

# Free Home Air Conditioning!

## Save Money on Your Electric Bills!

Using ONLY locally available materials, it is possible for ANY homeowner to virtually eliminate their electric bills for air conditioning FOREVER! If a million California homeowners would choose to individually save this money, they would collectively reduce the electricity power load on the California power grid by around 5,000 Megawatts! That reduction might even help the electricity suppliers keep up with their demand! A grass-roots solution for a problem that the honchos can't solve!

This is a method for supplying plenty of cooled, de-humidified air for almost any house or many commercial buildings, WITHOUT needing to run an electricity-eating air conditioner compressor! Even better, it is fairly inexpensive to install and unbelievably environmentally friendly! All of the rooms of a house will be EXACTLY as comfortable as if that expensive compressor was running! The temperature, humidity and comfort level can even be regulated by the very same wall thermostat you already have!

This system is extremely logical and actually very simple. It involves moving the house's air through large tubes (like tunnels) underground. In technical terms, these tubes are "heat exchangers" that use long-proven simple techniques to transfer heat FROM the house air INTO the cool deep soil.

The temperature a few feet down in the ground is remarkably constant throughout the day and year. In Chicago, for example, that deep soil remains approximately 52°F, day and night, summer and winter. In the summer, the hot house air is blown through some underground tubes and that hot house air is cooled by contact with the cool (52°F) walls of the underground tubes. It turns out that it is also de-humidified, too! By the time the air has returned to the house, it is exactly the same as the cooled air that would have come out of a standard central air-conditioner. **Air conditioning is accomplished without running an energy-expensive compressor, virtually eliminating air-conditioning expense.** In the winter, there is even a bonus effect! Make-up air for the house, that might sometimes enter the house at -10°F, would enter the house at around 52°F instead! The heat load of the house can be significantly reduced, minimizing heating bills.

---

Have you ever been in a cave? Remember how cool it was, even if it was 90°F outside? The air inside that cave that you were breathing did not start out in the cave. Some winds had blown air in through some opening somewhere. Hot outside air that had gone into the cave had been cooled by the cool walls down there. That's pretty much what we are doing with this system. You can do this with locally available materials, which should cost on the scale of \$500, in just a day or two, which would mostly be digging up and refilling trenches across your yard! If you hire a backhoe or trencher to do that might be another \$500. Adding in some other expenses, the whole works might be do-able for well under \$2,000. (These estimates depend on house size, climate and other factors, and are suggested as a ball-park estimates.) Simple, easy, fairly inexpensive, perfect!

---

By being able to entirely and continuously cool a house all summer, without a compressor running, many homes could save \$1,000 or more, EVERY summer! This is certainly a great thing for the homeowner, who has to pay the bills, but it can also help many energy-strapped utility companies. If a substantial number of people would install this system, the summer electricity demand could be substantially reduced.

Does it GET any better than this? You SAVE \$1,000 (or more) every year for the rest of your life. You have a cooling system that is unbelievably environmentally friendly. AND you're helping the short-sighted electric companies past their crisis. And all this does not even cost an arm and a leg! (Maybe a toe or two!) There are a lot of variables, like home size, climate, soil

This technology is being GIVEN away, FREE. Beginning in November, 2000, we have tried to get word out to California homeowners that this option is available to each of them. It is given in the spirit of one human being helping a neighbor.

We are just trying to offer assistance for people who seem to be destined for some great adversity. We have heard that in San Diego, electric rates quadrupled in 2000. People who paid out \$1000 the previous year for a summer of air conditioning are amazed at their recent bills for this and all following summers! And the electric companies have basically confirmed that blackouts will occur for up to ten years, until they have enough new power plants built.

How could caring people NOT offer a solution where none other seems to be available? But the response has been amazing. The bulk of officials and politicians seem to assume that if this had any value, we would certainly be trying to make piles of money on it, so they are polite, but clearly cannot wait until the conversation is over.

Some California homeowners DO seem to be aware of upcoming problems, but they seem to almost universally believe that there really IS no shortage and that this whole fiasco is some ploy on the part of the power companies to be allowed to charge them more. And, they have been conditioned so totally that government and executives can solve all of their problems, that most seem willing to patiently wait until government somehow bails them out of whatever "minor" inconveniences they will face.

These problems ARE very real. Yes, they seem to have been made far worse by greedy businessmen and poor bureaucrats, but the problems exist. It seems certain that those many people are going to be very upset as they realize the severity of the problem, AND that they probably face similar or worse problems for the next nine years!

At whatever point any homeowners feel the need to solve their own problems, on a grass roots level, this page should be here. It is, and forever will be, offered as a Public Service.

No incredible breakthrough is presented here. The concepts have been known for many decades. I heard a rumor that even the ancient Romans "air conditioned" a few buildings with this method (but I doubt it!) Our primary contribution is to figure out a system that only costs on the order of one or two thousand dollars and which would

type, etc, but a do-it-yourselfer could put the whole system in for under \$1,000 for some houses. (Contractors would charge more, but probably still a manageable cost.)

---

## Some Technical Stuff

There is a somewhat similar energy source called **Geothermal Energy**. That is actually different from the energy involved in this device. Geothermal energy taps energy that is coming upwards from the hot center of the Earth. Most geothermal energy applications involved rather deep wells or a location near natural hot springs. This system does not need that energy source. Most of the energy involved in this system is actually solar energy, which had arrived months earlier and became stored in the mass of the earth, just a few feet deep.

Each location on Earth has a certain annual energy input from the Sun and a certain energy loss from radiation (into space), conduction and convection. In the long-term, these two must be identical.

The consequence of this is that Equatorial locations, which receive more solar energy during a year, must necessarily have a higher average ground temperature in order to radiate, conduct and convect that greater amount of incoming heat away. Polar regions have colder earth for the same reason. Very near the surface, the ground temperature is greatly affected by day and night and summer and winter, but even three feet deep, those effects are fairly minimal.

Here is a map of the US showing average deep soil/well temperatures. Just find your location. The usual indoor design air temperature for air conditioning is 76°F, so if the deep soil in your area is under 76°F, this approach will work! (Even if it was above, house air could be substantially cooled, reducing the need for a central air conditioner to work, STILL saving you a lot of money!

probably save the homeowner more than that outlay every single year, forever.

We have a single request. The fact that we are giving away a pretty thorough explanation of this system, does NOT mean that we are also offering unlimited free engineering expertise as well! For unusual houses, or ones in unusual locations, or in especially hot climates, it is sometimes prudent to have individual engineering calculations done, to ensure proper performance. Any local engineer (HVAC, civil, mechanical, chemical, etc) should be able to do the necessary calculations. If they (or you) wish, we can provide all the necessary technical equations (and examples) for such analysis, which anyone that understands algebra should be able to use. Alternatively, we could do such specialized engineering. In both of these cases, which are beyond our offer of this free technology, we think it is only fair to be paid for whatever additional time and effort would be used, so the end of this presentation includes such matters. We feel that most houses in most climates do NOT need this extra engineering effort!

C.

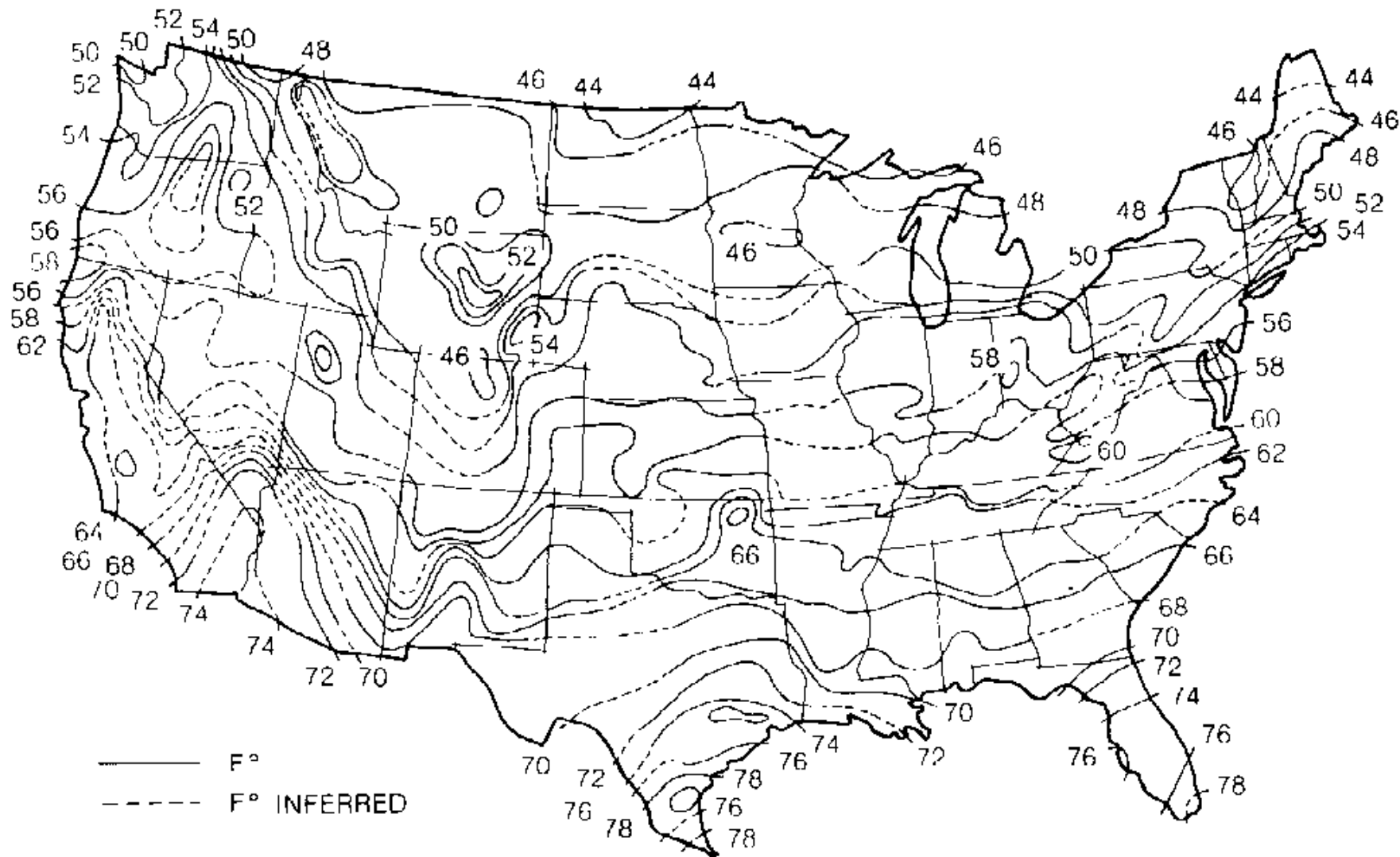

*Ground water temperatures. Map courtesy of National Water Well Association.*

Actually, the temperatures shown here are nearly always very close to the average of the summer and winter average temperatures. (In Chicago, the average December temperature is 28°F and the average June temperature is 72°F, which averages to 50°F, close to what this map shows.)

---

There happens to be another approach that is relatively similar to ours, which is often incorrectly called a geothermal system. It is a variation of a standard heat-pump that uses ground water (usually well water) or occasionally buried copper tubing to capture the same energy we are going for. Such ground-sourced or water-sourced heat pumps have been long proven and sold, and are very successful at providing heating and cooling for many homes. They represent one of several "proofs" that our system works.

Heat-pumps are much more efficient than normal air conditioners, but they still have compressors that use a lot of expensive electricity. Because they use that compressor, they have the capability of sort of "multiplying" the heat/cool from the ground to even provide complete winter heating (for some climates), where our system, without a compressor, does not try to accomplish that. But we don't have to pay for electricity for that compressor, either!

---

As cooling or heat is removed from the deep ground in our system (or in a ground-source heat pump), it is gradually replaced primarily by heat conduction from nearby soil, through the soil. It turns out that many soils are pretty lousy at conducting heat in this way, so this replenishment tends to be fairly slow and nearly always represents the **limiting factor in the long-term operation** of this system. In areas where the soil is saturated with water, some convection can occur, too. Therefore, if the deep soil is moist, this system works tremendously better. Water-source heat pumps nearly totally rely on this convection effect.

Because any substantial volume of earth contains enormous amounts of heat/cool storage but the many soils are so poor at heat conduction, the AREA of the interface (tube wall) between the soil and the tube contents nearly always is the greatest **limiting effect on short-term system performance**. Ground-source heat pumps generally have very small diameter copper tubing, so the circumference and the outside surface area in direct contact with the soil is very limited. This tends to make ground-source heat pumps to often act like they have depleted the energy source very quickly. Fortunately, they have their compressor that just has to work harder, but can still continue to work during fairly severe depletion. And, in any case, energy from nearby soil replenishes the energy source in just a few hours.

Our approach is to use much larger diameter tubing underground, which **greatly increases the contact area between the soil and the tubing surface**. This total "area of contact" is one of the most important characteristics to design for in this system! Again, in more technical terms, heat exchange is proportional to the surface area of the heat exchanger. It determines the amount of heat (or coolness) that can be given to the house air that is flowing through the tubes, in other words, the Btu/hr rating of the system (or short-term performance). Even normal ground-source heat pumps would benefit from such a larger surface contact area, but their compressor allows designers to calculate very minimal systems, to keep their digging (and copper tubing) costs at a minimum.

Further, our approach is to divide the underground air passageway into several "parallel" paths, separated from each other by around six horizontal feet. This configuration takes into account the very slow soil heat conductance and yet allows using a FAR larger mass of soil to participate in this system, which determines the long-term performance of the system.

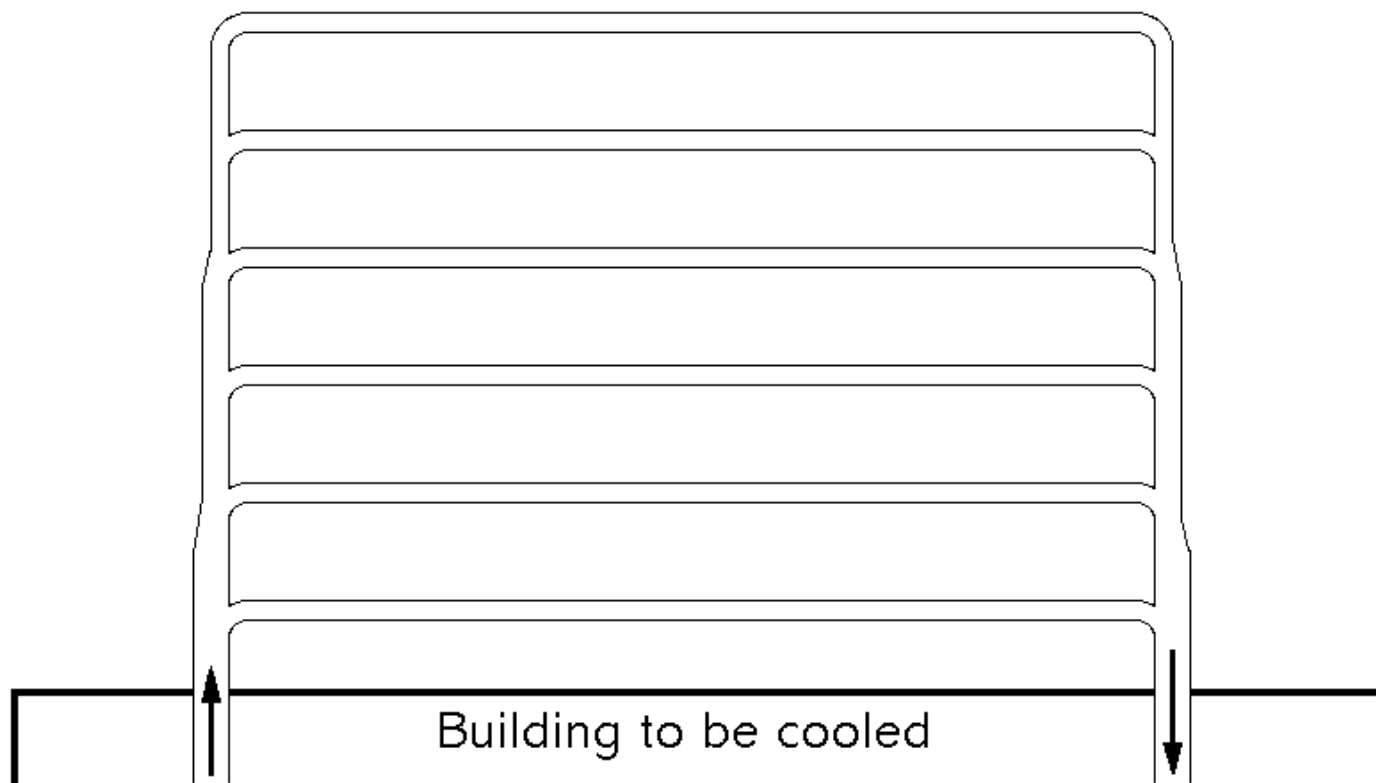

This drawing suggests a very compact arrangement. For example, if a 50 by 50 foot area was involved (about 1/16 acre), nine parallel tubes (six feet apart), totaling around 450 feet of tube length (plus the bigger sections from and to the building) would represent a way of installing around 500 linear feet of heat exchange surfaces in that fairly compact area. Such a configuration would involve well over a million pounds of cool soil all within three feet of a tube. (Simple engineering calculations show that that represents over 10,000,000 Btus of cooling available!) In case you're still skeptical, the "heat exchanger" arrangement we are describing has a coefficient  $U$  that is around 8 Btu/hr/square foot/ $^{\circ}$  difference. If you look at ONE of our nine tubes, its circumference is around one foot and it is 50 feet long, so its area is around 50 square feet. If the house air begins at 90 $^{\circ}$ F and the deep soil temperature is 53 $^{\circ}$ F, there is 37 $^{\circ}$ F difference. Multiplying these (8 \* 50 \* 37) gives an effective rating of 14,800 Btu/hr. That's ONE of our tubes, and there are nine of them! This suggests that the total system is capable of about 135,000 Btu/hr cooling, around four times as much as the normal house requires! Well, it could (almost) actually do that for a few minutes, but there are a number of factors that would quickly get it down to the 36,000 Btu/hr that we designed our "standard configuration" for.

Many larger houses and hot climates should probably have specific engineering done to determine that that is enough, but a million pounds of cool soil would often be sufficient for many houses and climates.

Basically, we are using modern engineering concepts to maximize the effectiveness of a natural phenomenon!

**There are many variables involved, but many installations should be able to use 4" plastic PVC drain/sewer pipe, available at any local 'home' store. ([Technical Comments](#)). At around \$3.50 per ten-foot length, the 450 feet of pipe mentioned above (45 lengths) would only cost around \$160. A trencher (sort of like a roto-tiller) can be rented for around \$220 per day. The sections are light and easy to handle, and available almost everywhere. Standard PVC Cement glues the sections together. The big pipe may be harder to find but it IS available near you! A do-it-yourselfer could do this amazingly inexpensively and quickly and easily!**

The drawing above certainly does not show the only possible arrangement. But it shows a compact arrangement with the three important considerations.

1. There is a lot of total pipe surface area (which defines the short term performance of the system). In this case, there is over 500 square feet of exterior pipe surface in contact with the soil.
2. Pipes are distributed so that a lot of mass of soil is within about three feet of some tube (which defines the long term performance of the system), (in this case, around 2.1 million pounds) and
3. The AREA of the air path always totals an area comparable to the area of the main house ducts (which allows proper airflow through the whole system). In this example, each 4" tube has around 13 square inches of cross-sectional area, so 9 of them total about 120 square inches, fairly similar to an 8" by 16" house trunk duct of 128 square inches. Note that the end pipes are bigger (15" diameter or about 170 square inches cross-sectional area) , so they at least equaled the total inside area of all the long pipes.

If you do a reasonable job of providing these three considerations, your system is bound to work!

[\(More Technical Comments\).](#)

---

Virtually all of the heat that replenishes this system (or ground-source or water-source heat pumps, close cousins) originally began as solar energy that heated the surrounding fields, often months before. Virtually no actual "geothermal" heat is involved. However, there is no commonly accepted name for this process and we suspect that it will generally be thought of as geothermal heating/cooling. Oh, well!

---

In case you are curious, this system was invented and designed by a nuclear physicist! It is based on very well established processes and we refined it with engineering, as a sub-system associated with our Version 1 Solar heated House.

This article is presented separately from the NorthWarm Solar System presentation because this feature could be added to most houses, either while they are being built or to be retrofitted later to existing houses. **This sub-system can be fairly inexpensive and can be configured to completely eliminate ALL conventional summer air conditioning usage (and those huge electric bills!) In the winter, the same system significantly reduces home heating cost by reducing the necessary heat load. Yet another benefit is that recent Indoor Air Purity concerns can be addressed in a way that is not costly or wasteful. Finally, you cannot get much more environmentally friendly than this system!**

Now, you probably already see the obvious logic of this system. Some fairly large-scale (expensive) systems have been occasionally installed for at least 30 years, and the relatively similar ground source heat pump system has been marketed for twenty years, so the concept is well proven. We are just presenting a low-cost version of it for residential use.

You are probably curious if the designer of this system uses it! Actually, his house has an unusual environment, and he uses a variation of this system which required much more design engineering but works even better! Here is [a description of it](#).

---

**Essentially, this is why basements generally stay cool in the summer and why caves remain at very constant temperatures.** In case you have any doubts, just find a long underground culvert (like under a highway) or aqueduct or cave and stand near the open end of it. If the wind happens to be blowing in your direction, you will feel a rush of very cool air coming out of it. That air had actually entered the other end at the 90°F of the outdoor air and had been cooled in passing through that tunnel. That is essentially exactly what our sub-system does.

This might lead you to believe that no planning or engineering is actually necessary! Well, technically, you would be right! If you chose to bury a mile-long culvert, it would certainly work excellently! However, most people couldn't afford to do that! They would want the shortest, most compact arrangement possible, both to fit under their yard and to minimize the digging expense.

The example described above will work extremely well for most medium-sized homes in moderate climates. So, no additional engineering is necessary for such applications! But, where soil is extremely dry, or the climate is extremely hot, or the house is especially large, prudent design might involved extra engineering. There is even often an alternative here, too! OK! You make 4' deep trenches and place the PVC tubing in the bottom of them. Instead of immediately filling in the entire trenches, for such applications, consider filling in ONE foot deep of fill in the trenches! THEN, get (cheap) 100 foot-long coils of black polyethylene 1/2" water line from the store, and drill LOTS of small holes in it! Make water connections to this set of water pipes, which are now one foot above the much bigger air tubes below. THEN fill in the trenches and re-plant your grass.

Materials List	
45 pieces 4" PVC thinwall sewer (ASTM D-3034)	~\$158
8 pieces 15" PVC sewer MAIN (ASTM D-3034)	~\$240
18 'saddle' tees (ASTM D-3034)	~\$290 optional
2 sewer MAIN caps (ASTM D-3034)	~\$24
PVC cement	~\$4
Rental of DitchWitch #1820 Trencher	~\$220

IF the system should ever seem to lose effectiveness in the future, it would generally be because the soil had gotten too dry down there, and the coolness was not able to flow through the soil to the tube. By briefly running some water through those water lines, you can quickly saturate the soil around the air tubes, TREMENDOUSLY increasing the system's performance (often by over a factor of EIGHT!) This "accessory" to this system is really inexpensive to add, and if your climate or soil dryness or house size is even moderately unusual, it might be a good idea to add this feature, even if it turns out that you never need it.

---

If the system is not properly designed and planned, there are two possible problems. A too-small cooling system (not enough total surface area of soil to tubing or not enough actual total soil involved) might work really well for a while, but then the ground and tube would warm up, and could almost completely stop having a cooling effect, and you would have to wait a day or two to again get any cooling. The other potential problem has to do with safety concerns related to the water that would condense INSIDE on the walls of the cool underground tube, and that will be discussed below.

## Comparison to Conventional Air Conditioning

We are not going to go into the actual operation of a standard air conditioning system, except to say that a compressor is necessary in the cooling process. Any textbook on air conditioning can explain the process. Most residential and commercial applications use electricity to run the compressor. THIS is where the problem is!

Let's say you have a moderate sized house in a moderate climate and you want to have 36,000 Btu/hr of cooling. Again, there are straightforward engineering conversion formulas that indicate that this is equivalent to about 10.5 Kilowatts of actual cooling effect. Our thoughtful government has provided us with a **SEER** (Seasonal Energy Efficiency Ratio) or **COP** (Coefficient of performance) for each air conditioning system sold. Let's say for a moment, that yours happens to have a SEER of 10 (about the same as a COP of 3.0). You would just divide the cooling load (36,000) by the SEER (10) to know how much electricity will actually be used (about 3.6 kW) of electricity. If you knew the COP instead, you would divide the cooling effect (10.5 kW) by the COP (3.0), or again, about 3.6 kW of electricity.

Most actual central air conditioners have a lower SEER than 10. Government studies have established that home central air conditioners average using 1.49 kW of electricity for the compressor and another 0.14 kW for fan motors, for each "ton" (12,000 Btu) of rating. Our example 36,000 Btu/hr system (3 tons) would therefore probably use about 4.9 kW of electricity (which calculates to a SEER of about 7.3).

Still with us? Now say you have a REALLY hot day, and the compressor ran virtually continuously for all 24 hours (not particularly good for the compressor!). You would have used up  $4.9 * 24$  or around 118 kWh of electricity that day. Look at your latest electric bill and it will tell you what each kWh costs you. Recently, electric rates have been going wild in many parts of the country. In an area where such rates are still relatively stable (Chicago), the rate is still only around 10 cents per kWh. One hundred eighteen kWh would therefore cost  $118 * 0.10$  or about \$12. That single very hot day would have cost \$12 in air conditioning. This is for a very moderate sized house and air conditioning system and for very reasonable priced electricity. We have shown you this logic here so you could figure these things out for YOUR system using electricity available to YOU.

You can probably now better understand the very large electric bills you receive during the summer. Twelve dollars for a hot day could easily account for \$200 per month. Far more, for larger homes and for where electricity is more expensive than ten cents per kilowatt-hour.

The system described here **does not involve any compressor!** The only electricity necessary is for a fan or blower to push the house air through the underground tunnels! In many cases, this can be accomplished with a fan or blower that only uses 200 watts (0.2 kW) or less of electricity. In terms of SEER, the effective rating would be  $(36,000/200)$  around 180! **That's nearly TWENTY TIMES as energy efficient as the very BEST heat pump or air conditioning system!**

On that example very hot day described above, let's look at the figures. Instead of continuously using up 4.9 kW of electricity, this system only needs 0.2 kW. In 24 hours, that's 4.8 kWh. At the electricity cost mentioned above, that's \$0.48 of electricity instead of \$12.00! A full month of such heavy cooling would cost around \$10 instead of over \$200!

There are actually even some possibilities of eliminating the cost of running the fan, too, eliminating even that last \$10 of monthly operating expense! However, it is such a minimal remaining expense, it is probably not worth even trying to do that!

This basically states the point of this system (regarding air conditioning). If you have a moderate sized house in a moderate climate and you have moderate electricity costs, you are STILL likely to sometimes save \$200 in a single month! In a whole summer, this "eliminating" of the cost of air conditioning the house or building, might easily save you \$1,000. Basically, whatever your total electric bills were last summer, inflated for the recent price hikes, THAT'S what you would save! And, that savings would be EVERY year, for the rest of your life! What a deal!

In areas where electricity costs have drastically risen in recent months, they are not likely to ever fall back to where they were. Using the logic presented above, you should be able to figure out approximately how much air conditioning will cost you. Or just check the electric bills from a previous year and multiply by how much the cost of electricity has multiplied. We are guessing that there are many millions of homeowners who are going to find it no longer possible to regularly air-condition their homes, just because of this tremendous increase in the cost of electricity. Well, that's a main reason we are presenting and offering this page! Each homeowner who would install this simple and obvious system, will virtually certainly save more than \$1000 every summer (depending on climate, of course), forever! If a new monthly TOTAL cooling cost becomes only \$10, even if it some day doubles, that's only \$20!

And the coolest (pun intended) part of this is that all of the comfort in the house is PRECISELY identical to that when using conventional air conditioning. The temperature and humidity levels will be identical. Of course, you would not have a noisy condenser unit running outside your house, so if you like that sound, you're outa luck! All this, in a system is about as "natural" as you can get! And bonus \$\$\$ savings in the winter!

If you live in ANY house, and YOU pay the electric bills, you must now see the exquisite logic of this system. It even has a bunch of additional bonus characteristics. For example, there is virtually NO chance of ever being charged for any repairs to the system, because there is virtually nothing that could ever break or fail or leak!

**It seems to us that such homeowners will even be doing good things for society and the environment, as well as pocketing an extra \$1,000+ each year. Consider California and its amazing energy woes, particularly electricity. Even during the winter, their electric companies and power grid have great difficulties in keeping up with electrical demand. Consider if a million California homeowners decide to save \$1,000 each, every summer, with this type of system. They're smiling! LOTS of happy people in California! But consider this! If a million California homeowners are NOT taking 5 kW each from the power grid during the summer, that's a reduction of load on the power grid of FIVE THOUSAND MEGAWATTS! It is unclear if that would "solve" the lack of planning of California's electricity needs, but it would have to help!**

(I know! I know! There are far too many exclamation marks in the previous paragraphs! But several of these concepts are pretty amazing! Huh?!)

## Winter Make-Up Air

All buildings have a certain amount of infiltration, air that somehow leaks into the house. Necessarily, an equal amount of air must also leak out of the house. In any heated building, the infiltration air tends to be low in the building's walls and the exiting air tends to leave high on the walls or through the roof. This is a result of natural physical laws. During air-conditioning, the process is reversed.

Until around 1985, all houses built had significant infiltration (leakage), and many thousands of cubic feet of heated house air would therefore leak out each hour and be wasted. This added considerably to the heating load of the house or building, but it actually naturally assured indoor air purity because any air seldom actually remained in the house more than an hour or two.

After some energy shortages in the late 1970s and early 1980s, houses were built to be extremely tight, because of this very situation. Air infiltration was nearly eliminated. This significantly improved the energy efficiency of the house, but it caused the air in the house to not have any way of ever leaving. Where the smell of a cigar would have left in an hour or two in an older house, it is now trapped for days or even weeks in the new, tight house.

**This situation eventually caused great concerns regarding Indoor Air Purity. (It is amazing that no one saw that coming!) Not because any more pollutants were being created in the house, but because the ones created in the house could never leave.**

By the middle 1990s, Building Codes were starting to add new rules, where motorized house pressurization or similar schemes were required in new construction. In a darkly humorous sense, they are defeating the entire advantage accomplished by making the houses so very tight only a decade earlier! Some States' new (bad) rules require motorized exhausters, which is a truly bad idea because it causes the house to be at negative atmospheric pressure. That could cause fumes from a car in an attached garage to be sucked into the house, or smoke from a fireplace drawn out into the room as air is sucked down the chimney, or paint fumes from a workshop in the basement be pulled upstairs. Others of the new rules, slightly more thought through, require a similar motorized device to forcefully inject fresh outdoor air into the house. In principle, this is a far better idea, since it slightly pressurizes the house. If any leakage would happen associated with a garage, it would be (warmed) house air being forced out into the garage. Regarding a fireplace, warmed house air would be forced up the chimney. Wasteful of heat, but not a source of Indoor Air Pollution.

By the way, this pressurization approach has existed in most large commercial stores for decades. Did you ever notice how air whooshes (outward) past you as you enter the door of such a store? That's actually unnatural, because the "chimney effect" tends to always suck cold outdoor air INWARD near the ground and it leaks out through cracks high in a building. They pressurize such buildings for several reasons, but that is one of them. They don't want their incoming customers to have to feel an incoming blast of cold outdoor air!



Amazingly enough, some of the new laws realized that a motorized pressurizer couldn't actually push any new (clean) air into the house unless old (stale or polluted) air was able to get out, so they ALSO required PERMANENT openings in the house where this air could leave. Some new windows are built with these permanent openings in the frames! In principle, those windows act like they always remain slightly open! It's sort of hilarious! The older laws mandate super insulation and all that (costing the owner \$\$\$) to make the house more energy efficient. These new laws require expensive motorized blowers and special windows and such which are designed to completely defeat the purpose of the original added expense, only at additional expense! Only in America!

## Our Approach

Given this last arrangement, it figures that most building codes will eventually require such house pressurization for every new home constructed. Hopefully, they will not be as wildly illogical as some present rules that require not only the motorized pressurizer but permanent openings for house air to be able to be pushed out of the house! The effect is of having a well-built energy efficient house, but with a window permanently open! Amazing!

Since some amount of outdoor air must then be brought into the house (by the motorized pressurizer), if the outdoor temperature is below zero, this adds greatly to the heating load for the house, and therefore to the cost of supplying heat for the house (unless you have our NorthWarm Solar Heating System!) In principle, you are bringing in extremely cold outside air and then having to add quite a bit of heat and humidity to it.

**We're finally getting to our (winter) improvement!** Assuming you have a large yard, imagine digging a trench about four feet deep all the way across the yard, and maybe then even zigzagging around the yard. In the bottom of this trench, place a large diameter pipe, and then fill the trench back in. At the one end of this pipe, have it pass through the basement wall and open into the basement or some other low part of the house. At the opposite end, (for primarily heating systems) have it elbow upwards so it sticks up out of the ground. (Make it decorative somehow!) **(For primarily cooling systems, see below, and the descriptions earlier.)**

The motorized pressurizer would be set up to draw its air through this long underground tube. When the air was first drawn into the tube at the outer end, that air might be below zero. But the ground several feet deep is much warmer. In the Chicago area, for example, it always stays around 52°F. As the air was drawn through the long tube, as long as the tube was designed and dimensioned properly, it would pick up heat from the surrounding pipe and soil. By the time the air arrived at the house, it would have been (naturally!) heated from the original 0°F to around 52°F. Only a minor amount of heating would then be necessary to raise it to the 70°F for the house, around 1/4 of that needed otherwise!

## Summer Air Conditioning

**This underground tube concept is REALLY beneficial during the summer!** The deep ground is still around 52°F in Chicago in the summer. Rather than using an electrical air conditioner, which is pretty expensive to operate, why not make BOTH ends of that underground tube come through the basement wall? Then, use the existing air handler or furnace blower to push the house air through this tubing. The hot house air (maybe 80°F or 90°F) that was sent into the tubing would obviously be cooled (and even de-humidified!) while passing through the underground tubing loop and the SAME air would come out the other end of the tube, back into the house at around 52°F. It would quickly and comfortably mix with the existing house air and cool the entire house down, without huge electric bills for operating an air conditioner. (This is again describing the system shown earlier).

Any existing furnace/air conditioning system already has a 'Summer Fan' switch on the wall thermostat. This switch just turns on the blower, without activating the furnace or air-conditioner, and could easily be used to control the airflow through the underground tubes. Alternately, the 'Air Conditioning' switch position on the thermostat could be used. This would then allow the wall thermostat to automatically turn on and off the blower, blowing the house air through the underground tubes as necessary to maintain the desired temperature set on the thermostat! Absolutely automatic! Absolutely identical in usage to traditional air conditioning!

## Summer De-Humidification

It turns out that there are even bonus benefits for summertime use, if the tubes are installed in a certain way. The hot summer house air that is sent into the tubes often has very high relative humidity. Both the heat and the humidity make us uncomfortable in the summer. An air conditioner not only cools air but it removes humidity from it as well. (That's why window air conditioners tend to drip.) In the underground tube, that hot, humid air is cooled down by the cool pipe and soil around it. For complicated physical reasons, the RELATIVE humidity gets higher as the air cools. Soon, some of that humidity can condense out on the walls of the tube. (This occurs at a temperature called the dew-point). If the design and planning of the tube system is good, by the time the air has gotten to the house, it is not only cooler, but it has been de-humidified as well! Both of the functions accomplished by an air conditioner are accomplished in a far more natural way. With FAR less electricity and expense involved!

Interestingly enough, this system actually lets you control a comfort parameter that normal air conditioning does not, the Indoor Relative Humidity! Massive government tests have determined that the ideal summer indoor conditions are 76°F dry-bulb temperature (normal temperature) and 40% Indoor Relative Humidity (See any ASHRAE Handbook). Store bought air conditioners were designed to accomplish approximately the right IRH as a function of the temperature, so you don't actually have any control.

This system actually does (if you wish it!) Much of the foregoing discussion has mentioned air returning to the house at 52°F in our examples. This system can actually be used in that way, but that is usually not the ideal situation. If the air passing through the tube actually gets down to 52°F, then the great majority of its moisture content would condense out on the walls of the underground tubes. That's a desirable goal, but in this case, we're doing TOO good a job! Once that air comes out into the house and becomes warmed to the 76°F room temperature, it will only have around 13% IRH.

Since we would probably rather have the air come out with around 40% IRH (at 76°F), it turns out that it would be better to have the air exit the underground system (to the house) at 60°F. When this air heats up to 76°F, it will have 40% IRH. Going to the other extreme, if we arranged it so the air came out at 68°F, when that air warmed to 76°F, it would have an IRH of around 70% and it would feel muggy, even though the temperature was fine.

So, how would we control the IRH? By controlling how long a time that individual air molecules would be inside the tube system! There are elegant engineering ways of calculating what cfm of blower airflow would provide final airflow temperature, but it is generally easier and more accurate to just measure the (web-bulb) temperature as the air re-enters the house. If it is 60°F, then you will get 40% IRH. If it is higher or lower, just adjust the air flow cfm through the tube system so that the air returns at that saturation temperature. For locations where the ground temperature is higher than that 60°F, the house humidity level may be higher than desired, and, under some circumstances, a de-humidifier may be necessary in the house.

It might seem that changing the air flow through the tubes, and therefore the temperature that the air returns to the house, would affect the overall system Btu/hr capability. In general, it doesn't. A LOT of air coming back at 60°F has as much cooling effect as a lesser quantity of 52°F air. The actual coolness being delivered is proportional to the PRODUCT of cfm and temperature differential. So, with 80°F air entering the system, either 1000 cfm at 52°F or 1400 cfm at 60°F, would provide the same Btu/hr of cooling. Only the IRH would be different.

---

In case you are an environmentalist, please note that there is no CFC Freon refrigerants that could affect the ozone layer or otherwise pollute anything. **This system represents a version of an elegantly natural, low-tech approach that does the job far better than the high-tech air conditioner does.**

Depending on the climate of the house, it might be desirable to arrange this system for primarily or exclusively A/C operation, with little or no concern about winter benefits. In such a situation, there can be additional benefits from looping the tube around so that both ends of it come through the basement walls. Ducts (with dampers) would connect the existing furnace (or air handler) ducts to this path. At whatever point the wall thermostat would call for cooling, that existing blower would turn on and appropriate dampers would move so house air is blown through the underground tubes. This recirculating method has certain advantages, like better control of house humidity, better usage of the available cooling effects (higher net efficiency), and air filtration advantages. A pure recirculating system would have the potential of the super tight house Indoor Air Purity concerns. Probably the ideal solution for a primarily cooling installation would be a primarily recirculating system with a small intake provision for bringing in a little make-up air (for pressurizing the house).

---

If you already have a full basement, you already have a crude version of this system! You have certainly noticed that such a basement always stays cool in summer (but that it is also often rather humid). The basement floor is actually acting like the walls of the underground tubes we have been describing. House air that flows along that basement floor becomes cool from the coolness of the floor. Just like in the underground tube arrangement, that air also gives up some of its moisture in the process of being cooled, which tends to make basement floors slightly damp and makes the basement sometimes feel humid.

With the underground tubing, the effect of all this is much more prominent, and the moisture that condenses out of the air is collected and removed, very much like a normal air conditioner does.

The basement floor has plenty of "interface area" so short-term performance can be great. If you live in a climate where air conditioning is only needed for a few hours at a time, you could probably get most of the benefits of air-conditioning from just recirculating your upstairs house air through the basement, using the existing house blower/air handler.

If there is NOT thermal insulation under the basement floor, then fairly simple engineering shows the short-term benefit you can get from this cool basement floor. Say the house is 25 feet by 40 feet, so the basement floor is 1,000 square feet. If the ground underneath it is at 52°F and the house air is at 80°F, then the "cooling effect" is seen to be  $(1,000) * 8 * (80-52) = 224,000$  Btu/hr! That would be PLENTY to cool your house, and that's why recirculating the upstairs air through the basement can quickly cool the house. Just sending that air through the basement does not actually send all of that air right along the basement floor, so the "basement effect" winds up to be far less than 224,000 Btu/hr, but can definitely be the 36,000 Btu/hr of cooling that your house actually needs. (Keep in mind that this approach does NOT remove moisture from the house air, so there is no de-humidifying effect and a separate de-humidifier would be needed).

However, if your air conditioning needs are for more than a few hours at a time, this approach will soon lose its effect. Gradually, the soil underneath the basement floor will warm up. Since it is a finite volume of soil (basically the size of the house), once it has all warmed up, the cooling effect would be greatly reduced, until an extended period of non-use occurred so the soil could again cool back down. Anyone who has tried to cool their house in this way has noticed the reduction in cooling effect over time.

$$T - T_o = \frac{Q'}{2\pi K} \int_x^{\infty} \frac{e^{-\beta^2}}{B} d\beta$$

Any engineer can solve this Integral Kelvin equation to determine this effect. (By the way, this is the scariest of the equations involved! And the technical information package described below includes a table of solutions for this equation for all practical situations.) If a common, fairly dry, Midwestern soil is under the house, and if this example house needed continuous cooling of 36,000 Btu/hr, the solution shows that the soil a foot below the basement floor would have risen in temperature by 24°F after just one week! By then, the floor would have been at 76°F and there would have been no cooling effect at all. Even after just a couple days, the cooling ability would have dropped to about half, because the soil down there would have heated up to around 64°F. With a more moist common Midwest soil down there, the effect is only half as bad, with a decent cooling effect existing beyond a full week.

A simplistic engineering approach could also be used to roughly estimate long-term performance. In VERY approximate terms, the soil temperature one foot down would probably reflect the overall effect on TWO feet deep of soil down there. One thousand square feet, two feet deep is 2,000 cubic feet or about 200,000 pounds of soil. The specific heat of dry soil is around 0.3, so the heat capacity of this mass of soil is around 0.3 \* 200,000 or 60,000 Btu/°F. If 60,000 Btus are put into that ground, it would rise an average of 1°F. Since we are talking about putting 36,000 Btu/hr down into that soil, that's 864,000 Btu/day. This implies that the soil would rise in temperature by around 14°F in a 24 hour period of operation, relatively in line with the solution of the more precise Integral Kelvin equation.

These comments are included to emphasize the need for calculating the long-term performance. Even though a basement floor starts out with incredible short-term cooling capability, in just a few days of use, that cooling effect gets depleted. Larger volumes of soil need to be involved when extended periods of cooling as necessary. The network of underground tubes accomplishes this.

---

OK! So, YOU don't live near Chicago. YOU live in a much hotter climate. Could it still work? Yup! You probably already found your location on that map we included above. In cities like Los Angeles (68°F) and San Francisco (64°F), the deep ground temperature is not 52°F but it is higher. The configuration has to be designed with more underground tubing, but it will still work like a charm! Even a place like Death Valley amazingly only has a deep ground temperature of around 70°F! New York City (54°F), Seattle (52°F), Washington DC (56°F), Denver (52°F), and such a system would cool excellently. About the only two areas where it is at all complicated is around Miami, where the deep ground is around 77°F and very southern Texas, where it is about the same. (Farther north in Florida, like Orlando (74°F) is already simpler and fine!) By the time we get as far north as Atlanta (64°F), everything is easy! Additional design planning is involved regarding consistently hot areas like Miami, because a lot more underground tubing is necessary, but anywhere else in the USA is a piece of cake!

---

OK! You already know that you need to pay attention to the three main aspects of it. For a reasonably average sized house, we have mentioned that the tube pattern shown above will be near enough soil for long-term performance and will have enough surface area for short-term performance. We have a couple additional comments regarding the tube diameters.

We had mentioned using nine parallel 4" tubes for the total of about 120 square inches of area for the airflow. We have discovered that some people have read this page and decided to "improve" on it by making one very long air path of a single 4" pipe 500 or more feet long. Well, that WOULD actually work, but it would have a disadvantage. In the same way that firemen use a 3" diameter hose instead of a 1/2" garden hose (to carry far more water for putting out the fire), a single 4" air path would greatly limit the amount of air that could be cooled. True, it would be cooled really well, but there would be very little air flow through the tube, the effect being a lot like the garden hose trying to supply enough water to put out a big fire. The larger area is very important!

Now, if you have 6" pipe available to you locally, roughly five parallel tubes would be necessary to match the air flow through the nine 4" pipes. In that case, the air flow would be fine, but the total tube surface area would be slightly less (making the short-term system performance a little less, and the amount of soil within three feet of a tube would only be 5/9 as much, substantially reducing the long-term performance. So, before you go changing any major aspect of this system, make sure you understand all the consequences of that change!

Four inch PVC drain pipe should be available everywhere. Six inch is nearly as widely available.

We haven't said too much about the larger diameter tubes in that drawing. There are a number of approaches you could use. Some people might fabricate a rectangular duct of some sort, and have the branch runs come off of it. A second possibility is to just have all nine separate 4" PVC pipes elbow and come through the basement walls, with an "airbox" then fabricated there to connect them all in parallel. Another possibility involves using PVC larger diameter pipe there, too. There is a 15" diameter PVC pipe that is normally used for sewer mains, and it would work excellently here. Either the full 15" diameter could be used for the whole length or it could step down to 12", then 10", then 8", then 6" and finally 4". Either approach is fine. The second choice is technically slightly better for air flow, but the first choice would likely be simpler to install and probably cheaper.

As to joining the 4" pipe runs to the 15" main, there are again two choices. First, there are solvent weld fittings (a lot like standard a 4" PVC Tee, but for this specific combination. Those fittings are around \$100 each, and you would need 18 of them for the pattern shown above, so that's too expensive. The second choice is called a "Saddle Tee". It is a fitting that is PVC solvent welded onto the 15" pipe to add the Tee wherever you want it. A lot simpler, and those fittings are in the \$16 price range. If you're creative, you can probably think of less expensive ways of joining the 15" and the 4" pipes.

These items, the 15" PVC Sewer Main pipe and the Saddle Tees (and even the expensive Tees) are items you may have trouble finding locally. If that is the case, we have located suppliers, so we could provide them to you. Check around locally, first!

---

As to specifics for a particular application, well, that's where we might earn our keep. We would have liked to include those specifics in this page, but there are quite a few variables that can affect the performance of this system. (You probably haven't been too thrilled with the engineering info we've used here!) For example, two identical houses, a mile apart, could need extremely different systems, if one was over very dry sand and the other was in a marshy area. In this case, the necessary area of pipe is different by a factor of four! Also, the size and shape of a yard, the climate, the house size, and the soil type all can affect the best choice of tubing diameter, so we cannot even generalize there! Sorry! You need to either do the math yourself or have us do it (or provide the equations) or over-estimate how much pipe you will need.

If you want our help, we have two possible fees that could be charged. The first is a flat **fee of \$250**, for a collection of equations, formulas, charts, (pre-calculated solutions of that Integral Kelvin equation!), and a lot of additional guidance regarding designing of the intake tube sizes, materials, lengths, and a bunch of general suggestions. If you happen to be or to know a thermodynamics engineer, he could probably do all this for you and you wouldn't have to pay us anything! The second is a flat **fee of \$500** (for a single-family, fairly normal residential house) which would involve US doing the design calculation work (of those equations and formulas) necessary. For this, we would need you to supply us with a variety of information, so we can take into consideration the size of the house, the climate it is in, its estimated heating/cooling load, the number of members of the family, the size and shape of the yard available, the type of soil, etc., to determine the diameters, configurations, patterns, depths, etc. of the components of this system. Many variables are sometimes involved, including mountains, lakes, forests, and other local conditions.

For many climates, the necessary yard area that would have to be dug up for this network of tubes might only be 50 feet square! If you followed our "basement" discussion, this area of tubes would involve a volume of soil of about 56 feet square (about 3,000 square feet) and about double the vertical depth of soil (because the basement "hole" is not there). In other words, even this moderate area of yard could be used to supply around SIX TIMES the long-term cooling effect of the basement floor example. (3,000 \* 4 or 12,000 cubic feet of soil instead of 2,000). In hot climates, a larger area of yard would obviously be necessary.

If your application is anything other than a fairly standard single-family house with a large yard, our (second) fee will likely be higher. (The first fee would be the same, because the same basic equations and logic would still apply.) Unusual situations regarding house or yard, and ANY commercial or industrial application would be billed on a time-basis. The above-mentioned (second) fee is specified because we have a good idea of how much time would be involved for us to do the calculations for a normal house with a large yard.

In case you are concerned that we are talking about a (moderate) amount of money here, in a technology that is being given away for free, we hope the situation is obvious. We don't want to LOSE money as a result of this offer. It wouldn't seem fair for people to ask for free engineering as well, because it is fairly time consuming to do all of the necessary calculations and engineering. We encourage you to find a local civil engineer who could equally do the math. We are making this engineering offer because we have already done a LOT of research and collected all the useful stuff in that collection of information. We are hoping that a \$250 fee would not cause a hardship on anyone for that information.

---

## Doing This Without Our Help

### Water Condensation, Fungus, Etc.

If you choose to do this without our guidance, PLEASE be aware that there is a tendency to accumulate puddles of moisture down there, and if you don't plan it right, and that could represent a breeding-grounds for moss, fungi and other things. Some of the things that could grow there can be bad. Remember that Legionnaire's Disease was caused by condensation accumulations from air conditioning equipment and that it was a bad situation. There are similarities to be careful about.

You know how house gutters slightly slope, so they drain? Just an inch or two in a ten-foot length? That should be done for these underground tubes. NO corrugated tubing should be used, because it would trap such condensed moisture in lots of little puddles. The tubing should have a smooth interior. Since it is relatively hard to confirm that a minimal slope has no low spots (far harder than for gutters), it is generally a good idea to provide a somewhat greater slope than normally used in house gutters. The slope should probably go downhill along the direction of the airflow, so the moving air would tend to push the water along. This could terminate in a central condensate collection point in the tube system, or it could continue all the way back into the house, where the water would be collected and then sent down a sewer drain. These considerations would eliminate any danger of a puddling or bacteria problem in the tube system.

**NOTE: Before you go digging, make absolutely sure that no easements are across the property. You DEFINITELY do not want to dig into high voltage electrical cables or gas mains or water mains!**

---

From an engineering point of view, remember that the three main considerations are (i) the heat transfer between the soil and the air passing through the tubing, (ii) the total mass of soil participating in this system, and (iii) the total airflow path area inside the tube system. It often works out best (depending on soil type and moisture content) that several parallel smaller tubes be used rather than one large one, because of these considerations. Just think about how a septic field is designed to see why, or try the engineering calculations for different configurations. You will quickly see that you can substantially increase tube-soil surface area and the total mass of participating soil by running parallel tubes six feet apart. The example we discussed earlier represents a very practical system for many mid-sized houses. (This is the sort of additional guidance and insight we include in the engineering info package).

But, let's say you don't get our help and you happen to not bury enough pipe. Well, even in that case, you come out fine, because the system would do much of the air conditioning (depending on how well you planned the piping) and will greatly reduce your air conditioning bills anyway. So, even if you somewhat mess up by not doing any preliminary engineering, you still win!

---

This system is a part of the NorthWarm Solar Version 1 System. It may separately be used for either existing homes or buildings or for new construction.

---

This is one of two closely related "gifts" we are presenting to the American people. This one is for existing houses, while the other one is an approach for new construction. It is at: [Free Air Conditioning](#).

---

Depending on the local cost for usage of a backhoe, or if you happen to love to shovel(!?), **the installed cost of this system may be less than a conventional central air conditioning system.** Depending on the climate and house size, the necessary pipes could cost around \$500. Depending on how much a backhoe or trencher costs in your area, that might also be around \$500. This suggests that some installations could realistically be put in for well under \$2,000. If you can put in LOTS of narrower tubes, a Ditch Witch Model 1820 trencher can make 4 foot deep trenches for around \$220 rental per day. And you essentially eliminate ALL those huge summer air conditioning electric bills! And you get significant energy savings in winter, too! Forever!

In nearly all cases, the existing furnace blower or air handler, and wall thermostat could be used, so there's virtually nothing necessary except for the tubing and the trenching. And there's nothing bizarre about operating the system, either, since the normal wall thermostat would be used exactly as before.

**We believe this to be a feature that nearly all houses could benefit from.** Considering recent large price hikes for electricity and natural gas, we felt it appropriate to present it as a separate system, where it has always been considered a relatively minor part of the full NorthWarm Solar Heating System.

Even if you have already paid for an existing central air conditioner, this intake arrangement could quickly pay for itself in combined heating and cooling savings. Just do the cost calculations suggested above to find out what YOU might save. And, even if you happen to be in a climate, like Miami, where you might feel it too involved and costly to bury all the necessary piping for an entire system, any size system that you would install would greatly reduce your air conditioning electricity costs.

local newspaper, radio or TV reporter to look at what you did. We don't really care if we get any credit in the matter, but it's important to get the word out to all California homeowners that they each have a way to greatly reduce their summer electric bills. And, if enough of them actually do that, collectively we might help avert a big summer problem of blackouts out there. In the process of this, you might even get yourself on TV, if that's important to you! It might seem surprising, but WE don't want any publicity from this effort at trying to help California deal with a big problem. We just believe that we have a grass-roots solution for it, and that people should help one another.

---

In addition, this system represents an obvious solution to the recent flurry of legislation that is trying to deal with Indoor Air Quality issues. Bringing additional air in through our (winter) warming tube to pressurize the house would only have about 1/4 (depending on climate) the winter heating load increase of currently favored approaches (that just directly bring in outside air). This could even allow the legislators go totally over the top and to insist on drilling one-inch diameter holes in the walls of the house, without spectacularly increasing heating costs! That, and a continuous source of pressurizing (52°F) air from our tube, would certainly purge stale and polluted house air! (But we hope they won't do that!)

---

E-mail to: [Intake@mb-soft.com](mailto:Intake@mb-soft.com)

---

The NorthWarm Solar heating systems:

- For NEW houses, where maximum performance is desired, so that an ENTIRE large house can be TOTALLY heated, in most climates, with ONLY solar energy! [Solar1](#)

Performance and storage will be extremely great. The VERY large collector area and storage space make it certain that NO back-up heat will EVER be necessary for heating the house.

- For existing houses, where room for a two-car-garage-sized building is available nearby in the yard. [Solar2](#)

Performance and storage will be great, but the necessarily smaller collector area and storage space make it possible that back-up heat will sometimes be necessary for heating the house.

- For existing houses, in very rural areas, where an array of tracking collectors and a high-temperature boiler system would be of advantage. [Solar3](#)

This liquid-based version has potentially higher installation costs than either of the air-based systems above. It would certainly involve much more maintenance time and cost. It also has all the advantages and disadvantages of a water-based system.

- For existing or new houses. This system is quite different from all of the above. [Solar4](#)

It has very good performance but has intrinsically less performance ability than any of the other three NorthWarm versions. It is a low-tech approach to solar heating.

---

E-mail to: [Solar@mb-soft.com](mailto:Solar@mb-soft.com)

[NorthWarm Solar Heating](#)

# Technical Comments

Some people who have some knowledge of science see this as ridiculous! They think that plastic tubing would eliminate any decent performance of such a system. As a result, they then assume that we don't know what we are talking about and that this system does not work! Not true. They think that we would have had to mentioned aluminum tubing or copper tubing for the material. At the very least, iron or steel pipe!

Such people are theoretically correct, but are unaware of the practical engineering involved!.

Any engineering text, or any good heating text will confirm the following.

All "heat exchange" processes involve at least three major effects: (1) a surface film effect in the first fluid (house air, in this case); (2) the thermal conductivity through the material itself; and (3) a surface film effect in the second fluid/material (in our case, the moist soil surrounding the buried tubes).

The standard engineering formula for this is (slightly simplified):

$$1/U = 1/h_i + \text{thickness}/k + 1/h_o$$

U is the desired rate of thermal transfer of the heat exchanger, in Btu/hr/sq.ft.  $h_i$  is the heat-transfer coefficient for the first (incoming) film.  $h_o$  is the heat-transfer coefficient for the second (outgoing) film. k is the thermal conductivity of the material of the exchanger.

We have forced air passing through our tubes, so  $h_i$  is given by the standard engineering formula:

$$h_i = 0.024 * C_p * G^{0.8} / (D_i)^{0.2}$$

If we blow around 2,000 cfm of air through the nine tubes of our normal configuration, this calculates to around 8 Btu/hr/sq.ft./°F

For the other film coefficient, the condition of the soil, particularly its amount of moisture, tremendously affects the value. If the soil was dead dry sand (the worst possible situation) the coefficient could be on the scale of the incoming film value calculated above. However, all practical (deep) soils have substantial moisture content. That water enables excellent direct contact with the tube surfaces, creating very good heat transfer outward, by both conduction and convection. For most soils,  $h_o$  is at least 100 or so.

As to the middle term, the conductivity of the tube material itself: Standard iron pipe of 1/4" thickness has a conductivity of around 1480 Btu/hr/sq.ft./°F. The PVC plastic pipe we are recommending has a much lower value, and would only be around 48 Btu/hr/sq.ft./°F for a 1/4"

thick wall. We selected the thin wall drain pipe to enable this to be around 120 Btu/hr/sq.ft./°F for our choice of material.

Now, let's calculate U. If we used (relatively expensive) iron pipe, we would have:  
 $1/U = 1/8 + 1/1480 + 1/100$ , which gives U as 7.4 Btu/hr/sq.ft./°F.

If we use the PVC tubing we recommend, we would have:  
 $1/U = 1/8 + 1/120 + 1/100$ , which gives U as 7.0 Btu/hr/sq.ft./°F.

Yes, this confirms that the better thermal conductivity of iron pipe really DOES give better overall heat transfer. However, notice how little the difference is! Even though iron has about 30 times the thermal conductivity (k) of PVC, the net effect in our heat exchangers is amazingly minimal! Even if very expensive copper or aluminum pipe was to be used, the calculated value does not get above 7.5 Btu/hr/sq.ft./°F.

THIS is why we recommend the PVC pipe. The actual thermal disadvantage is far less than it might seem that it would be. Considering how very inexpensive PVC sewer pipes are, it makes a lot more sense to just add 5% more length of tubing to make up for this difference.

E-mail to: [Solar@mb-soft.com](mailto:Solar@mb-soft.com)

**[NorthWarm Solar Heating](#)**  
**[\(Air-based\) Free Air-conditioning System](#)**



# Technical Comments

We have recently located another system of doing the necessary calculations for the tube system. It doesn't actually involve Engineering, so it has no consideration for various types of soil and various other circumstances that might affect the performance of a system like the one we recommend. However, relatively speaking, it is fairly simple mathematically, a definite plus in this subject area!

There is actually a set of eight equations that are presented in the Heat Exchange Institute Standards, that accomplish this goal. They are a "simplified" method of doing certain calculations, and so their results are only approximate. We have further simplified the equations by inserting a number of facts from our system, such as the tube diameters and their wall thickness, several characteristics of air, and the like.

You may want to do these following calculations. They will aid in reasonably well knowing the system performance rating of any tube pattern you may want to consider, as well as the effects of various blower sizes that blow the air through the tubes.

The first equation is:

$$R/\Delta T_m = k * L * U_o * C_t * C_c * C_m / (b * V)$$

$$R/\Delta T_m = 0.103 * L / (\text{square root}(V))$$

Where L is the length of an individual tube air path (in feet) and V is the air velocity within the tube (in fps).

As an example, if a tube air path (L) is 50 feet long, and 1000 cfm of air is pushed through nine tubes, for a velocity of 21.2 fps (V), this value comes out to around 1.119

Next use a calculator or table to find the value of the exponential of the negative of this number. In our example, we get 0.327

Subtract this number from 1, and get 0.673

This number is the fraction of temperature difference that can be expected in the house air. For example, if hot house air is entering the system at 90°F, and if the deep soil temp is 53°F (for a beginning difference of 37°F), just multiply that by the fraction we just got, to get 25°F

The house air will return exit that tube (and each other tube as well) after being lowered about that amount.

Now, it's easy to calculate the total system (short-term) cooling performance. The 1000 cfm we would be blowing through is 60,000 cubic feet per hour, and each 13 cubic feet of air weighs one pound. That means we would be blowing 4600 pounds of air through the system every hour. Each of those pounds of air is cooled by 25°F. Since the specific heat of air is 0.241, then  $25 * .241$  Btu is needed to cool each of those pounds, or about 6.0 Btu. Therefore,  $4600 * 6$  indicates that the actual performance of the small tubes of this system produce a cooling effect of 27,600 Btu/hr.

You can use this fairly simple calculation to estimate the differences due to using different blowers. Say you decided to use a 2,000 cfm blower instead of the 1,000 cfm blower of the example above.  $V$  is then 42.4. The first number we get is then 0.791. Doing the exponential, we get 0.453. After subtracting from 1 (0.547), multiplying this by the 37°F difference, we find that the air is now cooled 20.2°F. It might seem surprising that the larger blower returns air that is not quite as cool to the house (now around 70°F instead of the earlier 65°F)! But don't be concerned!

Since we are now pushing twice the cfm of air through the tubes, that means twice the total weight of air, now 9200 pounds per hour. 20.2 temperature drop means  $(20.2 * 0.241)$  4.8 Btus are removed from each pound of air. Multiplying  $(4.8 * 9200)$  gives 44,200 Btu/hr for the total effect. The larger blower enabled the system to work better, increasing its performance from 27,600 Btu/hr to 44,200 Btu/hr.

You could do this calculation for any blower size, number of parallel tubes, tube lengths, deep soil temp and house temp. It is a way to get a reasonably good idea of expected system performance. It's not quite as accurate (or as capable of dealing with unusual soils or other aspects) as the full-blown Engineering approaches, but it certainly gives a rough idea of performance.

If your yard was long and skinny, you could see how 4 parallel tubes each 100 feet long would perform! Or almost any other configuration.

E-mail to: [Solar@mb-soft.com](mailto:Solar@mb-soft.com)

**[NorthWarm Solar Heating](#)**  
**[\(Air-based\) Free Air-conditioning System](#)**

# Personal Application

The "air-based" system described in the Free Air-conditioning presentation works great! It is also rather simple to install, inexpensive, and almost universally applicable to homes and other buildings. A bonus is that almost nothing bad could ever happen to it in future years, so maintenance is near zero!

It happens that the Physicist/designer of this system has a waterfall adjacent to his house, a rather unusual situation! More than that, it is not a waterfall that is fed by a surface stream (which water would be heated by the sun on a hot sunny day) but where the water is actually underground for at least a mile before coming out to be the waterfall.

If you have a fairly good understanding of the Free air-conditioning system, you might see advantages here! By having been underground for a long time, the water comes to have the 53°F temperature of the deep soil. As water, such heat/coolness can be transported in smaller pipes than the large air tubes described in our main presentation. As water, it can be passed through very common standard heat exchangers to create the desired cool air within the house.

This particular waterfall begins around 12 feet below the altitude of the house, and the water falls around 10 feet. That would normally indicate that a motorized pump would be required to pump the water UP to the house, where the coolness was captured. However, with extensive engineering, a system was designed where a second pipe paralleled the intake pipe. This pipe carried the water back down toward the waterfall, to a point in the stream below it. Since the entire water system is sealed, even with no pump involved, it acts as a "siphon" where the water flows all by itself! This even eliminated the expense of a pump and of the electricity for it!

## Technical

A ten foot drop between the ends of the siphon means that there is around 1/3 of atmospheric pressure difference between the two ends, around 5 PSI pressure, which drives the siphon flow. Pipe sizes and other components were chosen which allow a maximum of around 18 gallons per minute of water to flow through the system due to this siphon action. That's around 130 pounds of water flowing through the heat exchanger every minute. Not much effort was made to insulate the buried intake pipe, so the original 53°F water commonly becomes (naturally) warmed to around 56°F as it enters the heat exchanger in the house. If house air enters the heat exchanger at 80°F, that's around 24°F temperature differential within the heat exchanger. If everything had perfect efficiency, that would represent about 24 Btu of cooling per pound of water passing through the heat exchanger. The 130 pounds of water per minute therefore represents a maximum of around 3100 Btu per minute of cooling, or **186,000 Btu/hr of air conditioning!**

Few houses need more than 30,000 or 40,000 Btu/hr of cooling (normally provided by a compressor-based air-conditioning system of 36,000 to 60,000 Btu/hr rated equipment, or 3 to 5 tons). With the availability of a maximum of 186,000 Btu/hr of cooling, this system has incredible performance! (This also explains why it was not seen necessary to maximize efficiency by insulating the buried intake pipe!)

A conventional wall thermostat turns on and off the conventional furnace blower (air handler) that pushes air through the heat exchanger, so actual use is absolutely standard! About the only noticeable differences are that there is no sound of an air conditioner compressor running outside (and the associated high electric bills) and the fact that EXTREMELY cold temperatures can be set on the wall thermostat. In fact, it has been found that it can be set so low as to require wearing a coat in the house, or to go out into the 90°F outside air just to warm up! (That was done, only once, as an experiment, to have the house at around 63°F on a 90°F+ day, to see just how well it could cool!) Normally, the best design comfort temperature in the summer is 76°F, and the standard wall thermostat easily keeps the whole house exactly at that. (Remember that not even a pump is operating, with only the existing furnace blower sometimes turning on.

It may be one of the only houses anywhere that continuously air conditions the garage, too! With so much extra cooling capacity, and with no cost of providing the air conditioning, why not? There is not currently a dog present, but plans for air conditioning the large (6' by 8') existing doghouse are also in the works!

A water-based system has more maintenance than the air-based system described in the main web-page presentation. There is junk in the water, so filters must be used and sometimes cleaned. And, without a waterfall and a unique source of huge amounts of underground water, operating cost and system performance would suffer somewhat, requiring much more design and engineering. But you can probably see why the system designer uses this adaptation rather than the described air-based system!

After the summer, a valve is opened and air is allowed into the water lines, to let them all drain, to avoid freezing during the winter. Various other such considerations make this system a little less "fool-proof" than the described air-based system, which is another reason why that is described for universal applications.

E-mail to: [Solar@mb-soft.com](mailto:Solar@mb-soft.com)

**[NorthWarm Solar Heating](#)**  
**[\(Air-based\) Free Air-conditioning System](#)**

# NorthWarm Cooling System - Technical Info Fee Arrangement

We are a very unusual company! We hope you noticed that we have chosen to GIVE AWAY the entire technology for our sub-system that is able to provide Free Air-Conditioning for nearly any home or building. In the first two years that that page has been on the Internet, it is our understanding that more than 2,000 people have installed such systems. If each are now saving \$1,000 each summer, that would mean that collectively, they are saving two million dollars each summer, and they will forever!

This is said in preparation for the following:

This is how the Technical Info fee would be paid to us:

## For the Technical Information Packet

There are three possibilities.

- If you regularly attend a Church, Synagogue or Mosque, then you would make out a \$250 Cashier's Check TO that institution. It would be important that you include their mailing address! Such a check would show "NorthWarm" or "Anonymous" as the source, and not you. (You would also be free to benefit a Charity instead, as indicated below.)
- If you DO NOT regularly attend a Church, Synagogue or Mosque, then you would make out the \$250 Cashier's Check TO any recognized Charity Organization which YOU choose. It would be important that you include their mailing address! Such a check would show "NorthWarm AND you" or "anonymous" as the source.
- If this is for a commercial building, any commercial application, from an architect, designer, contractor, or other individual or company which is involved regularly in the industry, we would require a Notarized statement that the usage of the NorthWarm designs and system would only be used for that single application, and a suitable fee would be arranged.

In addition, if such a business intends or expects to use our technology for additional applications, a formal contract for such use would be negotiated, with suitable fees involved.

Regarding these business usages of our technology, the comments above should suggest

that we are a very fair company and would never over-charge anyone. The modern world forces us to have to try to protect our interests in these ways. We have invested massive time, effort and expense in designing and developing the NorthWarm technologies, and it is only fair that we receive compensation for usage of them, with the exception of the technologies which we choose to offer for free.

## For Direct Technical Assistance

We are pretty convinced that nearly everyone could do the math just from our Technical Packet mentioned above. Therefore, we choose to always send you that Packet as part of any larger technical involvement on our part. This essentially means that you would make out TWO Cashier's Checks, one for the "good deed" \$250 as described above, and the other to "NorthWarm" (for the total fee minus the \$250).

You would mail this to us. We would forward the appropriate Cashier's check to the address you included, so it gets to the proper destination!

One way or another, we are trying to do a "good deed" here!

We think this explanation is fairly clear, but if there are further questions or comments, our e-mail address is below.

E-mail to: [Solar@mb-soft.com](mailto:Solar@mb-soft.com)

**[NorthWarm Solar Heating](#)**  
**[\(Air-based\) Free Air-conditioning System](#)**

# Heating / Cooling Cost Reduction for New Construction

During new house construction, it is possible to provide for nearly free air conditioning and greatly reducing heating costs. This is true for the vast majority of homes, and could be usable for some businesses, and the cost is quite reasonable.

## The Concept

Do you plan a basement for this new house? If so, consider making a full sub-basement underneath it! That's essentially it! Maybe an extra thousand dollars of excavation cost, and an extra thousand dollars of concrete. There are some additional costs, but they tend to be minor, and **for around (possibly) \$2,000 differential in the construction cost of a new house, you could have completely normal air conditioning without paying for the central A/C unit (which generally costs AT LEAST \$2,000 that you would save!)** By eliminating the need for the central A/C unit, you might even be able to cancel out the differential cost of this system!

This sub-basement room would not be used as a room. It would actually be painted with a sealer, insulated on all sides, and entirely filled with standard backfill earth materials, and used as a "heat storage" area. Once this sub-basement was made and filled in (and then properly compacted), a standard basement floor would be poured on top of it, and the house built normally above it. In other words, the final house would show absolutely no evidence of the sub-basement even existing! The house would be absolutely "normal"! That allows almost infinite flexibility in the architecture and style of the house's design and construction.

What would be the point of this? Imagine a modest-sized house, of 40 feet by 25 feet, or 1,000 square feet floor area. This sub-basement would then have 1,000 square feet of area and 8 feet in height, or around 8,000 cubic feet of the earth materials trapped inside it. At a density of around 100 pounds per cubic foot, that's around 800,000 pounds of heat storage materials. Using some standard engineering information, this huge amount of storage is able to store around 500,000 Btu of heat (or cool) for each degree of temperature change of the material.

## Cooling

First, consider cooling. If this house is in a climate similar to Chicago's, the natural ground temperature is around 53°F. If, in the Spring, the storage is permitted to revert to its natural deep earth temperature, then all of the 800,000 pounds of storage would be at 53°F at the beginning of the Summer. If the desired summer house temperature is the common 76°F, that means that the storage contains around  $(76^{\circ}\text{F} - 53^{\circ}\text{F}) * 500,000$  or 11.5 million Btus of cooling!

What is the expected use of this cooling? In a climate like Chicago's, there are commonly around 20 days each summer where a central air conditioner is used for the six hours of the afternoon. That's 120 actual hours of air conditioning that is needed in a summer. A modest-sized house such as the above would often have a central air conditioner rated at 30,000 Btu/hr (2.5 tons). Multiplying these numbers gives a full summer's air conditioning usage of around 3.6 million Btus of cooling.

**Since the proposed storage could provide 11.5 million Btus of cooling, ALL of the 3.6 million Btus of cooling needs would easily be taken care of!** No other air conditioning system would be needed, ever! Not only would this eliminate the annual summer electricity usage for air conditioning (forever!) but it would even eliminate the initial cost of buying and installing the conventional air conditioning system. That's several thousand dollars of initial cost that is eliminated, greatly offsetting the cost of the sub-basement.

**Bottom line: ALL air conditioning is taken care of, forever, without the big electricity bills of conventional air conditioning, and without any Freon refrigerants that might be environmentally bad.**

## Heating

**There are even wonderful heating benefits from this system!**

If, in the Autumn, either solar heating or any of a variety of other heat sources is used to warm up the storage, that stored heat could be used during the winter for heating the house.

This is meant as a very "low-tech" system. You have certainly noticed that the interior of a closed car can soon get over 140°F on a sunny summer day. The point is, getting this massive storage up to, say 120°F, over several weeks is quite easy without having to resort to any exotic equipment. Many other heat sources are possible, too, like a woodstove or similar.

Using this very conservative value of 120°F for the top temperature of the storage, let's do the math. If a desired house temperature is the usual 70°F, then the storage would have  $(120^{\circ}\text{F} - 70^{\circ}\text{F}) * 500,000$  or 25 million Btus of heating available for the house at the beginning of the winter.

In Chicago's fairly nasty climate, our modest-sized house, if reasonably well insulated, might have an annual heating load of 60 million Btus. **That means that nearly half of the entire house's winter heating load could be provided by our massive storage, EVEN IF IT IS ONLY AT 120°F!**

If the storage could be warmed to 140°F, then the benefits would be even better. The storage would then contain around 35 million Btus, representing MORE than half of the house's heating



load for each winter. **That means that, for every following winter, only around half of the usual heating bills would be necessary! Forever!**

## Summary

Of course, a taller storage chamber could be built, which would provide even more heating and cooling storage. In certain climates, that might be something worth considering. This discussion is making the main point, that a rather conventional basement structure, beneath the planned basement, could accomplish a lot! For a rather moderate initial expense, an air conditioning system could very likely be eliminated (saving a good deal of money), ALL future air conditioning electric bills would be essentially eliminated, and a great deal of the cost of heating would also forever be eliminated! **Best of all, virtually all new construction could include this system, which is entirely invisible once the house is built.**

Also, please note that the re-sale value of a house that would NEVER have any air conditioning expenses and would have possibly half the winter heating, would be VERY high. **The additional re-sale value of the house almost certainly would be greater than the cost of installing this system!** Also, so you realize how quickly such a house would sell?

---

There ARE some Engineering considerations. All of the inner surfaces of the (concrete) chamber would have to be painted to seal those surfaces, such that moisture did not permeate through the concrete, either inward or outward. Effective, crush-resistant, durable, thermal insulation must be provided, so the storage does not lose too much of the stored heat to the surrounding ground. Proper selection of the best storage materials (for both economy and thermal characteristics) is desirable. The system needs efficient ways to both get heat into and out of the storage, for efficient performance. Otherwise, the house temperature could vary from the desired wall thermostat value! When these considerations are properly planned, the absolutely standard heating/cooling wall thermostat can keep the entire house within one degree of the value you set on that thermostat, for the ultimate in comfort, summer and winter. It's all automatic, too! Exactly like a standard central furnace and central air conditioning system performs!

---

As to specifics for a particular application, well, that's where we might earn our keep. We would have liked to include those specifics in this page, but there are quite a few variables that can affect the performance of this system. The size and shape of a house, the climate, and other variables can affect how this system should be engineered for optimum performance.

Actually, even without much planning at all, you can probably see how this general idea is bound to be helpful, for both heating and cooling of the house. So, really, you would not even need our help at all! But, if you're going to do this, you might as well do a little planning so that it will work really well. You should either do the math yourself or have us do it (or provide the equations) or

just over-estimate how much storage you will need. That is pretty easy to do, and the example of the moderate sized house near Chicago is a good example. In a normal Summer, only around 3.6 million Btus of cooling is likely to actually be needed, but the calculations above show that over 11 million Btus of cooling is available. This "over-design" is a good idea, so that it would always provide excellent cooling, even for a record hot summer. And, as an additional note on the actual air conditioning usage, it is very rare that the compressor in a conventional central A/C runs absolutely constantly for the six hours described. It generally cycles on and off to keep the house temperature at what you set the wall thermostat at. Therefore, the needed amount of cooling is generally less than the 3.6 million Btus.

The discussion above should have convinced you that almost any version of this concept will be of benefit, but if you're going to do it, you might as well get maximum benefit from it! The variables that have the greatest effects on performance are three: (1) the insulation R-factor used; (2) the type and condition of the storage medium itself; and (3) the method of efficiently getting heat into and out of the storage. In these areas, we have extensive understanding, and we can assure maximum performance of the system for you.

If you want our help, we have two possible fees that could be charged.

- The first is a flat fee of \$250, for a collection of plans, recommendations, equations, formulas, charts, drawings, and a lot of additional guidance regarding designing the various parts of this system. If you happen to be or to know a thermodynamics engineer, he could probably do all this for you and you wouldn't have to pay us anything!
- The second is a flat fee of \$500 (for a single-family, fairly normal residential house) which would involve US doing the design calculation work (of those equations and formulas) necessary. For this, we would need you to supply us with certain information, so we can take into consideration the size of the house, the climate it is in, its estimated heating/cooling load, the number of members of the family, etc., to determine the engineering parameters, etc. of the components of this system. Many variables are sometimes involved.

If this is of interest to you, send us an e-mail (below) and we can send you our mailing address.

---

This is one of two closely related "gifts" we are presenting to the American people. This one is for new construction, (and it is technically not entirely a gift, since you probably need to send us one of the two fees mentioned above), while the other one is an approach for existing houses (and that one really can be installed without ANY payment to us!). It is at: [Free Air Conditioning](#).

---

This presentation was first placed on the Internet in March 2002.

---

Link to the [Index of these Public Service Pages](#)

( <http://mb-soft.com/public/index.html> )

---

E-mail to: [Solar@mb-soft.com](mailto:Solar@mb-soft.com)

C Johnson, BA Physics, Univ of Chicago

# Totally Solar-Heated House - Version 1

## A Truly 100% Solar-Heated Home

For Northern Climates at an affordable price

The **NORTHWARM SOLAR** house design is a revolutionary improvement in modern housing. The hybrid passive-active design is based on a US Patented device. **It allows total heating of the ENTIRE house in a climate like Chicago's!** Even if there is only ONE sunny day every week! Or even if there is only 1.5 hours of sunshine per day! As an odd added bonus, the house may NOT even need air-conditioning in the summer (in many climates), which means further savings on the utility bills.



**This design should be able to ENTIRELY heat homes in virtually all climates in the US!** Even better, much of the construction of the house is very standard, using common building materials and construction techniques. This makes the overall cost of the house only moderately more than a conventional stick-built house. **Considering the savings that will accrue from NEVER having heating bills EVER AGAIN, even that cost differential would soon pay for itself!** That effectively makes the NorthWarm Solar heating system FREE! There will also never be any dependence on foreign oil or other uncertain or expensive heating source.

---

Up to now, solar heating has been impractical in moderate or northern climates. In Florida or Arizona, solar heating has long made sense, because of the great amounts of bright sunlight and the

mild climates that require less house heating. Other than in such areas, solar space (house) heating has been unrealistic, and functional solar heating has often been limited to heating domestic hot water (and swimming pools).

For solar space heating, the early 1980s was a brief boom time. Government tax incentives and rebates created a huge demand for solar devices, and a large number of companies popped up to sell things. Unfortunately, many of those companies didn't really know what they were doing! Manufacturers made a lot of different kinds of products, and some even did some research to advance their craft. Installers appeared everywhere, and suddenly EVERYONE was an expert!

It was astounding to witness the insanity of the time. We also operate a company that makes very high efficiency fireplaces and woodstoves ([JUCA](#)). A customer buying one of our woodstoves (in about 1980) was bragging about the solar heating system that he had just had installed, for which he had paid \$7,000. When I inquired about details, it turned out that he had received three 4 x 8 solar panels mounted on his garage's roof, that was meant to heat his domestic hot water. During succeeding months, he became disillusioned with the performance of it (and therefore loved the total-house-heating performance of our woodstove he bought even more!) Since he realized we were knowledgeable in the subject, he would occasionally call for possible suggestions from us. (He had earlier given up on the installer and the manufacturer of the solar collectors.) After a number of such conversations, we eventually realized that the garage was not on the south side of his house and that the collectors were facing a little north of west! It's astounding that someone would install them pointing such a weird direction, and then to charge him so much for it, too!

Many of the manufacturers were equally unprepared to sell large numbers of products. Most manufactured liquid (water) based systems, and seemed completely oblivious to the concept of electrolysis. This basic chemistry concept relates to ion transport between dissimilar metals in such a system. Aluminum and copper are particularly susceptible to corrosion due to electrolysis. Many of those companies (including nationally known companies) offered Five- or Seven- or Ten-year warranties on their products, only to find failure in half of their products within a year due to electrolysis!

Narrowing the field down to intelligently designed and intelligently installed solar systems, the better quality solar space-heating products that are still available on the market have always been (and are still) cost-ineffective. That is, they would not pay for themselves in fuel savings during their expected lifetimes.

The government also financed a few totally solar-heated, moderate-sized houses in the 1980s. In one, a \$30,000 house had a solar heating system installed that cost about \$700,000. It worked pretty well! But, it could never pay for itself.

More commonly, a good quality 4-foot by 8-foot solar collector panel often costs over \$1000, with a final, installed operational cost somewhat higher. Assuming it is properly sloped, aiming South, in January, under PERFECT weather conditions, it can intercept all of the Sun's light and heat, about

300 Btu/hr/sq.ft around noon (considerably less at other hours), or a sunny day's total of about 1600 Btu/day/sq.ft. Therefore, the entire collector panel can intercept  $1600 \times 4 \times 8$  or about 51 KBtu per DAY. An well-insulated, average sized house near Chicago will lose about 40,000 Btu per HOUR on a very cold day, or 960,000 Btu per DAY. To totally supply this much heat, one would need about 19 of those collectors, at an installed cost of well over \$30,000, and it would only be completely effective on a perfectly sunny day. (During the winter, Chicago skies only average about 35% clearness, so it would probably need three times as many collectors for real life circumstances).

With this setup, the realistic conventional heating fuel savings would be about \$300-\$400 per year (about \$60 per month). Sounds impressive, huh? The system would actually have to operate perfectly for about 80 years to re-coup the initial cost, not counting repairs, maintenance and lost interest on money that could have been left in the bank! This argument is basically why solar heating has remained impractical for space heating of houses --- it requires a lot of Nature's cooperation, and even then is not cost effective.

Some attempts at partially supplying solar space heating have been made. In general, these same arguments apply. Installing a few collectors to reduce house space heating might seem like a good idea, but we are not aware of any existing system that could even pay for its own cost, much less accomplish actual heating bill savings.

**UNTIL NOW!!!**

Staying for a moment more with existing systems, A common "solar home" has three or four of those 4 x 8 collector panels. Better-planned installations have some heat storage provision, which might involve 20 tons of rock heat storage. Let's examine this. If the three collectors were perfectly efficient, they could collect, on a perfectly sunny



day in January, at noon, about  $300 \times 4 \times 8 \times 3$  or 28,800 Btu/hr. If the outdoor temperature was mild, about 15 degrees F, then this COULD be enough to (momentarily) supply the entire (very-well-insulated) house's heat needs. But that's ONLY just at noon, and there is no room for clouds, or temperatures below 15, or even the system inefficiencies that always exist. If any of those circumstances apply, then it cannot entirely do the heating job (even at noon!), and backup heat is therefore necessary. The 20 tons of rock storage could hold up to 200,000 Btu of heat, but even that would only assist the solar heating system for far less than a day (actually, just a few hours) of cloudy weather. (Remember that 960,000 Btu/day house loss (for a decently insulated house) mentioned above?) The result is that you regularly need to use conventional fossil fuel heating to do the bulk of the heating. The approximately \$10,000 that people spend to have such a system installed, will never pay for itself. BUMMER!

## Enter the NorthWarm Solar Heating System

**The NorthWarm Version 1 is, by far, the best of the NorthWarm Versions, but it requires that a house be built pretty much centered on this system. The Version 1 cannot be used for any existing building.** There is considerable freedom in room arrangements inside the house, but the exterior of the house has a limited number of appearances available.

## THE PROOF THAT IT WORKS!

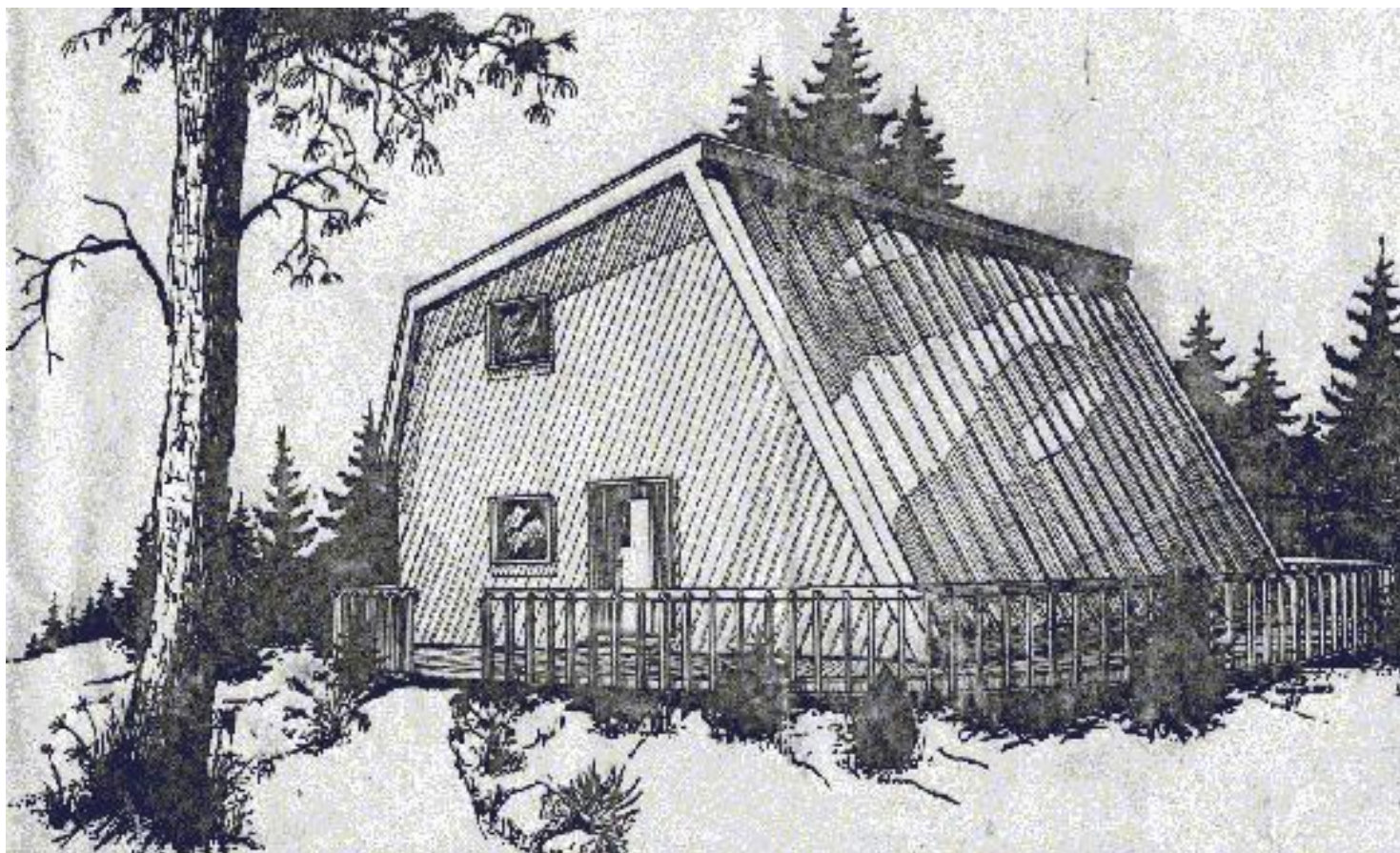

We designed a demonstration house (illustrations). A main floor of 1600 sq. ft. includes a huge Great Room (20 feet by 40 feet with a 22 foot high cathedral ceiling!) An upper floor of 800 sq. ft. of bedrooms and baths includes a Master Bedroom of 16 feet by 20 feet. A lower floor of 1250 sq. ft. could include office and workshop space and maybe a family room/den. This is a total of about 3,650 sq ft of living space, larger than most houses. We then bought vacant property near South Bend, Indiana, one of the FOUR cloudiest areas in the United States. South Bend is also known for its nasty lake-effect snows, and generally nasty winters!

We chose the idea of building a larger-than-normal house in a nastier-than-normal climate, to show the great performance of the NorthWarm solar heating system. Everyone would be justifiably skeptical (mostly due to the horrible reputation solar received in the 1980s due to companies like those mentioned above!) So, if someone in Kansas, or Virginia, or Wyoming, who planned to build a 2,200 sq. ft. house in their climate, knew that we could heat a bigger house in a worse climate, credibility could be present!

Instead of the 96 sq. ft. collecting area of a traditional solar heating system, this house was designed with nearly 900 sq. ft. of collecting area, around **NINE times as much collecting area**. Our unique system even improves on this, making its performance equal to better than 14 times the heat-gaining ability of a common so-called "solar house."

Under those perfect conditions referred to above (at noon, when the normal solar heating system



could momentarily heat the whole house, OUR system could be heating 14 houses! If there is just 1 1/2 hours of good sunlight around noon on that day, enough heat can be gained to supply heat for the entire house for the 24 hours of a full day in the dead of winter!

Our system has such high performance capabilities, that it makes sense to have substantial heat storage capability. Instead of the 200,000 Btu (mentioned above) of common systems (if they even HAVE storage capacity!), our system has much more! The actual storage capacity will depend on the climate and size of the house. The large South Bend house described above was designed with approximately 10,000,000 Btu of storage (FIFTY times that of other systems!)

That much storage would allow going for WEEKS without any Sun, even in the intensely cold days of January or February, while still maintaining consistent and constant 72 F temperature throughout the house! And, even if this would ever happen (it has not in either South Bend or Chicago in the past 50 years!), a single really sunny day could replenish storage enough (2.5 MBtu) for most of ANOTHER WEEK without any Sun!

**Our system's performance is so great that it almost seems pointless to even compare previous solar space heating systems with it!**

To confirm all of this, we obtained ALL the US Weather Bureau records from their office at the South Bend Airport since they started keeping records in the 1940s. We then did massive computer simulations to see how our system would have fared in each of the winters. In early 1961, there was a stretch of ten days when the sun never shone, while the outdoor temperatures hovered near zero and often fell below. Our simulations show that the large house described above would have easily gone through that period. **Actually, our simulations showed that the heat storage would STILL have had about 5 MBtu of heat available, about half of its total capacity.** Our design and storage provisions could have kept the entire house at 72°F for twice as long, under those horrible conditions! **NO BACK-UP HEAT was EVER needed during ANY of the nearly 50 years of weather records we did computer simulations for!** Actually, it was rare that the simulations showed the storage going below half full! (These simulations and results are available at the end of this page).

---

There's another way of looking at this that explains our approach. Look at all your heating bills from last winter. You can quickly total up the number of cubic feet of gas you used (multiply by 1000) or the number of gallons of oil you used (multiply by 140,000) or the number of kWh of electric heating you used (multiply by 3400). That will give the total heating used in the entire winter. There are some adjustments necessary because of efficiency, but the total (for a climate like Chicago) is likely to be around 60 to 80 million Btu for the entire winter (for a reasonable sized house). It might be a little less for an extremely well insulated house.

ANY method of providing that 60 million Btus would heat your house! You could use the conventional fuels mentioned above, or a woodstove (and several cords of wood). We see solar

heating as a realistic possibility. A Chicago winter usually involves around 100 pretty nasty days. And Chicago, in winter, is a really cloudy place, with only around 35% clear days. That means around 35 nice and clear days to do serious collection of solar energy. (Most salespeople would incorrectly be using all 100 days, in a REALLY optimistic sales presentation!) Now, the Version 1 NorthWarm house has around 10 million Btu of heat storage, and at the start of the winter, that storage is full and available. So, we don't quite need to provide all 60 million, but 50 million Btu collected in a winter would do the trick. With 35 available days of sun, that means we need to think in terms of collecting around 1.5 million Btus per sunny day.

Do you see where we are going? Now that we know that we need 1.5 million Btu per sunny day, if we think in terms of five strong hours of sunshine, that means we need to collect around 300,000 Btu/hour of bright sunlight. As it happens, one square foot of surface gets around 340 Btu/hour of sunlight on a completely sunny winter day. This means we need around 900 square feet of collector surface to get the needed 300,000 Btu total per hour. This is roughly the derivation of why we see the need for around 900 square feet of collection area. (The actual math is somewhat more elegant, but the point is essentially the same.) All of this logic is very straightforward and even obvious. Enough solar heat must be present, must then be collected, must then be stored, and must later be distributed as needed. Simple, really!

This should also make it clear why a few "bought panels" with a hundred total square feet of collection area has no chance whatever to seriously offer savings on heating bills. That's why no other company even dreams of their products fully heating any house. It doesn't matter if they would use special glass, or special collector configurations, or special insulation, unless they used many hundreds of square feet of collectors, no possible arrangement could entirely heat a house in a cold climate.

The NorthWarm Version 1 house actually has a little lower heat loss than the 60 MBtu used above, mostly due to fairly common modern construction techniques, so the numbers are even a little better. The discussion above is meant to show that a solar heating concept is actually a realistic possibility for existing fairly normal homes, in addition to the specially built houses like the Version 1 house. (We arranged a variation on the Version 1, called the Version 2, for using much of this system for an existing house, and a link to a description of it is at the bottom of this page.)

---

OK! So, you may now believe that we can really produce heat from solar. Does this mean that there are periods of unbearable heat in the house or in some rooms? **NO!** Amazingly enough, the system includes sophistications to ensure **CONSTANT** comfortable temperatures throughout the house and throughout the day and year. It **WILL NOT** overheat the house or any part of it (unless you turn the standard wall thermostat up to do it intentionally!) The system is designed to be totally automatic, operated by standard wall thermostat(s). Side-benefits from this unique, patented system, include a reduction (or possibly even elimination, depending on the climate) of air-conditioning needs, further reducing house operating costs. This "even heat" aspect is unheard of in solar heating! Almost everyone in the industry is familiar with systems designed for substantial heat-gain that

made some parts of a house always unbearably hot! Not so, with the NorthWarm approach.

You may not have realized it, but NO solar heating supplier has ever even mentioned air conditioning! They are so focused on trying to get every available Btu of heat, that they seem to ignore the situations where a room or the house would become TOO hot! Our goal is really not "heating" but "comfort". Because of that, we early included an air conditioning provision for the Version 1 system. If you want the house at 71°F, we intend it to BE 71°F! With the incredible heating performance of our system, we realized that cooling may sometimes be necessary to accomplish that. Of course, in the summer, the air conditioning portion would operate separately, to again keep the house at whatever you set the thermostat at. In response to watching the California energy crisis of 2000, we even chose to offer a version of the air conditioning system to everyone for free. A link is near the bottom of this page.

Very constant, comfortable heat. NO heating bills. Sounds expensive, huh?

Actually, it isn't. Well, at least, not horribly! We have sort of blue-collar attitudes toward such things. Super-rich people do not NEED to save on their heating bills! And, they can afford to pay for extremely expensive systems that might not actually work like their promoters say they will. We're not like that. Our goal is to (1) save people (who actually NEED to save) money on their heating bills and (2) be kinder to the environment than society has been in the past.

We actually have FOUR different versions solar heating systems. Three of them are fairly closely related, with the fourth being rather different.

The version we have been describing here is the BEST of the group. It is the most automatic, with the most even and comfortable and consistent heating for the house. It REQUIRES that the house be designed and built with this system integrally part of it. House size is pretty flexible, although the house needs to be relatively squarish in shape and it must have one sloping wall. That wall does NOT have to all be one surface; it could have set-backs like is popular with many modern condos. Interior floor plans are also quite flexible, with room locations and layouts very adaptable to owners' desires. (It does NOT require a giant Great Room; we just thought that such a huge room would emphasize the tremendous performance of the NorthWarm Solar heating system!)

There are links to the other versions of our NorthWarm Solar heating systems below.

Since people who have interest in this are likely to be all over the country, we came to realize that we could not become licensed to be General Contractors in all the possible jurisdictions where our designs might be used. That's just as well, because we would have had trouble having constructions crews agree to travel all over the place, and we also might not have been aware of nuances of local building statutes.

Therefore, we think it generally most appropriate to work with architects while they are designing

houses. We should be able to supply them the bulk of the preliminary drawings they would need to work from, so their job should actually become easier! Extensive communication between the architect, the homebuyer and us would be involved, primarily because of all the extensive flexibility that our Version 1 system permits.

The total cost of a Version 1 system will consist of four main expenses:

- Most of the materials required for the construction of the house are standard items. There are a few unusual items, such as the large number of 2 foot by 8 foot 1/4" (normal) plate glass panels, some wide-flange I-beams, and assorted other things. These items figure to increase the material cost between \$2,000 and \$10,000 above that for a "normal" house. That range is mostly due to comparison shopping, and whether new glass or storefront glass is used.
- Architect's extra charges for including the NorthWarm Solar Version 1 in the house. This will totally depend on the attitude of the specific architect. Some might be so intrigued with the idea that they would do it for no additional charge. Others might charge quite a premium.
- Our **charge of \$10K** (for most situations). For this, our expertise and regular interactions with the architect, drawings and plans for both the architect and the contractor, and regular interaction with the contractor and certain sub-contractors. Extensive modification of the general design might involve additional expense.
- The contractor's additional charge for assembling the house with the NorthWarm Solar Version 1 system included. This part of the cost is probably the most variable. If, like some architects, a contractor agreed to build the house with little or no additional charge (or possibly a charge based on hourly rates for additional time involved), this part could be near zero. On the other hand, most contractors don't really like to get involved in unknown projects, because they're worried about the possibility of losing money on a cost over-run. Therefore, it is common that contractor's try to charge an obscene additional for unique or unusual features. Realistically, the contractor probably SHOULD charge around \$8K additional associated with labor for building the house based on the NorthWarm Solar Version 1 system.

These considerations suggest that the grand total differential expense of this NorthWarm Solar system could range from a low of around \$12K to a high of more than three times that. (Most of the construction of the house is pretty traditional.) If a specific contractor has already built one of our Version 1 houses, it is liable to be around \$20K total differential.

Depending on the size of the home and the climate it is in, the annual savings on heating bills may be \$1,000 to \$2,000. This means that the Version 1 NorthWarm Solar heating system should completely pay for itself in 5 to 20 years. After that, further savings are just gravy! If the climate is such that summer air-conditioning savings also can occur, there may be more savings yet, with even shorter payback period! All this suggests that there are a couple additional values involved. First, the security of KNOWING that the house will be fully heated regardless of political events in the Mid-East or decisions of executives or politicians that might affect fuel supplies or prices. Second, given these things, the house VALUE would probably be increased more than the cost of the

system, because MANY people would want a house with such security.

This version is an air-based system, so there is no electrolysis threat to its longevity. Actually, long-term maintenance should be LESS involved than for a conventional gas or oil furnace. We think that air filters and standard air handler maintenance should usually be all the attention this system should ever require, for the lifetime of the house!

Let's see. You'd ALSO likely become the center of the social circle of the town, since EVERYONE would be curious about your very unique house. (That might be a reason for that Great Room, after all!) And, if you like the idea of getting media attention from the local newspapers, radio and TV, you'd probably have the opportunity.

We DO have a little bit of bad news. While our South Bend Demonstration House was being built, some complications occurred (most specifically, a divorce!) Because of these unforeseen circumstances, the Demonstration House has not yet been built. (The photos included here are of a 1/12 scale model.) Even without this having yet been built, we believe that we have proven the performance of the system. The logic explained above should make the general point. In addition, a link below can show the daily results of any year's simulation for our proposed large Demonstration House in the harsh South Bend winters.

The design is specifically NOT based on exotic glass or exotic materials or insulations in collector panels, so there are no mumbo-jumbo arguments about using high-emissivity glass or other advanced subjects. This system is more a meat-and-potatoes approach that uses conventional (soda-lime) glass, normal building insulation, normal construction methods (for the most part) and a special large heat storage facility beneath the concrete floor of the lowest floor. With very large collector area and very substantial heat storage ability, we feel the logic of the system is obvious. If it isn't, please e-mail us, and we can discuss whatever subjects you would like. We have a Physicist available to field your questions, so, hopefully, we can respond to any technical subject you might bring up!

We mentioned that our design will not overheat the house. We actually include SEVERAL defense methods regarding overheating. Depending on whether it is Summer or Winter or Spring, or day or night, or the status of the storage, any or all of the systems may automatically come into play.

## **Free Air-Conditioning???**

The entire Version 1 approach is quite sophisticated, using a combination of many different technologies to achieve sufficient and constant heating for a house. In general, all of these sub-systems work together to achieve the desired ends of constant temperatures and total comfort.

We have decided (in November 2001) to present one of the sub-systems of the NorthWarm Solar Version 1 system, as a separate presentation. It only represents about 10% of the complete

effectiveness of the Version 1 system, but we realize that it can have separate applications on its own. This portion of the NorthWarm Solar system is normally involved in providing "make-up" air for the house. Our approach to this greatly reduces the heating load of the whole house system, and, as a bonus, also can provide (in nearly all climates) virtually FREE air-conditioning for ANY whole house! As indicated, we realize that this sub-system could have many applications in existing houses, so we created a web-page that [presents this intake system](#) separately. Even if you do not want to use our NorthWarm Version 1 HEATING system, the FREE air-conditioning system should be worth a look!

Eventually, we think that our NorthWarm Solar Version 1 heating system will even be practical for totally heating economy tract homes. At the moment, however, we will concentrate on stick-built, individually designed homes.

Please contact us so that we may discuss the possibilities for your future building needs.

[More Details on this NorthWarm System](#) E-mail to: [Solar@mb-soft.com](mailto:Solar@mb-soft.com)

---

The other NorthWarm Solar heating systems:

- For existing houses, where room for a two-car-garage-sized building is available nearby in the yard. [Solar2](#)

Performance and storage will be great, but the necessarily smaller collector area and storage space make it possible that back-up heat will sometimes be necessary for heating the house.

- For existing houses, in very rural areas, where a large yardful array of tracking collectors and a high-temperature boiler system would be of advantage. [Solar3](#)

This version has potentially higher installation costs than either of the air-based systems above. Version 3 would certainly involve much more maintenance time and cost. It also has all the advantages and disadvantages of a water-based system.

- For existing or new houses. This system is different from all of the above. [Solar4](#)

It has very good performance but has intrinsically less performance ability than any of the above Versions. Version 4 is a low-tech approach to solar heating.

The results of the simulations for the proposed South Bend Demonstration House are available [here](#).

## Not Us!

Finally, if your needs and requirements are for LIMITED solar heat gain, none of these Versions makes much sense. If your desire is just to heat your domestic hot water, or to reduce your heating bill by 10%, these are probably not the way to go! There are a multitude of companies that make collector panels that you could slap on your roof for such applications.

NorthWarm has no intention in trying to "cut in" to the market for such products! Each of the four NorthWarm Versions (especially Version 1) is intended and designed and engineered for SERIOUS solar space heating; situations where no competitive technology exists that can do the job!

SO, for the multitude of people who read about the NorthWarm Versions, and then ask us to supply them with something that might go on their roof, they're barking up the wrong tree! The only NorthWarm Version that could possibly be applied to an existing roof is Version 4, by far the least sophisticated and efficient of the four! And, even then, the Version 4 system involves far more than just nailing some panels to a roof. So, please realize that the NorthWarm Versions are NOT competitors to those available roof panel systems. We actually have no competition at all, because no one seems to know how to ENTIRELY and COMFORTABLY heat a home exclusively with solar energy. Except us!

## Photovoltaic Cells, Electricity from Sunlight

This is an area where we have no suggestions or recommendations! Except for some negative information! In the same way that solar heat collector panels are promoted unrealistically, the same is true of creating electricity from solar energy. We regularly hear from people who are attempting to "become independent of the power grid." Most have already bought a few square feet of photovoltaic panels, with the various necessary special batteries, voltage regulators, circuit breakers and inverters. Some salesman had told them that they would be able to get a thousand watts of power, or some such figure.

I suppose that technically that is not quite a lie. At noon, on a perfectly clear day, it might be capable of creating the number of watts that was promoted during a sales pitch. The problem is, at 2 pm, it is liable to be down to 800 watts, but that is still on a perfectly clear day. As mentioned far above, Chicago in winter only has around 35% of clear skies. So, on the average, that means 330 watts at noon and 270 watts a while later. In an entire perfectly clear day, around 5 kWh might be collected, but that would only average 1.7 kWh per day. At current electric rates, that would be a savings of around 15 cents per day, or about \$50 per year. Now, does it make sense to pay \$4,000+ for any device that would save you \$50 per year? If it lasted for 80 years, without needing any maintenance, and if you didn't consider the interest you would have earned in the bank with that \$4,000, it might eventually pay for itself. After that 80 years, under those conditions, it might start producing actual savings. Do you see why photovoltaic electric systems are nowhere close to yet being cost effective?

In addition, the electricity is created as Direct Current, like a battery. And, without some sort of storage, it would just disappear and be wasted. So, you have to have substantial exotic batteries to save that potential of 5 kWh that could be collected in a day. And, unless you intend to only use appliances that use direct current, you would need an Inverter to convert the electricity to 120 volts AC. These devices have losses, too, so final performance is reduced.

There have been people who have bought our JUCA's \$1,400 woodburning stove, which uses a conventional furnace blower to create extremely high performance and distribute the heat throughout the house. The most common of our optional blowers uses around 700 watts of electricity. The off-power-grid people expect to use their \$4,000 photovoltaic setup to run all kinds of appliances and lights and the JUCA blower. However, that \$4,000 electricity creation system, on a perfectly sunny day, could create only enough electricity to run ONLY the JUCA blower for around 6 hours that day/evening, so there would not even be enough electricity to run one device (the blower) through the night! If they could absolutely count on perfectly clear days, around \$12,000 of photovoltaic equipment would be able to keep the blower running. For Chicago, with its 35% clear skies, around \$35,000 of photovoltaic equipment would be necessary JUST to run the blower on the \$1,400 woodstove! Seems pretty expensive to us!

The general point being made, is that salespeople of photovoltaic equipment tend to make very impressive claims for the performance of what they sell, in order to justify the rather high prices. But, since it is NOT sunny 24 hours a day, and any climate has cloudy days, and very little solar energy is collectable early or late in the day, the reality is that benefits are FAR less than the ideal scenario presented during the purchase! If you're seriously considering such equipment, ask to talk about these matters with several owners (who are NOT connected with that company!).

---

E-mail to: [Solar@mb-soft.com](mailto:Solar@mb-soft.com)

**NorthWarm Solar Heating**

:



# Solar-Heated House - Version 2

## For Northern Climates at an affordable price

The **NORTHWARM SOLAR** heating system design is a revolutionary improvement in solar space heating. The hybrid passive-active design is based on a US Patented device. **It allows substantial heating of an ENTIRE existing house in a climate like Chicago's!** Even if there is only ONE sunny day every week! Or even if there is only 1.5 hours of sunshine per day!

This design should be able to substantially heat homes in virtually all climates in the US! Common building materials and construction techniques are generally used in the construction of the structure. This makes the overall cost of the system relatively comparable to that of a two-car garage. Considering the savings that will accrue from having very reduced heating bills FOREVER, even that cost would soon pay for itself! That effectively makes the NorthWarm Solar heating system FREE! There will also never be any dependence on foreign oil or other uncertain or expensive heating source.

---

Up to now, solar heating has been impractical in moderate or northern climates. In Florida or Arizona, solar heating has long made sense, because of the great amounts of bright sunlight and the mild climates that require less house heating. Other than that, solar space (house) heating has been unrealistic, and functional solar heating has often been limited to heating domestic hot water.

For solar space heating, the early 1980s was a brief boom time. Government tax incentives and rebates created a huge demand for solar devices, and a large number of companies popped up to sell things. Unfortunately, many of those companies didn't really know what they were doing! Manufacturers made a lot of different kinds of products, and some even did some research to advance their craft. Installers appeared everywhere, and suddenly EVERYONE was an expert!

It was astounding to witness the insanity of the time. We also operate a company that makes very high efficiency fireplaces and woodstoves ([JUCA](#)). A customer buying one of our woodstoves (in about 1980) was bragging about the solar heating system that he had just had installed, for which he had paid \$7,000. When I inquired about details, it turned out that he had received three 4 x 8 solar panels mounted on his garage's roof, that was meant to heat his domestic hot water. During succeeding months, he became disillusioned with the performance of it (and therefore loved the performance of our woodstove he bought even more!) Since he realized we were knowledgeable in the subject, he would occasionally call for possible suggestions from us. (He had given up on the installer and the manufacturer of the solar collectors.) After a number of such conversations, we eventually realized that the garage was not on the south side of his house and that the collectors were facing a little north of west! It's astounding that someone would install them pointing such a weird direction, and then to charge him so much for it, too!

Many of the manufacturers were equally unprepared to sell large numbers of products. Most manufactured liquid (water) based systems, and seemed completely oblivious to the concept of electrolysis. This basic chemistry concept relates to ion transport between dissimilar metals in such a system. Aluminum and copper are particularly susceptible to corrosion due to electrolysis. Many of those companies (including nationally known companies) offered Five- or Seven- or Ten-year warranties on their products, only to find failure in half of their products within a year due to electrolysis!

Narrowing the field down to intelligently designed and intelligently installed solar systems, the better quality solar space-heating products that are still available on the market have always been (and are still) cost-ineffective. That is, they would not pay for themselves in fuel savings during their expected lifetimes.

The government also financed a few totally solar-heated, moderate-sized houses in the 1980s. In one, a \$30,000 house had a solar heating system installed that cost about \$700,000. It worked very well! But, it could never pay for itself.

More commonly, a good quality 4-foot by 8-foot solar collector panel often costs over \$1000, with a final, installed operational cost somewhat higher. Assuming it is properly sloped, aiming South, in January, under PERFECT weather conditions, it can intercept all of the Sun's light and heat, about 300 Btu/hr/sq.ft around noon (considerably less at other hours), or a day's total of about 1600 Btu/day/sq.ft. Therefore, the entire collector panel can intercept  $1600 \times 4 \times 8$  or about 51 KBtu per DAY. An average sized house near Chicago will lose about 40,000 Btu per HOUR on a very cold day, or 960,000 Btu per DAY. To totally supply this much heat, one would need about 19 of those collectors, at an installed cost of well over \$30,000, and it would only be completely effective on a perfectly sunny day. (During the winter, Chicago skies only average about 35% clearness, so it would probably need three times as many collectors for real life circumstances).

With this setup, the conventional heating fuel savings would be about \$300-\$400 per year (about \$60 per month). Sounds impressive, huh? The system would actually have to operate perfectly for about 80 years to re-coup the initial cost, not counting repairs, maintenance and lost interest on money that could have been left in the bank! This argument is basically why solar heating has remained impractical for space heating of houses --- it requires a lot of Nature's cooperation, and even then is not cost effective.

Some attempts at partially supplying solar space heating have been made. In general, these same arguments apply. Installing a few collectors to reduce house space heating might seem like a good idea, but we are not aware of any existing system that could even pay for its own cost, much less accomplish actual heating bill savings.

**UNTIL NOW!!!**

Staying for a moment more with existing systems, A common "solar home" has three or four of those 4 x 8 collector panels. Better-planned installations have some heat storage provision, which might involve 20 tons of rock storage. Let's examine this. If the three collectors were perfectly efficient, they could collect, on a perfectly sunny day in January, at noon, about 300 x 4 x 8 x 3 or 28,800 Btu/hr. If the outdoor temperature was about 15 degrees F, then this COULD be enough to (momentarily) supply the entire (well-insulated) house's heat needs. But that's ONLY just at noon, and there is no room for clouds, or temperatures below 15, or even the system inefficiencies that always exist. If any of those circumstances apply, then it cannot entirely do the heating job (even at noon!), and backup heat is therefore necessary. The 20 tons of rock storage could hold up to 200,000 Btu of heat, but even that would only assist the solar heating system for less than a day of cloudy weather. (Remember that 960,000 Btu/day house loss (for a more normally insulated house) mentioned above?) The result is that you regularly need to use conventional fossil fuel heating to do the bulk of the heating. The approximately \$10,000 that people spend to have such a system installed, will never pay for itself. BUMMER!

## Enter the NorthWarm Solar Heating System

**The NorthWarm Version 2 is an adaptation of the NorthWarm system that might be applicable to existing buildings, as long as a new building, about the size of a two car garage, could be built in the yard.** This building would collect and store the solar heat, and underground insulated tunnels would get that heat to the home.

### THE PROOF THAT IT WORKS!

Instead of the 96 sq. ft. collecting area of a traditional solar heating system, this NorthWarm Solar system was designed with nearly 300 sq. ft. of collecting area, nearly **THREE times as much collecting area**. Our unique system even improves on this, making its performance equal to better than 5 times the heat-gaining ability of a common so-called "solar house."

Under those perfect conditions referred to above (at noon, when the normal solar heating system could momentarily heat the whole house, OUR system could be heating 5 houses! If there is 5 hours of good sunlight on that day, enough heat can be gained to supply heat for the entire house for the 24 hours of a full day in the dead of winter!

Our system has such high performance capabilities, that it makes sense to have substantial heat storage capability. Instead of the 200,000 Btu (mentioned above) of common systems (if they even HAVE storage capacity!), our system has much more! The actual storage capacity will depend on the climate and size of the house. Two to three million Btu of storage (more than 10 times that of other systems!) is often appropriate.

That much storage would allow going for several days without any Sun, in the intensely cold days

of January or February, while still heating the house!

**Our system's performance is so great that it almost seems pointless to even compare previous solar space heating systems with it!**

To confirm all of this, we obtained ALL the US Weather Bureau records from their office at the South Bend Airport since they started keeping records in the 1940s. We then did massive computer simulations to see how our system would have fared in each of the winters. In early 1961, there was a stretch of ten days when the sun never shone, while the outdoor temperatures hovered near zero and often fell below. Our simulations show that this would have been one of the very few times in the past 50 years when the storage would have been fully depleted and back-up heat would have been necessary!

---

There's another way of looking at this that explains our approach. Look at all your heating bills from last winter. You can quickly total up the number of cubic feet of gas you used (multiply by 1000) or the number of gallons of oil you used (multiply by 140,000) or the number of kWh of electric heating you used (multiply by 3400). That will give the total heating used in the entire winter. There are some adjustments necessary because of efficiency, but the total (for a climate like Chicago) is likely to be around 60 to 80 million Btu for the entire winter (for a reasonable sized house).

ANY method of providing that 60 million Btus would heat your house! You could use the conventional fuels mentioned above, or a woodstove (and several cords of wood). We see solar heating as a realistic possibility. A Chicago winter usually involves around 100 pretty nasty days. And Chicago, in winter, is a really cloudy place, with only around 35% clear days. That means around 35 nice and clear days to do serious collection of solar energy. (Most salespeople would incorrectly be using all 100 days, in a REALLY optimistic sales presentation!) Now, the Version 1 NorthWarm house has around 10 million Btu of heat storage, and at the start of the winter, that storage is full and available. So, we don't quite need to provide all 60 million, but 50 million Btu collected in a winter would do the trick. With 35 available days of sun, that means we need to think in terms of collecting around 1.5 million Btus per sunny day.

Do you see where we are going? Now that we know that we need 1.5 million Btu per sunny day, if we think in terms of five strong hours of sunshine, that means we need to collect around 300,000 Btu/hour of bright sunlight. As it happens, one square foot of surface gets around 340 Btu/hour of sunlight on a completely sunny winter day. This means we need around 900 square feet of collector surface to get the needed 300,000 Btu total per hour. This is roughly the derivation of why we see the need for around 900 square feet of collection area. (The actual math is somewhat more elegant, but the point is essentially the same.)

This should also make it clear why a few "bought panels" with a hundred total square feet of collection area has no chance whatever to seriously offer savings on heating bills. That's why no

other company even dreams of their products fully heating any house. It doesn't matter if they would use special glass, or special collector configurations, or special insulation, unless they used many hundreds of square feet of collectors, no possible arrangement could entirely heat a house in a cold climate.

The NorthWarm Version 1 house actually has a little lower heat loss than the 60 MBtu used above, so the numbers are even a little better. The discussion above is meant to show that solar heating is actually a realistic possibility for existing fairly normal homes, in addition to the specially built houses like the Version 1 house.

---

OK! So, you now believe that we can really produce heat from solar. (Version 1 works even better! A link to a presentation of it is below.) The system is designed to be totally automatic, operated by a standard wall thermostat.

Very constant, comfortable heat. NO heating bills. Sounds expensive, huh?

Actually, it isn't. We have sort of blue-collar attitudes toward such things. Super-rich people do not NEED to save on their heating bills! And, they can afford to pay for extremely expensive systems that might not actually work like their promoters say they will. We're not like that. Our goal is to (1) save people money on their heating bills and (2) be kinder to the environment than society has been in the past.

We actually have FOUR different versions solar heating systems. Three of them are fairly closely related, with the fourth rather different.

The version we have been describing here is one of the group of three. It is automatic, with even and comfortable and consistent heat for the house. It REQUIRES the construction of an two-car-garage-sized out-building in the yard relatively near the house. Structure size and the amount of the underground storage beneath it are both dependent on the climate and the size and condition of the house being heated. It must have a sloping wall.

There are links to the other versions of our NorthWarm Solar heating systems below.

Since people who have interest in this are likely to be all over the country, we came to realize that we could not become licensed to be General Contractors in all the possible jurisdictions where our designs might be used. That's just as well, because we would have had trouble having constructions crews agree to travel all over the place, and we also might not have been aware of nuances of local building statutes.

Therefore, we think it generally most appropriate to work with architects and/or local contractors. The total cost of a Version 2 system will consist of four main expenses:

- Most of the materials required for the construction of the building are standard items. There are a few unusual items, such as the large number of 2 foot by 8 foot 1/4" (normal) plate glass panels, some wide-flange I-beams, and assorted other things. These items figure to increase the material cost between \$2,000 and \$10,000 above that for a "normal" garage. That range is mostly due to comparison shopping.
- Architect's charges for designing the NorthWarm Solar Version 2 out-building. This will totally depend on the attitude of the specific architect. Some might be so intrigued with the idea that they would do it for minimal charge. Others might charge quite a premium.
- Our **charge of \$10K** (for most situations). For this, our expertise and regular interactions with the architect, drawings and plans for both the architect and the contractor, and regular interaction with the contractor and certain sub-contractors. Extensive modification of the general design might involve additional expense.
- The contractor's additional charge for assembling the out-building with the NorthWarm Solar Version 2 system included. This part of the cost is probably the most variable. If, like some architects, a contractor agreed to build the out-building with little additional charge (or possibly a charge based on hourly rates for additional time involved), this part could be minimal. On the other hand, most contractors don't really like to get involved in unknown projects, because they're worried about the possibility of losing money on a cost over-run. Therefore, it is common that contractor's try to charge an obscene additional for unique or unusual features. Realistically, the contractor probably **SHOULD** charge around \$8K additional for building the out-building based on the NorthWarm Solar Version 2 system.

These considerations suggest that the grand total differential expense of this NorthWarm Solar system could range from a low of around \$12K to a high of more than three times that (above the going price of a two-car garage). (Much of the construction of the out-building is pretty traditional.) If a specific contractor has already built one of our Version 2 out-buildings, it is liable to be around \$20K.

Depending on the size of the home and the climate it is in, the annual savings on heating bills may be \$1K. This means that the NorthWarm Solar heating system should completely pay for itself in 20 years. After that, further savings are just gravy! All this suggests that there are a couple additional values involved. First, the security of **KNOWING** that the house will be fully heated regardless of political events in the Mid-East or decisions of executives or politicians that might affect fuel supplies or prices. Second, given these things, the property's **VALUE** would probably be increased more than the cost of the system, because **MANY** people would want such security.

This version is an air-based system, so there is no electrolysis threat to its longevity. Actually, long-term maintenance should be **LESS** involved than for a conventional gas or oil furnace. We think that air filters and air handler maintenance should usually be all the attention this system should require, for the lifetime of the house!

We believe that we have proven the performance of the system. The logic explained above should

make the general point. In addition, a link below can show the daily performance results of any year's simulation for heating a house in the harsh South Bend, Indiana winters.

The design is specifically NOT based on exotic glass or exotic materials or insulations in collector panels, so there is no mumbo-jumbo arguments about using high-emissivity glass or other advanced subjects. This system is more a meat-and-potatoes approach that uses conventional (soda-lime) glass, normal building insulation, normal construction methods (for the most part) and a large heat storage facility beneath the concrete floor. With very large collector area and very substantial heat storage ability, we feel the logic of the system is obvious. If it isn't, please e-mail us, and we can discuss whatever subjects you would like. We have a Physicist available to field your questions, so, hopefully, we can respond to any technical subject you might bring up!

## Free Air-Conditioning???

We have even decided to present one of the sub-systems of the NorthWarm Version 1 system, as a separate presentation. It only represents about 10% of the effectiveness of the Version 1 system, but we realize that it can have separate applications on its own. This portion of the NorthWarm Solar system is involved in providing "make-up" air for the house. Our approach greatly reduces the heating load of the whole house system, and, as a bonus, also can provide (in nearly all climates) virtually FREE air-conditioning for the whole house! As indicated, we realize that this sub-system could have many applications in existing houses, so we have a page that [presents this intake system](#) separately.

Please contact us so that we may discuss the possibilities for your needs.

E-mail to: [Solar2@mb-soft.com](mailto:Solar2@mb-soft.com)

---

The other NorthWarm Solar heating systems:

- For NEW houses, where maximum performance is desired, so that an ENTIRE large house can be TOTALLY heated, in most climates, with ONLY solar energy! [Solar1](#)

Performance and storage will be extremely great. The VERY large collector area and storage space make it certain that NO back-up heat will EVER be necessary for heating the house.

- For existing houses, in very rural areas, where a large yardful array of tracking collectors and a high-temperature boiler system would be of advantage. [Solar3](#)

This version has potentially higher installation costs than either of the air-based systems

above. It would certainly involve much more maintenance time and cost. It also has all the advantages and disadvantages of a water-based system.

- For existing or new houses. This system is different from all of the above. [Solar4](#)

It has very good performance but has intrinsically less performance ability than any of them. It is a low-tech approach to solar heating.

The results of the simulations for operation in South Bend, Indiana are available [here](#).

## Not Us!

Finally, if your needs and requirements are for limited solar heat gain, none of these Versions makes much sense. If your desire is just to heat your domestic hot water, or to reduce your heating bill by 10%, these are probably not the way to go! There are a multitude of companies that make collector panels that you could slap on your roof for such applications.

NorthWarm has no intention in trying to "cut in" to the market for such products! Each of the four NorthWarm Versions (especially Version 1) is intended and designed and engineered for SERIOUS solar space heating; situations where no competitive technology exists that can do the job!

SO, for the multitude of people who read about the NorthWarm Versions, and then ask us to supply them with something that might go on their roof, they're barking up the wrong tree! The only NorthWarm Version that could possibly be applied to an existing roof is Version 4, by far the least sophisticated and efficient of the four! And, even then, the Version 4 system involves far more than just nailing some panels to a roof. So, please realize that the NorthWarm Versions are NOT competitors to those available roof panel systems. We actually have no competition at all, because no one seems to know how to ENTIRELY and COMFORTABLY heat a home exclusively with solar energy. Except us!

## Photovoltaic Cells, Electricity from Sunlight

This is an area where we have no suggestions or recommendations! Except for some negative information! In the same way that heat collector panels are promoted unrealistically, the same is true of creating electricity from solar energy. We regularly hear from people who are attempting to "become independent of the power grid." Most have already bought a few square feet of photovoltaic panels, with the various necessary special batteries, voltage regulators, circuit breakers and inverters. Some salesman had told them that they would be able to get a thousand watts of power, or some such figure.



I suppose that technically that is not quite a lie. At noon, on a perfectly clear day, it might be capable of creating the number of watts that was promoted during a sales pitch. The problem is, at 2 pm, it is liable to be down to 800 watts, but that is still on a perfectly clear day. As mentioned far above, Chicago in winter only has around 35% of clear skies. So, on the average, that means 330 watts at noon and 270 watts a while later. In an entire clear day, around 5 kWh might be collected, but that would only average 1.7 kWh per day. At current electric rates, that would be a savings of around 15 cents per day, or about \$50 per year. Now, does it make sense to pay \$4,000 for any device that would save \$50 per year? If it lasted for 80 years, without needing any maintenance, and if you didn't consider the interest you would have earned in the bank with that \$4,000, it might eventually pay for itself. After that 80 years, under those conditions, it might start producing actual savings. Do you see why that photovoltaic electric systems are nowhere close to being cost effective?

In addition, the electricity is created as Direct Current, like a battery. And, without some sort of storage, it would just disappear and be wasted. So, you have to have substantial exotic batteries to save that potential of 5 kWh that could be collected in a day. And, unless you intend to only use appliances that use direct current, you would need an Inverter to convert the electricity to 120 volts AC. These devices have losses, too, so final performance is reduced.

There have been people who have bought our \$1,400 woodburning stove, which uses a conventional furnace blower to create extremely high performance and distribute the heat throughout the house. The most common of our blowers uses around 700 watts of electricity. The off-power-grid people expect to use their \$4,000 photovoltaic setup to run all kinds of appliances and lights and the JUCA blower. However, that \$4,000 electricity creation system, on a perfectly sunny day, could create only enough electricity to run ONLY the JUCA blower for around 6 hours that day/evening, so there would not even be enough electricity to run one device (the blower) through the night! If they could absolutely count on perfectly clear days, around \$12,000 of photovoltaic equipment would be able to keep the blower running. For Chicago, with its 35% clear skies, around \$35,000 of photovoltaic equipment would be necessary JUST to run the blower on the \$1,400 woodstove! Seems pretty expensive.

The general point being made, is that salespeople of photovoltaic equipment tend to make very impressive claims for the performance of what they sell, in order to justify the rather high prices. But, since it is NOT sunny 24 hours a day, and any climate has cloudy days, and very little solar energy is collectable early or late in the day, the reality is that benefits are FAR less than the ideal scenario presented during the purchase! If you're seriously considering such equipment, ask to talk about these matters with several owners (who are NOT connected with that company!).

---

E-mail to: [Solar@mb-soft.com](mailto:Solar@mb-soft.com)

## **NorthWarm Solar Heating**

# Solar Heating System - Version 3

The **NORTHWARM SOLAR** heating system design is a revolutionary improvement in solar space heating. This Version 3 uses movable trough parabolic reflectors to concentrate the solar energy in a small area, to generate high temperature operation. This concentrated heat is collected in a liquid filled "receiver". Depending on the application needs, that hot water could be used to provide Domestic hot water, a certain amount of Hydronic space heating, or a more sophisticated version could develop steam instead of hot water, to drive a turbine or steam engine to produce mechanical power or electricity. It is based on a US Patented device.

This design, properly engineered for a specific application, should be able to partially heat a home and/or supply domestic hot water and/or a steam powered electricity generator, in virtually any climate in the US! Common building materials and construction techniques are generally used in the construction of the various components. This can keep the cost of the system relatively reasonable. Considering the savings that can accrue from having very reduced heating bills FOREVER, even that cost would soon pay for itself! That effectively makes any of the NorthWarm Solar Heating Systems FREE! There would also be the benefit of never being dependent on foreign oil or other uncertain or expensive heating sources in the future.

---

Up to now, solar heating has been impractical in moderate or northern climates. In Florida or Arizona, solar heating has long made sense, because of the great amounts of bright sunlight and the mild climates that require less house heating. Other than that, solar heating has been generally impractical, and functional solar heating has often been limited to partial heating of domestic hot water.

Solar heating had a brief boom time in the 1980s. Government tax incentives and rebates created a huge demand for solar devices, and a large number of companies popped up to sell things. Unfortunately, many of those companies didn't really know what they were doing! Manufacturers made a lot of different kinds of products, and some even did some research to advance their craft. Installers appeared everywhere, and suddenly EVERYONE was an expert!

It was astounding to witness the insanity of the time. We also operate a company that makes very high efficiency fireplaces and woodstoves ([JUCA](#)). A customer buying one of our woodstoves (in about 1980) was bragging about the solar heating system that he had just had installed, for which he had paid \$7,000. When I inquired about details, it turned out that he had received three 4 x 8 solar panels mounted on his garage's roof, that was meant to heat his domestic hot water. During succeeding months, he became disillusioned with the performance of it (and therefore loved the performance of our woodstove he bought even more!) Since he realized we were knowledgeable in the subject, he would occasionally call for possible suggestions from us. (He had given up on the installer and the manufacturer of the solar collectors.) After a number of such conversations, we

eventually realized that the garage was not on the south side of his house and that the collectors were facing a little north of west! It's astounding that someone would install them pointing such a weird and useless direction, and then to charge him so much for it, too!

Many of the manufacturers were equally unprepared to sell large numbers of products. Most manufactured liquid (water) based systems, and seemed completely oblivious to the concept of electrolysis. This basic chemistry concept relates to ion transport between dissimilar metals in such a system. Aluminum and copper are particularly susceptible to corrosion due to electrolysis. Many of those companies (including nationally known companies) offered Five- or Seven- or Ten-year warranties on their products, only to find failure in half of their products within a year due to electrolysis!

Narrowing the field down to intelligently designed and intelligently installed solar systems, the better quality solar space-heating products that are still available on the market have always been (and are still) cost-ineffective. That is, they would not pay for themselves in fuel savings during their expected lifetimes.

The government also financed a few totally solar-heated, moderate-sized houses in the 1980s. In one, a \$30,000 house had a solar heating system installed that cost about \$700,000. It worked very well! But, it could never pay for itself.

More commonly, a good quality 4-foot by 8-foot solar collector panel often costs over \$1000, with a final, installed operational cost somewhat higher. Assuming it is properly sloped, aiming South, in January, under PERFECT weather conditions, it can intercept all of the Sun's light and heat, about 300 Btu/hr/sq.ft around noon (considerably less at other hours), or a day's total of about 1600 Btu/day/sq.ft. Therefore, the entire collector panel can intercept  $1600 \times 4 \times 8$  or about 51 KBtu per DAY. After a variety of unavoidable system inefficiencies and energy losses, the net energy gained is often half that, or 25 KBtu per DAY. An average sized house near Chicago will lose about 40,000 Btu per HOUR on a very cold day, or 960,000 Btu per DAY. To totally supply this much heat, one would need about 38 of those collectors, at an installed cost of well over \$60,000, and it would only be completely effective on a perfectly sunny day. (During the winter, Chicago skies only average about 35% clearness, so it would probably need three times as many collectors for real life circumstances).

With this setup, the conventional heating fuel savings would be about \$150-\$200 per year (about \$30 per month). Sounds impressive, huh? The system would actually have to operate perfectly for about 160 years to re-coup the initial cost, not counting repairs, maintenance and lost interest on money that could have been left in the bank! This argument is basically why solar heating has remained impractical for space heating of houses --- it requires a lot of Nature's cooperation, and even then is not cost effective.

Some attempts at partially supplying solar space heating have been made. In general, these same

arguments apply. Installing a few collectors to reduce house space heating might seem like a good idea, but we are not aware of any existing system that could even pay for its own cost, much less accomplish actual heating bill savings.

## UNTIL NOW!!!

Staying for a moment more with existing systems, A common "solar home" has three or four of those 4 x 8 collector panels. Better-planned installations have some heat storage provision, which might involve 20 tons of rock storage. Let's examine this. If the three collectors were perfectly efficient, they could collect, on a perfectly sunny day in January, at noon, about 300 x 4 x 8 x 3 or 28,800 Btu/hr. If the outdoor temperature was about 15 degrees F, then this COULD be enough to (momentarily) supply the entire (very well-insulated) house's heat needs. But that's ONLY just at noon, and there is no room for clouds, or temperatures below 15, or even the system inefficiencies that always exist. If any of those circumstances apply, then it cannot entirely do the heating job (even at noon!), and backup heat is therefore necessary. The 20 tons of rock storage could hold up to 200,000 Btu of heat, but even that would only assist the solar heating system for less than a day of cloudy weather. (Remember that 960,000 Btu/day house loss (for a more normally insulated house) mentioned above?) The result is that you would regularly need to use conventional fossil fuel heating to do the bulk of the heating. The approximately \$10,000 that people spend to have such a system installed, will never pay for itself. BUMMER!

## Enter the NorthWarm Solar Heating System

**The NorthWarm Version 3 is a different adaptation of the NorthWarm system that might be applicable to existing houses, as long as a substantial yard area (say an acre or more) is available to be used exclusively for this system.** An installation that could collect enough heat to completely heat an entire house is likely to need thirty or more separate movable concentrating collector assemblies, each 4' by 8' in collector size. We suspect that most people would consider a reduced installation that PARTIALLY provides the heat for the house! This is the only water (or water-antifreeze) NorthWarm Version.

---

Version 3 of the NorthWarm Solar Heating system uses an array of several movable parabolic trough reflective concentrators, to reflect the solar energy to a target boiler or collector. In this sense, the approach is the same as some long available products. In general, the dimensions and specifications of the individual collector assemblies, the size and design of the receiver assembly, and the spacing between them somewhat depends on the application requirements.

---

The existing available "trough collectors" on the market are all pretty sophisticated (and expensive). They use very short focus parabolic mirrors, which therefore must be very accurately and precisely made. Along a centerline of that trough, the "receiver" pipe collects the concentrated

solar energy. Every collector trough therefore has its own receiver. Since the receiver needs to have special insulation around it to keep from immediately radiating that gained energy away, these receivers ALSO are pretty expensive. Any concentrating collector must continuously move to track the sun's movement. The competing concentrating collectors that have been on the market have had very complex motorized drive systems, with a dedicated computer continuously trying to figure out where the Sun is, and what commands must be sent to the motors to properly point the concentrating collector.

Due to these considerations, we feel that trough collectors are advantageous over full paraboloid collectors. The mirror surface is less complex, only curving in one dimension rather than two, making it less complex to build and therefore less expensive. Also, the drive system really only needs to follow along a single (tilted) axis, making for less complicated and expensive drive systems and less involved pointing logic.

---

The NorthWarm approach is similar but different. It has more similarities with a governmental experimental set-up in New Mexico often called the Solar Power Tower.

Like that system, we plan for just one "receiver", mounted on a utility pole. To the north of that pole are an array of large, movable, curved mirror assemblies. Each of those separate mirror assemblies has a major shaft that is parallel with the Earth's rotational axis, so the shaft points to the North Star.

The full design of each mirror assembly has a number of additional features, but the overall concept is that of a four-foot by eight-foot panel, resembling a sheet of very thick plywood, attached to that shaft. Attached just in front of this panel, are two separate four-foot by four-foot standard single-strength mirrors. These are NOT plate glass mirrors, but thinner, with 1/8 inch thick glass.

It turns out that, by applying a "squeezing" pressure to the vertical edges of such a mirror, it will bend. If that pressure is not too great, the mirror bends without breaking! We have had many years experience with this, and have found that such 1/8 inch thick mirrors can be bent to amazing curvature in such a way! Our application, however, only requires the very slightest of curvature, and there is absolutely no danger of breaking the mirror.

It also turns out that the shape of the curve that the mirror takes is astoundingly close to being the desired parabolic shape!

**Instead of dealing with a very complex, \$2,000 parabolic trough collector, we are taking commonly available building materials and a \$40 mirror, and creating just as good a system! Instead of each assembly costing several thousand dollars, you can see that these cost around \$100.** This great economy allows building MANY of the concentrating mirror assemblies, to

collect massive amounts of solar heat in the pole-mounted receiver!

The reference earlier to two separate 4x4 mirrors was to reduce the difficulty of handling 4x8 thin mirrors, to lessen the future cost if you ever have a neighbor's kid break one, and so the two half-mirrors could be slightly tilted so the two of them could both better hit a small receiver tank on the utility pole.

You should be able to see that our approach is to use the general idea (proven over many years) of movable parabolic collectors, but to do it in a way that is far less expensive, and probably even DIY-able.

Now, each of these many separate mirror assemblies still has to move to reflect the sunlight up onto the receiver on the utility pole. It would be possible to use the traditional motor and gear train method, with a computer directing each of them (they all have to point in different directions so all the light hits the receiver). But that is still a very expensive approach, even though you now have economical mirror assemblies.

The one unique contribution of NorthWarm to this system (other than squeezing the mirrors to become parabolic!) is the economical drive system that directs each mirror assembly. NorthWarm does NOT manufacture such devices, but could provide you with the instructions to easily assemble them out of commonly available materials. If you choose to use our Version 3, you would just be paying NorthWarm for (1) a number of details on these matters already mentioned, about the assembly of the mirror assemblies and the receiver assembly; (2) additional guidance on how to get and use the energy collected in that receiver; (3) and the information on making the tracking drive systems. For this, NorthWarm is currently charging \$250.

Where other companies' solar products aim at collecting and supplying minimal amounts of energy, with VERY expensive products, our approach (with ALL of the NorthWarm Versions) is to collect and supply MASSIVE amounts of solar energy! If a specific application requires gathering a LOT of energy, then all that is needed is to build more separate concentrating reflector assemblies. Lesser energy needs would likely indicate fewer of the reflector assemblies were needed. There is a LOT of flexibility present, since you could always build a few more mirror assemblies at some later time.

If the application requires storage of that collected heat, a large hot water storage tank, such as those used with other water-based solar systems, might be required. Since our approach is always on a larger energy scale than competing solar systems consider, a pretty large capacity storage tank might be called for.

## **Cost**

The cost of each system is greatly dependant on what the application is expected to do, but, in

general, it is surprisingly tolerable. A GREAT consideration in Version 3's final cost is the "handiness" of the home owner. A creative and handy individual could assemble a lot of the assemblies and structures, possibly even using surplus parts. In such case, the total cost could be QUITE low! On the other hand, if all of the assemblies would be built of list price materials by union craftsmen, the total cost could be HUGE!

A substantial portion of the cost of a Version 3 System could be in actually using the energy collected. If energy storage is desired or necessary, that tank can be pretty expensive, as much as nearly everything else, if the person builds most of the assemblies. If generated steam is to be used in a turbine to generate electricity, that turbine and alternator may also cost as much as all the parts WE normally consider the solar Version 3 System, the array of movable concentrating collectors and the receiver. So, there is no obvious way that we can better guide you on total costs, but you should be able to do that on your own, knowing what your desires are.

As to limitations on the Version 3 System, there are relatively few. If you feel the need to generate 10,000 watts of electricity, well, that would not be a problem. Say you build 20 mirror assemblies, each of which is the 4x8 size. That's 640 square feet of sunlight that you would be intercepting. Each square foot (on a sunny day) is over 300 Btu/hr, so that would be a total of 192,000 Btu/hr. If ALL of that could be converted to electricity, that would be over 35,000 watts! A variety of unavoidable inefficiencies exist in the various parts of this system, and there are heat losses, too, but getting 10,000 watts of electricity would be easy!

By the way, NO competing solar supplier would even DREAM of supplying that much electricity from solar! Today, commonly, photovoltaics are used for generating electricity, and enough photovoltaics for even 1,000 watts generally costs around \$7,000. So, 10,000 watts from photovoltaics would involve at least \$70,000 in purchases! Our system would involve those 20 mirror assemblies (home-built for around \$150 each) and the utility pole and receiver (\$500) and a turbine and alternator (\$??). Instead of \$70,000, this probably amounts to around \$5,000, only about 1/14 as much! Solar generated electricity can start to make sense!

We have sort of blue-collar attitudes toward such subjects. Super-rich people do not NEED to save on their heating bills! BUT, they are the ones who can afford to pay for those competitive extremely expensive systems that might not actually work like their promoters say they will. We're not like that. Our goal is to (1) save people money on their heating bills and (2) be kinder to the environment than society has been in the past.

---

We actually have FOUR different versions solar heating systems. Three of them are fairly closely related (this being one of them), being based on a patented system, with Version 4 being rather different, and rather low-tech.

The version we have been describing here is one of the group of three. It is the only of the four that



uses water-antifreeze as the collecting medium. It's use and operation could be made automatic, with even and comfortable home heating or hot water supply, or substantial electricity generation. It is a system that can often be added to an existing house or building (with a big yard for the mirror assemblies).

This system is a sort of home-sized version of the large scale Solar Power Tower electric generation systems in the US Southwestern desert. Many independent moveable curved mirror assemblies are mounted on separate pedestals in a field. They each continuously move to reflect the sunlight to a steam boiler mounted on a separate tower / pedestal.

**Version 3 REQUIRES a good amount of yard area to be committed exclusively for the various parts of this system.** Most other parameters of this system have a lot of flexibility.

---

There are links to the other versions of our NorthWarm Solar heating systems below.

As mentioned above, NorthWarm could supply plans and drawings for building the various component sub-assemblies, along with an assortment of useful information and suggestions, for \$250.

Depending on MANY variables (installation options, climate, etc), the annual savings on heating (or electric) bills may be \$1K. This means that the NorthWarm Solar heating system should completely pay for itself in just a few years. After that, further savings are just gravy! All this suggests that there are a couple additional values involved. First, the security of KNOWING that the house will be partially or fully heated regardless of political events in the Mid-East or decisions of executives or politicians that might affect fuel supplies or prices. Second, given these things, the property's VALUE would probably be increased more than the cost of the system, because MANY homebuyers would want such security.

This version is designed to be a liquid-based system. The design is generally NOT based on exotic glass or exotic materials or insulations in collector assemblies, so there is no major mumbo-jumbo arguments about using high-emissivity glass or other advanced subjects. Just generic mirrors are used, for example, and not special ones. With very large total solar collection area, we feel the logic of the system is obvious. If it isn't, please e-mail us, and we can discuss whatever subjects you would like. We have a Physicist available to field your questions, so, hopefully, we can respond to any technical subject you might bring up!

## **Free Air-Conditioning???**

We have even decided to present one of the sub-systems of the NorthWarm Version 1 system, as a separate presentation. It only represents about 10% of the effectiveness of the Version 1 system, but we realize that it can have separate applications on its own. This portion of the NorthWarm

Solar system is involved in providing "make-up" air for the house. Our approach greatly reduces the heating load of the whole house system, and, as a bonus, also can provide (in nearly all climates) virtually FREE air-conditioning for the whole house! As indicated, we realize that this sub-system could have many applications in existing houses, so we have a page that [presents this intake system](#) separately.

Please contact us so that we may discuss the possibilities for your needs.

E-mail to: [Solar3@mb-soft.com](mailto:Solar3@mb-soft.com)

---

The other NorthWarm Solar heating systems:

- For NEW houses, where maximum performance is desired, so that an ENTIRE large house can be TOTALLY heated, in most climates, with ONLY solar energy! [Solar1](#)

Performance and storage will be extremely great. The VERY large collector area and storage space make it certain that NO back-up heat will EVER be necessary for heating the house.

- For existing houses, where room for a two-car-garage-sized building is available nearby in the yard. [Solar2](#)

Performance and storage will be great, but the necessarily smaller collector area and storage space make it possible that back-up heat will sometimes be necessary for heating the house.

- For existing or new houses. This system is different from all of the above. [Solar4](#)

It has very good performance but has intrinsically less performance ability than any of them. It is a low-tech approach to solar heating.

The results of the simulations for operation in South Bend, Indiana are available [here](#).

## Not Us!

Finally, if your needs and requirements are for limited solar heat gain, none of these Versions makes much sense! If your desire is just to heat your domestic hot water, or to reduce your heating bill by 10%, these are probably not the way to go! There are a multitude of companies that make collector panels that you could slap on your roof for such applications.

NorthWarm has no intention in trying to "cut in" to the market for such products! Each of the four NorthWarm Versions (especially Version 1) is intended and designed and engineered for SERIOUS solar space heating; situations where no competitive technology exists that can do the job!

SO, for the multitude of people who read about the NorthWarm Versions, and then ask us to supply them with something that might go on their roof, they're barking up the wrong tree! The only NorthWarm Version that could possibly be applied to an existing roof is Version 4, by far the least sophisticated and efficient of the four! And, even then, the Version 4 system involves far more than just nailing some panels to a roof. So, please realize that the NorthWarm Versions are NOT competitors to those available roof panel systems. We actually have no competition at all, because no one seems to know how to ENTIRELY and COMFORTABLY heat a home exclusively with solar energy. Except us!

---

E-mail to: [Solar@mb-soft.com](mailto:Solar@mb-soft.com)

**NorthWarm Solar Heating**

# Solar Heating System - Version 4

The NORTHWARM SOLAR heating system designs are all very advanced and unique. Versions 1, 2 and 3 are meant for ultimate heat collection and distribution throughout a good-sized house for a relatively normal family. They are extremely effective at accomplishing amazing solar heating at a tolerable cost. This Version 4 is entirely different from those three. It is NOT based on the patent that the other Versions are based on. It is a very LOW-TECH system!

We encourage you to look at the web page presentations of the other Versions (especially Version 1). There are links at the end of this page with brief descriptions of the various Versions, so you could visit any of those separate pages. This Version 4 is unique in itself! It can be set up to also provide virtually all the heat needed for a normal home!

All competing solar heating systems on the market use either air or liquid (usually water with antifreeze) for the heat collection and transport medium. Even our Versions 1 and 2 use air and Version 3 uses liquid. Version 4 is very different and unique. It is designed specifically to use **used motor oil!**

OK! On first thought, that sounds pretty questionable. But, think about it a little further. You'll see some real benefits from this medium!

For discussion's sake, consider a house that has a fairly steep roof and is oriented so that the main roof ridge is east-to-west. This means that there is a large, steep, south-facing area of the roof. Now consider mounting two by fours, on top of the roof, ON EDGE, from the roof ridge to the eave. Next, get or make a bunch of sections of a modified version of metal corrugated roofing. The edges of these pieces are modified in a way to arrange for a final lip outward. The idea is that the piece will fit between the two by fours you attached to the roof, with the edge lips resting on the topmost (outermost) edge of the two by fours, to be nailed there. This will vaguely resemble a series of playground slides.

We found that the best situation is that the pieces of corrugated metal extended the whole distance from ridge to eave. If a joint must be made, it should overlap at least 8 inches, and have a lot of silicone-caulk sealing the two pieces together. NO nails or other holes should exist ANYWHERE in the trough between the edge rib two by fours. If even a tiny amount of the oil leaked or seeped out, the smell is REALLY obvious and annoying!

For an experimental system we built once, we then obtained two very large (1200 gallon) concrete septic tanks, which we put in the crawl space under the house (before it was built). Those tanks were placed on two layers of two inch thick blue Styrofoam, and then two layers of the same insulation was attached to all the outside surfaces of each of the two septic tanks. (This insulation gave about R-20 insulation value. The tanks then were painted ON THE INSIDE (a nasty job!)

with polyurethane concrete paint, to seal the surface from oil seepage.

Then, obtain used motor oil. There are companies that recycle it, but there are also many companies that will give it away to you. You do NOT need to, or even WANT to, clean or re-process it. From our point-of-view, the dirtier the oil, the blacker, and the better! If you use the twin large septic tank reservoir set up like we did, you will be able to put thousands of gallons of used motor oil in the reservoirs.

The specific heat of most petroleum based products is around 0.50. A gallon of used motor oil weighs around 7 pounds. In our example set-up, we had a total of 2400 gallons of storage, which means  $2400 * 7 = 16,800$  pounds of oil in the tank. The specific heat means that  $16,800 * 0.5 = 8,400$  Btus of heat is stored for each degree rise in the temperature of the oil. With this example, when we would sometimes get the storage up to 150°F, which was 80°F higher than the desired 70°F house temperature, the storage contained  $8,400 * 80$  or 672,000 Btus of heat storage. That was essentially enough to entirely heat that whole house for about 24 hours. Similar calculations can be done for any size and number of storage tanks.

Next, we got a really heavy-duty (industrial) pump, which was specifically designed to be able to pump viscous liquids. (A 'normal' water pump could move the oil acceptably when the oil was hot, but really strains when it was cold and thick.) That pump was connected so that it could draw liquid from either or both septic tank reservoirs, and it would pump the (black) used motor oil through a large 2" pipe up to an even larger diameter pipe that extended along the entire ridgeline of the house. Many appropriately located, varying diameter holes were drilled in the bottom of that pipe, so that the black motor oil could come out and onto the corrugated metal. At the eave edge, a similar large diameter pipe collected the oil after it passed down along the surface of the roof, and then that drained (by gravity) back into the septic tank reservoirs. We put a 'connector pipe' between the two septic tanks so neither could overflow or overflow.

Two layers of standard window or plate glass then covered the entire area of the metal channels on the roof. We found that good caulking and weather stripping was very important, so that there was never any hint of smelling the oil. Also, if even a little rainwater got into the oil, it turns a whitish color that doesn't collect solar energy as well.

The above generally describes the whole concept and the whole system. You probably see some of the way it works. This method has several aspects of real elegance that you might not realize!

On a cool, sunny day, the pump turns on. The oil is pumped up to the ridgeline, and distributed evenly over the entire length of the corrugated collector area. The specific shape of the metal troughs keeps the oil spread out over the whole width of the collector trough, to make sure not to miss any of the solar energy hitting any area. The black oil will absorb a great deal of the heat hitting it, mostly because it's black! By the time this oil gets to the eave area, it is substantially warmer than before, due to the heat it absorbed as it slowly moved down the roof surface. This

new, warmer oil drains back into the reservoirs, adding to the heat stored there.

On very cold days, the oil becomes more viscous, and so it flows down the corrugated metal collector areas more slowly. This is beneficial, since it gives that oil some additional time to absorb solar energy. This tends to make it more efficient at accumulating solar energy when it is needed most! On mild days, when all of the oil in the reservoirs is quite hot, the flow is much more rapid, reducing solar heat collection when it is hardly needed. On really mild days, when the storage is as hot as it needs to be, or during the summer, the pump does not turn on, and the metallic surface of the metal will tend to reflect the solar energy, reducing the air conditioning load in the summer.

Being motor oil, there is no danger of it freezing (like water) during very cold weather, so there is no need for a lot of expensive anti-freeze. At the other extreme, there is no danger of the fluid boiling if you start really getting the storage reservoirs really hot. Additionally, this system eliminates society's need for safe disposal of thousands of gallons of used motor oil, thereby benefiting the environment!

There are a variety of ways that the heat can be removed from the storage reservoirs. Since we put the reservoirs under the house, we found that by (automatically) removing some of the insulation on the top of the reservoirs, we could get some heating up to warm the underside of the floor above. We also put several old (ugly?) steam radiators inside the septic tank reservoirs. These very durable, cast-iron radiators are really heavy! But, by using a separate hydronic pump to send water through them, that water would quickly heat up to virtually the temperature of the oil in the reservoir. That water could then be run to normal hot-water radiators in the various rooms of the house. This operation even allowed zoning the heating system of the house, to independently set the temperature of each room!

If a sufficient area of collecting area is used, an amazingly good performance can be had! Our system had about 770 square feet of collecting area. On a nice sunny day, sunlight has about 300 Btu/sq.ft./hour available. This means that we could sometimes collect as much as 230,000 Btu/hr! (There are several technical reasons why it is actually slightly less than this, but 210,000 Btu/hr is very realistic!) During an entire clear, sunny day, more than a million Btus were occasionally collected!

That particular house was moderately insulated, and moderately-sized, in a rather nasty winter climate (northern Indiana), and the house would use up about 40,000 Btu/hr when it was continuously 10 below zero (the 'design temperature'). In 24 hours, that's 960,000 Btu. That means that the half dozen hours of clear sunlight during the day could collect enough solar energy to heat the entire house for all 24 hours of a day EVEN when it was 10 below outside! (You won't find anybody else's system that could accomplish that!)

The amount of storage described above can represent as much as 1,500,000 Btu of heat storage (if

the oil is at the reasonable maximum of 250°F). This would be enough to maintain the entire house at 70°F inside, for more than two full 24-hour days **without any sun** when it was -10°F outside! Pretty impressive, huh?

The Version 4 System was not really intended as a "total" solar heating system, so we felt that that amount of storage was fine, but larger storage tanks or more of them could obviously increase the storage heat capacity, for larger houses or longer heating capability without sun.

**(Actually, our Version 1 system has even far better performance!)**

If it was 30°F outside, that amount of storage could likely keep the entire house comfortably heated for an entire week without sun! Of course, installing a third storage reservoir, would improve on even this amazing performance.

When the storage is relative full (the oil is pretty hot), a side benefit of this system is that the hot oil flows down the collector area rather quickly, long enough to gain some solar energy, but not so long that the hot oil would lose much heat by radiative loss while it was in the collector. The glass on top of the collector areas adds to this aspect. It is relatively transparent (about 90%) to the incoming solar energy, but relatively opaque to the infrared heat that would be radiated outward by the oil, thereby keeping most of the heat in the system.

**Version 4 REQUIRES a LARGE AREA, properly oriented and sloped roof surface.** An alternative might be to build a separate sloping structure near the house. Also required is a person who has good abilities at fairly normal construction.

There are links to the other, more sophisticated Versions of our NorthWarm Solar heating systems at the bottom of this page.

We think that a reasonably adaptable person could build this Version 4 system just from the descriptions above. All sorts of improvisations might occur to the constructor, to use locally available materials (like the surplus radiators we used) to assemble the system. Even though we own the invention and the design, we would let people make single systems based on the above descriptions for their own homes. We would NOT permit contractors to build multiple installations without specific written agreements regarding them.

We really don't think it should be necessary, but we can supply general plans and drawings and recommendations for building this system. We charge \$250 (US) for these plans. The necessary materials are minimal cost (except for the pump, the tanks and all the glass). If you want or need us to do additional engineering/design regarding specifics for a particular climate or house size, or if you want us to consult on related matters, there would be an additional per-hour charge for such services. When people e-mail us regarding specific guidance for their unique application, this situation would fairly properly apply.

A GREAT consideration in Version 4's final cost is the "handiness" of the homeowner. A creative and handy individual could improvise and construct a lot of the assemblies and structures, possibly even using surplus parts and materials. In such case, the total cost could be QUITE low! On the other hand, if all of the assemblies would be built of list price materials by union craftsmen, the total cost could be substantial!

The saving on heating bills by using this low-tech system ensure that it would pay for itself in just a few years. In the case of our original system, we found a source for surplus (used) store-front plate glass windows, and we did similar scrounging for the other items, and the total materials cost was not much over \$1,000. We saved virtually that much each and every winter, so it quickly paid for itself. After that first winter, further savings were just gravy! All this suggests that there are a couple additional values involved. First, the security of KNOWING that the house will be fully heated regardless of political events in the Mid-East or decisions of executives or politicians that might affect fuel supplies or prices. Second, given these things, the property's VALUE would probably be increased more than the cost of the system, because MANY people would want a home with such security.

The design is NOT based on exotic glass or exotic materials or insulations in collector panels, so there is no mumbo-jumbo arguments about having to use high-emissivity glass or other advanced subjects. The usage of special "solar" glass WOULD improve the system performance, but not enough to counteract the MUCH higher price of those kinds of glass. This Version 4 is based on a VERY LOW-TECH approach, where expensive, exotic components are not necessary. Standard 1/4" plate glass and other standard materials are generally used. With the very large collector area, we feel the logic of the system is obvious. **Large collector area = a lot of heat collected. Large storage tank(s) = enough heat for a substantial house for a good number of hours.** It's all actually pretty simple in concept.

## Free Air-Conditioning???

We have even decided to present one of the sub-systems of the NorthWarm Version 1 system, as a separate presentation. It only represents about 10% of the effectiveness of the Version 1 system, but we realize that it can have separate applications on its own. This portion of the NorthWarm Solar system is involved (in winter) in providing "make-up" air for the house. Our approach greatly reduces the (winter) heating load of the whole house system, and, as a bonus, also can provide (in nearly all climates) virtually FREE air-conditioning for the whole house! As indicated, we realize that this sub-system could have many applications in existing houses, so we have a page that [presents this intake system](#) separately. In a similar way to our freely offering this information on the Version 4 heating system, we present sufficient information in that presentation to assemble the free air-conditioning system, also at no charge.

E-mail to: [Solar4@mb-soft.com](mailto:Solar4@mb-soft.com)



The other NorthWarm Solar heating systems:

- For NEW houses, where maximum performance is desired, so that an ENTIRE large house can be TOTALLY heated, in most climates, with ONLY solar energy! [NorthWarm Solar Version 1](#)

Performance and storage will be extremely great. The VERY large collector area and storage space make it certain that NO back-up heat will EVER be necessary for heating the house. A Version 1 System house must be designed around certain aspects of the Version 1 System.

- For existing houses, where room for a two-car-garage-sized building is available nearby in the yard. (That building can NOT be used as a garage!) [NorthWarm Solar Version 2](#)

Performance and storage will be great, but the necessarily smaller collector area and storage space make it possible that back-up heat will sometimes be necessary for heating the house.

- For existing houses, in very rural areas, where a large yardful array of tracking collectors and a high-temperature boiler system would be of advantage. [Solar3](#)

This version has potentially higher installation costs than either of the air-based systems above. It would certainly involve much more maintenance time and cost. It also has all the advantages and disadvantages of a water-based system.

The results of the simulations for operation in South Bend, Indiana are available [here](#).

## Not Us!

Finally, if your needs and requirements are for limited solar heat gain, none of these Versions makes much sense. If your desire is just to heat your domestic hot water, or to reduce your heating bill by 10%, these are probably not the way to go! There are a multitude of companies that make collector panels that you could slap on your roof for such applications.

NorthWarm has no intention in trying to "cut in" to the market for such products! Each of the four NorthWarm Versions (especially Version 1) is intended and designed and engineered for SERIOUS solar space heating; situations where no competitive technology exists that can do the job!

SO, for the multitude of people who read about the NorthWarm Versions, and then ask us to

supply them with something that might go on their roof, they're barking up the wrong tree! The only NorthWarm Version that could possibly be applied to an existing roof is (this) Version 4, by far the least sophisticated and efficient of the four! And, even then, the Version 4 system involves far more than just nailing some panels to a roof. So, please realize that the NorthWarm Versions are NOT competitors to those available roof panel systems. We actually have no competition at all, because no one seems to know how to ENTIRELY and COMFORTABLY heat a home exclusively with solar energy. Except us!

---

E-mail to: [Solar@mb-soft.com](mailto:Solar@mb-soft.com)

**[NorthWarm Solar Heating](#)**

# JUCA Hi-Efficiency Wood Burning

## and Gas Burning Fireplaces and Stoves

JUCA has produced high quality, high-efficiency, clean-burning wood- and gas-burning fireplaces, stoves and wood burning furnaces for over 20 years. **Over 100,000 Americans live in homes being entirely heated with JUCA products. People LOVE them!**



**Most JUCA units can feed warm air into house warm air ducts to supply heat to the entire house.** The popular [Model F-9A](#) (shown here) is rated at **140,000 Btu/hr output (about like a normal gas house furnace.)** **An F-9A can heat the WHOLE HOUSE and looks EXACTLY like a normal fireplace!** A strong 465-cfm blower is included as standard, with several options up to 2,550-cfm (3/4 HP) for VERY large houses. Beautiful Brass Doors are included! **And the F-9A is only about \$1,400!**

**JUCA makes a wide variety of models, including Built-In Models ([F-series](#)), Free-Standing Models ([B-series](#)), Free-Standing Models with 3 Glass Sides ([C-series](#)), and Fireplace Insert Models ([L-series](#)).** JUCA also makes basement-style wood-furnaces ([A-Series](#)) **All can use wood OR gas OR both!**

Free-Standing Models are available in about [35 standard colors](#). **The Built-In Fireplace Models can have over [2,000 different appearances!](#)** (Including Arch-Tops!)

---

[Click here to find out:](#)

[How Does A JUCA Work???](#)

---

[PRICES](#)

[Many Other  
Subjects](#)

[URGENT!](#)

[Solar  
Heating??  
FREE Air  
Conditioning??](#)



(Three-glass-sided Model B-3D shown here) **Nearly all JUCA models are individually CUSTOM MADE** so a customer can request special features or special-size dimensions, for a special application or situation. In addition, JUCA often makes exotic and unusual units to order, such as a 5-glass-sided unit (for a 5-sided room) and wedge-shaped units for hyper-modern motifs. **JUCA's efficient operation keeps prices very reasonable**

JUCA products all include extremely sophisticated high-efficiency heat-exchangers. A computer was extensively used in CAD to maximize performance. **That's why JUCAs stand alone in entirely heating whole houses! Several are GUARANTEED to be able to entirely heat ANY home in the U.S. This is true whether burning wood OR gas!** With wood, 8-12 hour burn times are normal, while burning cleanly! That's why JUCA was featured on the [TODAY Show](#), in [NEWSWEEK](#), in the New York Times, in [Mother Earth News](#) and elsewhere.

**JUCAs are entirely manufactured in the U.S.**

By the way: It is not NECESSARY to get huge heat output from a JUCA. On mild days, you can use it to just "take the chill off."

Many owners have found that their house values increased more than the cost of the JUCA!

(Model B-3B shown here) JUCA products are so advanced that sometimes it may not be obvious to a prospective customer just all the choices and options available for a particular house. **JUCA has created hundreds of web-page presentations** to help supply answers to questions and solutions to unique installation situations. Many background subject discussions on fireplaces, woodstoves, wood burning, etc., are included in its **2,900 screens**. Of course, substantial information is also included on the many JUCA models, their various options, and a multitude of suggestions on how best to plan, install and enjoy a JUCA. **All prices of all products are included, even all the hundreds of options available to you.**



**Bad News!**

[Click Here](#) for more info on Fireplaces;

[Or Here](#) for more info on Stoves;

[Or Here](#) for more info on 3-Glass-sided Stoves;

[Or Here](#) for an Index of Many More Subjects.

**E-mail your questions to JUCA at [JUCA@mb-soft.com](mailto:JUCA@mb-soft.com)**

---

The web-site includes pictures which help one know the distinction between mantels, lintels and hearths in a regular fireplace; discussions on modern house-air purity considerations; hundreds of suggestions on getting maximum performance and enjoyment from your fireplace/woodstove. [An Inter-Active 'Questionnaire'](#) asks some questions about the house and then does an **approximate heat-loss analysis of the house**. It then suggests the best JUCA and best blower for that specific house and *even calculates the amount of wood to cut to heat it completely for a whole winter!*

Hundreds of other presentations address specific subjects. There's a chart that describes the burning characteristics of [about 35 species of wood](#). A sub-program helps select among over [2,000 different brass-door appearances](#) available for the Model F-9A! A LOT of useful stuff!

For technical jocks, the web-site includes some really hairy stuff, such as the [quintuple Integral Calculus equations](#) used to design the JUCA heat exchangers for maximum performance. Theory, physics, chemistry, thermodynamics and aerodynamics discussions are included in the [TECHNICAL section](#). (NORMAL people don't have to be subjected to this sort of abuse!)

For NON-Technical people, there are visual mini-movies, charts, graphs and such to present the JUCA concepts for most people.

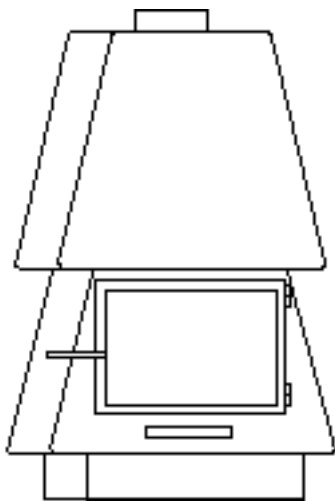

The rotating free-standing **JUCA Model B-3B** at the left shows a number of its features.

On the front is the **large (15" by 21") glass door**, and slide **draft control** underneath.

On the back is the **(Standard) blower** near the bottom, the **8" by 16" warm air outlet** (to connect into ducts) near the top, and the **automatic blower control assembly** to the right.

Less obvious are the **adjustable warm air outlets** on the sides, under the overhangs about halfway up.

# Clean-Burning Non-Airtight Operation

**JUCA products are all designed to work on a NON-airtight principle of operation. This is a VERY important (and unique) characteristic of all JUCA products.** ALL other (competing) woodstoves and efficient fireplaces operate on an air-suffocation (or air-tight) principle of operation. That approach **NECESSARILY** causes major changes in how the fire burns and how the fireplace/woodstove operates, from how it would have worked as a "normal" fireplace. These effects require those products to have designs which have small fireboxes, small doors and small glass areas, limited heat exchange areas, and a sealed fire chamber. They also require **SERIOUS** design attention to the fact that suffocation designs tend to burn poorly, and therefore tend to create creosote and pollution.

JUCA uses a totally different approach. **Our NON-air-tight design allows the woodstove/fireplace to operate very similarly to how a fireplace traditionally operated, VERY cleanly.** (You could even roast marshmallows or make popcorn in it, which you cannot do with ANY competing product! Competing products cannot be operated with the door open because the design theory doesn't allow it.) Our computer-designed heat exchange structure up above captures most of the heat that would have been lost up the chimney, we have a huge firebox size, a very large glass viewing area, a large door for feeding wood, and a blower that is **MUCH** stronger than any competitor.

All these characteristics combine to capture the most heat possible from the fire's output, while not messing up the fire's original operation. **That original operation always included very clean burning**, which the JUCA's design maintains. JUCAs do NOT share the air-tight products' problems of huge creosote and pollution creation. JUCA's non-air-tight design allows capturing all that heat while burning so cleanly that no "catalytic combustor" or "secondary burn" is even necessary or desirable!

This difference between the JUCA's non-airtight design and ALL competing products (which are ALL airtight) has some other implications. Because those airtight products developed a bad reputation in the 1980s for creating a lot of pollution and creosote (because of the suffocation of the airtight operation), the EPA and other government agencies passed stringent laws applying to them. Commonly, the chimney must be re-lined (\$\$\$).

A JUCA woodburner does not require all that, and the EPA and other agencies agree. The JUCA unit actually **operates as a traditional old fireplace did** with the only major difference being that the JUCA captures most of the heat that would have gone up the chimney. Building fires is the same as in a conventional fireplace, and the fire behaves as you expect a fireplace fire to behave. That is definitely NOT true of airtight woodstoves and fireplaces, which operate **VERY** differently!

# Why are JUCAs different from all competing Woodburners?

The answer to that is pretty complex, and it's why we have hundreds of informational pages in our web-site. A capsule version:

Back in the 1970s, only Potbelly stoves, Franklin stoves and barrel stoves existed. They all produced huge amounts of heat, but TOO MUCH, and for only an hour or two. Great temperature variations in the room were common. So the problems were: too much heat and too short a burning period.

**Two solutions arose.** The Airtight design and the JUCA design.

- The **airtight approach** was to severely restrict the amount of air available to the fire. With less air, less burning (which is actually chemical oxidation of the fuel) could occur, which means less excessive heat production, which is good. Since the wood did not get consumed as rapidly, it lasted longer, giving longer burn times, which is also good.

With MODERATE restriction of the air supply, this represented a great improvement over previous woodburners. During the 1970s, people tended to use them in such an appropriate way.

When energy awareness became dominant about 1980, people started to try to use such products in extreme ways. They SERIOUSLY restricted the air supply, to make them operate even more efficiently. That happened, but an unexpected consequence was extremely poor burning. Under some conditions, fully 1/3 of the energy in the wood was going up the chimney as creosote and pollution! Which also reduced intrinsic efficiency, but no one noticed.

In the early 1980s, a lot of houses burned down, because massive unseen creosote accumulations in chimneys would catch fire and burn at over 5000°F, and no chimney could handle that. A lot of pollution was also getting put in the air.

- The **JUCA approach** was very different. It involved a larger firebox, normal non-airtight burning, MUCH thicker pieces of wood, and a sophisticated heat capture system. In principle, the fire would be allowed to burn as rapidly as it wished, but the thick pieces of wood (logs) NATURALLY only burn at a moderate rate, because burning can only occur at the SURFACE of a piece of wood. (Thicker logs actually burn more slowly!)

Thicker logs ALSO naturally burn more EVENLY (for reasonably constant heat output) and for a much longer time.

The JUCA design accomplishes the goals of evenness of heating and long burn times, in a VERY different way than airtight designs do. In a far more natural way. **The burning is extremely complete and efficient and clean. Virtually NO creosote or pollution is created in the fire, as fireplaces have operated for hundreds of years!**

The flaw in the logic so far is that thick logs burn so slowly that they create rather small amounts of heat. This is why the sophisticated heat capture and heat exchanger system in a JUCA is so important. It captures MOST of the heat actually produced, and sends it out into the room and does not allow it to go up the chimney.

As a footnote, airtight products CAN NOT safely use extensive heat exchangers to improve their efficiency. Since they naturally produce so much creosote in their smoke, and creosote condenses out at about 350°F, they must NOT be extremely efficient. Otherwise, they would cause massive creosote accumulation in their chimney systems. Some products like that were briefly sold around 1980, but they proved to be very dangerous products for this reason. Since JUCAs are non-airtight, the fire burns very cleanly, so there's little very creosote in the smoke, so we can capture the daylight out of the heat in the smoke! An optimally efficient JUCA can have smoke temperatures of 250°F. We are thus able to capture more than an extra hundred degrees of heat from the smoke before it goes up the chimney! Voile! Very high efficiency!

[Click Here](#) for more info on Fireplaces;

[Or Here](#) for more info on Stoves;

[Or Here](#) for more info on 3-Glass-sided Stoves;

[Or Here](#) for an Index of Many More Subjects.

**E-mail your questions to JUCA at [JUCA@mb-soft.com](mailto:JUCA@mb-soft.com)**

---

## JUCA Varieties

- [JUCA Built-In Fireplace Models](#)
  - [Normal-Appearing Built-In \(Traditional\) Fireplaces](#)
  - [Arch-Top Built-In Fireplaces](#)



- [Double-Sided Built-In Fireplaces](#)
  - [Custom-Sized Built-In Fireplaces](#)
  - [Unique Custom Built-In Fireplaces](#)
  - [JUCA Free-Standing Fireplace/Woodstoves](#)
    - [JUCAs with One Large Glass Door](#)
    - [JUCAs with Three Glass Sides](#)
    - [Custom-Sized or Unique Free-Standing Fireplace/Woodstoves](#)
  - [JUCA \(Basement or Garage\) Furnace Units](#)
  - [JUCA Fireplace Insert Models](#)
  - [Other Unique JUCAs for Specific Applications](#)
  - [JUCA Gas-Burning Units](#)
  - [Specifications on JUCA Products](#)
  - [Where to find JUCA Products](#)
  - [An Index of Many More Subjects.](#)
  - E-mail your questions to JUCA at [JUCA@mb-soft.com](mailto:JUCA@mb-soft.com)
- 

## JUCA Built-In Fireplace Models

Other companies' 'Zero-clearance' fireplaces all have unusual appearance, which give away the fact that they are not actually massive masonry fireplaces. **Not so with the JUCA F-9A series.**

The JUCA facing appearance is exactly like a conventional fireplace with a set of brass doors on it. There are no ugly black metal panels with air holes around the door opening. (All the "performance parts" are hidden inside the wall). 'Brass' may be too specific a term here since JUCA offers Antique Brass, Polished Brass, Satin Brass, Black, Copper, Chrome, Pewter, Nickel, Swedish Metal, Enamel, and all manner of combinations of these. Most mantel treatments are compatible with a JUCA F-9A. In recent years, Arch-Top JUCA F-9As have become quite popular. Over-size dimensions (or dimensions to suit a specific space) and many custom options are commonly included as part of an F-9A. **JUCA offers over 2,000 different "standard" appearances!** If this incredible choice isn't enough, even gold-plated and platinum-plated optional facings have occasionally been requested and supplied!



The F-9A is rated at 140,000 Btu/hr output, WAY more than any competing fireplace. All JUCAs use conventional large or small house ducting and normal warm air grille outlets to get the heat out into the room (and house). The air intakes and outlets DO NOT have to detract from the appearance of the fireplace. **They can be on other walls or even in other rooms!**

No matter WHAT decor and "mood" you want to create, a JUCA F-9A can help achieve it.

**Performance to heat the ENTIRE HOME combined with beautiful conventional fireplace appearance and operation. Wow!**

**About \$1,400 up (plus shipping)** [Details, Options](#)

[For a better view of the JUCA F-9A](#)

---

## **JUCA Built-In Fireplace Model Types**

- [Rectangular Built-In \(Traditional\) Fireplaces](#)
  - [Arch-Top Built-In Fireplaces](#)
  - [Double-Sided Built-In Fireplaces](#)
  - [Custom-Sized Built-In Fireplaces](#)
  - [Unique Custom Built-In Fireplaces](#)
- 

[Click Here](#) for more info on Fireplaces.

[Or Here](#) for an Index of Many More Subjects.

**E-mail your questions to JUCA at [JUCA@mb-soft.com](mailto:JUCA@mb-soft.com)**

[Click Here](#) to return to the Main Menu

---

## Built-In Traditional Fireplaces

Most people tend to select a conventional rectangular fireplace appearance on their JUCA Fireplace. The standard size of the F-9A is the so-called 36(w) by 28(h), the most popular size fireplace in the U.S., but JUCA has made units as wide as 78 inches! **About 1,300 different "standard" appearances are available in rectangular shape**, to fit in with ANY room decor. This includes a variety of finishes, frame widths, and door appearances and opening modes.



All this at VERY REASONABLE prices and relatively quickly.

**About \$1,400 (plus shipping)** [Details, Options](#)

---

[For a better view of the JUCA F-9A](#)

[Click Here](#) for more info on Fireplaces.

[Or Here](#) for an Index of Many More Subjects.

**E-mail your questions to JUCA at [JUCA@mb-soft.com](mailto:JUCA@mb-soft.com)**

[Click Here](#) to return to the Fireplace Menu

---

## Arch-Top Built-In Fireplaces

Some artistic design applications involve room decors that need an arch-top fireplace to blend in properly. Both Flat-Arch and Full-Arch varieties are available on the JUCA F-9A (**about 700 different Arch-Top appearances available.**) The famous JUCA performance is still there, with the ability to heat the whole house, but perfectly hidden from view.



All this is at VERY REASONABLE prices and relatively quickly.

**About \$1,600 up (plus shipping)** [Details, Options](#)

---

[Click Here](#) for more info on Fireplaces.

[For a better view of this JUCA F-9A Arch-Top](#)

[Or Here](#) for an Index of Many More Subjects.

**E-mail your questions to JUCA at [JUCA@mb-soft.com](mailto:JUCA@mb-soft.com)**

[Click Here](#) to return to the Fireplace Menu

---

## Double-Sided Built-In Fireplaces

Some applications need a through-the-wall fireplace for aesthetics reasons. The JUCA F-9AX model handles these situations. Even for unusual situations when one side needs to be an Arch-Top fireplace and the other side needs to be conventional rectangular, the F-9AX is the unit to get. Competing double-sided fireplaces require identical appearance (usually with black metal areas) on both sides. **The JUCA F-9AX could have Polished brass Traditional Bi-Fold doors on one side in a Great Room (for a regal feeling); and Black Clear-View Twin doors on the Family Room side (for a cozy feeling).** And, as always with a JUCA, the unit has ability to heat the whole house!

All this at VERY REASONABLE prices and relatively quickly.

**About \$1,800 (plus shipping)** [Details, Options](#)

---

[Click Here](#) for more info on Fireplaces.

[Or Here](#) for an Index of Many More Subjects.

**E-mail your questions to JUCA at [JUCA@mb-soft.com](mailto:JUCA@mb-soft.com)**

[Click Here](#) to return to the Fireplace Menu

---

## Custom-Sized Built-In Fireplaces

JUCAs 'standard' custom-built units include many thousands of possible combinations. They're all also available with customer-specified dimensions. Taller, wider, deeper, shallower, shorter, . . . No Problem!

All this at VERY REASONABLE prices and relatively quickly.

---

[Click Here](#) for more info on Fireplaces.

[Or Here](#) for an Index of Many More Subjects.

**E-mail your questions to JUCA at [JUCA@mb-soft.com](mailto:JUCA@mb-soft.com)**

[Click Here](#) to return to the Fireplace Menu

---

## Unique Custom Built-In Fireplaces

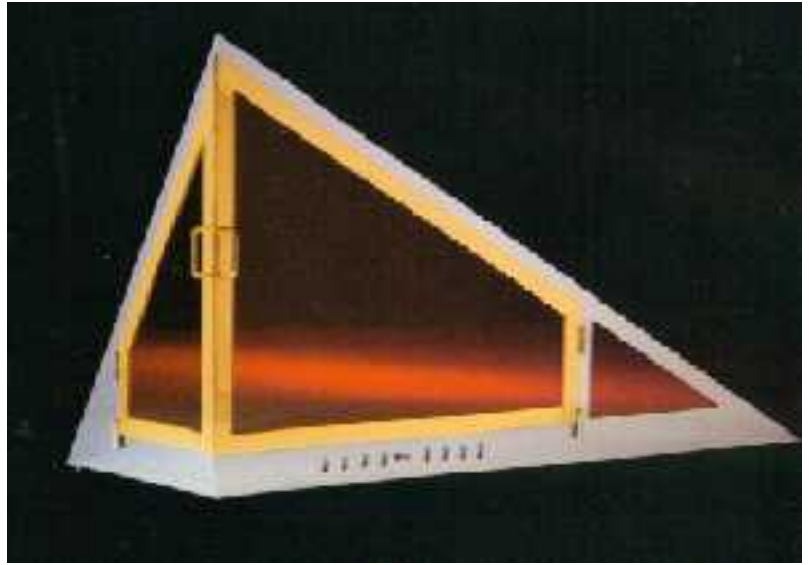
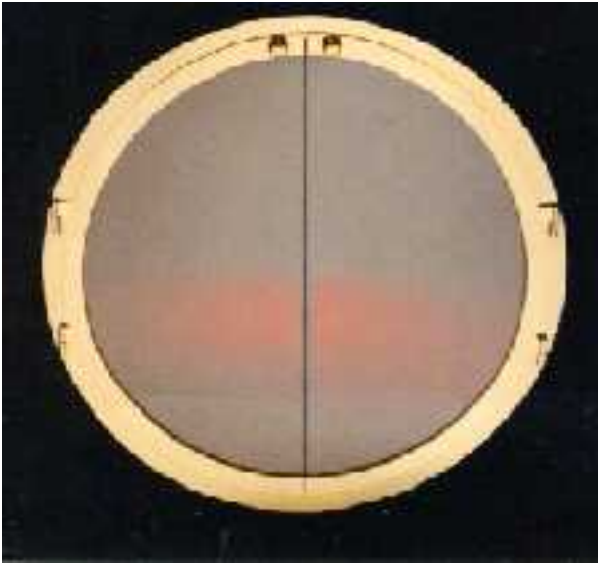

Need a circular-shaped or wedge-shaped door appearance? We build the firebox/heat-exchanger to customer- or builder-specified plans and include appropriate shaped doors (again in many possible finishes.)

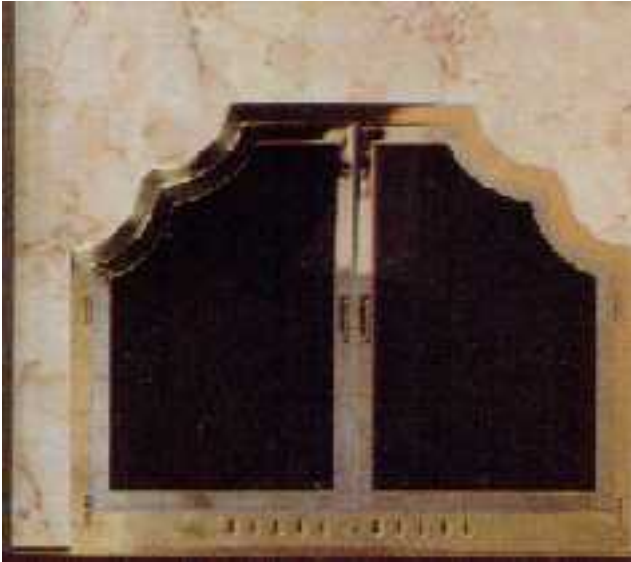

How about a Scalloped arch appearance? Or a Gothic-Arch Fireplace?



Or an Art-Deco motif? Or a Bay Window feel? JUCA does it, still maintaining the whole-house heating capability!

All this at VERY REASONABLE prices and relatively quickly.

---

[Click Here](#) for more info on Fireplaces.

[Or Here](#) for an Index of Many More Subjects.

**E-mail your questions to JUCA at [JUCA@mb-soft.com](mailto:JUCA@mb-soft.com)**

[Click Here](#) to return to the Fireplace Menu

---



# JUCA Free-Standing Fireplace-Stoves

When an application calls for a free-standing fireplace or woodstove, the JUCAs B-3 series should be able to do the job. **Fourteen standard models are available, each in 35 standard colors.** All have at least one large glass viewing area. Many are glass on 3 sides! Nearly all have provision to feed house warm-air ducts through a large outlet on the back, to heat the whole

house. **Four models are GUARANTEED to be able to heat ANY SINGLE-FAMILY HOUSE in the U.S.!**



**About \$1100 - 1,900 (plus shipping)**

[For a better view of the JUCA B-3B](#)

---

## JUCA Free-Standing Fireplace/Woodstoves

- [JUCAs with One Large Glass Door](#)
- [JUCAs with Three Glass Sides](#)
- [Custom-Sized or Unique Free-Standing Fireplace/Woodstoves](#)

---

[Click Here](#) for more info on Stoves.

[Or Here](#) for an Index of Many More Subjects.

**E-mail your questions to JUCA at [JUCA@mb-soft.com](mailto:JUCA@mb-soft.com)**

[Click Here](#) to return to the Main Menu

---

## JUCAs with One Glass Door

The B-3B is JUCA's most popular free-standing unit.

**Conservatively rated at 122,000 Btu/hr output, the B-3B can heat any house completely!**

Reasonably priced, easy to install, **the B-3B is the best value in the industry. The B-3B is GUARANTEED to be able to heat ANY single-family home in the U.S.**

Two smaller varieties are also available.



**About \$1,400 (plus shipping)** [Details,](#)  
[Options](#)

B-3J Model (86,000 Btu/hr) is about \$1200 [Details, Options](#)

K-3 Model (65,000 Btu/hr) is about \$1200 [Details, Options](#)

---

[Click Here](#) for more info on Stoves.

[Or Here](#) for an Index of Many More Subjects.

**E-mail your questions to JUCA at [JUCA@mb-soft.com](mailto:JUCA@mb-soft.com)**

[For a better view of the JUCA B-3B](#)

[Click Here](#) to return to the Main Menu

---

## JUCAs with 3 Glass Sides

The B-3D is the centerpiece of any Great Room or Family Room. Many have been installed in restaurants and stores and in Dome-homes. **Imagine a fireplace over 6 feet tall, with glass virtually surrounding the fire! That's the JUCA B-3D.** And keep in mind that **it can simultaneously be heating the whole house!** Seven other 3-glass-sided models are available in different sizes.

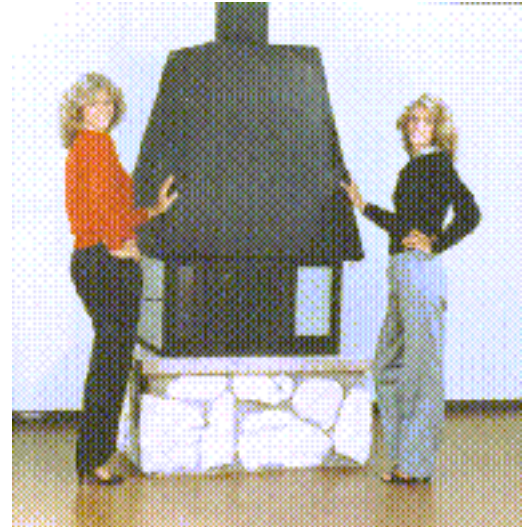

**About \$1,900 (plus shipping)** [Details,](#)  
[Options](#)

B-3N Model (117,000 Btu/hr) is about \$1700 [Details, Options](#)

B-3JN Model (78,000 Btu/hr) is about \$1500 [Details, Options](#)

B-3C Model (180,000 Btu/hr) is about \$1800 [Details, Options](#)

C-3 Model (280,000 Btu/hr) is about \$2300 [Details, Options](#)

D-3 Model (280,000 Btu/hr) is about \$2500 [Details, Options](#)

C-7 Model (90,000 Btu/hr) is about \$1500 [Details, Options](#)

D-7 Model (90,000 Btu/hr) is about \$1700 [Details, Options](#)

---

[Click Here](#) for more info on 3-Glass-sided Stoves.

[Or Here](#) for an Index of Many More Subjects.

**E-mail your questions to JUCA at [JUCA@mb-soft.com](mailto:JUCA@mb-soft.com)**

[For a better view of the JUCA B-3D](#)

[Click Here](#) to return to the Main Menu

## Unique Free-Standing Fireplace-Woodstoves

In case one of the many JUCA 'standard' custom-built fireplace/woodstoves doesn't fit your needs, JUCA can certainly still fulfill your needs. JUCA has made units that included 'bread ovens,' internal cooking provisions, 4-Glass-Sided and 5-Glass-Sided units and many other unique units for specific applications.

In case one of our [35 standard colors](#) doesn't ring your chimes, we have the capability of other possibilities. Shoot, we've been wondering when someone would order a polka-dot unit!

---

[Click Here](#) for more info on Stoves.

[Or Here](#) for more info on 3-Glass-sided Stoves.

[Or Here](#) for an Index of Many More Subjects.

**E-mail your questions to JUCA at [JUCA@mb-soft.com](mailto:JUCA@mb-soft.com)**

[Click Here](#) to return to the Main Menu

---

## JUCA Basement-Garage Furnace Units

Some customers just want the famous JUCA performance but intend to install it in a cellar or garage to feed the house warm-air ducts. Since seeing the fire is unimportant, the steel-doored B-3A Model may be best. (Other than the door, this unit is identical to B-3B.)

Some JUCA B-3As have been installed in warehouses, factories, garages, shops, barns, pig brooders, henhouses, and even outdoors (ducting the heat into a building). Industrial-sized units with five-foot square doors and 2,000,000 Btu/hr ratings have been made, too.

**About \$1,400 (plus shipping)** [Details, Options](#)

---

[Click Here](#) for more info on Stoves, Furnaces.

[Or Here](#) for an Index of Many More Subjects.

**E-mail your questions to JUCA at [JUCA@mb-soft.com](mailto:JUCA@mb-soft.com)**

[Click Here](#) to return to the Main Menu

---

## Other Unique JUCAs for Specific Applications

JUCA loves to create unique custom-designed fireplaces, woodstoves, and wood burning furnaces for specific situations. Many very unusual appearing JUCAs now heat homes. In addition, JUCAs heat greenhouses, warehouses, factories, pig brooders, barns, garages, pole barns, etc.

Considering what JUCA calls 'standard,' these are usually 'cake!'

All this at VERY REASONABLE prices and relatively quickly.

---

[Click Here](#) for more info on Fireplaces.

[Or Here](#) for more info on Stoves.

[Or Here](#) for more info on 3-Glass-sided Stoves.

[Or Here](#) for an Index of Many More Subjects.

**E-mail your special requests to JUCA at [JUCA@mb-soft.com](mailto:JUCA@mb-soft.com)**

[Click Here](#) to return to the Main Menu

---

## JUCA Gas-Burning Units

**All of the normal JUCA units are built very sturdy, in order to be able to burn wood safely.** However, all can be combined with a normal gas-log set to make it a gas-burning unit, too! **In this way, double benefit is gained.** If the user feels industrious, the gas logs are removed and wood is burned; at other times, the gas logs are burned. In both cases, the romance of the fire is present, as well as **the JUCA performance to heat the whole house!** The changeover usually only takes a couple of minutes.



**JUCA's gas-burning units can have manual control, wall control, remote control, or even wall-thermostat control.** This last choice can allow the JUCA unit to act as the automatic central heating source for the house!

The gas-burning capability of a JUCA can be delayed until later. The unit can be used as wood-only for now, and then later gas can be used. As long as the unit is built with the gas-line stub pipe installed, the gas log-set could be installed years later, using wood now! Great flexibility!

The opposite approach can also be used. As long as gas is reasonably priced (AND AVAILABLE), why not burn gas in the fireplace, heating the entire home in the process? If something silly happens again in the Mid-East (and it will), where conventional fuel sources are interrupted, then take the two minutes to remove the log set and start burning wood. **The best of both worlds! See any of the JUCA models listed above. All can be wood-, gas-, or both.**

## Roughly \$1,400 (depending on model)

---

[Click Here](#) for more info on Fireplaces.

[Or Here](#) for more info on Stoves.

[Or Here](#) for more info on 3-Glass-sided Stoves.

[Or Here](#) for an Index of Many More Subjects.

**E-mail your special requests to JUCA at [JUCA@mb-soft.com](mailto:JUCA@mb-soft.com)**

[For a better view of the JUCA Gas-Burning F-9A](#)

[Click Here](#) to return to the Main Menu

---

**E-mail: JUCA at [JUCAmain@mb-soft.com](mailto:JUCAmain@mb-soft.com)**

---

This JUCA Web-Site is at: <http://www.mb-soft.com/juca/index.html>

## Totally Heating a Home with Solar Heat??

We have a sister company in Solar Heating that has just as much technology and expertise as we do! If you have interest in really high performance in a Solar Heating system, you might want to visit the [NorthWarm Solar Heating](#) web site. Most of the NorthWarm systems are based on a patented system.

Even better, the NorthWarm Version 1 System includes a sub-system that is also a way of **entirely Air Conditioning virtually any existing house in the United States nearly for FREE!** In a spirit of hoping to assist California homeowners from enormous summer electric bills (and power outages), this sub-system is being made available, for FREE, at [FREE Home Air Conditioning!](#) We hope that, if enough California homeowners would install the simple system, maybe the power companies and the energy grid could keep up with the Summer high demand for electricity. Since we're giving this information away, you could probably help some of those California homeowners to tremendously reduce their summer electric bills and maybe help avert blackouts out there, so let any of your California friends know about that possibility available to them!



We are also involved with a variety of other projects that are meant to give benefit to society in one way or another. Some are social or intellectual presentations, meant to help find solutions to things in our lives. Others are products or services that also are meant to somehow improve our lives. If you have curiosity about this, you might want to visit a directory page we set up for these [Various projects](#). If you are civic-minded or otherwise motivated, a number of those projects could benefit from the participation of additional people.

---

This site was designed by:

**MB Software**

E-mail: MB at [MBSoft@mb-soft.com](mailto:MBSoft@mb-soft.com)

# NorthWarm Solar Heating Fee Arrangement

We are a very unusual company! You may have noticed that we have chosen to GIVE AWAY the entire technology for our sub-system that is able to provide Free Air-Conditioning for nearly any home or building. In the first two years that that page has been on the Internet, it is our understanding that more than 2,000 people have installed such systems. If each are now saving \$1,000 each summer, that would mean that collectively, they are saving two million dollars each summer, and they will forever!

This is said in preparation for the following:

This is how the \$10K fee would be paid to us:  
TWO separate Cashier's Checks would be made out, each for \$5,000.

There are three possibilities.

- If you regularly attend a Church, Synagogue or Mosque, then one of the \$5,000 Cashier's Checks would be made out TO that institution. It would be important that you include their mailing address! Such a check would show "NorthWarm" or "anonymous" as the source, and not you. (You would also be free to benefit a Charity instead, as indicated below.)

The other \$5,000 Cashier's Check would be made to NorthWarm Solar Heating.

- If you DO NOT regularly attend a Church, Synagogue or Mosque, then one of the \$5,000 Cashier's Checks would be made out TO any recognized Charity Organization which YOU choose. It would be important that you include their mailing address! Such a check would show "NorthWarm AND you" or "Anonymous" as the two sources.

The other \$5,000 Cashier's Check would be made to NorthWarm Solar Heating.

- If this is for a commercial building, any commercial application, from an architect, designer, contractor, or other individual or company which is involved regularly in the industry, we would require a Notarized statement that the usage of the NorthWarm designs and system would only be used for that single application, and a suitable fee would be arranged.

In addition, if such a business intends or expects to use our technology for additional applications, a formal contract for such use would be negotiated, with suitable fees involved.

Regarding these business usages of our technology, the comments above should suggest that we are a very fair company and would never over-charge anyone. The modern world forces us to have to try to protect our interests in these ways. We have invested massive time, effort and expense in designing and developing the NorthWarm technologies, and it is only fair that we receive compensation for usage of them, with the exception of the technologies which we choose to offer for free.

You would mail this to us. We would forward the appropriate Cashier's check to the address you included, so it gets to the proper destination!

We think this explanation is fairly clear, but if there are further questions or comments, our e-mail address is below.

E-mail to: [Solar@mb-soft.com](mailto:Solar@mb-soft.com)

**NorthWarm Solar Heating**  
**(Air-based) Free Air-conditioning System**

# Free Home Air Conditioning and also Winter Pre-Heating

## Excellent Indoor Air Purity, too!

## Greatly Reduce Electric Bills!

### No Freon

Using ONLY locally available materials, it is possible for ANY homeowner to virtually eliminate their electric bills for air conditioning FOREVER! If a million California homeowners would choose to individually save this money, they would collectively reduce the electricity power load on the California power grid by around 5,000 Megawatts! That reduction might even help the electricity suppliers keep up with their demand! A grass-roots solution for a problem that the honchos can't solve!

---

Our NorthWarm Solar Heating Version 1 includes many different ways of assuring that a house stays exactly at the temperature an owner wants it to be at. Traditional attempts at solar space heating have a reputation of being terrible at this. Either there is not enough stored solar heat and the room or house is too cool or a room is unbearably hot while the house or room is collecting solar heat. We feel that both of these conditions are unacceptable. The NorthWarm Version 1 Solar Heating System avoids both situations by including a number of unique features.

This article presents one of those features, actually a sub-system in the greater concept of the NorthWarm system design. It is not central to the operation of the NorthWarm Version 1 System, but it certainly contributes toward the total System performance.

This system is extremely logical and actually very simple. It involves moving the house's air through large tubes (like tunnels) underground. In technical terms, these tubes are "heat exchangers" that use long-proven simple techniques to transfer heat FROM the house air INTO the cool deep soil.

The temperature a few feet down in the ground is remarkably constant throughout the day and year. In Chicago, for example, that deep soil remains approximately 52°F, day and night, summer and winter. In the summer, the hot house air is blown through some underground tubes and that hot house air is cooled by contact with the cool (52°F) walls of the underground tubes. It turns out that it is also de-humidified, too! By the time the air has returned to the house, it is exactly the same as the cooled air that would have come out of a standard central air-conditioner. **Air conditioning is accomplished without running an energy-expensive compressor, virtually eliminating air-conditioning expense.** In the winter, there is even a bonus effect! Make-up air for the house, that might sometimes enter the house at -10°F, would enter the house at around 52°F instead! The heat load of the house can be significantly reduced, minimizing heating bills.

---

Have you ever been in a cave? Remember how cool it was, even if it was 90°F outside? The air inside that cave that you were breathing did not start out in the cave. Some winds had blown air in through some opening somewhere. Hot outside air that had gone into the cave had been cooled by the cool walls down there. That's pretty much what we are doing with this system. You can do this with locally available materials, which should cost on the scale of \$500, in just a day or two, which would mostly be digging up and refilling trenches across your yard! If you hire a backhoe or trencher to do that might be another \$500. Adding in some other expenses, the whole works might be do-able for well under \$2,000. (These estimates depend on house size, climate and other factors, and are suggested as a ball-park estimates.) Simple, easy, fairly inexpensive, perfect!

This technology is being GIVEN away, FREE. Beginning in November, 2000, we have tried to get word out to California homeowners that this option is available to each of them. It is given in the spirit of one human being helping a neighbor.

We are just trying to offer assistance for people who seem to be destined for some great adversity. We have heard that in San Diego, electric rates quadrupled in 2000. People who paid out \$1000 the previous year for a summer of air conditioning are amazed at their recent bills for this and all following summers! And the electric companies have basically confirmed that blackouts will occur for up to ten years, until they have enough new power plants built.

How could caring people NOT offer a solution where none other seems to be available? But the response has been amazing. The bulk of officials and politicians seem to assume that if this had any value, we would certainly be trying to make piles of money on it, so they are polite, but clearly cannot wait until the conversation is over.

Some California homeowners DO seem to be aware of upcoming problems, but they seem to almost universally believe that there really IS no shortage and that this whole fiasco is some ploy on the part of the power companies to be allowed to charge them more. And, they have been conditioned so totally that government and executives can solve all of their problems, that most seem willing to patiently wait until government somehow bails them out of whatever "minor" inconveniences they will face.

These problems ARE very real. Yes, they seem to have been made far worse by greedy businessmen and poor bureaucrats, but the problems exist. It seems certain that those many people are going to be very upset as they realize the severity of the problem, AND that they probably face similar or worse problems for the next nine years!

---

By being able to entirely and continuously cool a house all summer, without a compressor running, many homes could save \$1,000 or more, EVERY summer! This is certainly a great thing for the homeowner, who has to pay the bills, but it can also help many energy-strapped utility companies. If a substantial number of people would install this system, the summer electricity demand could be substantially reduced.

Does it GET any better than this? You SAVE \$1,000 (or more) every year for the rest of your life. You have a cooling system that is unbelievably environmentally friendly. AND you're helping the short-sighted electric companies past their crisis. And all this does not even cost an arm and a leg! (Maybe a toe or two!) There are a lot of variables, like home size, climate, soil type, etc, but a do-it-yourselfer could put the whole system in for under \$1,000 for some houses. (Contractors would charge more, but probably still a manageable cost.)

In the Winter, bringing in ALL of the house's make-up air through such a tube (from an air intake out across the yard) would warm that frigid outdoor air up to about the (52°F) temperature of the deep ground. This doesn't provide ALL the heat for the house, but the total heat load of the house can be significantly reduced, minimizing heating bills. The house is pressurized, too, a coming trend.

---

## Some Technical Stuff

There is a somewhat similar energy source called **Geothermal Energy**. That is actually different from the energy involved in this device. Geothermal energy taps energy that is coming upwards from the hot center of the Earth. Most geothermal energy applications involved rather deep wells or a location near natural hot springs. This system does not need that energy source. Most of the energy involved in this system is actually solar energy, which had arrived months earlier and became stored in the mass of the earth, just a few feet deep.

Each location on Earth has a certain annual energy input from the Sun and a certain energy loss from radiation (into space), conduction and convection. In the long-term, these two must be identical.

The consequence of this is that Equatorial locations, which receive more solar energy during a year, must necessarily have a higher average ground temperature in order to radiate, conduct and convect that greater amount of incoming heat away. Polar regions have colder earth for the same reason. Very near the surface, the ground temperature is greatly affected by day and night and Summer and Winter, but even three feet deep, those effects are fairly minimal.

Here is a map of the US showing average deep soil/well temperatures. Just find your location. The usual indoor design air temperature for air conditioning is 76°F, so if the deep soil in your area is under 76°F, this approach will work! (Even if it was above, house air could be substantially cooled, reducing the need for a central air conditioner to work, STILL saving you a lot of money!

At whatever point any homeowners feel the need to solve their own problems, on a grass roots level, this page should be here. It is, and forever will be, offered as a Public Service.

No incredible breakthrough is presented here. The concepts have been known for many decades. I heard a rumor that even the ancient Romans "air conditioned" a few buildings with this method (but I doubt it!) Our primary contribution is to figure out a system that only costs on the order of one or two thousand dollars and which would probably save the homeowner more than that outlay every single year, forever.

We have a single request. The fact that we are giving away a pretty thorough explanation of this system, does NOT mean that we are also offering unlimited free engineering expertise as well! For unusual houses, or ones in unusual locations, or in especially hot climates, it is sometimes prudent to have individual engineering calculations done, to ensure proper performance. Any local engineer (HVAC, civil, mechanical, chemical, etc) should be able to do the necessary calculations. If they (or you) wish, we can provide all the necessary technical equations (and examples) for such analysis, which anyone that understands algebra should be able to use. Alternatively, we could do such specialized engineering. In both of these cases, which are beyond our offer of this free technology, we think it is only fair to be paid for whatever additional time and effort would be used, so the end of this presentation includes such matters. We feel that most houses in most climates do NOT need this extra engineering effort!

C.

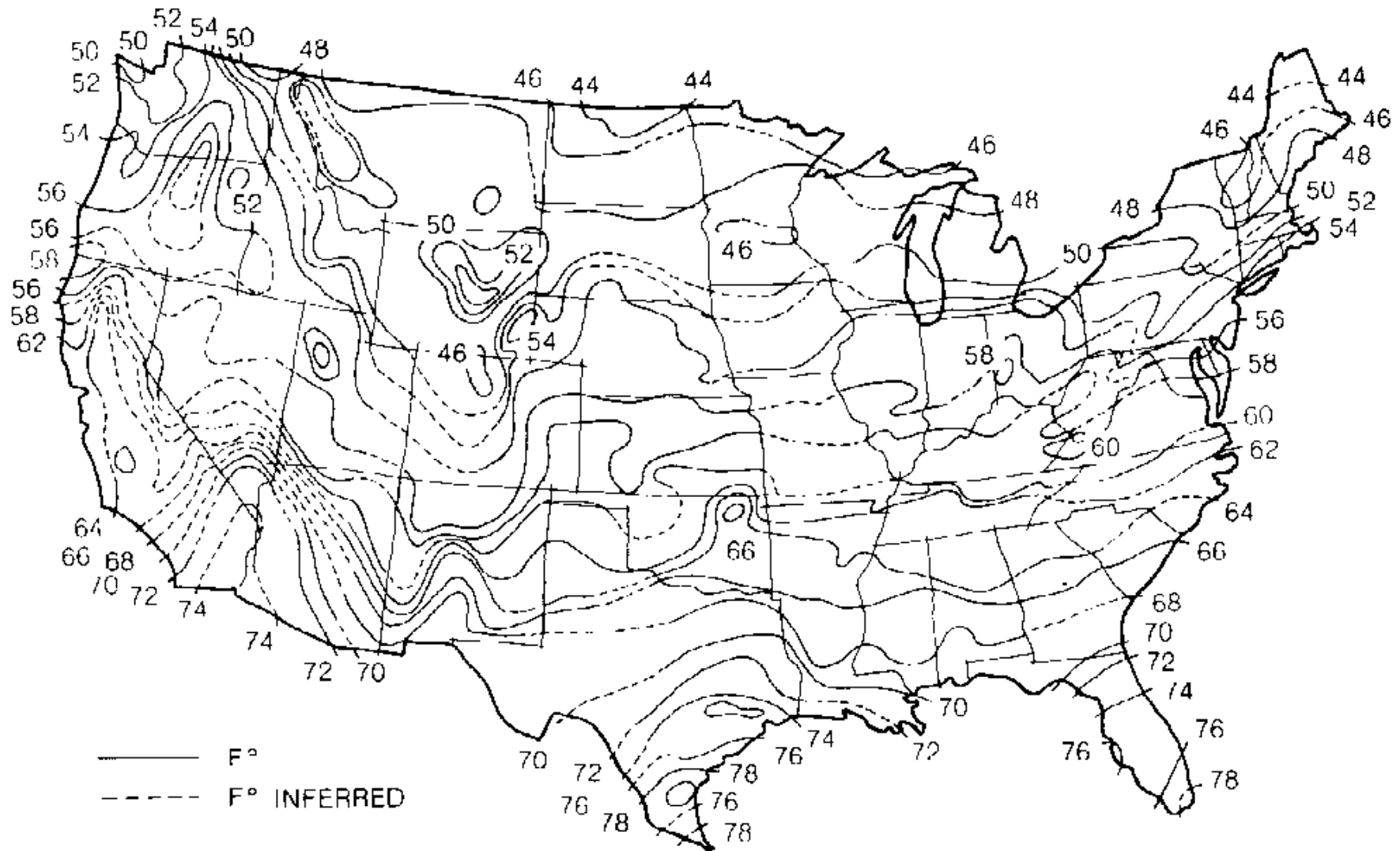

*Ground water temperatures. Map courtesy of National Water Well Association.*

Actually, the temperatures shown here are nearly always very close to the average of the summer and winter average temperatures. (In Chicago, the average December temperature is 28°F and the average June temperature is 72°F, which averages to 50°F, close to what this map shows.)

---

There happens to be another approach that is relatively similar to ours, which is often incorrectly called a geothermal system. It is a variation of a standard heat-pump that uses ground water (usually well water) or occasionally buried copper tubing to capture the same energy we are going for. Such ground-sourced or water-sourced heat pumps have been long proven and sold, and are very successful at providing heating and cooling for many homes. They represent one of several "proofs" that our system works.

Heat-pumps are much more efficient than normal air conditioners, but they still have compressors that use a lot of expensive electricity. Because they use that compressor, they have the capability of sort of "multiplying" the heat/cool from the ground to even provide complete winter heating (for some climates), where our system, without a compressor, does not try to accomplish that. But we don't have to pay for electricity for that compressor, either!

---

As cooling or heat is removed from the deep ground in our system (or in a ground-source heat pump), it is gradually replaced primarily by heat conduction from nearby soil, through the soil. It turns out that many soils are pretty lousy at conducting heat in this way, so this replenishment tends to be fairly slow and nearly always represents the **limiting factor in the long-term operation** of this system. In areas where the soil is saturated with water, some convection can occur, too. Therefore, if the deep soil is moist, this system works tremendously better. Water-source heat pumps nearly totally rely on this convection effect.

Because any substantial volume of earth contains enormous amounts of heat/cool storage but the many soils are so poor at heat conduction, the AREA of the interface (tube wall) between the soil and the tube contents nearly always is the greatest **limiting effect on short-term system performance**. Ground-source heat pumps generally have very small diameter copper tubing, so the circumference and the outside surface area in direct contact with the soil is very limited. This tends to make ground-source heat pumps to often act like they have depleted the energy source very quickly. Fortunately, they have their compressor that just has to work harder, but can still continue to work during fairly severe depletion. And, in any case, energy from nearby soil replenishes the energy source in just a few hours.

Our approach is to use much larger diameter tubing underground, which **greatly increases the contact area between the soil and the tubing surface**. This total "area of contact" is one of the most important characteristics to design for in this system! Again, in more technical terms, heat exchange is proportional to the surface area of the heat exchanger. It determines the amount of heat (or coolness) that can be given to the house air that is flowing through the tubes, in other words, the Btu/hr rating of the system (or short-term performance). Even normal ground-source heat pumps would benefit from such a larger surface contact area, but their compressor allows designers to calculate very minimal systems, to keep their digging (and copper tubing) costs at a minimum.

Further, our approach is to divide the underground air passageway into several "parallel" paths, separated from each other by around six horizontal feet. This configuration takes into account the very slow soil heat conductance and yet allows using a FAR larger mass of soil to participate in this system, which determines the long-term performance of the system.

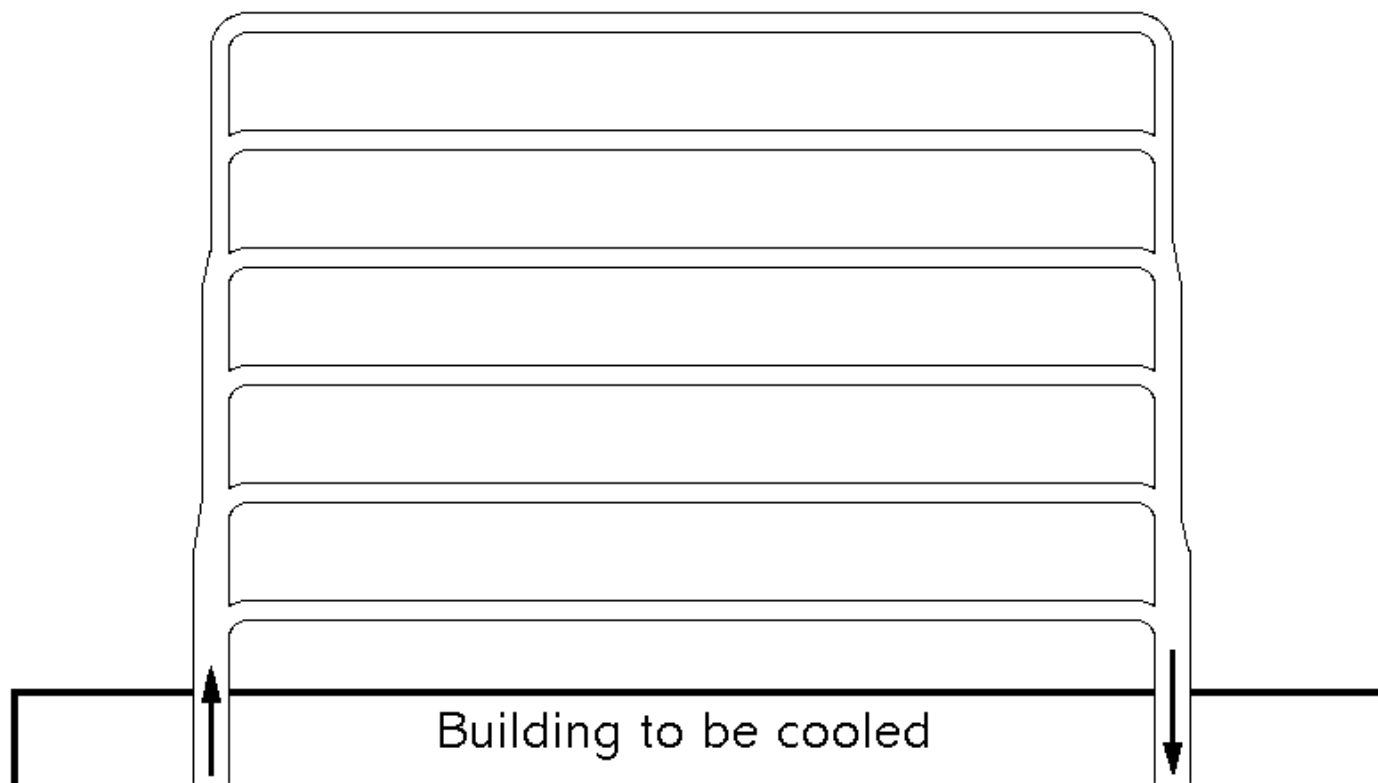

This drawing suggests a very compact arrangement. For example, if a 50 by 50 foot area was involved (about 1/16 acre), nine parallel tubes (six feet apart), totaling around 450 feet of tube length (plus the bigger sections from and to the building) would represent a way of installing around 500 linear feet of heat exchange surfaces in that fairly compact area. Such a configuration would involve well over a million pounds of cool soil all within three feet of a tube. (Simple engineering calculations show that that represents over 10,000,000 Btus of cooling available!)

In case you're still skeptical, the "heat exchanger" arrangement we are describing has a coefficient  $U$  that is around 8 Btu/hr/square foot/ $^{\circ}$  difference. If you look at ONE of our nine tubes, its circumference is around one foot and it is 50 feet long, so its area is around 50 square feet. If the house air begins at 90°F and the deep soil temperature is 53°F, there is 37°F difference. Multiplying these ( $8 * 50 * 37$ ) gives an effective rating of 14,800 Btu/hr. That's ONE of our tubes, and there are nine of them! This suggests that the total system is capable of about 135,000 Btu/hr cooling, around four times as much as the normal house requires! Well, it could (almost) actually do that for a few minutes, but there are a number of factors that would quickly get it down to the 36,000 Btu/hr that we designed our "standard configuration" for.

Many larger houses and hot climates should probably have specific engineering done to determine that that is enough, but a million pounds of cool soil would often be sufficient for many houses and climates.

Basically, we are using modern engineering concepts to maximize the effectiveness of a natural phenomenon!

**There are many variables involved, but many installations should be able to use 4" plastic PVC drain/sewer pipe, available at any local 'home' store. ([Technical Comments](#)). At around \$3.50 per ten-foot length, the 450 feet of pipe mentioned above (45 lengths) would only cost around \$160. A trencher (sort of like a roto-tiller) can be rented for around \$220 per day. The sections are light and easy to handle, and available almost everywhere. Standard PVC Cement glues the sections together. The big pipe may be harder to find but it IS available near you! A do-it-yourselfer could do this amazingly inexpensively and quickly and easily!**



The drawing above certainly does not show the only possible arrangement. But it shows a compact arrangement with the three important considerations.

1. There is a lot of total pipe surface area (which defines the short term performance of the system). In this case, there is over 500 square feet of exterior pipe surface in contact with the soil.
2. Pipes are distributed so that a lot of mass of soil is within about three feet of some tube (which defines the long term performance of the system), (in this case, around 2.1 million pounds) and
3. The AREA of the air path always totals an area comparable to the area of the main house ducts (which allows proper airflow through the whole system). In this example, each 4" tube has around 13 square inches of cross-sectional area, so 9 of them total about 120 square inches, fairly similar to an 8" by 16" house trunk duct of 128 square inches. Note that the end pipes are bigger (15" diameter or about 170 square inches cross-sectional area) , so they at least equaled the total inside area of all the long pipes.

If you do a reasonable job of providing these three considerations, your system is bound to work!

[\(More Technical Comments\).](#)

Virtually all of the heat that replenishes this system (or ground-source or water-source heat pumps, close cousins) originally began as solar energy that heated the surrounding fields, often months before. Virtually no actual "geothermal" heat is involved. However, there is no commonly accepted name for this process and we suspect that it will generally be thought of as geothermal heating/cooling. Oh, well!

In case you are curious, this system was invented and designed by a nuclear physicist! It is based on very well established processes and we refined it with engineering, as a sub-system associated with our Version 1 Solar heated House.

This article is presented separately from the NorthWarm Solar System presentation because this feature could be added to most houses, either while they are being built or to be retrofitted later to existing houses. **This sub-system can be fairly inexpensive and can be configured to completely eliminate ALL conventional summer air conditioning usage (and those huge electric bills!)** In the winter, the same system significantly reduces home heating cost by reducing the necessary heat load. Yet another benefit is that recent Indoor Air Purity concerns can be addressed in a way that is not costly or wasteful. **Finally, you cannot get much more environmentally friendly than this system!**

Now, you probably already see the obvious logic of this system. Some fairly large-scale (expensive) systems have been occasionally installed for at least 30 years, and the relatively similar ground source heat pump system has been marketed for twenty years, so the concept is well proven. We are just presenting a low-cost version of it for residential use.

You are probably curious if the designer of this system uses it! Actually, his house has an unusual environment, and he uses a variation of this system which required much more design engineering but works even better! Here is [a description of it.](#)

**Essentially, this is why basements generally stay cool in the summer and why caves remain at very constant temperatures.** In case you have any doubts, just find a long underground culvert (like under a highway) or aqueduct or cave and stand near the open end of it. If the wind happens to be blowing in your direction, you will feel a rush of very cool air coming out of it. That air had actually entered the other end at the 90°F of the outdoor air and had been cooled in passing through that tunnel. That is essentially exactly what our sub-system does.

This might lead you to believe that no planning or engineering is actually necessary! Well, technically, you would be right! If you chose to bury a mile-long culvert, it would certainly work excellently! However, most people couldn't afford to do that! They would want the shortest, most compact arrangement possible, both to fit under their yard and to minimize the digging expense.

The example described above will work extremely well for most medium-sized homes in moderate climates. So, no additional engineering is necessary for such applications! But, where soil is extremely dry, or the climate is extremely hot, or the house is especially large, prudent design might involved extra engineering. There is even often an alternative here, too! OK! You make 4' deep trenches and place the PVC tubing in the bottom of them. Instead of immediately filling in the entire trenches, for such applications, consider filling in ONE foot deep of fill in the trenches! THEN, get (cheap) 100 foot-long coils of black polyethylene 1/2" water line from the store, and drill LOTS of small holes in it! Make water connections to this set of water pipes, which are now one foot above the much bigger air tubes below. THEN fill in the trenches and re-plant your grass.

Materials List	
45 pieces 4" PVC thinwall sewer (ASTM D-3034)	~\$158
8 pieces 15" PVC sewer MAIN (ASTM D-3034)	~\$240
18 'saddle' tees (ASTM D-3034)	~\$290 optional
2 sewer MAIN caps (ASTM D-3034)	~\$24
PVC cement	~\$4
Rental of DitchWitch #1820 Trencher	~\$220

IF the system should ever seem to lose effectiveness in the future, it would generally be because the soil had gotten too dry down there, and the coolness was not able to flow through the soil to the tube. By briefly running some water through those water lines, you can quickly saturate the soil around the air tubes, TREMENDOUSLY increasing the system's performance (often by over a factor of EIGHT!) This "accessory" to this system is really inexpensive to add, and if your climate or soil dryness or house size is even moderately unusual, it might be a good idea to add this feature, even if it turns out that you never need it.

---

If the system is not properly designed and planned, there are two possible problems. A too-small cooling system (not enough total surface area of soil to tubing or not enough actual total soil involved) might work really well for a while, but then the ground and tube would warm up, and could almost completely stop having a cooling effect, and you would have to wait a day or two to again get any cooling. The other potential problem has to do with safety concerns related to the water that would condense INSIDE on the walls of the cool underground tube, and that will be discussed below.

## Comparison to Conventional Air Conditioning

We are not going to go into the actual operation of a standard air conditioning system, except to say that a compressor is necessary in the cooling process. Any textbook on air conditioning can explain the process. Most residential and commercial applications use electricity to run the compressor. THIS is where the problem is!

Let's say you have a moderate sized house in a moderate climate and you want to have 36,000 Btu/hr of cooling. Again, there are straightforward engineering conversion formulas that indicate that this is equivalent to about 10.5 Kilowatts of actual cooling effect. Our thoughtful government has provided us with a **SEER** (Seasonal Energy Efficiency Ratio) or **COP** (Coefficient of performance) for each air conditioning system sold. Let's say for a moment, that yours happens to have a SEER of 10 (about the same as a COP of 3.0). You would just divide the cooling load (36,000) by the SEER (10) to know how much electricity will actually be used (about 3.6 kW) of electricity. If you knew the COP instead, you would divide the cooling effect (10.5 kW) by the COP (3.0), or again, about 3.6 kW of electricity.

Most actual central air conditioners have a lower SEER than 10. Government studies have established that home central air conditioners average using 1.49 kW of electricity for the compressor and another 0.14 kW for fan motors, for each "ton" (12,000 Btu) of rating. Our example 36,000 Btu/hr system (3 tons) would therefore probably use about 4.9 kW of electricity (which calculates to a SEER of about 7.3).

Still with us? Now say you have a REALLY hot day, and the compressor ran virtually continuously for all 24 hours (not particularly good for the compressor!). You would have used up  $4.9 * 24$  or around 118 kWh of electricity that day. Look at your latest electric bill and it will tell you what each kWh costs you. Recently, electric rates have been going wild in many parts of the country. In an area where such rates are still relatively stable (Chicago), the rate is still only around 10 cents per kWh. One hundred eighteen kWh would therefore cost  $118 * 0.10$  or about \$12. That single very hot day would have cost \$12 in air conditioning. This is for a very moderate sized house and air conditioning system and for very reasonable priced electricity. We have shown you this logic here so you could figure these things out for YOUR system using electricity available to YOU.

You can probably now better understand the very large electric bills you receive during the summer. Twelve dollars for a hot day could easily account for \$200 per month. Far more, for larger homes and for where electricity is more expensive than ten cents per kilowatt-hour.

The system described here **does not involve any compressor!** The only electricity necessary is for a fan or blower to push the house air through the underground tunnels! In many cases, this can be accomplished with a fan or blower that only uses 200 watts (0.2 kW) or less of electricity. In terms of SEER, the effective rating would be  $(36,000/200)$  around 180! **That's nearly TWENTY TIMES as energy efficient as the very BEST heat pump or air conditioning system!**

On that example very hot day described above, let's look at the figures. Instead of continuously using up 4.9 kW of electricity, this system only needs 0.2 kW. In 24 hours, that's 4.8 kWh. At the electricity cost mentioned above, that's \$0.48 of electricity instead of \$12.00! A full month of such heavy cooling would cost around \$10 instead of over \$200!

There are actually even some possibilities of eliminating the cost of running the fan, too, eliminating even that last \$10 of monthly operating expense! However, it is such a minimal remaining expense, it is probably not worth even trying to do that!

This basically states the point of this system (regarding air conditioning). If you have a moderate sized house in a moderate climate and you have moderate electricity costs, you are STILL likely to sometimes save \$200 in a single month! In a whole summer, this "eliminating" of the cost of air conditioning the house or building, might easily save you \$1,000. Basically, whatever your total electric

bills were last summer, inflated for the recent price hikes, THAT'S what you would save! And, that savings would be EVERY year, for the rest of your life! What a deal!

In areas where electricity costs have drastically risen in recent months, they are not likely to ever fall back to where they were. Using the logic presented above, you should be able to figure out approximately how much air conditioning will cost you. Or just check the electric bills from a previous year and multiply by how much the cost of electricity has multiplied. We are guessing that there are many millions of homeowners who are going to find it no longer possible to regularly air-condition their homes, just because of this tremendous increase in the cost of electricity. Well, that's a main reason we are presenting and offering this page! Each homeowner who would install this simple and obvious system, will virtually certainly save more than \$1000 every summer (depending on climate, of course), forever! If a new monthly TOTAL cooling cost becomes only \$10, even if it some day doubles, that's only \$20!

And the coolest (pun intended) part of this is that all of the comfort in the house is PRECISELY identical to that when using conventional air conditioning. The temperature and humidity levels will be identical. Of course, you would not have a noisy condenser unit running outside your house, so if you like that sound, you're outa luck! All this, in a system is about as "natural" as you can get! And bonus \$\$\$ savings in the winter!

If you live in ANY house, and YOU pay the electric bills, you must now see the exquisite logic of this system. It even has a bunch of additional bonus characteristics. For example, there is virtually NO chance of ever being charged for any repairs to the system, because there is virtually nothing that could ever break or fail or leak!

**It seems to us that such homeowners will even be doing good things for society and the environment, as well as pocketing an extra \$1,000+ each year. Consider California and its amazing energy woes, particularly electricity. Even during the winter, their electric companies and power grid have great difficulties in keeping up with electrical demand. Consider if a million California homeowners decide to save \$1,000 each, every summer, with this type of system. They're smiling! LOTS of happy people in California! But consider this! If a million California homeowners are NOT taking 5 kW each from the power grid during the summer, that's a reduction of load on the power grid of FIVE THOUSAND MEGAWATTS! It is unclear if that would "solve" the lack of planning of California's electricity needs, but it would have to help!**

(I know! I know! There are far too many exclamation marks in the previous paragraphs! But several of these concepts are pretty amazing! Huh?!)

## Winter Make-Up Air

All buildings have a certain amount of infiltration, air that somehow leaks into the house. Necessarily, an equal amount of air must also leak out of the house. In any heated building, the infiltration air tends to be low in the building's walls and the exiting air tends to leave high on the walls or through the roof. This is a result of natural physical laws. During air-conditioning, the process is reversed.

Until around 1985, all houses built had significant infiltration (leakage), and many thousands of cubic feet of heated house air would therefore leak out each hour and be wasted. This added considerably to the heating load of the house or building, but it actually naturally assured indoor air purity because any air seldom actually remained in the house more than an hour or two.

After some energy shortages in the late 1970s and early 1980s, houses were built to be extremely tight, because of this very situation. Air infiltration was nearly eliminated. This significantly improved the energy efficiency of the house, but it caused the air in the house to not have any way of ever leaving. Where the smell of a cigar would have left in an hour or two in an older house, it is now trapped for days or even weeks in the new, tight house.

**This situation eventually caused great concerns regarding Indoor Air Purity. (It is amazing that no one saw that coming!) Not because any more pollutants were being created in the house, but because the ones created in the house could never leave.**

By the middle 1990s, Building Codes were starting to add new rules, where motorized house pressurization or similar schemes were required in new construction. In a darkly humorous sense, they are defeating the entire advantage accomplished by making the houses so very tight only a decade earlier! Some States' new (bad) rules require motorized exhausters, which is a truly bad idea because it causes the house to be at negative atmospheric pressure. That could cause fumes from a car in an attached garage to be sucked into the house, or smoke from a fireplace drawn out into the room as air is sucked down the chimney, or paint fumes from a workshop in the basement be pulled upstairs. Others of the new rules, slightly more thought through, require a similar motorized device to forcefully inject fresh outdoor air into the house. In principle, this is a far better idea, since it slightly pressurizes the house. If any leakage would happen associated with a garage, it would be (warmed) house air being forced out into the garage. Regarding a fireplace, warmed house air would be forced up the chimney. Wasteful of heat, but not a source of Indoor Air Pollution.

By the way, this pressurization approach has existed in most large commercial stores for decades. Did you ever notice how air whooshes (outward) past you as you enter the door of such a store? That's actually unnatural, because the "chimney effect" tends to always suck cold outdoor air INWARD near the ground and it leaks out through cracks high in a building. They pressurize such buildings for

several reasons, but that is one of them. They don't want their incoming customers to have to feel an incoming blast of cold outdoor air!

Amazingly enough, some of the new laws realized that a motorized pressurizer couldn't actually push any new (clean) air into the house unless old (stale or polluted) air was able to get out, so they ALSO required PERMANENT openings in the house where this air could leave. Some new windows are built with these permanent openings in the frames! In principle, those windows act like they always remain slightly open! It's sort of hilarious! The older laws mandate super insulation and all that (costing the owner \$\$\$) to make the house more energy efficient. These new laws require expensive motorized blowers and special windows and such which are designed to completely defeat the purpose of the original added expense, only at additional expense! Only in America!

## Our Approach

Given this last arrangement, it figures that most building codes will eventually require such house pressurization for every new home constructed. Hopefully, they will not be as wildly illogical as some present rules that require not only the motorized pressurizer but permanent openings for house air to be able to be pushed out of the house! The effect is of having a well-built energy efficient house, but with a window permanently open! Amazing!

Since some amount of outdoor air must then be brought into the house (by the motorized pressurizer), if the outdoor temperature is below zero, this adds greatly to the heating load for the house, and therefore to the cost of supplying heat for the house (unless you have our NorthWarm Solar Heating System!) In principle, you are bringing in extremely cold outside air and then having to add quite a bit of heat and humidity to it.

**We're finally getting to our (winter) improvement!** Assuming you have a large yard, imagine digging a trench about four feet deep all the way across the yard, and maybe then even zigzagging around the yard. In the bottom of this trench, place a large diameter pipe, and then fill the trench back in. At the one end of this pipe, have it pass through the basement wall and open into the basement or some other low part of the house. At the opposite end, (for primarily heating systems) have it elbow upwards so it sticks up out of the ground. (Make it decorative somehow!) **(For primarily cooling systems, see below, and the descriptions earlier.)**

The motorized pressurizer would be set up to draw its air through this long underground tube. When the air was first drawn into the tube at the outer end, that air might be below zero. But the ground several feet deep is much warmer. In the Chicago area, for example, it always stays around 52°F. As the air was drawn through the long tube, as long as the tube was designed and dimensioned properly, it would pick up heat from the surrounding pipe and soil. By the time the air arrived at the house, it would have been (naturally!) heated from the original 0°F to around 52°F. Only a minor amount of heating would then be necessary to raise it to the 70°F for the house, around 1/4 of that needed otherwise!

## Summer Air Conditioning

**This underground tube concept is REALLY beneficial during the summer!** The deep ground is still around 52°F in Chicago in the summer. Rather than using an electrical air conditioner, which is pretty expensive to operate, why not make BOTH ends of that underground tube come through the basement wall? Then, use the existing air handler or furnace blower to push the house air through this tubing. The hot house air (maybe 80°F or 90°F) that was sent into the tubing would obviously be cooled (and even de-humidified!) while passing through the underground tubing loop and the SAME air would come out the other end of the tube, back into the house at around 52°F. It would quickly and comfortably mix with the existing house air and cool the entire house down, without huge electric bills for operating an air conditioner. (This is again describing the system shown earlier).

Any existing furnace/air conditioning system already has a 'Summer Fan' switch on the wall thermostat. This switch just turns on the blower, without activating the furnace or air-conditioner, and could easily be used to control the airflow through the underground tubes. Alternately, the 'Air Conditioning' switch position on the thermostat could be used. This would then allow the wall thermostat to automatically turn on and off the blower, blowing the house air through the underground tubes as necessary to maintain the desired temperature set on the thermostat! Absolutely automatic! Absolutely identical in usage to traditional air conditioning!

## Summer De-Humidification

It turns out that there are even bonus benefits for summertime use, if the tubes are installed in a certain way. The hot summer house air that is sent into the tubes often has very high relative humidity. Both the heat and the humidity make us uncomfortable in the summer. An air conditioner not only cools air but it removes humidity from it as well. (That's why window air conditioners tend to drip.) In the underground tube, that hot, humid air is cooled down by the cool pipe and soil around it. For complicated physical reasons, the RELATIVE humidity gets higher as the air cools. Soon, some of that humidity can condense out on the walls of the tube. (This occurs at a temperature called the dew-point). If the design and planning of the tube system is good, by the time the air has gotten to the house, it is not only cooler, but it has been de-humidified as well! Both of the functions accomplished by an air conditioner are accomplished in a far more natural way. With FAR less electricity and

<http://mb-soft.com/solar/intake.html> (9 of 14) [10/3/2003 6:01:18 PM]

expense involved!

Interestingly enough, this system actually lets you control a comfort parameter that normal air conditioning does not, the Indoor Relative Humidity! Massive government tests have determined that the ideal summer indoor conditions are 76°F dry-bulb temperature (normal temperature) and 40% Indoor Relative Humidity (See any ASHRAE Handbook). Store bought air conditioners were designed to accomplish approximately the right IRH as a function of the temperature, so you don't actually have any control.

This system actually does (if you wish it!) Much of the foregoing discussion has mentioned air returning to the house at 52°F in our examples. This system can actually be used in that way, but that is usually not the ideal situation. If the air passing through the tube actually gets down to 52°F, then the great majority of its moisture content would condense out on the walls of the underground tubes. That's a desirable goal, but in this case, we're doing TOO good a job! Once that air comes out into the house and becomes warmed to the 76°F room temperature, it will only have around 13% IRH.

Since we would probably rather have the air come out with around 40% IRH (at 76°F), it turns out that it would be better to have the air exit the underground system (to the house) at 60°F. When this air heats up to 76°F, it will have 40% IRH. Going to the other extreme, if we arranged it so the air came out at 68°F, when that air warmed to 76°F, it would have an IRH of around 70% and it would feel muggy, even though the temperature was fine.

So, how would we control the IRH? By controlling how long a time that individual air molecules would be inside the tube system! There are elegant engineering ways of calculating what cfm of blower airflow would provide final airflow temperature, but it is generally easier and more accurate to just measure the (wet-bulb) temperature as the air re-enters the house. If it is 60°F, then you will get 40% IRH. If it is higher or lower, just adjust the air flow cfm through the tube system so that the air returns at that saturation temperature. For locations where the ground temperature is higher than that 60°F, the house humidity level may be higher than desired, and, under some circumstances, a de-humidifier may be necessary in the house.

It might seem that changing the air flow through the tubes, and therefore the temperature that the air returns to the house, would affect the overall system Btu/hr capability. In general, it doesn't. A LOT of air coming back at 60°F has as much cooling effect as a lesser quantity of 52°F air. The actual coolness being delivered is proportional to the PRODUCT of cfm and temperature differential. So, with 80°F air entering the system, either 1000 cfm at 52°F or 1400 cfm at 60°F, would provide the same Btu/hr of cooling. Only the IRH would be different.

---

In case you are an environmentalist, please note that there is no CFC Freon refrigerants that could affect the ozone layer or otherwise pollute anything. **This system represents a version of an elegantly natural, low-tech approach that does the job far better than the high-tech air conditioner does.**

Depending on the climate of the house, it might be desirable to arrange this system for primarily or exclusively A/C operation, with little or no concern about winter benefits. In such a situation, there can be additional benefits from looping the tube around so that both ends of it come through the basement walls. Ducts (with dampers) would connect the existing furnace (or air handler) ducts to this path. At whatever point the wall thermostat would call for cooling, that existing blower would turn on and appropriate dampers would move so house air is blown through the underground tubes. This recirculating method has certain advantages, like better control of house humidity, better usage of the available cooling effects (higher net efficiency), and air filtration advantages. A pure recirculating system would have the potential of the super tight house Indoor Air Purity concerns. Probably the ideal solution for a primarily cooling installation would be a primarily recirculating system with a small intake provision for bringing in a little make-up air (for pressurizing the house).

---

If you already have a full basement, you already have a crude version of this system! You have certainly noticed that such a basement always stays cool in summer (but that it is also often rather humid). The basement floor is actually acting like the walls of the underground tubes we have been describing. House air that flows along that basement floor becomes cool from the coolness of the floor. Just like in the underground tube arrangement, that air also gives up some of its moisture in the process of being cooled, which tends to make basement floors slightly damp and makes the basement sometimes feel humid.

With the underground tubing, the effect of all this is much more prominent, and the moisture that condenses out of the air is collected and removed, very much like a normal air conditioner does.

The basement floor has plenty of "interface area" so short-term performance can be great. If you live in a climate where air conditioning is only needed for a few hours at a time, you could probably get most of the benefits of air-conditioning from just recirculating your upstairs house air through the basement, using the existing house blower/air handler.

If there is NOT thermal insulation under the basement floor, then fairly simple engineering shows the short-term benefit you can get from this cool basement floor. Say the house is 25 feet by 40 feet, so the basement floor is 1,000 square feet. If the ground underneath it is at 52°F and the house air is at 80°F, then the "cooling effect" is seen to be  $(1,000) * 8 * (80-52) = 224,000$  Btu/hr! That would be PLENTY to cool your house, and that's why recirculating the upstairs air through the basement can quickly cool the house. Just sending that air through the basement does not actually send all of

that air right along the basement floor, so the "basement effect" winds up to be far less than 224,000 Btu/hr, but can definitely be the 36,000 Btu/hr of cooling that your house actually needs. (Keep in mind that this approach does NOT remove moisture from the house air, so there is no de-humidifying effect and a separate de-humidifier would be needed).

However, if your air conditioning needs are for more than a few hours at a time, this approach will soon lose its effect. Gradually, the soil underneath the basement floor will warm up. Since it is a finite volume of soil (basically the size of the house), once it has all warmed up, the cooling effect would be greatly reduced, until an extended period of non-use occurred so the soil could again cool back down. Anyone who has tried to cool their house in this way has noticed the reduction in cooling effect over time.

$$T - T_o = \frac{Q'}{2\pi\kappa} \int_X^{\infty} \frac{e^{-\beta^2}}{B} d\beta$$

Any engineer can solve this Integral Kelvin equation to determine this effect. (By the way, this is the scariest of the equations involved! And the technical information package described below includes a table of solutions for this equation for all practical situations.) If a common, fairly dry, Midwestern soil is under the house, and if this example house needed continuous cooling of 36,000 Btu/hr, the solution shows that the soil a foot below the basement floor would have risen in temperature by 24°F after just one week! By then, the floor would have been at 76°F and there would have been no cooling effect at all. Even after just a couple days, the cooling ability would have dropped to about half, because the soil down there would have heated up to around 64°F. With a more moist common Midwest soil down there, the effect is only half as bad, with a decent cooling effect existing beyond a full week.

A simplistic engineering approach could also be used to roughly estimate long-term performance. In VERY approximate terms, the soil temperature one foot down would probably reflect the overall effect on TWO feet deep of soil down there. One thousand square feet, two feet deep is 2,000 cubic feet or about 200,000 pounds of soil. The specific heat of dry soil is around 0.3, so the heat capacity of this mass of soil is around 0.3 \* 200,000 or 60,000 Btu/°F. If 60,000 Btus are put into that ground, it would rise an average of 1°F. Since we are talking about putting 36,000 Btu/hr down into that soil, that's 864,000 Btu/day. This implies that the soil would rise in temperature by around 14°F in a 24 hour period of operation, relatively in line with the solution of the more precise Integral Kelvin equation.

These comments are included to emphasize the need for calculating the long-term performance. Even though a basement floor starts out with incredible short-term cooling capability, in just a few days of use, that cooling effect gets depleted. Larger volumes of soil need to be involved when extended periods of cooling as necessary. The network of underground tubes accomplishes this.

---

OK! So, YOU don't live near Chicago. YOU live in a much hotter climate. Could it still work? Yup! You probably already found your location on that map we included above. In cities like Los Angeles (68°F) and San Francisco (64°F), the deep ground temperature is not 52°F but it is higher. The configuration has to be designed with more underground tubing, but it will still work like a charm! Even a place like Death Valley amazingly only has a deep ground temperature of around 70°F! New York City (54°F), Seattle (52°F), Washington DC (56°F), Denver (52°F), and such a system would cool excellently. About the only two areas where it is at all complicated is around Miami, where the deep ground is around 77°F and very southern Texas, where it is about the same. (Farther north in Florida, like Orlando (74°F) is already simpler and fine!) By the time we get as far north as Atlanta (64°F), everything is easy! Additional design planning is involved regarding consistently hot areas like Miami, because a lot more underground tubing is necessary, but anywhere else in the USA is a piece of cake!

---

OK! You already know that you need to pay attention to the three main aspects of it. For a reasonably average sized house, we have mentioned that the tube pattern shown above will be near enough soil for long-term performance and will have enough surface area for short-term performance. We have a couple additional comments regarding the tube diameters.

We had mentioned using nine parallel 4" tubes for the total of about 120 square inches of area for the airflow. We have discovered that some people have read this page and decided to "improve" on it by making one very long air path of a single 4" pipe 500 or more feet long. Well, that WOULD actually work, but it would have a disadvantage. In the same way that firemen use a 3" diameter hose instead of a 1/2" garden hose (to carry far more water for putting out the fire), a single 4" air path would greatly limit the amount of air that could be cooled. True, it would be cooled really well, but there would be very little air flow through the tube, the effect being a lot like the garden hose trying to supply enough water to put out a big fire. The larger area is very important!

Now, if you have 6" pipe available to you locally, roughly five parallel tubes would be necessary to match the air flow through the nine 4" pipes. In that case, the air flow would be fine, but the total tube surface area would be slightly less (making the short-term system performance a little less, and the amount of soil within three feet of a tube would only be 5/9 as much, substantially reducing the long-term performance. So, before you go changing any major aspect of this system, make sure you understand all the consequences of that change!

Four inch PVC drain pipe should be available everywhere. Six inch is nearly as widely available.

We haven't said too much about the larger diameter tubes in that drawing. There are a number of approaches you could use. Some people might fabricate a rectangular duct of some sort, and have the branch runs come off of it. A second possibility is to just have all nine separate 4" PVC pipes elbow and come through the basement walls, with an "airbox" then fabricated there to connect them all in parallel. Another possibility involves using PVC larger diameter pipe there, too. There is a 15" diameter PVC pipe that is normally used for sewer mains, and it would work excellently here. Either the full 15" diameter could be used for the whole length or it could step down to 12", then 10", then 8", then 6" and finally 4". Either approach is fine. The second choice is technically slightly better for air flow, but the first choice would likely be simpler to install and probably cheaper.

As to joining the 4" pipe runs to the 15" main, there are again two choices. First, there are solvent weld fittings (a lot like standard a 4" PVC Tee, but for this specific combination. Those fittings are around \$100 each, and you would need 18 of them for the pattern shown above, so that's too expensive. The second choice is called a "Saddle Tee". It is a fitting that is PVC solvent welded onto the 15" pipe to add the Tee wherever you want it. A lot simpler, and those fittings are in the \$16 price range. If you're creative, you can probably think of less expensive ways of joining the 15" and the 4" pipes.

These items, the 15" PVC Sewer Main pipe and the Saddle Tees (and even the expensive Tees) are items you may have trouble finding locally. If that is the case, we have located suppliers, so we could provide them to you. Check around locally, first!

---

As to specifics for a particular application, well, that's where we might earn our keep. We would have liked to include those specifics in this page, but there are quite a few variables that can affect the performance of this system. (You probably haven't been too thrilled with the engineering info we've used here!) For example, two identical houses, a mile apart, could need extremely different systems, if one was over very dry sand and the other was in a marshy area. In this case, the necessary area of pipe is different by a factor of four! Also, the size and shape of a yard, the climate, the house size, and the soil type all can affect the best choice of tubing diameter, so we cannot even generalize there! Sorry! You need to either do the math yourself or have us do it (or provide the equations) or over-estimate how much pipe you will need.

If you want our help, we have two possible fees that could be charged. The first is a flat **fee of \$250**, for a collection of equations, formulas, charts, (pre-calculated solutions of that Integral Kelvin equation!), and a lot of additional guidance regarding designing of the intake tube sizes, materials, lengths, and a bunch of general suggestions. If you happen to be or to know a thermodynamics engineer, he could probably do all this for you and you wouldn't have to pay us anything! The second is a flat **fee of \$500** (for a single-family, fairly normal residential house) which would involve US doing the design calculation work (of those equations and formulas) necessary. For this, we would need you to supply us with a variety of information, so we can take into consideration the size of the house, the climate it is in, its estimated heating/cooling load, the number of members of the family, the size and shape of the yard available, the type of soil, etc., to determine the diameters, configurations, patterns, depths, etc. of the components of this system. Many variables are sometimes involved, including mountains, lakes, forests, and other local conditions.

For many climates, the necessary yard area that would have to be dug up for this network of tubes might only be 50 feet square! If you followed our "basement" discussion, this area of tubes would involve a volume of soil of about 56 feet square (about 3,000 square feet) and about double the vertical depth of soil (because the basement "hole" is not there). In other words, even this moderate area of yard could be used to supply around SIX TIMES the long-term cooling effect of the basement floor example. (3,000 \* 4 or 12,000 cubic feet of soil instead of 2,000). In hot climates, a larger area of yard would obviously be necessary.

If your application is anything other than a fairly standard single-family house with a large yard, our (second) fee will likely be higher. (The first fee would be the same, because the same basic equations and logic would still apply.) Unusual situations regarding house or yard, and ANY commercial or industrial application would be billed on a time-basis. The above-mentioned (second) fee is specified because we have a good idea of how much time would be involved for us to do the calculations for a normal house with a large yard.

In case you are concerned that we are talking about a (moderate) amount of money here, in a technology that is being given away for free, we hope the situation is obvious. We don't want to LOSE money as a result of this offer. It wouldn't seem fair for people to ask for free engineering as well, because it is fairly time consuming to do all of the necessary calculations and engineering. We encourage you to find a local civil engineer who could equally do the math. We are making this engineering offer because we have already done a LOT of research and collected all the useful stuff in that collection of information. We are hoping that a \$250 fee would not cause a hardship on anyone for that information.

---

## Doing This Without Our Help

## Water Condensation, Fungus, Etc.

If you choose to do this without our guidance, PLEASE be aware that there is a tendency to accumulate puddles of moisture down there, and if you don't plan it right, and that could represent a breeding-grounds for moss, fungi and other things. Some of the things that could grow there can be bad. Remember that Legionnaire's Disease was caused by condensation accumulations from air conditioning equipment and that it was a bad situation. There are similarities to be careful about.

You know how house gutters slightly slope, so they drain? Just an inch or two in a ten-foot length? That should be done for these underground tubes. NO corrugated tubing should be used, because it would trap such condensed moisture in lots of little puddles. The tubing should have a smooth interior. Since it is relatively hard to confirm that a minimal slope has no low spots (far harder than for gutters), it is generally a good idea to provide a somewhat greater slope than normally used in house gutters. The slope should probably go downhill along the direction of the airflow, so the moving air would tend to push the water along. This could terminate in a central condensate collection point in the tube system, or it could continue all the way back into the house, where the water would be collected and then sent down a sewer drain. These considerations would eliminate any danger of a puddling or bacteria problem in the tube system.

**NOTE: Before you go digging, make absolutely sure that no easements are across the property. You DEFINITELY do not want to dig into high voltage electrical cables or gas mains or water mains!**

---

From an engineering point of view, remember that the three main considerations are (i) the heat transfer between the soil and the air passing through the tubing, (ii) the total mass of soil participating in this system, and (iii) the total airflow path area inside the tube system. It often works out best (depending on soil type and moisture content) that several parallel smaller tubes be used rather than one large one, because of these considerations. Just think about how a septic field is designed to see why, or try the engineering calculations for different configurations. You will quickly see that you can substantially increase tube-soil surface area and the total mass of participating soil by running parallel tubes six feet apart. The example we discussed earlier represents a very practical system for many mid-sized houses. (This is the sort of additional guidance and insight we include in the engineering info package).

But, let's say you don't get our help and you happen to not bury enough pipe. Well, even in that case, you come out fine, because the system would do much of the air conditioning (depending on how well you planned the piping) and will greatly reduce your air conditioning bills anyway. So, even if you somewhat mess up by not doing any preliminary engineering, you still win!

---

This system is a part of the NorthWarm Solar Version 1 System. It may separately be used for either existing homes or buildings or for new construction.

---

This is one of two closely related "gifts" we are presenting to the American people. This one is for existing houses, while the other one is an approach for new construction. It is at: [Free Air Conditioning](#).

---

Depending on the local cost for usage of a backhoe, or if you happen to love to shovel(!?), **the installed cost of this system may be less than a conventional central air conditioning system.** Depending on the climate and house size, the necessary pipes could cost around \$500. Depending on how much a backhoe or trencher costs in your area, that might also be around \$500. This suggests that some installations could realistically be put in for well under \$2,000. If you can put in LOTS of narrower tubes, a Ditch Witch Model 1820 trencher can make 4 foot deep trenches for around \$220 rental per day. And you essentially eliminate ALL those huge summer air conditioning electric bills! And you get significant energy savings in winter, too! Forever!

In nearly all cases, the existing furnace blower or air handler, and wall thermostat could be used, so there's virtually nothing necessary except for the tubing and the trenching. And there's nothing bizarre about operating the system, either, since the normal wall thermostat would be used exactly as before.

**We believe this to be a feature that nearly all houses could benefit from.** Considering recent large price hikes for electricity and natural gas, we felt it appropriate to present it as a separate system, where it has always been considered a relatively minor part of the full NorthWarm Solar Heating System.

Even if you have already paid for an existing central air conditioner, this intake arrangement could quickly pay for itself in combined heating and cooling savings. Just do the cost calculations suggested above to find out what YOU might save. And, even if you happen to be in a climate, like Miami, where you might feel it too involved and costly to bury all the necessary piping for an entire



system, any size system that you would install would greatly reduce your air conditioning electricity costs.

Since we're basically telling you how to generally do this, for free, we feel it's fair to ask a single favor in return. If you happen to live in or near California, and you install this system, please call ANY local newspaper, radio or TV reporter to look at what you did. We don't really care if we get any credit in the matter, but it's important to get the word out to all California homeowners that they each have a way to greatly reduce their summer electric bills. And, if enough of them actually do that, collectively we might help avert a big summer problem of blackouts out there. In the process of this, you might even get yourself on TV, if that's important to you! It might seem surprising, but WE don't want any publicity from this effort at trying to help California deal with a big problem. We just believe that we have a grass-roots solution for it, and that people should help one another.

---

In addition, this system represents an obvious solution to the recent flurry of legislation that is trying to deal with Indoor Air Quality issues. Bringing additional air in through our (winter) warming tube to pressurize the house would only have about 1/4 (depending on climate) the winter heating load increase of currently favored approaches (that just directly bring in outside air). This could even allow the legislators go totally over the top and to insist on drilling one-inch diameter holes in the walls of the house, without spectacularly increasing heating costs! That, and a continuous source of pressurizing (52°F) air from our tube, would certainly purge stale and polluted house air! (But we hope they won't do that!)

---

E-mail to: [Intake@mb-soft.com](mailto:Intake@mb-soft.com)

---

The NorthWarm Solar heating systems:

- For NEW houses, where maximum performance is desired, so that an ENTIRE large house can be TOTALLY heated, in most climates, with ONLY solar energy! [Solar1](#)

Performance and storage will be extremely great. The VERY large collector area and storage space make it certain that NO back-up heat will EVER be necessary for heating the house.

- For existing houses, where room for a two-car-garage-sized building is available nearby in the yard. [Solar2](#)

Performance and storage will be great, but the necessarily smaller collector area and storage space make it possible that back-up heat will sometimes be necessary for heating the house.

- For existing houses, in very rural areas, where an array of tracking collectors and a high-temperature boiler system would be of advantage. [Solar3](#)

This liquid-based version has potentially higher installation costs than either of the air-based systems above. It would certainly involve much more maintenance time and cost. It also has all the advantages and disadvantages of a water-based system.

- For existing or new houses. This system is quite different from all of the above. [Solar4](#)

It has very good performance but has intrinsically less performance ability than any of the other three NorthWarm versions. It is a low-tech approach to solar heating.

---

E-mail to: [Solar@mb-soft.com](mailto:Solar@mb-soft.com)

[NorthWarm Solar Heating](#)

# NorthWarm Solar Heating System System Information

The NorthWarm Solar Heating System is a very sophisticated system. Other attempts at solar heating tend to be simplistic in concept, with little effort to accomplish even, comfortable heating. Every aspect of the NorthWarm Solar Heating System has been optimized for maximum performance.

- A **VERY LARGE** collector area is used. Where a common solar heating system often includes about 3 panels each no larger than four feet by eight feet (less than 96 square feet), the NorthWarm Demonstration house was designed with **864 square feet** of collection area, **NINE TIMES AS MUCH!**

The NorthWarm Solar Heating System has all this collector area as a large glass, fairly conventional wall. This wall is sloped back at a specific angle depending on the latitude of the house.

The NorthWarm Demonstration house was designed with one very large glass wall, such that a huge Great Room (40 feet by 20 feet by over 20 feet high) would be the focus of the house. This one large area is not actually necessary. With the Demonstration House, our intent was to prove a point, that a rather large house (over 3,600 square feet of living area) in one of the cloudiest, snowiest, coldest, nastiest climates (near South Bend, Indiana) could be entirely heated by solar heating. In that direction, we thought it would emphasize the point by having a Great Room that was so large that a two-bedroom ranch-style home could nearly fit inside that one room! In a more practical home, that area might be broken up into two or three rooms. The glass wall surfaces would still need to exist, but they could be set back (a la condo style construction) to break up that large exterior surface.

- Associated with such a large collector area, several other considerations are parts of the system. One is a **VERY LARGE HEAT STORAGE** provision. Some common solar heating systems have no storage provision at all, and the ones that do generally can only store a few hundred thousand Btu. The storage designed for the NorthWarm Demonstration house has a design capacity of over 7.5 MILLION Btu! That is enough to keep the entire house toasty warm for a couple weeks even if the Sun is never seen! The amount of storage would be individually engineered for each house, and it would depend on many variables.
- Since the system has such tremendous heat capture capability, it is necessary to provide for protection against over-heating. The NorthWarm System has three main separate and independent (automatic) provisions to avoid overheating. If you desire the house to be at 70°F, it should be able to stay at 70°F, even on a hot summer day. Or even in the dead of

winter.

- Everything is designed to be entirely automatic. A normal wall thermostat (or zoned thermostats in different parts of the house) would control the distribution of heat to the house. Automatic systems control the mechanism for heat storage and those for the defense against over-heating. Exotic (expensive, and subject to breakdown) control computers are not necessary (but could be employed).

(The remainder of this text is normally only used related to the Computer Simulation results printouts).

## NorthWarm Solar Energy Collection

This column shows the amount of heat collected on a particular day, in thousands of Btus. You have probably noticed that there are many days where the Solar Gain is ZERO! (Not a misprint!) If the STORAGE is entirely FULL, the NorthWarm Solar System's automatic overheat-avoidance systems automatically take over, to eliminate gaining too much heat (see above explanations).

Rather than overheating the storage or the house, the System just chooses not to collect the heat in the first place!

If the day is a mild day, where little or no heat is needed, the same heat avoidance systems go into effect. If no heat is needed, none is collected. If a limited amount of heat is needed, just that amount is collected!

Of course, there is one other possibility for why there might be a zero in the GAIN column. If the sky were completely overcast, no solar heat would be available for collection.

You might have noticed that the system is **capable of collecting around 2 Million Btu of heat in a single day!** It is extremely rare that that would ever actually be necessary. It would involve many consecutive cloudy days (that partially deplete the storage) followed by a completely clear one. It's much more common for the System to collect the necessary amount early in the day and then for it to automatically invoke its anti-overheating systems, to maintain a constant house

temperature.

## NorthWarm House Heat Loss Load

Our calculations of the heat load (in thousands of Btu) for the day, are based on the standard 'R' factor analysis for fairly standard construction materials. During the hours of daylight, our computer simulations have assumed that the outdoor temperature was constant at the HIGH temperature value from the Weather Bureau records. During the hours of darkness, we have assumed that the temperature was constant at the LOW temperature value from those records. Since Winter days have more hours of darkness than daylight, this causes the simulated heating load to be generally slightly more than was probably actually the case on those days. This implies that the NorthWarm solar heating systems should work even slightly better than these simulations suggest.

On mild days, where the High temperature was above 70°F, it would have been possible to let the house heat up from that, to reduce the necessary heat for the following night. The simulations do not include such a choice. We felt it more desirable to maintain a constant 70°F inside the house day-and-night and so our simulations reflect that our system intentionally chooses to NOT collect that extra heat.

Most of the house is constructed with fairly standard materials and construction. The exterior wall opposite the glass wall is an eight-inch thick wall, with fairly common double two-by-four construction, for best 'R' value. The roof and sidewalls are built to modern standards, but no exotic insulations are necessary.

The large glass wall is a separate matter. While it is collecting solar energy, it acts as an insulated window, with two layers of glass separated by an air space. The air space is much larger than the fraction of an inch of a normal insulated double-pane window. The two panes of glass are several inches apart!

During any circumstances when solar energy is not being collected (at night, when the storage is

full, or when there is no Sun), an automatic system blows Styrofoam peanuts into that space. This tremendously increases the 'R' factor of the window wall, from about the 2 of a double-pane insulated window up to above 15! Whenever the Sun rises, or comes out from behind clouds, or if the storage needs extra heat, the peanuts are automatically blown back into their storage reservoir. There are actually several sub-systems involved in that whole mechanism.

By the way, this system also represents one of the three systems that defend against over-heating the house. If a logic circuit would sense that the storage was full, the house thermostat was satisfied and there was bright sun beaming down, this heat-defense mechanism would automatically fill (insulate) the window wall to reduce the heat gain.

While we're on that subject, a second over-heating defense involves a set of automatic roller shades just inside the window wall. We think that optimally, the outward facing surface of those roller shades should be black, but research will be necessary on that. The PRIMARY reason for the existence of the roller shades is for the situation when the house wall thermostat is satisfied but the storage is calling for extra heat to be collected. The roller shades would automatically roll down during that circumstance. Heat to the Great Room would be blocked (to keep from overheating it), but heat would still be collected by the NorthWarm system and sent directly to the storage. Since this mechanism would be present for this contingency, it is also present for additional defense against excessive heat when none is needed by the house or storage. (Hence the current uncertainty about the color of the outer surface of the roller shade!)

The NorthWarm Solar Heating System also includes an even more effective defense against over-heating. Between these three primary heat-defense systems, and a variety of secondary systems, the NorthWarm System is easily able to maintain whatever house temperature the resident chooses!

## **NorthWarm Heat Storage Provision**

A very extensive and unique heat storage provision is installed beneath the (standard) concrete basement floor. In the NorthWarm Demonstration house, it was designed to generally hold about 7.5 million Btu of heat, FAR more than any normal solar heating system. It does NOT involve any

exotic or expensive storage media, and only involves common, inexpensive materials. Again, the NorthWarm heat storage method is unique in solar heating approaches.

That amount of storage is enough to entirely heat the whole house for more than two weeks in zero outdoor temperatures, with no sun at all! We have even planned ahead and designed the storage to only be able to give up its heat at a rate a few times more than necessary for heating the house. Even if an exterior door is left open for an entire day during the dead of winter, the storage will not completely deplete itself.

There are no chemicals to ever become depleted and no exotic pumps or mechanisms that could some day break down. The storage, as well as the entire NorthWarm Solar Heating system is incredibly environmentally friendly! The design of the storage also follows the general line of the rest of the logic of the NorthWarm Solar Heating System in being as simple as possible. Sometimes, simplicity can be very elegant.

The way the NorthWarm storage is designed, the possibility of zoning the house is possible. Separate wall thermostats in various rooms of the house could maintain different temperatures in those rooms.

By the way, our design criteria included the very conservative approach of not allowing the storage to ever get above 120°F. The 7.5 million Btu of heat storage is at that temperature! All of the structures and materials of our system and storage could withstand MUCH higher temperatures, and so the ACTUAL storage capacity could be MUCH higher! We limited it to a 120°F temperature for a variety of reasons. Again, our primary intent and goal was a CONSTANT, COMFORTABLE and RELIABLE heat, and we have attempted to consider all things that might affect that. If some truly unforeseen change in our climate should occur, where the house's heating needs become 20% higher (like if the entire Earth should drop in temperature by 20°F!), it would be simple, quick and easy to change the storage temperature to be allowed to go up to 130°F. Just that small change would increase the heat storage by around 20%! Planning ahead!

## **NorthWarm Backup Heat Necessary**

With the NorthWarm Solar Heating System, this subject is rather meaningless. The NorthWarm System is intended and designed to entirely and always, reliably heat the whole house, with immense extra collection and storage capabilities for unexpected contingencies. We are convinced that a backup heating system is not necessary. As you can see from the simulations, the Demonstration house we designed for South Bend, Indiana, NEVER ONCE needed backup heat during the 40 years of simulations.

Better than that, the STORAGE was rarely below half-filled during those 40 entire winters! It still could have gone many more sunless days in January or February! And this is for a huge house with around 3,600 square feet of living space! And this is in a climate that is one of the four cloudiest in the United States, and which has truly nasty cold winters with enormous snows. (By the way, snow on the ground actually IMPROVES the performance of our system by as much as 6%. The white snow reflects some extra solar energy to our collector areas!)

As a result of REALLY thorough engineering and countless computer simulations, we are TOTALLY certain that a NorthWarm (Version I) Solar Heated house, ANYWHERE in the USA, would not even need a conventional furnace!

In a sense, this represents a wry irony! Our sister company, JUCA Super-Fireplaces, manufactures wood-burning fireplaces and stoves that similarly heat entire houses. For over 28 years, tens of thousands of homes have been entirely heated with JUCA woodburners. Obviously, if the NorthWarm Solar Heating System ever needed a "backup", a JUCA would have been the perfect choice! (Hundreds of people who spent small fortunes on [competitive] solar heating systems wound up buying a JUCA, and then bragging to their friends that they were "independent". We think they seldom mentioned that their solar contribution was minimal and the JUCA virtually was alone in heating their house! And yet, with the NorthWarm Solar Heating System, a JUCA is unnecessary!

Even more, consider when you go south on a winter vacation. You know how you turn the heat down, to minimize your heating bills? And then you come home to a cold house? Think about the NorthWarm system. Why not just leave it as normal? No heating oil or gas would be consumed. I guess that's not that important a difference, and no one really complains about coming home to a cold house, but it actually would not be necessary with the NorthWarm Version 1 System!

NorthWarm's [Computer Simulations](#)

**NorthWarm Solar Heating's Main Page is at:**  
<http://mb-soft.com/solar/index.html>



# NorthWarm Solar Heating Simulations

We put enormous effort in engineering our Solar System, and bought a hill near South Bend, Indiana, to construct it. We did a LOT of computer simulations in refining it. We obtained ALL the US Weather Station records ever kept at the South Bend International Airport! They only started recording there after World War II, so our simulations start then.

In 1948-49, the Winter sky had only about 23% clearness. Some whole Januarys and Februarys had less than 10% clearness! **In 1961-62, a January stretch of 10 days without ANY sun combined with temperatures below zero on 13 days!** In December 1967, there were 12 consecutive days without any Sun! In every case, the normal solar heating system performed disappointingly, while our system EASILY would have kept the entire large house at the constant 70°F! Check it out!!

**Please Choose Year:**

**Choose From These Years:**

**Then Click Here for Year's  
Performance**

---

NorthWarm's Home Page is at: <http://mb-soft.com/solar/index.html>

E-mail to: [Solar@mb-soft.com](mailto:Solar@mb-soft.com)

# Owners Say . . .

These are some of **MANY** unsolicited letters we have received:

---

Our JUCA B-3 . . . has heated our whole house (over 1300 sq ft) in temperatures down to 15 below. The inside temperature with the stove loafing along generally runs 75 . . . and the stove will indeed hold fires for eight or ten hours easily. Moreover, it will hold a night fire on 50 cents worth of oak. (*Minnesota*)

---

. . . working great . . . adapts to ductwork so easily and heats so efficiently that I doubt any other stove on the market can compete. (*South Dakota*)

---

(. . .) with the heat from the (JUCA) fireplace, our house stays between 68 and 70 degrees. (*Indiana*)

---

Our cats lie on top of the (JUCA) furnace or lie on the hearth.

---

We heated 6 rooms with it without hooking up the ducts and used a lot less wood than the other stoves we have used in the past.

---

This morning -10 degrees warming to +4 all afternoon. I've been on JUCA heat exclusively.

---

(. . .) Building inspector . . . was impressed with the unit.

---

You can't beat these fireplaces for the heat they put out.

---

We really love our JUCA.

---

. . . it is heating our entire house for us. . .

---

. . . have used less than 30 gallons of LP gas (this winter).

---

. . . installed our JUCA . . . ourselves . . . We were amazed and delighted at how comfortable the heat was, and how effectively our JUCA heated . . . our home . . . We enjoy being able to watch the fire.

---

. . . the B-3 has been the best buy out of all the purchases I have ever made.

---

We heat in excess of 2000 sq ft without any ductwork . . . My saving on fuel for one winter will almost pay the cost of the unit. I am very pleased with the construction and operation of the B-3 unit.

---

. . . able to keep the house regulated to about 70 degrees . . .

---

. . . my JUCA kept my home warm and saved \$100 per month in electric heat bills.

---

The stove is one of the best moves I ever made and it works real fine.

---

We are enjoying our JUCA very much and it heats our home extremely well and it looks real nice.

---

. . . has proven to be of the greatest value in heating our house.

---

. . . paid for itself in the first winter of use. It's all gravy, now.

---

My neighbor has been fully heating his house with two logs at a time in his JUCA for 15 years. I was using 20 logs in another brand of woodburner and still had \$1400 annual gas bills. I'm sending in my money. I want one just like he got.

---

I'm glad I finally found you. It wasn't easy, since you don't advertise. (*Kansas*)

---

. . . stove is marvelous! Dogs and cats love it. A winter pet magnet! (*Maine*)

---

---

*(Oct 1995)* I started using your stove in 1978. I checked the pipes [Ed: chimney] the first winter, but had no build up of creosote in them. I cleaned the chimney that spring with a brush, the first and last time. Every summer I check the chimney . . . *(New York)*

**[Ed: PLEASE check all chimneys anyway!!]**

---

**And then there are people who REALLY like their JUCAs!**

**You get the point!**

---

---

E-mail to: [JUCA@mb-soft.com](mailto:JUCA@mb-soft.com)

The JUCA Home Page is at: <http://mb-soft.com/juca/index.html>

# JUCA Fireplace Inserts

JUCA's Model L-8 Fireplace Insert (shown here) is designed to vastly improve the performance of an existing fireplace. **JUCA CUSTOM-BUILDS each and every L-8 specifically for that unique fireplace.** This approach provides the largest possible glass door, the largest firebox size, and the greatest heat-exchange area for highest performance. All this at a VERY REASONABLE price, (usually about \$1,500)

photo of an L-8

The customer makes [six measurements](#) of the fireplace. **JUCA's Computer-Assisted-Design (CAD) System then uses these dimensions to design a unique heat exchanger assembly as the firebox section of the JUCA L-8.** This ensures the most efficient possible Fireplace Insert, because the heat-exchange area is maximized. A JUCA L-8 Fireplace Insert built for an average-sized fireplace usually has a Heat-Output Rating of about 80,000 Btu/hr! You can confirm the **EXACT [rating for a JUCA L-8 Fireplace Insert](#) built for YOUR fireplace. It duplicates much of the computerized design work for YOUR CUSTOM FIREPLACE INSERT to calculate the exact Heat-Output Rating FOR YOUR INSTALLATION!** [After placing the order,](#) the finished, custom-built fireplace insert is completed and shipped.

**Other choices are also available.** The door can open right or left; the electric power cord (for the included automatic blower) can come out the left or right side; the warm air supply can come out primarily to the left or right. The attractive mesh areas (the room air intake and warm air outlet) can be Black, Polished Brass, or Aluminum. (The main body is usually matte black). Recently, as a result of a remarkably visionary (female) customer, who special ordered a unique combination of colors for body and screens, JUCA has started allowing customers to choose any of the [35 standard JUCA colors](#). for the screens and body. To see all of the choices available on a JUCA L-8 Fireplace Insert, and prices, [Click Here](#).

## Normal (Rectangular) Fireplaces

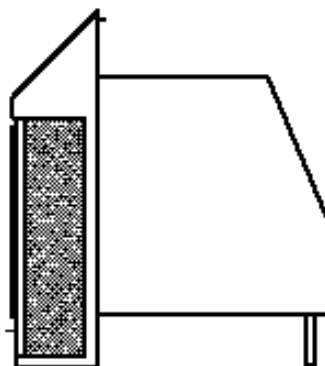
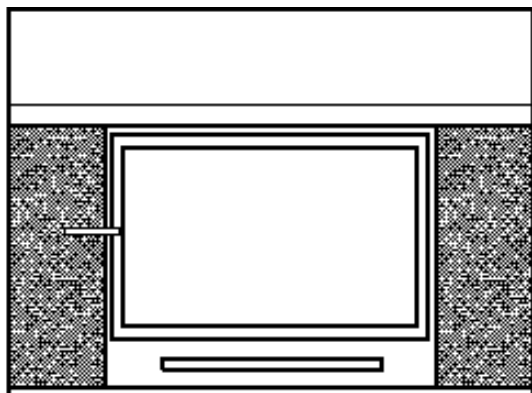

Normally, JUCA builds an L-8 to overlap the fireplace's brickwork by about 3 inches. Such a unit usually resembles the drawings here. Sometimes, however, customers have very rough surfaced fireplaces or otherwise prefer to have the L-8 be an "exact fit." This does not overlap the facing at all and requires high temperature caulking to seal the edges to the fireplaces. The precision of the measured fireplace dimensions must be very accurate for this option, and JUCA requires an accurate paper template of the fireplace opening to make sure of an exact fit. This is only possible for larger-sized fireplaces.

By the way, did you notice the sloping back wall of the heat exchanger portion? That's done to better match the sloping back wall of the individual fireplace! (Whatever the angle or size of that sloping fireplace wall, the L-8 is built to match it.) Also, note the heavy legs that support the heat exchanger structure. This keeps the heat exchanger up above the ash accumulations in the fireplace, to make sure that our FOREVER WARRANTY will never need to be activated. It also allows a small amount of air and smoke flow up outside the heat exchanger area to gain even more heat from its outside walls!

## Arch-Top Fireplaces

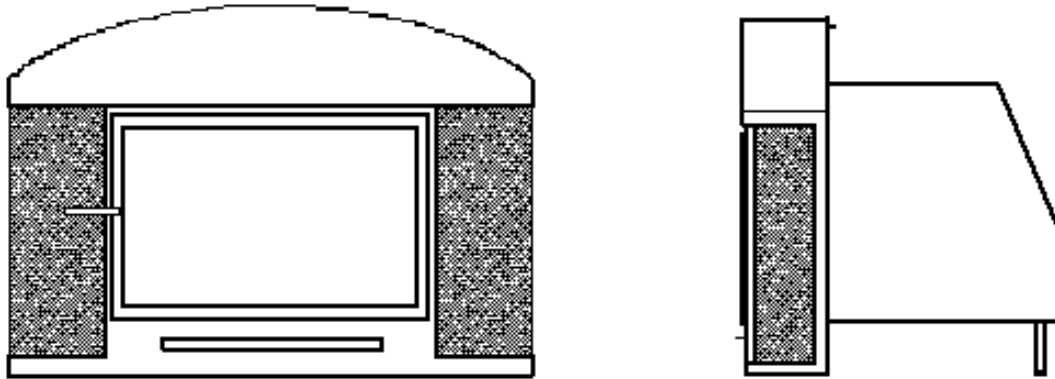

When customers have an arch-top fireplace, usually installing a competing brand's Fireplace Insert covers over everything and hides the arch. Since JUCA's Fireplace Inserts are individually Custom-Built, the JUCA L-8 can usually be made in several different ways. Of course, a normal (rectangular) L-8 can be made where the heat exchanger portion still is as large as possible in the firebox. But (as an extra expense option), the top portion of the front section of an L-8 can usually be made to follow the arch motif of a Flat-Arch fireplace, either with an overlap fit or as an exact (inside) fit! (This is probably not available for Full-Arch fireplace, since there would be nowhere to put the blower and grilles!)

## See-Thru Fireplaces

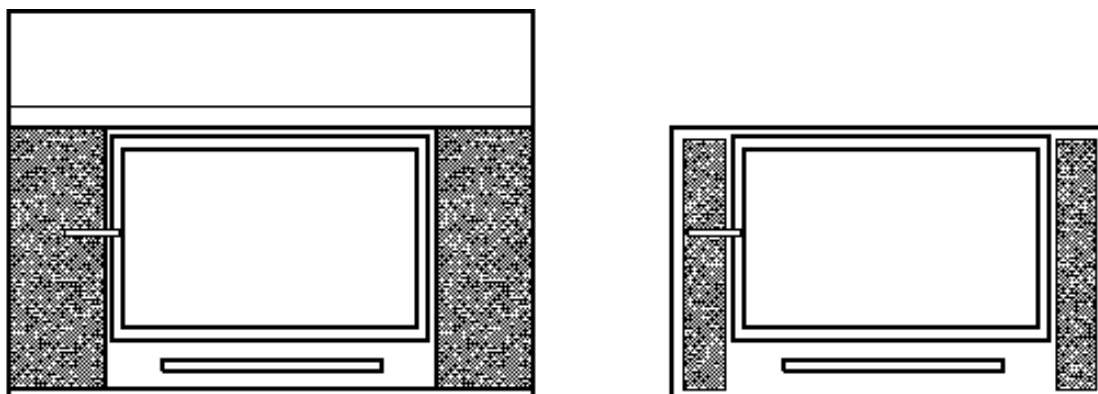

For applications where a fireplace connects two rooms as a see-thru, JUCA can make an L-8X See-thru Fireplace Insert. From one side the unit looks just like the normal L-8 (Left drawing). When the unit is slid into place (from that side), the back(?) side of the L-8X slides through the fireplace right up to be almost flush with the fireplace facing in the other room. This allows the glass area in that room to look like it really belongs there! (Right drawing) There are outlet grilles along side both the glass areas to feed warm air to both rooms. **More advantages of each JUCA unit being custom-built!**

The dimensions we need to build an L-8X are a little different from those for a normal L-8. We want to have the width and height of each opening, and we like to have the diagonals of those openings, too, to make sure the openings are actually square. (Usually, sketches of each side opening with the dimensions is a good idea.) We also need to have the distance through the fireplace at each corner of the fireplace. In principle, these four are all the same, but again we're just making sure! Finally, we want you to measure the floor diagonals through the fireplace. These again should be the same. If they're not, one opening is down the wall from the other, and we would have to make a distorted unit to fit in a distorted fireplace!

**Bad News!**

## And the L-8 Price???

**Usually \$1,499 (plus shipping)** [Details, Options](#)

## Measuring Your Fireplace

[PRICES](#)  
[Many Other Subjects](#)  
[URGENT!](#)  
[Solar Heating??](#)  
[FREE Air Conditioning??](#)

## Front View

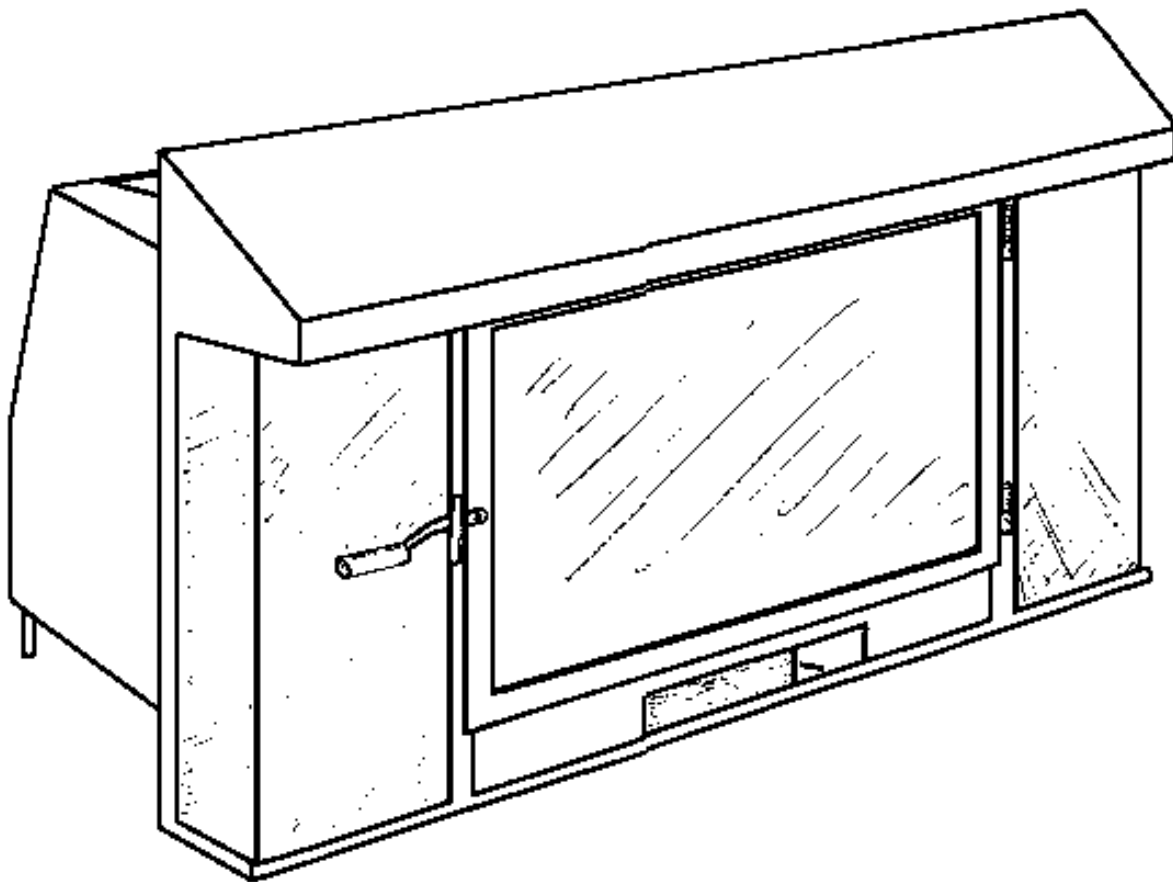

A drawing of a front view of a JUCA L-8 Fireplace Insert. Shown are the large glass area in a narrow frame; the grilles on either side for drawing in room air and sending it back out into the room after being heated; the slide draft control beneath the door. Dimensions and proportions are for illustration only; the actual dimensions and proportions are specified by the dimensions of the specific fireplace which it is custom-built to go into.

## Rear View

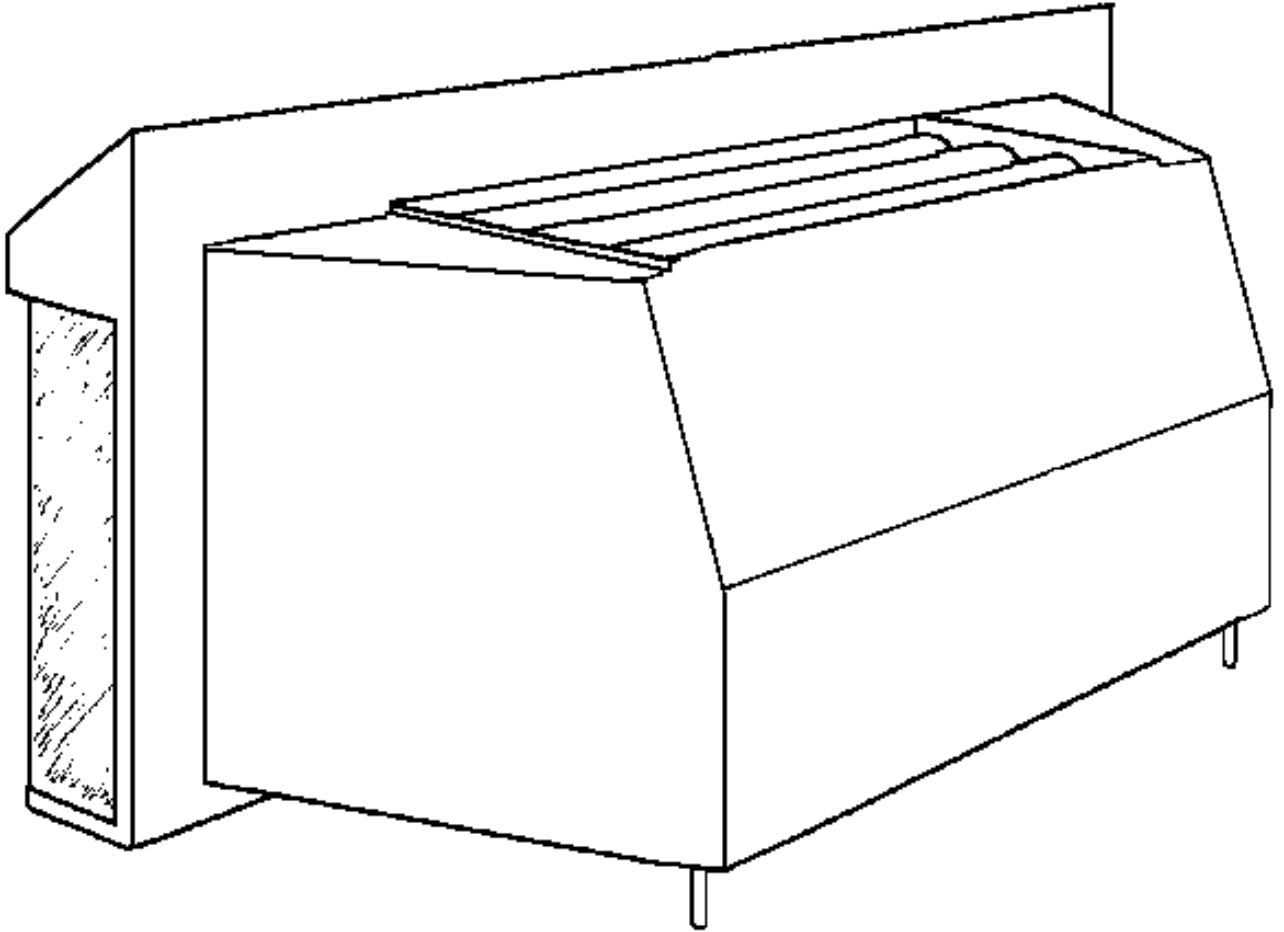

A drawing of a rear view of a JUCA L-8 Fireplace Insert. Shown are the generally tapering width; the rear wall which is vertical at the bottom and which then slopes forward; the hollow heat exchanger chambers which surround the firebox (the inner walls of which are super-heavy 1/4" plate steel); the heat exchanger tubes above the fire, which span the firebox, but which still allows a relatively open top, so that the fireplace can operate "normally" as it always had before; the rear legs, which keep the heat exchange structure up out of the ashes, which can be corrosive under certain conditions.

**The relatively open top is an important characteristic of the JUCA L-8 Fireplace Insert, and it's unique to JUCA's products.** ALL other efficient fireplace inserts operate on an air-suffocation (or air-tight) principle of operation. That approach NECESSARILY requires major changes in how the fireplace operates, from how it worked before the insert was installed. These effects require designs which have small fireboxes, limited heat exchange areas, and a closed fire chamber (with a closed top), and a direct-connect flexible hose kit to make sure that the creosote it produces is not deposited in the hollow space behind the body of the insert.

JUCA uses a totally different approach. **Our NON-air-tight design allows the fireplace to operate very similarly to how it operated before the installation of the insert.** (You could still roast marshmallows or make popcorn in it. Competing products cannot be operated with the door open because the design theory doesn't allow it.) Our custom



designed heat exchange structure incorporates the largest possible firebox size, the largest heat exchange surface areas, the largest glass viewing area and the largest door for feeding wood, and a blower that is MUCH stronger than any competitor.

All these characteristics combine to capture the most heat possible from the fire's output, while not messing up the fireplace's original operation. **That original operation always included very clean burning**, which the JUCA L-8's design maintains. JUCA L-8s do NOT share the air-tight inserts' problems of huge creosote and pollution creation. JUCA's non-air-tight design allows capturing all that heat while burning so cleanly that a "catalytic combustor" or "secondary burn" are not even necessary or desirable!

This difference between the JUCA's non-airtight design and ALL competing fireplace inserts (which are ALL airtight) has some other implications. Because those airtight products developed a bad reputation in the 1980s for creating a lot of pollution and creosote (because of the suffocation of the airtight operation), the EPA and other government agencies passed stringent laws applying to them. Commonly, the chimney must be re-lined (\$\$\$) and a special assembly called a Direct-Connect Kit (\$\$\$) must be installed (\$\$\$) (which is often pretty involved). The Direct-Connect Kit includes a large flexible stainless steel hose that connects the airtight insert up into the inside of the chimney.

As long as the present fireplace is safe to use to start with, a JUCA L-8 Fireplace Insert does not require all that, and the EPA and other agencies agree. The fireplace actually **still operates as it originally did** with the only difference being that the JUCA L-8 has captured much of the heat that would have gone up the chimney. Building fires is the same as before, and it behaves as you have come to expect it to behave. That is definitely NOT true of airtight fireplace inserts, which operate VERY differently!

## Why are JUCAs different from all competing Inserts?

The answer to that is pretty complex, and it's why we have hundreds of informational pages in our web-site. A capsule version:

Back in the 1970s, only Potbelly stoves, Franklin stoves and barrel stoves existed. They all produced huge amounts of heat, but TOO MUCH, and for only an hour or two. Great temperature variations in the room were common. So the problems were: too much heat and too short a burning period.

**Two solutions arose.** The Airtight design and the JUCA design.

- The **airtight approach** was to severely restrict the amount of air available to the fire. With less air, less burning (which is actually chemical oxidation of the fuel) could occur, which means less excessive heat production, which is good. Since the wood did not get consumed as rapidly, it lasted longer, giving longer burn times, which is also good.

With MODERATE restriction of the air supply, this represented a great improvement over previous woodburners. During the 1970s, people tended to use them in such an appropriate way.

When energy awareness became dominant about 1980, people started to try to use such products in extreme ways. They SERIOUSLY restricted the air supply, to make them operate even more efficiently. That happened, but an unexpected consequence was extremely poor burning. Under some conditions, fully 1/3 of the energy in the wood was going up the chimney as creosote and pollution! Which also reduced intrinsic efficiency, but no one noticed.

In the early 1980s, a lot of houses burned down, because massive creosote accumulations in chimneys would burn at over 5000 F, and no chimney could handle that. A lot of pollution was also getting put in the air.

- The **JUCA approach** was very different. It involved a larger firebox, normal non-airtight burning, MUCH thicker pieces of wood, and a sophisticated heat capture system. In principle, the fire would be allowed to burn as rapidly as it wished, but the thick pieces of wood (logs) NATURALLY only burn at a moderate rate, because burning can

only occur at the SURFACE of a piece of wood. (Thicker logs actually burn more slowly!)

Thicker logs ALSO naturally burn more EVENLY (for reasonably constant heat output) and for a much longer time.

The JUCA design accomplishes the goals of evenness of heating and long burn times, in a VERY different way than airtight designs do. In a far more natural way. The burning is extremely complete and efficient and clean. Virtually NO creosote or pollution is created in the fire, as fireplaces have operated for hundreds of years!

The flaw in the logic so far is that thick logs burn so slowly that they create rather small amounts of heat. This is why the sophisticated heat capture and heat exchanger system is important. It captures MOST of the heat actually produced, and sends it out into the room and not up the chimney.

As a footnote, airtight products CAN NOT safely use extensive heat exchangers to improve their efficiency. Since they naturally produce so much creosote in their smoke, and creosote condenses out at about 350 F, they must NOT be extremely efficient. Otherwise, they would cause massive creosote accumulation in their chimney systems. Some products like that were briefly sold around 1980, but they proved to be very dangerous products for this reason. Since JUCAs are non-airtight, the fire burns very cleanly, so there's little very creosote in the smoke, so we can capture the daylight out of the heat in the smoke! An optimally efficient JUCA can have smoke temperatures of 250 F. We are thus able to capture an extra hundred degrees of heat from the smoke before it goes up the chimney! Voile! Very high efficiency!

Another unique characteristic of a JUCA Fireplace Insert, which is only possible because of the non-airtight design, is that it has an open bottom! When you look inside, you see the original fireplace floor! Why is this good? If you already have an ash dump, or a gas line for a log lighter or gas logs, or an outside combustion air inlet, those features still work like they always did! What a deal!

And, up above, since the space between our heat exchanger tubes is also open, an extension could be added to the existing fireplace throat damper, so it hangs down between the JUCA's tubes. This would allow normal adjustment of that damper, just like before!

---

## Air-Flows

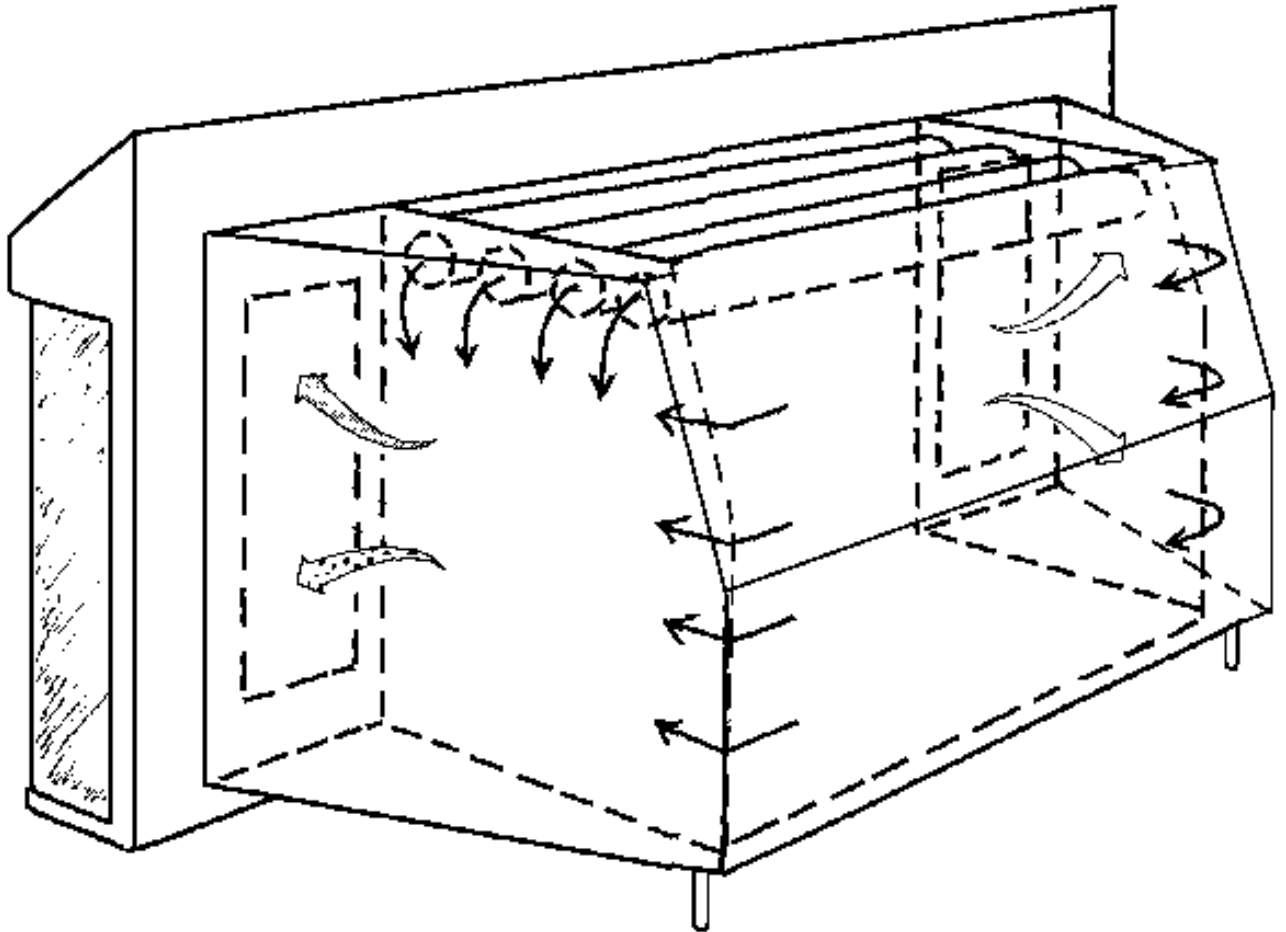

This (transparent) view of a JUCA L-8 Fireplace Insert shows the side-to-side airflow, coming from the front-mounted, automatically activated blower; through the tubular heat exchangers and all the way around the firebox (generally split about equally between these paths); and then back through the main wall passageway for the warmed air to leave the heat exchange chambers and get out into the room.

This configuration allows a JUCA L-8 heat exchanger to capture the radiation from the fire in all directions, because our heat exchange chambers totally surround the fire. It also captures much of the heat being carried away in the hot smoke, primarily by the presence of the tubular heat exchangers above the fire.

There are also a variety of more subtle design features incorporated in a JUCA L-8 to enhance performance. JUCA designers (and JUCA computers!) have gone to a lot of effort to maximize the performance of each and every Custom JUCA L-8 Fireplace Insert made.

---

We have even arranged for a way for you to know a little about such a Custom-Built JUCA Fireplace Insert specially made for your fireplace! (At least for single-sided fireplaces!) [This program](#) uses the six dimensions of your fireplace and duplicates some of the design work our people would do during construction of it. The program then estimates several useful bits of info about the unit.

The actual unit might have slightly different dimensions or ratings. These are just preliminary estimates that are usually quite close to the final figures.

Before you get too excited about wanting to get one of these, please read the [Production Schedule](#) info. Then, you may want to look at [Plan B](#) below.

## Plan B

OK! So we know that we cannot please ALL the people ALL the time! There are several situations where a customer might actually **dare** consider NOT getting our L-8 unit!

- **Climate.** You live in a climate where you do not need the tremendous sophistication and heating capability of the L-8.
- **Attitude.** You live in a colder climate, but getting heat out of your fireplace is not your highest priority, but you would like to get some.
- **Appearance.** You think the L-8 is ugly as sin! (Some people LOVE its appearance, so there!)

For these people, we have an alternate suggestion. It does not actually involve anything we manufacture, and the heat collection is much less, but there is great flexibility of appearance, where the fireplace could look very "standard". In many cases, since we can supply these set-ups at our normal discounts, the final cost is actually even less than that of our L-8 (in some cases, as low as about \$800)! (Pretty effective job of salesmanship, huh?)

If this interests you, please [Click Here](#).

[Or Here](#) for an Index of Many More Subjects.

---

[Click Here](#) to Return to JUCA Main Menu.

E-mail: JUCA at [JUCAL8@mb-soft.com](mailto:JUCAL8@mb-soft.com)

---

The main JUCA Web-Site is at: <http://www.mb-soft.com/juca/index.html>

## Totally Heating a Home with Solar Heat??

We have a sister company in Solar Heating that has just as much technology and expertise as we do! If you have interest in really high performance in a Solar Heating system, you might want to visit the [NorthWarm Solar Heating](#) web site. Most of the NorthWarm systems are based on a patented system.

Even better, the NorthWarm Version 1 System includes a sub-system that is also a way of **entirely Air Conditioning virtually any existing house in the United States nearly for FREE!** In a spirit of hoping to assist California homeowners from enormous summer electric bills (and power outages), this sub-system is being made available, for FREE, at [FREE Home Air Conditioning!](#) We hope that, if enough California homeowners would install the simple system, maybe the power companies and the energy grid could keep up with the Summer high demand for electricity. Since we're giving this information away, you could probably help some of those California homeowners to tremendously reduce their summer electric bills and maybe help avert blackouts out there, so let any of your California friends know about that possibility available to them!

We are also involved with a variety of other projects that are meant to give benefit to society in one way or another. Some are social or intellectual presentations, meant to help find solutions to things in our lives. Others are products or services that also are meant to somehow improve our lives. If you have curiosity about this, you might want to visit a directory page we set up for these [Various projects](#). If you are civic-minded or otherwise motivated, a number of those projects could benefit from the participation of additional people.

---

This site was designed by:

**MB Software**

E-mail: MB at [MBSoft@mb-soft.com](mailto:MBSoft@mb-soft.com)

# Color Finish on Free-Standing Models

---

## Black Matte Finish

The lower half of all free-standing JUCAs are normally this matte (flat) black finish. It is not actually a paint. Technically, it is a silicone-based coating, suitable for surfaces subject to continuous temperatures of 800°F. Since the hottest areas of a JUCA operate at about 400-450°F, the paint is likely to keep its condition forever.

This kind of coating actually fuses into the metal during the first few fires' heating. During this "curing" process, some smell and airborne particles can be released. After those first few fires, the coating should be fully cured and should never again give off any smell, and the coating will have become permanently bonded to the metal.



## Medium Red or Bright Orange Gloss Finish

JUCA offers two gloss finishes on the upper half of free-standing models. The lower half remains [black matte finish](#).

These finishes are rated at continuous temperature of 400°F. Since the upper shell of a JUCA surrounds a warm air chamber, it is seldom over 150°F, so the gloss high temp paint JUCA uses should last forever.

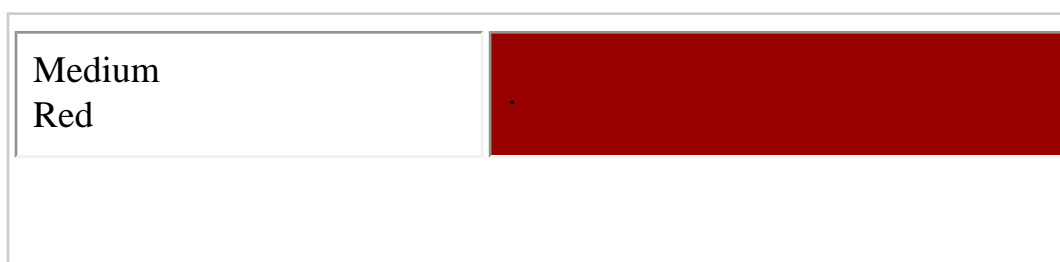

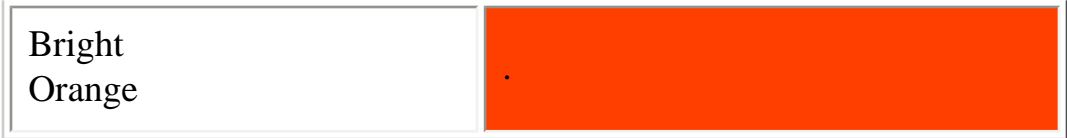









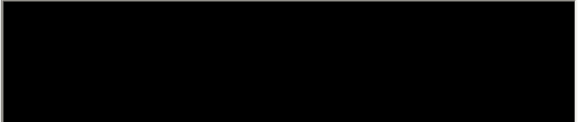







Please keep in mind that the exact color may be a little different from what you see on your monitor, since color/tint/contrast/intensity settings vary from monitor to monitor. You can request a COLOR SAMPLE if the precise color is really important to you.

---













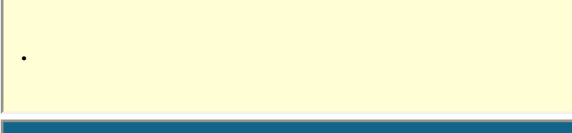

### Other Optional Finishes

As with everything else regarding JUCAs, a huge choice is available. Currently, there are about 45 color choices in this category. All are matte finish, unless noted below.

<p>Matte Gold</p> <p>.</p>	
<p>SB Satin Black</p> <p>.</p>	
<p>SB Leather Brown</p> <p>.</p>	
<p>SB Metallic Brown</p> <p>.</p>	
<p>SB Russett</p> <p>.</p>	
<p>SB Metallic Gray</p> <p>.</p>	
<p>SB Sky Blue</p> <p>.</p>	

SB Metallic Mahogany .	
SB Metallic Blue .	
SB Moss Green .	
SB Forrest Green .	
SB Redwood .	
SB Charcoal .	
SB Golden Fire Brown .	
SB Silver .	
SB Almond .	
SB Metallic Rich Brown .	
SB Sand .	
SB Metallic Black .	
SB Bark Brown .	
SB .	

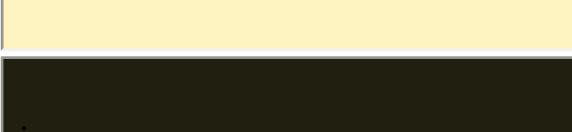

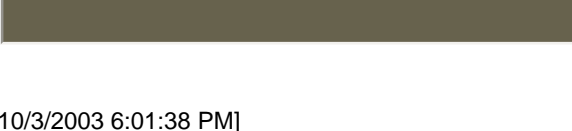
SB Honey Glo Brown .	
SB Mauve .	
SB Patriot Blue .	
SB Mojave Red .	
TH Dark Brown .	
TH Metallic Dark Brown .	
TH Clay Tan .	
TH Raleigh Blue .	
TH Warm Brown .	
TH Metallic Warm Brown .	
. .	
TH Hanover Red .	
TH Andover White .	
TH Newbury Brown .	
TH Roanoke Brown .	

TH Gloucester Gray .	
<b>Gloss Finish</b>	
SB Ivory .	
SB Almond .	
SB Sand .	
SB Brown .	
SB Blue .	
SB Green .	
SB Hunter Green .	
SB Light Red .	
SB Dark Red .	
SB Dark Blue .	

Please keep in mind that the exact color may be a little different from what you see on your monitor, since color/tint/contrast/intensity settings vary from monitor to monitor. You can request a **COLOR SAMPLE CARD**.

Color choice selection may vary from time to time based on the paint manufacturers' offerings.

The JUCA Home Page is at: <http://mb-soft.com/juca/index.html>

E-mail to: [JUCAcolor@mb-soft.com](mailto:JUCAcolor@mb-soft.com)

This Web-Site was designed by: MB Software

E-mail to: MB at [MBSoft@mb-soft.com](mailto:MBSoft@mb-soft.com)

# Glass Fireplace Door Choices

**We offer over 2,000 different glass fireplace screens** for the visible part of JUCA's F-9A built-in fireplace. We're sure you don't want to have to deal with descriptions and pictures of ALL 2,000+ different glass fireplace doors currently available on a JUCA F-9A **Whole-House Heating, Built-In Super-Fireplace.**

This page pre-qualifies the choices, to make the list you see a more manageable size. Please select from the choices below and then click on the **Display List** button.

<a href="#"><b>URGENT!</b></a>	<a href="#">Assorted useful info on doors and gas logs (and some propaganda!)</a>
--------------------------------	-----------------------------------------------------------------------------------

## Please Choose Overall Shape:

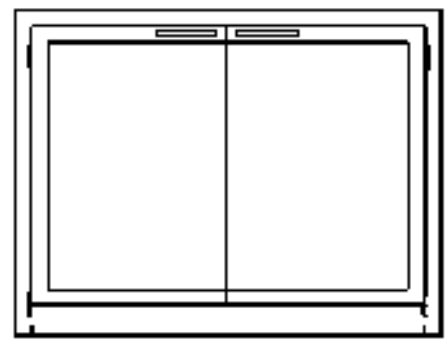
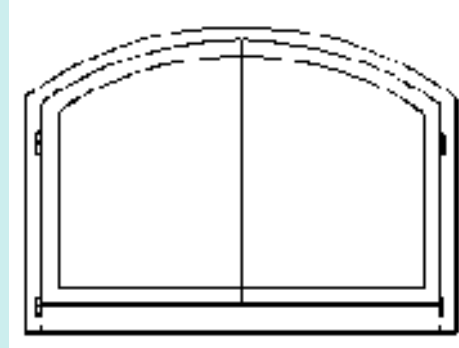
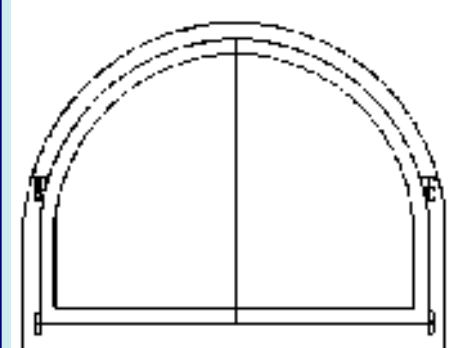
<p><b>Rectangular</b></p>  <p>about 1459 choices</p>	<p><b>Flat-Arch</b></p>  <p>about 363 choices</p>	<p><b>Full-Arch</b></p>  <p>about 317 choices</p>
<p><b>Choose Here:</b> <a href="#">Rectangular</a> -- <a href="#">Flat-Arch</a> -- <a href="#">Full-Arch</a> -- <a href="#">Other</a></p>		

## Please Choose Opening Method:

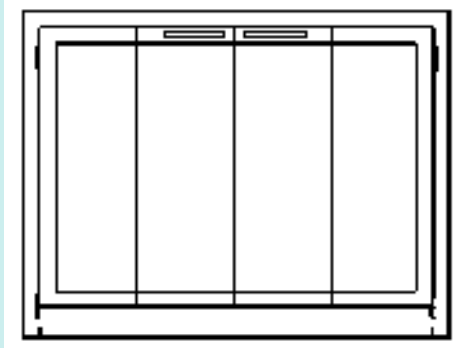
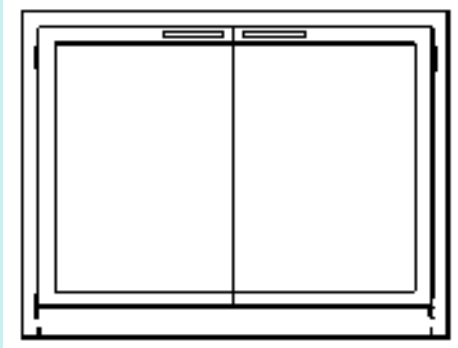
<p><b>Bi-Fold</b></p>  <p>about 956 choices</p>	<p><b>Twin (or Cabinet)</b></p>  <p>about 955 choices</p>
------------------------------------------------------------------------------------------------------------------------------------	-----------------------------------------------------------------------------------------------------------------------------------------------

**Choose Here:** -- Bi-Fold    -- Twin (or Cabinet)

**Please Choose Style:**

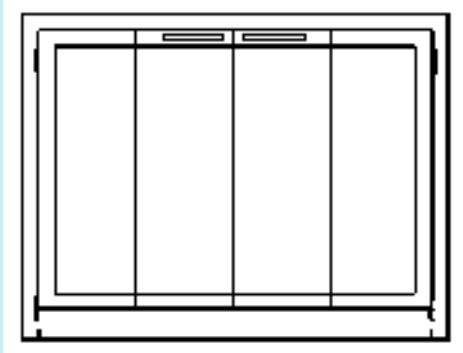
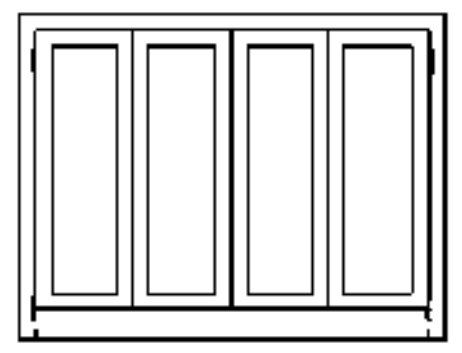
<p><b>Clear-View</b></p>  <p>about 1266 choices</p>	<p><b>Traditional</b></p>  <p>about 646 choices</p>
<p><b>Choose Here:</b> -- Clearview    -- Traditional</p>	

**Please Choose Door Finish:**

**Choose From These Finishes:**

**Then Click Here for the List:**

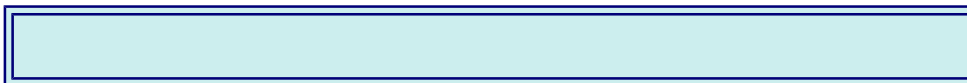

---

## Brands

On the custom-built built-in fireplaces we (JUCA) manufacture, we use many brands of doorsets. Therefore, we handle:

- [Portland-Willamette](#)
- [HearthCraft](#)
- [Diamond W](#)
- [Custom Doors](#)

- [Wilkening](#)
  - [Schaefer](#)
  - [Custom Firescreens](#)
  - [Beckwood](#)
  - [Designer Specialties](#)
  - [ThermoRite](#)
  - [Heat-n-Glo](#)
  - [Minuteman](#)
  - [FireGuard](#)
  - [Hart](#)
- 

## Miscellaneous Notes

People notice the **wide range of prices** of the fireplace doors available on a JUCA F-9A and ask why. How could there be door sets for \$250 and others for over \$2,000? And mass merchandisers even sell some for around \$100. How could this be?

Think about automobiles. General Motors makes some GEO models that sell for about \$7,000, and other models that sell for over \$50,000. Both will get you down the road! And for a while, Yugos sold NEW for under \$4,000! How could THIS be? Well, it is related pretty directly to two things: **Quality and Extra features**. Try closing a door on a GEO and on a Cadillac Eldorado. The "feel" is VERY different! The Eldorado also has quite an assortment of luxury features which are standard, where the GEO is pretty much "bare bones."

A similar concept applies to fireplace doors. Doors sold by mass merchandisers look nice when you buy them but feel really flimsy and cheap when you open or close the doors, and the minimal brass plating sometimes starts coming off during the first winter of use. These are almost "disposable doors!" At the other (expensive) end of the spectrum are doors which feel strong and smoothly glide open and closed. Quality is obvious throughout, with a protective coating over the brass to keep it from ever discoloring.

In the middle are doors of intermediate quality, **generally in direct relation to the price**. This being America, these manufacturers have found a "fair" price for each of their products. When they tried to charge too high a price, competing models captured their market share. When they charged too low, they soon realized they could make higher profits without losing any market share.

**Subjectively**, we feel that most of the doors in the \$350-\$500 range have very good quality when economy is a significant concern. (That's why we include any of the doors up to \$450 list price, as STANDARD with the JUCA F-9A Built-In Fireplace.)

We usually start getting nervous regarding quality on doors which list for under \$300 or so. In general, such doors are mass produced using as many "shortcuts" as the manufacturer think they can get away with. Metal thickness is the thinnest, the plating process is the fastest they can accomplish, hinges and rollers are the least expensive possible, part assembly is very fast and sometimes sloppy, and quality control is often poor. We are trying to avoid certain single-word descriptions of such products here! We realize that you cannot personally see all of the many door qualities available on the market, and we are just trying to give some personal, subjective opinions on such products. We choose not to carry such products, and we suspect that says something, too!

If economy is not quite so pressing a concern, we think in terms of up to maybe \$800 list. In many years of handling thousands of door sets in this price range (\$500-\$800), we can only recall a single customer not being completely pleased by the quality of the door set. Above this price range, we usually only recommend door sets either because the style or appearance merits it (like super-narrow frames), because a particular unique style would enhance a desired room decor (like pewter doors), or because price is less important than absolute top-of-the-line quality.

(Arch-Top door assemblies are usually \$250 or so higher than the comparable rectangular door assemblies discussed above.)

All modern quality fireplace door sets have an invisible enamel or lacquer coating over the Brass or Copper to make sure it would **never tarnish** or otherwise oxidize. Modern door sets do not have to be continually cleaned and polished like very old fireplace door sets did.

People sometimes also ask us about **Solid Brass versus Plated Brass**. Some door models are available in either construction, and there's usually a couple hundred dollars difference in the price. So! Should someone ALWAYS lean toward the more expensive solid brass? Actually, probably not! All reputable door manufacturers use excellent care in the plating process they use, so the layer of plating is plenty thick. In addition, that protective coating keeps the air from oxidizing/tarnishing the plated metal, and it also eliminates you grinding away that plating with abrasive cleaners. In other words, there doesn't seem to be much reason to spend the extra money for a solid brass door set (in our opinion!) [We're trying to save you some money here!]

Again, the actual list price of a door set should probably be the best guide for you regarding quality. As an example, there are a few Brass Plated door sets which are carefully hand-assembled and the finish is hand-polished (unusual in the modern world!) and the result is an incredibly impressive door set! In our opinion, such a door set definitely deserves its higher list price. So, just the word **SOLID** or **PLATED** shouldn't necessarily turn you on or off for a particular door set.

---

Another important subject: **INSTALLATION!** There would be little sense in getting a door set if it was not likely to be installable on YOUR fireplace. Or if it was necessary to hire a rocket scientist to mount it!

Fortunately, this is America! All of the door manufacturers are aware of each other! They don't want to

give you ANY reason to go to any of their competitors. Therefore, ALL door sets come with a bag of hardware, such that (usually) three different mounting methods are available. (They want to make sure you don't get frustrated with their products and say bad things about them!) Each door set comes with installation directions, which range from adequate to great.

Briefly, the methods generally available for overlap doors (the most common arrangement) are as follows:

1. Most fireplaces have a heavy metal beam across the top of the opening, called a lintel, which supports the weight of all the bricks or stone above it. The simplest installation just involves special shaped "hooks" that grab on the back edge of the lintel. (This method usually does not apply to JUCA's F-9A units).
2. Many doorsets have provision to just press outward sideways on the sidewalls of the fireplace. Technically, it is not actually attached at all! It is just fixed in place by that sideways pressure. (The sideways pressure is usually focused on pointed bolts so it very slightly digs into the sidewalls for additional stability).
3. Door sets always include several "masonry anchors". If neither of the "easy" installations will work, this one ALWAYS does! Either two or four 1/4" holes are drilled in the sidewalls of the fireplace, about 1" deep. The little anchors (usually plastic) are then slid in those holes and screws (provided) are screwed into them to attach the door set very solidly and permanently. (This method is a little different for JUCA's F-9A units. Instead of masonry anchors and 1/4" holes, 1/8" holes are drilled in the sides of the "snout" of the F-9A for the screws).

**Please note that none of these methods alter or affect the facing of the fireplace at all.** In nearly all cases, the provided strips of fiberglass insulation does a decent job of sealing the door set with the fireplace facing. People who want a tighter seal sometimes use silicone caulking around the edges. Very rough surface fireplaces might need extra fiberglass or alternate sealing methods, or an inside (exact fit) mount of the door set.

---

Another useful subject: **Extra heat!** (This whole subject does not apply for a JUCA F-9A or F-9AX because the fireplace already has a far more sophisticated heat capture structure in it). Sometimes people want to not only put glass doors on a fireplace to keep from losing heat up the chimney but they also want to get more heat, too! One common solution to that is a Fireplace Insert. Such products have a variety of drawbacks: they tend to be small (to fit in most fireplaces) so they have small doors, small glass areas, and small fireboxes. They generally involve having (ugly?) black metal panels around the Insert to close off the remaining opening of the fireplace. They are nearly always of a design called "air-tight" which means they are prone to creating potentially dangerous creosote in the chimney and pollution in the environment. And they're generally rather expensive.

JUCA has long offered a (non-air-tight) Fireplace Insert, but some people don't like its appearance either, and it might be like forever before additional ones will be able to be built, so that's not a realistic alternative right now.



A third alternative exists, and it is often a pretty good one! There are products called "hearth heaters" which capture some heat from the fire with a blower and heat exchanger. The best part is that the FRONT of these units is just 1 3/8" high! Then ANY of our thousands of door choices could be selected to be placed on top of it! The result is virtually the same appearance as a normal fireplace door set, but with a reasonable amount of heated air coming out into the room. These hearth heaters are available in several configurations, but all are under about \$500 (after our discount). If this interests you, there is a thorough, honest (some say harsh!) discussion of them at [Hearth Heaters](#).

The most important consideration related to hearth heaters is that a door set then needs to be bought for an opening height 1 3/8" (1.37") LESS TALL, because it would be sitting ON TOP of the front part of the hearth heater.

---

## **[JDoor's Door Ordering Form](#)**

## **[JDoor's Portland-Willamette Door Ordering Form](#)**

## **[JDoor's HearthCraft Door Ordering Form](#)**

## **[JDoor's Diamond W Door Ordering Form](#)**

---

JUCA's Built-In Fireplace Home Page is at: <http://mb-soft.com/juca/indexf.html>

E-mail to: [JDoor@mb-soft.com](mailto:JDoor@mb-soft.com)

# JUCA Prices

---

All JUCA prices and options, and much more, are in our web-site. Each product model line has a separate page that lists every single choice, option and price, that applies to that particular model. Included are thorough descriptions of every available option and many of the specific features of that model JUCA. Freight and ordering info is included, too.

In each JUCA Model home page, there is always a prominent line, in big green print, that is like:

**About \$1,400 (plus shipping)** [Details, Options](#)

The link "Details, Options" is the link to the page with the prices, options, and details for that model. That page also has many additional links to specific info on the various features, options, and other useful stuff.

---

If you already know which JUCA Model you are interested in, here is a list of links to all the various pricer pages:

- [Model F-9A Details, Options](#)
- [Model B-3B Details, Options](#)
- [Model B-3A Details, Options](#)
- [Model F-9AX Details, Options](#)
- [Model B-3J Details, Options](#)
- [Model B-3D Details, Options](#)
- [Model L-8 Details, Options](#)

(Less popular models below:)

- [Model B-3C Details, Options](#)
- [Model B-3N Details, Options](#)
- [Model B-3JN Details, Options](#)
- [Model K-3 Details, Options](#)
- [Model D-3 Details, Options](#)
- [Model D-7 Details, Options](#)
- [Model C-3 Details, Options](#)
- [Model C-7 Details, Options](#)

The JUCA Home Page is at: <http://mb-soft.com/juca/index.html>

E-mail to: [JUCApricezz@mb-soft.com](mailto:JUCApricezz@mb-soft.com)

This Web-Site was designed by: MB Software

E-mail to: MB at [MBSoft@mb-soft.com](mailto:MBSoft@mb-soft.com)

# JUCA Super-Fireplace Info Sheets

These presentations are each designed to be **PRINTABLE** so that you can have a hard copy to show to friends or your contractor. Nearly all of them originated as entries in the JUCA Downloadable Program, which we originally duplicated here for people whose computers could not present the DOS-based program.

We have tried to include every subject associated with wood-burning or gas-burning; fireplaces, woodstoves or furnaces.

These subjects are ALSO listed [Alphabetically](#).

## General Subjects

### Listed by General Usefulness

- **Popular Subjects**
- [Ducting](#) (General)
- [History of Wood Burning - Beyond Air-Tight](#) (General)
- [Comments from JUCA Owners](#) (General)
- [Firewood Chart](#) (General)
- [Questionnaire for Custom Computer House Analysis](#) (General)
- [How a JUCA Performs so Well!](#) (General)
- [B-3 1-Glass-Sided Wood Furnaces](#) (Models)
- [B-3 3-Glass-Sided Wood Furnaces](#) (Models)
- [F-9A Built-In Fireplace Wood Furnaces](#) (Models)
- [Ideas, Possibilities](#) (General)
- [Shipping Suggestions](#)
- [Blower Choices](#) (Models)
- [Colors Available on Free-Standing JUCAs](#) (General)
- [Blower Variable Speed Control](#) (Models)
- [Remote Blower Option](#) (Models)
- [Flexibility for Applications](#) (General)
- [Door Facings for JUCA Fireplaces](#)
- [Door Facings for Fireplaces](#)
- [Duct Connection Damper](#) (Install)
- [Hot Water Production](#) (General)

- [The Story Of JUCA](#) (General)
- [Comments On Our Pricing](#) (General)
- [Free-Standing JUCA Side Warm Air Outlets](#) (General)
- [Company Structure](#) (General)
- [Cooking and a JUCA](#) (General)
- [Heat Exchanger Design](#) (General)
- [External Make-Up Air](#) (General)
- [External Combustion Air](#) (General)
- [Gas Pipe Provision For Gas Logs or Gas Starter](#) (General)
- [Outside Combustion Air Inlet Option](#) (General)
- [Selling](#) (General)
- [Chimney Connector \(Flue\)](#)

## ● **JUCA Model Types**

- [Built-In Wood Burning Fireplaces](#) (Models)
- [Free-Standing Wood Stoves](#) (Models)
- [3 Glass Sided Free-Standing Wood Stoves](#) (Models)
- [Free-Standing Wood Furnaces](#) (Models)
- [Built-In Gas Burning Fireplaces](#) (Models)
- [Free-Standing Gas Stoves](#) (Models)
- [3 Glass Sided Free-Standing Gas Stoves](#) (Models)
- [JUCA Model Brief Descriptions](#) (Models)
- [JUCA Model Descriptions / Specifications](#) (Models)

## ● **Miscellaneous Subjects**

- [Efficiency Comparison of Different Products](#)
- [Performance Chart \(Output\)](#) (User)
- [Current Time Schedule](#) (Models)
- [INTRODUCTION](#) (General)
- [INTRODUCTION](#) (General)
- [INTRODUCTION](#) (General)
- [AIR-TIGHT vs NON-AIR-TIGHT](#) (General)
- [Bonnet Control Automatic Blower Control](#) (General)
- [Main Warm Air Outlet Duct](#) (General)

## ● **Technical Series**

- [Technical-Design Of A Wood-Burner](#)

- [Technical- 17 Degree Angle Sides](#)
- [Technical-Controlled Turbulence](#)
- [Technical-Fire Physics](#)
- [Technical-Design Of Secondary Air](#)
- [Technical-Testing Philosophy](#)
- [Technical-Energy In Wood Fuel](#)
- [Technical-Chimney Design](#)
- [Technical-Computer-Assisted Design](#)
- [Castable Firebrick Technical Specifications](#) (Models)
- [Firebox Technical Design Considerations](#) (Models)

•

## • **Prices, Options**

- [Prices, Options for B-3A Unit](#) (General)
- [Prices, Options for B-3B Unit](#) (General)
- [Prices, Options for B-3C Unit](#) (General)
- [Prices, Options for B-3D Unit](#) (General)
- [Prices, Options for F-9A Unit](#) (General)
- [Prices, Options for B-3J Unit](#) (General)
- [Prices, Options for B-3JN Unit](#) (General)
- [Prices, Options for K-3 Unit](#) (General)
- [Prices, Options for L-8 Unit](#) (General)
- [Prices, Options for B-3N Unit](#) (General)
- [Prices, Options for F-9AX Unit](#) (General)

•

## • **Dimensions, Specifications**

- [Dimensions of B-3A Unit](#) (General)
- [Dimensions of B-3B Unit](#) (General)
- [Dimensions of B-3C Unit](#) (General)
- [Dimensions of B-3D Unit](#) (General)
- [Dimensions of F-9A Unit](#) (General)
- [Dimensions of B-3J Unit](#) (General)
- [Dimensions of B-3JN Unit](#) (General)
- [Dimensions of K-3 Unit](#) (General)
- [Dimensions of L-8 Unit](#) (General)
- [Dimensions of B-3N Unit](#) (General)
- [Dimensions of F-9AX Unit](#) (General)

•

- **Product Order Forms**

- [Ordering Form of B-3A Unit](#) (General)
- [Ordering Form of B-3B Unit](#) (General)
- [Ordering Form of B-3C Unit](#) (General)
- [Ordering Form of B-3D Unit](#) (General)
- [Ordering Form of F-9A Unit](#) (General)
- [Ordering Form of B-3J Unit](#) (General)
- [Ordering Form of B-3JN Unit](#) (General)
- [Ordering Form of K-3 Unit](#) (General)
- [Ordering Form of L-8 Unit](#) (General)
- [Ordering Form of B-3N Unit](#) (General)
- [Ordering Form of F-9AX Unit](#) (General)

- **Chimney Subjects**

- [Chimney Information](#) (Accessories)
- [Chimney Comparison Shopper](#) (Accessories)
- [Chimney Re-Lining Materials](#) (Accessories)
- [Class-'A' Chimney Manufacturer Info](#)
- [Information on Solving Problems in Existing Chimneys](#) (Accessories)

- **Built-In Fireplace Subjects**

- [F-9A Built-In Fireplace/Wood Furnaces](#) (Models)
- [F-9-Series Space Requirements](#) (User)
- [F-9A Arch-Top Options](#) (General)
- [F-9A Ash-Dump Provisions](#) (General)
- [F-9A Warm Air Outlet Options](#) (General)
- [F-9A Chimney Options](#) (General)
- [F-9A Built-In Fireplace Wood Furnaces](#) (Models)
- [Fireplace Mantels](#) (Accessories)
- [Fireplace Tools, Accessories](#) (Accessories)
- [Gas-Burning Fireplaces](#) (Accessories)
- [Features on JUCA Built In fireplaces](#) (General)
- [F-9A Left-Right Choices](#) (General)
- [F-9A Main Warm Air Outlet Duct](#) (General)
- [Oversized F-9A Unit Options](#) (General)
- [F-9A Door Appearance Choices](#)
- [F-9A Old Version Door Selector](#)

- **Ducting Subjects**

- [Ducting Into Warm Air Ducts](#) (General)
- [Ducting Into Cold Air Ducts](#) (General)
- [Ducting Into a Separate Duct System](#) (General)
- [Non-Ducted Duct Arrangement!](#) (General)
- [Blower Specifications and Performance Curves](#) (General)

- 

- **More Subjects**

- [Bonnet Control Auto Blower Ctrl of L-8](#) (General)
- [Castable Firebrick Firebox Floor](#) (General)
- [Comparing a JUCA to A Gas Furnace](#) (General)
- [Computer-Assisted Design](#) (Tech)
- [Construction / Materials](#) (General)
- [Creosote](#) (General)
- [Door Details on Free-Standing and Insert JUCAs](#) (General)
- [Editorial to the Industry](#)
- [EPA Regulations And JUCA](#) (General)
- [Features on JUCA Products](#) (General)
- [Firebox Subjects](#) (General)
- [Free-Standing Wood Furnace - Advanced](#) (Models)
- [Fuel-Limited Operation](#) (General)
- [Gas Logs For Fireplaces](#) (Accessories)
- [Standard Tempered Glass](#) (Models)
- [Glass Options Available](#) (Models)
- [Glass Options](#) (Models)
- [Glass Mesh Screen](#) (Models)
- [Glass Removable Safety Panel](#) (Models)
- [Grates \(Log Holders\) Considerations](#) (General)
- [JUCA's Sales Pitch](#) (General)

- 

- **Fireplace Insert Subjects**

- [L-8 Fireplace Insert](#) (Models)
- [Measuring for a L-8 Fireplace Insert](#) (General)
- [L-8 Fireplace Insert Comparison](#) (Models)
- [L-10 Fireplace Insert](#) (Models)
- [L-8 Warm Air Outlet Considerations](#) (General)
- [L-8 Appearance Options](#) (General)



- [Firebox Subjects for L-8 Inserts](#) (General)
- [Direct Connection Considerations for Inserts](#) (General)
- [L-8 Fireplace Insert Installation](#) (Models)
- [L-8 Fireplace Insert Arch-Top Options](#) (General)
- [L-8 Fireplace Insert Blower Choices](#) (General)
- [L-8 Fireplace Insert Automatic Blower Control](#) (General)
- [L-8 Heat Exchanger Design](#) (General)
- [L-8 Left-Right Choices](#) (General)
- [Oversized L-8 Unit Options](#) (General)
- 
- **Yet More Subjects**
- [Materials / Construction](#) (General)
- [NewsWeek Feature Article](#) (General)
- [Non-Air-Tight Operation of a JUCA](#) (General)
- [Non-Air-Tight Synergistic Operation of a JUCA](#)
- [NON-AIR-TIGHT vs AIR-TIGHT](#) (General)
- [Options](#) (Models)
- [Outside Combustion Air](#) (General)
- [Outside Make-Up Air](#) (General)
- [Owner Business Opportunities](#) (General)
- [Mother Earth News Article](#) (Models)
- [Today Show Appearance / POTBELLY Display](#) (Models)
- [Opportunity Knocks?](#) (General)
- [Performance Guarantee](#)
- [Program Diskette Notes](#)
- [Secondary Combustion Air](#) (General)
- [Semi-Technical Description](#) (General)
- [The Staff At JUCA](#) (General)
- [Coal Burning](#)
- [Slider Draft Control](#) (General)
- [Flexibility of Custom Built Products](#)
- [Left-Right Choices](#) (General)
- [Comparing a JUCA with a Competing Woodstove](#)
- [Limited Warrantee](#)
- [Synergistically Designed System](#) (General)
- [The Argument Against Airtight Designs](#) (General)
- [Ash-Dump Provisions](#) (General)
- [Air-Limited Operation of a JUCA](#) (General)

- [Base Construction for C-model Units](#) (General)
  - [Where to Find a JUCA](#)
  - [JUCA Replacement Parts](#) (General)
  - [Brief Installation Guide](#)
  - [Diskette Notes](#)
  - [Y2K Millennium Concerns\(Limited\)](#)
- 
- 

The JUCA Home Page is at: <http://mb-soft.com/juca/index.html>

E-mail to: [JUCA@mb-soft.com](mailto:JUCA@mb-soft.com)

# URGENT!

(this is meant as dark humor!)

We just read a couple articles in the industry trade magazines, that very strongly emphasized that sellers of ANY products should attempt to inspire urgency in customers, because they will not buy your product otherwise.

One of the articles emphasized that a customer's fear and greed should be manipulated to cause him to buy your product. We're supposed to create a "buying frenzy". Tell them about your "Going out of business sale" or some other disaster to inspire their greed in wanting to take advantage of you. Create fear by harping on things like the Y2K "the sky is falling" images, and fears of massive power outages or fuel source disruptions.

Then, the article stated that customers have very limited attention spans, and that you have to push, push, push them to buy your product, today, NOW!

The other article explained that you should act in whatever ways necessary to get the customers to like you, because then they will trust you, and then you can get them to be generous to you, by buying your product. The article continued with implications that you should play on their sympathy or anything else, to make the sale. And that you have to be aggressive in asking the customer to buy now, today.

## WOW!!

Doesn't anyone care about what's best for the customer any more?? I hope you noticed that that "expert guidance" never referred to whether the specific product was actually any good, or actually suitable to a customer's needs, because that is apparently irrelevant today!

Is this REALLY the way that sellers envision their customers? As a lower form of life that must be manipulated to cause them to buy a product? If so, that's a really sad statement on our society!

We have long known that there were SOME salespeople who acted this way, but to find out that they are now being universally TAUGHT such things?!?! Don't people start suspecting anarchist plots when such things are found???

I hope these concepts might cross your mind the next time you're in a big store talking to a salesperson. There is apparently a good chance that that person was trained to "manipulate" you and to treat you like you don't have a brain! But just smile, because there isn't a lot we can do about the way American companies do business! And then they wonder why we are so cynical

about their offers to give us millions of dollars and free cars and free everything. Oh, did we mention out that we just doubled the prices of all JUCA products, but for YOU, we're giving a HUGE 50% discount? What a joke!

A few of those companies even feel that they are being above-board and ethical. There actually ARE people who win \$10 million just for buying some magazines. But the company might point out that you are at least thirty times as likely to be killed by lightning than to win that money. So, in a technical sense, they ARE being truthful, but they are still attempting to mislead customers. Isn't that some category of deception???

---

Well, we have NEVER acted like that, and don't intend to start now. We believe that a superior product should be able to sell itself, if an intelligent customer is given sufficient accurate information on which to make a decision.

Of the 25,000+ JUCAs sold over the years, there are probably only a handful where our personnel have ever even nudged a sale along! In general, we are a remarkably patient bunch. Sometimes, customers mull over a decision for YEARS before deciding to get a JUCA! We don't see this as a problem. If and when they ever get to a point of needing one of our products, we expect to be here to make it for them!

This web-site has well over 1,000 files in it. Hundreds of specific subject presentations are offered, to help inform a potential customer about whatever aspects and subjects are important to him or her. But, we're pretty sure that NONE of the pages have any reference to trying to get you to actually BUY one! We don't think it's necessary, or even appropriate, to push a customer to make a purchase. We credit our customers with intelligence to be able to judge for themselves whether they actually should buy a JUCA.

We find dark humor in the fact that an occasional customer clearly expects us to make the moves to attempt to close a sale, and that we just don't do that. If there is enough uncertainty in their mind that they need an outsider (and, probably a BIASED outsider, at that!) to push them to make a purchase, then we don't believe it's our place to do the pushing. Sometimes customers like that just walk away, looking stunned. I remember a guy once, whose pocket was clearly packed with a bunch of dollar bills ready to pay for a JUCA, walked away like that, after we didn't push him to buy it. After he left, a salesman friend of ours, who had happened by and witnessed the situation, was literally shrieking at why we didn't try to "close" the sale because the guy clearly wanted and expected to buy one. He probably had some good points. We probably induced some unnecessary stress in that customer, in wondering if we doubted our own products, since we didn't seem interested in "pushing" them! (A few weeks later, he came back and bought one!)

We can't even give you the excuse of an impending price increase! In our 28 years of making and selling JUCAs, we have only ever had 6 price increases, and the two last ones were in 1989 and

2000! Imagine how long it will be before we have another!

SOOOOOOOO, take your time, read all the stuff you want, not just from our site, but from all available sources. You will probably get some quite diverse points of view, since each product vendor tends to be very biased in what they tell you, to try to make sure you buy their stuff. I mean, this IS America! You've probably already noted that we have tried to avoid that sort of thing, because, as far as we're concerned, the CUSTOMER'S needs are paramount, even if it means their not getting a JUCA after having learned from our site. (Except people who try to steal the JUCA design! We REALLY don't like that!)

Digest all of what you learn, and then make the best decision FOR YOU and your circumstances. As long as you do that, and if you can benefit from our web-site, then we have done our job, whatever your decision is. If it happens to be to buy a JUCA, cool! If not, almost as cool! Surprisingly enough, there actually ARE decent competitors out there, and for certain applications, like heating one or two rooms, some may be perfect. Only you can judge that. In our opinion, the "good" products out there seem to be awfully expensive, but this is America, and there's a Free Market!

Modern society, and modern business, have clearly lost some valuable traits from the way they SHOULD be. (That's an opinion!) But just because everyone else behaves in certain ways, we don't think it means WE have to. We prefer to have the CUSTOMER'S needs at the center of our efforts rather than concerns about sell, sell, sell!

Oh! Let's see! We should now have the hypnosis section! Please stare at the following word for an hour or so:

This probably comes across as a cynical attitude about American business. We hope that's not so! We are proud of America and the American approaches to business, which have been instrumental in enabling our country to grow to what we are today. But, if businesses (or society) is to ever remember earlier ethics and principles and morals, it is probably helpful if there are some examples of companies that try to behave properly. That's all we try to do. Are we perfect? Not EVEN close!!! But we try!

Considering the modern business environment, we are definitely an unusual company! The sad thing is that, a hundred years ago, no one would have noticed anything unusual about us! Sad, isn't it?

---

The JUCA Home Page is at: <http://mb-soft.com/juca/index.html>

E-mail to: [JUCAurgent@mb-soft.com](mailto:JUCAurgent@mb-soft.com)

This Web-Site was designed by: MB Software

E-mail to: MB at [MBSoft@mb-soft.com](mailto:MBSoft@mb-soft.com)

# So Ya Wanna Know How a JUCA Works?!

So here's a JUCA Model B-3B. How's it work?

Well, we can't tell much just lookin' at it. Fortunately, we have thoughtfully provided you with a pair of X-Ray glasses (they're somewhere near the mouse pad) to let you have Superman's vision. [Please Click Here](#) to use them.

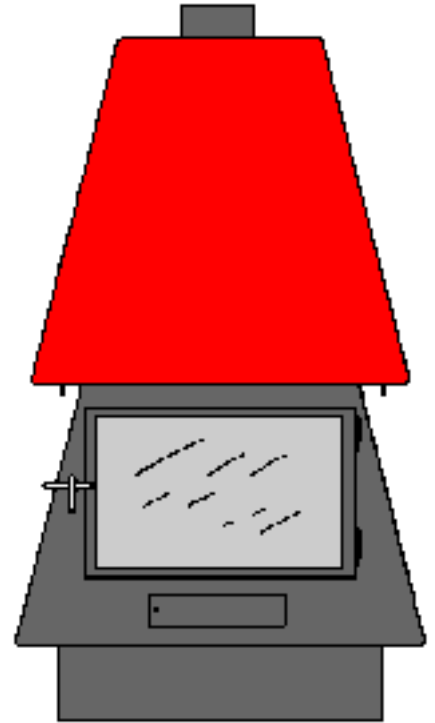

---

[To Go Forward to NEXT page](#)

---

E-mail to: [JUCAworks@mb-soft.com](mailto:JUCAworks@mb-soft.com)

The JUCA Home Page is at: <http://mb-soft.com/juca/index.html>

This Web-Site was designed by: MB Software

E-mail to: MB at [MBSoft@mb-soft.com](mailto:MBSoft@mb-soft.com)

# New York Hall of Science POTBELLY Exhibit

Our JUCA unit wound up being featured on NBC's **Today Show** in a very peculiar way. As best as we can re-construct it, it happened as follows.

One of our wood-burners wound up in this Potbelly exhibition that was put on by the New York Hall of Science in Flushing, NY (near New York City). We have no idea how it was chosen to be exhibited. We certainly didn't approach them or pay to have it exhibited or even give them a unit. Shoot! We had never even HEARD of the New York Hall of Science at the time.

They must have bought one from one of the nearly 300 dealers we had Nationally at the time. WE were certainly never told about it or even that there was going to BE an exhibit of Wood-Burning Technology. Of course, we're proud to have been considered one of a very few products with advancements so great as to show them in such an exhibit. But we didn't even know about it until after the fact. And even that was kind of weird.

It turns out that the NBC **Today Show** did a live broadcast from the site of the exhibit on National TV. As we understand it, the reporter stood for quite a while next to our JUCA, probably because it was by far the physically biggest product exhibited. (Some of the other products would have fit inside our firebox!)

A number of owners of JUCAs saw that program. (None of us did!) Many called us after the show to congratulate us on such a publicity coup! We had no idea what they were talking about!





Eventually, we came to understand that the Today Show had our product on (but apparently without identifying it as ours, so it had effectively no marketing effect!) And only THEN we came to find out that it was at the New York Hall of Science. (Wherever that was!) We managed to find a phone number for that museum, and they kindly sent us the two photographs you see here. You now know as much as we do about the whole matter!



---

New York Hall of Science Potbelly Exhibition, Oct 10, 1980 to Jan 1981.

---

Soon after this Exhibition began, the New York Times apparently published an article on the JUCA products on Nov 13, 1980. We never saw the article, so we have no idea what it said.

The Today Show feature story was apparently aired live on November 8, 1979, but, again, we didn't ever see it or even know it was going to happen!

---

The JUCA Home Page is at: <http://mb-soft.com/juca/index.html>

# Computer-Designed Stove

(text of the Newsweek New Products Guide article)

The JUCA stove, manufactured by JUCA, Inc of LaPorte, Ind, incorporates an advanced heat exchange system in which the temperature of the air increases as it circulates through sequentially arranged exchangers.

Its double-decked A-frame construction makes it look unlike any other wood-burning stove. But the most extraordinary feature of the JUCA stove, designed by J----- of JUCA, Inc, LaPorte, Ind, is not something you can see. A computer model was used to maximize the stove's combustion efficiency. The result is a wood-burning stove that is at least 80 per cent efficient. Most wood-burning stoves are in the efficiency range from 30 to 50 per cent.

The computer system was configured specifically for modeling combustion processes, and J----- programmed 18 kilobytes of computer memory with equations necessary to determine the optimum design and operation of the stove. The computer performs 2 million operations per second and each program can take as long as twenty minutes to process. "We've known about fire ever since the cavemen," says J-----, who was trained as a Nuclear Physicist. "But until the last ten years, not much was really known about the variables of combustion. The mathematics are almost too complicated to analyze any way except by computer."

The computer is also used for jobs as relatively simple as cutting the maximum number of stove pieces from a single piece of sheet metal, minimizing the number of welds and processing customer questionnaires to determine the most appropriate JUCA stove (and the projected fuel savings) for each user.

## STATE OF THE ART

### Computer-Designed Stove

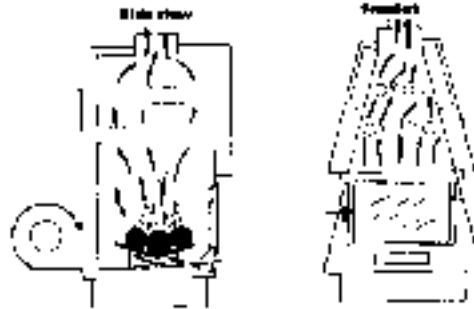

The JUCA stove manufactured by JUCA, Inc. of LaPorte, Ind, looks novel as an advanced heat exchange system in which the temperature of the air increases as it circulates through sequentially arranged exchangers.

The double-decked A-frame wood-burning stove that looks unlike any other wood-burning stove, designed by J----- of JUCA, Inc, LaPorte, Ind, is not something you can see. A computer model was used to maximize the stove's combustion efficiency. The result is a wood-burning stove that is at least 80 per cent efficient. Most wood-burning stoves are in the efficiency range from 30 to 50 per cent.

The computer system was configured specifically for modeling combustion processes, and J----- programmed 18 kilobytes of computer memory with equations necessary to determine the optimum design and operation of the stove. The computer performs 2 million operations per second and each program can take as long as twenty minutes to process. "We've known about fire ever since the cavemen," says J-----, who was trained as a Nuclear Physicist. "But until the last ten years, not much was really known about the variables of combustion. The mathematics are almost too complicated to analyze any way except by computer."

### Quartz-Element Radiant Heaters

Quartz heaters are a new type of portable unit that can be used in a variety of situations. They are made of quartz and are about the size of a small space heater. They are made of quartz and are about the size of a small space heater. They are made of quartz and are about the size of a small space heater.

### Quartz heaters cost less to operate and can be safer and less bothersome than other portable units.

Quartz heaters are a new type of portable unit that can be used in a variety of situations. They are made of quartz and are about the size of a small space heater. They are made of quartz and are about the size of a small space heater.

The heart of the JUCA stove is a sophisticated heat-exchanger system made up of sequentially arranged exchangers. The first rear exchanger draws in cool air that is circulated through the rest of the series until it is boosted to a much higher temperature. The various angles and surfaces used to circulate the heat more closely resemble a gas- or coal-burning steam boiler than a wood stove, says the designer. Unlike an "air-tight" stove, the JUCA stove allows in enough oxygen to incorporate the carbon monoxide gas into the combustion process. This eliminates the need for a secondary air system, while also minimizing the amount of creosote build-up. The JUCA also incorporates a forced-air blower (a number of sizes are available) that directs the heat down to the floor, so that it rises evenly throughout a room. But the JUCA was not designed only to heat single rooms. Ideally, it can be used as a central heating system, and has outlets that connect directly to the hot-air ducts in a house.

Price: from about \$524 to about \$909.

---

**A nice article in Newsweek! Some very minor errors existed in the reporter's understanding of our technological product, but he got the basic ideas down right. We bet you wish we still had the 1981 prices mentioned there! Actually, they're only about double that now. Few other products could say that! (My loaded 1980 TransAm was \$8,000; now they're well over \$20,000. A pizza was \$1.90; now it's \$12!)**

---

This appeared in the Newsweek New Products Guide in March 1981.

The JUCA Home Page is at: <http://mb-soft.com/juca/index.html>

# SOMETHING NEW IN WOOD HEAT

(Mother Earth News Magazine article text)

There are now an awful lot of good wood-fired furnaces, cookstoves, space heaters, etc., on the market ... some of the best are advertised in MOTHER's pages ... and we ain't gonna take any sides in the argument about which is the very best of all.

Every so often, however, someone does come along with a new twist or two on an old basic idea and -for that reason alone-we like to call your attention to his or her novel new approach. And the fellow we'd like you to know about right here is a stove builder from Indiana named J-----.

Nope. J----- didn't invent the burning of wood for heat nor the idea of doing it inside a stove made of welded-up steel plates. It's the design of his space heater that puts J----- in our "we'd like you to know about" category.

What J----- has done, you see, is take the freestanding fireplace idea (which was pretty good to start with) ... and add a few twists of his own (to make it really great).

J----- started by putting fireproof glass across the front of the wood-burner (and, in some cases, around three of its four sides) so you can have a completely enclosed blaze ... yet still see and enjoy the flame! Then he put a tent-shaped hood up over the fire chamber, installed some short lengths of three-inch pipe in the cone's top, and connected them to a sleeve that runs up the back and around the sides of the furnace.

"This makes it possible," J----- explains, "to put a small blower on the unit and force air through the sleeve. The air, of course, is heated as it passes over the walls of the fireplace. And it's heated even more as it's blown through the pipes, down through another sleeve, and onto the floor. Or, if you like, you can hook ducts to the second sleeve and direct the hot air to any part of the house just as with a conventional furnace."

**SOMETHING NEW IN WOOD HEAT**

second sleeve and direct the hot air to any part of the house ... just as with a conventional furnace.

Result: (1) a 80% efficient wood burner with (2) a completely enclosed fire that has (3) real curtains and which (4) operates automatically while it (5) burns logs up to 24 inches long and (6) heats houses with at least a 2000 square foot of floor space (7) without any extra pipes, screens, or ducts.

And that's why Carl Johnson's line of "Stone Super-Fireplaces" - which start at \$469.00 - are designed to pay for themselves in a single heating season. (And, yes, the steel plates used in the construction of the units are so heavy that the freestanding furnaces should last a good many years.)

And as MOTHER knows, Carl Johnson and his partners, he's brought to the ready-revised-art of burning wood for space heat. If you'd like to know more about his extremely efficient furnaces, write to: J-----, Dept. ME, P.O. Box 88, North Jackson, Indiana 46782.

There are now an awful lot of good wood-fired furnaces, cookstoves, space heaters, etc., on the market ... some of the best are advertised in MOTHER's pages ... and we ain't gonna take any sides in the argument about which is the very best of all.

Every so often, however, someone does come along with a new twist or two on an old basic idea and -for that reason alone-we like to call your attention to his or her novel new approach. And the fellow we'd like you to know about right here is a stove builder from Indiana named J-----.

Nope. Carl didn't invent the burning of wood for heat nor the idea of doing it inside a stove made of welded-up steel plates. It's the design of his space heater that puts Carl in our "we'd like you to know about" category.

And that's why Carl Johnson's line of "Stone Super-Fireplaces" - which start at \$469.00 - are designed to pay for themselves in a single heating season. (And, yes, the steel plates used in the construction of the units are so heavy that the freestanding furnaces should last a good many years.)

And as MOTHER knows, Carl Johnson and his partners, he's brought to the ready-revised-art of burning wood for space heat. If you'd like to know more about his extremely efficient furnaces, write to: J-----, Dept. ME, P.O. Box 88, North Jackson, Indiana 46782.

**New!**

**"Let's reach for the sun"**

AN EXCITING BOOK OF 30 ORIGINAL HOME DESIGNS... EACH HEATED BY THE SUN.

This 120-page book is a treasure chest from the Lake Superior region - and for \$5.95 includes 30 designs of its most exciting ideas - in wood-burner energy.

It has 120 pages, 120-page book, GreenTime Outdoor Living. The book is a treasure chest from the Lake Superior region - and for \$5.95 includes 30 designs of its most exciting ideas - in wood-burner energy.

There are a variety of other wood-burner plans, stoves and designs of 30 home stoves ... and full price is \$9.95.

This is a limited edition printing. As such, supply is limited.

**SPACE PLAN DESIGNER, INC.**  
P.O. Box 4420 • Waterloo, Wisconsin 53185

Name \_\_\_\_\_  
Address \_\_\_\_\_  
City \_\_\_\_\_ State \_\_\_\_\_ Zip \_\_\_\_\_

Send me \_\_\_\_\_ for \$5.95 (plus \$2.00 shipping and handling fee).

10/19 AUGUST 1978

Result: [1] an 80% efficient wood-burner with [2] a completely enclosed but [3] completely visible fire that has [4] cool surfaces and which [5] operates automatically while it [6] burns logs up to 24 inches long and [7] heats houses with as much as 2,000 square feet of floor space [8] without any cold spots, corners, or drafts.

And that's why J-----'s line of "JUCA Super-Fireplaces" which start at \$408.60 are designed to pay for themselves in a single heating season. (And, yes, the steel plates used in the construction of the units are so heavy that the freestanding furnaces should last a good many years.)

And so MOTHER salutes J----- son and the advances he's brought to the newly rediscovered art of burning wood for space heat. If you'd like to know more about his extremely efficient furnaces, write to: JUCA, Inc., Dept. ME, P.O. Box -----, Indiana.

---

Mother Earth News JULY/AUGUST 1978 p.63

---

We had been merrily just making a few JUCAs locally up to that point. We have no idea how Mother Earth News ever found out about us. We had never advertised ANYWHERE! Their reporter interviewed the originator of the JUCA design. (We have edited his name in the reprinted text above, because he doesn't really like publicity or fame.)

We also edited the address given in that article, because it is no longer a valid address. We DID leave in the reference to the 1978 prices! In today's dollars, that would be over \$2,000, so we have actually been able to LOWER the cost of modern JUCAs, even while doubling the thickness of all the firebox walls, and adding many other small improvements over the years.

---

The JUCA Home Page is at: <http://mb-soft.com/juca/index.html>

# Bad News

**JUCA has found it necessary to stop production of its products.** If and when JUCA products are again to be available, it will be due to some separate company manufacturing them for JUCA. Sorry!

---

We hope you clicked here before you got too intrigued with the JUCAs. Circumstances have made it necessary to tremendously restrict the availability of JUCA units. I know! This sounds weird! A company is supposed to want infinite numbers of orders, but we're different.

After we stopped all advertising in 1981, we went for 16 years with enough orders to keep us occupied. Without any advertising, we have never been exactly sure of where those buyers actually came from, but we have always assumed that they were friends or neighbors of people who already had JUCAs. Since they had already seen one working, and were apparently very impressed, they generally had few questions, and they would usually order the exact same kind of unit that the person they knew had earlier bought. We were keeping busy and we were providing our units for the people who somehow found us.

Then, in early 1997, we created a web-site, not really to sell any products (which everyone at the time said was impossible anyway), but rather to provide a lot of extra information for people who already had JUCAs but weren't getting everything out of them that they could, and for their friends and neighbors, like before. There was no intention or expectation that we'd ever sell even one unit through the internet, except in assisting that earlier mode that had always worked so well for us.

Well, for whatever reasons, our web-site created TOO MUCH interest! In the Fall of 1998 and 1999, we also had an assortment of complications that greatly reduced our production capability. By the Fall of 2000, we had removed nearly all of the references to our phone or our physical address, and a number of other things, to try to reduce the number of inquiries. We even told the Better Business Bureau that we were closed, because we figured that a lot of people (should) check there before considering making a fairly large purchase, and we thought that would 'scare away' a lot of potential customers. Those things helped a little, but the Internet is incredibly huge, and enormous numbers of people still continue to explore the JUCA site.

For the past several years, there have consistently been about **ten thousand people visit the JUCA web-site every week!** And many of them apparently like what they see! And we LIKE being a small company, which custom-builds each and every product, which is extremely time-consuming. From 1973 on, we had always enjoyed knowing that the extremely high efficiency and high performance JUCA units all went to (generally rural) people who really NEEDED to save on their heating bills. But the presence on the Internet changed all that. We soon noticed that more than half of the custom-built JUCAs being made were clearly not remotely going to be used to save the owners money on heating bills. We found it very frustrating to spend the limited available

production time in building custom-built units that would rarely be used, while people who actually NEEDED to save money by burning wood were delayed in doing so.

We eventually added some text to our [Production Schedule](#) info to tell people that we would give very low scheduling priority to units going to (a) very southerly climates [where JUCA's great heating ability is not needed]; (b) people who needed a custom firebox to match some specific mantel (for aesthetic purposes alone); (c) apparently very wealthy people who were building incredibly huge and expensive homes and who apparently wouldn't need to save on their heating bills and would probably rarely use a JUCA for more than having a pretty fire!; (d) people who just wanted a shiny new toy [to brag to neighbors about]. In addition, with very large numbers of people visiting the JUCA web-site, it began to be clear that it was very unlikely that we could possibly build enough JUCAs for so many diverse potential customers! We found it necessary to stop even discussing potential orders entirely on a dozen of our model lines, including the very popular L-8 Fireplace Insert, for at least two years, and now MUCH longer. These things helped, but it seems that some potential JUCA buyers find this 'rarity' to be even MORE desirable, and want one even more!

No, don't get us wrong! We appreciate the compliment of so many people wanting our products. It's just that we were once a fairly big company (briefly 4th largest woodstove manufacturer in the US, long ago), and we like being small a WHOLE lot better.

For a more complete description of all these things, and the 'whys', see the link above. But the result is, that we see it necessary to try a much more drastic step. In an effort at trying to follow our pre-internet mode (where we did not advertise at all for 16 years!), we next tried ONLY accepting orders from people who already have JUCAs or their friends or neighbors who could specifically identify them. Our records show many thousands of the earlier JUCA buyers, and we intend to check that list related to any new potential order.

Is this goofy, or WHAT?

It's even goofier what the response was! We got very large numbers of attempted orders who would make a vague reference to "John Smith" or some other name, who allegedly owned a JUCA. Such people must not have noticed that we consider ethics to be a big thing! Outright lying is definitely not a way to impress us!

The same effect happened regarding at least 700 e-mails we received that requested getting a JUCA. These e-mails were surprisingly similar. Usually, at least one of the family had cancer. The father had lost his job and his unemployment was running out. They generally had between six and ten children. But in every case, all of their worldly cares would have been solved if they could JUST get a JUCA!

The troublesome thing is that one or two of those 700+ notes might have actually been true! But it

seemed that EVERYONE was making up tragic tales, in order to "cut in line" to get a JUCA.

Is all this not the weirdest thing you have ever heard? Even we agree! But, between 1999 and 2002, we did everything we could think of to limit the interest in and demand for the JUCA units, and nothing worked. In some cases, it's clear that the effect has been opposite! Sensing a 'rare' product, some people become even more aggressive at wanting one! Ah, human nature!

The only remaining alternative that we can think of is to entirely remove the JUCA site from the Internet. That should certainly do it. But we think that our site includes a LOT of informative material in its 1,000 pages, and we think that that information should remain available, as a public service. Given these current circumstances, a number of people have sent in e-mail notes to thank us for presenting so much honest information on wood burning and related subjects. Many have said that they felt more prepared to go into a local fireplace shop to discuss some competing product, and they appreciated the info.

So, apologies to the many people who are going to be angry at us because we cannot provide products for them. We tried a lot of approaches in those three years, and the Internet just seems too big!

You have just attempted to interact with one of the most unusual companies anywhere! But our hearts are good!

There is one additional reason that we want to leave the JUCA site up on the Internet. Here we have a product where we have had to turn away over \$4 million of business in each of the last several years! We still have hope that such people might be able to get a JUCA. But only if some OTHER manufacturer comes along and wants to join forces with us! Even though this seems like a good idea, we have already been approached by eight such prospective manufacturers. In every case so far, once they have fully been taught the complex construction procedures, they have all just disappeared! Each of them had apparently decided that they were too complicated to build! This actually was a GOOD thing for most of JUCA's existence, because it always kept competitors from ever starting to build and sell JUCA-clones. But now it is a big problem!

Here is a footnote: On an entirely different subject, if you are a really curious person, you might go to the very bottom of the main JUCA presentation page to a link there, and then go down near the bottom of next page, to explore a number of links there. Eventually, you can discover another important reason why JUCA is not driven to become a giant manufacturing company!

---

The JUCA Home Page is at: <http://mb-soft.com/juca/index.html>



E-mail to: [JUCAbadnews@mb-soft.com](mailto:JUCAbadnews@mb-soft.com)

# JUCA Built-In Fireplace Furnaces

Think of having a completely normal-looking built-in fireplace with all the atmosphere it offers; at the same time heating the entire house with wood! You can enjoy the fire through large normal fireplace glass doors while the F-9A heats the entire house! Since the huge firebox can take giant pieces of wood, you get long, even, constant heating just like with a regular furnace. You just don't have to pay for gas, oil, or electricity! And the unit price is only **about \$1,400!**



The appearance is **EXACTLY** that of a regular fireplace with brass doors. There is a hidden 4" offset in front of the main body to allow space for full thickness facebrick to be the facing of the fireplace. This allows maximum flexibility for you in your choice of facing materials, including brick, stone, veneer brick, ceramic tile, marble, limestone, etc. The firebox floor is lined with castable firebrick. Our standard 465 cfm blower is automatic and very effective. Optional blowers are even stronger, to enable heating a whole house through a duct system. Blower is 115 volt. Normally, the blower is mounted hidden in the wall alongside the fireplace, but it can be remotely located in a basement or elsewhere.

[For a better view of the JUCA F-9A](#)

## Gas Burning

When the JUCA F-9A is used with a 24" set of gas logs, the appearance is exactly that while using wood. The enjoyment of watching the flickering fire through the brass doors is wonderful. While this is happening, the 90,000 Btu/hr gas-log burner is creating enough heat, that is captured by the sophisticated JUCA heat exchanger system, to be heating the whole house! A variety of log styles are even available, from Mountain Oak to Twisted Cypress to White Birch. Various accessory control systems can use a wall thermostat to cycle the burner on and off like a gas furnace or be controlled by a handheld remote control. The automatic wall-thermostat controlled operation of the gas logs' fire cycling on and off is a popular option when burning gas, so that the JUCA fireplace can act as the house's central heating system!

It's great to have this mode of operation while gas prices are reasonable while still having the capability of heating the whole house with wood if something silly happens again in the Mideast. The change only takes a minute or two. The best of both worlds!

A unique advantage of JUCA's non-airtight design is that, whether using wood as the fuel or gas logs, you can open the Bi-Fold Brass Doors to roast marshmallows. All the while, it's still heating

the whole house! The JUCA F-9A still works extremely well, even with its doors open!

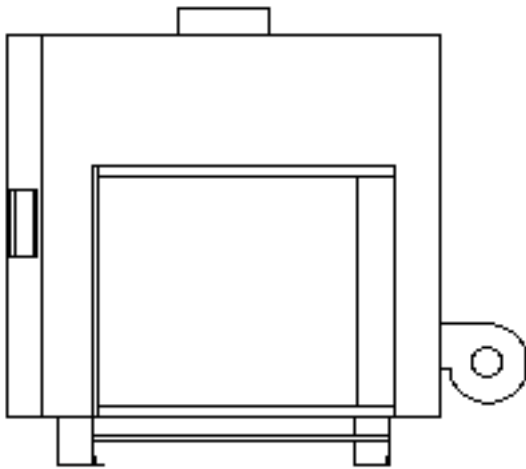

The rotating **JUCA Model F-9A** at left shows some of its features.

On the front is the **large** opening of the huge firebox (brass doors removed for clarity). The (included) **door assembly** has a **draft control** for air for the fire.

On one side of the body is the **(Standard) blower** ; on the opposite side is the **8" by 16" warm air outlet** (to feed into ducts and/or to **warm air registers** in the room). An **automatic blower control** has a temperature probe in the warm air chamber there.

Notice the offset of the door assembly to the main body (we call it the "snout") that allows space for full thickness facebrick everywhere on the facing. Also note the heat baffle and air chambers below the firebox.

The entire firebox is surrounded by heat exchange chambers, to capture radiant heat from the fire inside. Not visible are the tubular heat exchangers bridging across inside above the fire, to capture convective heat from the smoke.

The JUCA F-9A Series is intended to allow maximum flexibility in accomplishing a desired appearance in an installation. If the homeowner wants a rugged fieldstone faced fireplace, an F-9A is perfect. If the desired appearance is that of an 18th Century Rumsford traditional fireplace surrounded by an ornate mantel, the JUCA F-9A is again perfect. Ditto for a French Provincial treatment or a Hyper-Modern motif.

JUCA's desire to supply custom sized or styled units makes all this practical. YOU just specify the required width, height, or depth (if you feel our standard sized F-9A is inappropriate for your application.)

If you're the type considering a Hyper-Modern motif, you certainly must have liked the photo of our Wedge-Shaped Fireplace Door-Set. We truly are capable of creating virtually any appearance you need.

With a JUCA, you get remarkably even, comfortable, long lasting heat everywhere in your house. You can eliminate your regular heating fuel bill. It feels great to carry wood to your JUCA knowing that each armload saves you \$2.00 or more on your heating bill. There are no cold drafts, even at floor level. The built-in computer-assisted-design heat exchanger is so efficient that you get more usable heat with less wood burned.

While heating fuel prices have been low, many people have bought JUCA F-9As and installed (automatic wall-thermostat controlled) gas logs. They can heat the house using our JUCA as a 140,000 Btu/hr gas furnace. (Gas log ratings often limit this to 90,000 Btu/hr, but that's still usually enough to entirely heat most houses.) When fuel prices go through the roof (and they will) it can easily be converted back to wood in under 2 minutes! The best of both worlds! You can't even tell the difference at the house's warm air registers when you change from one to the other. The F-9 has been safety tested and approved to UL Standards.

## Model F-9A

The brass bifold doors make the appearance **exactly** like a regular built-in fireplace. The only difference is that it can heat the whole house with wood and eliminate your heating bill! And there are actually over 2,000 different appearances available! Including **Arch-Top appearances** which have been very popular in recent years.

## 'R' OPTION

If a utility room or garage is behind the fireplace, this option would allow you to be able to feed the fire from the back through a steel rear feed door (or the regular way from the room).

## 'X' OPTION

This is a double-sided fireplace version of the F-9A. If your application involves a see-through or back-to-back fireplaces, consider the X- option on a JUCA F-9A model. Normal thru-the-wall depth is 30" (but, as in everything else, we're flexible on it!)

You have a lot of input on such a unit. If you want one side to be an Arch-Top and the other (normal) Rectangular, and if you want it 27" deep, there's little or no extra charge!

## APPEARANCE OPTIONS

Door Assembly appearance. We offer over 2,000 different door facing assemblies. Traditional

framed or unframed clearview; antique or polished brass, black, copper, nickel, chrome, pewter, real marble, or combination finishes; plated finish or solid brass; bi-fold (4 panel) doors or cabinet-style twin doors; even arch-top designs; very plain to very ornate.

## SIZE OPTIONS

We consider the most popular size of fireplace in America, the so-called 36" by 28", to be our standard size. **HOWEVER!** We can easily adjust any of the dimensions to fit an application. Our normal firebox is 24" deep, much deeper than the common 16-18". (We like to be able to put HUGE amounts of wood inside! For people who want shallower fireboxes (we call them pancake units), there is no extra charge. Similarly, we normally put a 4" snout on the F-9A to provide for the thickness of regular facebrick. When people intend to face their unit with stones from their farm fields, we have made snouts as large as 10" deep. Veneer brick facing can allow snouts as small as 1" if space is tight and firebox depth is less important. (Nearly everyone gets the regular 4" snout.)

Width is also buyer selectable. For each 6" extra width over our regular width F-9A, add \$80 (mostly for material.) We make quite a few 42", some 48", a few 54", and occasional units up to 78" wide. If you're going above 42" wide or you have a rather short chimney, use the [Chimney Design Calculation Program](#) to confirm appropriate chimney size and performance. Or [check this guidance page](#).

Opening Height is also buyer selectable. If higher than the regular 28", then use (319) as above and contact us for price differential. Or [check here](#).

Arch-Top units of ANY oversize should use (319) to make sure there is extra chimney capacity for that size unit. Or [check here](#).

## Specifications

.	F-9A	F-9AX	F-9AR
RatedOut(Btu/hr)	<b>140,000</b>	100,000	125,000
Log Length:	<b>24 in</b>	24 in	24 in
H/W/D (inches):	47x43x26	47x43x30	47x43x27

Flue Size:	10 in	10 in	10 in
Firebox:	<b>12.3 cu ft</b>	15.4 cu ft	12.3 cu ft
Firebox H/W/D:	26x34x24	26x34x30	26x34x24
Door Ass'y Size:	<b>36" x 28"</b>	36" x 28"	36" x 28"
Expcted BurnTime	<b>10-11 hr</b>	7-11 hr	10-11 hr
Blower (cfm):	465 to 2550	465 to 2550	465 to 2550
Duct Outlet:	8" x 16"	8" x 16"	8" x 16"
Weight:	635 lb	545 lb	655 lb
Price:	<b>\$1,389</b> <a href="#">Details</a>	<b>\$1,757</b> <a href="#">Details</a>	\$1,599

---

The JUCA main Web-Site is at: <http://www.mb-soft.com/juca/index.html>

# JUCA Free-Standing Wood/Gas Furnaces

## Model B-3B

### and other sizes of JUCA Free-Standing Stoves

Our most popular free-standing model has proven its ability to completely heat many thousands of homes all across the U.S. for over 20 years. Combining the performance of a wood-burning furnace, the installation convenience and economy of a woodstove, and the fire-viewing of a fireplace, the B-3B is the ultimate in wood-burners. The blower-driven warm air that comes out the adjustable side outlets and/or the duct system seems like it was produced by a gas furnace . . . you can't tell that it wasn't! Safe, comfortable, clean air to evenly heat your house. No cold drafts along the floor. Users often remark that then comfort level with a JUCA is far better than that with gas or oil heat, and they save money, too. With appropriate (optional) blowers, B-3Bs are heating spaces ranging from 400 square feet to over 5,000 square feet in all climate areas of the U.S.A. Clearly the most versatile wood burner on the market. And the best performing. So effective that JUCA **GUARANTEES** that a B-3B can fully heat ANY single-family house in the U.S.A! And very clean burning, too. Reasonably priced, at **about \$1,400!**



[For a better view of the JUCA B-3B](#)

## Gas Burning

When the JUCA B-3B is used with a 24" set of gas logs, the appearance is exactly that while using wood. The enjoyment of watching the flickering fire through the glass door is wonderful. While this is happening, the 90,000 Btu/hr burner is creating enough heat to be heating the whole house! A variety of log styles are even available, from Mountain Oak to Twisted Cypress to White Birch. Various accessory control systems can use a wall thermostat to cycle the burner on and off like a gas furnace or be controlled by a handheld remote control. The automatic operation of the fire cycling on and off is a popular option so that the JUCA fireplace acts as the house's central heating system.

It's great to have this mode of operation while gas prices are reasonable while still having the capability of heating the whole house with wood if something silly happens again in the Mideast.

## The best of both worlds!

Efficient and handsome, the JUCA B-3B will blend in with any decor. The versatility of being able to install it upstairs, downstairs, in an attached garage, or in a cellar; of using it as a room heater, as an add-on furnace, or as a separate furnace; of being able to enjoy the fire through a large glass door (except in model B-3A); make it the best product on the market. Since it has the capability of heating even very large houses, and since the firebox is large enough to take giant pieces of wood, you get long, even, constant heating just like with a regular furnace. You just don't have to pay for the gas, oil, or electricity!

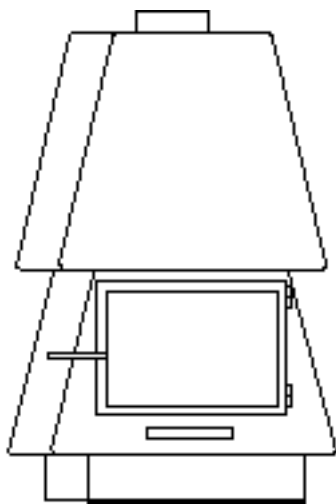

The rotating free-standing **JUCA Model B-3B** at the left shows a number of its features.

On the front is the large door that is nearly all glass , with the slide draft control underneath.

On the back is the (Standard) blower near the bottom, the 8" by 16" warm air outlet (to connect into ducts) near the top, and the automatic blower control assembly to the right.

Less obvious are the adjustable warm air outlets on the sides, under the overhangs about halfway up.

The firebox bottom is lined with castable firebrick. A slide draft control under the door can adjust the fire. Dozens of optional colors are available for the top half to liven up a room; however matte black is standard. Our standard blower is nice and powerful and is automatically controlled by a built in temperature probe. The optional blowers are even stronger (up to 3/4 hp), and one of them is usually necessary when feeding central heating ducts to heat a whole house. Adjustable air outlets on both sides also send warm air out into the room, down along the floor where it does the most good. Our glass doors use high temperature glass, but we also include a metal inner safety panel that slides into place when the unit is unattended (while you're at work or asleep) to make sure large logs can't shift and crash into the glass. We believe that JUCAs are the only glass-doored wood burners with this extra safety feature. Blower is 115 volt.

Wherever a JUCA is installed, you get remarkably even, comfortable, long-lasting heat everywhere in your house. You eliminate your regular heating fuel bill. It feels great to carry wood to your JUCA when you know that each armload saves you about \$2.00 (or more) on your heating



bill. There are no cold drafts, even at floor level. The built-in computer-assisted-design heat exchanger is so efficient that you get more usable heat with less wood burned.

In recent years, gas and oil prices have been tolerable. As long as this situation continues, a set of gas logs may be used inside the JUCA. Then, you get all the performance benefits of the JUCA heat exchangers. You get the coziness of a woodstove. You get the ambiance of watching a fire. (It just doesn't get any better than that!) And when, some day in the future gas or oil shortages occur, you could convert it to using wood in just a couple of minutes.

The units have two adjustable side warm air outlets. All but the K-3 also have a large outlet that can feed a house central heating duct system to send heat to the entire house. Standard color- Matte black, with many optional colors available for the top half; Castable firebrick bottom; The blower turns on and off automatically.

## Model B-3B

Our most popular JUCA, this unit has a large glass door and a huge firebox for using 8" - 9" diameter full logs.

**GUARANTEED TO HEAT YOUR HOUSE.**

## Model B-3A

Identical to the B-3B except that the glass door is replaced by a thick steel door, for installations in cellars or garages where it will not be desirable to see the fire burn.

**GUARANTEED TO HEAT YOUR HOUSE.**

## Model B-3J

A smaller version of the B-3B. The B-3J will still fully heat nearly any normal sized and insulated house, but the firebox is a little smaller which gives slightly shorter burn times; but it takes up less space.

## Model K-3

A smaller yet version of the B-3B that is meant for heating a specific open area without ducts. It operates on a slightly different principle than the other JUCAs and is therefore slightly less efficient. This is the only free-standing JUCA unit that does NOT have provision to feed the house central warm air duct system.

## Specifications

.	<b>B-3B</b>	<b>B-3A</b>	<b>B-3J</b>	<b>K-3</b>
RatedOut(Btu/hr)	<b>122,000</b>	122,000	86,000	65,000
Log Length:	<b>24 in</b>	24 in	20 in	16 in
H/W/D (inches):	53x33x30	53x33x30	45x27x25	36x22x20
Flue Size:	8 in	8 in	6 in	6 in
Firebox:	<b>9.5 cu ft</b>	9.5 cu ft	5.5 cu ft	3.0 cu ft
Door Opening:	<b>21" x 15"</b>	21" x 15"	17" x 12"	14" x 10"
Expcted BurnTime	<b>10-11 hr</b>	10-11 hr	7-8 hr	5-6 hr
Blower (cfm):	465 to 2550	465 to 2550	465 to 1240	465
Duct Outlet:	8" x 16"	8" x 16"	8" x 12"	None
Weight:	490 lb	495 lb	290 lb	220 lb
Price:	<b>\$1,389</b> <a href="#">Details</a>	\$1,339 <a href="#">Details</a>	\$1,199 <a href="#">Details</a>	\$1,199 <a href="#">Details</a>

The JUCA Web-Site is at: <http://www.mb-soft.com/juca/index.html>

# JUCA 3-Glass-Sided Wood/Gas Fireplace Furnaces

Efficient and majestic, the B-3D will blend in with any decor. The combination of the modern tapered shape over large glass areas and the massiveness of personally planned stonework or brickwork surrounding the lower part, makes an impressive statement in the home. The versatility of being able to install it upstairs or downstairs; of using it as a room heater, as an add-on furnace, or as a separate furnace; of being able to enjoy the fire from everywhere through three large glass panels; make it the best product on the market. Since it has the capability of heating even very large houses (since it has a large duct connection outlet to be able to feed warm air into the house's central heating duct system), and since the firebox is large enough to take giant pieces of wood, you get long, even, constant heating just like with a regular furnace. You just don't have to pay for the gas, oil, or electricity! JUCA even **GUARANTEES** that the B-3D can fully heat ANY single-family house in the U.S.A! (After all, the B-3D has a rated output of 180,000 Btu/hr, more than most house central furnaces) (But it can be used at very low heat outputs, too!) All this, at the amazingly low price of **around \$1,900!**



[For a better view of the JUCA B-3D](#)

## Gas Burning

When the JUCA B-3D is used with a 24" set of gas logs, the appearance is exactly that while using wood. The enjoyment of watching the flickering fire through the glass walls is wonderful. While this is happening, the 90,000 Btu/hr gas-log burner (and the JUCA, of course!) is creating enough heat to be heating the whole house! A variety of log styles are even available, from Mountain Oak to Twisted Cypress to White Birch. Various accessory control systems can use a wall thermostat to cycle the burner on and off like a gas furnace or be controlled by a handheld remote control. The automatic operation of the fire cycling on and off is a popular option so that the JUCA fireplace acts as the house's central heating system.

It's great to have this mode of operation while gas prices are reasonable while **STILL** having the capability of heating the whole house with wood if something silly happens again in the Mideast. The change only takes a minute or two. The best of both worlds!

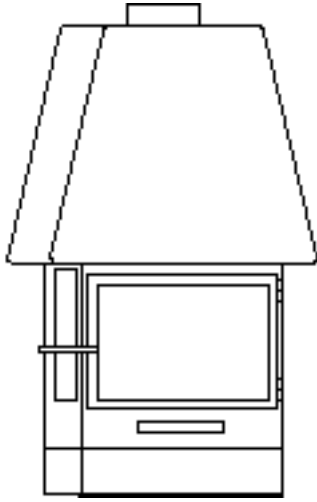

The rotating **JUCA Model B-3N** at left shows some of its features.

On the front is the large door that is nearly all glass , with the slide draft control underneath.

On the sides are more **large glass areas** to view the fire. Less obvious are the adjustable warm air outlets on the sides, under the overhangs, above the glass areas.

On the back is the (Standard) blower near the bottom, the 8" by 16" warm air outlet (to be able to connect into ducts) near the top, and the automatic blower control assembly to the right.

A slide draft control under the door can adjust the fire. Dozens of optional colors are available for the top half to liven up a room; however matte black is standard. Our standard blower is nice and powerful and is automatically controlled by a built in temperature probe. The optional blowers are even stronger (up to 3/4 hp), and one of them is usually necessary when feeding central heating ducts to heat a whole house. Adjustable air outlets on both sides also send warm air out into the room, down along the floor where it does the most good. Our glass door and glass side panels use high temperature glass, but we also include removeable metal inner safety panels that slide into place when the unit is unattended (while you're at work or asleep) to make sure large logs can't shift and crash into the glass. We believe that JUCAs are the only glass-doored wood burners with this extra safety feature. Blower is 115 volt, and most are energy efficient.

Wherever a JUCA is installed, you get remarkably even, comfortable, long-lasting heat everywhere in your room and house. **You can completely eliminate your regular heating fuel bill.** It feels great to carry wood to your JUCA when you know that each armload saves you about \$2.00 (or more) on your heating bill. There are no cold drafts, even at floor level. The built-in computer-assisted-design heat exchanger is so efficient that you get more usable heat with less wood burned.

## Model B-3D

The elegant B-3D fireplace can be the dominant centerpiece of any family room or great room.

This model is our most popular Three-sided-glass model. **Guests are ALWAYS amazed that it is also heating the whole house!**

The B-3D has similar performance (actually even better) than our work horse B-3B, combined with the breathtaking appearance of having glass on three sides for viewing the fire from everywhere in the room. A true conversation starter for a conversation pit!

This beautiful free-standing unit has provision to be able to [feed warm air into the house warm air ducts](#), just like nearly all other JUCA models.

Sometimes, owners arrange for the B-3D to be installed as a "peninsula". This provides for a very simple way of hiding the blower and the duct connection on the back of it. Sometimes, owners arrange instead to have removable "privacy screens" between the B-3D and the rear wall for the same function.

**MODEL B-3D IS [GUARANTEED TO HEAT YOUR HOUSE.](#)**

## Model B-3C

An installed B-3C looks identical to a B-3D. This model does **NOT** include the lower half of the firepit as part of the unit, which includes the firebrick lining of the firebox and several heat baffles and air spaces beneath the firebox floor. (This used to be a very popular approach, and a few contractors still like this type unit because it allows them the flexibility to make more unique [masonry lower portions of the final installation.](#) ) **In other words, the Model B-3C has an open bottom!**

A B-3D has all that heat baffle and multiple air chamber stuff under the firebox so that it can be installed over a wooden sub-floor, where the B-3C Model does not include this - since it has no bottom, it **MUST** be installed on a [totally fireproof masonry base/firepit.](#)

**MODEL B-3C IS [GUARANTEED TO HEAT YOUR HOUSE.](#)**

## Models D-7 and D-3

These are different height versions of the B-3D (shorter and taller). JUCA performance is so great, that the amazingly high ability of the D-3 is pretty much irrelevant for any realistic house. These models should be chosen for aesthetic, height considerations.

## Models C-7 and C-3

These are different height versions of the B-3C (again shorter and taller), again without a bottom.

(See the description in the B-3C description above).

## Models B-3N and B-3JN

These are smaller versions of the three-sided- glass B-3D, for locations with limited space but where you still want to see the fire from all sides.

**Special Custom Free-Standing Fireplaces.** JUCA has also made many specialized units for specific applications. Four-sided-glass units allow looking clear through it! Six-glass-sided and 8-glass-sided units have been made; even an asymmetric 5-sided glass unit was built to match an unusual room. Normally C and D units are free-standing, but there are ways to install them to make them appear built-in as peninsulas or islands.

Any of these units is available in any of [dozens of colors](#) with any of our 6 blowers and/or other custom features, at reasonable prices and is usually shipped in a few weeks! WOW!!

### Specifications

.	B-3D	B-3C	D-3	B-3N	B-3JN
Rated Out-Btu/hr	<b>180,000</b>	180,000	280,000	116,000	77,000
Log Length:	<b>24 in</b>	24 in	24 in	18 in	15 in
H/W/D (inches):	76x41x30	56x41x30	89x41x30	52x31x29	44x27x25
Flue Size:	10 in	10 in	12 in	8 in	6 in
Firebox:	<b>12 cu ft</b>	12 cu ft	14 cu ft	5.5 cu ft	3.5 cu ft
Door Opening:	<b>32" x 14"</b>	32" x 14"	32" x 23"	21" x 15"	17" x 12"
Front Glass:	<b>31" x 13"</b>	31" x 13"	31" x 22"	20" x 14"	16" x 11"

Side Glass:	<b>23" x 17"</b>	23" x 17"	23" x 24"	20" x 14"	16" x 11"
Expcted BurnTime	<b>10-11 hr</b>	10-11 hr	10-11 hr	6-8 hr	5-6 hr
Blower (cfm):	465 to 2550	465 to 2550	465 to 2550	465 to 1460	465 to 1240
Duct Outlet:	8" x 16"	8" x 16"	8" x 16"	8" x 16"	8" x 12"
Weight:	710 lb	460 lb	940 lb	370 lb	250 lb
Warrantee:	<b>FOREVER</b>	FOREVER	FOREVER	10 yrs	5 yrs
Heated Area:	<b>ANY HOUSE G'TEED</b>	ANY HOUSE G'TEED	ANY HOUSE G'TEED	200-1800 sq ft	200-1400 sq ft
Price:	<b>\$1,959</b> <a href="#">Details</a>	<b>\$1,769</b> <a href="#">Details</a>	<b>\$2,509</b> <a href="#">Details</a>	<b>\$1,669</b> <a href="#">Details</a>	<b>\$1,519</b> <a href="#">Details</a>

The JUCA Web-Site is at: <http://www.mb-soft.com/juca/index.html>

# JUCA's Questionnaire for House Analysis

This program will ask you a few questions about your house, and then calculate an approximate Heat Loss Analysis of your home! Then it will recommend which JUCA can totally heat your home! It will suggest which of JUCA's six available blowers (most models) is most appropriate for your specific house.

It calculates how much wood would be needed to **ENTIRELY heat your home** for a whole winter! It even calculates how long it would take for the JUCA to **PAY FOR ITSELF!** (It estimates how much you are likely to save in conventional heating fuel, and it knows the total installed cost of the JUCA installation which it recommends.)

**All of the information it generates is UNIQUE for YOUR INSTALLATION!** Where else could you get all this personalized info? A competing dealer or salesperson is not likely to have the engineering background to do a Heat Loss Analysis for your house! Cool, huh?!

## Questionnaire for House Analysis

**Your Last Name?**

Please select a choice for each of the following 14 questions.

**Please Select a Description of your Climate:**

<b>Very Mild .(1500 deg. days)</b> <b>Mild . . . (3500 deg. days)</b> <b>Moderate . (5500 deg. days)</b> <b>Harsh . . .(7500 deg. days)</b> <b>Very Harsh (9500 deg. days)</b>	<b>OR</b>	<b>Give me Your Zip Code</b>
--------------------------------------------------------------------------------------------------------------------------------------------------------------------------------------------	-----------	----------------------------------



## Your Type of Home?

<b>Apartment</b> <b>Mobile Home</b> <b>Modular Home</b> <b>Ranch Style</b> <b>Two-Story</b> <b>Tri-Level</b>	If your home is not one of these then pick the one that is most similar
-----------------------------------------------------------------------------------------------------------------------------	-------------------------------------------------------------------------

## The General Level of Your Insulation:

<b>None . . .(R=3)</b> <b>Minimal . (R=7)</b> <b>Adequate .(R=11)</b> <b>Good . . .(R=17)</b> <b>Very Good (R=27)</b>	Pick the choice that best describes your home. If your home has unique features, like huge windows, then consider adjusting the choice here as appropriate.
-----------------------------------------------------------------------------------------------------------------------------------	-------------------------------------------------------------------------------------------------------------------------------------------------------------

## Size of Your House?:

<b>Modest . . . . . (700-1000 sq ft)</b> <b>Moderate . . . .(1000-1300 sq ft)</b> <b>Above Average . (1300-1600 sq ft)</b> <b>Large . . . . . (1600-2000 sq ft)</b> <b>Very Large . . .(2000-2500 sq ft)</b> <b>Extremely Large (2500-3000 sq ft)</b> <b>Larger Yet . . .(3000-5000 sq ft)</b>
------------------------------------------------------------------------------------------------------------------------------------------------------------------------------------------------------------------------------------------------------------------------------------------------------------------

## **How Much of this Area Do You Intend to Heat with the JUCA?**

**ALL  
Half or so**

## **Present Heating System?**

**Gas Forced-Air  
Oil Forced-Air  
Electric Forced-Air  
Heat Pump  
Hot Water (Hydronic) Boiler  
Electric Baseboards  
Other**

## **Present Heating System Rating?**

**Less Than 50,000 Btu/hr  
50,000-80,000 Btu/hr  
(very common) 80,000-110,000  
110,000-150,000 Btu/hr  
150,000-200,000 Btu/hr  
Over 200,000 Btu/hr  
Unknown**

## **House Ducts?**

**There Are None**  
**All Ducts Are Metal**  
**Cold-Air Returns Are Non-Metal**  
**A Limited Duct System Could Be Installed**  
**A Full Duct System Could Be Installed**

## **Where Would You Like to Install a JUCA?**

**Main Floor-Near Center of House**  
**Main Floor-Near End or Corner of House**  
**Above the Main Floor-Near Center of House**  
**Below Main Floor-IN the Living Area-Near Center**  
**Below Main Floor-IN the Living Area-Near End or Corner**  
**In an Unfinished Basement**  
**In an Unheated Basement or Cellar**  
**In a Garage**  
**Other**

## **Do You Presently Have a Built-In Fireplace?**

**No**  
**Yes, It's Masonry**  
**Yes, It's a Metal Pre-Fab Unit**

**Are You considering a  
Built-In Fireplace Now?**

**No**  
**Yes**

**Is a Safe Usable Chimney  
Available Already?**

**No**  
**Yes**

**How Much Do You Hope to  
Reduce Your Heating Bills?**

**Completely Eliminate Them**  
**Eliminate Half**  
**Not Important**

## Approximate Total Cost You Expect?

<p><b>\$1000</b></p> <p><b>\$1500</b></p> <p><b>\$2000</b></p> <p><b>\$2500</b></p> <p><b>Flexible On Cost</b></p>
--------------------------------------------------------------------------------------------------------------------

**Click Here to Get the  
Results!**

--

The JUCA Home Page is at: <http://mb-soft.com/juca/index.html>

# Firewood Ratings and Info

based on data from: U.S. Forest Products Laboratory

(and numerous other sources)

Species	Relative Heat	Easy to Burn	Easy to Split	Heavy Smoke ?	Throw Sparks ?	General Rating	Aroma	Weight of Seasoned Cord-lbs	Heat Produced per Cord M Btu
<b>Hardwoods</b>	.								
Black Ash	Med	Yes/Fair	Yes	No	No/Few	Excel	Minim	2,992	19.1
White Ash	High	Yes/Fair	Yes	No	No/Few	Excel	Minim	3,689	23.6
Red Oak	High	Yes/Poor	No	No	No/Few	Excel	Fair	3,757	24.0
White Oak	High	Yes	No	No	No	Excel	.	4,012	25.7
Beech	High	Yes/Poor	Yes	No	No/Few	Excel	Minim	3,757	24.0
Blue Beech	High	Yes/Poor	Yes	No	No/Few	Excel	Minim	3,890	26.8
White Birch	Med	Yes/Good	Yes	No	No/Mod	Excel	Minim	3,179	20.3
Grey Birch	Med	Yes/Good	Yes	No	No/Mod	Poor	Minim	3,179	20.3
Yellow Birch	High	Yes/Good	Yes	No	No/Mod	Excel	Minim	3,689	23.6
Paper Birch	Med	Yes/Good	Yes	No	No/Mod	Excel	Minim	3,179	20.3
Black Birch	High	Yes/Good	Yes	No	No/Mod	Excel	Minim	3,890	26.8
Hickory	High	Yes/Fair	Bad	No	No/Mod	Excel	Good	4,327	27.7
Hard Maple	High	Yes	Bad	No	No	Excel	.	.	.
Pecan	High	Yes	Yes	No	No	Excel	.	.	.
Dogwood	High	Yes	Yes	No	No	Excel	.	.	.
Red or Soft Maple	Med	Yes	No	No	No	Good	.	2,924	18.7
Cherry	Med	Yes/Poor	Yes	No	No/Few	Good	Excel	3,120	20.0
Black Cherry	Med	Yes/Poor	Yes	No	No/Few	Good	Excel	2,880	19.9

Walnut	Med	Yes	Yes	No	No	Good	.	.	.
.									
White Elm	Med	Med/Fair	No	Med	No/None	Fair	Fair	3,052	19.5
American Elm	Med	Med/Fair	No	Med	No/None	Fair	Fair	3,052	19.5
Sycamore	Med	Med	No	Med	No	Fair	.	.	.
Gum	Med	Med	No	Med	No	Fair	.	.	.
Aspen	Low	Yes	Yes	Med	No	Fair	.	2,295	14.7
.									
Basswood	Low	Yes	Yes	Med	No	Fair	.	2,108	13.5
Cottonwood	Low	Yes	Yes	Med	No	Fair	.	2,108	13.5
Chestnut	Low	Yes	Yes	Med	Yes	Poor	.	.	.
Apple	High	Poor	.	.	Few	Med	Excel	4,140	26.5
Hemlock	Low	.	.	.	Many	Fair	Good	2,482	15.9
.									
Black Locust	High	Poor	.	.	None	Good	Minim	3,890	26.8
Sugar Maple	High	Poor	No	.	Few	Good	Good	3,757	24.0
Eastern Hornbeam	High	.	.	.	.	Excel	.	4,267	27.3
Hackberry	Med	.	.	.	.	.	.	3,247	20.8
Boxelder	Low	.	.	.	.	.	.	2,797	17.9
Butternut	Low	.	.	.	.	Poor	.	2,100	14.5
.									
<b>Softwoods</b>	.								
.									
Yellow Poplar	Low	Yes	Yes	Med	Yes	Poor	.	.	.
Southern Yellow Pine	High/Low	Yes	Yes	Yes	No/Mod	Good	Good	.	.
Douglas Fir	High	Yes	Yes	Yes	No	Good	.	.	.
Cypress	Med	Med	Yes	Med	No	Fair	.	.	.
Redwood	Med	Med	Yes	Med	No	Fair	.	.	.
.									

White Cedar	Med/Low	Yes/Exc	Yes	Med	Some	Good	Excel	1,913	12.2
Western Red Cedar	Med/Low	Yes/Exc	Yes	Med	Yes/Many	Good	Excel	.	.
Eastern Red Cedar	Med/Low	Yes/Exc	Yes	Med	Yes/Many	Good	Excel	.	.
Eastern White Pine	Low	Med/Exc	Yes	Med	No/Mod	Fair	Good	2,236	14.3
Western White Pine	Low	Med/Exc	Yes	Med	No/Mod	Fair	Good	2,236	14.3
.									
Sugar Pine	Low	Med/Exc	Yes	Med	No/Mod	Fair	Good	.	.
Ponderosa Pine	Low	Med/Exc	Yes	Med	No/Mod	Fair	Good	2,380	15.2
Tamarack	Med	Yes	Yes	Med	Yes	Fair	.	3,247	20.8
Larch	Med	Yes	Yes	Med	Yes	Fair	.	.	.
Spruce	Low	Yes	Yes	Med	Yes	Poor	.	2,100	14.5
.									
Black Spruce	Low	.	.	.	.	.	.	2,482	15.9
Jack Pine	Low	.	.	.	.	.	.	2,669	17.1
Norway Pine	Low	.	.	.	.	Fair	.	2,669	17.1
Pitch Pine	Low	.	.	.	.	Fair	.	2,669	17.1
Balsam Fir	Low	.	.	.	.	Poor	.	2,236	14.3
Willow	Low	.	.	.	.	Poor	.	2,100	14.5
.									
<b>Coals</b>	.							one ton	per ton
.									
Anthracite	High	No	N/A	.	No	Good	Good	2,000	25.4
Bituminous Hi-Volat	Med	Med	N/A	.	No	Med	Fair	2,000	22.0
Bituminous Lo-Volat	Med	Yes	N/A	.	No	Med	Fair	2,000	28.6
Lignite	Low	Yes	N/A	.	No	Poor	Poor	2,000	13.8
Charcoal	High	Yes	N/A	.	No	Poor	Poor	2,000	26.0



Weight and Heat content figures are based on seasoned wood at 20% moisture content, and 85 cu ft of wood per cord. A "cord" of wood is defined as a stack 4 feet high, 4 feet thick and 8 feet long. (A cord has about 85 cu ft of wood and not 128, because of the air spaces between the pieces). "Face cords" are often sold. These are amounts of wood that are still 4 feet high and 8 feet long, but of a lesser depth than 4 feet. Commonly, wood for sale is cut to 16 inches long, and stacked as a face cord. This is 1/3 of an actual cord, and it is also called a "rank" or "rick" or "stove cord" or "fireplace cord".

For more technical information on the amount of heat in wood, and how it is measured and calculated, see [Amount of Energy in Wood](#).

**In general, softwoods light and burn easily and quickly with a hot fire which tends to make a lot of sparks.**

**Hardwoods are usually harder to start but burn more evenly and quite a bit longer.**

## Regarding Seasoning of Wood

Freshly cut wood has a very high moisture content. As much as 60% (or more) of the weight of a tree is water. At least some of this water must be removed before trying to use it as a fuel wood. See [Amount of Energy in Wood](#), for a discussion of why that is necessary. Several bad results can occur from burning wood that is not fully dried to below 25% moisture content. (Such wood is referred to as "green" wood). As that discussion mentions, the effective available heat is MUCH less, not just because there is less wood fibers in each pound of wood put in the woodburner, but that a good percentage of that heat must be used to evaporate all that water before those wood fibers can burn. Another VERY important consequence of burning green wood is that the presence of all that moisture tends to keep "putting out" the fire, and therefore making it burn very poorly, which tends to produce a lot of creosote and pollution. **Don't Do It!**

Generally, the way this drying is accomplished is by "**seasoning**" it. Firewood is cut to length and then seasoned (dried) in a stack, with air being able to get to it, for **at least 9 months** before burning. The natural 60%-70% moisture content must be reduced to about 20% to burn well. The wood cells don't lose much moisture through the bark; the moisture is most effectively removed through the cut cells at the ends of each piece.

That's why logs which have lain in the woods for years may still have a lot of moisture and may not burn well (unless cut and dried.) We have heard of people cutting up these downed trees and immediately putting them in a woodburner! And the wood burns poorly! Now you know why!

OK! So, sometimes, it turns out to be NECESSARY to burn some green wood. Which species

would be best under those conditions? It turns out that the desirability is NOT the same as for seasoned wood! While they are living, various species of trees have different moisture contents. If you suitably dry them all, that difference rather disappears. But, while still green, it becomes significant.

It is possible to correlate both the heat-content of the wood fibers and the green moisture content to form a table of desirability for those situations when green wood must be burned.

<b>Species</b>	<b>Excess Moisture to dry weight</b>	<b>GREEN ranking</b>	<b>SEASONED ranking</b>
Ash	15%	1	8
Beech	17%	2	4
Black Locust	17%	3	1
Red Spruce	18%	4	16
Shagbark Hickory	19%	5	2
Sugar Maple	21%	6	5
Norway Pine	19%	7	14
Tamarack	21%	8	10
Black Cherry	22%	9	11
Yellow Birch	23%	10	7
White Birch	24%	11	12
Red Maple	24%	12	9
White Oak	25%	13	3
Silver Maple	27%	14	13
Red Oak	31%	15	6
White Pine	31%	16	21
White Elm	35%	17	15
Basswood	38%	18	22
Aspen	40%	19	19
Butternut	41%	20	18
Balsam Fir	44%	21	20
Hemlock	44%	22	17

Excess moisture is that percentage above the desirable 20% seasoned moisture content.

---

There is a complication that applies to at least some of the numerical data in the tables above. Unfortunately, two VERY different methods of describing moisture content are sometimes used. The scientific approach is to take a piece of wood and "remember" the initial weight of it. Let's say we have a piece that starts out weighing exactly one pound. If we had X-ray eyes, maybe we could see that that specific piece was actually 60% water and 40% wood fibers. A scientist would say that the initial moisture content was 60% (sounds obvious). Now, let's dry that piece, so that 5/6 of that original water evaporates. The wood fibers (originally 40% of the start) are all still there. So is water that represents 10% of the original weight of the piece of wood. So a scientist could describe this dried piece of wood as having 10% remaining moisture content.

However, think of the reality of the situation. Fifty percent of the weight of the piece of wood is now gone, evaporated as water vapor. When we actually look at the final piece of dried wood, we have no indication of all that moisture that used to be there! All we have left is wood fibers (which represents 4/5 of what we have left) and the remaining moisture (which represents the remaining 1/5 of what we have left). In practical terms, we could describe that 1/5 moisture in the piece as being 20% moisture content. Since this approach can be used with any piece of existing wood (without having to know its previous history), this is a common way used of describing the moisture content of wood.

Do you see the confusion? For our test piece, we could very correctly describe the moisture content of the dried piece as being either 10% or 20%, and either would be true. Unfortunately, some of the sources of the numerical data in the chart above did not indicate which of these two methods they used in deriving their results.

In general, we intended these charts to be of "comparative" usefulness, so a wood burner might have a general idea of which species might be better or worse. So, as long as you are not weighing all of your wood before putting it in your stove and doing rigid scientific studies, the information should be fine and you can ignore these technical comments.

If you ARE of a technical bent, there is actually yet another method that occasionally gets used. About 1980, a researcher decided to start referring to wood moisture in a piece of wood as being the percentage of the original moisture in the piece. This is a poor approach, but his reputation in the industry caused some people to adopt this system. His system would had looked at our example piece above and said that it started out with 100% moisture, and since the dried piece ended with 1/6 of that original moisture, he would have described the dried piece as having 17% moisture content.

I guess the bottom line of all this is to just realize that when anyone states a "moisture content" of a piece of wood, just remember that that number is dependent on just which system of measuring

was used! And then smile, because that level of detail is pretty much irrelevant in actually using a wood stove!

## Miscellaneous Wood Subjects

A number of specialty subjects might be useful to woodburners.

- Should pieces of wood be split from the top down or the bottom up? Since most people these days either buy their wood already split or they use hydraulic log-splitters, this is a somewhat irrelevant question these days. Even though old timer wood burners will adamantly tell you one or the other, careful experimental tests have shown that there is no advantage in time or effort in splitting from either direction. It doesn't matter!
- Wood pieces should be split along "check lines", cracks that have already formed in the piece during drying. This can significantly reduce the time and effort necessary to split pieces of wood.
- There are people who believe that wood is split easiest if it is frozen. The idea is that the pieces are more brittle and will sort of shatter. Surprisingly enough, experimental tests showed very little advantage of splitting general wood. Even more surprising, if most of the wood to be split is full of knots, there is actually substantial advantage of doing that splitting them thawed and not frozen!
- There are people who insist that wood should be dried (seasoned) for at least one or two years. Experimental evidence has established that that is nearly always unnecessary, as long as the pieces of wood are cut to length and stacked. Natural airflows through the stack, and particularly through the cut cells of the pieces of wood themselves, dries them sooner than that. Experimental evidence has established that one-foot long cut pieces generally dry to acceptable levels in just two or three months. Two-foot long cut pieces take about six or seven months for similar acceptability. Four-foot long cut pieces DO require at least a year.

Associated with this, covering the woodpile with a tarp slightly improves this, but probably not enough to make the expense of a tarp worthwhile, except in a climate where rain and very high humidity is common. Similarly, split pieces of wood tend to dry slightly faster than full diameter logs, but again by minimal amounts.

There appears to be no value in drying firewood more than about nine months.

- If wood is stacked in four-foot or longer lengths, the drying process is greatly slowed. In other words, if wood is cut to four-foot length and stacked, for nine months, and then cut to shorter burning length just before use, it will probably not burn well because it is still too wet

(green).

---

The JUCA Home Page is at: <http://mb-soft.com/juca/index.html>

# Theory of Design of an Efficient Wood-Burning Appliance

Quite a number of physical laws need to be dealt with in designing an optimal wood heating device. This paper presents an overview and is the method that was followed in designing the JUCA products. The same principles are used by JUCA today in examining product refinements and modifications. We generally use a computer nowadays, but the initial JUCA design from these equations was done by hand in 1973 and 1974.

A first step is to quantify the radiation given off by the fire and also the heat given off to the firebox air movements through and above the fire, all with the intention of tracking all the heat energy getting to the stove walls and heat exchangers.

## RADIATION:

After deciding on the physical size of the hypothetical fire and its average temperature (which depends on intensity - slow fires may average 1200°F; hot, intense ones 2300°F), use the Black-body radiation equation for each square inch of fire's contribution to the radiation incoming on each square inch of wall surface.

The basic equation is:

$$R = \sigma * \epsilon_1 * \epsilon_2 * (T_1^4 - T_2^4) * \left( \frac{A_1 \cos \theta_1 * A_2 \cos \theta_2}{\pi * (r_1 - r_2)^2} \right)$$

where  $\sigma$  = Stefan-Boltzmann constant; the  $\epsilon$ 's are the emissivities of the fire and wall; the T's are

the localized temperatures Kelvin of the fire and the wall; the A's are the areas used; and the  $\theta$ 's are the space angles between the surface's normal and the line joining the fire point and the wall point (for each end, of course);  $(r_1 - r_2)$  is the distance between the fire source point and the wall point. Subscript 1 refers to the fire (source); subscript 2 refers to the heat exchanger surface (destination).

This can be handled as a quintuple integral,

$$Q = \iiint \iint \sigma * \epsilon_1 * \epsilon_2 * (T_1^4 - T_2^4) * \left( \frac{A_1 \cos \theta_1 * A_2 \cos \theta_2}{\pi * (r_1 - r_2)^2} \right) dx_1 dy_1 dx_2 dy_2 dz_2$$

but solving this equation gets fairly messy with any complicated structure like the JUCA heat exchanger, and a numerical integration has generally been used.

The problem would actually be much more than a quintuple integral, except we made some assumptions to simplify it to the above equation. We assumed that the flames did not vary with time, and that they were uniform over the entire (flat) top surface area of the fire. We assumed that the fire was entirely flat and had no vertical side walls to radiate from. We made certain assumptions

about the consistency of convective air flows within the firebox, as would occur after several hours of constant burning.

## CONVECTION:

Using the production of hot smoke as a starting point, it is possible to estimate local smoke temperatures and velocity vectors near all wall segments. The excess air amount, wood consumption rate, flame temperature and distribution, and effectiveness of draft air distribution all represent serious effects, and a smoke production equation is used to provide estimates for these results, assuming the instantaneous smoke temperature begins at the fire temperature and that it immediately mixes following ideal gas statistical behavior.

### Combining Their Effects at the Wall

Now, if we temporarily assume a wall temperature, we can calculate the amount of energy available to the wall (a total of the convective and radiative heat energy) by solving the two component problems using that destination temperature. Next, we must determine the air flow characteristics that will affect the thermal transfer to the wall. A number of surface effects come into play which affect (generally reduce) the amount of heat actually transferred to the metal of the wall.

Since this is a natural convection situation, we can use the Nusselt number, the Grashof number, and the Prandtl number, to get:

$$\frac{hL}{\kappa} = \Phi \left( \frac{\gamma g \vartheta c_p L^3 \theta}{\mu^* \kappa} \right)$$

where  $h$  = the desired heat-transfer coefficient;  $L$  relates to the geometry of the structure;  $\kappa_f$  is the conductivity of the fluid;  $\gamma$  is the fluid density;  $\vartheta$  is the thermal expansion coefficient;  $c_p$  is the specific heat;  $\theta$  is the temp differential;  $\mu_f$  is the fluid viscosity.

Using a variety of assumptions, this can often be simplified to:

$$h = 0.13 * \kappa * \alpha^{1/3} \theta^{1/3}$$

$$\alpha = \frac{\gamma g \vartheta c_p}{\mu^* \kappa}$$

where

This equation for free convection must be used in the firebox as we use a natural draft fire.

On the other side of the exchanger surface a different set of equations must be used, since it is a forced air convection situation there. The Reihher equation (simplified) becomes:

$$\frac{hd}{\kappa_f} = 0.131 * \left( \frac{dG_{\max}}{\mu_f} \right)^{0.69}$$

where  $h$  is again the desired heat-transfer coefficient;  $d$  is a geometrical factor;  $G(\max)$  is the mass flow rate of fluid;  $\mu_f$  is the absolute viscosity of the fluid;  $K_f$  is the film thermal conductivity. Notice the similarity of the right hand side to the Reynold's number. It is very important to correct all the values to the correct temperature conditions that exist at the wall/air interface as many of them vary rapidly with temperature.

Now, use the radiation equation above again to calculate the outgoing radiation from that square inch of wall. Then solve:

$$R_{in} + R_{out} = C_{in} + C_{out}$$

for equilibrium conditions to estimate a correction to the initial temperature estimate for that square inch, then do it all again until incoming energy balances outgoing energy for every square inch of the structure. Of course, it is necessary to pay attention to the interaction of the separate square inches. Early ones in the exchanger will change the temperatures of both the air being heated and the smoke being tapped, so conditions in later portions and will materially change, generally tending to reduce the apparent effectiveness of the exchanger.

The balance equation above requires use of the  $h$  (heat-transfer coefficient) to determine actual heat transfer. It is also necessary to include a factor relating to the thermal resistance of the wall structure itself (as an additional  $R$  factor) although, with normal wall materials (like steel), the bulk of the result will be due to the surface effects described here. The advantage of the better intrinsic conductivity of an aluminum exchanger would be mostly lost among these much more dominant surface effects.

A representative simulation of a computer numerical integration of these equations is included in our web-site. It is at: [CAD Design](#).

In the many thousands of such simulations that have been done, the advantages of larger blowers in the room air side of the heat exchangers is evident.

The numerous simulations also showed the significant advantage of a tapering firebox shape. As heat is removed from the smoke, it becomes cooler and needs to take up less volume (at constant pressure). We call this concept "isobaric equilibrium" and it is the reason why free-standing JUCAs all have a tapering shape. The very popular B-3B and B-3A units have sides that slope in at a 17 degree angle. The larger B-3D and B-3C have an optimal angle of 16 degrees. Discussion of that subject is at [Why JUCA sides slope at 17 degrees](#).

---

The JUCA Home Page is at: <http://mb-soft.com/juca/index.html>



# Specifications of JUCA Products

## Popular JUCA Models

JUCA Model	Description	Rating Btu/hr	Dimensions (inches)	Door WxH	wood lgth	Duct Outlet	Wt Lbs	.
<a href="#">F-9A</a>	Built-In Fireplace	140,000	47Hx43Wx26D	30"x24"	24"	8"x16"	635	<a href="#">More</a>
<a href="#">B-3B</a>	Free-Standing Stove	122,000	53Hx33Wx30D	21"x15"	24"	8"x16"	495	<a href="#">More</a>
<a href="#">B-3J</a>	Free-Standing Stove	86,000	45Hx27Wx25D	17"x12"	20"	8"x12"	390	<a href="#">More</a>
<a href="#">B-3D</a>	3-Glass Side Stove	180,000	76Hx41Wx30D	32"x14"	24"	8"x16"	710	<a href="#">More</a>
<a href="#">L-8</a>	Fireplace Insert	~90,000	<b>CUSTOM</b>	custom	.	DNA	375	<a href="#">More</a>
<a href="#">B-3A</a>	Central Furnace	122,000	53Hx33Wx30D	21"x15"	24"	8"x16"	505	<a href="#">More</a>

## Other JUCA Models

JUCA Model	Description	Rating Btu/hr	Dimensions (inches)	Door WxH	wood lgth	Duct Outlet	Wt Lbs	.
<a href="#">F-9AX</a>	See-Thru Fireplace	110,000	47Hx43Wx30D	30"x24"	24"	8"x16"	595	<a href="#">More</a>
<a href="#">B-3N</a>	3-Sided Glass Stove	116,000	51Hx31Wx30D	21"x15"	20"	8"x16"	370	<a href="#">More</a>
<a href="#">B-3JN</a>	3-Sided Glass Stove	77,000	42Hx26Wx25D	17"x12"	16"	8"x12"	310	<a href="#">More</a>
<a href="#">K-3</a>	Free-Standing Stove	65,000	36Hx22Wx20D	14"x10"	16"	none	260	<a href="#">More</a>
<a href="#">L-10</a>	Fireplace Insert	~75,000	<b>CUSTOM</b>	custom	.	DNA	365	<a href="#">More</a>
<a href="#">B-3D7</a>	3-Glass Side Stove	90,000	66Hx41Wx30D	32"x14"	24"	8"x16"	470	<a href="#">More</a>
<a href="#">B-3C</a>	3-Glass Side Stove	180,000	56Hx41Wx30D	32"x14"	24"	8"x16"	490	<a href="#">More</a>

## B-3B

### Free-Standing Central or Add-on Furnace

The workhorse of the JUCA line, the B-3B has been completely heating many thousands of homes for over twenty years. The versatility of being able to install it upstairs, downstairs, in an attached garage or cellar; of using it as a room heater, as an add-on furnace, or as a separate furnace; of being able to enjoy the fire thru a large glass door; make it the best woodburner on the market.

With its capability of heating very large houses and since the B-3B has a huge firebox that will take large pieces of wood, you get long, even heating just like a regular furnace.

The unit has adjustable warm air outlets on both sides which send warm air downward and out to evenly distribute heat throughout a large open area, even when the ducting capability is not used.

8" Flue; Black is standard. The top half can be any of 35 other colors; Blower rating 465 cfm(std) to 2550 cfm.

---

[Click Here](#) for more info on Stoves.

[Return to Specification Table](#)

---

## B-3J

### Free-Standing Central or Add-on Furnace

Slightly smaller version of the B-3B. Good for medium sized houses. Quite popular when space is at a premium.

The unit has adjustable warm air outlets on both sides which send warm air downward and out to evenly distribute heat throughout a large open area, even when the ducting capability is not used.

6" Flue; 465 cfm(std) or 1240 cfm blower; Black is Standard. The top half can be any of 35 other colors.

[Click Here](#) for more info on Stoves.

[Return to Specification Table](#)

---

## K-3

### **Free-Standing Furnace**

A smaller yet version of the B-3B. Good for small houses or cabins. This model does NOT have ducting capabilities.

The unit has warm air outlets on both sides which send warm air downward and out to evenly distribute heat throughout a large open area.

6" Flue; 465 cfm blower. Black is standard. The top half can be any of 35 other colors.

---

[Click Here](#) for more info on Stoves.

[Return to Specification Table](#)

---

## B-3A

### **Free-Standing Central or Add-on Furnace**

Identical to the B-3B but without the glass door. A heavy steel door is used for basement-type applications where it is not desired to see the fire. The unit has adjustable warm air outlets on both sides which send warm air downward and out to evenly distribute heat throughout a large open area, in addition to the ducting capability.

---

[Click Here](#) for more info on Stoves.

[Return to Specification Table](#)

---

## B-3D

### Free-Standing or Peninsula Fireplace-Furnace

A variation on the B-3B design that has glass on three sides for enjoying the fire from everywhere. The B-3D is a focal point of any room. The unit can appear to sit on a stone or brick raised hearth. Lower part is firebrick lined. All one piece construction.

Combines the massiveness of masonry with the modern appearance and performance of a JUCA. You can have an ash dump; an outside air intake; a gas line for a log lighter; etc.

The unit has adjustable warm air outlets on both sides which send warm air downward and out to evenly distribute heat throughout a large open area, even when the ducting capability is not used.

10" Flue; Black is standard. The top half can be any of 35 other colors; Blower rating 465 cfm(std) to 2550 cfm.

---

[Click Here](#) for more info on 3-Glass-sided Stoves.

[Return to Specification Table](#)

---

## B-3C

### Free-Standing or Peninsula Fireplace-Furnace

Identical to B-3D except has an open (no) bottom and MUST be installed only over masonry (NO wood under unit), on a firebrick-and-masonry firepit (not included) to combine the massiveness of masonry with modern appearance/efficiency. Use model B-3D over a wood floor.

The unit has adjustable warm air outlets on both sides which send warm air downward and out to evenly distribute heat throughout a large open area, even when the ducting capability is not used.

10" Flue; Black is standard. The top half can be any of 35 other colors; Blower rating 465 cfm(std) to 2550 cfm.

[Click Here](#) for more info on 3-Glass-sided Stoves.

[Return to Specification Table](#)

---

## **B-3D7**

### **Free-Standing or Peninsula Fireplace-Furnace**

This shorter version of a B-3D is for applications where the full capabilities of the B-3D are not needed and/or where the size of the B-3D might aesthetically dominate the room. This model has fewer heat exchangers which allows less heating capability than most other JUCAs.

The unit has adjustable warm air outlets on both sides which send warm air downward and out to evenly distribute heat throughout a large open area, even when the ducting capability is not used.

10" Flue; Black is standard. The top half can be any of 35 other colors; Blower rating 465 cfm(std) to 1450 cfm.

---

[Click Here](#) for more info on 3-Glass-sided Stoves.

[Return to Specification Table](#)

---

## **B-3N**

### **Free-Standing or Peninsula Fireplace-Furnace**

Similar to the B-3B but with 3 glass sides. Side glass walls are vertical, instead of the sloping lower walls on the B-3B.

The unit has adjustable warm air outlets on both sides which send warm air downward and out to evenly distribute heat throughout a large open area, even when the ducting capability is not used.

8" Flue; Black is standard. The top half can be any of 35 other colors; Blower rating 465 cfm(std) to 2080 cfm.

---

[Click Here](#) for more info on 3-Glass-sided Stoves.

[Return to Specification Table](#)

---

## B-3JN

### Free-Standing or Peninsula Fireplace-Furnace

Similar to the B-3J but with 3 glass sides. Side glass walls are vertical, instead of the sloping lower walls on the B-3J.

The unit has adjustable warm air outlets on both sides which send warm air downward and out to evenly distribute heat throughout a large open area, even when the ducting capability is not used.

6" Flue; Black is standard. The top half can be any of 35 other colors; Blower rating 465 cfm(std) to 1240 cfm.

---

[Click Here](#) for more info on 3-Glass-sided Stoves.

[Return to Specification Table](#)

---

## F-9A

### Built-In Fireplace

The built-in version of the JUCA high-efficiency wood burning furnace combines the performance of a good furnace with the attractiveness of a traditional-looking fireplace. This unit allows enjoyment of a cozy fire and the heating of the whole house at the same time. The efficiency and performance of our built-in fireplace is much higher than anything else on the market. The F-9 was approved to UL standards and received BOCA listing.

There is flexibility of installing an ash dump; an outside air intake; a gas line for a log lighter or gas logs. Size is very flexible, too: we have made F-9A units as large as 78" wide!

The F-9A facing is a popular brass door assembly. We offer over [2,000 facing styles and finishes](#), including Arch-Top and other unique designs. No black metal panels or register grilles are present to distract from the appearance of the fireplace. The F-9A standard price includes very nice quality brass doors.

108" Flue; Blower rating 465 cfm(std) to 2550 cfm.

---

[Click Here](#) for more info on Fireplaces.

[Return to Specification Table](#)

---

## F-9AR

### **Built-In Fireplace with Rear Feed Door**

This Option on the JUCA Model F-9A has a steel rear door to allow feeding the fire from a garage or utility room behind the JUCA.

Specifications like F-9A except 40 lbs heavier; output 15,000 less.

---

[Click Here](#) for more info on Fireplaces.

[Return to Specification Table](#)

---

## F-9AX

### **See-Through Built-In Fireplace**

All F-9AX models have glass doors on two opposite sides for see- thru applications. The fire may be fed and enjoyed from both rooms. As with all JUCA units, custom dimensions and features are allowable. We have even made units which are Arch-Top on one side and Rectangular on the opposite side. We doubt that such a unit would be available from any other source.

On a JUCA F-9AX, you can choose among the [2,000 appearances](#) available **for each side**

**individually!**

10" Flue; Blower rating 465 cfm(std) to 2550 cfm.

---

[Click Here](#) for more info on Fireplaces.

[Return to Specification Table](#)

---

## L-8

### Fireplace Insert

**CUSTOM BUILT** to improve an existing fireplace's efficiency

We use six dimensions of your fireplace opening to design and build a unique product especially for you!

Our fireplace insert has a very large glass door combined with an automatic 465 cfm forced air system and heat exchangers. Can heat most of your house. **Custom built to your fireplace's measurements.** Extends out about 10" from the brickwork. All specifications are unique since each unit is designed FOR THAT FIREPLACE!

---

[Click Here](#) for more info on Fireplace Inserts.

[Return to Specification Table](#)

---

## L-10

### Fireplace Insert

**CUSTOM BUILT** to improve an existing fireplace's efficiency

We use six dimensions of your fireplace opening to design and build a unique product especially for you!



Performs similarly to the L-8 but has a different facing which is primarily a brass bi-fold door assembly 8" out from the wall with black intake and warm air grilles on the sides. The automatic blower is 330 cfm. Extends about 6" out from the fireplace brickwork.

---

[Click Here](#) for more info on Fireplace Inserts.

[Return to Specification Table](#)

---

---

In case you got to this page from a search:

The JUCA Web-Site is at: <http://www.mb-soft.com/juca/index.html>

# Where to Get JUCA Products

Many years ago, JUCA had quite a few dealers spread around the country. There were a total of about 500 JUCA dealers during that period.

Because the JUCA products are so technologically advanced, and because the JUCA diskette / down-loadable Program didn't yet exist, we had concerns that a few of those dealers were not able to address some customers' questions about JUCAs. For this and other reasons (referred to below), we stopped encouraging new dealers to join our family at that time. We wanted to make sure customers got correct and accurate and thorough answers to the questions and concerns and thought that customers might be better served by being in direct contact with the manufacturer (US!). This became even more valuable when we went to custom building every single unit in 1989, and we had started offering an immense number of customization choices. It turns out that dealers with showrooms didn't like that anyway, because they wanted to have "stock" products on the floor and in their stockroom to be able to sell immediately.

When we created the diskette-based Program in 1992 (which we mailed out on floppy diskettes), customers now had access to the answers to EVERY question and concern they might have. That program also offered and described the huge diversity of options and choices we had recently started making available. The answers are ACCURATE and COMPLETE, since they come directly from the manufacturer and the designers. Customers love this! They like having extensive, relatively un-biased information available, **such that they can make INFORMED DECISIONS.**

In the next several years, JUCA operated much as a mail-order house. This was good, in that it kept overhead low, allowing us to keep prices low (**from 1989 through 1999, JUCA product prices never increased!**) The only disadvantage was that many customers wanted to SEE one or more JUCA units and / or to talk to someone who has owned one. They seldom had any specific questions (the diskette Program had taken care of all that!) They just wanted the reassurance of actually seeing one and / or talking to an owner.

Up to early 1997, this was a very nice situation. We had not advertised anywhere since 1981, so virtually anybody that had found a way to contact us probably had already seen a friend's or neighbor's JUCA. How else could they have ever even known about a company that didn't advertise? Amazingly enough, sufficient people found us during those 16 years of not advertising to be busy and happy.

When we created our very complete web-site in 1997, the situation continued. We actually didn't create the web-site to nab new prospects! We did it for two primary reasons. (1) The vast majority of JUCAs sold earlier were through those 500 dealers, and when they eventually closed or quit, they never gave us their sales records, so we have never known just where most of our products are actually being used! Over the years, we have come to realize that many people could enhance

the performance of their JUCA, because they have poor duct arrangements or an improper sized blower for their home. JUCAs work so very well, that even with such errors in installations, they work great, and such owners are probably unaware of being able to get even better performance out of their old JUCA! (2) This was a selfish reason! Traditionally, JUCA would mail out roughly a hundred sheets of information on the unique operation and design of JUCA products. This cost us a lot in printing and mailing. We thought that by having the web-site, we might be able to reduce that cost, and therefore be able to keep product prices down even better. It turns out that there has been a side benefit from that. When people would receive a hundred sheets of paper in the mail, they would invariably discard ninety of those sheets right away, because they dealt with different types of products or features or aspects that they did not care about. With the web-site, a visitor could look at (and print out) ANY of the 1,000 files included in our web site and ignore all the rest.

Our web-site visitors are often extremely impressed with what they read and see. Given the real world, though, it amazes us at what a huge number of people choose to then buy our products, without actually seeing one. Of course, since we custom build each one, there really are no "stock" models to look at anyway! But still, it makes sense that most people would prefer to actually SEE one first, and maybe even in operation in an owner's home. At least, it would be nice to talk to someone who owns one.

In a way, we have complicated this, too. Since EVERY JUCA is custom-built to fill a specific customer's needs, they are all unique (and different!) When someone now orders an F-9AX Built-In Double-Sided Fireplace, with an Arch-Top opening on one side and a Rectangular opening on the other, there is virtually NO chance that a similar one will be within driving distance! (Even if we still had lots of dealers, NO dealer would STOCK such a unique product, so even then, it would not have been possible to see one.

---

To try to solve this need, JUCA added this page to the web site, hoping that some existing JUCA owners would be willing help out in this way and/or to act as Mini-Dealers and receive calls from prospective customers. The idea was that they might even sometimes invite prospective buyers to call or visit them. This would allow a potential customer to BOTH see a unit in operation heating an entire house AND to talk to an owner about their experiences of using a JUCA. As existing JUCA owners would happen to find our web-site and choose to help in this way, this page would get filled in with contacts all across the country. After all, we have sold over 26,000 JUCAs over the years, in 49 states (not Hawaii!)

Seems like a good idea, right? Through this list, future customers would (eventually!) be able to find someone local to talk to and to visit, and maybe even to buy from, rather than having to depend solely on our pictures and information.

The alternative to our current system, would be to (1) virtually eliminate all of our custom-built aspects (normal dealers like standard models that they can stock); (2) have customers wind up

paying a LOT more for our products (since contractors, dealers and distributors all profit for handling any products, our \$1400 prices would be likely to be \$2300 to the final customer); (3) eliminate installers being able to call our factory experts about questions they might have; (4) reduce our factory technical experts being able to DIRECTLY give useful suggestions about specific installations; (5) reduce the personal interaction of the transactions; (6) and otherwise have the disadvantages of higher volume operation to our customers. (That's how virtually all other products are sold.) So we are pretty well committed to our current approach.

Our hope was to eventually get enough current JUCA owners to be listed on this page, so that ANY future prospect could see one in operation, and we think our system would have become nearly perfect. Have you noticed how all the references here have been in the past?

A bad thing happened. Things were going well through most of 1997, and various existing JUCA owners veritably LEAPED at the chance to brag about how their unit had heated their homes completely. (Actually, we tend to think that some owners exaggerate how well they work, and listening to some owners makes it sound like JUCAs work even better than we describe in our web site. Oh, well!) Then, Alaska!

Early in 1998, some woman in Alaska had found our web-site and had become impressed. For unknown reasons, it appears that she had chosen to call EVERY SINGLE ONE of the dozen or so names then listed on this page, and she apparently kept EVERY ONE of them on the phone for one and one-half to two hours! Now, these kind people had just volunteered to be helpful (and we will forever be thankful to them for their generous offer). But we doubt if ANY of them expected to have an entire evening at home tied up by a two-hour conversation about a product that they just happened to like!

In the next few days, nearly all of those dozen people called us and asked to be removed from the page. Since they were all nice, kind people, none would initially say why, but we soon learned to just say the word "Alaska" and they would mention that they hadn't realized what an imposition their kind offer turned out to be. Nearly all pointed out that if ONE inquiry took up an entire evening of theirs, how much MORE of their leisure time would be also tied up in that way by future inquiries?

It is hard to imagine that a single customer could do so much damage! And, why did she feel it necessary to bother EVERY SINGLE ONE of them? And for so long? (And, can you imagine the phone bill she must have gotten, for all those very long calls from Alaska?) In any case, we immediately removed ALL of the entries from the (empty) list below.

There is even a funny part of that story. About two weeks later, that lady called US back again. She said she was amazed at how happy all of the JUCA owners were, but that her plans had changed and she no longer had any need for a JUCA! Ya just GOTTA have a sense of humor sometimes!

---

JUCA has always been extremely low-key, and, in all of our years in business, **we have never approached ANYONE to sell or present our products**, it doesn't figure that we are going to suddenly get aggressive about recruiting traditional dealers, like fireplace shops. So, the following list (of actual participating Mini-Dealers or Dealers, who would be looking to make a profit and so might put up with certain people from Alaska) will probably be pretty empty for quite a while. (The first few might get a lot of contacts! We are not sure whether that would be good or bad!) Of course, remember that we have worked directly from the factory for the past several years. So, for everywhere not served (yet!?) by Mini-Dealers or Dealers, **WE'RE always available to you.**

- **MidWest** . IL,IN,OH,MI,WI,KY
  -
- **NorthEast** PA,NY,MA,CT,RI,VT,NH,ME,NJ,DE,MD,WV,DC
  -
- **SouthEast** TN,VA,NC,SC,GA,AL,MS,LA,FL
  -
- **West** .. CA,OR,WA,AZ,NM,TX,NV,ID,WY,CO,WA,UT
  -
- **Plains** .. KS,NE,SD,ND,IA,MO,AR,OK,MN
  -
- **Other** . . AK,HI,Canada,Foreign
  -

---

The JUCA Web-Site is at: <http://www.mb-soft.com/juca/index.html>

# JUCA F-9A Pricing Details, Options

Prices as of Jan 1, 2000

F-9A Unit	140,000 Btu/hr output rating	<a href="#">More Info</a>	\$1,389.00
<b>Includes:</b>			
	<b>Strong Blower</b>	<a href="#">More Info</a>	<b>Included</b>
	Standard 465 cfm Blower (List \$152.92)	<a href="#">More Info</a>	<b>Included</b>
	915 cfm Optional Blower (List \$285.07)	<a href="#">More Info</a>	+\$114.90
	1240 cfm Optional Blower (List \$331.80)	<a href="#">More Info</a>	+\$138.08
	1460 cfm Optional Blower (List \$352.10)	<a href="#">More Info</a>	+\$154.83
	2080 cfm Optional Blower (List \$453.50)	<a href="#">More Info</a>	+\$262.48
	2550 cfm Optional Blower (List \$504.90)	<a href="#">More Info</a>	+\$322.28
	<b>Over 2,000 Diff Appearances</b>	<a href="#">More Info</a>	<b>Some Choices - Included</b>
	<b>"Snout"</b>	<a href="#">More Info</a>	<b>Included</b>
	<b>Automatic Blower Control</b>	<a href="#">More Info</a>	<b>Included</b>
	<b>Castable Firebrick Floor</b>	<a href="#">More Info</a>	<b>Included</b>
	<b>Huge 12 cubic foot Firebox</b>	<a href="#">More Info</a>	<b>Included</b>
	<b>Sophisticated Heat Exchangers</b>	<a href="#">More Info</a>	<b>Included</b>
	<b>Large 8" by 16" House Duct</b>	<a href="#">More Info</a>	<b>Included</b>
	<b>Warm Air Room Outlets</b>	<a href="#">More Info</a>	<b>Done On-Site</b>

## Options:

Variable Blower-Speed Control	<a href="#">More Info</a>	+\$42.37
Self-Feeding Steel Log Grate	<a href="#">More Info</a>	+\$43.97
Ash Dump Provision	<a href="#">More Info</a>	+\$25.00
Gas-Line Pipe Stub	<a href="#">More Info</a>	+\$14.00
Outside Combustion Air Duct	<a href="#">More Info</a>	+\$15.00
Arch-Top Appearance	<a href="#">More Info</a>	\$0.00
Oversize Width	<a href="#">More Info</a>	+\$100.00
Remote Blower Lip	<a href="#">More Info</a>	+\$9.80
Left- or Right-Hand Blower	<a href="#">More Info</a>	No Charge

Chimney Options <a href="#">More Info</a>	+0.00
Rear Feed Door Option <a href="#">More Info</a>	+210.00

## Other Info:

[Dimensions, Specifications](#)

[Installation Options, Necessary Dimensions](#)

[Freight, Shipping, etc.](#)

[F-9A ORDER FORM to Print Out](#)

[Comments on Our Pricing](#)

[Current Production Schedule](#)

[Various Types of Applications](#)

[More Ideas and Suggestions](#)

---

**E-mail: [JUCAF@mb-soft.com](mailto:JUCAF@mb-soft.com)**

The main JUCA Web-Site is at: <http://mb-soft.com/juca/index.htm>









# JUCA F-9AX Pricing Details, Options

Prices as of Jan 1, 2000

F-9AX Unit 100,000 Btu/hr output rating	<a href="#">More Info</a>	\$1,757.00
<b>Includes:</b>		
Strong Blower	<a href="#">More Info</a>	Included
Standard 465 cfm Blower (List \$152.92)	<a href="#">More Info</a>	Included
915 cfm Optional Blower (List \$285.07)	<a href="#">More Info</a>	+\$114.90
1240 cfm Optional Blower (List \$331.80)	<a href="#">More Info</a>	+\$138.08
1460 cfm Optional Blower (List \$352.10)	<a href="#">More Info</a>	+\$154.83
2080 cfm Optional Blower (List \$453.50)	<a href="#">More Info</a>	+\$262.48
2550 cfm Optional Blower (List \$504.90)	<a href="#">More Info</a>	+\$322.28
1,500 Diff Appear Each Side!	<a href="#">More Info</a>	Some Choices - Included
"Snout"	<a href="#">More Info</a>	Included
Automatic Blower Control	<a href="#">More Info</a>	Included
Castable Firebrick Floor	<a href="#">More Info</a>	Included
Huge 14 cubic foot Firebox	<a href="#">More Info</a>	Included
Sophisticated Heat Exchangers	<a href="#">More Info</a>	Included
Large 8" by 16" House Duct	<a href="#">More Info</a>	Included
Warm Air Room Outlets	<a href="#">More Info</a>	<b>Done On-Site</b>

## Options:

Variable Blower-Speed Control	<a href="#">More Info</a>	+\$42.37
Self-Feeding Steel Log Grate	<a href="#">More Info</a>	+\$43.97
Ash Dump Provision	<a href="#">More Info</a>	+\$25.00
Gas-Line Pipe Stub	<a href="#">More Info</a>	+\$14.00
Outside Combustion Air Duct	<a href="#">More Info</a>	+\$15.00
Arch-Top Appearance	<a href="#">More Info</a>	\$0.00
Oversize Width	<a href="#">More Info</a>	+\$80.00
Remote Blower Lip	<a href="#">More Info</a>	+\$9.80
Left- or Right-Handed Door	<a href="#">More Info</a>	No Charge

## Other Info:

[Dimensions, Specifications](#)

[Installation Options, Necessary Dimensions](#)

[Freight, Shipping, etc.](#)

[\*\*F-9AX ORDER FORM to Print Out\*\*](#)

[Comments on Our Pricing](#)

[Current Production Schedule](#)

[Various Types of Applications](#)

[More Ideas and Suggestions](#)

---

**E-mail: [JUCAx@mb-soft.com](mailto:JUCAx@mb-soft.com)**

The main JUCA Web-Site is at: <http://mb-soft.com/juca/index.htm>



# JUCA B-3B Pricing Details, Options

Prices as of Jan 1, 2000

B-3B Unit	122,000 Btu/hr output rating	<a href="#">More Info</a>	\$1,389.00
Includes:			
	Strong Blower	<a href="#">More Info</a>	Included
	Standard 465 cfm Blower (List \$152.92)	<a href="#">More Info</a>	Included
	915 cfm Optional Blower (List \$285.07)	<a href="#">More Info</a>	+\$114.90
	1240 cfm Optional Blower (List \$331.80)	<a href="#">More Info</a>	+\$138.08
	1460 cfm Optional Blower (List \$352.10)	<a href="#">More Info</a>	+\$154.83
	2080 cfm Optional Blower (List \$453.50)	<a href="#">More Info</a>	+\$262.48
	2550 cfm Optional Blower (List \$504.90)	<a href="#">More Info</a>	+\$322.28
	Matte Black Finish	<a href="#">More Info</a>	Included
	Orange or Red Gloss Finish	<a href="#">More Info</a>	+\$39.00
	Many Other Color Finishes	<a href="#">More Info</a>	+\$72.00
	Hi-Temp 14" by 20" Glass Door	<a href="#">More Info</a>	Included
	Super Pyroceram	<a href="#">More Info</a>	+\$68.10
	Automatic Blower Control	<a href="#">More Info</a>	Included
	Castable Firebrick Floor	<a href="#">More Info</a>	Included
	Huge 9.5 cubic foot Firebox	<a href="#">More Info</a>	Included
	Sophisticated Heat Exchangers	<a href="#">More Info</a>	Included
	Adjustable Side Warm Air Outlets	<a href="#">More Info</a>	Included
	Large 8" by 16" House Duct Outlet	<a href="#">More Info</a>	Included
	Chimney Connector	<a href="#">More Info</a>	Included
	Unique Door Structure	<a href="#">More Info</a>	Included
	Slider Draft Control	<a href="#">More Info</a>	Included
	Metal Safety Panel	<a href="#">More Info</a>	Included
	Decorative Glass Screen	<a href="#">More Info</a>	Included

## Options:

Variable Blower-Speed Control	<a href="#">More Info</a>	+\$42.37
Self-Feeding Steel Log Grate	<a href="#">More Info</a>	+\$43.97
Gas-Line Pipe Stub	<a href="#">More Info</a>	+\$14.00
Outside Combustion Air Duct	<a href="#">More Info</a>	+\$15.00
Remote Blower Lip	<a href="#">More Info</a>	+\$9.80
Left- or Right-Handed Door	<a href="#">More Info</a>	No Charge

## Other Info:

[Dimensions, Specifications](#)

[Freight, Shipping, etc.](#)

**[B-3B ORDER FORM to Print Out](#)**

[Comments on Our Pricing](#)

[Current Production Schedule](#)

[Various Types of Applications](#)

[More Ideas and Suggestions](#)

---

**E-mail: [JUCAb@mb-soft.com](mailto:JUCAb@mb-soft.com)**

The main JUCA Web-Site is at: <http://mb-soft.com/juca/index.htm>

# JUCA B-3J Pricing Details, Options

Prices as of Jan 1, 2000

B-3J Unit	86,000 Btu/hr output rating	<a href="#">More Info</a>	\$1,199.00
Includes:			
	Strong Blower	<a href="#">More Info</a>	Included
	Standard 465 cfm Blower (List \$152.92)	<a href="#">More Info</a>	Included
	915 cfm Optional Blower (List \$285.07)	<a href="#">More Info</a>	+\$114.90
	1240 cfm Optional Blower (List \$331.80)	<a href="#">More Info</a>	+\$138.08
	Matte Black Finish	<a href="#">More Info</a>	Included
	Orange or Red Gloss Finish	<a href="#">More Info</a>	+\$39.00
	Many Other Color Finishes	<a href="#">More Info</a>	+\$72.00
	Hi-Temp 10.6" by 16.5" Glass Door	<a href="#">More Info</a>	Included
	Super Pyroceram	<a href="#">More Info</a>	+\$38.10
	Automatic Blower Control	<a href="#">More Info</a>	Included
	Castable Firebrick Floor	<a href="#">More Info</a>	Included
	Huge 5.5 cubic foot Firebox	<a href="#">More Info</a>	Included
	Sophisticated Heat Exchangers	<a href="#">More Info</a>	Included
	Adjustable Side Warm Air Outlets	<a href="#">More Info</a>	Included
	Large 8" by 12" House Duct Outlet	<a href="#">More Info</a>	Included
	Chimney Connector	<a href="#">More Info</a>	Included
	Unique Door Structure	<a href="#">More Info</a>	Included
	Slider Draft Control	<a href="#">More Info</a>	Included
	Metal Safety Panel	<a href="#">More Info</a>	Included
	Decorative Glass Screen	<a href="#">More Info</a>	Included
Options:			
	Variable Blower-Speed Control	<a href="#">More Info</a>	+\$42.37
	Self-Feeding Steel Log Grate	<a href="#">More Info</a>	+\$43.97
	Gas-Line Pipe Stub	<a href="#">More Info</a>	+\$14.00



Outside Combustion Air Duct	<a href="#">More Info</a>	+\$15.00
Remote Blower Lip	<a href="#">More Info</a>	+\$9.80
Left- or Right-Handed Door	<a href="#">More Info</a>	No Charge

## Other Info:

[Dimensions, Specifications](#)

[Freight, Shipping, etc.](#)

[B-3J ORDER FORM to Print Out](#)

[Comments on Our Pricing](#)

[Current Production Schedule](#)

[Various Types of Applications](#)

[More Ideas and Suggestions](#)

---

**E-mail: [JUCAj@mb-soft.com](mailto:JUCAj@mb-soft.com)**

The main JUCA Web-Site is at: <http://mb-soft.com/juca/index.htm>

# JUCA K-3 Pricing Details, Options

Prices as of Jan 1, 2000

K-3 Unit	65,000 Btu/hr output rating	<a href="#">More Info</a>	\$1,199.00
<b>Includes:</b>			
	Strong Blower	<a href="#">More Info</a>	Included
	465 cfm Blower (List \$152.92)	<a href="#">More Info</a>	Included
	Matte Black Finish	<a href="#">More Info</a>	Included
	Orange or Red Gloss Finish	<a href="#">More Info</a>	+\$39.00
	Many Other Color Finishes	<a href="#">More Info</a>	+\$72.00
	Vycor Hi-Temp 9" by 13" Glass Door	<a href="#">More Info</a>	Included
	Automatic Blower Control	<a href="#">More Info</a>	Included
	Castable Firebrick Floor	<a href="#">More Info</a>	Included
	Huge 3 cubic foot Firebox	<a href="#">More Info</a>	Included
	Sophisticated Heat Exchangers	<a href="#">More Info</a>	Included
	Side Warm Air Outlets	<a href="#">More Info</a>	Included
	Chimney Connector	<a href="#">More Info</a>	Included
	Unique Door Structure	<a href="#">More Info</a>	Included
	Slider Draft Control	<a href="#">More Info</a>	Included
	Metal Safety Panel	<a href="#">More Info</a>	Included
	Decorative Glass Screen	<a href="#">More Info</a>	Included

## Options:

Variable Blower-Speed Control	<a href="#">More Info</a>	+\$42.37
Self-Feeding Steel Log Grate	<a href="#">More Info</a>	+\$43.97
Outside Combustion Air Duct	<a href="#">More Info</a>	+\$15.00
Left- or Right-Handed Door	<a href="#">More Info</a>	No Charge

## Other Info:

- [Dimensions, Specifications](#)
- [Freight, Shipping, etc.](#)

**[K-3 ORDER FORM to Print Out](#)**

[Comments on Our Pricing](#)

[Current Production Schedule](#)

---

**E-mail: [JUCAk@mb-soft.com](mailto:JUCAk@mb-soft.com)**

The main JUCA Web-Site is at: <http://mb-soft.com/juca/index.htm>

# JUCA B-3D Pricing Details, Options

Prices as of Jan 1, 2000

B-3D Unit	180,000 Btu/hr output rating	<a href="#">More Info</a>	\$1,959.00
Includes:			
Strong Blower		<a href="#">More Info</a>	Included
	Standard 465 cfm Blower (List \$152.92)	<a href="#">More Info</a>	Included
	915 cfm Optional Blower (List \$285.07)	<a href="#">More Info</a>	+\$114.90
	1240 cfm Optional Blower (List \$331.80)	<a href="#">More Info</a>	+\$138.08
	1460 cfm Optional Blower (List \$352.10)	<a href="#">More Info</a>	+\$154.83
	2080 cfm Optional Blower (List \$453.50)	<a href="#">More Info</a>	+\$262.48
	2550 cfm Optional Blower (List \$504.90)	<a href="#">More Info</a>	+\$322.28
Matte Black Finish		<a href="#">More Info</a>	Included
	Orange or Red Gloss Finish	<a href="#">More Info</a>	+\$39.00
	Many Other Color Finishes	<a href="#">More Info</a>	+\$72.00
Hi-Temp 13" by 31" Front Glass Door		<a href="#">More Info</a>	Included
Two Hi-Temp 17" by 24" Side Glass Panels		<a href="#">More Info</a>	Included
	Super Pyroceram Glass Set	<a href="#">More Info</a>	+\$208.10
Automatic Blower Control		<a href="#">More Info</a>	Included
Castable Firebrick Floor		<a href="#">More Info</a>	Included
Huge 12 cubic foot Firebox		<a href="#">More Info</a>	Included
Sophisticated Heat Exchangers		<a href="#">More Info</a>	Included
Adjustable Side Warm Air Outlets		<a href="#">More Info</a>	Included
Large 8" by 16" House Duct Outlet		<a href="#">More Info</a>	Included
Chimney Connector		<a href="#">More Info</a>	Included
Unique Door Structure		<a href="#">More Info</a>	Included
Slider Draft Control		<a href="#">More Info</a>	Included
3 Metal Safety Panels		<a href="#">More Info</a>	Included
3 Decorative Glass Screens		<a href="#">More Info</a>	Included

## Options:

Variable Blower-Speed Control	<a href="#">More Info</a>	+\$42.37
Self-Feeding Steel Log Grate	<a href="#">More Info</a>	+\$43.97
Gas-Line Pipe Stub	<a href="#">More Info</a>	+\$14.00
Outside Combustion Air Duct	<a href="#">More Info</a>	+\$15.00
Remote Blower Lip	<a href="#">More Info</a>	+\$9.80
Left- or Right-Handed Door	<a href="#">More Info</a>	No Charge

## Other Info:

[Dimensions, Specifications](#)

[Freight, Shipping, etc.](#)

[B-3D ORDER FORM to Print Out](#)

[Comments on Our Pricing](#)

[Current Production Schedule](#)

[Various Types of Applications](#)

[More Ideas and Suggestions](#)

There are some other sized versions of this model.

.

## D-7

The D-7 model is identical to the B-3D unit except that the top ten inches of the upper unit is not present. This makes the height of the unit 10 inches less, the weight is about 100 pounds less. The upper row of heat exchanger tubes is also not present, so the heat production capability is substantially less. Otherwise all specifications, and all the options, are the same as for the B-3D model described above.

The price of the D-7 is \$100 less than the B-3D.

.

## D-3

The D-3 model is identical to the B-3D unit except that everything is taller. The top tapering area

is six inches taller, and the glass area is 7 inches taller. This makes the height of the unit 13 inches taller than the B-3D, the weight is about 200 pounds more. An extra upper row of heat exchanger tubes is present, so the heat production capability is substantially higher. The D-3 unit has a 12 inch chimney connector. Otherwise all specifications, and all the options, are the same as for the B-3D model described above.

The price pf the D-3 is \$500 more than the B-3D.

---

**E-mail: [JUCAd@mb-soft.com](mailto:JUCAd@mb-soft.com)**

The main JUCA Web-Site is at: <http://mb-soft.com/juca/index.htm>

# JUCA B-3N Pricing Details, Options

Prices as of Jan 1, 2000

B-3N Unit	116,000 Btu/hr output rating	<a href="#">More Info</a>	\$1,669.00
Includes:			
	Strong Blower	<a href="#">More Info</a>	Included
	Standard 465 cfm Blower (List \$152.92)	<a href="#">More Info</a>	Included
	915 cfm Optional Blower (List \$285.07)	<a href="#">More Info</a>	+\$114.90
	1240 cfm Optional Blower (List \$331.80)	<a href="#">More Info</a>	+\$138.08
	1460 cfm Optional Blower (List \$352.10)	<a href="#">More Info</a>	+\$154.83
	Matte Black Finish	<a href="#">More Info</a>	Included
	Orange or Red Gloss Finish	<a href="#">More Info</a>	+\$39.00
	Many Other Color Finishes	<a href="#">More Info</a>	+\$72.00
	Pyro 14" by 20" Front Glass Door	<a href="#">More Info</a>	Included
	Two Pyro 14" by 20" Side Glass Panels	<a href="#">More Info</a>	Included
	Automatic Blower Control	<a href="#">More Info</a>	Included
	Castable Firebrick Floor	<a href="#">More Info</a>	Included
	Huge 5.5 cubic foot Firebox	<a href="#">More Info</a>	Included
	Sophisticated Heat Exchangers	<a href="#">More Info</a>	Included
	Adjustable Side Warm Air Outlets	<a href="#">More Info</a>	Included
	Large 8" by 16" House Duct Outlet	<a href="#">More Info</a>	Included
	Chimney Connector	<a href="#">More Info</a>	Included
	Unique Door Structure	<a href="#">More Info</a>	Included
	Slider Draft Control	<a href="#">More Info</a>	Included
	3 Metal Safety Panels	<a href="#">More Info</a>	Included
	3 Decorative Glass Screens	<a href="#">More Info</a>	Included
<b>Options:</b>			
	Variable Blower-Speed Control	<a href="#">More Info</a>	+\$42.37
	Self-Feeding Steel Log Grate	<a href="#">More Info</a>	+\$43.97

Gas-Line Pipe Stub	<a href="#">More Info</a>	+\$14.00
Outside Combustion Air Duct	<a href="#">More Info</a>	+\$15.00
Remote Blower Lip	<a href="#">More Info</a>	+\$9.80
Left- or Right-Handed Door	<a href="#">More Info</a>	No Charge

## Other Info:

[Dimensions, Specifications](#)

[Freight, Shipping, etc.](#)

[\*\*B-3N ORDER FORM to Print Out\*\*](#)

[Comments on Our Pricing](#)

[Current Production Schedule](#)

[Various Types of Applications](#)

[More Ideas and Suggestions](#)

---

**E-mail: [JUCAn@mb-soft.com](mailto:JUCAn@mb-soft.com)**

The main JUCA Web-Site is at: <http://mb-soft.com/juca/index.htm>



# JUCA B-3JN Pricing Details, Options

Prices as of Jan 1, 2000

B-3JN Unit	77,000 Btu/hr output rating	<a href="#">More Info</a>	\$1,519.00
<b>Includes:</b>			
	Strong Blower	<a href="#">More Info</a>	Included
	Standard 465 cfm Blower (List \$152.92)	<a href="#">More Info</a>	Included
	915 cfm Optional Blower (List \$285.07)	<a href="#">More Info</a>	+\$114.90
	Matte Black Finish	<a href="#">More Info</a>	Included
	Orange or Red Gloss Finish	<a href="#">More Info</a>	+\$39.00
	Many Other Color Finishes	<a href="#">More Info</a>	+\$72.00
	Pyro 10" by 16" Front Glass Door	<a href="#">More Info</a>	Included
	Two Pyro 10" by 16" Side Glass Panels	<a href="#">More Info</a>	Included
	Automatic Blower Control	<a href="#">More Info</a>	Included
	Castable Firebrick Floor	<a href="#">More Info</a>	Included
	3.5 cubic foot Firebox	<a href="#">More Info</a>	Included
	Sophisticated Heat Exchangers	<a href="#">More Info</a>	Included
	Side Warm Air Outlets	<a href="#">More Info</a>	Included
	Large 8" by 12" House Duct Outlet	<a href="#">More Info</a>	Included
	Chimney Connector	<a href="#">More Info</a>	Included
	Unique Door Structure	<a href="#">More Info</a>	Included
	Slider Draft Control	<a href="#">More Info</a>	Included
	3 Metal Safety Panels	<a href="#">More Info</a>	Included
	3 Decorative Glass Screens	<a href="#">More Info</a>	Included

## Options:

Variable Blower-Speed Control	<a href="#">More Info</a>	+\$42.37
Self-Feeding Steel Log Grate	<a href="#">More Info</a>	+\$43.97
Gas-Line Pipe Stub	<a href="#">More Info</a>	+\$14.00
Outside Combustion Air Duct	<a href="#">More Info</a>	+\$15.00

Remote Blower Lip [More Info](#)

+\$9.80

Left- or Right-Handed Door [More Info](#)

No Charge

## Other Info:

[Dimensions, Specifications](#)

[Freight, Shipping, etc.](#)

[B-3JN ORDER FORM to Print Out](#)

[Comments on Our Pricing](#)

[Current Production Schedule](#)

[Various Types of Applications](#)

[More Ideas and Suggestions](#)

---

**E-mail: [JUCAjn@mb-soft.com](mailto:JUCAjn@mb-soft.com)**

The main JUCA Web-Site is at: <http://mb-soft.com/juca/index.htm>

# JUCA B-3C Pricing Details, Options

Prices as of Jan 1, 2000

B-3C Unit 180,000 Btu/hr output rating	<a href="#">More Info</a>	\$1,769.00
Includes:		
Strong Blower	<a href="#">More Info</a>	Included
Standard 465 cfm Blower (List \$152.92)	<a href="#">More Info</a>	Included
915 cfm Optional Blower (List \$285.07)	<a href="#">More Info</a>	+\$114.90
1240 cfm Optional Blower (List \$331.80)	<a href="#">More Info</a>	+\$138.08
1460 cfm Optional Blower (List \$352.10)	<a href="#">More Info</a>	+\$154.83
2080 cfm Optional Blower (List \$453.50)	<a href="#">More Info</a>	+\$262.48
2550 cfm Optional Blower (List \$504.90)	<a href="#">More Info</a>	+\$322.28
Matte Black Finish	<a href="#">More Info</a>	Included
Orange or Red Gloss Finish	<a href="#">More Info</a>	+\$39.00
Many Other Color Finishes	<a href="#">More Info</a>	+\$72.00
Hi-Temp 13" by 31" Front Glass Door	<a href="#">More Info</a>	Included
Two Hi-Temp 17" by 24" Side Glass Panels	<a href="#">More Info</a>	Included
Super Pyroceram Glass Set	<a href="#">More Info</a>	+\$208.10
Automatic Blower Control	<a href="#">More Info</a>	Included
Lower Half of Firebox	<a href="#">More Info</a>	<b>NOT Included</b>
Huge 12 cubic foot Firebox	<a href="#">More Info</a>	Included
Sophisticated Heat Exchangers	<a href="#">More Info</a>	Included
Adjustable Side Warm Air Outlets	<a href="#">More Info</a>	Included
Large 8" by 16" House Duct Outlet	<a href="#">More Info</a>	Included
Chimney Connector	<a href="#">More Info</a>	Included
Unique Door Structure	<a href="#">More Info</a>	Included
Slider Draft Control	<a href="#">More Info</a>	Included
3 Metal Safety Panels	<a href="#">More Info</a>	Included

## 3 Decorative Glass Screens

[More Info](#)**Included**

### Options:

Variable Blower-Speed Control	<a href="#">More Info</a>	+\$42.37
Self-Feeding Steel Log Grate	<a href="#">More Info</a>	+\$43.97
Remote Blower Lip	<a href="#">More Info</a>	+\$9.80
Left- or Right-Handed Door	<a href="#">More Info</a>	No Charge

### Other Info:

[Dimensions, Specifications](#)[Freight, Shipping, etc.](#)[B-3C ORDER FORM to Print Out](#)[Comments on Our Pricing](#)[Current Production Schedule](#)[Various Types of Applications](#)[More Ideas and Suggestions](#)

There are some other sized versions of this model.

.

## C-7

The C-7 model is identical to the B-3C unit except that the top ten inches of the upper unit is not present. This makes the height of the unit 10 inches less, the weight is about 100 pounds less. The upper row of heat exchanger tubes is also not present, so the heat production capability is substantially less. Otherwise all specifications, and all the options, are the same as for the B-3C model described above.

The price of the C-7 is \$100 less than the B-3C.

.

## C-3

The C-3 model is identical to the B-3C unit except that everything is taller. The top tapering area is six inches taller, and the glass area is 7 inches taller. This makes the height of the unit 13 inches

taller than the B-3C, the weight is about 200 pounds more. An extra upper row of heat exchanger tubes is present, so the heat production capability is substantially higher. The C-3 unit has a 12 inch chimney connector. Otherwise all specifications, and all the options, are the same as for the B-3C model described above.

The price of the C-3 is \$500 more than the B-3C.

---

**E-mail: [JUCAc@mb-soft.com](mailto:JUCAc@mb-soft.com)**

The main JUCA Web-Site is at: <http://mb-soft.com/juca/index.htm>



# JUCA B-3A Pricing Details, Options

Prices as of Jan 1, 2000

B-3A Unit	122,000 Btu/hr output rating	<a href="#">More Info</a>	\$1,339.00
<b>Includes:</b>			
	<b>Strong Blower</b>	<a href="#">More Info</a>	<b>Included</b>
	Standard 465 cfm Blower (List \$152.92)	<a href="#">More Info</a>	<b>Included</b>
	915 cfm Optional Blower (List \$285.07)	<a href="#">More Info</a>	+\$114.90
	1240 cfm Optional Blower (List \$331.80)	<a href="#">More Info</a>	+\$138.08
	1460 cfm Optional Blower (List \$352.10)	<a href="#">More Info</a>	+\$154.83
	2080 cfm Optional Blower (List \$453.50)	<a href="#">More Info</a>	+\$262.48
	2550 cfm Optional Blower (List \$504.90)	<a href="#">More Info</a>	+\$322.28
	<b>Matte Black Finish</b>	<a href="#">More Info</a>	<b>Included</b>
	Orange or Red Gloss Finish	<a href="#">More Info</a>	+\$39.00
	<b>Automatic Blower Control</b>	<a href="#">More Info</a>	<b>Included</b>
	<b>Castable Firebrick Floor</b>	<a href="#">More Info</a>	<b>Included</b>
	<b>Huge 9.5 cubic foot Firebox</b>	<a href="#">More Info</a>	<b>Included</b>
	<b>Sophisticated Heat Exchangers</b>	<a href="#">More Info</a>	<b>Included</b>
	<b>Slider Draft Control</b>	<a href="#">More Info</a>	<b>Included</b>
	<b>Adjustable Side Warm Air Outlets</b>	<a href="#">More Info</a>	<b>Included</b>
	<b>Large 8" by 16" House Duct Outlet</b>	<a href="#">More Info</a>	<b>Included</b>
	<b>Chimney Connector</b>	<a href="#">More Info</a>	<b>Included</b>

## Options:

Variable Blower-Speed Control	<a href="#">More Info</a>	+\$42.37
Self-Feeding Steel Log Grate	<a href="#">More Info</a>	+\$43.97
Gas-Line Pipe Stub	<a href="#">More Info</a>	+\$14.00
Outside Combustion Air Duct	<a href="#">More Info</a>	+\$15.00
Remote Blower Lip	<a href="#">More Info</a>	+\$9.80
Left- or Right-Handed Door	<a href="#">More Info</a>	No Charge

## Other Info:

[Dimensions, Specifications](#)

[Freight, Shipping, etc.](#)

[\*\*B-3A ORDER FORM to Print Out\*\*](#)

[Comments on Our Pricing](#)

[Current Production Schedule](#)

[Various Types of Applications](#)

[More Ideas and Suggestions](#)

---

**E-mail: [JUCAa@mb-soft.com](mailto:JUCAa@mb-soft.com)**

The main JUCA Web-Site is at: <http://mb-soft.com/juca/index.htm>



# Public Service Projects Index

Over the years, I have become involved in a number of projects, each of which has been intended to somehow benefit society, Nature or God. Some presently exist, some are in development, and some are just available for possible combined efforts! **ALL are protected by U.S. Copyright protection!** The presentations included in the following lists give at least an overview of many of these projects. Each is designed to be **PRINTABLE**. They apply to a wide variety of fields. Some represent possible business ventures (some of which already exist). Most represent new combinations of perspectives or technologies that seem to enable new insights into the subject at hand. I hope that these scientific, social, religious, and intellectual pages might provide seeds of thought on which others could build. If such use is made of any of my pages, I request a notation of credit be included.

The product- or service-related business ideas presented all belong to me, and some are either currently patented or have patent procedures in progress. Nearly aoo of these are also meant to somehow benefit society. Use or development of any of them would **ONLY** be allowed based on a written contract of agreement regarding that particular invention or device or process. **NO** authority is given to manufacture or promote any of them, based on the mere presence of these presentation pages.

If a reader of this happens to be an electronics technician or hobbyist, I would have great interest in discussing the possibility of hiring or collaborating on a number of these projects that involve various levels of electronic circuitry.

[Information about my background.](#)

## Scientific

- [A New Explanation For Mass Extinctions of Dinosaurs](#)
- [A Significant Change in the Interpretation of Relativistic Red Shifts-Intro](#)
- [A Significant Change in the Interpretation of Relativistic Red Shifts](#)
- [An Improved Theory for Galaxy Rotation](#)
- [Source of the Earth's Magnetic Field](#)
- [New ideas on the Physics applying to Large Dinosaurs](#)
- [Gravitational Forced Vibration Resonances](#)
- [Additional Science-Related Topics](#)

## Social

- [\*\*A New Approach at Eliminating Hurricanes!\*\*](#)
- [\*\*A Simple Way to Make Airlines Safe!\*\*](#)
- [A Non-Chemical Method of Anesthesia for Medical Operations](#)
- [Why the Muslim Terrorists Do Those Things](#)
- [Improving American Public Education Inexpensively](#)
- [\*\*The Physics of Why SUVs Have So Many Rollover Accidents\*\*](#)
- [PSST Rape Prevention System](#)
- [Making our Neighborhoods Safer](#)
- [\*\*South Florida's Water Supply Danger\*\*](#)
- [\*\*An Alternative to High-Speed Police Chases\*\*](#)
- [\*\*Thoughts on the Meaning of Life\*\*](#)
- [An Active Mechanism to greatly reduce aircraft turbulence and drag](#)
- [A Comfortable, Wearable Support Device for Lower Back Pain and more](#)
- [Hydrogen as a Potential Energy Source for Cars](#)
- [\*\*Additional Society-Related Topics\*\*](#)

## Potential Products or Services

- [\*\*Virtually FREE House Air Conditioning\*\*](#)
- [An Extremely Efficient Transportation System](#)
- [An Inexpensive device to check Auto Tire Pressures](#)
- [\*\*Complete House Solar Heating - Version 1\*\*](#)
- [An Improved Automotive Engine?](#)
- [RoadTalker Highway Safety Improvement](#)
- [\*\*Additional Product-Related Topics\*\*](#)

## Environmental

- [\*\*Method and Mechanism to Save Beached Whales\*\*](#)
- [\*\*Saving Venice from Sinking Into the Sea\*\*](#)
- [An Almost Unlimited \(Clean\) Power Source!](#)
- [Reducing Vehicle Pollution](#)
- [Reducing Natural Resource Depletion](#)

## Religious

- [\*\*Compatibility of Christianity and Science\*\*](#)

- [Compatibility of Genesis and Science](#)
- [A Religious Information Source](#)
- [A New Perspective on the Trinity](#)
- [Compatibility Between Christianity and Other Religions](#)
- [A Christ Walk Church](#)
- [Additional Religion-Related Topics](#)

---

The individual presentations generally include the dates of origin and of presentation on the Internet. These pages first started being placed on the Internet in January 1997.

---

---

C. Johnson

E-mail to: [Public@mb-soft.com](mailto:Public@mb-soft.com)

# NorthWarm Solar Heating Simulations

## Version II Performance

We put enormous effort in engineering our Solar System, and bought a hill near South Bend, Indiana, to construct it. We did a LOT of computer simulations in refining it. We obtained ALL the US Weather Station records ever kept at the South Bend International Airport! They only started recording there after World War II, so our simulations start then.

In 1948-49, the Winter sky had only about 23% clearness. Some whole Januarys and Februarys had less than 10% clearness! **In 1961-62, a January stretch of 10 days without ANY sun combined with temperatures below zero on 13 days!** In December 1967, there were 12 consecutive days without any Sun! In every case, the normal solar heating system performed disappointingly, while our system EASILY would have kept the entire large house at the constant 70°F! Check it out!!

**Please Choose Year:**

**Choose From These Years:**

**Then Click Here for Year's  
Performance**

---

NorthWarm's Home Page is at: <http://mb-soft.com/solar/index.html>

E-mail to: [Solar@mb-soft.com](mailto:Solar@mb-soft.com)