

**AT** MICROFICHE  
REFERENCE  
LIBRARY

A project of Volunteers in Asia

Fuel Alcohol Production: A Selective Survey of  
Operating Systems

by: Cliff Bradley, et al., edited by Jon Sesso

Published by:

National Center for Appropriate Technology  
P.O. Box 3838  
Butte, MT 59702 USA

Available from:

National Center for Appropriate Technology  
P.O. Box 3838  
Butte, MT 59702 USA

Reproduced by permission of the National Center  
for Appropriate Technology.

Reproduction of this microfiche document in any  
form is subject to the same restrictions as those  
of the original document.

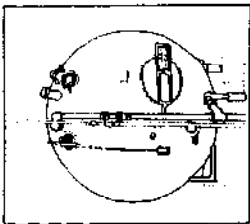
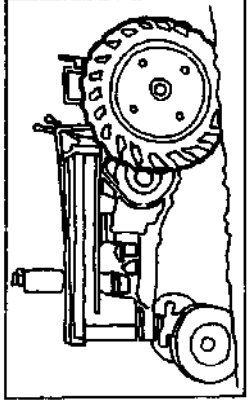
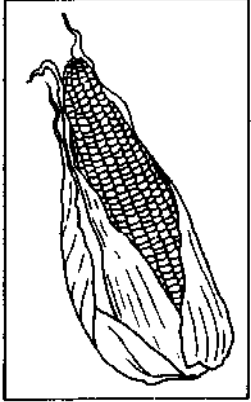
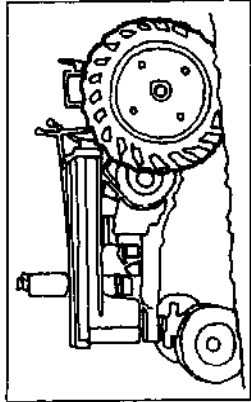
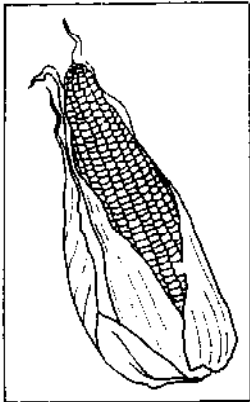

# FUEL ALCOHOL PRODUCTION

A SELECTIVE SURVEY  
OF OPERATING SYSTEMS

**Ncat** the National Center for  
Appropriate Technology

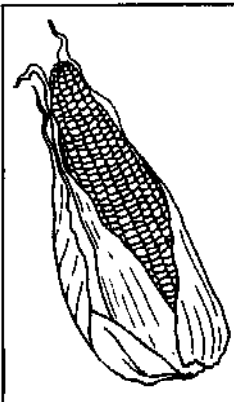
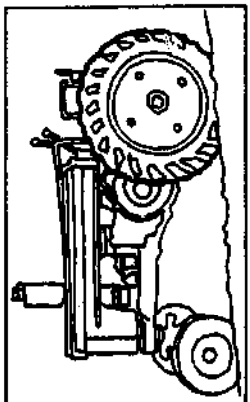
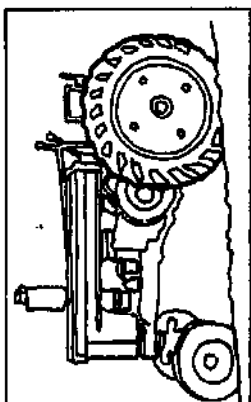
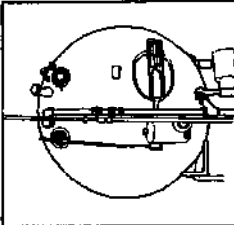
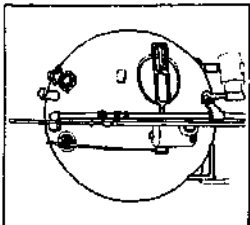
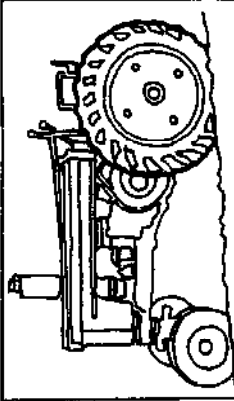
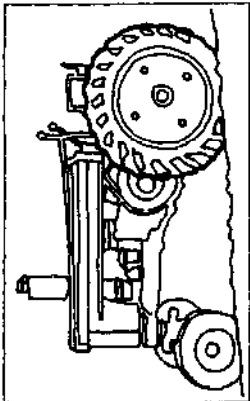
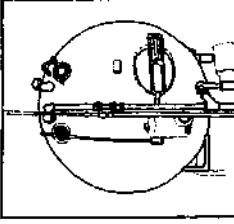

# FUEL ALCOHOL PRODUCTION

## A SELECTIVE SURVEY OF OPERATING SYSTEMS

by

Cliff Bradley  
Bob Moody  
Rod Portch  
Ken Runnion

*Edited by*  
Jon Sesso

*Illustrations by*  
Hans Haumberger

*Graphics by*  
Kris Ellingsen

*Typesetting by*  
Evelyn Tracy

January 1981

This report was prepared by the Research and Development Staff of the National Center for Appropriate Technology, with support in part by the National Alcohol Fuels Commission.

The information contained herein is, to the best of our knowledge, accurate as of July 31, 1980. Neither the National Center for Appropriate Technology, nor any of their employees, contractors or subcontractors, make any warranty, express or implied, or assumes any liability or responsibility for accuracy, completeness or usefulness of any information, apparatus, product or process.

The National Center for Appropriate Technology is in no way endorsing or disapproving of any product, process, company or individual.

No portion of this report may be taken out of context so as to alter any statement.

Principal funding for the National Center for Appropriate Technology (NCAT) is provided by the U.S. Community Services Administration.

NCAT's goal is to encourage widespread use of appropriate technologies that help alleviate problems of low-income Americans. NCAT will grant permission freely for individuals, organizations and publishers who share that goal to reproduce any part of this publication for further distribution, provided that proper credit is given to NCAT. Write: Publications Editor, NCAT, Box 3838, Butte, Montana 59701

Copyright 1980 by the National Center for Appropriate Technology.

# Contents

Disclaimer	1
Preface	3
Introduction	4
Glossary	6
Data Summary of Eight Alcohol Production Plants	8
<b>Apple Agri-Sales</b>	10
<b>Beckman Construction Company</b>	14
<b>Boucher Rural Products</b>	18
<b>Butters, Randy</b>	22
<b>Day, Dennis</b>	26
<b>Harris, Gary</b>	30
<b>Schroder Farms Alcohol</b>	34
<b>Tennessee Gasohol Commission</b>	40
Resource Directory	48

# Preface

In July, 1980, the National Alcohol Fuels Commission funded NCAT to do a survey of small-scale, on-farm alcohol production systems. The Commission sponsored the information-gathering effort to increase the public's knowledge and understanding of this emerging renewable energy technology.

Selection of the eight systems began with a telephone survey of over 100 small-scale alcohol "producers." Names were obtained from the Commission, the American Agriculture Movement, the National Gasohol Commission, the Department of Energy's Office of Alcohol Fuels, the National Alcohol Fuel Producers Association and referrals from "producers." However, the majority of those contacted were in the planning or design phase of their projects and did not have an operating system. Thus, from the list of 100 contacts, NCAT identified 19 operating fuel alcohol production systems, from which eight were selected for this survey.

Some of the units have been constructed by individuals for their own use; others are prototypes of units intended for commercial sale. Each of these systems can be improved upon but nonetheless provide a representative sample of the present state of development in small-scale alcohol production. The reader should remember that there is presently no small-scale alcohol production system that is mass-produced fully warranted, and independently tested to verify the manufacturer's claims. Current small-scale producers are pioneers in the truest sense of the word.

One such pioneer was Bill Schroder. Unfortunately, Bill died recently in a tragic fall while building a new system. The tragic accident occurred just after this survey was completed, and to express our sincere condolences to the Schroder family, the NCAT survey team *heretby dedicates this book in Bill's memory.*

Cliff Bradley  
Bob Moody  
Rod Portch  
Ken Rynnion



# Introduction

As each day passes, fossil fuels become more expensive and less available. In turn, a host of energy alternatives are being examined that can help meet future energy demands. One alternative fuel that shows considerable promise, especially for transportation, is *ethyl alcohol*.

The idea of using ethyl alcohol for fuel is not new; it was explored during the early years of the automobile industry. In fact, Henry Ford believed that alcohol produced from biomass was "the fuel of the future." But in that era of cheap, abundant fossil fuels, alcohol could not compete. Today, things are different.

The technology for alcohol production through fermentation is well-developed in this country, but most systems are designed to produce beverage alcohol and not fuel-grade alcohol. Consequently, numerous designs for fuel alcohol production systems have appeared recently, each one said to be cheaper, simpler and more efficient than the next. Unfortunately, an equal number of conflicting claims on the cost and production capability of these systems also have appeared, creating a considerable amount of distress for individuals and groups trying to decide on the size, type, or indeed, the practicality of owning and operating an alcohol system.

*The purpose of this survey is to help people make informed decisions about fuel alcohol production.* The descriptive survey provides baseline information on eight operating alcohol production systems. These systems use a variety of feedstocks, range in cost from a few thousand to several hundred thousand dollars and vary considerably in production capability. The information should help people determine whether fuel alcohol

production is feasible for them, and if so, what kind of system adequately suits their needs.

This eight-site survey is not designed to provide a comprehensive review of all alcohol systems, rather it is intended to provide an overview of a variety of systems.

Undoubtedly, a number of groups or individuals working in the field were overlooked or were not available for comment. However, NCAT feels that these eight systems provide a representative cross section of on-farm fuel alcohol plants.

The information presented is based on the answers received from the operators. No actual testing or quantitative evaluation of the systems' performance was made by NCAT.

**Also, the system schematics presented are not drawn to scale and should not be used as accurate design drawings of the alcohol units.** If you have any questions or request additional information about a particular system, contact the operator directly. Remember to enclose a self-addressed stamped envelope with your request.

NCAT believes that small-scale fuel alcohol production has its place on the farm. It creates an alternative use for crops, thus strengthening the farmer's position in the market place. If produced efficiently, alcohol can partially replace the use of imported oil, thus easing the pressure of escalating fuel prices on rural farm communities. Combined with other energy alternatives, alcohol fuel can offer farmers an opportunity to become energy self-sufficient.

Alcohol fuels alone will not solve America's energy problems. But alcohol production can contribute to the solution and impact favorably on America's rural economy.

For those who have determined, after reviewing this survey, that installing a fuel alcohol production is feasible, the operators have identified the following list of concerns.

★ *Obtain the proper Alcohol, Tobacco and Firearms permits. Your regional ATF office can identify which permits are necessary in your state.*

★ *Get good technical help, preferably from someone who is operating a system successfully.*

★ *Learn and understand all the important steps in the production process (see next page).*

★ *Start with a small system if good technical help is not available, as you gain experience you can gradually go to a larger unit.*

★ *Remember that an alcohol plant is more than a storage unit. It is an integrated production system that handles cooking, fermentation and distillation steps.*

★ *Look for a market system to grow farm products from your community and to market them locally.*

★ *Don't try to do it all yourself. Can you afford a local market for the fuel?*

★ *How long to build or if the regulations or products is there a market for the alcohol?*

# FUEL ALCOHOL PRODUCTION PROCESS

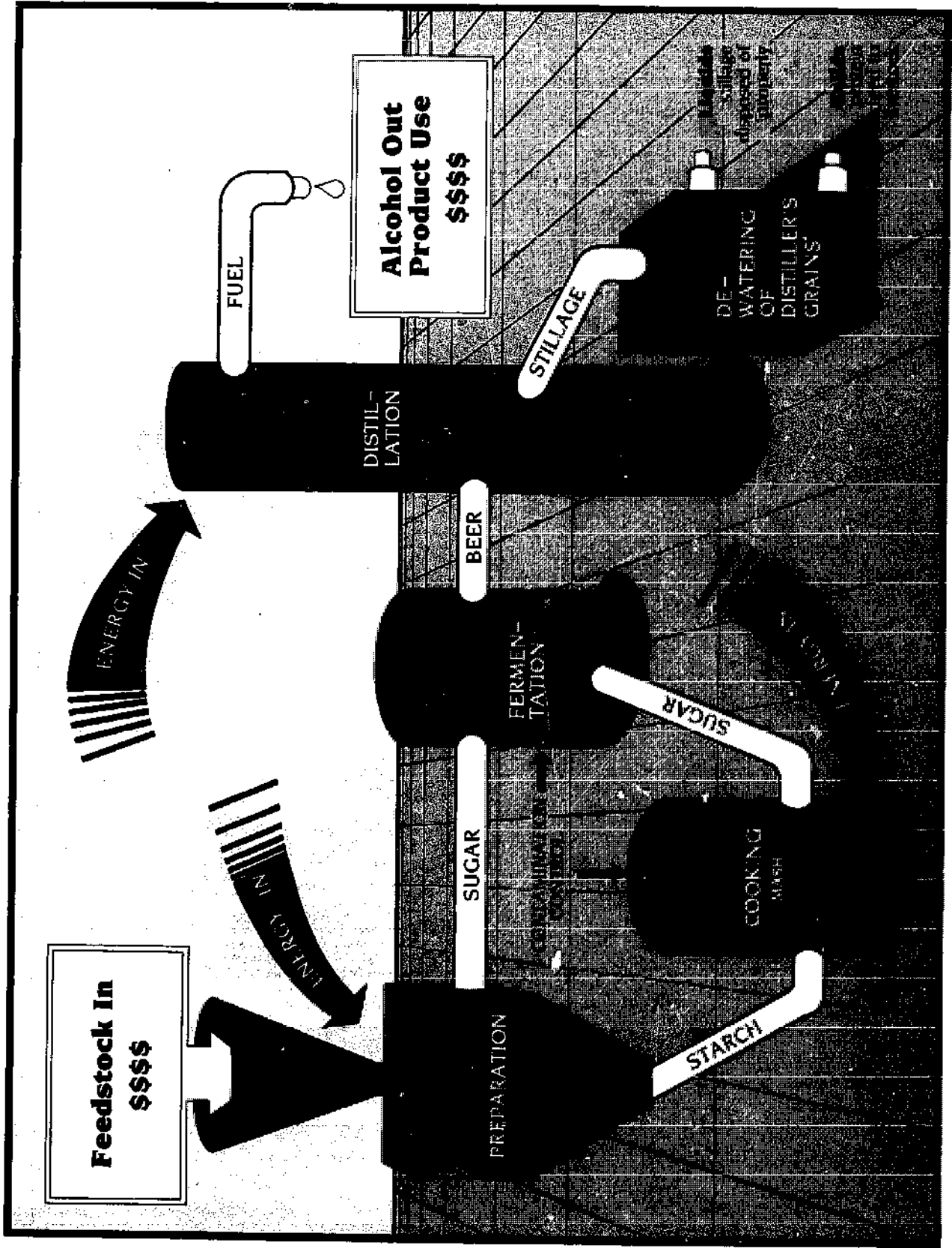

# Glossary

**AGITATOR:** A device, such as a stirrer that provides complete mixing and uniform dispersion of all components in a mixture. Agitators are generally used continuously during the cooking process and intermittently during fermentation.

**AUGER:** A rotating, screw-type device that moves material through a cylinder. In alcohol production, it is used to transfer grains from storage to the grinding site and from the grinding site to the cooker.

**AZEOTROPE:** Two liquids that have a constant boiling point at some concentration of each component. Water and ethyl alcohol form an azeotrope which is approximately 5 percent water and 95 percent alcohol; such an azeotropic mixture cannot be separated further by simple distillation.

**BATCH DISTILLATION:** A process in which the liquid feed is placed in a single container and the entire volume is heated, in contrast to continuous distillation in which the liquid is fed continuously to the still.

**BATCH PROCESS:** Unit operation where one cycle of feedstock preparation, cooking, fermentation and distillation is completed before the next cycle is started.

**BEER:** A low-level (6-12 percent) alcohol solution derived from the fermentation of mash by microorganisms.

**BOILER:** A unit used to heat water to produce steam for cooking and distillation processes.

**BOILING POINT:** The temperature at which a liquid changes phases and becomes a gas; when the vapor pressure of the liquid is equal to the vapor pressure of the system (i.e., atmospheric pressure).

**CONCENTRATION:** The quantity of ethyl alcohol (or sugar) present in a known quantity of water. Weight percent is the weight of alcohol (or sugar) per volume of water. Volume percent is the volume of alcohol (or sugar) per volume of water.

**CONDENSER:** A heat transfer device that uses cold water to change the ethyl alcohol from a vapor to a liquid.

**COOKER:** A heated tank with an agitator that cooks the grain/water mixture.

**COOKING:** The process that breaks down the starch granules in the grain and makes the starch available for the liquefaction and saccharification steps.

**DISTILLATION:** The process by which the components of a mixture are separated by boiling and resultant vapors are recondensed into isolated liquids. The main components in this case are water and ethyl alcohol.

**DISTILLERS GRAIN:** The residue of non-fermentable solids that remains after grain fermentation. This material is high in protein (20-30 percent) and is a good animal feed.

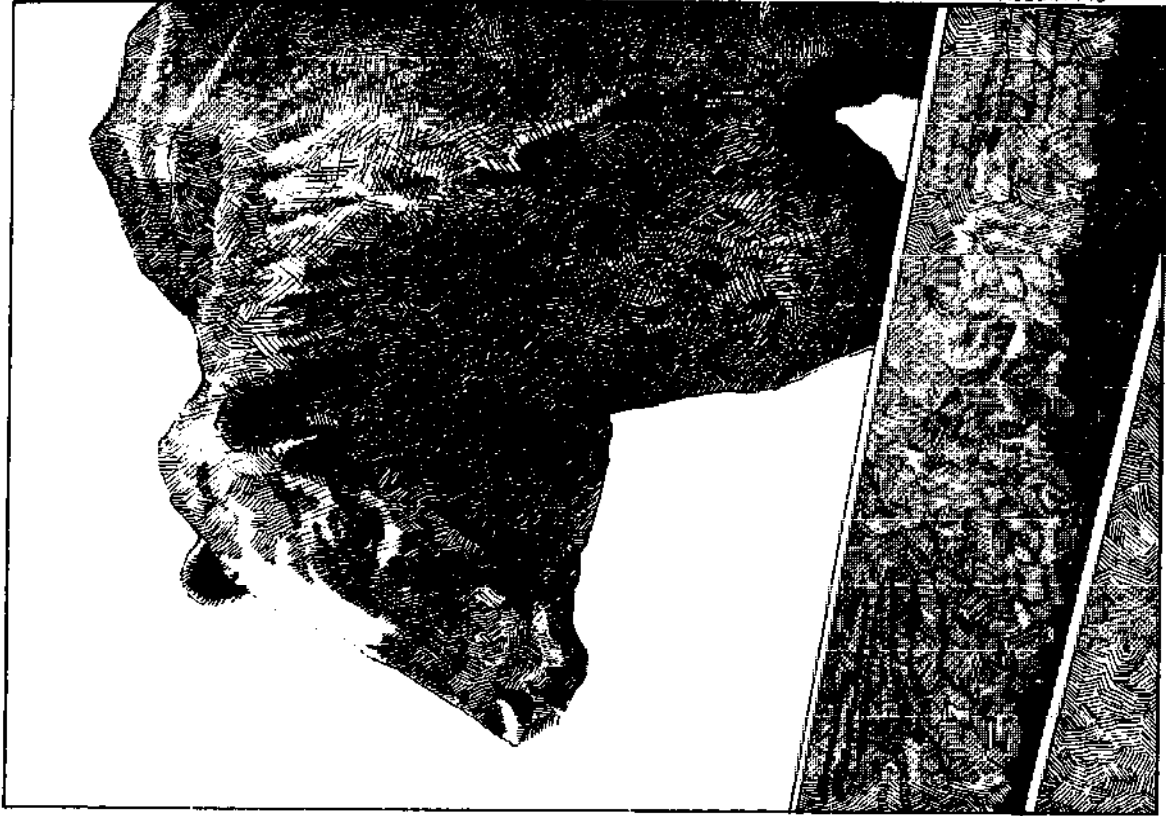



- ENZYMES:** Organic substances produced by bacteria or fungi in the cells of living organisms that catalyze specific chemical changes in the liquefaction and saccharification steps.
- ETHYL ALCOHOL:** A flammable organic compound ( $\text{C}_2\text{H}_5\text{OH}$ ) formed during sugar fermentation. It is also called ethanol, grain alcohol or simply alcohol.
- FEEDSTOCK:** The raw material, such as grain, fruit, or other agricultural products, used as the sugar source in the fermentation process.
- FERMENTATION:** The biological sequence of enzymatic reactions that convert sugars into  $\text{CO}_2$  and alcohol in the absence of oxygen, generally refers to metabolism in the absence of oxygen.
- GLUCOSE:** The primary component of starch and cellulose, this sweet, colorless sugar is the most common in nature and most commonly fermented by yeast to produce ethyl alcohol. It contains six carbon atoms ( $\text{C}_6\text{H}_{12}\text{O}_6$ ).
- GPH:** Gallons per hour; units used to identify distillation rate.
- HEAT EXCHANGER:** A unit that transfers heat from one liquid (or vapor) to another without mixing the fluids. A condenser is one type of heat exchanger.
- LIME:** A white powder composed of calcium oxide that forms a highly alkaline solution when mixed with water. Lime is used to increase the pH of mash.
- LIQUEFACTION:** The process by which starch is broken down into short chains of glucose molecules. Starch in water forms an insoluble gel; when a liquefaction enzyme is added to the mixture, the long chains of glucose molecules (starch) are broken up and the gel liquefies.
- MASH:** A mixture of crushed grains and water that can be fermented to produce ethyl alcohol.
- MOLECULAR SIEVE:** A packing material that separates molecules (i.e., ethyl alcohol from water) by selective absorption of molecules on the basis of size.
- PACKED COLUMN:** A type of distillation column or pipe that is filled with high surface-area materials, such as metal fillings, ceramic saddles, or plastic or glass beads.
- pH:** A scale that measures the acidity or alkalinity of a solution. An acidic solution has a pH less than 7; a neutral solution has a pH of 7, and an alkaline solution has a pH greater than 7.
- PRECULTURE:** A process in which the alcohol-producing yeast are propagated prior to introduction into the fermentation tank. Preculturing ensures a high concentration of active yeast, thus reducing the time required for fermentation and controlling the production of unwanted bacteria.
- PROOF:** A term used to measure the volume content of ethyl alcohol in water. The proof content is twice the alcohol percentage (i.e., 100 proof is 50 percent alcohol by volume).
- PROTEIN:** High molecular-weight compounds composed of amino acids. Proteins are an essential ingredient in the diet of animals and man.
- RECTIFYING COLUMN:** The section of the distillation column in which the alcohol concentration is increased by repeated interaction of the rising vapor with the liquid distillate. This section is above the beer injection point.
- REFLUX:** The condensed liquid alcohol that is reintroduced into the top of the distillation column; this process increases the alcohol concentration of the liquid through more efficient separation.
- SACCHARIFICATION:** The process by which short chains of glucose formed in the liquefaction step are converted into single glucose molecules by acids, bases or enzymes.
- SIEVE PLATE COLUMN:** A type of distillation column that uses a series of perforated plates to promote the interaction of liquid and vapor in the column.
- STARCH:** Long chains of glucose molecules bound together. Starch is a major component of potatoes and grains, and can be broken down into glucose and other simple sugars.
- STILL:** An alcohol production unit that consists of a container for heating a beer solution, a distillation column for separating the alcohol and water, and a condenser for capturing the alcohol vapors.
- STILLAGE:** A grain mixture of nonfermentable solids and water that remains after the alcohol is removed through distillation; also called spent beer.
- STRIPPING COLUMN:** The section of the distillation column in which the alcohol concentration in the starting beer solution is decreased. This section is below the beer injection point.
- SULFURIC ACID:** A strong acid ( $\text{H}_2\text{SO}_4$ ) used to lower the pH (increase the acidity) of a solution. Also known as battery acid, it can be obtained from most automotive stores.
- TAPERED AUGER:** A rotating screw-type device used to dewater the stillage or mash in preparing this material for animal feed.
- VAPORIZATION:** The process of converting a compound from a liquid or solid state to the gaseous state. Alcohol is vaporized during distillation.
- YEAST:** Single-celled microorganisms that ferment simple sugars into ethyl alcohol and carbon dioxide. Yeasts are one type of fungi.

# DATA SUMMARY OF EIGHT ALCOHOL PRODUCTION PLANTS

PROJECT	FEEDSTOCK	GALLONS OF WATER PER BUSHEL OF FEEDSTOCK	ENZYMES	YEAST	BEER ALCOHOL CONTENT (percent)	DISTILLATION COLUMN DIMENSIONS (height/ diameter, number of columns)
<b>Apple</b>						
<b>Agri-Sales</b>	corn	26-30	Biocon	GB Red Star	8-10	10'5½"
<b>Beckman Construction Company</b>	miló	25	Miles	Miles	8-10	16'12" (two columns)
<b>Boucher Rural Products</b>	corn potatoes sweet sedan sargo fodder beets wheat	30	Biocon	Biocon	10½	10 bu. 16'2"16" 9'8"13"
<b>Butters, Randy</b>	corn	18	Miles	local distillery	8-9	17'12" (two columns)
<b>Day, Dennis</b>	corn	20	Biocon	Biocon	8-10	60'16"
<b>Harris, Gary</b>	barley	30	Miles	Biocon	5	16'12" (two columns)
<b>Schroder Farms Alcohol</b>	miló corn	16	Miles Nova	all brands available	12	16'16" (three columns) 1
<b>Tennessee Gasohol Commission</b>	waste fruit corn garbage	20	Biocon	Biocon	8-10	6'13" (two columns)

N.A. means data not available

COLUMN INTERNALS	DISTILLATION RATE (8 ph)	GALLONS OF ALCOHOL PER BATCH	GALLONS OF ALCOHOL PER BUSHEL OF FEEDSTOCK	PRODUCT ALCOHOL CONTENT (percent)	BOILER FUEL	ENERGY INPUTS (Btu/gallon of alcohol)	LABOR (hours/batch)	SYSTEM COST
metal turnings	5-6	35-40	2.5	90	propane	64,000	2	\$8,000
Sieve plates	25	150	2.5	94.5	fuel oil or natural gas	39,000	8	\$85,000
	3	10 bu. 25						10 bu. \$6,000
glass beads	0.7	1 bu. 2.5	2.5	90	propane or wood	55,000	8-10	1 bu. \$2,400
Sieve plates	15-20	90	1.5	90-91	fuel oil	N.A.	5-6	\$14,000
burrel ceramic saddles	17	150	2.3-2.6	87.5-90	fuel oil	21,000	8-10	\$30,000
Sieve plates	20-25	70	N.A.	80-85	waste oil	N.A.	12	\$10,000
Sieve plates	40	3000	2.5	95	diesel oil	24,000	24 <sup>3</sup>	\$400,000
metal turnings	N.A.	30-40	N.A.	80	waste wood or garbage	N.A.	N.A.	\$1,200

1. Two rectifying columns are 16"/12"

2. Anhydrous distillation requires an additional 4000 Btu/gallon.

3. A continuous operation. One person on duty at all times.

## PROJECT:

# Apple Agri-Sales Rural Route No. 6 Crawfordsville IN 47933

CONTACT: Phil Apple

Phil Apple owns Apple Agri-Sales and has been operating his Tri-Star still since April, 1980. The unit is a propane-fired batch still. A single-tank unit costs approximately \$8,000 and a three-tank unit for multiple-batch operation is about \$18,500.

## FEEDSTOCKS/PREPARATION

Apple uses corn only. The corn, which comes directly from the local elevator across from Apple's shop, is ground through a 3/16 inch screen (fine-grade, ground corn) for animal feed.

## COOKING

Approximately 200 gallons of water are heated to 150°F and the proper amount of liquefaction enzyme is mixed into the 500 gallon tank. After a few minutes, approximately 14 to 16 bushels of ground corn are added. Then the mixture is boiled and stirred constantly for 30 to 40 minutes.

When the liquefaction is complete, the mash is cooled to 140°F by adding cold water to the tank. The pH is adjusted to 4.5 and the saccharification enzyme is added. The mash, mixed constantly with a paddle wheel stirrer, is held at 140°F for about 30 minutes. Then the mash is cooled to 90°F by adding more cold water to the tank and by circulating water through cooling coils. Final volume is about 26-30 gallons of water per bushel of corn. Apple uses Biocon enzymes and recipes.

## FERMENTATION

When the mash has cooled to between 88 to 91°F it is ready for fermentation. Apple uses GB-Red Star yeast, approximately a one pound package per batch. The dry yeast are added to the mash, stirred constantly for about one hour and then left to ferment for approximately 60 hours. Automatic temperature sensors cycle water through the cooling coils to maintain the temperature between 88° and 93°F. When the cooling cycle is engaged, the mixing paddle starts up. During the winter when the cooling cycle is not required, the mixer is operated manually for about five minutes each morning and night to stir up the mash. Alcohol concentrations in the beer have been estimated at 8-10 percent.

## DISTILLER GRAINS

A screen box separates the solids from the liquid in the spent beer. Upon completion of the distillation cycle, the tank is drained into a large, shallow box with a screen at the outfall end. The solids are dewatered for 24 hours and the liquid is discharged to a gravel drain field. The solids, at about 80 percent moisture, are fed to a neighbor's steers. The cattle raised on the wet distillers grains are doing well.

The wet feed is sun-dried to prolong storage. According to Apple, an average of 16 to 18 pounds of distillers grains is obtained per bushel of corn and this feed averages about 28 percent protein.

## PRODUCT USE

The fuel alcohol is used in Apple's 1977 Chevrolet truck. At first, Apple experienced a problem with clogged fuel filters; but after enough alcohol was run through the fuel system to clean it up, the truck ran well, with no problems in starting, acceleration or loss of mileage. He uses a fine-grade fuel filter now to strain out any sediment that might collect with the alcohol.

## DISTILLATION - Batch

The Tri-Star unit uses a triple-tube, propane-fired burner. When fermentation is complete, the mash is heated. The alcohol and water vapors are driven off the mash and travel up a distillation column packed with metal turnings. The temperature at the top of the column is maintained at 174°F via a water jacket. The column and condenser are each 10 feet tall, with a 5½-inch inside diameter and a 6-inch outside diameter. The distillation rate varies with the concentration of alcohol in the beer, but averages about 5-6 gph of 90 percent alcohol (180 proof).

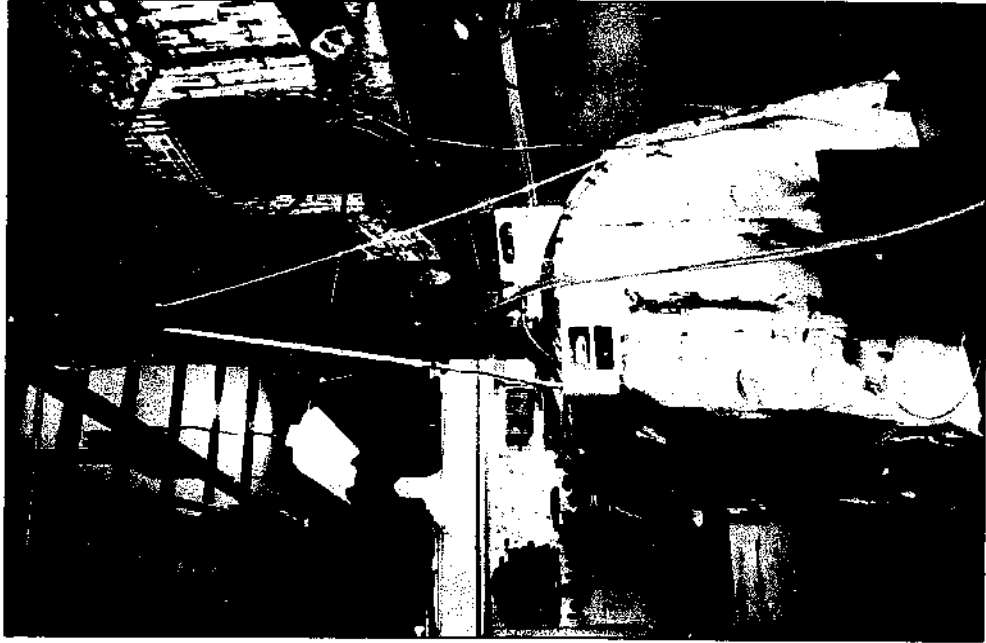

The Tri-Star still (above) is almost fully automated and is becoming part of Apple's daily farm-chore routine. He transports the three-tank unit (left) to fairs and expositions to help convince his Indiana neighbors that alcohol production is feasible.

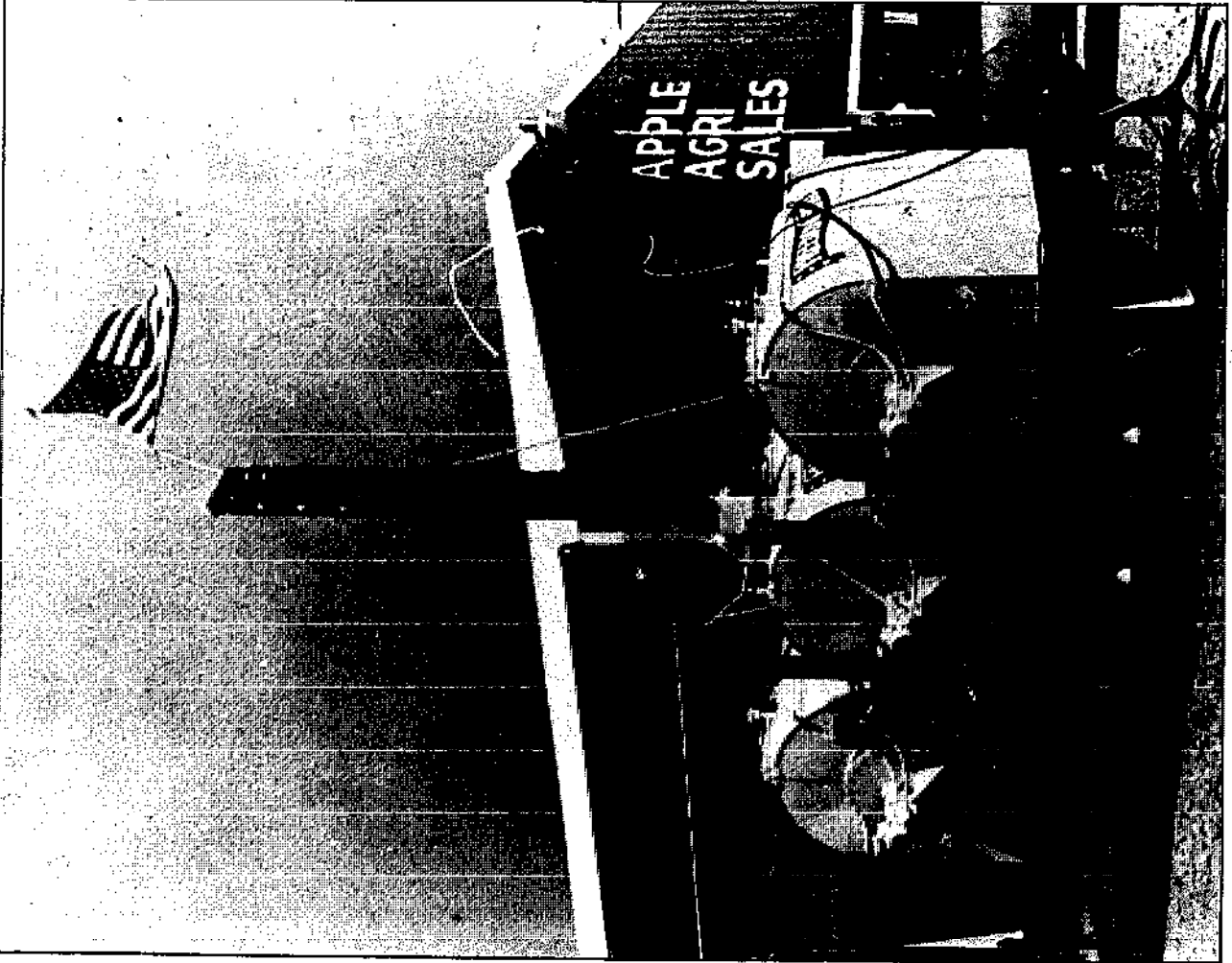

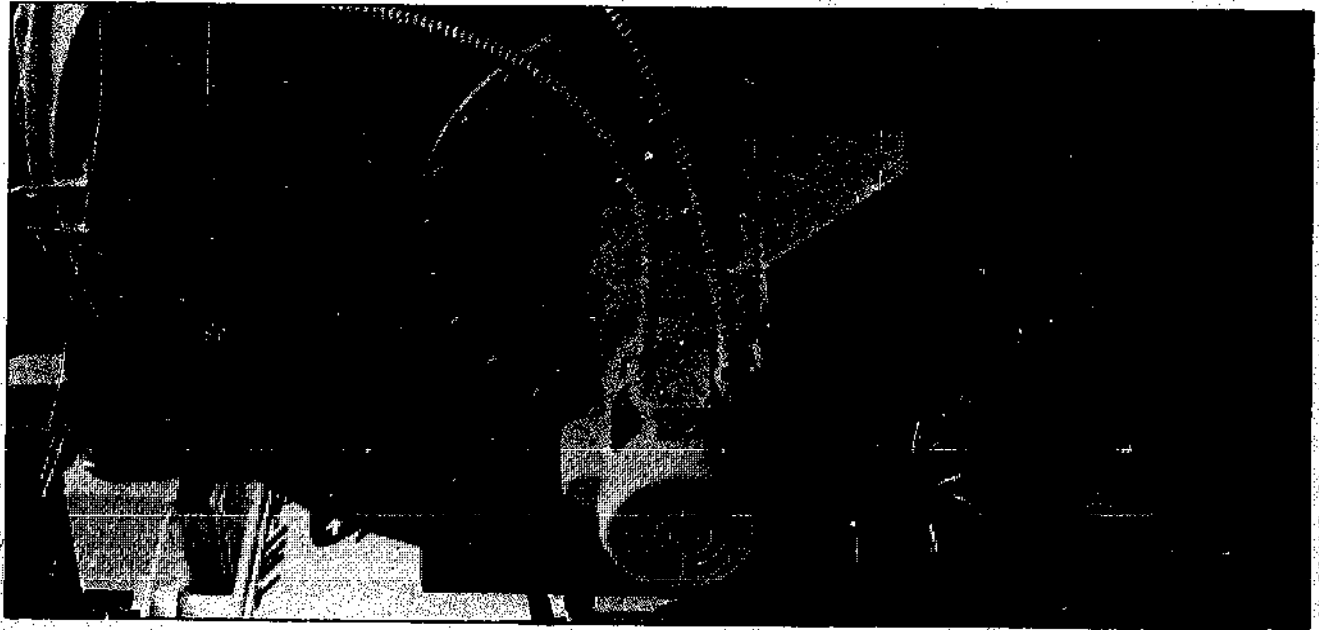

The 3/4 HP electric motor drives a four-blade agitator.

### ENERGY INPUTS

Apple estimates the energy input on his propane-fired, single-tank unit at 64,000 Btu/gallon of ethanol. However, with proper insulation of the tanks and column, water recycling and heat exchangers, Apple thinks energy inputs will drop to between 40,000 and 42,000 Btu/gallon. Electrical energy costs for the stirrer and process controls are 0.4 to 0.6 cents per gallon.

### LABOR

The Tri-Star unit is fairly automatic with temperature sensors and a timer to control most of the cycles. "Once you've loaded the system (made your mash), it pretty much runs by itself. You should check it periodically during the distillation cycle to make sure it's running OK," says Apple.

Apple estimates two manhours are required per 30 to 40 gallon batch of alcohol. He plans to automate the system even more and make it simple enough to be part of the daily farm-chore routine.

### CONTAMINATION CONTROL

Thus far, Apple hasn't had any problems. He recommends that the system be flushed out with water after every third or fourth batch. However, he has run more than 10 batches in succession without a cleanout. "Every time you distill the mash, you sterilize the system. We've never made a bad batch yet..."

### DESIGNER COMMENTS

Apple says the Tri-Star system is designed to be: 1) efficient in the conversion of corn to alcohol; 2) easy to operate; 3) adaptable to various operations; 4) affordable; and 5) relatively maintenance free. He feels his system "fills the bill" and is looking for better ways to insulate the unit and conserve heat to make it more energy efficient. For the average Indiana farmer, the system produces enough alcohol to satisfy most on-farm fuel needs.

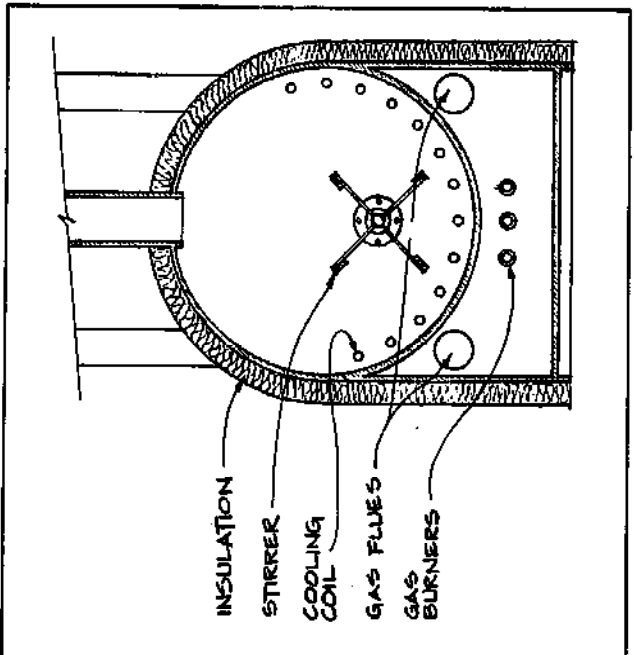
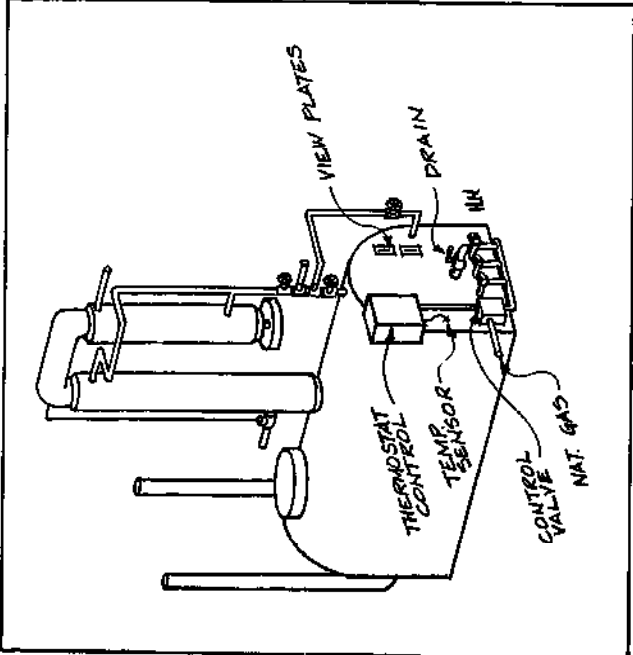

END VIEW, CUT-AWAY

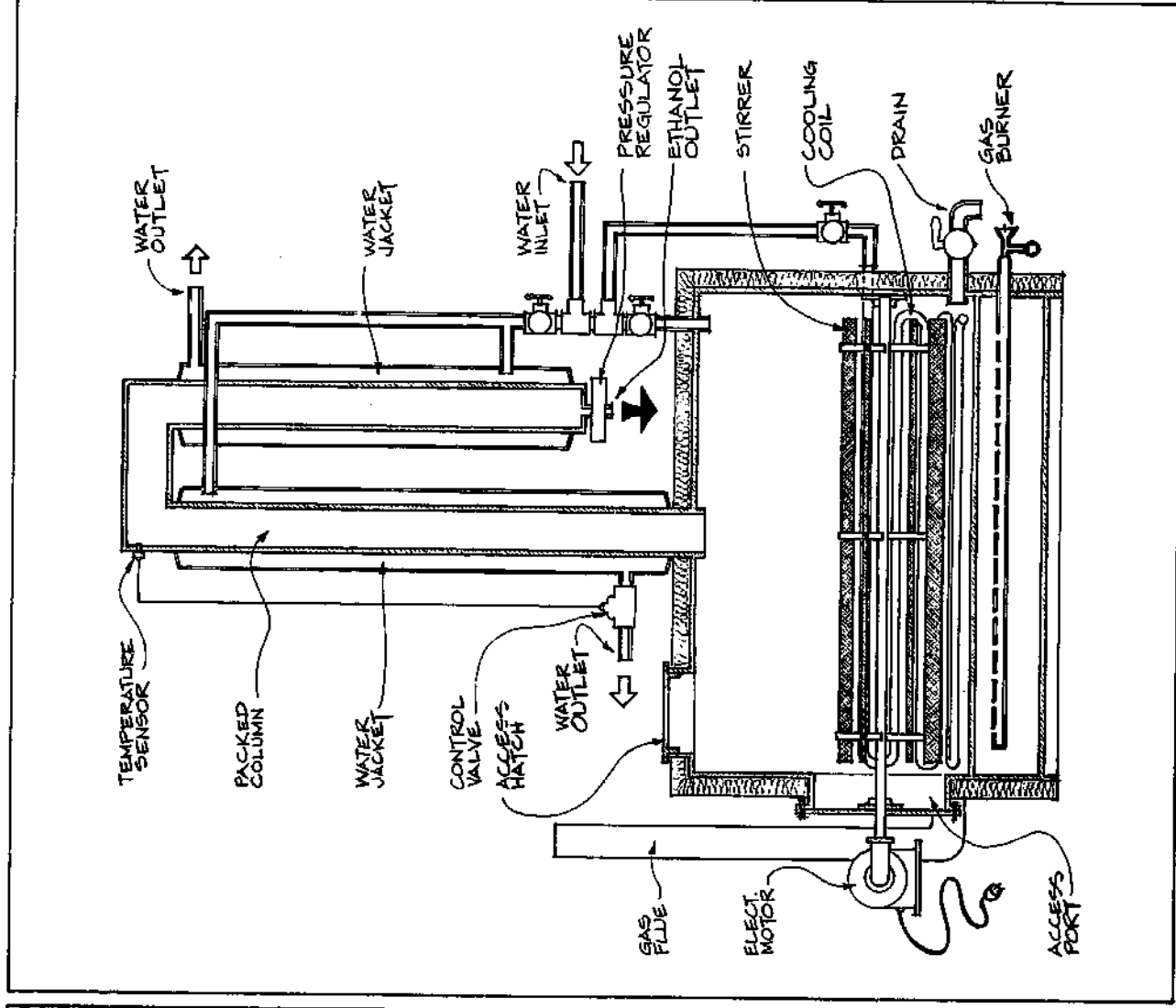

SIDE VIEW, CUT-AWAY

## PROJECT:

**Beckman Construction Co. 7201 W. Vickery St. Fort Worth, TX 76116**

CONTACT: Larry D. Gossett

Beckman Construction Company has developed a farm-sized fuel alcohol plant as a prototype for a larger plant design. Larry Gossett, vice-president of Beckman's alcohol engineering division, has operated the batch plant since January of 1980. Including their experimental laboratory and the numerous design changes in the pilot plant, Beckman has invested over \$175,000 to design and construct this prototype. Although Beckman does not intend to market small plants (the company plans to design and build larger commercial-sized units), Gossett says the prototype would sell for approximately \$85,000.

**FEEDSTOCKS/PREPARATION**

Many different feedstocks have been used including bakery waste, stale donuts, cookie dough, biscuit dough, sweet sorghum, sweet sorghum silage, sweet sorghum juice, and grains, such as milo.

Milo, obtained from a commercial supplier, was used to standardize the plant. Using a hammermill, the milo is ground to approximately 20-25 percent retention on a number 20 mesh screen (see photo). Rolled milo was also tried but hammermilled milo produced better results.

**COOKING**

About 60 bushels of milo are cooked in the 1500-gallon batch tank. The milo is added to about one-half tank of water. Using constant agitation, the liquefaction enzyme is added and steam is injected directly into the tank, raising the temperature to 195-200°F. The mash is held at this temperature for 30 minutes.

When the liquefaction is complete, the mash is cooled to 140°F by adding water directly into the tank and by circulating cooling water in the outside shell of the cooker. The saccharification enzyme is added and the mash is held at 140°F for approximately 30 minutes. Final volume is approximately 25 gallons of water per bushel of milo. Beckman has evaluated many kinds of enzymes and has standardized their operation using the Miles Laboratory enzymes Takatherm and Diazyme.

**FERMENTATION**

The saccharified mash is cooled to between 85° and 105°F; the mean temperature of 95°F is optimum. It is then inoculated with distillers active dry yeast (from Miles Laboratory) at a concentration of one pound per thousand gallons (1½ pound/1500-gallon batch). The yeast is premixed in five gallons of warm water at least 10 minutes before addition to the mash. During fermentation, the temperature and pH of the mash are not controlled and there is no mechanical agitation. According to Gossett, the beer reaches 8.5 percent alcohol after 26 hours of fermentation and 10 percent alcohol after 48-60 hours. When the fermentation cycle is complete (60 hours), less than 0.1 percent sugar and less than 3 percent starch are left in the mash (figures confirmed for Beckman by an independent laboratory).

**DISTILLATION—Continuous**

During distillation the beer in the cooker-fermentation tank is agitated constantly for the first hour and last hour, and sporadically in between to keep the solids stirred up. Steam from the boiler is used to distill the beer being pumped into the stripper column. The stripper column is 12-inches in diameter, 16-feet tall and made with sieve plates spaced up the length. The beer is fed into the upper portion of the stripper column and steam is injected into the bottom. The alcohol/water mixture increases in proof to its azeotrope as it travels up the rectifier column (also 12-inches in diameter, 16-feet tall).

Centrifugal pumps supply reflux to the top of the stripper and rectifier columns. Product alcohol flows into a storage tank from a water-cooled condenser. A hydrometer in the line monitors the proof of the alcohol going into the storage tank. *The columns use a cartridge-type plate arrangement to facilitate cleaning, which is recommended once or twice a year to remove protein buildup on the plates.*

The distillation column produces 94.5 percent alcohol (189 proof) at a rate of 25 gph. Yields are 2.54 gallons/bushel of milo. The alcohol content remaining in the spent mash is less than 0.01 percent (measured by an independent laboratory).



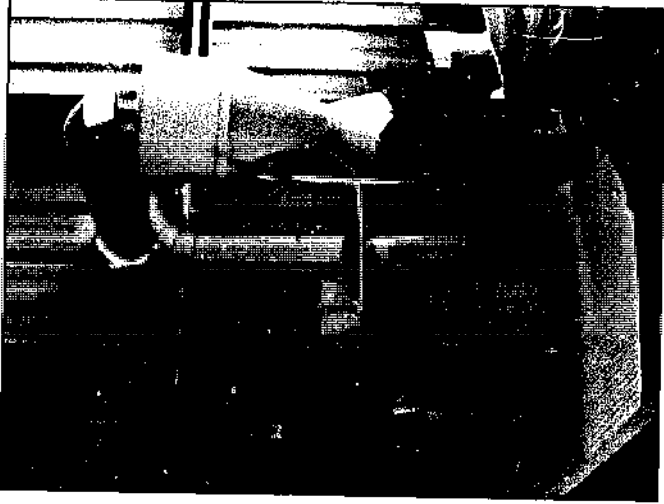

The hammermill (above) is used to grind feedstock for the Beckman system. Gossett (in the striped shirt at left) says the experimental system has generated a great deal of interest among fellow Texans.

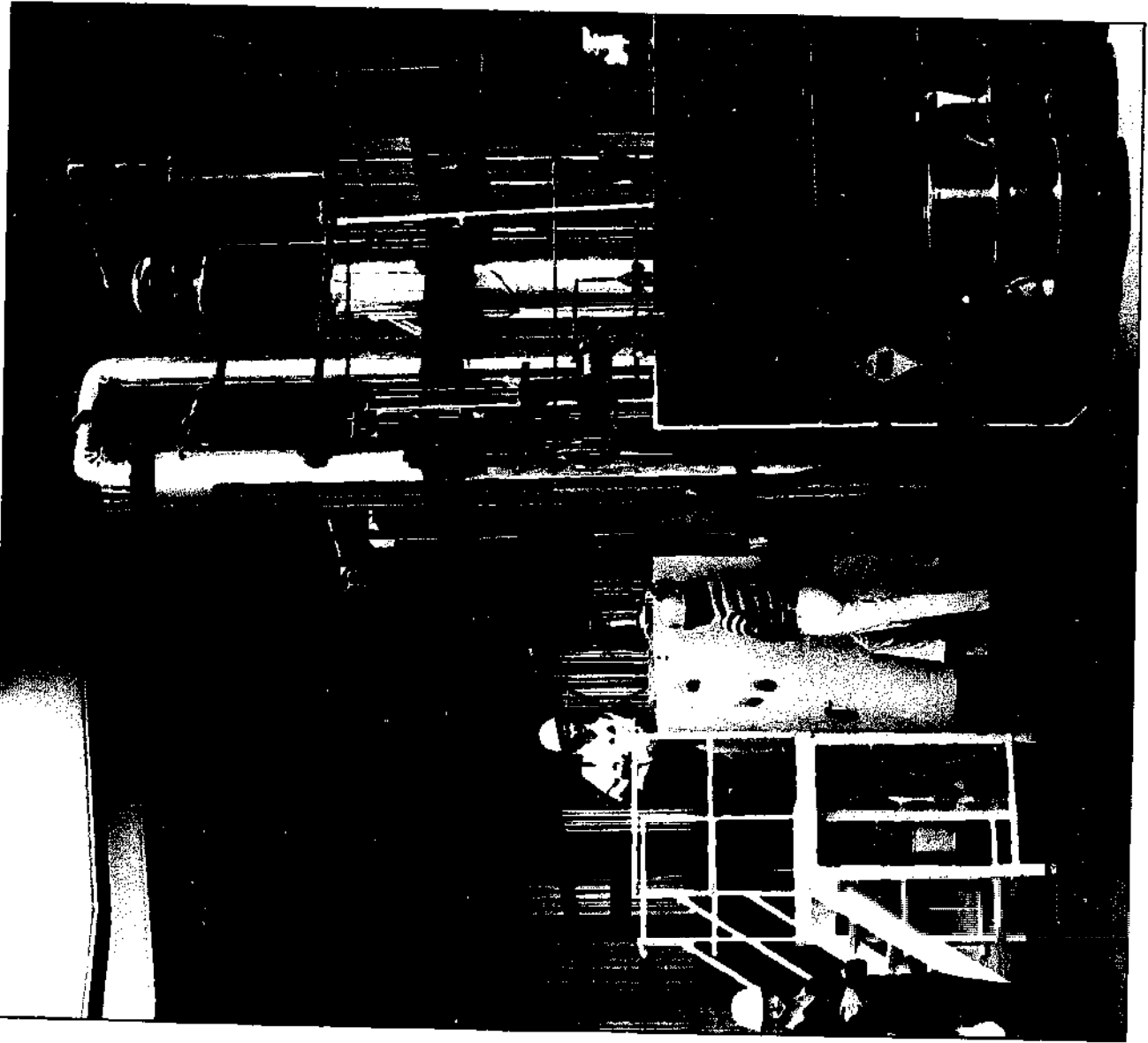

## BECKMAN'S SYSTEM

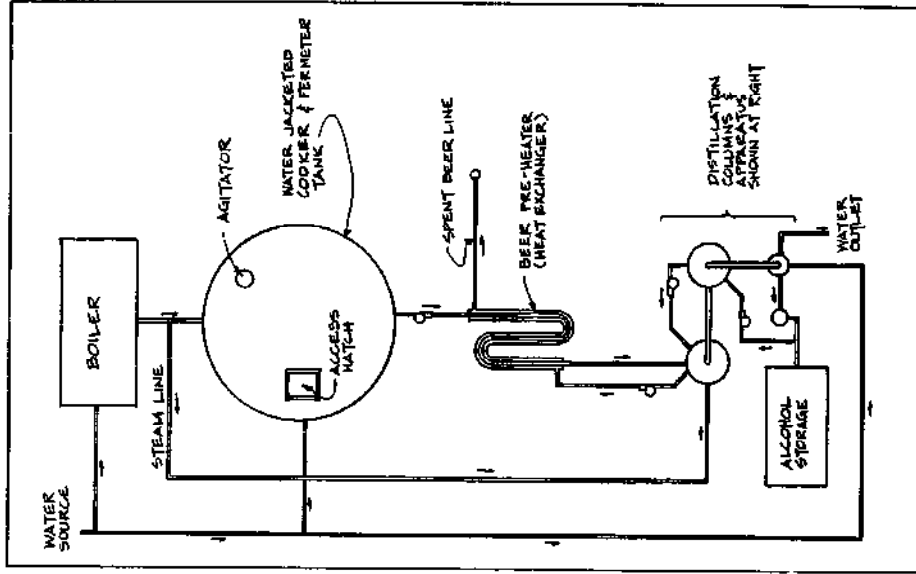

TOP VIEW

### DESIGNER COMMENTS

The Beckman plant uses milo because the grain is locally available, but the system should work equally well with any fermentable feedstock. Gossett wouldn't discuss the yields obtained with other feedstocks because that work was paid for by private clients and results are confidential.

Gossett's personal comments are timely in nature.

"The first thing I'd say to a farmer is be honest with yourself. If you can get more money for your grain down at the co-op than you have figured the alcohol is worth (to you or somebody else), then sell your grain to the co-op. Don't get yourself into a corner where you have to be making alcohol. The farmer ought to get the best price he can for his crop."

Another important point is to get good technical help if you need it, and get it from somebody who has made alcohol. Gossett worked with Dr. Paul Middaugh of South Dakota State University during the initial phases of the Beckman alcohol project.

"Be sure to investigate the track record of those who intend to help you or sell you a plant. Have they actually helped anyone or built a successful, operating (and I mean still operating) plant? If you're buying equipment, make sure that it comes with a guarantee and some training."

### DISTILLERS GRAINS

Gossett has experimented with a centrifuge-type separation system to remove solids from stillage. Independent laboratory tests have shown that the solids from the spent mash contain 29.8 to 31.5 protein. The wet stillage is sold to a local buyer who sells it to dairy farmers in the Fort Worth, Texas area.

### PRODUCT USE

Oil or gas is used to fire the 47½ HP boiler. The boiler supplies steam for the cooking and distillation portions of the production cycle. Using milo, Gossett estimates the net energy costs are 5-6 cents/gallon of ethanol. Total energy inputs are 39,000 Btu/gallon, excluding electricity to run the pumps and motors.

### LABOR

Gossett estimates approximately eight hours of operator time per batch, including the time required for milling the grain and handling the stillage. For a full-sized operation with four fermentation tanks and the plant running seven days a week, 24 hours per day, Gossett projects five operators (i.e. one per shift; one for weekends; one as a backup).

### CONTAMINATION CONTROL

Gossett hasn't had any problems with their pilot plant. He uses good housekeeping techniques and washes down the tanks thoroughly after each batch. No disinfectants have been used.

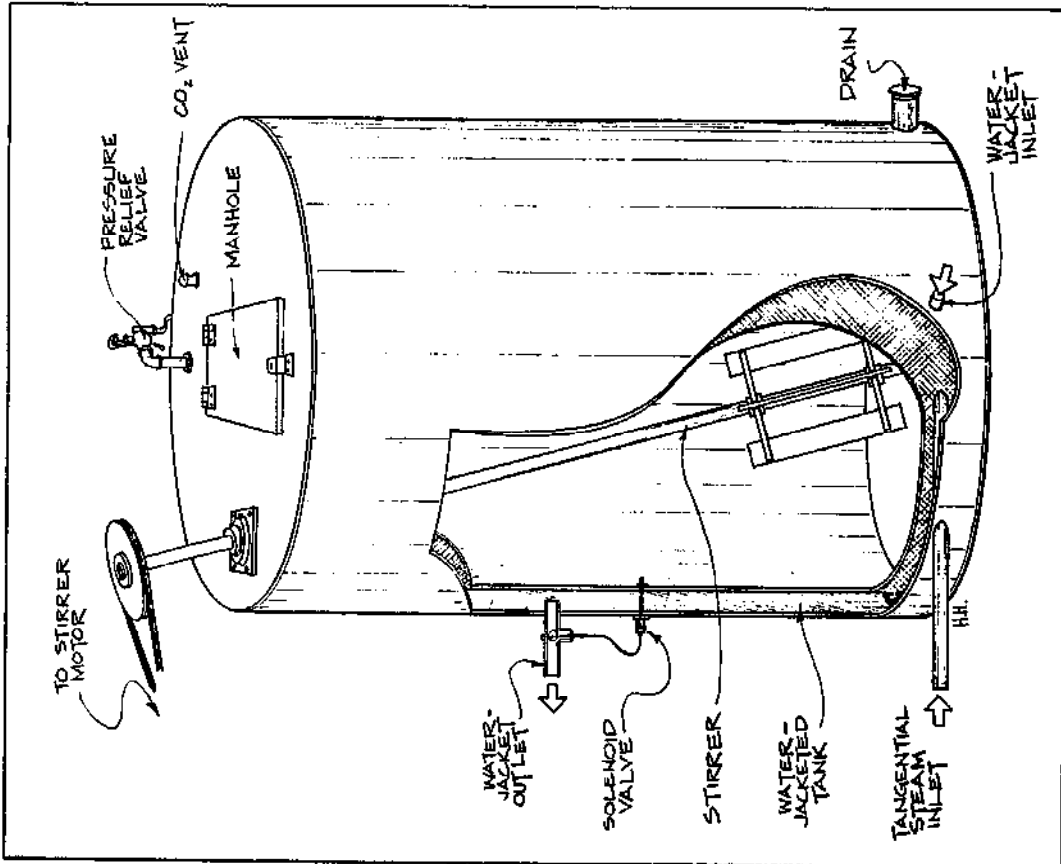

COOKER/FERMENTER

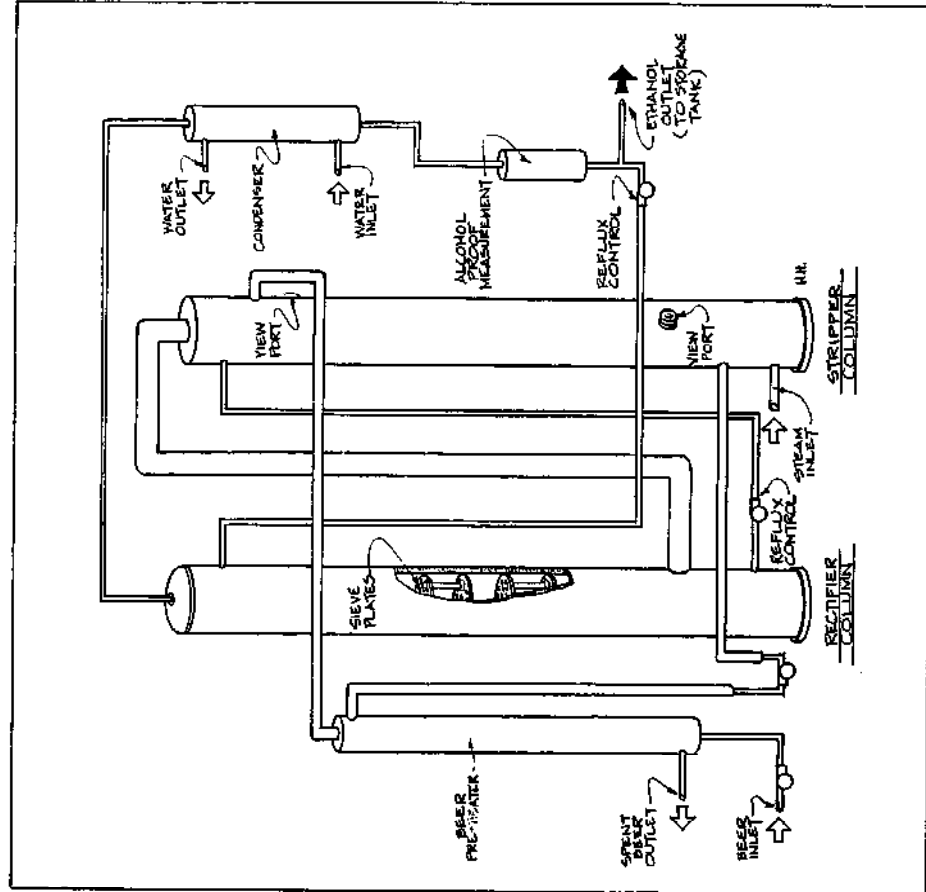

DISTILLATION COLUMNS

## PROJECT:

# Boucher Rural Products Beefmaker Cattle Co. Ravenna, NE 68869

CONTACT: George Boucher

*He has developed two small, experimental models for farm use -- a one bushel and a ten bushel unit. The two batch-type stills are wood- or propane-fired. The one bushel unit sells for \$2,400; the ten bushel for \$6,000. Boucher, who has produced approximately 3,000 gallons of 90 percent alcohol with the two units, is also building a full-scale plant that has 12-inch diameter columns capable of producing 27 gph.*

## FEEDSTOCK/PREPARATION

Boucher uses corn (grown on his farm), potatoes, sweet sudans, sargo, fodder beets and wheat. He also has experimented with alfalfa and ground wood.

To prepare feedstock for larger batches, Boucher always uses a wet extruder to improve consistency. For corn, he recommends grinding or milling the crop through a number 100 mesh screen; this extra step raises the alcohol production per bushel by almost 20 percent, according to Boucher.

## COOKING

The cook tank is half filled with water, heated to 150°F and the liquefaction enzyme is mixed in. (55 gallon tank for the one bushel unit; 450 gallons for the ten bushel.) The corn is added and the mixture is boiled for 20 minutes. *Boucher stresses that enzymes should be in the water before adding corn.*

When the liquefaction is complete, the mash is cooled to 140°F by adding water directly to the tank. The saccharification enzyme is added and the mash is held at 140°F for approximately 20 minutes. Then the mash is cooled to 90°F with more cold water; final volume is approximately 30 gallons of water per bushel of corn. Boucher uses and recommends Biocon enzymes.

## DISTILLATION -- Batch

Boucher designed his own distillation columns for both experimental stills; the packing material is glass beads. The temperature at the top of the column is controlled at around 172°F with cold water coils. The distillation rate is approximately 0.7 gph of 90 percent alcohol (180 proof) for the one bushel unit and 3 gph for the 10 bushel unit.

Each system has a single distillation column; the stripper section is below the feed and a rectifier section is above the feed. On the one bushel unit, the column is 9-feet, 8-inches tall and 3-inches in diameter; on the 10 bushel unit, it is 16-feet, 2-inches tall, and 6-inches in diameter.

## FERMENTATION

Boucher uses about 1/4 ounce of Biocon distilling yeast per bushel of feedstock. The dried yeast are soaked in warm water for one hour before addition to the 90°F mash. Temperature and pH are not controlled during fermentation. The mash is not stirred mechanically; Boucher claims the carbon dioxide generated during the fermentation process provides enough mixing to prevent the yeast from settling. Fermentation is usually complete within 72 hours resulting in a beer solution of approximately 10½ percent alcohol.

## DISTILLERS GRAINS

The liquids are not separated from the solids of the distillers grains. Boucher uses the whole stillage because "it's a shame to waste all that protein in the liquid." He mixes the stillage with molasses and bentonite before putting it into lick tanks. The cattle, especially the calves, feed well on the mixture.

Boucher learned a great deal from building this 10 bushel unit and has planned a number of design improvements in a larger plant under construction.

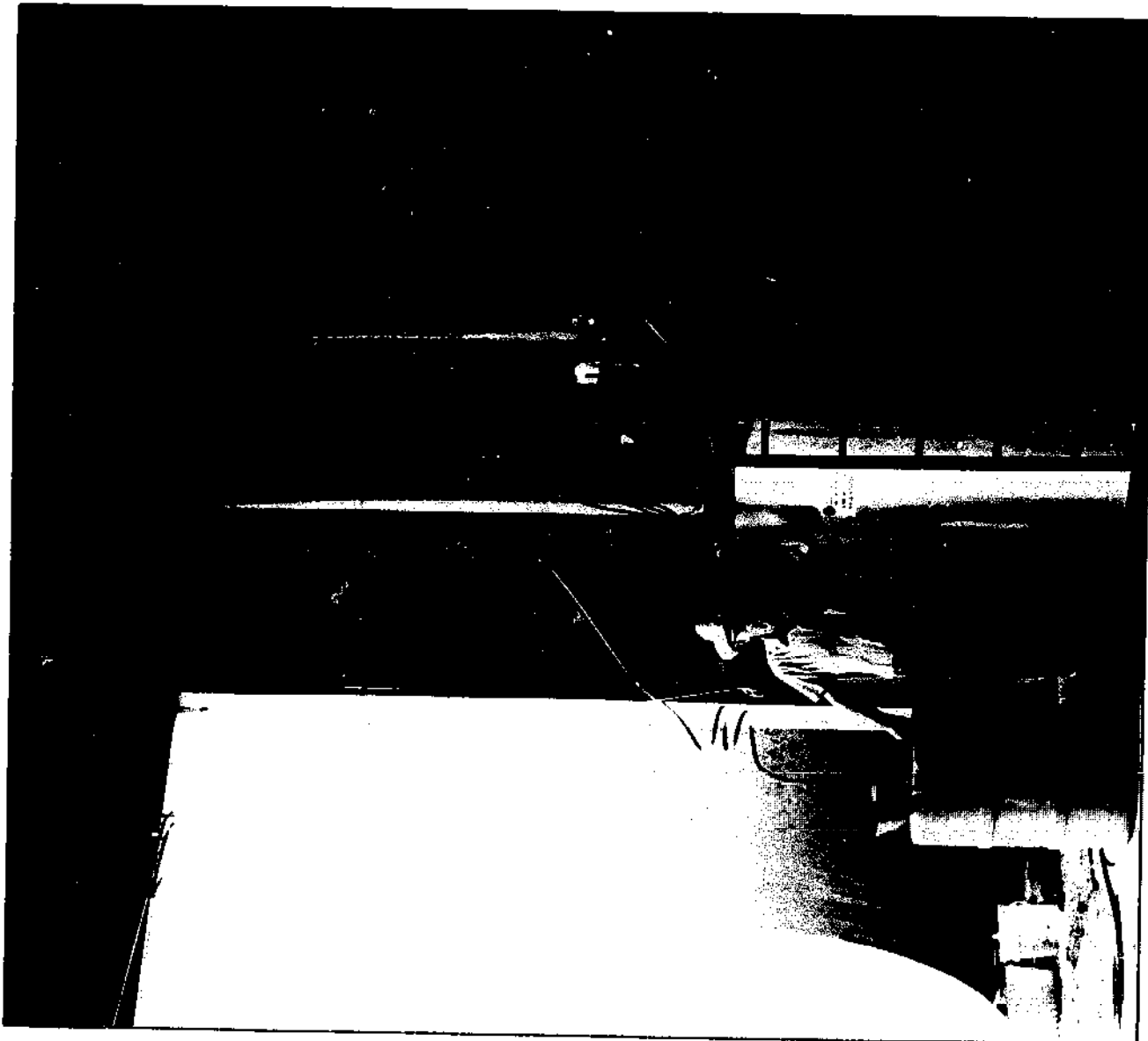

### PRODUCT USE

The alcohol powers some of the vehicles on Boucher's farm. The trucks have performed well. Boucher also supplies alcohol to people using it for experimentation, and does some experimenting on his own (see photo). A neighbor has converted a tractor to alcohol, and claims it performs better.



### ENERGY INPUTS

Energy consumption to fire the batch stills is about 55,000 Btu/gallon of alcohol, excluding electricity to run the stirring motors. Boucher has his own wood supply, so wood costs only \$15 a cord and energy costs are less than 10 cents/gallon of ethanol. When he uses propane, energy costs are 55 cents/gallon and for coal, 11 cents/gallon.

### LABOR

From feedstock preparation to final distillation, Boucher estimates that it takes eight to ten manhours to make a batch of alcohol. Most of that time the unit is self-operating and only occasional checking is required. Boucher noted that it takes the same amount of time to run the one bushel unit as it does the ten bushel model.

### CONTAMINATION CONTROL

Boucher has had no serious problems. For the small experimental units, he uses no extraordinary housekeeping routines, other than general cleaning: the cooking cycle "sterilizes" the system during each batch. However, for farm-sized units with auxiliary fermenters, Boucher recommends using two tanks: one always ready for fermentation while the other is being cleaned. He cleans his tanks with caustic soda and then flushes them thoroughly with water.

### DESIGNER COMMENTS

Boucher has these tips for people buying a farm alcohol still: 1) know what the seller has done; 2) get a guarantee on the unit you buy; 3) don't buy a still until you have trained at an operating facility and learned how to make alcohol; 4) ask the seller to include training/instruction as part of the deal; 5) buy a small still first ("learn to walk before you run"), and purchase it from a manufacturer who will trade it for a larger one; and 6) learn from the mistakes of others.

Boucher has plans for small pot stills in three sizes: one bushel, ten bushel, and 30 bushel; he also has plans for 12-inch, 18-inch and 24-inch distillation columns, for a continuous operation.

Boucher believes that, "The answer to alcohol for fuel is the biomass cellulose conversion from sources, such as garbage, trees, etc."

BOUCHER'S SYSTEM

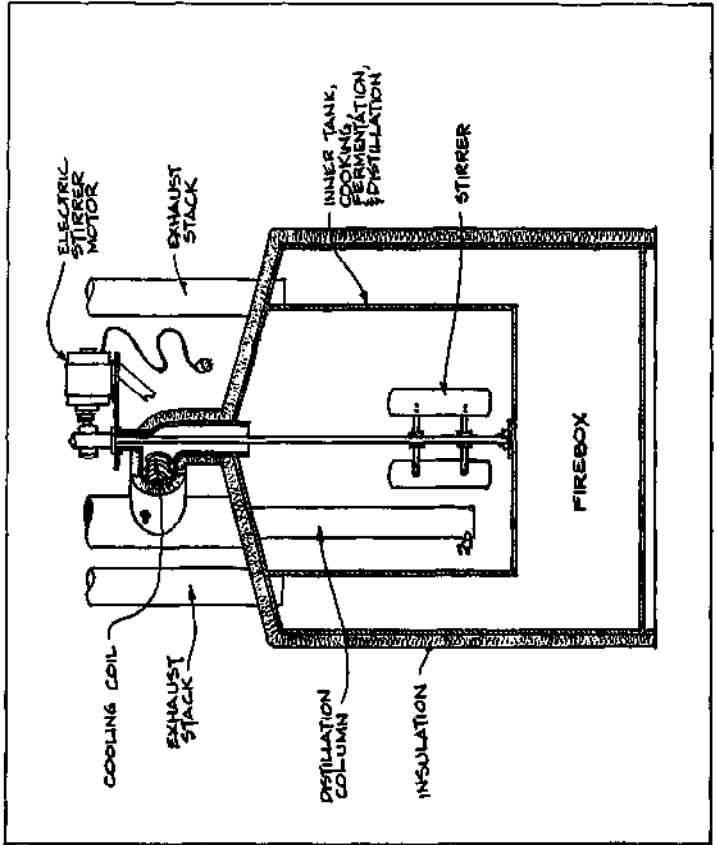
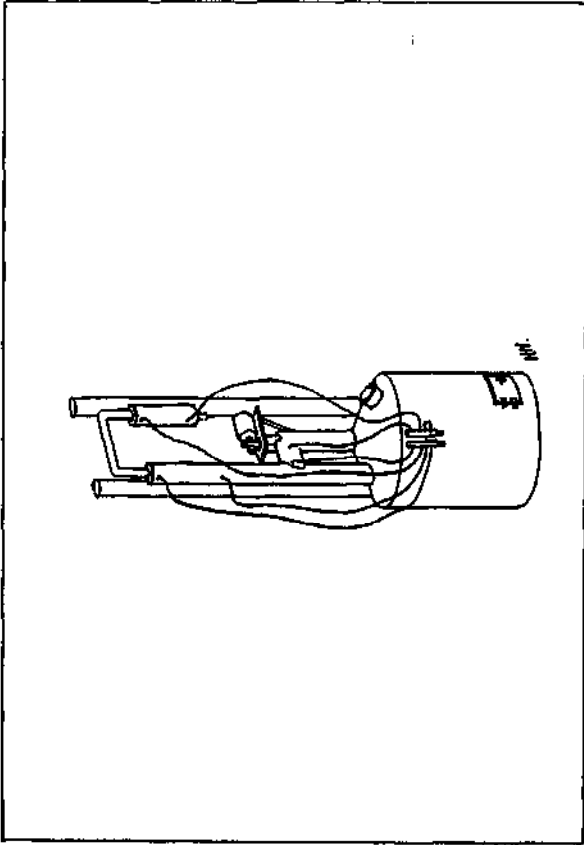

SIDE VIEW, CUT-AWAY

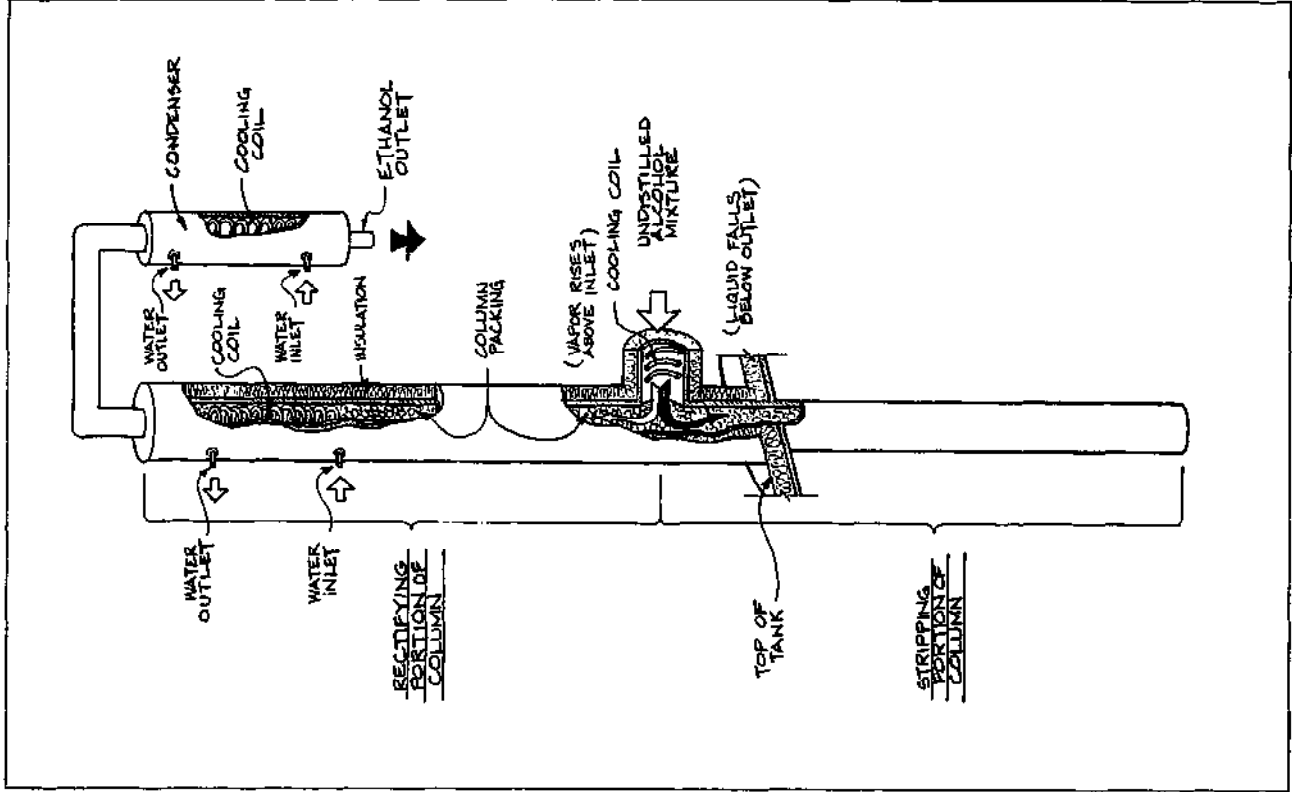

DISTILLATION COLUMN

## PROJECT:

**Randy Butters 4275 - 2 1/2 Mile Road Homer, Michigan 48245**

CONTACT: Randy Butters

*Randy Butters has been making alcohol fuel on his farm since January, 1980. He has invested about \$14,000 in the alcohol production system he designed, and an additional \$8,500 in a screw press he uses to dewater the mash.*

### FEEDSTOCK/PREPARATION

Randy Butters uses only corn from his farm. No special provisions are made to harvest or store this grain; it is the same grain used to feed the livestock (mostly hogs).

Butters grinds the corn through a mixer-grinder using either a 1/8-inch or 5/16-inch screen. He prefers to use a coarser-ground corn because it is easier to salvage the grain by-product and squeeze it down to a lower moisture content.

### COOKING

Six hundred to eight hundred gallons of water are heated to approximately 160°F. *Sixty bushels of ground corn are added over an hour long period.* As the corn is mixed with the water, one half of the liquefaction enzyme is added. Steam injection is used throughout the cooking cycle. When the temperature reaches approximately 210°F, the rest of the enzyme (total 2 1/4 quarts) is added and the 210°F temperature is maintained for approximately one hour. The mash is stirred constantly.

When the liquefaction is complete, the mash is cooled to about 140°F with heat exchangers and by adding cold water to the tank. The pH is adjusted to 4 to 4.5, and the saccharification enzyme is added. The mash is stirred constantly and the 140°F temperature is maintained for another 30 minutes. At this point, the solids from the mash are removed with a shaker sieve and screw press. The remaining liquid mash is transferred to the fermentation tank and cooled to between 85° and 100°F, optimizing at about 90°F; final volume is 18 gallons of water per bushel of corn. Butters uses Miles enzymes.

### FERMENTATION

The 1500 gallon fermentation tank is inoculated with approximately two pounds of distillers yeast obtained from a local distillery. During fermentation, the temperature, which varies between 85°F and 100°F, and the pH are not controlled. There is no mechanical agitation. Fermentation requires about 72 hours resulting in a beer solution of 8-9 percent alcohol. If the fermentation is slow in starting, compressed air is injected into the tank to get the yeast working.

### DISTILLATION - Continuous

A stripper and a rectifier column are used. The two sieve plate-type columns are both 12-inches in diameter and 17-feet tall. The stripper has 1/4-inch holes in the plates and the rectifier column has 1/8-inch holes.

Steam is injected directly into the stripper column to distill the beer. The alcohol coming out of the rectifier column is condensed in a tube and shell condenser that is 8-inches in diameter and 10-feet long. The condenser contains 400 feet of 1/2-inch copper tubing for the heat exchange.

Centrifugal pumps supply reflux to the top of the stripper and rectifier columns. The twin distillation columns produce 90-91 percent alcohol (180-182 proof) at a rate of 1.5-2.0 gph. The yield is 1 1/2 gallons of alcohol per bushel of corn.





Butters uses fuel alcohol to fire the boiler for cooking and distillation. He aims to make the system and his farm operation energy self-sufficient.

## DISTILLERS GRAINS

Butters separates the solids before fermentation with a vibrating screen and a screw press. The solids are used on his farm for hog feed or sold to a neighbor for dairy cattle feed. The dairyman said that the butter fat from his milking herd increases between 0.5 and 1.0 percent when the cows eat the high protein distillers grains tests for protein content have averaged 28 percent).

## PRODUCT USE

Butters runs his pickup truck on alcohol and also uses the fuel to run the boiler for the alcohol plant. He plans to convert other farm machinery and to sell the alcohol. Butters is also investigating various types of anhydrous units to make 100 percent alcohol for sale on the gasohol market.

## LABOR

Butters says it takes five or six manhours for a 60 bushel batch: 1½ hours for the cook cycle to add grain, make pH adjustments and remove solids; two to three hours during the distillation cycle for start up and shut down; and about two hours for twice-a-day inspections during the self-operating fermentation cycle to control the temperature.

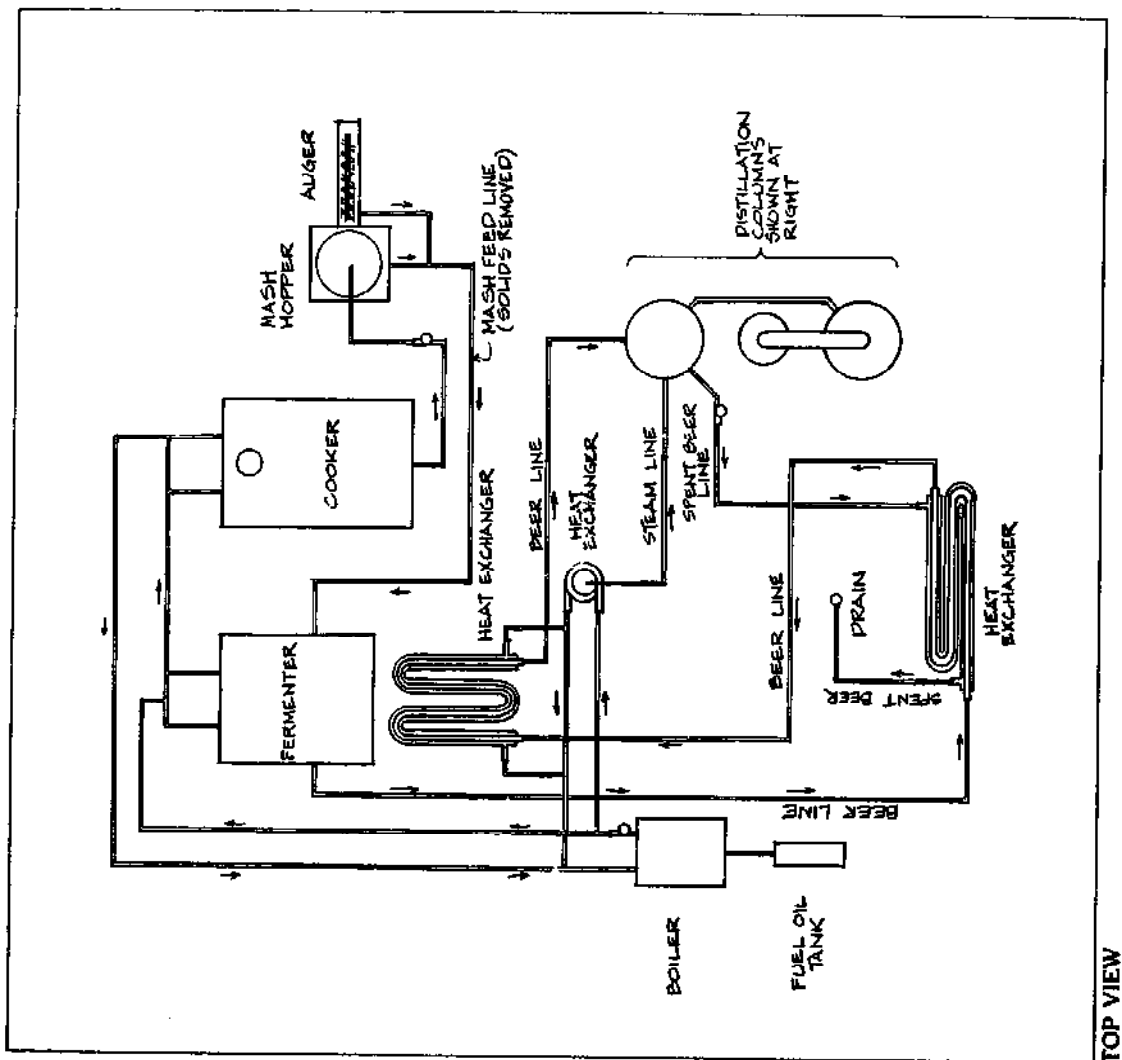

TOP VIEW

### ENERGY INPUTS

The heat source is a multi-fueled (diesel oil and alcohol) hot water boiler. Six electric motors are used: on the grinder/mixer (for feedstock preparation); for fuel injection to the boiler; on pumps for beer and mash transfer; on the shaker sieve; and on the screw press to dewater the solids. The actual Bu/gallon of alcohol is unknown at this time. However, Butters is confident it is fairly economical. He uses heat exchangers throughout the system and all tanks, lines and columns are spray-insulated with cellulose. He is also looking into a hot water storage tank to save even more energy. Finally, by using his fuel-grade alcohol to fire the boiler, the system is fairly energy self-sufficient.

### CONTAMINATION CONTROL

To date, he hasn't had any problems. As part of his general housekeeping routine, Butters uses water to clean out the tanks and lines that will be idle for any period of time.

### DESIGNER COMMENTS

Butters has approximately six months and over \$20,000 invested in his alcohol plant. He started off using a 400 gallon dairy bulk tank and 6-inch columns. But after visiting the Schroder plant in Campo, Colorado, he designed his columns similarly. He says that the serious operator should use heat exchangers to conserve operating energy.

Butters considers the by-product of alcohol production as important as the fuel itself. He uses his plant primarily to process the distillers grains and produce fuel for his farm use.

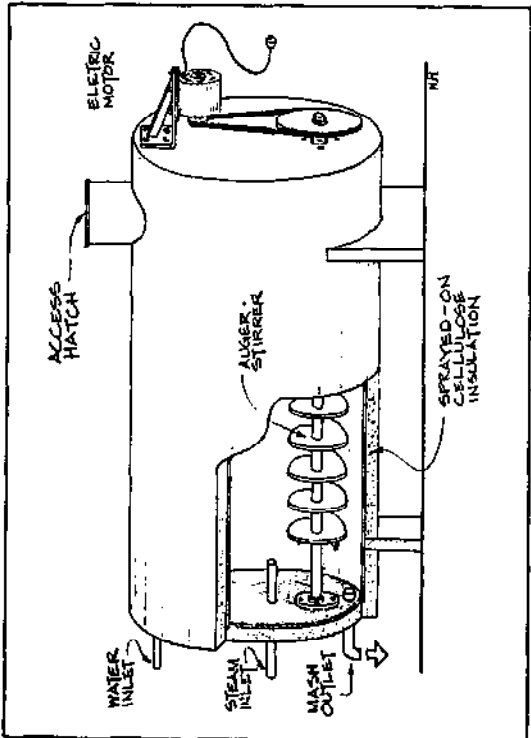

COOKER

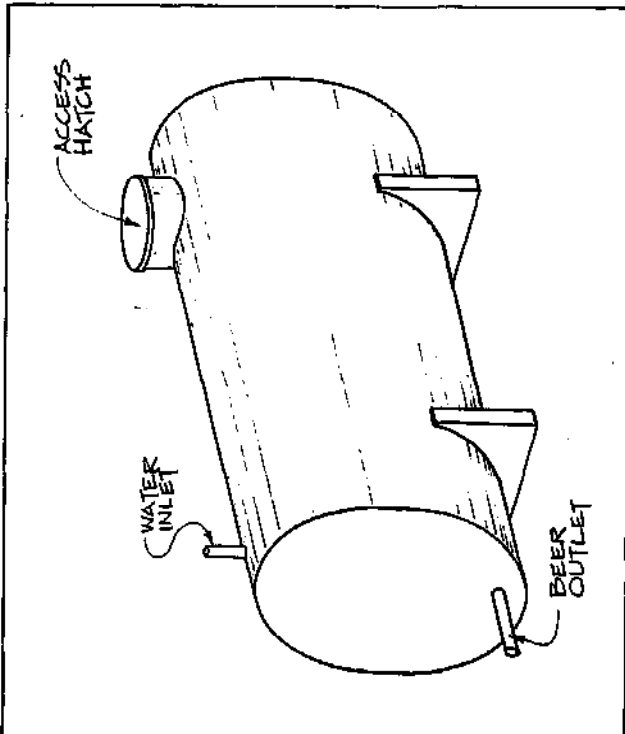

FERMENTER

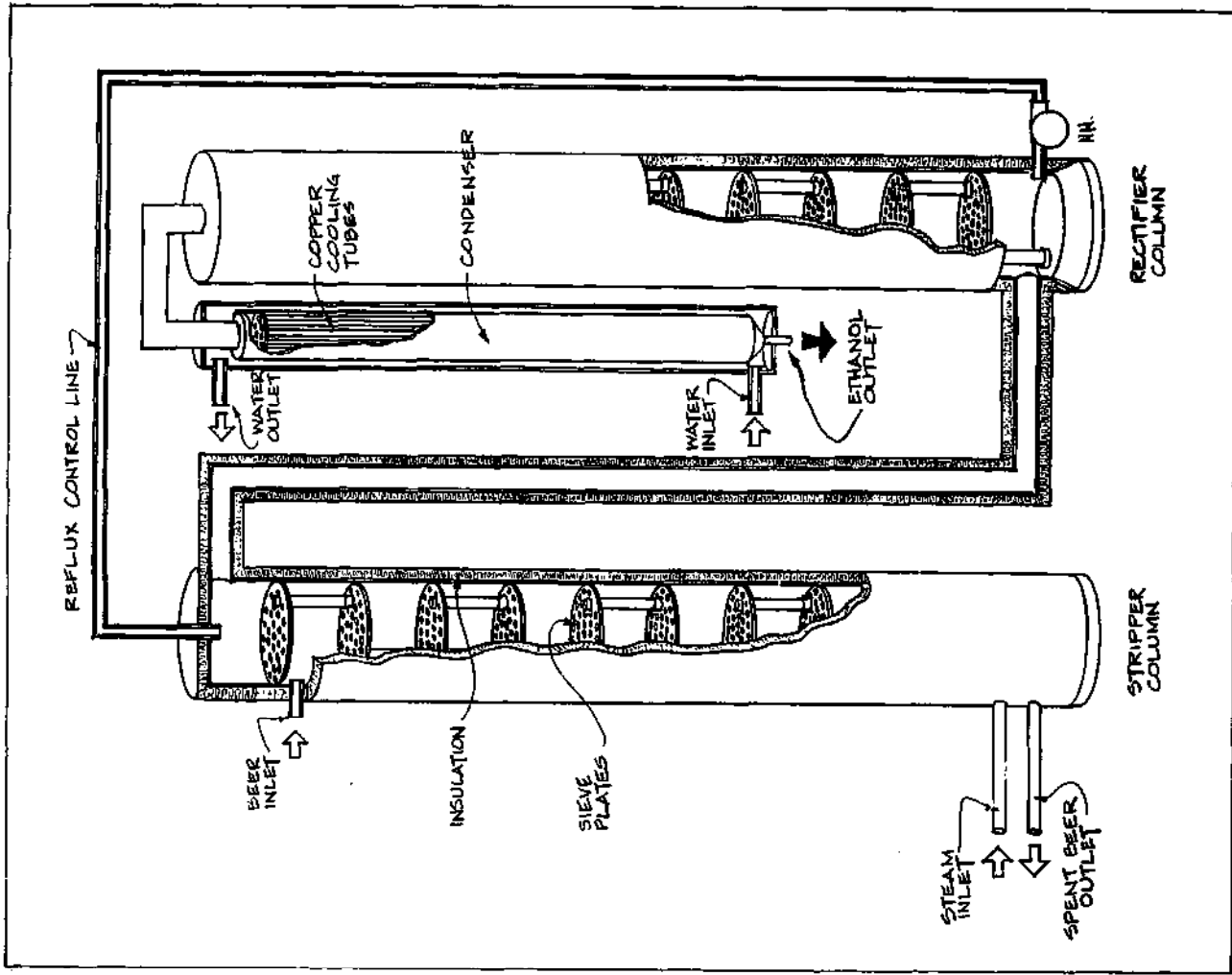

DISTILLATION COLUMNS

## PROJECT:

**Dennis Day RR 2 Grimes, Iowa 50111**

CONTACT: Dennis Day

*Dennis Day has been making fuel alcohol for over 1½ years. He has designed his own system and invested approximately \$30,000 in his on-farm plant. Day also uses a Wenger extrusion cooking/conversion system on loan from the manufacturer; this system costs about \$40,000.*

**FEEDSTOCK/PREPARATION**

Day uses field corn grown on his farm. A wet milling operation is used to prepare the corn for alcohol production. A roller mill with a small motor (3 HP) cracks the corn at a rate of 200 bushels/hour. The rolled corn is then separated in a large water tank; the germ and hulls float to the top while the starch (in the corn) sinks to the bottom of the tank and is drawn off to the extruder. The advantage, according to Day, is that there are virtually no solids for the system to handle; the wet milling removes approximately 19 pounds of germ and hull per bushel of corn.

**COOKING**

The starch (and some water) is fed from the separation tank to the Wenger SX-80 extruder. The extruder operates at a temperature of 250-300°F at 700-1200 psi. The starch stays in the extruder for 30-45 seconds. When the short extrusion cycle is complete, the starch is fed to a conversion tank. Cold water is injected at the outlet of the extruder to cool the starch mash.

The conversion tank contains water and liquefaction enzyme. The mash temperature is 140°F. The mash is stirred during the liquefaction step. After liquefaction is complete, the mash is pumped to the fermentation tank and the saccharification enzyme is added. The mash is then cooled to 90°F by adding cold water. Final volume is about 20 gallons of water per bushel of corn. Day uses Biocon enzymes.

**FERMENTATION**

The cooled mash is inoculated with Biocon distillery yeast. Day pre-cultures the yeast in mash prior to starting the fermentation. Temperature and pH are not controlled and the tank is not stirred. Fermentation requires 60-72 hours and results in a beer of 8-10 percent alcohol.

**DISTILLATION - Continuous**

An oil-fired hot water boiler supplies heat to a vacuum distillation column. The continuous column stands 60-feet tall and is 16-inches in diameter. It contains 42 feet of packing; the lower, 22-foot section contains 2-inch burrel ceramic saddles; the upper section is packed with 1-inch and ¾-inch saddles.

At the top of the column, a tube bundle partial condenser controls the temperature and supplies reflux to the column. The column produces 87.5-90 percent alcohol (175-180 proof) at a rate of 17 gph. Yields are 2.3-2.6 gallons of alcohol/bushel of corn.

**DISTILLERS GRAINS**

The germ separator used for feedstock preparation produces a product that contains 18 percent protein, 22 percent fat and very little starch. Day feels this product is a valuable livestock feed and believes it could even be processed into human food. He gives his distillers grains to a neighbor "in return for a lot of work."

**PRODUCT USE**

Day burns most of the alcohol in his cars and trucks. He has also given 55 gallons of alcohol to the Department of Energy.

**ENERGY INPUTS**

The Wenger extrusion cooker is fairly energy efficient: it captures heat for the conversion tank from the end of the extruder and uses a heat exchanger on the diesel engine to warm the water going into the extruder; with this system, the energy needed for starch conversion is 3000 Btu/gallon of alcohol. The oil-fired hot water boiler uses 18,000 Btu/gallon. Thus, total energy inputs, excluding electricity, is 21,000 Btu/gallon of alcohol.

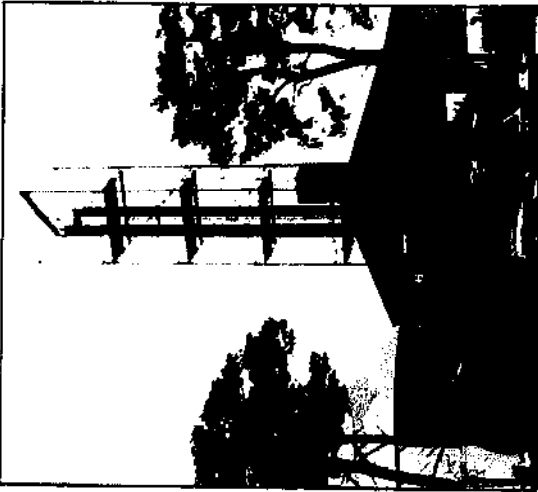

### LABOR

Day estimates that his system requires 8-10 hours per batch. With three fermentation tanks he has the capacity to produce alcohol on a daily basis.

### CONTAMINATION CONTROL

Day has had some problems when the tanks remain empty for long periods of time (two weeks). Tanks are now steamed before a new batch is started, and occasionally flushed with disinfectants, such as lye or clorox.

### DESIGNER COMMENTS

Dennis Day's opinion about alcohol production is changing. At first, he just wanted to make his own fuel to be self-sufficient. Now he sees another horizon and a chance to obtain a fair return for his crops. He believes that selling alcohol and its associated by-products will help him earn a profit from his farming operations and ensure him a place in the rural economy.

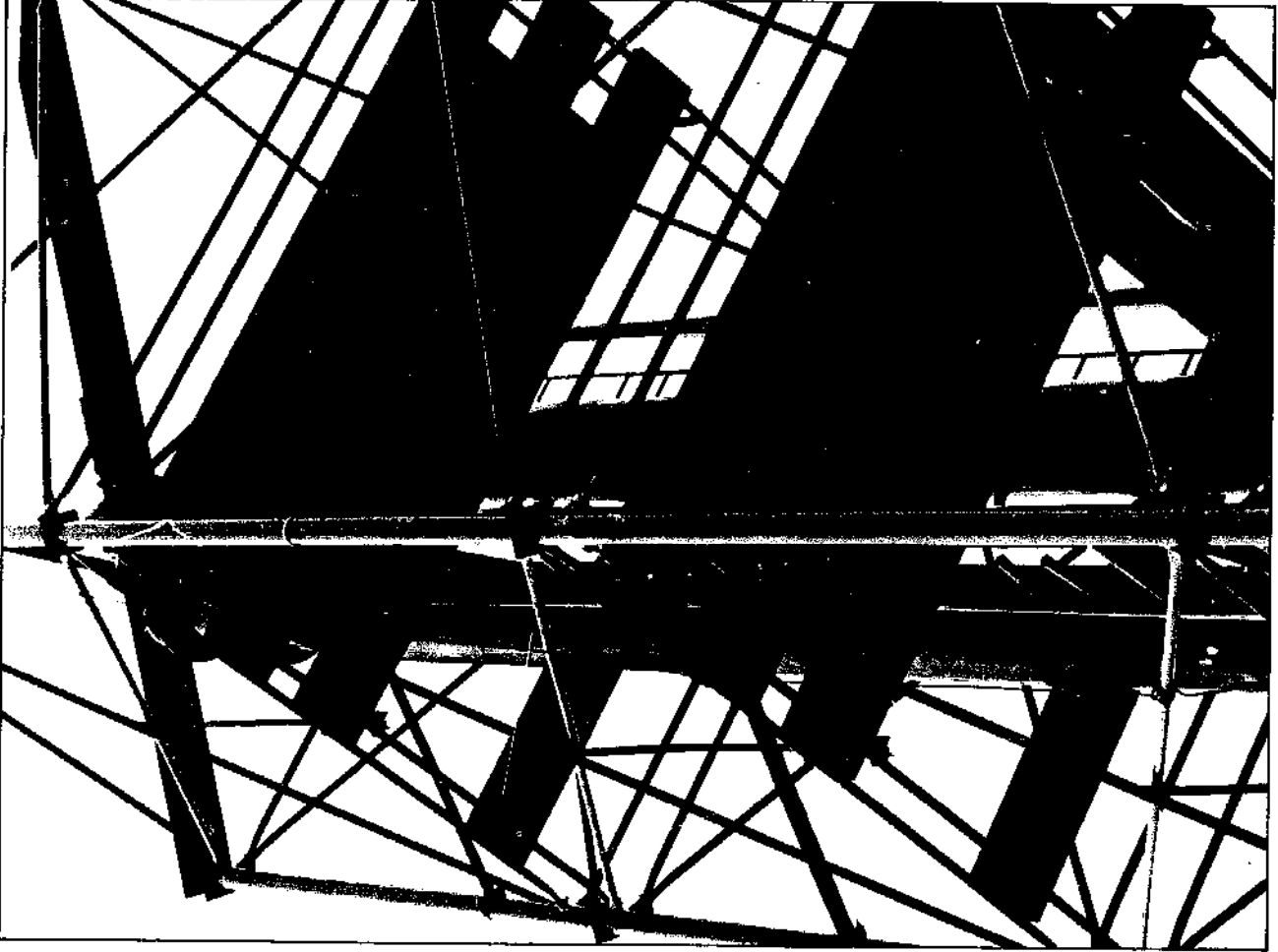

Day's 60-foot distillation columns tower over his Iowa farm.

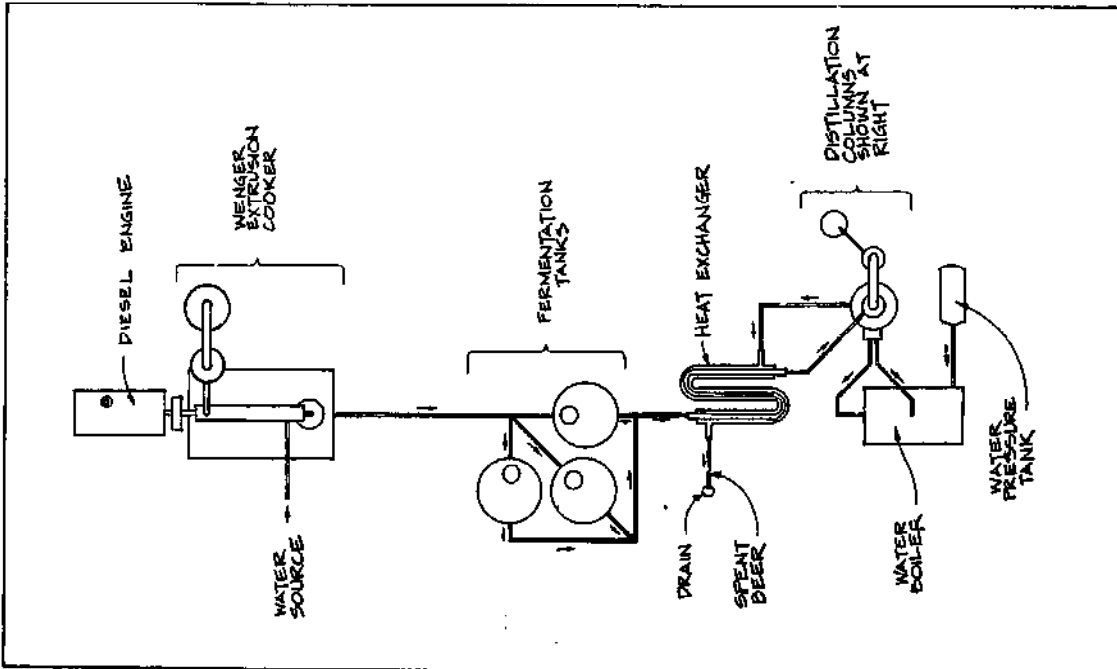

TOP VIEW

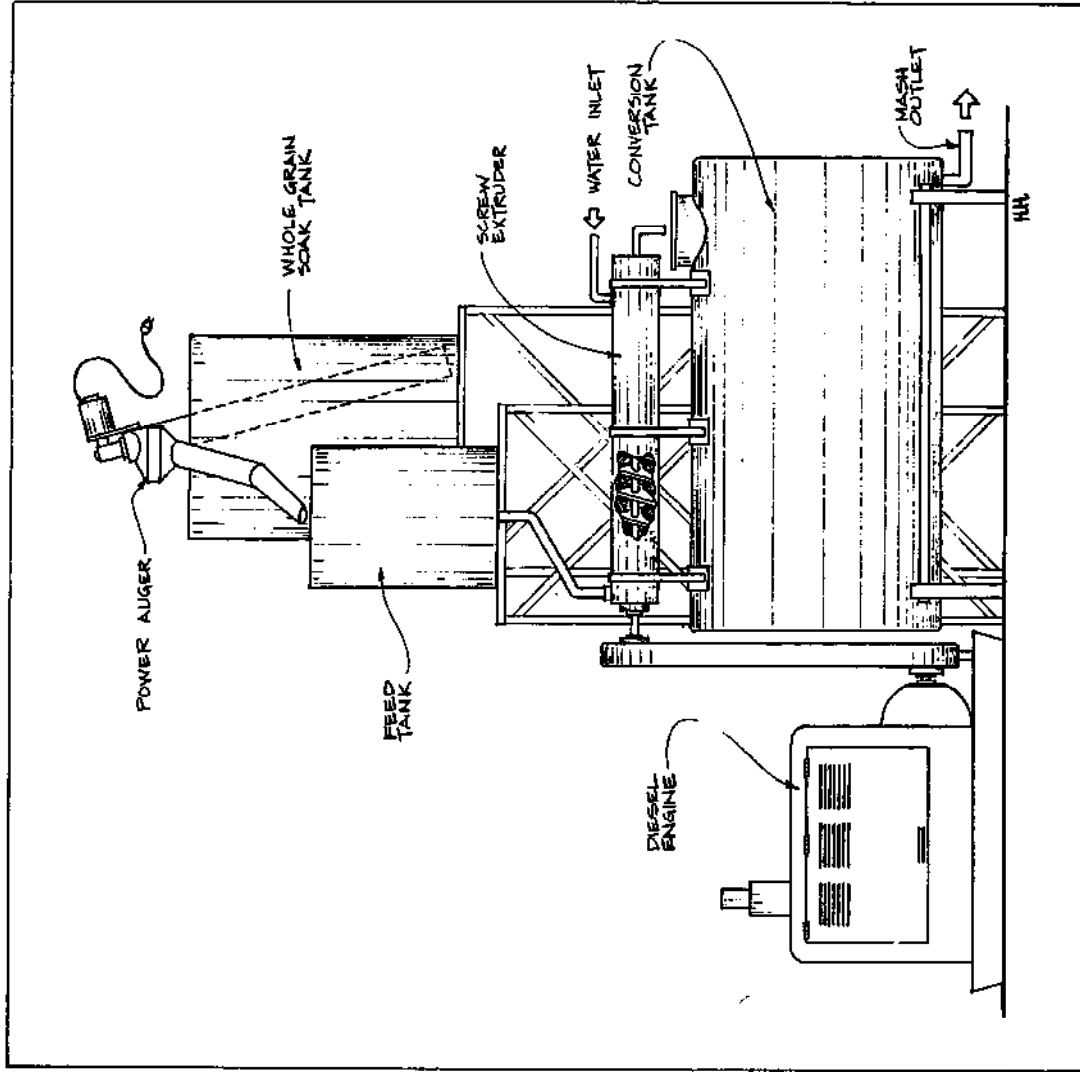

WENGER EXTRUSION COOKER

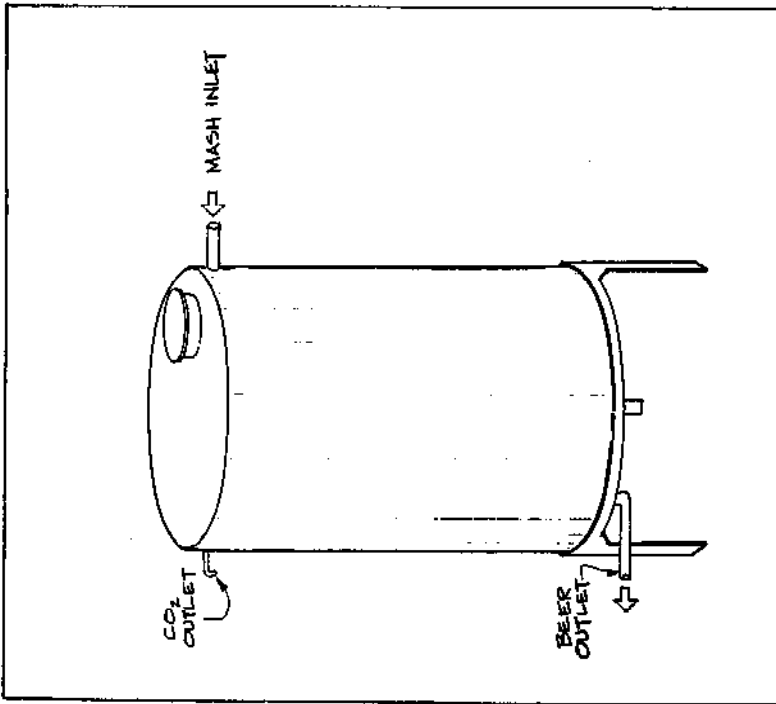

FERMENTER

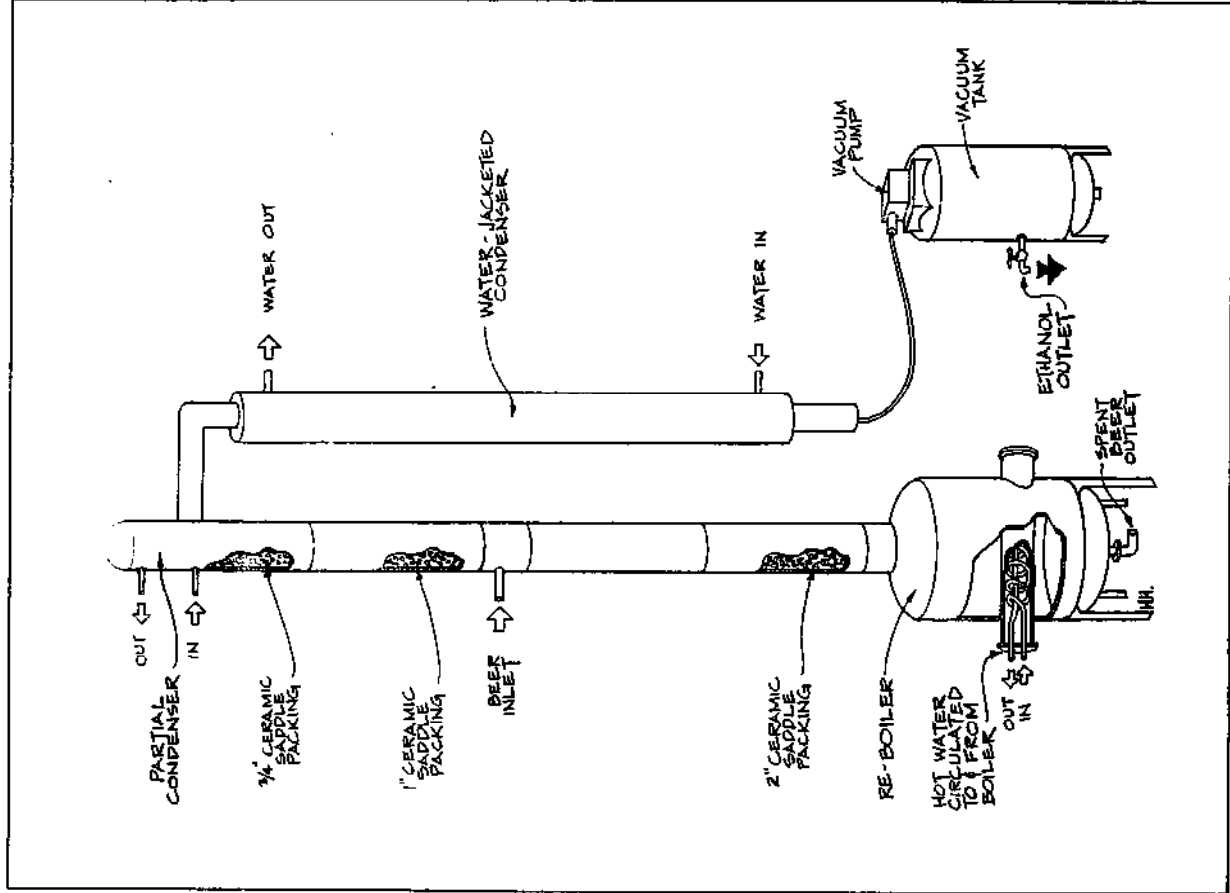

DISTILLATION COLUMNS

## PROJECT:

**Gary Harris Star Route, Box 70 Conrad, Montana 59425**

CONTACT: Gary Harris

Gary Harris invested \$10,000 and built his own alcohol plant. The basic design is from the American Agriculture News publication, 'Makin' It On The Farm.'

### FEEDSTOCK/PREPARATION

Harris uses barley grown on his farm. He grinds the barley in a feed grinder with 1/8-inch sieve holes; once ground, the barley has the consistency of a fine powder.

### COOKING

Seventy bushels of barley are mixed with about 1,000 gallons of water in a 3,000 gallon tank. The liquefaction enzyme is added and the tank is heated to 190°F by direct steam injection. At first the mash was agitated by an auger set vertically in the center of the tank; however, this arrangement did not provide adequate mixing and has since been changed to a conventional stirring paddle. The liquefaction step takes about one hour.

When liquefaction is complete, the tank is cooled to 140°F by adding cold water directly to the tank and by circulating water through cooling coils. The saccharification enzyme is added and the mash is held at 140°F for 30 minutes. The tank is then cooled to 80°F by adding more cold water; final volume is approximately 30 gallons of water per bushel of barley. Harris uses Milles enzymes.

### FERMENTATION

About 2-2½ pounds of Biocon distilling yeast are mixed with five gallons of barley mash the night before fermentation. This preculture is added to start fermentation. The pH of the mash is adjusted if necessary and the temperature is controlled between 80-90°F. The tank is stirred intermittently every hour for a few minutes. Fermentation is complete in about 60 hours resulting in a beer of about 5 percent alcohol.

### DISTILLATION

Twin distillation columns are 16-feet tall and 12-inches in diameter. The columns are built with sieve plates and controlled with reflux pumps. The columns are designed to produce 25 gph; however, due to insufficient steam from the waste oil boiler, Harris has only been able to produce 2 gph of 80-85 percent (160-170 proof) alcohol.

### DISTILLERS GRAINS

Thus far, Harris has spread the stillage on his fields. He plans to dry the grains and purchase a pelletizing machine that processes the feed for livestock. He will sell the feed on the local market.

### PRODUCT USE

Harris has converted a pickup truck and a two cylinder, four cycle engine to run on alcohol.

### ENERGY INPUTS

Twenty-five to thirty gallons of waste oil collected from local service stations were used to fire the boiler to produce the first batch of alcohol. By insulating his cook/fermenter tank, and distillation columns, Harris hopes to reduce his energy input considerably. He also plans to build a straw-fired boiler.



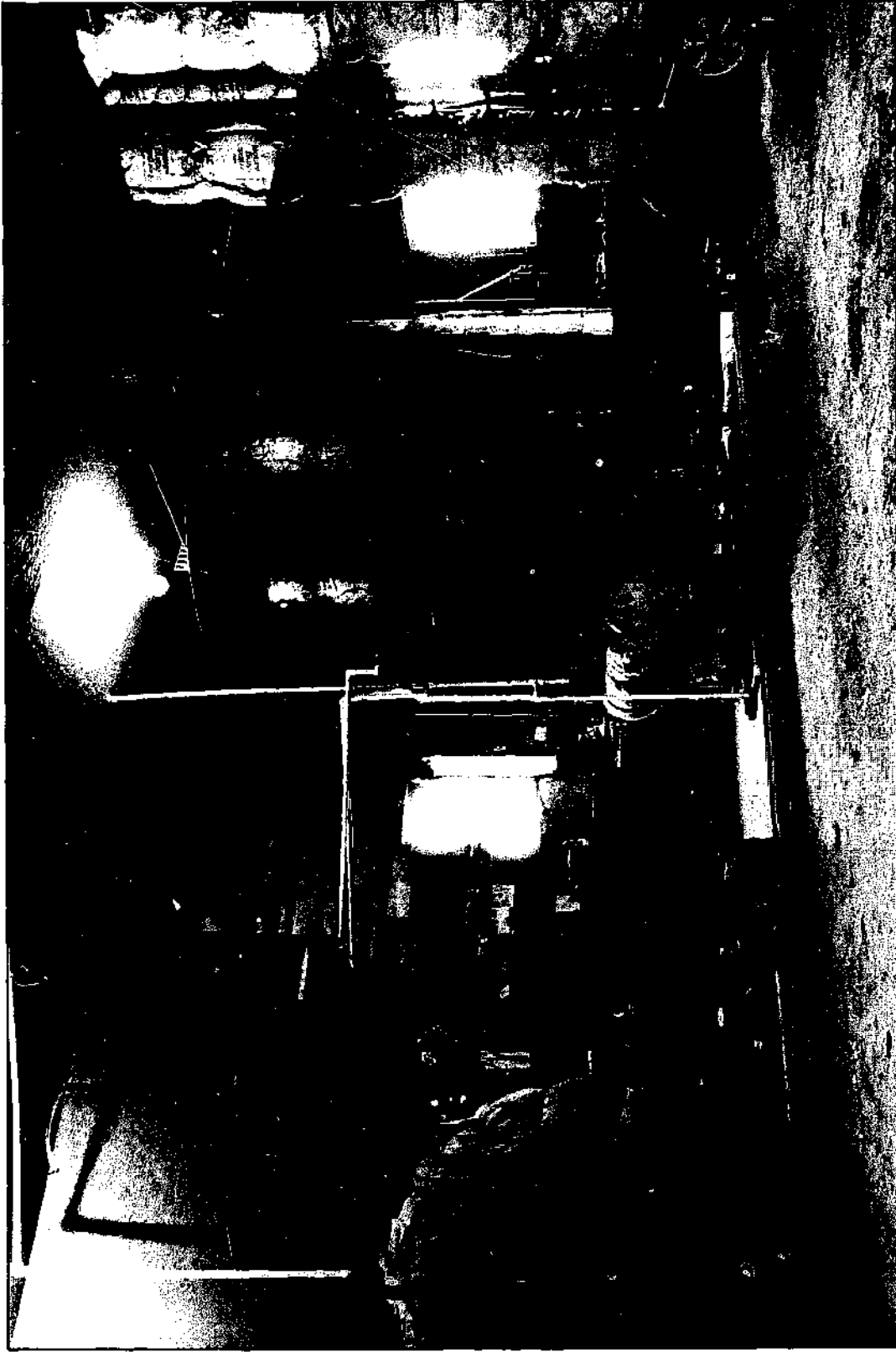

In his effort to conserve heat, Harris has thoroughly insulated his alcohol production equipment.

## HARRIS' SYSTEM

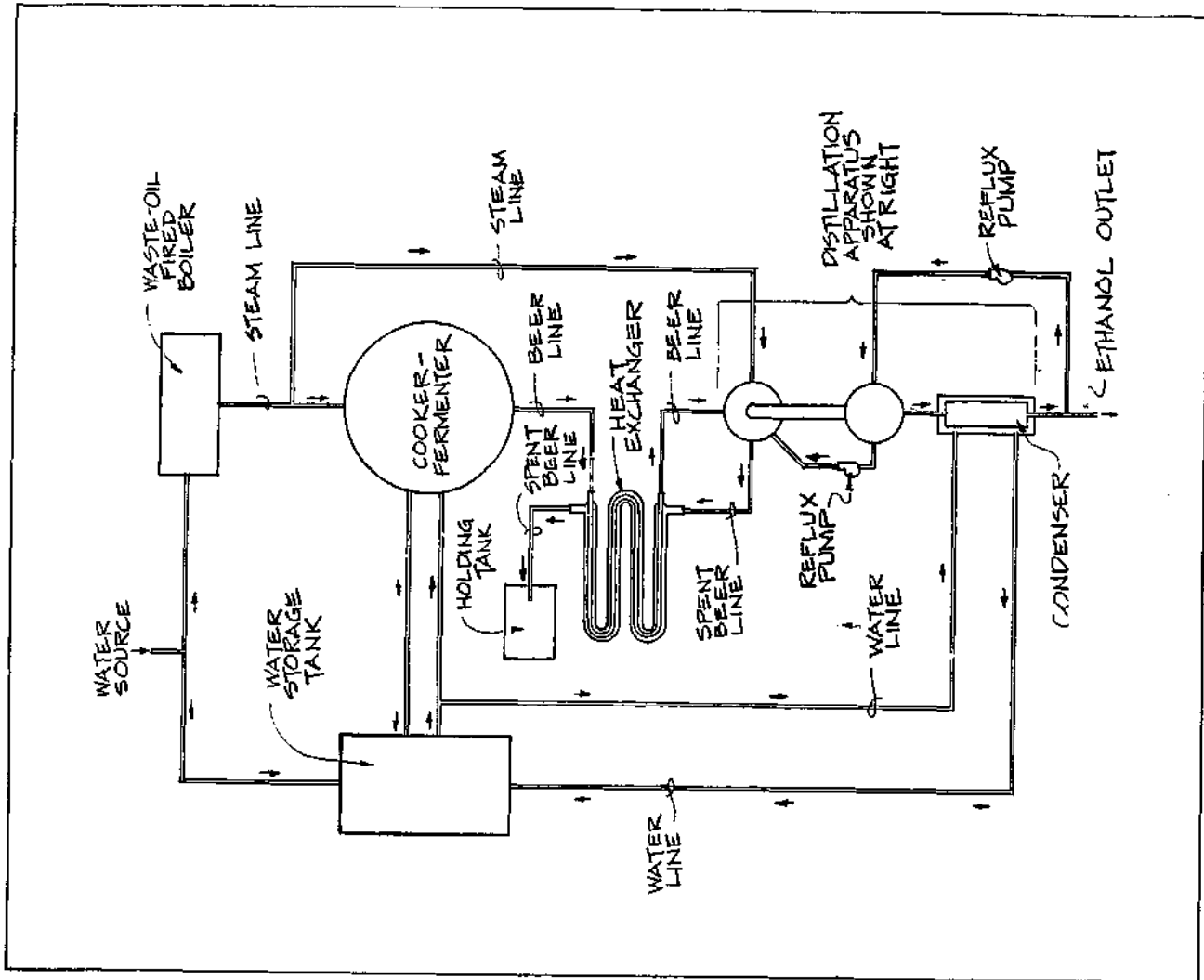

TOP VIEW

### LABOR

Harris spent approximately 40 hours making his first batch of alcohol; this included fixing pumps, insulating lines, and experimenting to find out how to make the system work best. In the future, he estimates that it will take 3-4 hours for the conversion cycle and an additional 8 hours for distillation.

### CONTAMINATION CONTROL

Harris has not had any problems. Steam is run through the system for 15 minutes before a new batch is started. The system is also flushed with hot water after each batch.

### DESIGNER COMMENTS

Noting that it takes a lot of time and personal energy to design and build an alcohol plant, Harris says, "It may be better, if you have the money, to go out and buy a plant." Nonetheless, he has gained a lot of satisfaction in building his own plant, and making it work right.

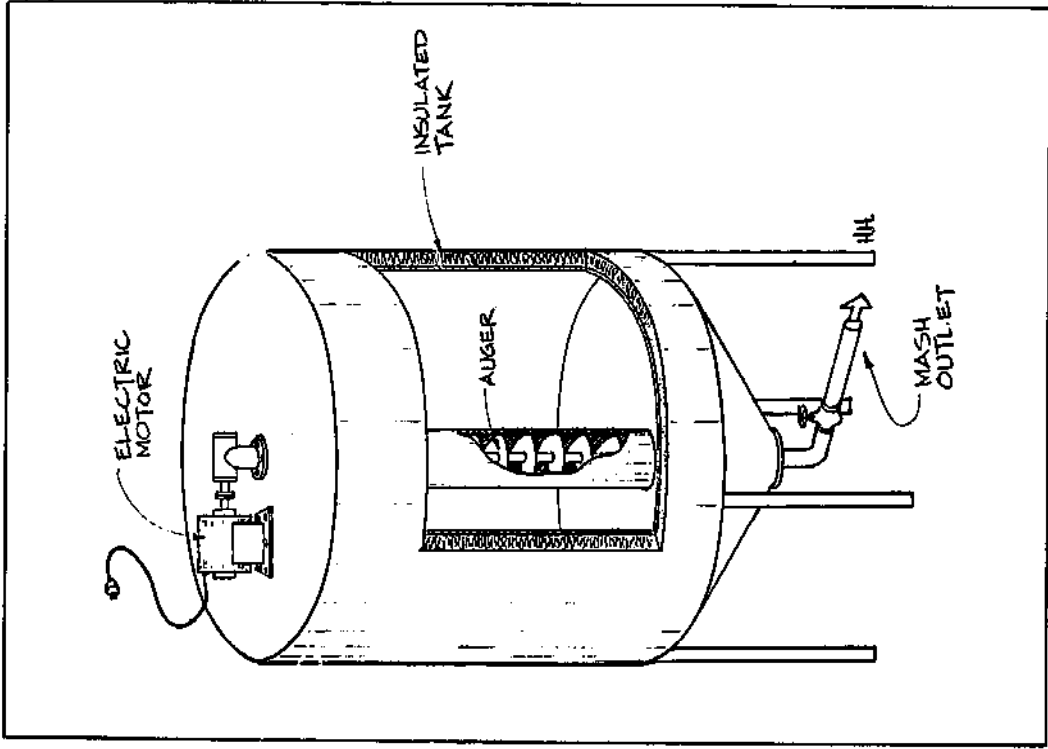
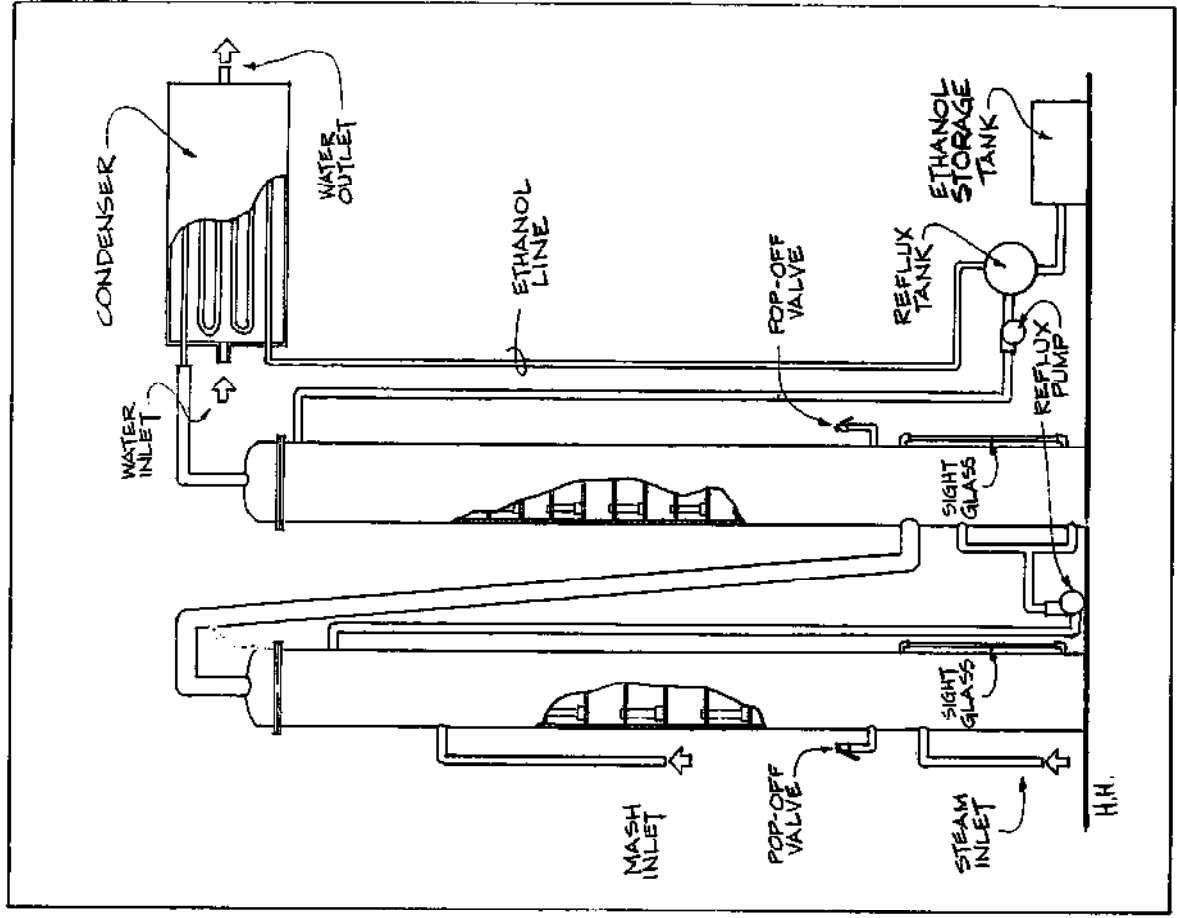

DISTILLATION COLUMNS

COOKER/FERMENTER

## PROJECT:

# Schroder Farms Alcohol North Route Campo, Colorado 81029

CONTACT: Gene Schroder

Gene Schroder and his father Derral have been leaders in the fuel alcohol movement for the last few years. They have invested \$400,000 to develop an alcohol plant which has over 54,000 gallons of fermentation capacity. Their system is one of the most advanced farm plants in operation. In addition, an anhydrous system is used to produce 100 percent alcohol.

## FEEDSTOCKS/PREPARATION

Although corn has been used in the system, the Schroders standardized their operation using milo. The grain is harvested from their fields and stored in large elevators before being transferred to the alcohol facility. Once at the plant, the milo is cleaned and ground using a roller mill with a number 60 mesh or finer. Before addition to the cook tank, the grain is weighed to get an accurate measure of starch concentration.

## COOKING

Warm water from a storage tank is pumped to an 8900 gallon cook tank and heated to 160°F. Ground milo and the liquefaction enzyme are then added and the mixture is heated to 190-195°F by direct steam injection. The pH of the mash is about 6.5. Cooking and liquefaction takes about three hours, after which the mash is transferred through a heat exchanger to the fermentation tank. The cooled mash (100°F) is adjusted to pH 4.5 with sulfuric acid and then the saccharification enzyme is added. Final volume is 16 gallons of water per bushel of milo with an estimated sugar concentration after saccharification of 20-22 percent. Schroder uses enzymes from both Miles Laboratories and Novo.

## FERMENTATION

Yeast are precultured for about 48 hours in a separate 1000-gallon tank prior to their introduction into the fermentation tank (see photo). Says Gene Schroder, "We've used most of the commercially available brands of distillers yeast, and if they are precultured there is very little, if any difference among them." Temperature is not controlled during fermentation but stays below 100°F. The pH is maintained at 4.5. The tanks are stirred intermittently throughout the process. Fermentation times vary with the amount of yeast added from the preculture tank; 72 hours is typical. The beer reaches about 12 percent alcohol when fermentation is complete.

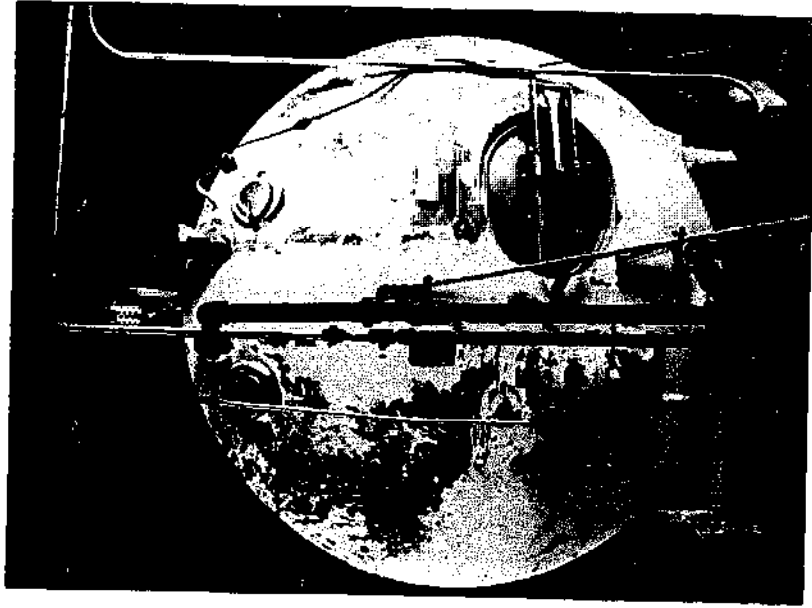

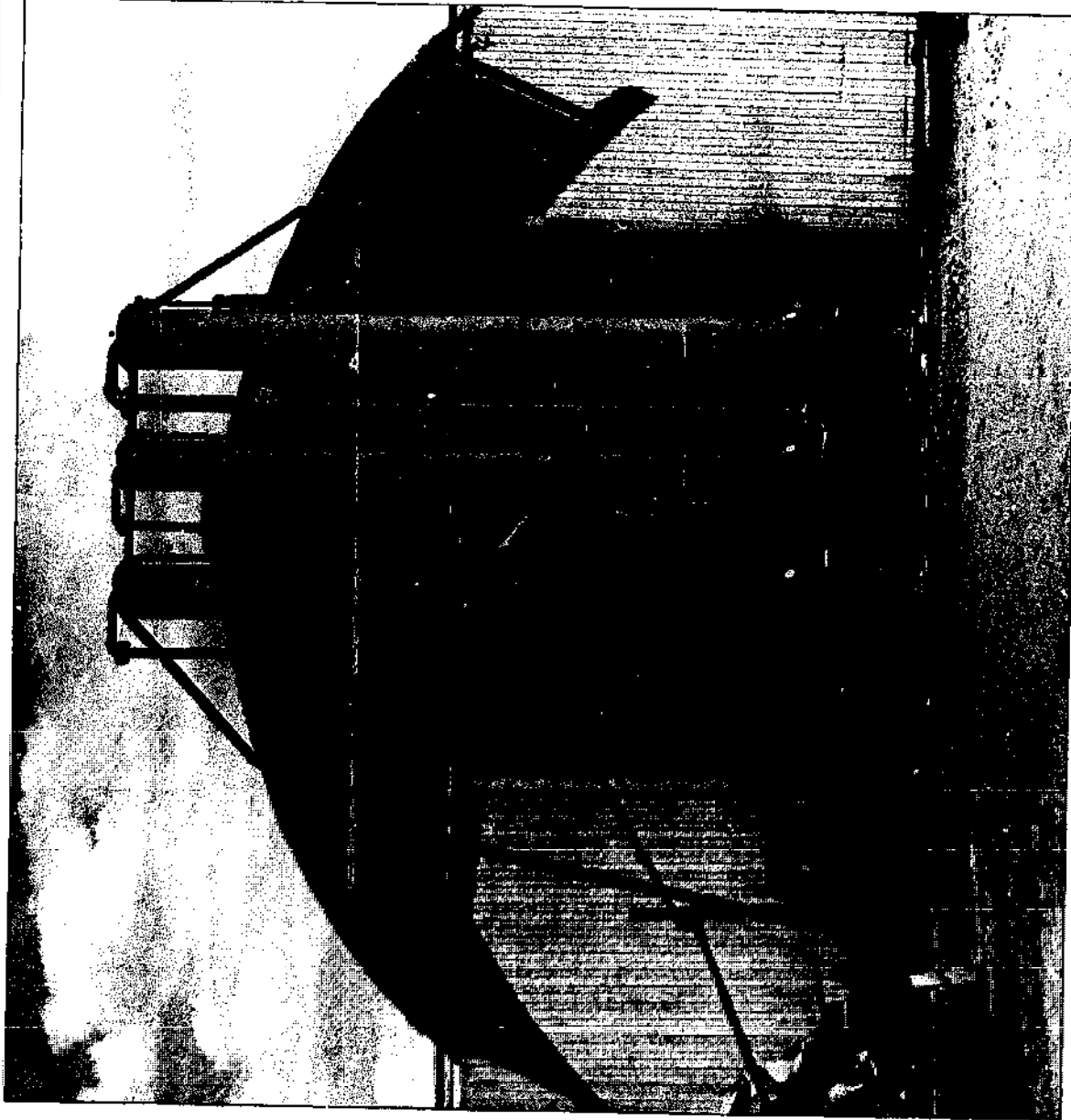

Schroder's unique distillation system uses three columns -one stripper and two rectifiers - to produce 95 percent alcohol at a rate of 40 gph.

## DISTILLATION -- Continuous

The Schroder's distillation system has three 16-foot columns that are insulated and constructed with sieve plates; the stripper is 16-inches in diameter and the two rectifier columns are 12-inches in diameter. Reflux is added to the top of each column. The columns produce 95 percent alcohol (190 proof) at a rate of 40 gph. The yield is 2.5 gallons/bushel of milt.

Before being introduced into the top of the stripper column, the fermented beer passes through a heat exchanger where it is preheated by the hot stillage exiting from the bottom of the stripper. This step conserves energy by reusing waste heat from distillation. A condenser (shell and tube design) cools the alcohol with cold well water. The heated water from the condenser is cycled to a storage tank for reuse.

The alcohol is transferred by gravity to a storage tank prior to processing through an anhydrous system. The anhydrous system is a column packed with Union Carbide's molecular sieves. These sieves must be regenerated (dried) after every eight hours of use with hot air from a propane heater.

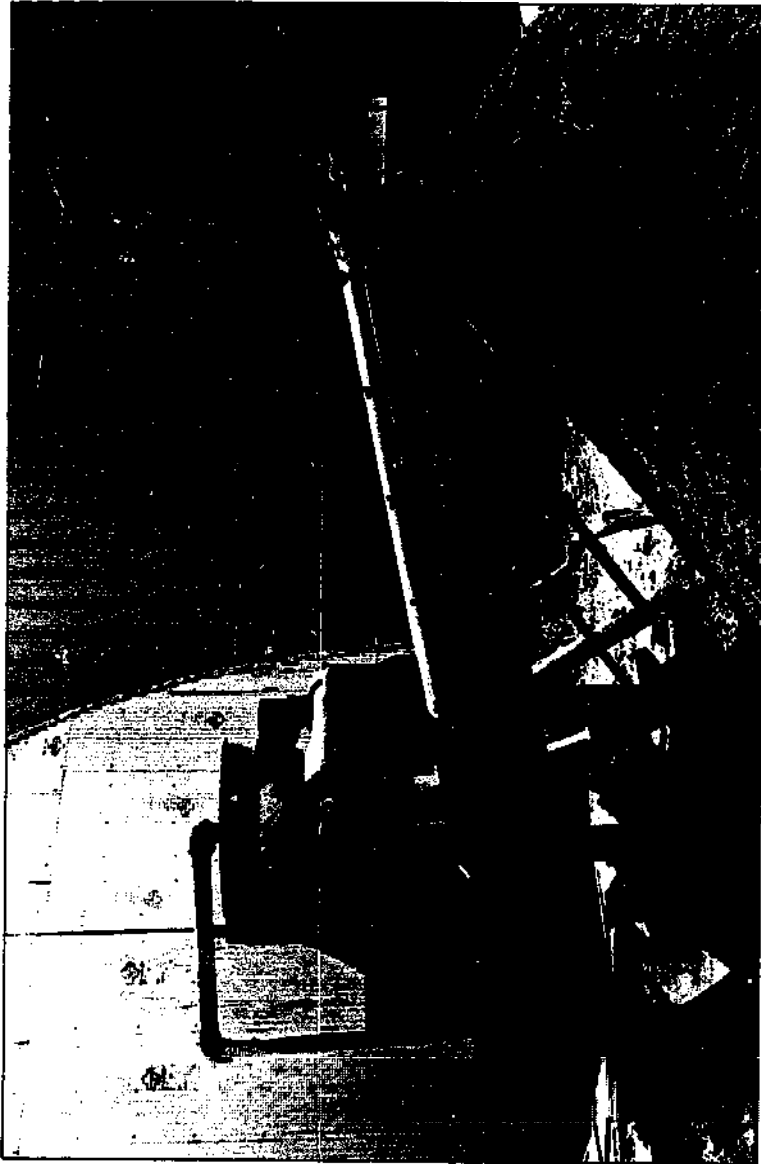

## DISTILLERS GRAINS

The spent beer is processed with a vibrating screen system to remove the bulk of the water from the solids. A screw press dewateres the solids further to about 60 percent moisture (see photo). The solids are stockpiled on the ground and picked up by a local cattle feeder. The protein content has been measured at about 28 to 30 percent.

## ENERGY INPUTS

Electricity powers the roller mill, pumps and motors. The diesel oil-fired boiler generates steam for cooking and distillation. *Heat exchangers, a hot water storage tank, and insulation on tanks, pipes, and columns are used to conserve heat.* Energy inputs are 24,000 Btu/gallon of 95 percent alcohol. The anhydrous operation uses an additional 4000 Btu/gallon to produce 100 percent alcohol. Thus, total energy inputs are 28,000 Btu/gallon of 200 proof alcohol.

## PRODUCT USE

The fuel alcohol is sold locally to individuals or used in the farm trucks and other vehicles. Schroder has found that the alcohol-powered vehicles are performing well, although with a little less power. The mileage, though, has remained more or less the same.

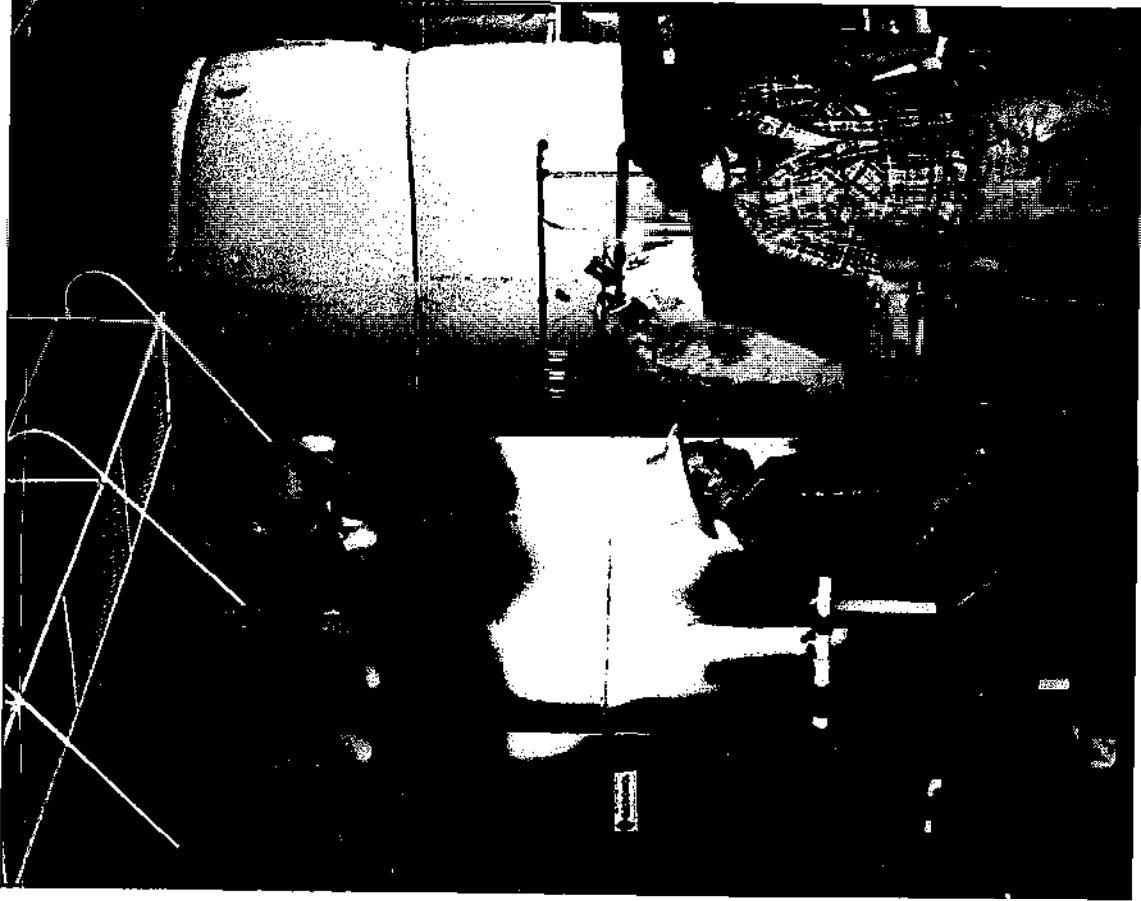

Derral and Gene Schroder work full-time on their Colorado farm producing alcohol.

### LABOR

When the alcohol plant is in full operation, one person will be on duty at all times, and possibly two people during the day.

### CONTAMINATION CONTROL

The Schroders have had no problems. The tanks and lines are washed periodically with caustic soda and steam as a precautionary measure.

### DESIGNER COMMENTS

The Schroders are using the alcohol plant as a means of gaining what they feel is a fair return on the investment of growing crops on their farm. By selling the alcohol and the distillers grains they are able to earn more per bushel on their milo than by selling it through the local co-op.

The Schroder family works with the local college to present seminars on alcohol fuel production.

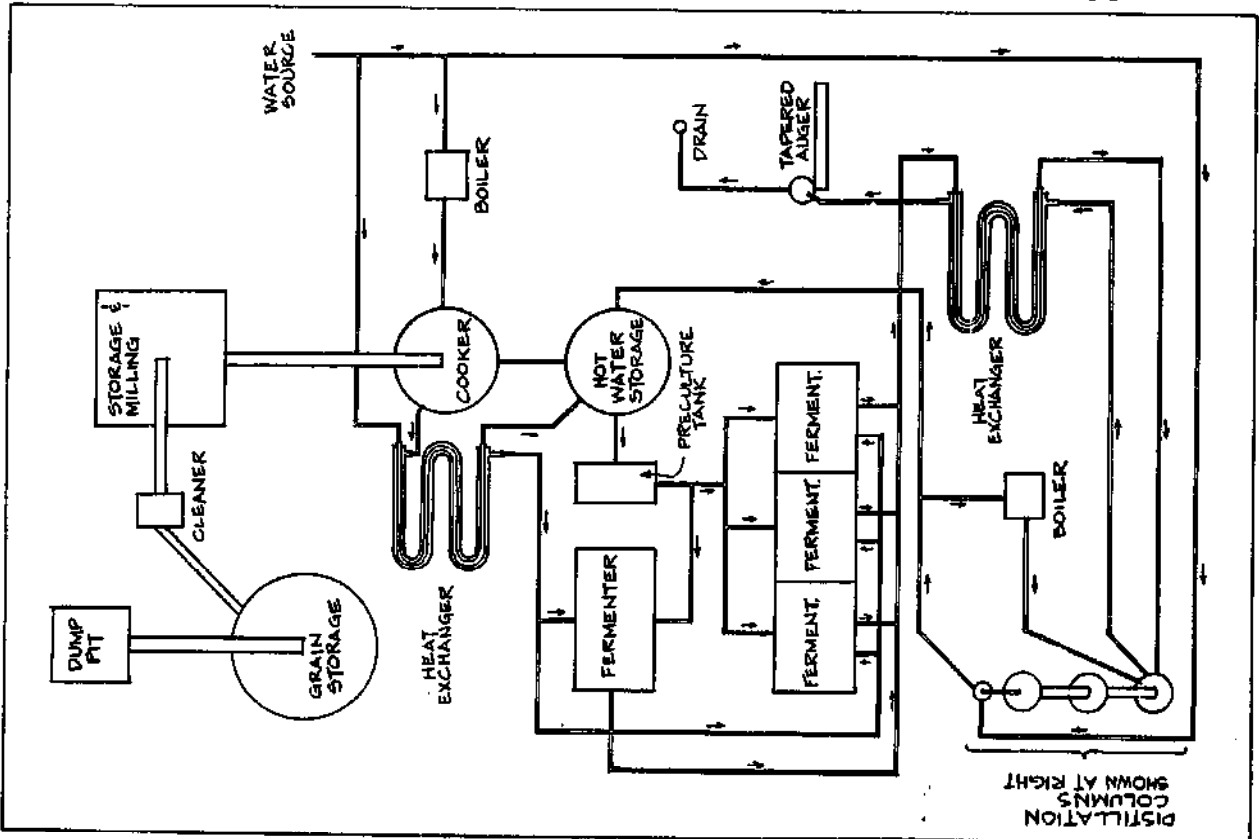

TOP VIEW

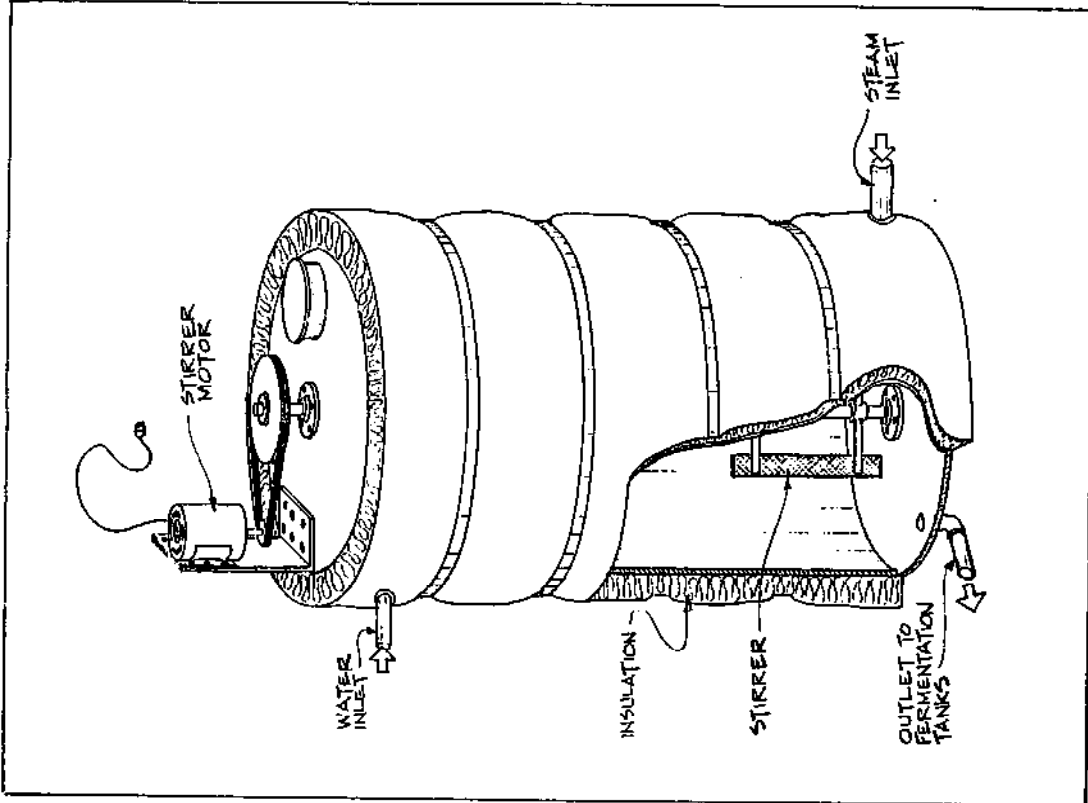

COOKER



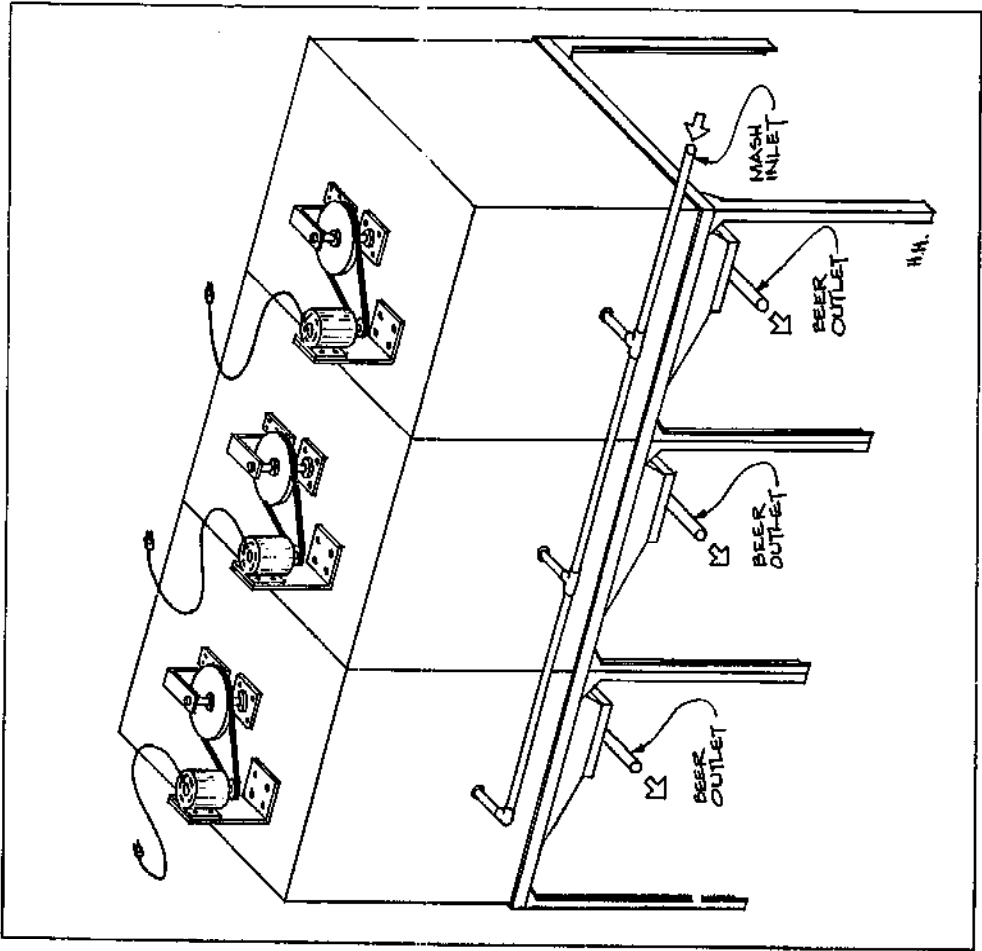

FERMENTER

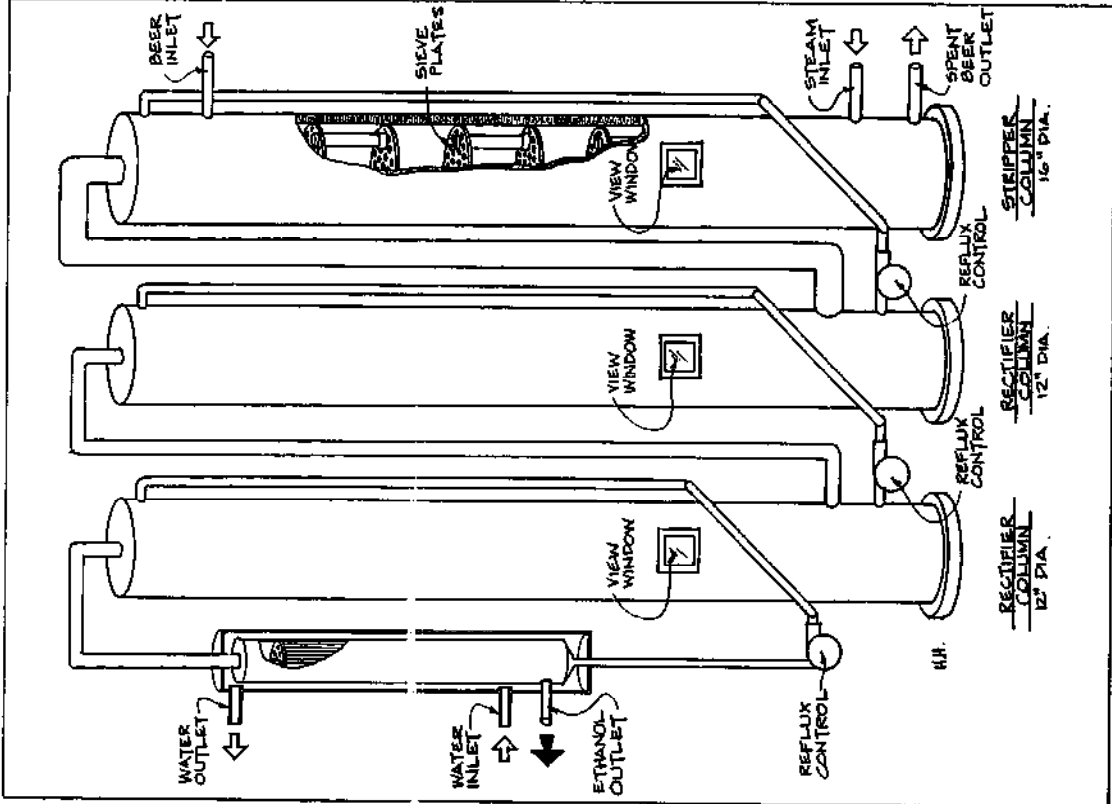

DISTILLATION COLUMNS

## PROJECT:

# Tennessee Gasohol Commission Rt. No. 10 Old Knoxville Highway

CONTACT: Marc A. Cardoso

Marc Cardoso of the Tennessee Gasohol Commission has been making alcohol since 1978. He has designed and built eight stills, and his first "Old No. 13" is still in operation. Cardoso has produced about 6000 gallons of alcohol, and runs an exhibition booth in Pigeons Forge, Tennessee featuring an operating "moonshine still" and gasohol displays.

"Old No. 13" is a batch still. Cardoso built it for about \$1,200 in one month using locally available materials and no specialized tools.

## FEEDSTOCKS/PREPARATION

Cardoso uses waste fruit, white and yellow corn, and garbage (soft table scraps, without meats).

The fruits and garbage are prepared with a garbage grinder, and the corn is processed with a hammermill through a 1/32 inch screen. Cardoso's feedstocks are either grown on his farm or donated by local groups.

## COOKING

Cardoso uses Biocon's recipe. For every bushel of feedstock, 25 gallons of water is heated to 140°F. About six ounces of Canalpha (Biocon's liquefaction enzyme) is mixed with every five bushels of feedstock. Cardoso also adds some (quantity not specified) of Biocon's biocellulase enzyme. The enzymes and feedstock are then added to the heated water and mixed continuously to eliminate lumping. The mixture is boiled for 30 minutes.

After the liquefaction is complete, the mash is cooled to about 160°F by adding cold water and the saccharification enzyme is added. The mash is held at 160°F for approximately 15 minutes. The mash is then cooled to about 90°F by adding more cold water; total volume is roughly 30 gallons of water per bushel of feedstock.

## FERMENTATION

Biocon's yeast (4 ounces/5 bushels) is added to the cooled, 90°F mash. After 24 hours the mash is pumped into a converted cement septic tank for the remainder of the fermentation cycle. Temperature and pH are not controlled during fermentation nor is the mash stirred. Fermentation times range from 24 hours for waste fruit to 72 hours for corn. Cardoso claims a beer alcohol content of 14 percent with fruit and 10 percent with corn.

## DISTILLATION -- Batch

After fermentation, the solids are separated from the mash and the liquid portion is distilled in the cooker/distillation tank of "Old No. 13." Cardoso describes his distillation columns as counter flow equilibrium columns with "packed pseudo sieve plates." 30-gallon drums stacked on end comprise the twin distillation columns, each 6-foot tall and 13-inches in diameter (see photo). The stacked drums are not welded together but sealed with a silicone substance; thus the drums can be separated and cleaned when necessary. The top and bottom of each drum are used as sieve plates, with small holes (1/2-inch in stripper section and 1/4-inch in rectifier section) drilled through 8-10 percent of the surface area. The drum columns are packed with stainless steel turnings. Cooling coils at the top of each column provide reflux for distillation.

Cardoso estimates production at four gallons of 80 percent alcohol (160 proof) per 70 pound bushel of corn and between 30 and 40 gallons of alcohol per 10 bushel batch.

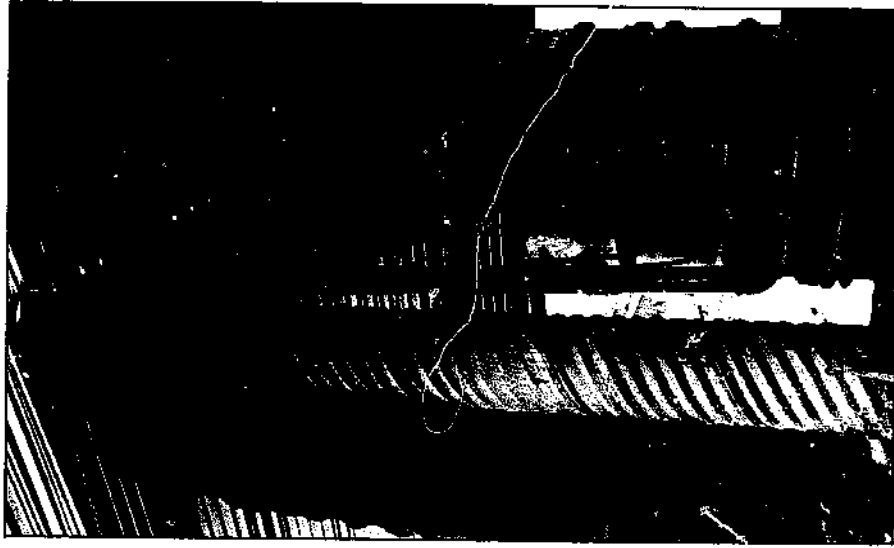

Sevierville, TN 37862

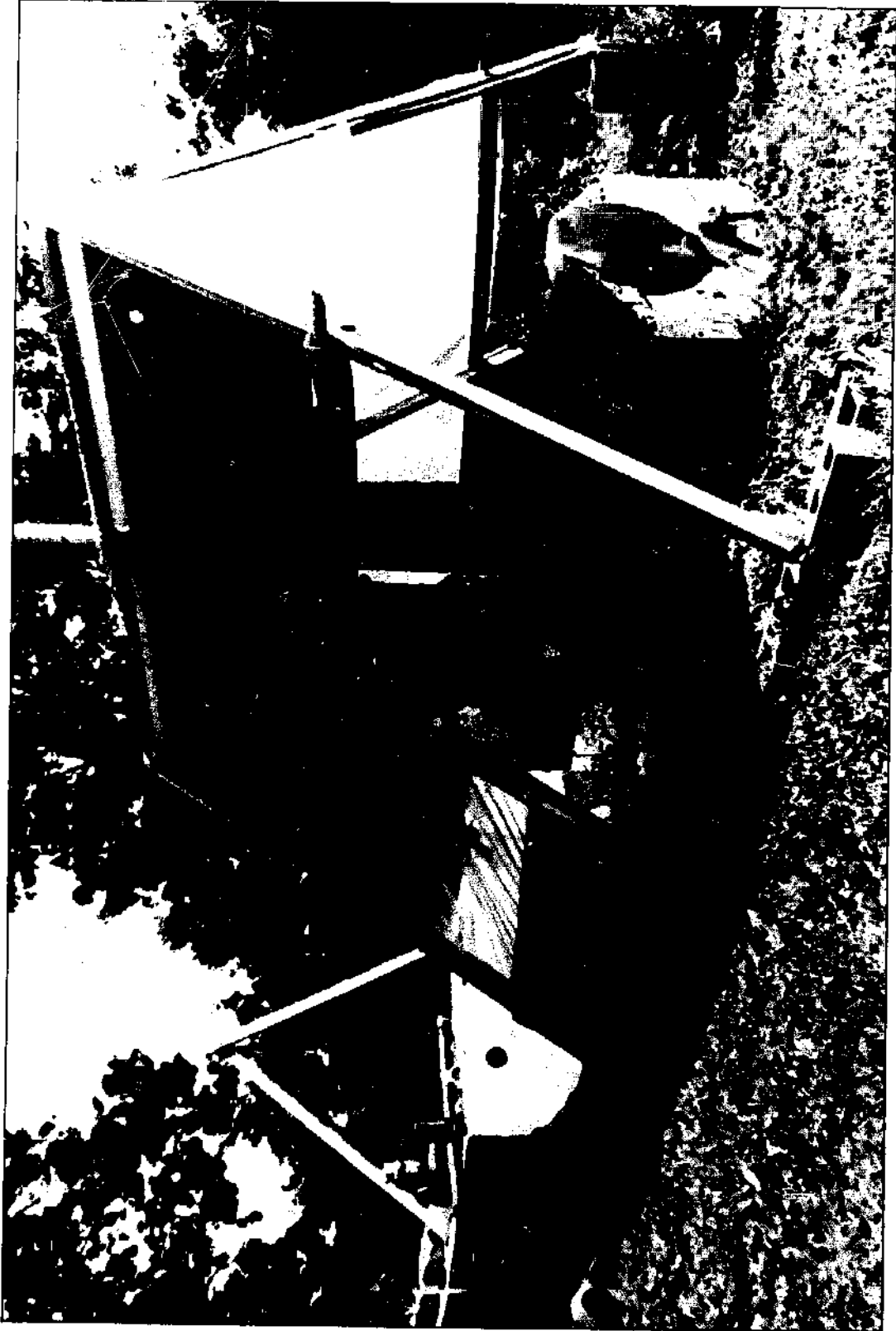

With the simple and inexpensive "Old No. 13," Cardoso demonstrates the practicality of alcohol production.

### DISTILLERS GRAINS

An old washing machine lined with burlap and run on the spin cycle is used to separate the solids from the mash. The solids are either fed to animals or recycled into the next batch.

### PRODUCT USE

The alcohol is used in a converted truck and for various experiments in fuel blending. Cardoso says the fuel works well in his Ford pickup, in lawn mowers, and in his home heating system. He also plans to sell alcohol fuel now that it is legal.

### ENERGY INPUTS

Electricity is used to run the grinders, the agitator motor, and a transfer pump. The balance of his energy for the still comes from burning waste wood and garbage. No estimate was made on the Btu/gallon of ethanol.

### LABOR

The real time necessary to operate "Old No. 13" on a full-time basis has not been calculated.

### CONTAMINATION CONTROL

Cardoso has had problems with contamination, especially with the septic tanks he uses as fermenters. To help control these problems, his housekeeping routine is as follows:

1. After the system is shut down he flushes everything with a solution of three tablespoons of powdered Draino for each five gallons of water. This is to remove any protein buildup in the system.
  2. The septic tank fermenters are cleaned out with a solution of five gallons of clorox bleach in 350 gallons of water.
  3. He then flushes the system with fresh water before he starts the next batch.
- Cardoso is also investigating the use of penicillin to eliminate contamination on his fermentation tanks.

### DESIGNER COMMENTS

Cardoso has designed a smaller, electric-fired pot still called the "liberator" which uses a 30 or 55-gallon drum. He claims there are numerous "liberators" being built in the area. The Tennessee Gasohol Commission is running a 1000 acre farm and Cardoso hopes to make it energy self-sufficient.

# CARDOSO'S SYSTEM

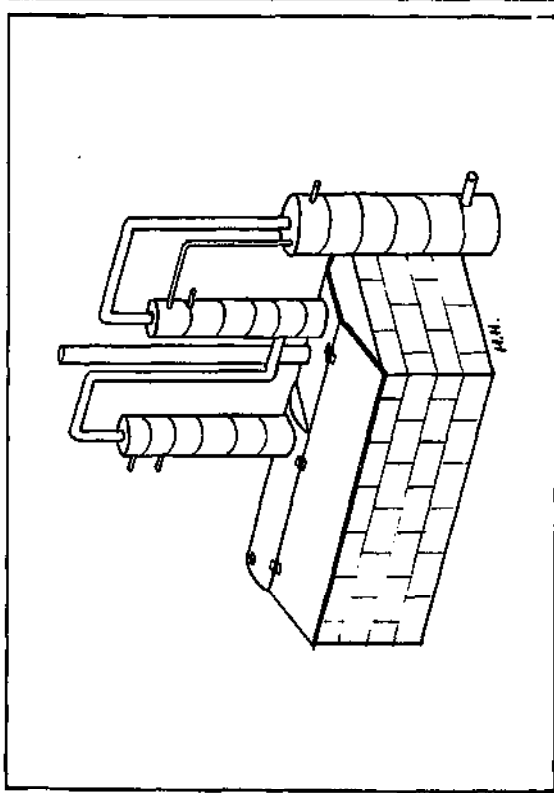

TOP VIEW

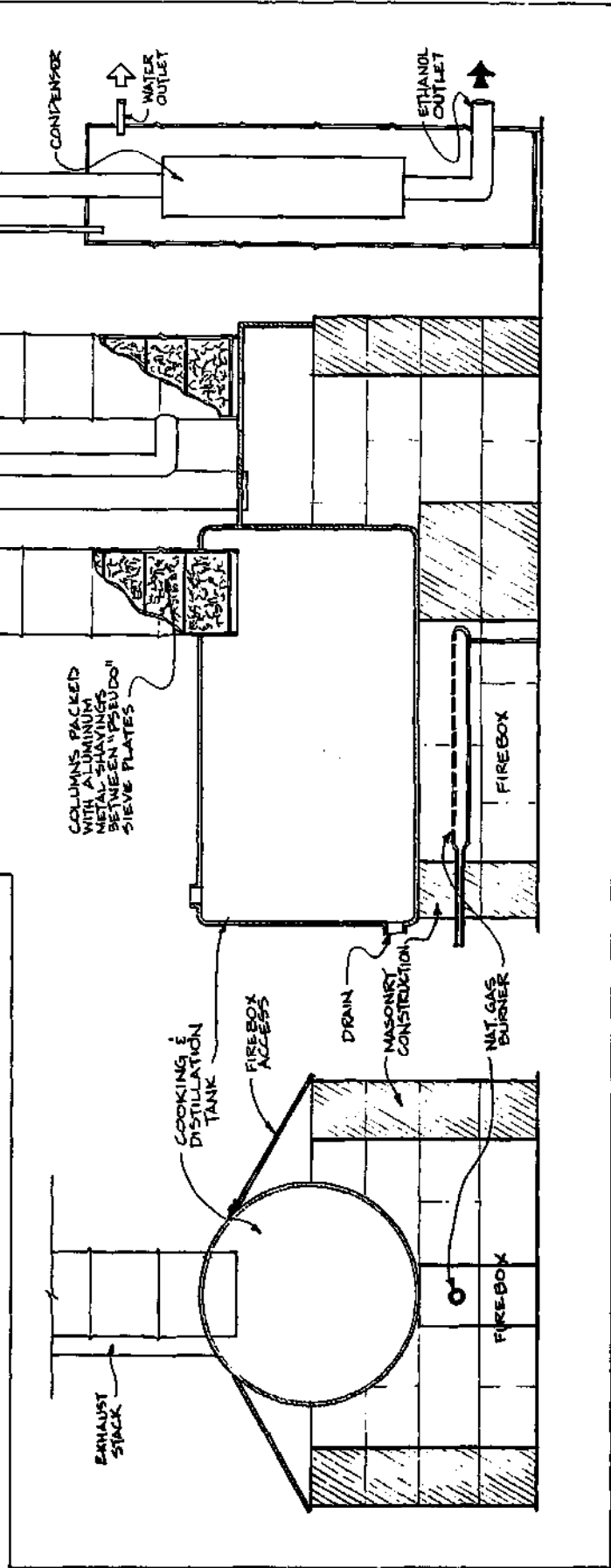

SIDE VIEW, CUT-AWAY

END VIEW, CUT-AWAY

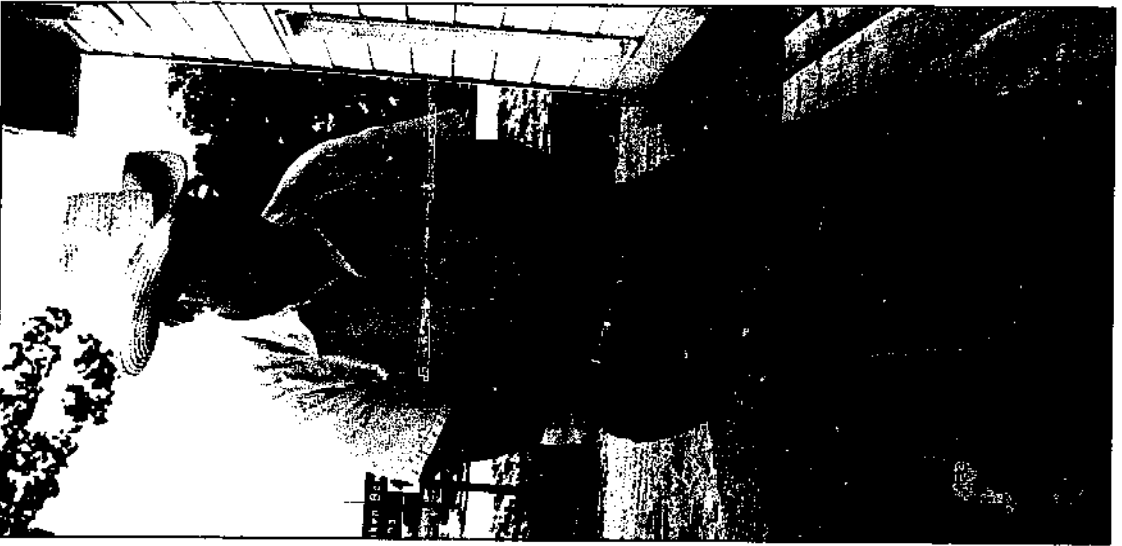

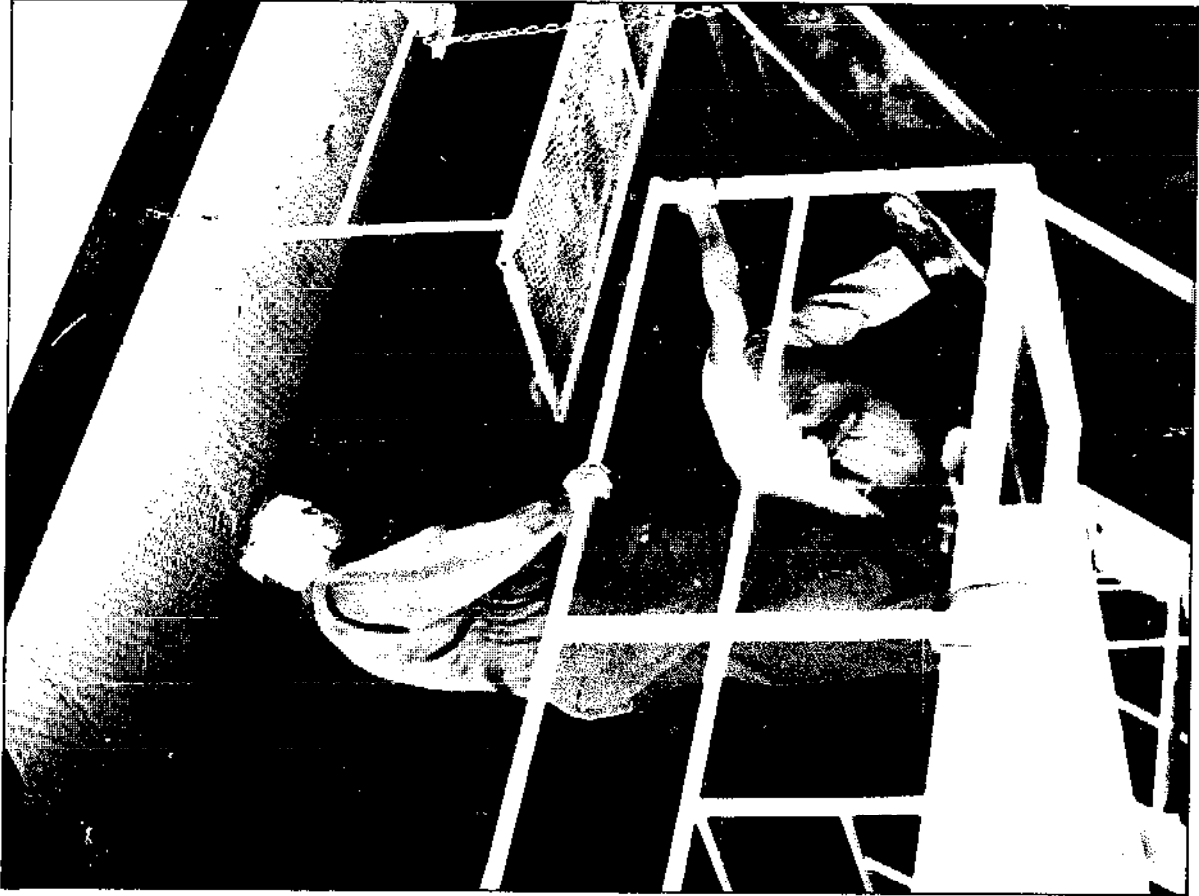







# Resource Directory

**National Center For  
Appropriate Technology**  
P.O. Box 3838  
Butte, Montana 59702  
(406) 494-4572

or

815 15th St. N.W.  
Suite 624  
Washington, D.C. 20005  
(202) 347-9193

**U.S. National Alcohol Fuels  
Commission**  
412 1st Street, S.E.  
Washington, D.C. 20003  
(202) 426-6490

**National Gasohol Commission**  
521 S. 14th Street  
Suite 5  
Lincoln, Nebraska 68508  
(402) 475-8044

**Farmers Home Administration**  
U.S. Department of  
Agriculture  
Room 5420-S  
Washington, D.C. 20250  
(202) 447-4323  
(for consult local  
directory for local  
FmHA listing)

**Bureau of Alcohol, Tobacco  
and Firearms**  
U.S. Department of Treasury  
1200 Pennsylvania Avenue  
Room 4402  
Washington, D.C. 20226  
(202) 566-7777

**National Alcohol Fuels  
Information Center**  
Alcohol Fuels Hotline  
c/o Solar Energy Research  
Institute  
1617 Cole Boulevard  
Golden, Colorado 80401  
(800) 525-5555

**U.S. Department of Energy  
Office of Alcohol Fuels**  
1000 Independence Avenue S.W.  
Room 6A211  
Washington, D.C. 20585  
(202) 252-9487

**National Alcohol Fuel  
Producers Association**  
P.O. Box 2756  
Lincoln, Nebraska 68502  
(402) 474-1977

**Midland Energy Institute**  
900 Grand  
Kansas City, Missouri 64106  
(816) 842-2459

**The Mother Earth News**  
P.O. Box 70  
Hendersonville, N.C. 28739  
(704) 693-0211

**Colby Community College**  
1255 South Range  
Colby, Kansas 67701  
(913) 462-3984

**American Agriculture News**  
P.O. Box 100  
Iredell, Texas 76649  
(817) 364-2474

**Ncat** the National Center for  
**Appropriate Technology**

P.O. Box 3838 Butte, Montana 59702

Non-Profit  
Organization  
U.S. Postage Paid  
Permit No. 381  
Butte, MT 59701