

Agrodok 14

Dairy cattle husbandry

Puck Bonnier
Arno Maas
Jolianne Rijks

© Agromisa Foundation, Wageningen, 2004.

All rights reserved. No part of this book may be reproduced in any form, by print, photocopy, microfilm or any other means, without written permission from the publisher.

First edition: 1996

Second edition: 2004

Authors: Puck Bonnier, Arno Maas, Jolianne Rijks

Editor: Peter Hofs

Illustrator: Dorothee Becu

Design: Janneke Reijnders

Translation: Sara van Otterloo

Printed by: Digigrafi, Wageningen, the Netherlands

ISBN: 90-77073-66-3

NUGI: 835

Foreword

Dairy cattle are kept all over the world. Keeping a dairy cow can be very lucrative, especially close to urban areas. The dairy cow is, however, a very valuable animal and owning one entails a number of risks. The biggest risk is losing the animal. Low productivity due to bad management will also lead to losses.

If farmers have no experience of livestock keeping we advise them to start with other sorts of animal, such as goats or sheep. These are easier to feed, and the economic risks are less (a goat or sheep is not as expensive as a cow).

This booklet is aimed at farmers who have experience with goats and sheep or with cattle and who want to start or improve their cattle keeping. It is especially meant for smallholders who are confronted with changing surroundings, whether ecological (such as in semi-arid areas) or economic (such as increasing demand for milk). These farmers may be wondering whether improvements or intensification in their cattle keeping will help them to improve the profitability of their farm. This booklet should help them to make decisions.

This booklet is not aimed in the first place at those traditionally involved in livestock keeping, such as pastoralists in arid areas of Africa.

You can order booklets on related topics through Agromisa/CTA. These include "Small-scale preparation of dairy products" and "Goat keeping in the tropics".

Contents

1	Introduction	6
1.1	Reasons for keeping dairy cattle	6
2	Farming systems	8
2.1	The three cattle farming systems	8
2.2	Constraints for the different farming systems	11
2.3	Important aspects within each farming system	13
3	Feeding of the cattle	15
3.1	Stomach functioning and feed requirements	15
3.2	Water	17
3.3	The protein and energy requirements	17
3.4	Quantity and quality of feed	20
3.5	Supplements	23
3.6	Minerals and vitamins	25
4	Animal health	27
4.1	Disease prevention	27
4.2	Health control: regular observation	28
4.3	Measures after observing something unusual	29
4.4	Disposal of a dead animal	33
4.5	The importance of a health record	34
4.6	Causes of ill health	34
4.7	Diarrhoea or scouring	35
5	Diseases and disease control	36
5.1	Vaccinations	36
5.2	Worm prevention	36
5.3	Tick control	38
5.4	Trypanosomiasis control	41
5.5	Skin and hoof problems	43
6	Reproduction	44

6.1	Calving interval	44
6.2	Heat	45
6.3	Heat detection	47
6.4	Servicing a cow	49
6.5	Abortion	50
6.6	Administration	50
7	Calving and calf rearing	53
7.1	Calving or Parturition	53
7.2	Calf rearing	55
7.3	Heifers	60
8	Records, farm administration and economic analysis	61
8.1	Records	61
8.2	Cost-Benefit Analysis	64
8.3	Remarks concerning the economic analysis:	66
8.4	Conclusion	69
	Appendix 1: Points to look for when buying an animal	71
	Appendix 2: How to handle cattle	73
	Appendix 3: Urea treatment of straw	74
	Making a molasses-urea lick-block (measures in kilogramme)	75
	Appendix 4: How to milk a cow	76
	Further reading	80
	Useful addresses	81
	Glossary	82

1 Introduction

Dairy cattle are kept all over the world. Keeping a dairy cow can be very lucrative, especially close to urban areas. The dairy cow is, however, a very valuable animal and owning one entails a number of risks. The biggest risk is losing the animal. Low productivity due to bad management will also lead to losses.

If farmers have no experience of livestock keeping we advise them to start with other sorts of animal, such as goats or sheep. These are easier to feed, and the economic risks are less (a goat or sheep is not as expensive as a cow).

This booklet is aimed at farmers who have experience with goats and sheep or with cattle and who want to start or improve their cattle keeping. It is especially meant for smallholders who are confronted with changing surroundings, whether ecological (such as in semi-arid areas) or economic (such as increasing demand for milk). These farmers may be wondering whether improvements or intensification in their cattle keeping will help them to improve the profitability of their farm. This booklet should help them to make decisions.

This booklet is not aimed in the first place at those traditionally involved in livestock keeping, such as pastoralists in arid areas of Africa.

You can order booklets on related topics through Agromisa/CTA. These include "Small-scale preparation of dairy products" and "Goat keeping in the tropics".

1.1 Reasons for keeping dairy cattle

There are several reasons to keep dairy cattle:

Short term reasons: direct economic returns on products such as milk, meat, hides, manure, traction, etc.

Long term reasons: investment, bank and/or life insurance.

It is important to be aware of the risks in both cases. A head of cattle is a big investment; you can lose it through careless management. The costs involved in making cattle profitable are also considerable. This booklet should make these risks and costs more clear. If you only keep animals for long term reasons, you may well hire someone else to do the daily work for you. For both economic and ecological reasons, it might be advisable to check on alternative possibilities for investment. In order to make a decision on whether to take up dairy cattle farming, or on how to change your farm management system you should ask yourself the following questions:

- How is the availability and accessibility of production factors and inputs?

These are land, climate, labour, veterinary assistance etc. Dairy cattle require more inputs and more regular labour than beef cattle.

- What are the local marketing possibilities?

Does anyone want to buy your products, milk, meat, hides etc.?

Who will sell the products and what will this cost?

Can you sell the products all year round or only in a certain period?

What do other farmers do: is it an advantage or disadvantage for you to do the same thing, or would it be better to do something else?

Although we have tried to cover all aspects of dairy cattle keeping, reading this booklet might raise more questions than it gives answers. If this is the case, do not hesitate to contact Agromisa with your questions. After reading this booklet you should be able to formulate your questions more precisely.

2 Farming systems

There are many ways of keeping animals for production. The one you choose depends very much on the circumstances in your area: climate, type of vegetation, market for selling the product, availability of labour and, last but not least, local traditions. For this reason we describe three examples of farming systems in this chapter. These will give an idea of possible options. Many existing cattle keeping systems can be compared with the systems described here. These systems are not completely different from each other, but overlap partly. Combinations are also possible. We give a description of the three systems, together with the limitations of each. This should help you to choose the system that best fits your situation.

2.1 The three cattle farming systems

The three systems discussed are the grazing-system, the grazing-with-supplementary-feeding-system and the zero-grazing-system (see Figure 1-3). These systems are defined according to the way the animals are fed, because this is one of the most important aspects of cattle raising. The type of feeding determines the most possibilities and constraints in a system, for example labour use and production potential. Here follows a description of each system:

1 Grazing system.

In this system the animals graze on natural or improved pasture. This may be on communal or on private grazing lands. Animals that graze along the roadside are also included under this system. This system could be used if you have enough land, but not much time for more labour intensive milk or beef production. It is also suitable if you have sufficient time, together with a small area of land, and you are happy with a fairly low level of production.

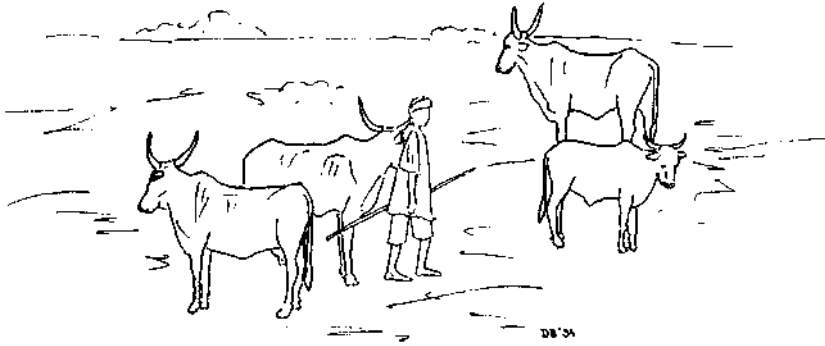

Figure 1: Grazing system.

2 Grazing with supplementary feeding.

Here we find the same way of grazing as above, but the animals' diet is supplemented with fodder crops and/or with concentrates (see Chapter 3). The supplements can be produced on your own land or can be bought on the market. Supplementary feeding is usually done when the animals are brought home, for instance to stay the night in a pen or in a shelter, or when they are being milked. Supplementary feeding is only possible if the milk price is high enough and supplements are not too expensive.

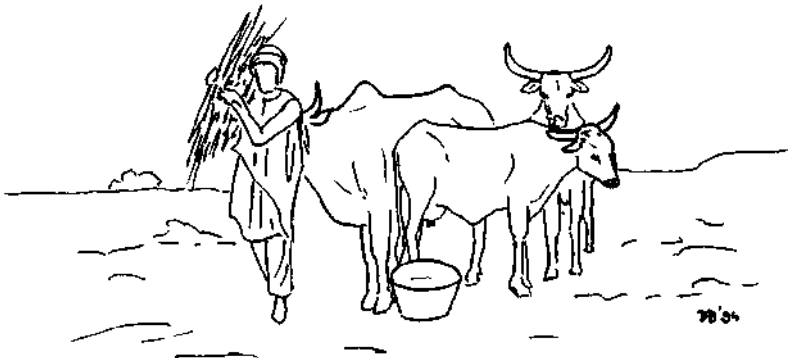

Figure 2: Grazing with supplementary feeding.

3 Zero grazing.

Within this system the animals stay in one place only and all the feed is brought to them. This means that not only the supplementary feed has to be bought or cultivated, and brought to the animal, but also the roughage (grass, hay etc.) and the water for drinking has to be brought to the animal (see Chapter 3). The grass can be cultivated (e.g. Pennisetum, Napier, elephant grass, Panicum, see Chapter 3) or cut from natural pastures. This system is mostly only used with dairy cows and only if the milk fetches a good price. Meat is not usually produced under this system as it can never be sold for a high enough price.

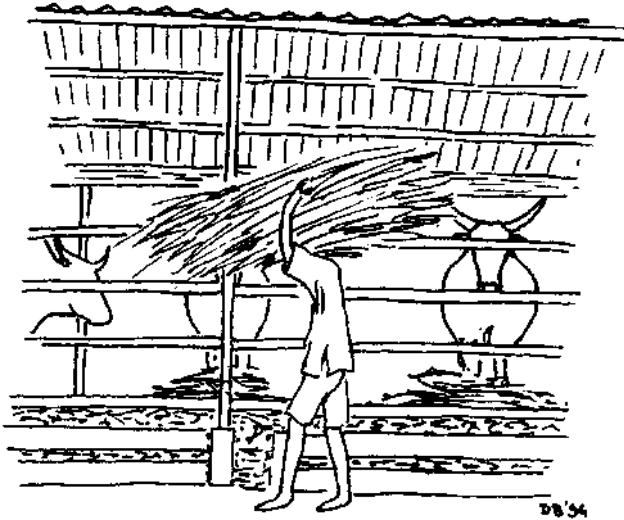

Figure 3: Zero grazing.

System 1 requires the least financial investment, labour and specialized knowledge. System 3 requires the most of each, and system 2 falls in between. With intensification the potential production level rises and needs less land. The land, however, will be used more intensively and thus needs to be manured in order to keep grass production at an acceptable and stable level. This will be discussed later in this

chapter in more detail. First we provide a description of the physical appearance of the systems.

2.2 Constraints for the different farming systems

There are many constraints that have to be considered before you start using a particular farming system, or before you change from one farming system to another. The extra inputs needed (money, labour and knowledge) and the consequences of changing a system have to be very carefully considered in advance. Otherwise big surprises may occur and the expected improvement in production might be disappointing. At worst it might even cost you money without bringing any improvement. Take notice of what your neighbours do, and of people that have tried to change their system of cattle keeping. It is better to exchange information with other farmers in your confidence, because they know most about the local situation.

The system you choose will depend above all upon the climate and the soil fertility.

Overgrazing should be avoided! Overgrazing means there are too many animals grazing on a too small area of land. The soil fertility will decline over the years, until there is no grass left for the animals. The amount of animals on a certain area should depend on the amount of pasture the land produces. In order to increase the amount of animals or the production per animal, you should raise the fertility of the soil by manuring with dung, spreading fertilizer or planting legumes. Another possibility is to supplement the animals with feed from elsewhere.

If animals are kept in a zero-grazing system, they do not graze, but still may affect the soil fertility. Soil fertility will decline if grass is brought every day from the field to the animals. The fertility of the soil can be restored by using the animals' manure on the soil that is providing the grass.

The chosen system should not cause or make worse erosion by wind or water. Wind erosion can be prevented by making sure the area is covered with plants or grass throughout the year. Water erosion on hill-sides can be prevented best by terracing, alley cropping and by ensuring that there is continuous ground cover. Grasses give good coverage throughout the year. Grazing is the most common system in areas where erosion is common and soil fertility is low.

Other important constraints on the choice of farming system are production aims, the availability of labour, the investment possibilities and management skills.

Production aim

It is not worth trying to intensify production if you keep animals as a form of saving or for home consumption of milk. This is because of the negative cost-benefit ratio (see Chapter 8). If your aim is production for a market, where you can expect a constant demand and a constant price, then it is worthwhile considering whether or not to intensify.

Availability of labour

Intensification always means extra work. Should the work be done by family members or is there a possibility of hiring labour from outside the family? The zero-grazing system is very labour-intensive. The grass has to be cultivated or cut somewhere from communal grazing land and brought to the animals. The animals eat large amounts. For grazing you only need a herdsman, because the animals find food themselves.

Investment possibilities

Intensification requires investments. Investments in better feed for milk cows can be repaid more quickly if you can sell the milk for a good price. Products sold over the long term and at lower prices, such as meat, repay less quickly and with less profit.

Zero-grazing also requires investment in a cowshed and in grass planting, if you cultivate the grass yourself. Investments made in zero-grazing will only pay off if you can get a good price for the milk, for

instance if you live close to a town where the price is high. This aspect of repayment will be explained further in Chapter 8.

Management skills

You will have to get used to each change you make in the production method. In the beginning this will always take more time than you expected. It is also very difficult to know how your animals will react to changes. Observe other people in your neighbourhood. Contact them, see how they produce and how they manage their production.

2.3 Important aspects within each farming system

In this paragraph we will indicate the chapters that are of importance for the three systems. The fact that the zero grazing system has the longest list shows that this is the most difficult system to manage.

Grazing system:

- Minerals and Vitamins (Chapter 3)
- Health (Chapter 4 and 5)
- Reproduction (Chapter 6)
- Calving and calf rearing (Chapter 7)
- Records, farm administration and economic analysis (Chapter 8)

Grazing with supplementary feeding:

- Functioning of stomach and feed requirements, water, protein and energy requirements and supplementation (Chapter 3)
- Minerals and Vitamins (Chapter 3)
- Health (Chapter 4 and 5)
- Reproduction (Chapter 6)
- Calving and calf rearing (Chapter 7)
- Records, farm administration and economic analysis (Chapter 8)

Zero grazing:

- Functioning of stomach and feed requirements, water, protein and energy requirements, quantity and quality of fodder and supplementation (Chapter 3)
- Minerals and Vitamins (Chapter 3)
- Health (Chapter 4 and 5)
- Reproduction (Chapter 6)
- Calving and calf rearing (Chapter 7)
- Records, farm administration and economic analysis (Chapter 8)

3 Feeding of the cattle

After reading this chapter you should be able to weigh up your animals' needs against the economic possibilities available to you. Here we give you information on the various types of feed for cattle and the needs of the animal.

3.1 Stomach functioning and feed requirements

Animals need water and food in order to live, grow, work and give milk. Even when the cow is not producing, it needs energy to breathe, walk and ruminate, and it needs protein to grow (meat contains a lot of protein). The basic need, which is necessary to maintain a stable condition, is called the 'maintenance requirement'. The maintenance requirement is higher for a big cow than for a smaller one. The type of cow can play an important role in maintenance requirement. A local breed will have a lower requirement than an exotic or crossbred breed. 'Production requirement' is the requirement of extra feed for growth, work and/or milk production.

The cow

The cow is a ruminant, as are sheep and goats. Ruminants are cud chewing animals, with a stomach divided into four compartments. The first compartment, the rumen, is where food is partly digested before being regurgitated to be chewed as cud. This activity is called ruminating (see also Chapter 4). The rumen is very big, with a capacity of 200 - 300 litres depending of the size of the animal (see figure 4). The rumen is specialized for the digestion of roughage such as grass or hay, feed that is useless to other animals. Grasses and herbs may contain up to 80% of water. Although cows need a lot of water, roughage contains very little of the valuable substances needed for maintenance or production. Therefore cows need very large quantities of roughage.

A big cow, with a big stomach (rumen), may eat more roughage. She needs it because her 'maintenance requirement' is higher, but she can

produce more as well. Although cows are adapted for eating large quantities of roughage, they can also eat other types of feed such as grains, but they need a minimum amount of roughage

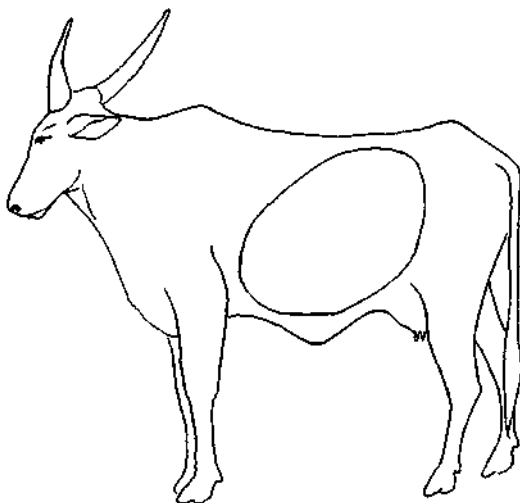

Figure 4: The position of the rumen in a cow.

to maintain the condition of the rumen. Eating and ruminating take up a lot of time. The animal spends one third (= 8 hours) of the day eating and one third (= 8 hours) of the day ruminating. You can recognize when a cow is ruminating: it chews the cud usually while lying or standing in the shade. The rest of the day is used for social contact with other cows, and for walking and sleeping. These activities are all spread over the whole day.

The calf

A calf's rumen is not yet fully developed. This means the calf cannot yet eat roughage. For this reason the calf needs milk. Milk is an easily digestible food for the calf. Especially in the beginning (first two days after birth) the calf needs the mother's milk, as this contains antibodies which protect the calf from disease. This first milk is called colostrum, and is described in more detail in Chapter 7. When the calf is about 6

weeks old it can start to eat roughage and/or concentrate, in order to get used to it. Try to start with high quality roughage because the calf is not yet used to it, and let it continue to suckle from the mother during this period as well. Crossbred calves can already start with concentrates during their second week in order to achieve optimum growth.

3.2 Water

Animals need water. Animals eat and chew their food very thoroughly and mix it with saliva before it goes to the rumen. Ruminants produce as much as 50 litres of saliva a day. Milk also contains a lot of water. To be able to produce saliva and milk, cows need a lot of water. They obtain part of their water requirements from the roughage they eat. The drier the roughage, the bigger the cow and the higher the production, the more extra water the cow needs: up to 45 litres a day. It is best to allow the animal continuous access to ample fresh, clean water throughout the day. If this is not possible you should try to give good quality water which is as fresh as possible at least twice a day (preferably in the morning and evening).

3.3 The protein and energy requirements

Feed contains energy, protein and water. We talk about two parts in the feed: water and the non-water-part, called Dry Matter (=DM). If you are not able to feed a big (exotic) animal properly it might be better to keep a few small animals. The maintenance requirement for a small local cow (weighing approximately 350 kg) is 7 kg Dry Matter a day. A larger cow (crossbred, weighing about 500 kg) needs 10 kg DM/day.

Example:

An adult local breed (350 kg) needs approximately 35 kg of grass a day. 20% DM of 35 kg = 7 kg DM, the rest: 80% is water = 28 kg. The water requirement is 45 litres. This is partly covered by the grass, which provides 28 litres. Besides this the animal needs an extra 17

litres of water. An adult crossbred animal (500 kg) would need 50 kg/day (10 kg DM) of the same grass and an extra 20 litres of water.

The energy the animal obtains from the feed is measured in mega joules (MJ) per animal per day (and is called Metabolisable Energy (ME)).

Protein is measured in grams of crude protein per animal per day. The maintenance requirements for energy, protein, dry matter and water are given in table 1, for animals with two different live weights. As well as protein, energy and water, the animal also needs vitamins and minerals. Information on this is given in Chapter 3.

Table 1: Maintenance requirements per animal per day.

Animal weight (kg)	Energy (MJ)	Protein (grams)	Dry Matter (kg)	Water (litres)
350	45	341	7	45
500	59	432	10	60

Animals need extra feed to produce power (= traction), milk and offspring, and also to grow. The type of feed an animal needs depends on the kind of production you want. Traction requires energy and therefore the extra feed should contain a lot of energy. Growth requires mostly proteins, and thus growing animals need feed with a lot of protein in it. For milk the animal needs both energy and protein.

Milk production

If milk production is your aim you should give special attention to the feed requirements of the cow. One week before calving give some extra high quality feed to strengthen the animal, because the animal will not eat very much during the first few days after calving. Once the cow has calved, she can be milked. Cows which have recently calved are very sensitive to nutrient deficiencies. If you supplement this cow with extra feed to stimulate milk production, take care that you do this regularly: preferably every day. You cannot do it by giving some one week and then nothing the following week! After a week with little or

no supplementary feed the milk production will drop and will be very difficult to stimulate again. The best period (economically speaking) to supplement with good quality feed is during the first 3 months after calving. The amount of Dry Matter required by a milking cow is 2.5-3% of its body weight. This is more than the maintenance requirements mentioned above! See table 2.

Table 2: Dry matter requirements for milking cows.

Body weight cow	350	400	450	500
DM Requirement (kg)	9-10.5	10-12	11-13.5	12.5-15

Meat production

Milk production cannot be raised after a period with little feed. Compensatory growth (meat production), however, will take place if feed is improved following a period with less feed. Table 3 shows the requirements necessary for growth.

Table 3: Growth requirements for animals of 100 and 400 kg respectively, with different levels of daily gain.

Weight (kg)	Daily gain (kg)	Energy need (MJ per kg weight)	Protein need (% in DM)	DM need (kg)
100	0.0	8.4	8.7	2.0
	0.5	9.2	12.4	2.3
	0.7	10.5	14.8	2.5
400	0.0	8.4	8.5	8
	1.0	10.9	9.4	10
	1.2	11.8	10.2	11

Crossbreeds

Many people prefer to keep crossbreeds for a higher milk production. Crossbreeds do indeed have a higher milk production potential, but they also require feed of a higher quality than local breeds: high quality grass and concentrates. If this high quality food is not available, it is not advisable to keep a crossbred. Crossbreeds need better management overall: not only higher quality feed and water, but also better housing and hygiene. They are very susceptible to diseases and there-

fore need extra medical help and vaccinations. Besides this, cross-breeds are more expensive and usually they are not as well adapted to local circumstances as local breeds.

3.4 Quantity and quality of feed

Feed can be divided roughly into two groups: roughage and supplements. The roughage in turn can be subdivided into three groups: low quality feed, reasonably quality feed and high quality types. Common to all these types of roughage is the high quantity of fibre they contain.

Roughage

1 Low quality roughage.

These types of feed are usually dry, old and look like wood. They contain only a little protein and digestible energy but during the dry season there will be a lot of this available in your surroundings. Examples are: rice straw, wheat straw or old and dry grass (yellow colour) or grasses with a lot of stem. Normally low quality roughage will not meet maintenance requirements on its own, and will certainly not meet requirements for production. Supplementation with other products will be required. If there are better quality feeds available, it is better to use the rice/wheat straw as litter, and afterwards as fertilizer on the land.

2 Reasonable quality roughage.

Grasses which are not too old, and consisting of more than just stem: the kind of growth that you find after the rains. Examples of reasonable quality roughage are: grass (light green) or hay (made from young grass).

A diet of this kind of roughage should cover maintenance requirements, but is not sufficient to achieve milk or meat production. With the addition of a few supplements production would be possible.

3 High quality roughage.

These sorts contain more protein and energy than the other two, but less than the supplements. Examples are: young, fresh grass (dark green), bean straw and cassava leaves.

The main fodder types used for cows all over the world are grass and legumes. Therefore, we discuss a number of grasses and legumes here.

Grasses

There are many different kinds of grasses in the tropics. Every climatic region has grasses which are adapted to the region. Sometimes it can be profitable, if you have some extra money and labour available, to improve your grassland by introducing better grasses. Buy the seeds and sow them in a prepared field, or sow extra grass among your existing pasture. Discuss with your local extension worker whether it is likely to be worthwhile resowing the grass. The extension worker can help you work out what the benefits are likely to be, but also how much they will probably cost you. A better quality of grass also means extra inputs such as manure or fertilizer to maintain this quality. In a zero-grazing unit you need to be especially aware of the danger of a mineral deficiency in the soil of potassium, nitrogen or phosphorus. You need to be able to take appropriate preventive measures.

There are a few easy ways to measure the quality of the grass (see Table 4). If the grass is old and dry it contains a lot of dry matter, and the quality will be very low.

Table 4: Quality of grasses.

Good feed	Bad feed
<p style="text-align: center;">Dark green & juicy grass</p> <p style="text-align: center;">↓</p> <p style="text-align: center;">Tasty for the cow</p> <p style="text-align: center;">↓</p> <p style="text-align: center;">High quality:</p> <ul style="list-style-type: none"> ▶ less needed for maintenance requirement ▶ higher production potential 	<p style="text-align: center;">Light green & dry grass</p> <p style="text-align: center;">↓</p> <p style="text-align: center;">Less tasty for the cow</p> <p style="text-align: center;">↓</p> <p style="text-align: center;">Low quality:</p> <ul style="list-style-type: none"> ▶ more needed for maintenance requirement ▶ lower production potential

Note: Grass production during flowering is zero. By way of management you can prevent flowering by cutting the grass before flowering or by keeping the optimal number of animals on the grassland.

The cow needs to eat a lot of it just to meet maintenance requirements. With low quality roughage you need to use more supplements to achieve any production. If it is green and juicy, this grass contains enough energy and protein. It is tasty and the animal will be happy to eat it. Young, dark green grass contains only a small amount of dry matter, and the quality is high. To get enough dry matter the cow needs to eat a lot too, but with a little extra it will even start producing.

Legumes

Legumes are found all over the world. They can be trees, shrubs or herbs. They are easily recognized by nodules on the roots. Most, but not all, cultivated legumes have trifoliate leaves, a leaf consisting of three leaflets (see figure 5).

Legumes, especially the leaves, make very good feed supplements because of their high protein content. Be careful not to give too many leaves, because sometimes they contain small quantities of poison. For example: Leucena leaves can lead to death if too much is eaten (the amount given should not be more than 40% of the total feed supplied). Also some good advice here: prevent your animals from eating too much legumes by offering them a variety of different types of feed.

Another benefit from legumes is that they act as nitrogen fixers in the soil, which improves the soil fertility. Sowing legumes within grassland serves two purposes: grass yield will improve, and your animal feed will be of a higher quality. Another possibility is to use legumes in a fodder bank to supplement the cows. The animals can feed themselves (grazing-with-supplement-system) or you can cut some feed and bring this to the animals (zero-grazing).

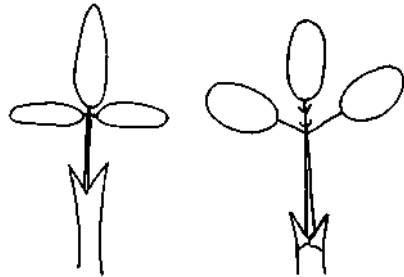

Figure 5: A trifoliate legume leaf.

3.5 Supplements

Supplements are products given in addition to the roughage in the cow's diet, if the roughage alone cannot satisfy the requirements for maintenance and production. During the dry season in particular, the roughage (straw) provided is usually not enough to cover maintenance requirements, or the animals are unable to eat enough to survive. Also during the rest of the year if you want to maintain a certain level of production, it could be wise to supplement your animals.

Supplementation can take the form of an extra dose of nitrogen (for protein) by treating straw with urea (contains nitrogen) or by providing extra urea (nitrogen) and molasses (energy rich) in a solidified lick-block. You can treat straw by adding 4 kg of urea to every 100 kg of air dry straw. Dissolve the urea in water and spray this over the straw. Then cover the straw with some plastic sheets. Use the treated straw as soon as possible. As this involves quite a lot of work it is best to make enough to last for several days to a week (see Appendix 3). The first time the animals may refuse to eat the treated straw because of the ammonia smell, but if this happens it will only last a few days. Be sure that the benefits obtained from this treatment are higher than the costs (the price of urea).

Another possibility is to make a lick-block containing urea and molasses. The block is given in addition to the roughage. These blocks are attractive and palatable to ruminants because of the smell and taste of molasses. To make these lick-blocks see Appendix 3. Cows can consume up to 0.5 kg per day per animal, depending on the size of the animal.

The processing of crops leaves waste products for which there is no further direct use. These are sometimes called concentrates because they contain a lot of nutrients and hardly any fibre in comparison with roughage. This feed (concentrate) alone is not sufficient for the animal. Cows need roughage to maintain the condition of the rumen. A minimum of one third ($1/3$) of the feed supplied should be roughage.

You can improve production with supplements but it is costly. Supplements require extra labour and money. Therefore they should only be used in the more intensive systems such as the grazing-with-supplementary-feeding or zero-grazing systems, and when you are sure there is a market for your products.

Supplements can be divided into three groups. Depending on the purpose of production of your cows you can choose a different supplement:

1 Energy supplements.

These supplements contain a lot of energy and can be used for draught-animals (animal traction) or cows which perform other kinds of work (see table 5 for products).

2 Protein supplements.

These are especially used to supplement the diet of growing animals (meat production). This group, made from by-products, contains a high amount of protein and less energy (see table 5 for products).

3 Balanced energy and protein supplements.

These products are good for milk production because they have a balanced energy and protein content. Most cakes are made from the by-products of oil processing, and contain a lot of energy as well as protein (see table 5 for products).

Table 5: Three different types of supplements.

Energy rich supplement	Protein rich supplement	Energy and Protein rich supplement
corn meal cassava chips cassava flour wheat bran wheat middling srice bran molasses fruits	Animal origin* such as: blood meal fish meal meat bone meal Cake: sunflower cake	Cakes: groundnut cake coconut cake cottonseed cake Others: brewers grain

* Make sure you practise good hygiene with these products: boil them before using them because they can contain diseases!

This list is not complete but gives you an idea of different supplements you can use for your animals. Look at your surroundings to find out which are the best and cheapest supplements to use. Maybe you use supplements which are not mentioned here.

A final word of advice: Make sure you feed your animals with a variety of different foods, and prevent them from eating too much of one single supplement.

3.6 Minerals and vitamins

Not only proteins and energy are necessary for maintenance and for production, but also minerals and vitamins. Minerals and vitamins are no problem if the cow eats a sufficiently well balanced diet (containing balanced concentrates and/or variety in roughage). Problems occur when a particular vitamin or mineral is lacking, or the diet is not balanced. The danger of eating too much minerals or vitamins is very unlikely to occur. If soils lack minerals, then the minerals will also be lacking in the plants growing in that soil, unless a particular mineral is concentrated in the plant, like, for example, calcium in legume-plants. Sometimes a lack of minerals or vitamins is noticeable more quickly in highly productive cows or in young animals. Changes in climate, growth or milk production can cause a mineral or vitamin deficiency.

Minerals

A list of all minerals, trace elements and vitamins follows.

Minerals consist of major elements and trace elements.

Major Elements:

Na = Sodium
Cl = Chloride
K = Potassium
Ca = Calcium
P = Phosphorous
Mg = Magnesium
S = Sulphur

Trace elements:

Fe = Iron
Cu = Copper
Mo = Molybdenum
Co = Cobalt
Zn = Zinc
Mn = Manganese
I = Iodine
Se = Selenium

Vitamins

Different vitamins: A - B - C - D - E - K

Although all the minerals above are essential to the health of the cow, in practice not all are likely to be limiting factors. If you want to know which minerals or vitamins are deficient in your area, please contact your local extension officer or local veterinarian.

With a normal varied diet (containing roughage and concentrates) there are unlikely to be problems.

In some areas the main problems are a lack of calcium and phosphorous. To overcome this you can make a so called calcium-phosphorous lick-block (a lick-block made of salt or molasses with extra Ca and P). The amount of calcium should always be the same as, or more than the amount of phosphorus, but not more than 7 times. For a description of how to make a lick-block, see Appendix 3.

4 Animal health

Taking good care of animal health does not only mean treating an animal when it is sick. It also means helping the animal to avoid becoming ill.

It is very important to realize that, even though treatment may eliminate the cause of the disease efficiently, the disease has already hurt the body. The effects of the disease may take longer to heal (if they do at all) than the time needed to eliminate the disease itself. Consequently, production losses may continue to be suffered after the animal has seemingly recovered. Examples of such production losses are retarded growth in calves and reduced milk production of cows after illness.

4.1 Disease prevention

The best is to discuss disease prevention measures with your district veterinary officer. He will give you advice that applies to your situation. The following paragraphs contain background information that can be of help to you in your discussion with him.

Most diseases can be prevented by the same measures that enhance production! General preventive measures are:

- Hygiene.
Cleaning and disinfecting. Remember disinfection is useless without cleaning thoroughly beforehand.
- Water.
Always ensure free access to clean and fresh water.
- Good feed and regular feeding.
- Shelter for protection against bad weather (rain, wind and cold, or intensive sunshine).
- Regular light exercise.
- A peaceful environment (avoid unrest and stress).

Another precaution to be taken is quarantine. This means isolating sick animals (during their illness) and newcomers (for about six

weeks) from the rest of the herd. This measure is often hard to implement, but helps to avoid the spread of contagious diseases to other animals.

Other diseases require other specific measures. These can be either:

➤ **Vaccinations.**

When an animal is vaccinated against a specific disease, the body of the animal will react to it, but the animal does not develop the disease. However, the animal's body has then been prepared to withstand an attack by this specific disease in its real form.

Sometimes a vaccination against a disease will protect the animal all its life against this disease, but most vaccinations have to be repeated after a certain amount of time to ensure protection.

NOTE: Vaccinations are not available for all diseases.

➤ **Preventive treatment.**

Sometimes we know a certain disease always occurs at the same time of the year. In some cases it can be useful to treat animals with medicine before we actually see the sickness in them. This will prevent them from becoming weak and avoid production losses. For example, preventive treatment against worms can be given before and after the rainy season.

4.2 Health control: regular observation

Regular observation of cattle at ease is a must, both for health control and for being able to tell whether a cow is in heat. The best time and frequency for observation are described under the section "Heat detection" in Chapter 6.

During observation of the animal, check the following points:

- **Behaviour:** Does it react normally to its environment or is it acting strangely?
- **Attitude:** Does it carry its head, ears, body and tail as usual? And gait: is there any change in the way it moves about?
- **Condition:** Is the animal in good condition, and is it well muscled?

- Does it eat, drink and ruminate properly? After eating, cattle older than six months will be seen chewing. After sometime they swallow the ball of food, which you can see as it slides down the neck into the stomach. If you continue to watch carefully, you will see after sometime that another ball of food is going in the opposite direction towards the head. The cow "burps" and starts chewing the new ball that came from the rumen part of the stomach. We say the cow is ruminating (see also Chapter 3). You can measure the rumen's activity by pressing lightly with your fist on the upper part of the left flank. The movement of the rumen expanding can be felt. Be careful not to confuse it with the breathing of the animal and beware of kicks (see Appendix 2 on handling of cattle).
- Does it urinate and defecate as usual? If a cow is being milked, the milk yield should be watched. Any sudden drop in milk yield is a sign of discomfort.
- Does anything else abnormal catch your eye?

4.3 Measures after observing something unusual

Call for veterinary assistance

If you find something unusual about your animal(s), you should call for veterinary assistance. This can be a veterinarian, a veterinary assistant or an animal health auxiliary.

You may live far from veterinary assistance. If this is the case, it could be worthwhile collecting some more useful information to tell the veterinarian when you call for him. It will help him estimate how urgent your case is. To obtain this extra information, you may do a general examination of your animal. Another option would be to ask your veterinarian if he can train somebody in your village or neighbourhood as an animal health auxiliary. Animal health auxiliaries are taught how to prevent, recognize and treat the most common diseases in their area.

Isolate and take special care of sick animals

It is strongly recommended to isolate unhealthy animals from the remainder of the herd. Beware of all body excretions and secretions (such as dung, urine, milk, blood and aborted material). They may contain the infectious agent and transmit the disease to other animals. Some diseases (such as tuberculosis, brucellosis and rabies) may even cause problems for humans. Therefore, make sure you take proper hygiene measures (cleanliness and disinfection). Sick animals need special care. Provide them with shade and protection against wind, fresh clean water and good quality feed.

General examination

Once again, always be careful with sick animals and be sure to respect the rules of hygiene. Abstain from further examination yourself if you have noticed strange behaviour.

Breathing frequency.

The normal breathing frequency of:

- adult cattle = 10 - 30 breaths/minute.
- a calf = 30 - 50 breaths/minute.

To count the number of breaths a minute, watch the right flank of the animal move out (inspiration, or breathing in) and in (expiration, or breathing out) for one minute: (1 breath = 1 inspiration + 1 expiration).

Pulse or heartbeat.

The normal pulse rate of:

- adult cattle = 50 - 80 pulse beats/minute.
- 2 months - 1 year = 80 - 110 pulse beats/minute.
- 2 days - 2 months = 100 - 130 pulse beats/minute.

The pulse should be regular. If it is not, be sure this is not due to incorrect recording.

If you can approach the animal without making it restless, you can take its pulse or heartbeat. The pulse is usually taken on the artery (blood vessel) called "*maxillaris externa*". If you stand to the left of the animal next to its head, facing in the same direction as the animal, you can pass your right hand under the head of the animal. Put your fingers gently on the bone of the bottom jaw, with just the fingertips on the right outside of the head. As your fingertips slide along the jaw from front to back, you will suddenly feel a thin "string" pass under them just before you reach the big round muscle on the jaw outside (the muscle used for chewing). You can become accustomed to finding the artery by trying on yourself or on healthy cattle. It might be of help to move your fingers back and forth along the jawbone. When you have found the artery, let your middle finger rest gently on it and count the pulse beats you feel while keeping track of time (see figure 6).

In young animals, the heartbeat can be felt by pressing the right-hand side of the calf against your left leg, leaning over and sliding your left hand between the left front leg and its chest.



Figure 6: The Artery maxillaris externa, used to feel the pulse.

Temperature

The normal temperature of:

- Adult cattle = 38 - 39°C
- Calf (up to 1 year) = 38,5 - 40,5°C
- A newly born calf = 38 - 40°C

Temperature is not necessarily a sign of fever. For instance, in adult cattle the digestion of food produces warmth that can result in a rise in body temperature. If temperature is due to fever, it is usually accompanied by shivers, faster breathing and pulse rate, the body tends to

retain water and the animal might have diarrhoea. Often the ears and the legs of the animal are cold to touch while the body is too warm.

If you have a thermometer, you can check the temperature of the animal by inserting it into the anus for a minute. In calves, insert the thermometer one third of its length, in cattle two thirds.

Be careful not to lose it (keep holding it) and do not break it (do not use with restless animals), because it contains mercury which is toxic.

If you have no thermometer, you may compare the warmth of the animal you suspect of fever by putting your hand on its back and comparing it with the backs of other animals that are healthy. Of course, this is just an indication.

Coat, skin, hooves and horns

A healthy animal has a shining, smooth and even coat, no skin wounds, shiny horns and hooves.

Mucous membranes

Just as the skin covers the outside of a body, the mucous membranes cover most of the inside: they can be seen on the inside of the mouth and the nose, under the eyelids, the inside of the vulva lips of a cow, and so on.

Check the colour of the membranes by lifting and gently turning them inside out, one by one. They should be pink (except when there is colouring of the skin continuing inside the mouth and the nose).

Look for bleeding and sores. They should not be present.

Lymph nodes

Lymph nodes or glands belong to the system which protects the body from disease. Lymph nodes grow in size in reaction to disease located near to them.

There are several lymph nodes that can be examined, but only the two which are the easiest to find will be described here. They are:

- Pre-scapular lymph nodes: locate by standing next to the shoulder of the animal and sticking your fingers halfway to two thirds down the shoulder blade under the front side of the blade. The fingers are then pointing backwards. Move your fingers over the skin until they

are pointing forwards. You should feel the gland slip under your fingers (see figure 7).

- Sub-iliac lymph nodes: Can be found by making the same movement at the rear leg, except that instead of sticking your fingers under the shoulder blade, you stick them in front of the rear leg, two-thirds of the way down the hip bone. Beware of kicking (see figure 7). Get used to the normal size of the lymph nodes by practising on healthy animals.

Your vet might teach you how to feel for other lymph nodes.

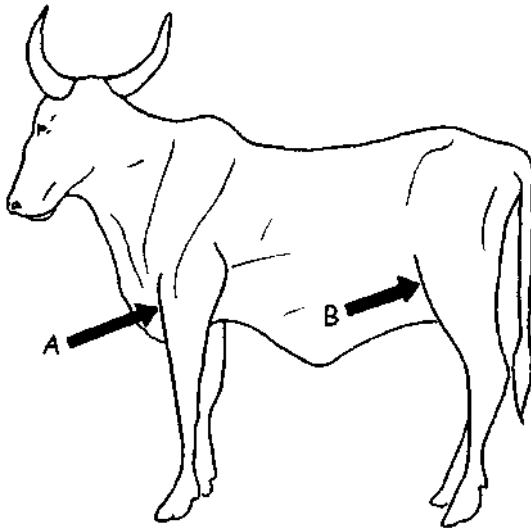

Figure 7: Position of two important lymph nodes. A: Pre-scapular lymph node, B: Sub-iliac lymph nodes.

4.4 Disposal of a dead animal

If an animal is found dead, the meat should not be sold or eaten. Neither should you leave the body somewhere to rot. Preferably, it should be burnt. Otherwise it can be buried deep (3 to 4 metres) under the ground.

If a diseased animal is killed in agony on farm (just before natural death), it is also not recommended that you sell or eat the meat. The

body should be disposed of as described above. In practice this advice does not seem to be respected.

If you decide to slaughter a sick animal because you think it will not recover, the best is to ask for veterinary advice. Unless the disease is highly contagious, slaughtering should be done in recognized slaughterhouses. If you slaughter on farm, veterinary personnel should be present to help select the edible parts from those that should be destroyed.

Beware of diseases dangerous to man, such as anthrax. In suspected cases of anthrax, do not open the body (the blood is highly contagious), and burn or bury the animal.

4.5 The importance of a health record

A health record of an animal is a piece of paper on which you write down all dates and facts relevant to this animal's health. It will remind you when to repeat a vaccination, and help you remember exactly how a disease proceeded in an animal, as well as the way the animal responded to treatment. The information might be needed years later, and the health record will help recall the details. Also it will help a new veterinarian, who might not know your farm very well yet, to give you correct advice.

4.6 Causes of ill health

Loss of health can have many causes, such as:

- Infectious agents (internal and external parasites such as worms & ticks, protozoa, bacteria, rickettsia, viruses and fungi).
- Nutritional deficiencies (in energy and/or proteins, minerals or vitamins) and metabolic disturbances (due to imbalances in feeding rations).
- Genetics (the animal may be born with an abnormality or acquire it).
- Accidents.
- A combination of these.

4.7 Diarrhoea or scouring

A symptom of loss of health which should be treated directly is diarrhoea, also called scouring. The following treatment can be given: Boiled water should be given to prevent dehydration (drying out). It is good to add 1 teaspoon of salt and 1 teaspoon of baking-soda to the water. If no improvement is seen after one day, seek veterinary assistance.

5 Diseases and disease control

In this chapter we describe some important measures to control diseases caused by infectious agents. To avoid diseases due to nutrient deficiencies you are referred to Chapter 3.

Ill-health due to genetic abnormalities can generally be limited by not breeding with the suffering animals, as well as avoiding "inbreeding". This means family breeding, for instance, do not cross a father bull with his daughter; look for another bull as sire.

5.1 Vaccinations

Vaccination against *rinderpest* is usually obligatory in Africa, and can be combined efficiently with vaccination against *contagious bovine pleuropneumonia*.

In areas where *haemorrhagic septicaemia* prevails (usually fairly humid), vaccination against this disease is usually compulsory too.

Vaccinations against *anthrax* and *black quarter* are strongly recommended in certain localities, even though most livestock-keepers seem to prefer just to hope their herd will not become infected. If it does, they tend to ask for "ring-vaccination" : the healthy animals of the herd are vaccinated, as well as the animals of surrounding herds.

If you keep milk-cattle it might be worthwhile vaccinating against *foot-and-mouth disease* and against *brucellosis*. It is best to contact a local veterinary officer to discuss with him which vaccinations to use. He knows which diseases are common in the area. The costs and benefits of these vaccinations should also be taken into consideration.

5.2 Worm prevention

A massive worm infection can express itself in the animal as a gradual loss in condition and production, or directly as illness. Although some kinds are relatively harmless, others suck blood (to the point that the animal has too little blood), or travel around the body until they become adult, thereby causing wounds and obstructions. For worm in-

fections, the golden rule really applies: "it is better to prevent than to treat".

How to prevent the destruction caused by worms? Life and reproduction cycles of different kinds of worms are different. Try to find out from your veterinary officer and the slaughterhouse officials which worms prevail in your area. The veterinary officer will then be able to advise you at what time to carry out preventive treatment of your stock.

Bear the following points in mind:

- Drugs that treat roundworm infections rarely also treat fluke infections, and vice versa. So if both groups of worms cause problems in your area, then be careful to treat against both.
- As far as prevention of worm infections is concerned, it is always best to treat all your animals, unless your veterinary officer says otherwise. Livestock-keepers sometimes have the tendency to treat only those animals which look worst. Unfortunately, as all the animals have grazed on the same pastures, all will be infected. The worms will reproduce themselves in those that are not treated, and worm eggs will be shed out in large amounts reinfesting the land.
- Some worms go through their life cycle developing on the ground and then in cattle. Others, before becoming adults in cattle, need to spend part of it in a different host, which is usually a particular invertebrate (snail, ant, etc.). This other host is called the intermediate host.
- Worms generally need humidity (and usually warmth) to help them develop. In the tropics this mostly corresponds with the rainy seasons (if there is a season distinction). This is why peaks of roundworm infections often start in the rainy season. Therefore preventive treatment is recommended before and after the rainy season. If the rainy season is longer than three months, a treatment during the rainy season is often also recommended.
- Flukes which cause problems in cattle usually have a snail as intermediate host. Such snails are found on marshy land and in stagnant waters. Flukes often become a problem when rivers stop flowing and dry up into small ponds, thereby concentrating the amount of

infected snails (usually towards the end of the dry season). Conclusion: if you water your animals in stagnant water, or own marshy grazing land, beware of flukes!

5.3 Tick control

Ticks are a real nuisance. They suck blood, and infect cattle with nasty diseases. Such diseases are called tick-borne diseases.

Although not all kinds of ticks transmit these diseases, they still weaken the animal by causing a loss of blood. They create wounds which allow bacteria to enter the skin (as in the case of the tick *Amblyomma variegatum* and the bacterial disease *Streptotrichosis*). As a result hides lose their value. Ticks may also attack the udder, causing the loss of a teat, thus making a milk cow less productive.

What to do about ticks? Different tick control measures will be discussed below. However, there is no standard answer to the question of the best way to control ticks. In most tropical countries they are difficult to control to an acceptable level without spending more on the control than the problem costs. There are preventive and curative treatments that can be effective against most tick-borne diseases if used in time (though they remain expensive). Intensive control of ticks is often only economic when exotic livestock is used in an attempt to improve productivity: this livestock tend to be more susceptible to ticks and disease but their higher productivity permits the cost of control. Consequently, you should find out which combination of tick and tick-borne disease control measures will be most economic for your farm. It will depend strongly on the kinds of ticks in your region, on the farm situation (kind of cattle breed, source of feed, etc.), and on the quality of the veterinary service available to you.

Once again we stress that you should discuss the matter with your veterinary officer, who knows the local tick situation and your farm situation, as well as the services he can provide. To illustrate the need to ask for his professional help, we will give you an example.

Example:

Suppose you have very little land, and you keep a 75% Frisian crossbred in your backyard in town which has a wall around it and hardly any vegetation in it. You sell its milk. You have no other animals. To feed the cow, you go out to gather grass along public roads every day. To control the ticks, you hand spray your cow and the stable twice a week. After reading the tick control options below, you may think that after a few months there will be so few ticks left in your backyard, that you will be able to reduce your control measures (and therefore your costs). The fact is, however, that one day you find your precious Frisian crossbred very ill with East Coast Fever! You did not realize that you were bringing in ticks every day with the feed for the cow gathered along the roadside. Your veterinary officer would have been able to warn you.

Tick control measures:

1 Host resistance to ticks.

Some cattle can acquire an ability to reduce the numbers and weight of ticks feeding on them. This is called host resistance to ticks. Some individuals and breeds are better at acquiring resistance than others. For tick control select for slaughter those animals that usually have heavy infestations of ticks, and keep those which show good host resistance to ticks.

2 Environmental tick control.

The use (strategic or not) of acaricides can contribute to low infestation of ticks on grazing land, but so can environmental tick control measures. These are: zero grazing, pasture rotation, rotation of crops, ploughing or re-seeding of pastures, and cutting or burning of grass. With zero-grazing you use pasture from places where the animals themselves do not go, so infestation from ticks and parasites should decrease (this will only be so if there are no cows from other farmers grazing on this pasture). Of course not all tick populations are equally affected by these different measures, and not all of these measures may be realistic in your farm situation. Environmental tick control is difficult to put into practice if you do not own

land or if you have not organized tick control with the other farmers with whom you share the grazing land.

Hyalomma tick infestation in cattle housing can be reduced by constructing the housing so that it is easy to clean properly and there are few cracks in which ticks can hide.

3 Use of acaricides.

Acaricides are chemicals that kill ticks.

a Toxicity: The acaricides used for tick control are generally also toxic to man and animals if they come into contact with them or ingest them in sufficient quantities. Acaricides should be used very carefully. This means that if you decide, for example, to sponge the acaricide onto the animal, always wear gloves, avoid sponging with your hand in an upright position, and wash off immediately any acaricide solution that comes onto your skin. The instructions of the manufacturer, as well as the precautions stated on the label, should be followed to the letter. Products should be plainly labelled for animal use. Do not use products labelled for plant use or home-made mixtures. Most acaricides are toxic to fish and these materials should not be allowed to enter streams or ponds.

b Application: Acaricides can be applied to cattle in several ways: dip baths and spray races are often used on large herds, and hand-spraying and hand-dressing on small herds. Make sure ears and axillae (where the legs join the body on the inside) are treated sufficiently. Ear-tags containing acaricide may be used in areas where the brown ear tick (*Rhipicephalus appendiculatus*) is a major problem.

c Timing: To control *Boophilus* ticks (which transmit Babesiosis and Anaplasmosis), treatment every 21 days reduces the number that can infest the pastures, but permits enough tick-feeding to maintain premunity (a kind of protection) against Babesiosis and resistance against ticks.

To control the other types of ticks of importance to cattle, treatment should usually be once every seven days. Exotic cattle un-

der threat of East Coast Fever should even be treated with acaricide twice a week.

- d Strategic dipping/spraying: In areas with distinct seasons, there is a time that the number of reproducing adult ticks increases. If you know which season this is, start treating your animals a few weeks in advance and throughout the season using the treatment intervals described above under timing.

This way you may be able to reduce the tick population on your land to a number that is below problem level, for the rest of the year. Of course for strategic dipping to be effective, you need to own your own land or agree with the other livestock-keepers with whom you share the land that all apply it to their herds. In wet tropical areas favourable to the ticks all year, strategic treatment may not be possible.

Always be careful with acaricides because ticks can build up a resistance to an acaricide.

4 Combinations of tick control measures.

Tick control measures are often used in combination. Here is an example of a combination that could be used for a local breed on a large farm in an area with a seasonal mass reproduction of ticks: strategic spraying, host resistance selection and pasture rotation.

Farmers use their imagination. For instance in Uganda a farmer bought land which was heavily infested with all kinds of ticks. He wanted to keep exotic milk cattle on it, but started off with local cattle which he dipped regularly to reduce the tick population. After several years he had managed to clear the land of most ticks and could then introduce expensive and susceptible exotic cattle.

5.4 Trypanosomiasis control

Trypanosomiasis is a protozoan disease transmitted by tsetse flies, often known in Africa as 'nagana'. It is characterized by anaemia (lack of red blood cells in the blood vessels, making the mucous membranes look whitish instead of pink), loss of condition, abortion, infertility, and if left untreated, high mortality.

In cattle, mainly three species of protozoa cause disease : *T. vivax*, *T. congolense* and *T. brucei*. *T. brucei* usually only produces mild disease in cattle, but infections from the first two species can be very severe. All three species are transmitted by tsetse flies.

Certain African breeds of small humpless cattle (e.g. Ndama) are less susceptible (i.e. tolerant) to the effects of trypanosomiasis than humped Zebu breeds.

The prevention and control of tsetse-transmitted animal trypanosomiasis depends partly on (inter)national measures including destruction of tsetse flies as vectors, and limitation of contact between livestock, wild animals and tsetse infestation.

On the other hand, trypanosomiasis control also depends on measures taken by livestock-keepers. These can be:

- 1 diagnosis and chemotherapy (see below).
- 2 chemoprophylaxis (see below).
- 3 the use of trypanotolerant breeds (such as Ndama).
- 4 participation in national control programmes.

1 Diagnosis and chemotherapy.

Diagnosis (= the identification of the disease): The diagnosis of trypanosomiasis depends on the detection of the parasites in the blood. You may already suspect that your animals have the disease because of its presence in your area and observation and examination of your animals. The veterinary service can detect the parasite in the blood using laboratory equipment. Chemotherapy (= treatment of the sick animals with medicine): An example of a medicine used for treatment of cattle sick with trypanosomiasis is diminazene aceturate, commonly known under the brand names of Berenil and Trypazen.

2 Chemoprophylaxis.

Chemoprophylaxis is the treatment of still healthy animals a little before we expect them to become infected or just after we suspect they may have been infected even though they show no signs of

disease yet. An example of a medicine used for chemoprophylaxis of trypanosomiasis in cattle is isomethamidium chloride, commonly known under the brand names of Samorin and Trypamidium.

It is essential that the timing of administration and the dosage of the drug is correct to prevent resistance (which means that the drug no longer protects against the parasite). Once again, ask the advice of the veterinary service for specific advice.

5.5 Skin and hoof problems

There are many reasons for skin problems. We will just describe a common one: Dermatophilosis, known as Lumpy Skin Disease.

Dermatophilosis is an acute or chronic, sometimes fatal skin infection, in which thick scabs form. A bacteria is found in the skin lesions, but in order for it to infect the animal it appears that the skin must already be damaged (for instance by a tick). Infected animals, including symptomless carriers, are the major source of infection. The disease is common in the humid tropics, and usually occurs during the rainy season. Certain breeds of cattle are more susceptible, such as exotic European breeds, while some of the local (African) breeds are much less affected.

The results of treatment are not always good.

In preventing the disease in cattle, the greatest benefit seems to result from the control of a certain tick called *Amblyomma variegatum*.

Hoof problems in local cattle usually have an infectious origin. But in crosses and full-bloods of exotic European breeds the origin may be that the breed is poorly adapted to local conditions.

For instance, Holstein-Friesians develop hoof problems when grazed continuously on steep humid hills. The reason we mention this is that cattle with hoof problems may show a serious drop in milk production. But the possible link between hoof problems and milk drop is sometimes forgotten. Animals in zero-grazing systems do not walk around, so their hooves are not worn down, so beware of hooves growing out of shape.

6 Reproduction

There are three ways in which reproduction can take place on the farm:

- 1 The bull is with the rest of the animals. If the bull and cows are fertile and if the male and female animals are together in one group, there are little problems with reproduction. No one can detect heat as well as the bull himself.
- 2 The bull is in the neighbourhood but not directly with the animals, and cannot reach the females. Reproduction depends on the detection of heat in the cows by the people that take care of them. For this situation we will give some practical explanations.
- 3 There is no bull in the surrounding area, but there is a good working Artificial Insemination (AI) programme, and semen is not too expensive. If you want to use AI be sure the service is working well and accurately. Too late an insemination and you will have to wait for another three weeks. The cows should be checked for heat every day, and it is best is to check several (3 - 4) times a day. Be sure the inseminator can reach your farm within 6 - 12 hours.

6.1 Calving interval

The calving interval expresses the economic importance of reproduction. The calving interval is the time between the birth of two calves by the same mother. The pregnancy of 9 months and 9 days (40 weeks) is included in this time.

Example:

With a calving interval of 3 years, a cow gives birth to a calf every 3 years. She will give birth to 2 calves every 6 years. A second cow, with a calving interval of 2 years, gives birth to a calf every 2 years, and thus will give birth to 3 calves every 6 years.

In the example the second cow gives birth to one extra calf every 6 years. This is important for both beef cattle and milking cows. Without a calf there is no reproduction and therefore no milk production.

Many people think that a shorter calving interval will give a lower milk production. In general they are right. The total milk production per lactation is somewhat lower with a shorter calving interval. The milk production per lactation means all the milk given in one calving interval. A cow with a shorter calving interval has more lactations in the same amount of years.

Again the same example:

The cow with a calving interval of 3 years might have a milk production of 2,200 litres per lactation. In 6 years she has 2 lactations and thus $2 \times 2,200 = 4,400$ litres (733 litres a year).

The second cow, with a calving interval of 2 years, might give 1,800 litres per lactation. In 6 years, however, she has 3 lactations and thus: $3 \times 1,800 = 5,400$ litres milk (900 litres a year).

This example shows the second economic advantage of a short calving interval. A short calving interval not only gives birth to more calves, but it also gives you more milk.

A calving interval of 1 to 1½ years is ideal, but difficult to achieve if there is no bull around and if the group of animals is very small. In a small herd there is little interaction between animals which makes it difficult to detect heat. Many cattle herds have a calving interval of 3 years or more and this can be improved if the following suggestions are followed.

6.2 Heat

Heat is the period during which a cow can be served successfully by a bull or inseminated artificially, if the latter is available.

In optimal situations heat occurs regularly, approximately every 3 weeks. Less optimal situations include:

- Heat stress: high temperatures and/or high humidity.

- Nutritional stress: imbalance in feed (proteins and minerals) or very little feed available due to seasonal effects.
- Suckling of calves.

All of these may suppress heat itself, or the signs which indicate heat in a cow.

The length of the heat period depends on the breed. Tropical breeds, like Zebus, have shorter heat periods than European breeds. The heat period lasts about 6 to 12 hours. So if you do not want to miss the heat period, you should watch your animals regularly, to see if there is a cow on heat (regularly means 3 to 4 times a day).

When the cow is ready to be served by a bull it is very important not to wait too long once you have seen the cow on heat, otherwise the cow won't allow the bull to jump.

1 Young cows.

Physically, animals can already be served at a young age. But if served at a young age, the animals will not attain a high bodyweight at the mature age. In Chapter 3 we explained that a bigger animal can eat more roughage and thus produce more: milk, meat or labour. An animal that calves at a young age will grow less than an animal that is served at an age of 1½ to 2½ years. Service at 2½ years is preferable to service at 1½ years, but do not wait much longer. Always be sure the cow is fertile and not a barren cow.

2 Bulls.

Bulls that are to serve cows can be used from 1 year old. In some cases, bulls might be infertile. A bull may be infertile, or less fertile if he has difficulties getting more than one cow pregnant. Try to get a veterinary assistant to check the bull.

3 Older animals.

What we write here applies to a situation where the cows and bull(s) are kept separately.

A cow is pregnant for 9 months and 9 days. To achieve an ideal calving interval of 1 to 1½ years, conception should take place

within the first 9 months after calving. Conception means that a cow is served by a bull and that she becomes pregnant.

Two months after calving a cow can be served again. Try to serve a cow at the first visible heat after these 2 months. If a cow comes on heat again, 20 to 23 days later, she has to be served again, as she is not pregnant.

When a cow does not come in heat again, you can expect a calf 9 months after the last service, if all goes well. Check these cows regularly (at intervals of 3 and 6 weeks) after this time because sometimes the embryo or foetus dies after conception and the cow comes in heat again.

When a calf suckles from its mother it might be that the cow does not come in heat, or that heat signs are difficult to detect.

With each heat you miss, you must wait another three weeks before the cow can be served. This means 3 weeks more of an unproductive cow. This lack of productivity also occurs if you miss a cow that returns in heat after service. The fact that a cow returns in heat means that she is not pregnant.

Local breeds may not come in heat while the calf is still suckling from the mother.

6.3 Heat detection

A bull will always notice a cow in heat and will serve her if there are no boundaries between the bull and cow. Many cows have heat signs that are difficult to notice for humans. The heat signs that humans can see are:

- The animal becomes restless, sometimes separating itself from the rest of the herd, walking along fences to seek a bull.
- The animal tries to mount other animals, sniffs them and is sniffed at by others (see figure 8).
- The animal bellows in order to attract a bull (the Zebu does not do this).

- Standing heat: the cow stands still when she is mounted by other animals (standing is the only reliable practical test of heat, see figure 8).
- Signs that the animal has been mounted by others, such as mud on its flanks, bare patches of skin on the hook or the pinbone, ruffled hair on the back etc. (see figure 8).
- The lips of the vulva turn red and are somewhat swollen (see figure 9).
- There is a discharge of clear, thin mucus hanging from the vulva or adhering to the tail (see figure 9).

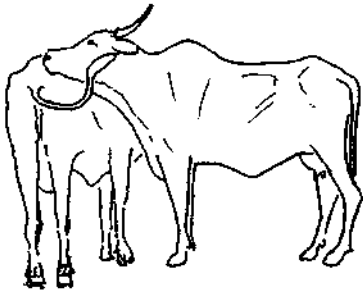

a: Cow sniffs and is sniffed at by others

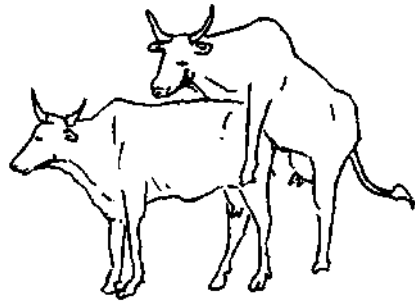

b: If the cow stands still, she is definitely in heat

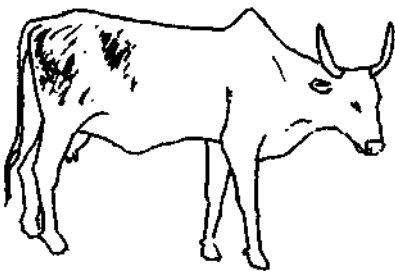

c: Bare patches of skin on the hook or the pinbone

Figure 8: Signs of a cow in heat.

The average heat period lasts about 11 hours, so in order to detect heat you should check the cows at least 3 times a day: early in the morning, in the afternoon and late in the evening (spend about 20 minutes each time). Cows should be calm (not distracted by feeding or so).

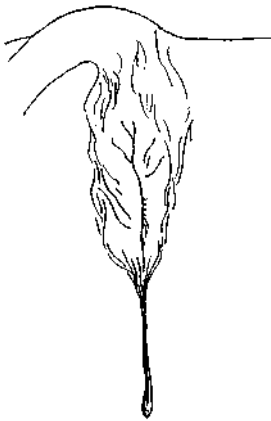

a: Lips of the vulva of the cow are red and swollen.



b: Clear, thin mucus hanging from the vulva.

Figure 9: Signs of a cow in heat.

6.4 Servicing a cow

Servicing is more successful if carried out during the second half of the heat, so about six hours after the detection of heat. A cow should be served by a bull during the standing heat. After that period the cow will refuse to let the bull service her.

Silent heat: the animal has normal heat cycles, but there are no heat signs or these are not noticed. Heat detection is very difficult, especially with tropical breeds. In this case it is preferable to keep a bull with or close to the cows.

The only reasons for keeping bull and cows separately is because cows in heat might not yet be ready to be serviced (for example young animals) and because it might be difficult to handle and milk the cows if the bull is present in the group.

One reason not to keep your own bull is because it might be cheaper to use your neighbour's bull. Another would be if there is an artificial insemination centre at short distance (so insemination can be done within 6 hours). If the reproduction rates get worse however, this economic advantage might become a disadvantage.

Servicing by a bull gives the best results, but it might be cheaper to use artificial insemination, as you will not have to maintain (house and feed) your own bull.

6.5 Abortion

The first three months after conception are quite critical. Sometimes the embryo or foetus dies and an abortion follows. Embryo loss can happen without any clear visible sign. Therefore heat detection at intervals of 3 or 6 weeks should continue also after conception.

Several causes of abortion are:

- Nutrition: a lack of good feed and/or enough feed.
- Hygiene: cow develops an infection due to lack of good hygiene.
- Disease: Brucellosis is a disease which causes abortion.

Always try to find out the cause of an abortion so you can try to prevent this happening during the next pregnancy.

6.6 Administration

Administration is important to be able to make economic calculations and therefore to select which animals to sell and which to keep yourself. Another reason for keeping track of services is so that you know when to expect a calf. Administration can also be of great help in detecting problems or bottle necks in the long term production on your farm. You can also compare your farm results with those of other

farmers. Good administration will cost you some time and effort, but you may be able to get some help from a local extension worker.

Name of cow:		Date of birth:				
Sire:		Dam:				
		1 st calf	2 nd calf	3 rd calf	4 th calf	5 th calf
Date of heat	1					
	2					
	3					
	4					
	5					
Date of service and name of bull	1					
	2					
	3					
	4					
	5					
Expected calving date						
Date of drying off						
True calving date						
Name and sex of calf ♀ = female; ♂ = male						
Calving interval						
Total milk production						

Figure 10: Example of an individual cow record.

Every cow has its own card (see figure 10), on which the sire (bull) and dam (cow) are noted. Further it notes:

- date of birth of the cow
- dates of heat
- dates of service
- expected calving date
- true calving date
- calving interval
- total milk production per lactation (see chapter 8)

The calving interval (low is best) and the total milk production per lactation (high is best) indicate from which mothers the calves should be kept. If a cow has a low calving interval and a high milk production per lactation, there is a greater chance that her daughter calf will do the same.

Male calves can also be selected this way, and can be sold to or exchanged with other farmers. To keep a male calf for your own farm might lead to problems because of inbreeding. Therefore try to get some new blood (bulls or cows which are not relatives of your animals) into your herd.

7 Calving and calf rearing

7.1 Calving or Parturition

Parturition is giving birth to the young calf. The calf can be expected 9 months and 9 days (40 weeks) after servicing takes place. Two months before the expected calving date (the parturition), so 7 months after service, the cow should get plenty of rest, because the growth of the calf takes up a lot of the cow's energy. This means that 2 months before the expected calving date, a milking cow should be dried off (i.e. you should stop milking her) and a cow you keep for traction should stop working.

Once the date of expected calving gets closer, the cow needs a comfortable place, where she can lie down easily and which is clean. The cow or the calf might incur open wounds during delivery, and the dirtier it is, the more trouble you will have with infections. You can clean your hands and the vulva of the cow before calving begins to prevent disease and infection.

Before the parturition the animal becomes restless, usually seeks seclusion, lies down and gets up frequently, attempts to urinate often and then starts with the actual labour of delivering.

Parturition can be divided into three stages:

- 1 The water bags come through the birth canal. This may take 2 to 6 hours.
- 2 In the second stage the actual delivery of the calf occurs. First the front legs come out, then the head, and after that the whole body comes out. Once the front legs are out the calf must be out within an hour. Otherwise the calf might suffocate.

The normal birth position (presentation) is with the front legs first and with the nose between the front legs (see figure 11).

If the calf presents differently the parturition is much more difficult. In that case you will see the cow really working to deliver the calf,

but nothing comes out. If it takes more than 8 hours, get veterinary help.

If you help the cow with the delivery of the calf, you should pull at the two legs. Always pull to the side of the legs and udder of the cow and never towards the tail side. If you pull, then only do so with a maximum of 2 people and pull only at moments when the cow is pushing herself.

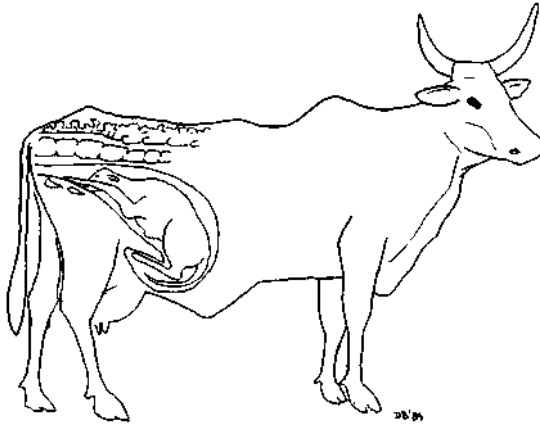

Figure 11: Normal presentation of the calf.

3 The third stage consists of the parturition of the placenta (after-birth), which normally follows the calf almost immediately. If, however, the placenta has not come out within 12 hours, you should contact a veterinarian.

If two calves are born from one cow at the same time, you have to be aware of possible infertility. If these calves are both male or both female there is no problem. If the calves have different sexes, the female calf may be a barren cow. This means that the young calf is infertile; she can not be used for reproduction or milk production.

7.2 Calf rearing

The calf rearing period, which is the period from birth until 6 months after weaning, is a period with many risks. The highest mortality rates occur in this period. The newly born calf is very weak and susceptible to diseases. During this period it needs extra care, with particular attention to good feeding, health, hygiene and housing.

Feeding of the calf

A calf needs its mother's milk in order to start a healthy and productive life. Milk contains all the necessary nutrients. It is full of energy, protein, minerals and vitamins. As mentioned in Chapter 3, it is very important for the calf to drink a sufficient quantity of the first milk, called colostrum, during the first 48 hours. This milk contains antibodies, which give the calf resistance to the prevalent diseases.

Beware of giving the mother cow medicines during the period of lactation because her milk might become contaminated with these medicines. This can make the calf sick or cause diarrhoea.

The calf needs 10 percent of its live weight in milk each day in order to grow 1 percent in live weight per day. So a calf that weighs 30 kg needs 3 kg milk daily. Too little milk will weaken the calf, make it more susceptible to disease or the calf might die because of malnutrition. If the calf is a female and she is given too little milk she will grow slowly and will be older before being able to be served. She will stay small, also as an adult, so her milk production potential will be lower. So, offering the calf too little milk will give lower milk production (and income) later. A good supply of milk for a female calf now will increase your income in a few years' time (see also Chapter 8). Too much milk, however, will give the calf diarrhoea.

Many tropical cattle breeds will not let down the milk if the calf is not present. This means that if the calf dies, the cow stops lactating. If the calf lives, the calf starts suckling and then the farmer can take over. After hand milking the calf can suckle again. This time she cleans up any milk remaining in the udder. Milking by hand can only be done

twice a day otherwise there is not enough milk left over for the calf. This kind of calf rearing is called suckling. The calf is not restricted in its milk intake. Especially if milk prices are high, restricted suckling is a good alternative to enable you to also get as much milk as possible. Let the calve suckle for a restricted time, 15 to 20 minutes, twice daily and then you continue to milk by hand for collection of milk for home consumption or sale. Another possibility is to milk two or three teats and leave the other(s) for the calf (make sure you use different teats each day). In the zero-grazing system sometimes bucket feeding is used to control the amount of milk the calf drinks. You can only do this if your cow will let down the milk without a calf. Bucket feeding means a lot of extra work. In terms of hygiene it is best to feed the calf by letting it suckle from the udder. If you milk in a bucket, you will have a better idea of how much milk is offered to the calf. If, however the bucket is not clean, the calf may get diarrhoea.

To teach a calf to drink from a bucket it is best to let it suckle on a finger. While the calf is suckling your finger, you slowly bring your hand downwards into the bucket until the calf reaches the milk. Important points to pay attention to during the bucket milk-feeding:

- Hygiene and cleanliness of the buckets to avoid sickness of the calf. The bucket should be washed after feeding. First rinse the bucket with clean water, then wash it with hot water and a detergent. Finally rinse the bucket with clean water and let it stand upside down to dry in the sun.
- Feed the calf directly after milking the cow because otherwise the milk cools down.
- The calf should drink all the milk quickly otherwise it is an indication that the calf is not healthy.
- Do not give too much milk at once. It is better to provide a smaller amount of milk three times a day.
- Under dry and hot weather conditions it is very important to provide fresh drinking water for the calf, so that it can drink when thirsty. table 6 gives an indication of how much milk a calf needs.

From the second week onward a calf should be able to eat small amounts of good quality feed such as young grass. This is necessary for the development of the rumen. Fresh, clean water should also be available. If the milk is required for the market or for home consumption you can decide to wean early, so the calf does not need milk any more.

Table 6: Feeding programme for a crossbred calf.

Week	Milk (litres per day)	Concentrate (kg)	Roughage
2	5	handful	good grass or a mixture of different types of good quality roughage. Increase the amount over time.
3	5	handful	
4	6	0.5	
5	6	0.5	
6	6	0.5	
7	5	1	
8	5	1	
9	4	1	
10	3	1	
11	3	1	
12	2	1.5	
13-40	nil	1.5	

At almost 4 months you can wean your calf, and provide it with good quality feed and concentrates. Ideal weaning weights are 70 kg live weight for large breeds (adult weight 500 kg) and 45 kg live weight for small breeds (adult weight 350 kg), provided the calf has no setbacks. If management is poor and concentrates are expensive, milk feeding for a longer period could be a better economic alternative.

Health of the calf

As mentioned before, colostrum is very important in preventing sickness in the first three months of life. The calf should be left with its mother for 48 hours so it starts drinking as soon as possible and as therefore gets as much colostrum as possible.

In general the most important diseases are mentioned in Chapter 5 but here we indicate the most important calf diseases.

Scouring or calf-diarrhoea.

This is the most common disease among calves.

Symptoms of scours are:

- the dung is liquid and has a whitish colour.
- the calf appears dull and drinks slowly or refuses to drink at all.
- the dung has a strong smell.

Causes:

- unhygienic housing: dirty calf pen or dirty bedding.
- dirty buckets if they are used for milk feeding.
- overfeeding of the calf with milk.
- too little colostrum fed so that resistance of the calf is low.

Treatment:

If you suspect scouring, the calf should not be given milk. Boiled water should be given instead to prevent drying out (dehydration). It is good to add 1 teaspoon of salt and 1 teaspoon of baking-soda to the water. If no improvement is seen after one day, seek veterinary assistance.

Pneumonia:

Calves are most susceptible in the period just after weaning until 5-6 months of age.

Symptoms of pneumonia are:

- coughing
- high fever
- mucous from the nose and watery eyes

Causes:

- Viruses and bacteria may be involved.
- Draught increases the risk of infection by pneumonia, especially when combined with humid conditions and lack of shelter during the rainy season.

Treatment:

- Colostrum will give the calf resistance.
- A clean, draught-free pen will prevent most cases of pneumonia.

Internal parasites.

Symptoms:

- the calf's condition deteriorates.
- the calf's coat is dull, not shining.
- the dung is more liquid.

Causes:

- worms (see also Chapter 5)

Treatment:

- Regular de-worming is needed, especially at the start of the rainy season. Start de-worming the calf from 6 months onwards.
- Most animals build up a natural resistance from 2 years of age onwards.

External Parasites (ticks).

Symptoms:

- the skin is covered with ticks.
- the calf's condition deteriorates.
- anaemia occurs after a while.

Causes:

- ticks can be brought in by cats, dogs or other animals.

Treatment:

- see Chapter 5.

Read Chapter 4 and be aware of the important vaccinations required in your area. The best time to vaccinate for the first time is mentioned here:

- Foot and mouth disease: 4 months of age and repeat every 6 months.
- Blantrax (Black Quarter and Anthrax): 6 months.

- Brucellosis: heifer calves at 8 months.

Housing of the calf

After birth the calf should stay with its mother but has to be protected against rain, cold and direct sunshine. The calf can not regulate its temperature well enough, so it has to be helped by using trees or a shelter, depending on the kind of system you use. If you want milk from the cow for home consumption or for sale it is best to separate the calf during the day after it has drunk from its mother. Make sure you save enough milk for the calf.

The calf should not come into contact with the manure of the cows. This manure contains the eggs of internal parasites and a young calf is very susceptible. The best is a large area of good-quality grass where there is also shade. This shelter can be a simple roof at least three metres high, with a large overhang.

In a zero-grazing system, a shelter for calves is necessary. The floor should be removable and slatted. The calf should not come in contact with urine and dung, and the calf should stay clean and dry. This will reduce the risks of pneumonia, diarrhoea and worm-infestation.

Be aware that shelters are a congregation area for cows and become wet, muddy and contaminated. They become a source of diseases unless they are dried and cleaned properly a few times a week.

7.3 Heifers

Heifers are very important for replacing old cows in the herd. Normally heifers can calve at an age of 2½ - 3½ years if they have received good and sufficient feed after weaning. If nutrition is inadequate the heifers will not calve until 4½ years old or even older. This late age of puberty is partly due to the lack of good feeding during the growth period and partly due to the type of breed.

Always remember: the calf now will be my cow within a few years.

8 Records, farm administration and economic analysis

In this chapter we describe how to record all the farm events and how to use these records for a good cost-benefit analysis.

8.1 Records

Farmers will remember significant events on their farm to the date, but often find it difficult to remember exactly when events relating to their individual animals occurred, especially if they have many. However, precise recording is necessary if you want to improve your economic returns.

Example:

Six weeks after giving birth Betty (a cow) has an impressive daily milk production of 18 litres and a total milk production per lactation of 3240 litres. However, she doesn't seem to become pregnant quickly: her calving interval is close to 3 years.

Blue (another cow) does not stand out with her peak production of 12 litres a day and a total milk production of 2880 litres. But she gives birth to a calf every 2 years.

Intuitively, you may think of Betty as your finest milking cow. Your intuition was wrong and administration could help you to see why. If you keep a record of both cows' milk production and calving dates, you can calculate the average daily milk production of both animals. You may be surprised to see that Blue is bringing you more benefit (see table 7).

Table 7: Total production per lactation.

	total production per lactation (litre)	calving interval (months)	average daily production (litre)
Betty	3240	36	3
Blue	2880	24	4

High milk production is nice, but a low calving interval counts too ! Betty produces the 3240 litres in 3 years, but if she had a lower calving interval her average daily milk production would increase greatly.

The kinds of records worth keeping depend on the production goal. But on all farms it is useful to have:

1 Farm diary.

In a normal diary write down the daily information concerning your farm as a whole. In such a way you will be keeping daily record of the expenses you make in time and money.

Also, writing down major events (such as the arrival of concentrate from the factory) sometimes helps tracing problems to their origin.

Example:

September 1990 (US\$ 1 = US\$ 100 cents).

15th: Besides general caretaking, I spent 4 hours collecting maize stalks for storage for the dry season, and Mary (my wife) spent an hour processing milk into ghee. Total: about 8 hours of labour.

16th: Bought 50 kgs concentrates from Oum Ali at a price of US\$ 30 cents per kg. Sold 20 litres of ghee to truck driver at US\$1 a litre. I treated the young stock against roundworms with levamisole (7 x US\$ 60 cents).

2 Farm costs-benefit calendar.

It is easiest to keep track of the above costs and benefits in a farm costs-benefits calendar (see figure 12).

COSTS - BENEFITS				
	COSTS		BENEFITS	
month	items	value	items	value
1				
2				
TOTAL	XXXXX		XXXXX	

Figure 12: Farm costs-benefits calendar.

3 Individual cow records.

For individual cow records it is important to be able to identify your animals easily. You can do this in a number of ways: by a sketch, drawing or marks (difficult when the animals are only one colour), branding, ear tagging, etc.

INDIVIDUAL COW-CARD
health records for bulls and young animals

Name animal: _____ Name sire: _____
Date of birth: _____ Name dam: _____

HEALTH			
date	vaccination	date	treatment
Remarks:			

Figure 13: Individual cow-card for bulls and young animals.

Dairy cattle.

- Bulls and young animals: They all have their own health record (see figure 13).
- Cows: Fertility and milk production records (see figure 10, 14 & 15): If you bucket-feed your calves, you will be able to record each cow's total milk production. If you do so twice a month for each cow you milk, you will be able calculate the total milk production of each cow from calving until drying off. Knowing the number of days you milked her, the total milk production can be calculated (= daily milk production x number of days of milking).
More relevant economically is to know the average daily milk production per calving interval (= total milk production / calving interval (days)).

The best cow is the cow with the highest average daily milk production per calving interval.

MILK PRODUCTION RECORDS
measured twice in a month

Farmer:

Month:

Year:

cow's name	date calving	MILK YIELD						Monthly total (14 * daily total 1 + 14 * daily total 2)
		first week of the month			second week of the month			
		AM	PM	daily total 1	AM	PM	daily total 2	

Figure 14: Milk production records.

8.2 Cost-Benefit Analysis

Chapter 1 discusses possible reasons for keeping cattle. Is your main interest to save or to produce?

If it is the latter, what do you want to produce?

Is there a market for your products?

In Chapter 2 you are asked to consider which production factors (inputs) you have access to.

The question is now: "Do these inputs allow you to produce what you had in mind with the expected benefits?"

To help you answer this question, Chapters 3 to 7 have given you basic information on the characteristics and needs of cattle:

Chapters 3 discuss the feed and water requirements of cattle according to production objective. They should give you a fair idea of the number of head of cattle you can feed and water, and the time and/or

money needed to do so. Preventive cattle health measures are described in Chapters 4 and 5. If the right prevention packages for local circumstances and production aims are given to cattle, costs of curative treatments should be low. Aspects of cattle fertility and the economic importance of the calving interval are discussed in Chapter 6. Chapter 7 talks about aspects of calf rearing.

INDIVIDUAL COW-CARD
 monthly milk production records for each lactation

Name cow: _____ Name sire: _____
 Date of birth: _____ Name dam: _____

MILK PRODUCTION							
MONTH	LACTATION						
	1	2	3	4	5	6	7
1							
2							
3							
4							
5							
6							
7							
8							
9							
10							
11							
12							
13							
14							
TOTAL							

Figure 15: Individual cow-card for dairy cows.

Now that you have this basic information, it is time to make some calculations to be able to answer the crucial question above.

If you do not have cattle yet, the analysis will be an estimate based on general information coming from research, such as breed characteristics, average fodder production per hectare, average local market prices, and so on.

If you already have a farm, use the information which it provides. To gather the information you should record things about your animals (see above). Such farm administration will help you to identify what is costing you more than expected, and what can be improved to increase benefits. A cost-benefit analysis is usually made each year.

8.3 Remarks concerning the economic analysis:

Costs

For each item, estimate or calculate (see "Farm Diary" and "Farm Cost-Benefit calendar") the amount of time and money put into it.

The time should be converted into money in economic calculations and is equivalent to what it would have cost you to hire a labourer to do the work for you (which could be necessary if you fall ill or have to attend other business). To do so, take the monthly salary of a labourer and divide it by 160 (officially there are 40 working hours a week and so there are 160 in a month). By doing this you obtain the price of an hour's work.

Example:

Your zero-grazing 75% exotic blood crossbred has an average daily milk production of 16 litres. For feed you go and collect 50 kg of grass along the roadside, which takes you 2 hours a day. It is usually of good quality and ensures about half the average milk production. Supplements provide for the other half (see table 8).

Another thing that should be converted into money is the amount of product that is consumed at home (which would otherwise have to be bought).

Table 8: The conversion of time into money.

Item:	Quantity:	Price:	Yearly costs:
Concentrate	3 kg/day	30 cents/kg	$3 \times 30 \times 365 = 32,950$ cents or nearly US\$330
Roughage	2 hours/day	40 cents/hour	$2 \times 40 \times 365 = 29,200$ cents or US\$292

True herd size

In your cost-benefit analysis, remember that the real herd size is bigger than the number of productive animals you want to keep.

As time goes on, you will have to replace animals in your herd that have become unproductive, ill and so on. You have two options: either you sell them, add money of your own to the price received (the latter is usually not much) and buy a new mature cow; or you use your own offspring. The last option is usually preferred because the qualities of their parents are known and they do not bring in diseases as outside animals may do.

However, there will always be a certain number of animals that are unproductive in a herd. Unfortunately, these are sometimes forgotten in calculating the amount of feed and housing space needed for the herd.

To calculate the number of animals in the herd, we base our calculations on farm and/or research observations of the breed. We take into account the calving interval and the respective ages of male and female sexual maturity (see Chapter 7), as well as the sex ratio at birth, and the calf mortality before weaning (see Chapter 8).

Example:

Your objective is to produce milk from ten cows. Your initial purchase costs will be only that of ten mature cows and a bull (plus costs of transport and time). On average you estimate that you will have to replace the cows between nine and ten years of age and the bull at seven. You wish to do this with your own herd's offspring. The remainder is sold at weaning age.

For our example we suppose that:

- The calving interval is 15 months. This means that the number of calvings a year is:

(12 months x 10 cows)/15 months = 8 cows calve each year.

- The calf sex ratio at birth is 1 : 1 (which means there is as much chance that a female calf is born as there is that a male is born). In this case it means four male and four female calves are born a year.
- Calf mortality before weaning is 12%. This means that before weaning one of the eight calves has died, which leaves three male and four female calves or four male and three female calves.
- The age of sexual maturity of the bull is about three years. To replace the elderly bull, one bull calf should be kept every four years ($7-3 = 4$). You cannot be sure of his quality as a sire, and therefore it is best to also keep a second choice. Overall this means you will keep one calf every two years as a potential future bull.
- The breeding age is around 2 years, so that the first calving age is about 3 years.
This means (1) the heifers will not produce milk before they are three years old, and (2) that if you have ten cows between 3 and $9\frac{1}{2}$ years of age, you will be replacing nearly one and a half a year (10 cows divided by $6\frac{1}{2}$ years). As you are not sure of the quality of your heifers as milkers, you may wish to keep two female calves a year, so that you can do away with bad milkers.

The real size of your herd will be more or less:

- 10 productive milk cows
- 1 mature bull
- 1 immature bull
- 4 heifers (cows that have not yet calved for the first time)
- about 7 calves not yet weaned, of which you will keep one male and two female; the other will be sold after weaning.

CONCLUSION:

You will have 16 ruminating head to feed and a total of 23 head of cattle to take care of instead of 11!

Investment costs versus running costs, depreciation and maintenance.

- When you start a farm, you use a large sum of money to buy cattle and maybe land, to construct a stable, etc. We say you are investing

money into the farm. The cattle, the land and the stable are your capital. Cattle is live capital.

However, having cattle is not enough. For them to produce, you need to feed them every day, to treat them regularly, and so on. In other words, you will have continuous expenses to keep the farm functioning. These are the so-called running costs.

- In principle, investment costs are "one time" costs (as opposed to the continuous running costs). Nevertheless, capital gradually loses value. This is called the depreciation of capital. There will be a time that things should be replaced. For replacement, money could be set aside each month. Theoretically, in such a way you will have a sum to replace an investment when its value has become zero. In practice, in developing countries there is little use in doing this if inflation is high. In the case of live capital, things are different as we have shown in the section headed "True herd size". Offspring can be kept to replace the elderly cows that have become less productive. Keeping these young ones costs you money while they are growing up, but it avoids suddenly needing a large sum of money after six years or so to buy new cows. In other words, you are spreading the costs over the years.
- The speed with which capital must be replaced can be reduced by maintaining it properly. It is useful to foresee maintenance costs and include them in the cost-benefit analysis.

Home consumption

Sometimes home consumption is forgotten but it can be calculated as a benefit.

8.4 Conclusion

As you have seen, administration can be made as difficult and complicated as you want. You can also make a cost-benefit analysis of your administration. Cost is the time spent doing the administration, and the benefit will be better production next year. What do you want to achieve? If you only have one cow, it is not wise to spend a lot of time on administration. If you have several milking cows it can be profit-

able to know exactly which cow is best, and therefore needed for offspring.

Example:

You are a housewife. Your husband works as a truck driver for a businessman. He's away from home most of the time. Your home is in a village five kilometres from town. You have 2 hectares of land which you use to produce food for your family; mainly maize, cassava and peanuts. Rainfall in your area is 700 mm, the vegetation is savanna-like. You have three children. The two eldest go to school in town. Some people in the village have a few head of cattle which are herded by the village herdsman.

You should be able to estimate the number of calvings to expect each year, the length of lactation, daily milk production, etc. Try calculating economic returns using the average calving interval, lactation length and daily milk production for human consumption. If you do not have data from your own farm you can find the information in research documents on the breed of cattle you want to keep.

Appendix 1: Points to look for when buying an animal

Age

It is possible to guess the age of a cow by looking at its teeth. The milk incisors (cutting-teeth) are replaced by permanent incisors at fairly regular intervals, so you can estimate the age of a cow quite accurately until it is approximately 4 years old. By this age it will have all its adult teeth. We stress that this gives only a rough indication, however, as different breeds change their teeth at different ages.

As a guideline we include information on dental development for a Dutch milking cow (see figure 16):

- the calf is born with 6 - 8 cutting-teeth (incisors) these are milk teeth
- 1 year and 3 months: the cutting-teeth are hollow
- 1 year and 9 months: the inner two teeth are replaced by two large teeth (I1)
- 2 years and 6 months: the inner middle teeth are replaced (I2): now four large teeth
- 3 years: the next set of cutting teeth are replaced (I3)
- 3 years and 9 months: the eye-teeth or canine-teeth (I4 or C) are replaced, all the milk teeth have now been replaced.

The cow now has four pairs of permanent incisors in the lower jaw. After this age we can only look at the wear of the chewing surface on the permanent incisors now. The ridges on top of the teeth which form a zig-zag line gradually become worn down until the surface is smooth.

- 5 years, the cutting-teeth are beginning to show some wear, beginning on the tongue side.
- 6 years the middle 2 incisors (I1) have become flat
- 7 years the middle 4 incisors (I1 and I2) are flat
- 8 years the middle 6 incisors (I1, I2, I3) are flat
- 9 years all 8 incisors (I1, I2, I3 and I4) are worn flat

Do not buy a cow that is older than 4-5 years for reproduction if you are not sure about her fertility.

Appearance.

Do not buy an animal with a disease. See for the checklist for general examination in Chapters 4 and 5.

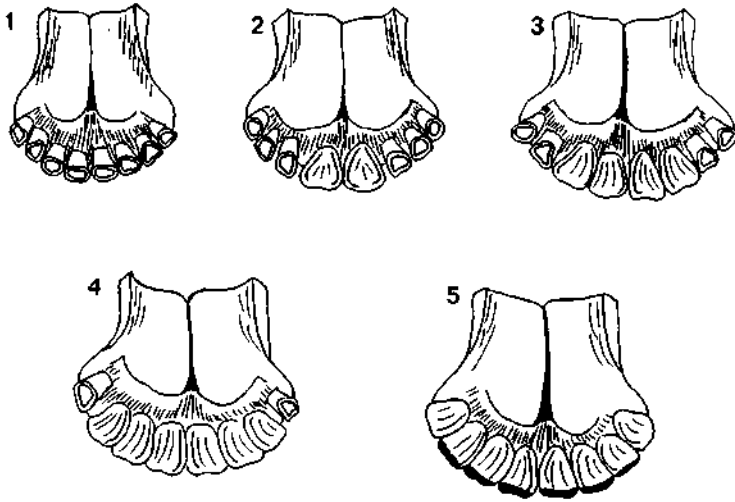

Figure 16: Teeth of cows at different ages (Source: Kroon, 1922)..

Appendix 2: How to handle cattle

Animals react clearly to your movements and feelings. Regularity and consistency are very important for the animals. Consistency means that repeated actions are always done in the same way. The animal will recognize these actions and in time it will become less frightened.

Approach the animals quietly and calmly, do not make sudden movements and do not shout. If you use a calm and quiet voice the animals will become more quiet. The animal also learns to recognize your voice as you approach.

Touch the animal often so it will not be scared if you touch it by accident, or need to touch it. Try to get the animals used to people as soon as possible. Do not change the people who tend the animals too often.

After a long period (of some weeks) inside the stable or when animals are not used to going outside all animals will want to get out as quickly as possible. The animals will behave restlessly. Be aware of this and maybe ask for some extra help. The animals will calm down after about 15 minutes.

Animals can be frightened suddenly by: snakes, a strange person, biting insects, other animals, buckets or other strange things. Calm the animal down as soon as possible because it can hurt itself.

If you want to take the cow with you or put it somewhere alone, use a firm rope and good knots.

Before milking you should put a rope around the cow's neck. Tie the hind legs to each other so the cow cannot kick (hobbling). It also prevents the cow from walking away. During milking it helps to give the cow something to eat.

Appendix 3: Urea treatment of straw

For 100 kg of dry straw you need 4 kg of urea. Dissolve the urea in water. Do not use more water than the amount of straw: in this case 100 litres. Put some straw in a pit or container and spray some of the urea solution onto the straw. Repeat this after adding some more straw, until you have sprayed all the straw.

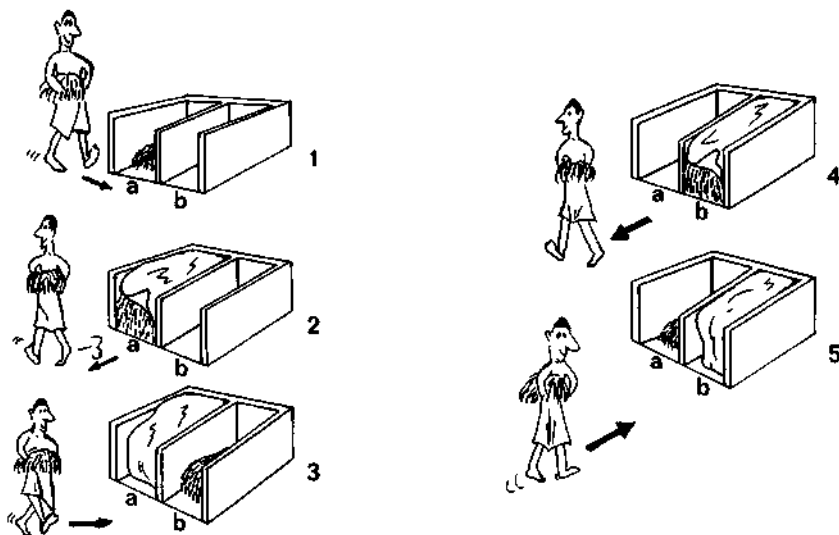

Figure 17: Straw treatment according to the two pit x seven day system (Source: Schiere and Ibrahim, 1985).

Making a molasses-urea lick-block (measures in kilogramme)

Ingredients for 30 kg:

Molasses	15.0
Urea	3.0
Salt	1.5
Cement/quick lime	3.0
Bran	<u>7.5</u>
Total	30.0

First make a pre-mixture of salt, cement and a little bit of water and add the other ingredients in the order indicated above.

Mix it well using a concrete mixer, or by hand.

After mixing properly you can put the mixture in moulds made from plastic sheets. This will make manageable portions. Let them harden for a few days. After drying, remove the blocks from the moulds and give them to the animals.

You can also add extra minerals to these blocks to improve the mineral balance.

Appendix 4: How to milk a cow

We will describe hand milking only here, as this is the most common way of milking, unless you have more than 15 cows. Good hand milking is a skill which can be learned. Good hygiene is of the utmost importance because the level of hygiene influences the quality of the milk (see also Agrodok 36: Small-scale preparation of dairy products).

There are a number of general rules which should always be followed. Adhering to these rules will decrease the risk of an udder infection (mastitis) and improve the hygiene and quality of the milk:

- Milk regularly, and always at the same times.
- Milk in the correct way.
- Clean your hands carefully before milking and keep your nails short.
- Be quiet and gentle with the cows.

The udder

The udder consists of four separate quarters, two front and two rear, each ending in a teat. The milk is produced and stored in the udder until the cow receives a signal to 'let down' the milk. Usually this occurs by the calf stimulating the udder by kicking or suckling. Tropical breeds of cow often will not let the milk down unless the calf is near the cow.

Milking equipment

You must sterilise equipment just before you use it, in order to kill any disease-causing micro-organisms left over after cleaning. You can use a chloride solution such as bleach, sodium hypochlorite. This can be bought locally, either in liquid form, or as a powder which can be dissolved in water.

Cleaning and disinfecting the milking equipment should be carried out as follows:

- Rinse with water.

- Scrub for one minute using a hot soda solution (1.5 tablespoons washing soda in 5 litres of water: dissolve in a little hot water, and then add cold water to the correct amount).
- Rinse with hot water.
- Buckets and other containers should be turned upside down on a rack to keep them free from dust; in this way they can drain and no dirt can fall in.
- Sterilise the equipment with a chloride (bleach) solution just before you are going to use it (2 tablespoons bleach in 4.5 litres of water).
- Rinse several times with clean hot water to remove any remaining disinfectant. No disinfectant must be allowed to contaminate the milk.

Note: If the equipment is not cleaned first the bleach can not do its work. Therefore there is little point in omitting the cleaning and only sterilising.

Hygiene

Before milking the cow should be restrained by tying the hind legs together, so that the cow cannot tip the bucket over or kick the person milking her. Then the udder should be prepared. Clean the udder, otherwise dirt can fall off into the bucket during milking. For the same reason the right flank of the cow (the side to sit for milking) should be cleaned.

Washing with water gives the cleanest udder, teat and flank. The water should be between 20°C and 40°C. Remove long hairs from the flank and udder regularly. The wet udder should be dried with a paper towel. This should be used only once, to prevent the spread of bacteria and other pathogens to other cows. If paper towels are not available you can use a sterilised cloth which should be replaced regularly. To make sure no bacteria and other pathogens are spread, disinfectant can be added to the cleaning water, which can then be used to clean several udders.

Again, it is important that each udder should be dried carefully, using a clean towel or cloth.

Milking

Before the real milking can start each quarter should be inspected for mastitis by checking the foremilk. This is sometimes done before cleaning the udder. The first milk should be spread on a dark surface, a foremilk cup or a dark tile. Abnormal milk shows discoloration, flakes, shreds, clots and/or wateriness. These are warning signs, which mean the milk should be kept aside because of the risk to humans.

To milk the cow it is best to place a small seat (milking stool) on the right side of the cow, and the bucket between your legs. You should sit upright and under the cow as much as possible.

Place your open dry hand next to a front teat, and close your thumb and forefinger around it. This prevents the milk from flowing back into the udder. Then place your other fingers along the teat next to your forefinger, one by one. This presses the milk out (see Figure 12).

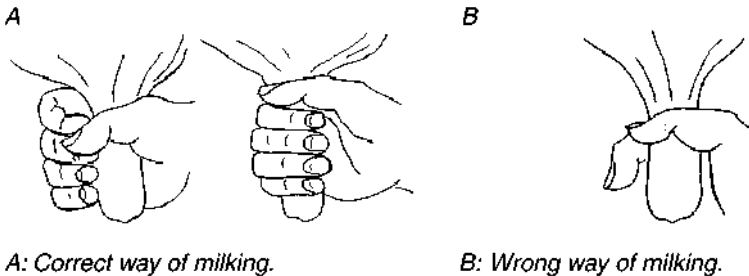

Figure 18: The grip to use for milking a cow..

After the milk has been pressed out open your hand so new milk can flow from the udder into the teat. Repeat the procedure with your other hand on the other front teat. Always use your whole hand. If this is not possible slide the teats between thumb and forefinger. This grip is considered bad for udder health and flow rate.

Always start by milking the two front teats until they are almost 'empty' (there is always some milk in the udder). Then milk the rear teats. It is not advisable to milk one front and one rear teat together as they do not contain the same amount of milk. The most efficient way

to milk a cow is with a regular rhythmic squeezing of both teats, using the whole hand. When the rear teats are almost empty you can empty the front teats, and then return to the rear teats to empty them.

The milking equipment should be thoroughly cleaned after milking, if necessary using cleaning agents and disinfectant.

Mastitis

Signs in the milk which indicate mastitis are small flakes, discoloration and/or wateriness. The quarter of the udder which is infected is painful and hard, and sometimes swollen.

Adopt the following measures:

- Milk the affected quarter more often (as often as possible).
- Keep the milk separate from the milk from other cows.
- Consult a veterinary officer if the milk yield is very low.
- Prevent infection of other cows through good hygiene.
- Clean your hands after milking the infected quarter.
- Milk the infected cow last.
- If possible disinfect the teats of all cows.
- Check the other cow very carefully.

(Source: Dairy Training Centre Friesland)

Further reading

Crotty, R. 1980. **Cattle, economics and development**. UK: Commonwealth Agricultural Bureaux.

French, M.H.. 1970. **Observations on the goat**. Rome: FAO, Agr. Studies No 80.

Hall, H.T.B. 1977. **Diseases and parasites of livestock in the tropics**. London: Longman group Ltd., Intermediate Tropical Agriculture Series.

Hand and machine milking. 1994. Notes for students at the Dairy Training Centre Friesland, Oenkerk. 32 pp.

Hill, D.H. 1977. **Cattle and buffalo meat production in the tropics**. London: Longman group Ltd., Intermediate Tropical Agriculture Series.

Kroon, H.M. 1922. **De koe**. Deventer: Kluwer. 6th revised edition.

Ministry of Livestock Development. **Housing. Zero grazing series**, vol. 1. Republic of Kenya.

Ministry of Livestock Development. **The management of Napier grass**. Zero grazing series, vol. 2. Republic of Kenya.

Ministry of Livestock Development. **Zero grazing, Calf rearing. Dairy Development project**. Republic of Kenya.

Ministry of Livestock Development. Zero grazing, **The fertility of the dairy cow**. Dairy Development project. Republic of Kenya.

Schiere, J.B. and M.N.M. Ibrahim. 1985. **Recent research in extension on rice straw feeding in Sri Lanka**. A review. In: The utilization of fibrous agricultural residues as animal feeds. Proceedings of the fourth annual workshop of the AAFARR network in Khon Kaen, Thailand. Canberra: IDP.

Useful addresses



PTC+ is an international training institute, which focuses on all the links in the production chain on plant and animal commodities, (agricultural) technology, (food) technology and natural areas.

Training programmes are practice-oriented and mix theory with practical classes. PTC+ offers “open entry” programmes, “tailor-made” programmes and consultancy. Programmes are offered in the Netherlands and/or at location.

It is the policy of PTC+ to search for partnerships and co-operation programmes with national and international institutions abroad.

For more information: visit our web-site www.ptcplus.com and/or write to:

PTC+ Head Office

P.O. Box 160, 6710 BD Ede, The Netherlands

Tel.: +31 318 645700

Fax: +31 318 595869

e-mail: info@ptcplus.com

Glossary

Antibodies	substances found in the blood that react chemically to destroy invading parasites and organisms.
Artificial insemination	the removal of semen from a male animal and placing it into a female's reproductive organs.
Bacteria	one-celled organisms from the Plant Kingdom; some are capable of causing disease.
Colostrum	the first milky substance to be provided by the mother for new-born offspring, rich in antibodies and vitamins.
Conception	state of becoming pregnant.
Cross breeding	mating different breeds of the same animal together.
Dam	mother
Dry cow	cow not producing milk.
Fodder	conserved feedstuff e.g. hay, silage etc.
Fodder bank	small piece of land where fodder is grown.
Heat	periodic coming into season of a female animal (on heat stage of the cycle when ready for mating).
Heifer	young cow which has not yet given birth to a calf.

In-breeding	the crossing of closely related animals.
Intake	the amount of food eaten by an animal.
Lactation	the period of milking from when the cow gives birth to when she dries up.
Oestrus	coming into season or heat in a female.
Ovulation	the process by which an ovum is released in the female's body.
Ovum	female germ cell which after fertilisation develops into a new member of the same species.
Roughage	fodder containing a high quantity of cellulose or other indigestible material stimulating gut action.
Rumen	the first and largest stomach of a ruminant animal.
Rumination	chewing of the cud or the return of food previously swallowed to the mouth for chewing.
Scouring	diarrhoea
Semen	the fluid produced by a male animal containing the male reproduction cells.
Sire	father
Udder	milk-producing bag on an animal.

Uterus	the structure in the female body which holds and nourishes the developing young.
Virus	a tiny disease-producing particle of protein which is only capable of reproducing inside a host cell.
Vulva	external opening of a female genital and urinary passages.
Weaning	changing the young's feed from milk to solid feedstuff.