

# **Agrodok 35**

## **Donkeys for traction and tillage**

Luurt Oudman

© Agromisa Foundation, Wageningen, 2004.

*All rights reserved. No part of this book may be reproduced in any form, by print, photocopy, microfilm or any other means, without written permission from the publisher.*

First edition: 2002

Second edition: 2004

Author: Luurt Oudman

Editor: Jan H. Loedeman

Illustrator: Barbara Oranje

Design: Ien Ko

Translation: Catherina de Kat-Reynen

Printed by: Digigrafi, Wageningen, The Netherlands

ISBN: 90-77073-95-7

NUGI: 835

# Foreword

Both CTA the Technical Centre for Agricultural and Rural Co-operation and the Agromisa Foundation felt a need to add a booklet on animal draft power to Agromisa's Agrodok series. Marg Leydens, who then was the Agrodok publication co-ordinator, came across Draft Animal Technology, a manual for a Bachelor of Science Course in Agricultural Engineering, which I had completed in 1997. This manual is a reflection of part of my work as Farm Power and Machinery lecturer at the University of Nairobi, Kenya. Marg invited me to write an Agrodok booklet on animal draft power. We soon realised that 'animal draft power' implied a scope that was too wide for the Agrodok series. Though we decided to limit the subject to donkeys, all facets of donkey labour should be addressed, including animal care in the broadest sense, training, harnessing, back-packing techniques as well as the description of suitable implements for transport and crop cultivation.

An agricultural engineer myself, I am familiar with the engineering aspects of donkey power. For an adequate coverage of other aspects, however, I had to lean heavily on other publications. My main sources have been 'Draught Animal Power Manual', published by the FAO in 1994, and 'Donkeys for Development' by Peta Jones. I am most grateful to both the FAO and Dr. Jones for allowing me to use their illustrations and certain descriptions. After I had completed the manuscript Janhein Loedeman did an excellent editing job and

Catharina de Kat-Reynen upgraded my English to a UK standard. I also like to express my heartfelt thanks to Barbara Oranje, who took care of the reproduction and improvement of the numerous illustrations and to Ien Ko who completed the layout.

Luurt Oudman  
October 2001.

# Contents

<b>1</b>	<b>Introduction</b>	<b>6</b>
<b>2</b>	<b>Characteristics and use</b>	<b>8</b>
2.1	Horses, mules and donkeys	8
2.2	General donkey features	9
2.3	Selection characteristics	10
2.4	Using draft donkeys	12
<b>3</b>	<b>Care</b>	<b>14</b>
3.1	Body condition	14
3.2	Feeding	15
3.3	Health and disease	19
3.4	Daily care of working donkeys	20
<b>4</b>	<b>Usage as pack animal</b>	<b>24</b>
4.1	Loads and comfort	24
4.2	Packing rules	24
4.3	Simple packs	25
4.4	Jerry cans	26
4.5	Pack-frames and soft baskets	27
<b>5</b>	<b>Training programme</b>	<b>30</b>
5.1	The rationale of a training programme	30
5.2	Step 1: roping and walking	32
5.3	Step 2: harnessing and walking	32
5.4	Step 3: pulling loads	34
5.5	Step 4: working as a team	35
<b>6</b>	<b>Harnessing</b>	<b>37</b>
6.1	Purpose of a donkey harness	37
6.2	Harnesses in general	38
6.3	Various pulling harnesses	39

<b>7</b>	<b>Hitching</b>	<b>46</b>
7.1	Hitching a single donkey to a cart	46
7.2	Hitching two donkeys to a cart	48
7.3	Other hitching arrangements for teams of two or more donkeys	49
7.4	Reining systems	50
<b>8</b>	<b>Equipment for transport</b>	<b>52</b>
8.1	Sledges	52
8.2	Carts	52
8.3	Wagons	56
<b>9</b>	<b>Equipment for primary tillage</b>	<b>57</b>
9.1	Mouldboard plough	57
9.2	Ard	62
9.3	Scarifier	64
9.4	Ripper	65
9.5	Ridger	66
<b>10</b>	<b>Equipment for crop husbandry</b>	<b>68</b>
10.1	Secondary tillage	68
10.2	Equipment for sowing	70
10.3	Equipment for inter-row weeding	74
<b>11</b>	<b>Maintenance of farming equipment</b>	<b>76</b>
11.1	Daily maintenance and inspections	76
11.2	Maintenance at the end of the season	76
	<b>Further reading</b>	<b>78</b>
	<b>Useful addresses</b>	<b>80</b>
	<b>Glossary</b>	<b>82</b>

# 1 Introduction

Although the donkey is indigenous to the Northeast part of Africa, its use on the continent as a whole is limited. The donkey is probably most appreciated in its true home, in arid and mountainous areas, where it is used most extensively. It is widely acknowledged that these animals can play a major role in rural development.

The steady speed of a donkey's walk is what makes it so popular as a pack animal or for pulling small carts. When properly harnessed and hitched, it is also fairly fast at ploughing. The intelligence of a donkey is often underestimated. A donkey is easy to manage once the animal knows what to do and recognises the appropriate verbal commands. When a donkey refuses to work, it is almost always because the work is impossible for the animal, not because it is "stubborn".

Donkeys are an undervalued power source in a large part of the world. Their potential to work is very high and their contribution to any household or even national economy is considerable. Generally the buying and selling price of donkeys is far below their true value, which should be calculated on the basis of the work they give over the 14 years they are able to work, if well cared for. If a donkey works six hours a day, four days a week over that many years, it will have given about 15,000 hours of work. The low price of donkeys, therefore, is a reflection of distorted perceptions of their role. This situation is changing. In Zambia, for instance, donkeys are now selling for the same price as cattle.

This Agrodok offers insight into the possibilities of donkey use, based on experiences with working donkeys around the globe. It is aimed at farmers, agricultural technicians and extension officers, for rural artisans and for people engaged in rural- and town transport with donkeys. The information provided is meant to assist them in tapping the work potential of the donkey in a manner that is humane for the animal.

The booklet starts in Chapter 2 with ‘Characteristics & Use’. Before a farmer starts working with donkeys he should know what characteristics are important in selecting a good working animal. ‘Care’ is the subject of the next chapter because proper treatment of a donkey is required to make optimal use of its potentials. The most basic use of donkeys is as ‘pack animals’, see Chapter 4. For pulling carts or implements, donkeys need to be trained in a step-wise approach, see Chapter 5. After training, proper harnessing is required to link the animal to the implement effectively, see Chapter 6. Useful implements for transport, primary tillage and crop husbandry are presented and discussed in Chapters 7 through 11.

The illustrations used in this Agrodok originate from other textbooks. We are grateful to the authors of the books for allowing us to use their illustrations. These books are highly recommended for further reading.

## **2 Characteristics and use**

Horses, donkeys and mules belong to the equine group. They are found mainly in temperate, semi-arid or highland areas. Equines move more quickly than cattle and buffaloes. They walk at 4-6 km/h, the speed of a normal human, and readily trot faster than this, making them particularly well suited for transport. They can maintain a good pace over long distances and are capable of rapid surges of power (very useful for getting stopped carts moving). They tend to be single-purpose work animals, and humans seldom consume their meat and milk.

### **2.1 Horses, mules and donkeys**

Health problems and the need for very good management restrict the range and use of horses in the tropics. Horses tend to be high-status, expensive, specialised work animals. In North Africa, Senegal and some highland regions in Africa, horses maintained mainly for transport may be used briefly for crop cultivation. However, for most smallholders in tropical Africa, horses are unlikely to be used as work animals.

Mules are specialised work animals produced by crossing a female horse with a male donkey. They are therefore only found where both horses and donkeys breed well, notably in temperate, semi-arid highland areas. They make excellent, single-purpose work animals, being more hardy than horses and stronger than donkeys. The great disadvantage of mules is that they are not fertile; so female horses have to be kept around to produce baby mules. This makes mules rather expensive.

Donkeys are small work animals, well adapted to semi-arid areas. They do not seem to thrive in humid or semi-humid conditions, but they are reputed to survive better than Zebu cattle in tsetse-infested areas. They have great ability to live entirely on poor free range graz-



ing, and in serious drought conditions they tend to outlive cattle. The animal is mainly used for carrying pack loads, pulling light carts or for riding.

## 2.2 General donkey features

Donkeys are often very inexpensive and have little, or no, disposal value. Although they have sometimes been considered as animals of ridicule or low status, they have excellent reputations as easily trainable and very dependable work animals. Children can easily manage donkeys.

*Table 1: Main advantages and disadvantages of using donkeys (Jones, 1997)*

Advantages	Disadvantages
Friendly towards humans	Suffer from being alone
Willing to work	Noisy when frustrated or lonely
Can turn in a small space	Friends not easily separated
Easy to train	Uncastrated males aggressive towards other donkeys
Need little supervision in work	Skin easily wounded
Can utilize poor feed well	Wander long distances if not supervised
Not affected much by external parasites	Do not move out of the way of traffic
Need little water	Need shelter from cold and damp
Can survive well in tsetse-infested areas	Meat not generally eaten
Can survive droughts better than cattle	Comparatively small in size
Comparatively cheap to buy	Mature slowly
Strong relative to size	Breed slowly
Live and work many years in good care	Manure more fibrous than nutrient-rich
Useful for calming and guarding other kinds of animals	
Fast walking speed	

Both males (intact males are called jacks and castrated males are geldings) and females (jennies) can be used for work. Donkeys reach maturity around four years of age, with maximum weights being reached

at about six years of age. In Africa, donkeys generally weigh about 120-180 kg. Naturally, good management affects the speed of growth and final body characteristics. With good care, donkeys can have a working life of 12-15 years, and they can live even longer.

Castration will help to improve the temperament and reliability of males. However, good jacks are important for breeding, and farmers may be able to obtain fees for allowing their jacks to breed.

### 2.3 Selection characteristics

Before describing the characteristics of a working donkey, some basic knowledge is needed of English names of parts of the animal, as shown in the figure below.

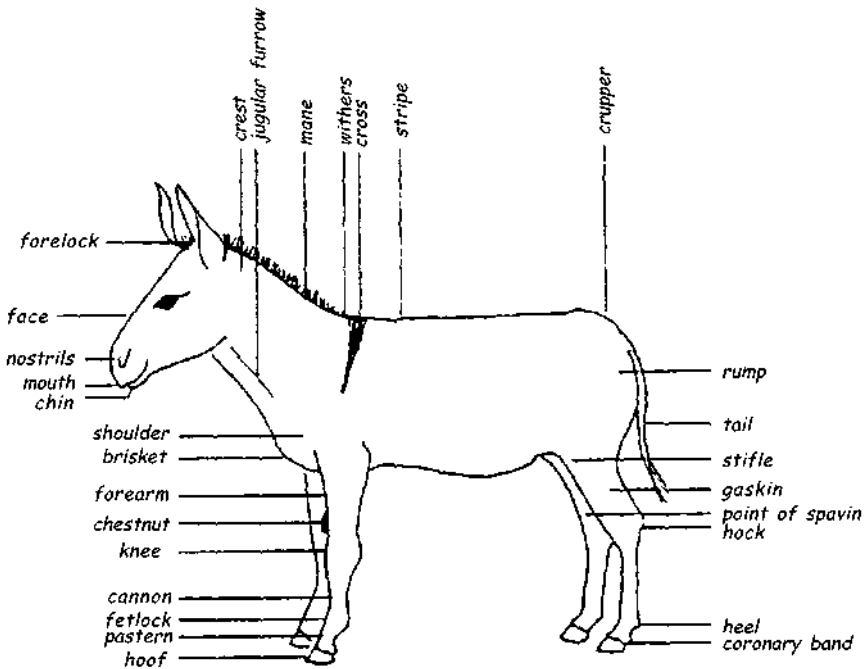
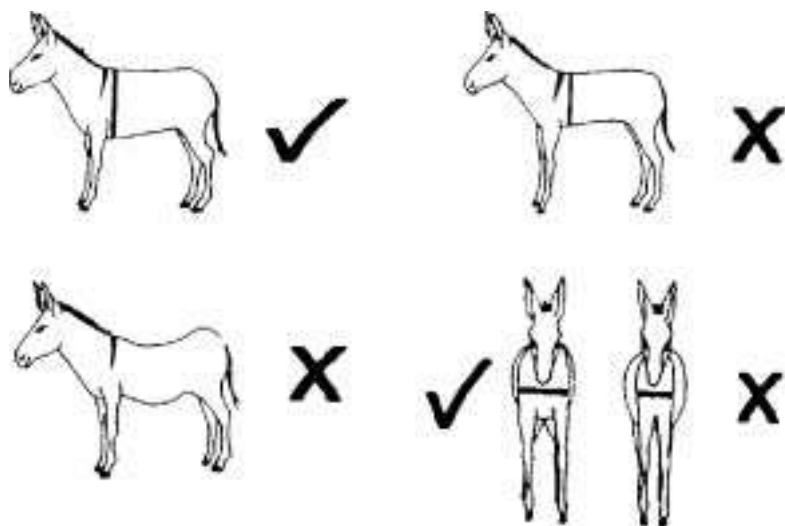


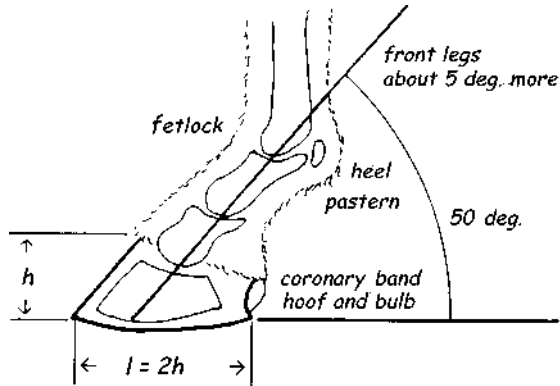
Figure 1: Names of the parts of a donkey.

When selecting an animal for work certain physical characteristics should be observed. These include: a large frame with wide shoulders and a deep chest, a straight back and well-muscled straight legs which have a 90° angle to the ground (figure 2). In young animals large knees are an indication of future thickness, but even in a large-kneed foal, the knees should not touch. The donkey should have good eyesight and agility (liveliness) and an attractive hair coat, without skin diseases or an abundance of ticks. It is important to observe an animal while it is working, to detect whether it has a physical disability, such as coughing, poor breathing, lameness, sores or wounds.



*Figure 2: Desirable and undesirable conformation features in donkeys.*

The sole of a donkey's hoof should be concave underneath; only the front part and the edges touch the ground. The shape of the hoof should be as round as possible. The angle between the pastern and the ground should be about 50-60 degrees, being slightly steeper in the front legs. The hoof angle and the pastern angle should be similar. Animals with feet abnormalities should not be selected (figure 3).



*Figure 3: Hoof and bones showing correct angles and dimensions.*

In addition to sound physical characteristics, an animal should have a suitable temperament. It should be responsive, but not excitable or aggressive. However, the extent to which an animal develops into a good working animal will also depend on its relationship with its handler. No animal will perform well if its handler is cruel or inconsistent.

## **2.4 Using draft donkeys**

### **Carrying loads**

The donkey is a good animal for packing as it is sure-footed and can easily negotiate narrow paths over steep and rocky terrain. An individual donkey should not carry more than one third of its body weight, i.e. 40 - 60 kg, depending on its size. Some variation can be allowed, for instance heavier loads can be carried for shorter times along shorter distances.

Donkeys are often too small to carry large human beings and are more frequently ridden by children. Most donkeys do not move very fast unless trained to do so, and they refuse to be hurried. Where there are hardly any roads, the donkey is an ideal means of transportation for

the sick, the old, and the disabled and very small children. A blanket over the donkey's back makes it more comfortable to ride.

### **Pulling carts**

If donkeys are well harnessed, two donkeys together can pull (in a smooth running cart), four times the load they can carry on their backs. In practical terms this means that a cart is economical only if it costs less than six donkeys, and carries a load not exceeding 500 kg.

### **Other uses**

With the right equipment, donkeys can also be used to turn the wheels for milling grain and for operating pumps that lift water. On a tread-wheel that operates a reciprocating pump, a donkey working for 20 minutes can pump 3,600 litres of water up 10 metres. One donkey should not do this work continuously for more than 20 minutes.

In various parts of the world, donkeys are used to guard other animals, such as sheep, and can protect them from predators. They may do this by raising the alarm with their loud braying, and in exceptional cases they may attack predators should they come near. They can form "friendships" with other animals, particularly if there is only one other donkey in their vicinity.

# 3 Care

The housing of donkeys can be kept very basic. Depending on the climate and season, a small shelter is sufficient. It should have at least a roof and three closed sides that face the prevailing wind directions. There must be enough space to lie down and the floor should not be damp or cold. Barbed wire enclosures should not be used for enclosing donkeys. Many donkeys will try to get through or jump over and injure themselves. The fence or shelter does not have to be very strong since donkeys will not use great force to get through a fence.

## 3.1 Body condition

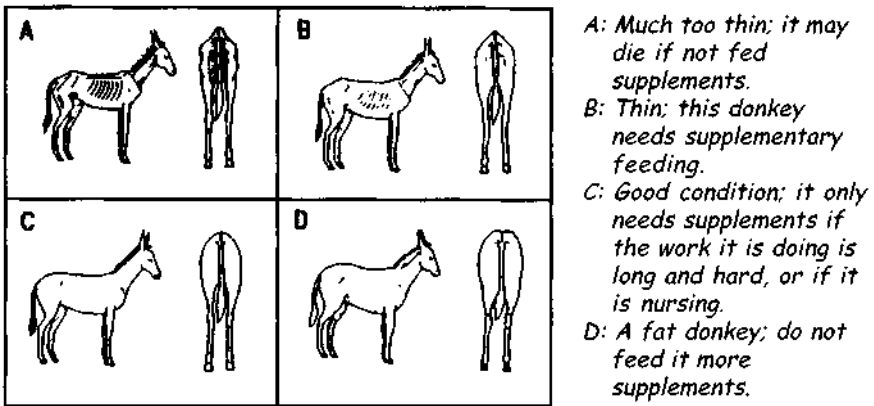


Figure 4: Body condition of donkeys.

The basic well-being of a donkey can be observed by its body condition (figure 4). A donkey is too thin if its ribs or the backbone are very obvious, the neck is thin on top, the rump is pointed or the hipbones are sticking up like those of a cow. A good body condition is a reward for good management. Malnutrition or disease may cause a decline of body condition. Adult male donkeys that are working may require extra energy, and perhaps additional salt. Animals that are still growing,

and females that are pregnant or nursing may also need extra energy, especially extra protein and important minerals (e.g. calcium and phosphorus).

## **3.2 Feeding**

Donkeys need several important feed components - energy, protein, vitamins, minerals and water. Different feeds contain these components in different amounts. Provided natural pasture is abundant and donkeys have adequate time to graze, the feeding of donkeys should not be a major problem. Besides forage (or roughage) from grazing, the animals may be fed additional forage and concentrates provided by the farmer, depending on age and workload.

In general, feeding strategies should be aimed at maintaining adequate body condition during periods of work stress or reproductive stress. Some preserved forage or concentrates should be stored for such periods. This is particularly important if donkeys have to work at the end of the dry season, when natural pasture is scarce.

A properly fed animal will live longer, work harder and resist diseases better. If well fed, females will become pregnant sooner, and pregnant and nursing jennies will produce bigger and healthier foals. Foals given extra food at weaning will grow faster, survive disease better and end up larger. Supplements are most important in the following circumstances:

- Local grazing is poor because of drought or over-grazing.
- Animals must walk long distances for food.
- Donkeys do not get at least six grazing hours each day.
- Female donkeys are in the last three months of pregnancy or they are nursing a foal.
- Young foals are growing, especially between 6 and 18 months of age.

## Forage

In general, forage consists of leaves and stalks of plants (grass, maize stover, etc.). Donkeys need to eat forage every day. The quality of forage depends on plant species and age, season and weather conditions.

As donkeys are selective feeders, they need to have a wide variety of plants to choose from when grazing. Donkeys can be fenced, staked, herded or left to graze unsupervised. If they are herded or range freely, they will be able to seek out a range of plants. If donkeys are staked, it is important to move their stake daily, or even twice per day. If they are fenced, it is better to have several small paddocks rather than one large one. This allows donkeys to be moved often (rotational grazing). In this way donkeys gain more nutrients than if they continually and selectively graze one large pasture. A grazing donkey can ingest eggs of internal parasites contained in manure, causing internal infections with these parasites, particularly worms. Therefore donkeys should not be allowed to graze in areas with lots of manure.

The most common forage supplements are crop residues. These include groundnut hay, and maize and sorghum stover. The leaves of legume fodder trees (e.g., *Leucaena*, *Sesbania* and some *Acacias*) are rich in protein and can also be fed to donkeys. Other sources of fodder include sugar cane bagasse and even shredded paper (if it does not contain too much ink).

Young plants, as well as those growing in cooler, drier seasons provide more nutrients than older plants. The quality of conserved forages (such as dried grass and groundnut hay) depends both on the quality of the original product and on the way it has been stored. They should be stored in a dry place. Forages that become wet and mouldy or dusty can be very unhealthy. If the available forage is not of sufficient quantity or quality to keep donkeys in suitable body condition, they may need to be given some concentrates as well.

## Concentrates

Concentrates are generally seed grains and milling by-products such as wheat bran, oilseed cake and molasses. Concentrates contain more



energy, and often more protein and minerals, than do forages. And they are generally more expensive.

The choice of concentrate feed will depend on local availability and costs. Good (but expensive) concentrated feed includes milled grains such as maize, sorghum and millet. Soiled grains considered unsatisfactory for human consumption can be used, provided they are not mouldy. Cottonseeds, cottonseed cake, groundnuts, and groundnut cake are all good. Dried cassava root can be used, as can green bananas. If they are available, brewer's grains or citrus pulp can be fed. Donkeys like molasses, which provides energy and can be poured on top of bran or forage.

Many by-products of grain are cheaper but less nutritious than grains. Maize bran from traditional pounding is very good. Rice bran and wheat bran can also be fed, but should not form the entire diet, particularly not for young animals, as the range of nutrients is very limited. The amount to be fed may be 1 to 2 kg per day. Finely ground bran may need to be mixed with a little water, to prevent choking. In some countries commercially made concentrates are sold for cattle. If these contain special additives (antibiotics or chemicals such as *Monnensin* or *Rumensin*) they should **not** be fed to donkeys.

Do not feed male donkeys concentrates on days in which they are not working, unless they are very thin. On the other hand, mothers and foals may need to be fed concentrates every day. Feed one half in the morning and the other half in the evening.

### **How much to feed**

The amount of extra feed that donkeys need depends on their size, the amount of work done, the quantity and quality of pasture available and the type and quality of feed used for supplementation.

Donkeys have stomachs designed for frequent small meals (such as when grazing naturally) so the more often they are fed the better. It is not a good idea to feed a lot of forage in the morning before work.

Give small amounts then and during rest periods in the day. Supply supplementary forages in the afternoon and evening, allowing donkeys to feed during the night. A nursing jenny needs the equivalent of about 2 - 3% of her body weight a day if she is only fed forage. A working donkey needs about 3 - 4% of its body weight a day. Thus an average donkey will need about 4 to 6 kg of fodder a day if nursing or working. A jenny that is both nursing and working will need more. If a donkey cannot obtain this amount from available grazing, it will need supplements. In any case, if donkeys are fed concentrate each working day, they will require less grazing, and learn that work brings rewards. If a donkey is fed well, but is still thin, it probably has internal parasites which need treating.

### **Water**

Donkeys need clean fresh water every day, especially when working in hot weather. Lack of water can cause colic, a fatal condition. If possible, donkeys should have access to fresh water all the time, or at least in the morning and evening. Keep the troughs clean. Donkeys should be allowed to drink as much as they want, without being rushed. Donkeys are often expected to drink from nearby ponds or streams. This is convenient, as long as they are not exposed to heavily used, damp, muddy areas as these may favour the spread of parasites, such as liver fluke.

### **Extra minerals**

All donkeys need salt. Rock salt is widely available and small quantities (about three teaspoons daily) can be fed on the palm of the hand or mixed with feed. Commercial salt lick blocks or mineral licks can also be provided in the pens of donkeys. Unless they are fed grain concentrates, donkeys will often need extra calcium and phosphorus. These are needed for growth and reproduction and they may be lacking in local forage. Cattle mineral licks contain these minerals, but avoid cattle licks that have more than five p.p.m. of iodine, as these can be toxic to foals. If licks are not available, try to ensure that the donkeys have some feeds rich in calcium (like legume fodder leaves, groundnut hay, molasses) and phosphorus (such as wheat bran, bone

meal). Calcium can be supplied from crushed limestone (one teaspoon a day mixed with the salt). Bone meal can be made locally by boiling and crushing bones.

### **3.3 Health and disease**

#### **General signs of disease**

Donkeys tend to be quite healthy. When an animal falls ill, give it a rest in a quiet place with food and water. Consult, if possible, the local animal health agent or veterinarian.

A farmer should be able to tell in an early stage whether the donkey is sick. Signs of ill health are when a donkey:

- has a very warm muzzle, pasterns and feet;
- has a nervous or depressed expression;
- hangs its head;
- has a rough coat with hairs standing up;
- stands with all four legs close under it;
- is reluctant to take steps;
- is sweating before work;
- does not pass faeces or urine, or if these are abnormal.

The earlier a disease is recognised, the sooner treatment can start. The cost of medicine or loss of work power can thus be minimised.

#### **Wound treatment**

Donkeys should regularly be checked for sores or cuts. Working donkeys in particular may have sores caused by the harness and should be inspected daily. Minor wounds are fairly common with working animals and may be treated on the farm. Clean the wound thoroughly with a salt solution (brine) and then apply a curative measure, such as:

- Dettol if the wound is fresh, or preferably:
- an antibiotic spray (e.g. Alamycin, Tetracyclin, E.S. 50, etc.)
- healing oil (which contains an antiseptic). This is cheaper but less effective.

Good donkey owners seldom have to treat pack and harness sores, because they try to prevent them.

### 3.4 Daily care of working donkeys

At the beginning of the working day a halter has to be placed around a donkey's head, for instance by using a rope that passes behind the ears and around the nose (figure 5). Lead the animal to a tree or post to groom and prepare it. Donkeys like routine so use the same place each day.

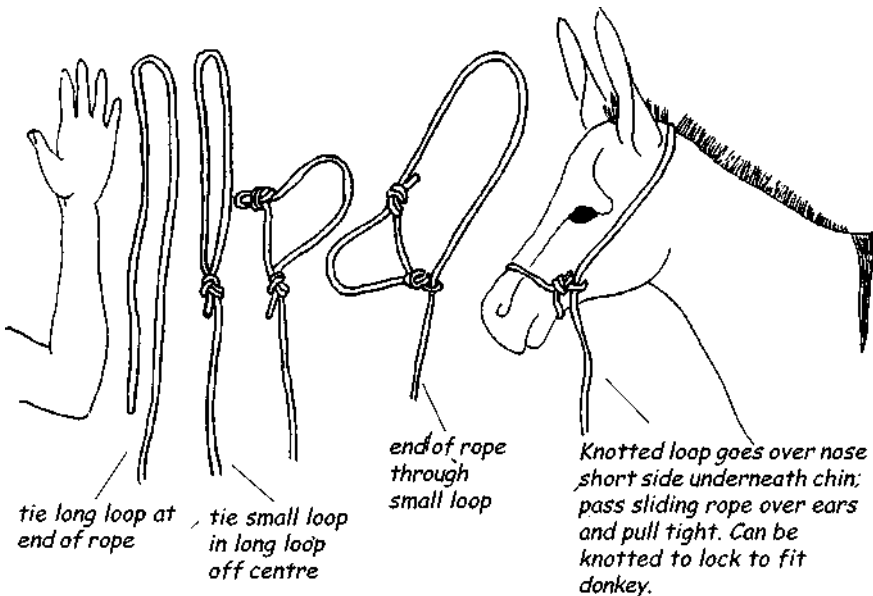


Figure 5: Knotting a head rope or halter.

This is a good moment to give some concentrates or by-products. Otherwise give something like fruit peelings, a banana or a handful of maize. This will encourage the donkey to come and enjoy human attention. Observe the donkey. If its behaviour is different from previous days then something may be wrong. Alertness and interest will indicate that the donkey is healthy.

Feel the legs to be sure they are not swollen or hot. Any damage to the legs caused on the previous day will show up in a stiff and obviously uncomfortable gait. Any temporary stiffness should be quickly “walked off”. If this does not happen the donkey should be put to rest for as long as necessary. If the stiffness persists a veterinarian needs to be consulted.

### **Care of the coat**

Grooming means taking care of the hair and skin of the animal. Daily grooming is important for the health of working donkeys. Donkeys enjoy being groomed and will become tamer by this daily routine. Grooming keeps the donkey’s skin healthy and prevents dirt from causing harness sores. Give special attention to those parts of the skin that are in contact with the harness and/or back pad.

Grooming is usually done first with a stiff round comb, made of plastic, hard rubber or metal. This is used to loosen the dirt. A body brush is then used to remove the dirt. Brush in the direction of the hair (i.e. head to tail) using firm pressure. If such items cannot be purchased locally, a scrubbing brush with stiff plastic or fibre bristles can be used. A piece of cloth or wad of clean straw rubbed in a circular motion, also helps to clean the donkey. Keep grooming equipment clean and periodically soak it in a disinfectant. This will help prevent the spread of disease, especially if the equipment is used on more than one animal.

If a donkey gets very dirty or sweaty, it may be helpful to wash it all over with clean or soapy water. Take a damp cloth and wipe out the nostrils and around the eyes. Any secretions that may have occurred during the night should not be left on the face during the day, as these will attract flies.

Check the coat for external parasites such as ticks. Ticks do not only create wounds, but also spread many infectious diseases. Check especially under the tail and inside the legs where the donkey cannot easily reach when grooming itself. Remove by hand any ticks that are found.

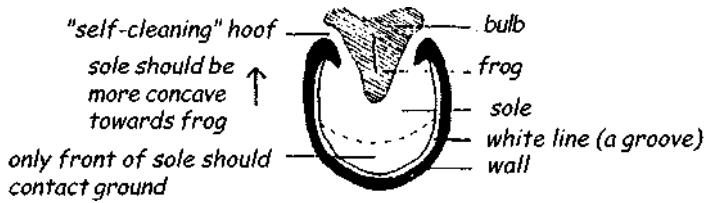
## Care of legs and hooves

Inspect a donkey's hooves daily and take care of them. A donkey's hoof should be short and upright with an oval bottom. If the toe becomes long and slanted, it should be trimmed. Excess hoof wall, as well as ragged loose pieces of frog, can be removed with a sharp, strong knife. Cracks and chips in the wall can spread, and eventually destroy the entire hoof (figure 6). Metal horseshoes are used in some countries to protect the hooves of donkeys. If shoes are not available, the rough edges of the donkey's hooves can be smoothed with a wood file. Coating them daily with oil or grease may help hooves that are very dry or brittle, badly cracked or broken. This prevents them from further dehydration and assists healing.



*Figure 6: Donkey hooves.*

A donkey will pick up its foot if the tendon is pinched at the back of the leg, just above the pastern. Pick up and handle the feet of the donkey early and often in its training, calling a clear command like “leg!” so that it will not object to this care later on during its working life. Clean out the bottom of the hooves with a hoof pick before each use of the donkey, to prevent lameness from stones or other materials penetrating the sole of the foot. Clean from the heel towards the toe, especially in the grooves between the frog and the bars of the hoof (figure 7).



*Figure 7: The underside of a donkey's hoof. When clean, all these should be visible. Clean alongside frog, pushing dirt out at back. Look for stones and thorns which may be lodged, and remove them carefully.*

If the area around the frog becomes black, oozing and very smelly the animal has "thrush". This bacterial disease results from prolonged standing in wet areas. Treat it by pouring on a solution of copper sulfate or iodine daily. Take the animal out of wet housing. An untreated hoof will rot and cripple the animal permanently.



*Figure 8: A hoof pick can be easily made by bending a piece of round steel into the desired shape with one end flat and pointed.*

## 4 Usage as pack animal

The most common use of donkeys is as pack animals for transport of goods and people. They do not need very intensive training to be able to be used as a pack animal. Often, young animals already walk along with the older animals and learn by observation. If donkeys transport goods in a group there is normally a natural order. The strongest animal will lead the group while the others follow. If the farmer keeps a good eye on the leader, managing the rest of the group is not a problem.

### 4.1 Loads and comfort

Because donkeys are so docile and willing, it is easy to overload them. Some farmers make donkeys carry goods equal to the weight of the donkey. This is excessive. In Zimbabwe, it has been recommended that in their initial years, donkeys can carry about one kg for every month of their age. Thus a three-year old could carry 36 kg. Depending on the local conditions, adult animals should be able to carry 40 - 80 kg.

A pack donkey ought to be comfortably loaded. An even load of reasonable weight on its well-padded back will allow a donkey to walk long distances with little or no attention.

Loads should be kept as close to the animal as possible. Tall loads are unstable, particularly if they are not well balanced. They are more likely to be uncomfortable and to shift during motion. In extreme cases they may cause a donkey to fall. At the end of the working day, pack saddles and pads should be removed to allow grooming.

### 4.2 Packing rules

#### Load balancing

All loads should be balanced evenly, with similar weight and bulk on either side of the animal so that it is comfortable. If loads are balanced at the start, they seldom shift or require adjustment.



## **Back padding**

Two-layer padding material between the pack load and the donkey's back is required for protection of its skin. The layer that rests on the skin should be both soft (to provide protection) and absorbent (to take up sweat). It has to be washed or replaced regularly, to avoid growth of noxious bacteria. Several layers of cotton material or sheepskin are ideal for this purpose. Sacking materials are not recommended. Hessian (gunny) sacks can be quite rough and plastic bags are not absorbent.

The second layer should provide a cushioning effect. Well-suited are a folded blanket or a straw-filled sack. With the latter it is important to sew the bag into sections to prevent the straw or other filling (animal hair or kapok) from falling to one end. A protective piece of skin or leather or a plastic sheet may cover the cushioning layer.

## **Protection of the backbone**

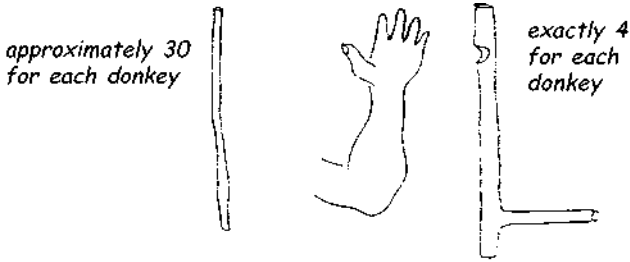
The back padding should be shaped in such a way that it prevents any direct pressure on the backbone. Therefore, a pack saddle or pack frame is recommended. figure 9 shows how such a device transfers the weight of the load onto the fleshier parts of the animal's back at either side of the backbone, i.e. the upper parts of the ribs. Moreover, a pack frame brings the load closer to the centre of gravity, which always results in more stability.

## **4.3 Simple packs**

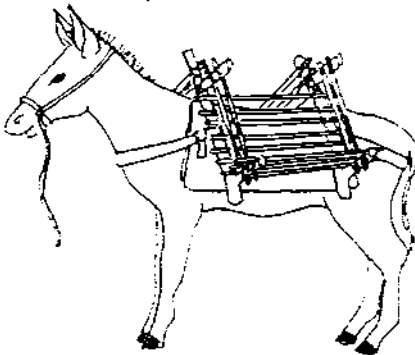
The simplest form of packing involves a single large sack placed partly filled on the back of the donkey, or two (small) sacks slung on either side over the back of the donkey. This is ideal for carrying small quantities of grain. In the latter case there should not be a hard knot directly on the animal's back. A soft pad should be used over the spine and a flat knot tied sideways of the backbone. There is no need for a belly strap.

This system can be used to train donkeys. Light sacks are used of which the weight can be gradually increased as the animal becomes

used to the load. Although this system is convenient, the pack-frame shown in figure 9 is preferably used to carry heavier and/or bigger sacks.



*Cut suitable sticks from strong, flexible wood.*



*Tie sticks with twine or fibre to make two equal four-sided boxes, one for each side of the donkey. Each side may take up to 15 bricks, depending on sizes of donkey and sticks, but load must balance evenly.*

*Straps of leather twine tie the boxes back and front to prevent movement on slopes. Sack or blanket should be under all loads.*

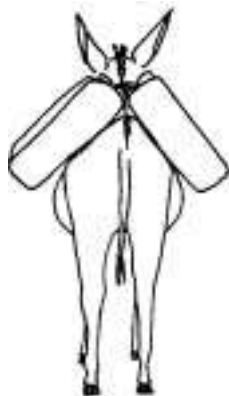
*Figure 9: Simple pack frame or back-box.*

#### **4.4 Jerry cans**

Flat, rectangular containers designed to carry liquids and made of metal or plastic usually have handles at their top. Two such containers with their handles tied tightly together form a good angular shape to put over the back of a donkey. In this way the sides of the containers press against the ribs, and the spine (figure 10) does not take the weight.

Containers come in various sizes. A donkey can easily carry 40 litres, which can best be divided into four 10-litre containers if these are available.

**Containers must be tied firmly to prevent them from slipping down gradually**, because then the ropes will cause considerable discomfort to the animal by pushing on the spine and they might cut into the skin over the spine. If containers are used that are not flat and rectangular, they should be placed on a pack-frame or in panniers at either side of the back.

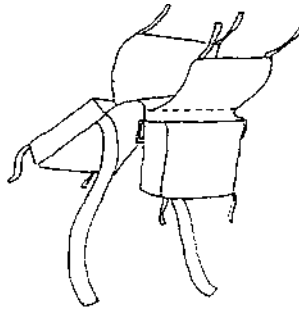


*Figure 10: Carrying jerry cans so as not to stress the spine.*

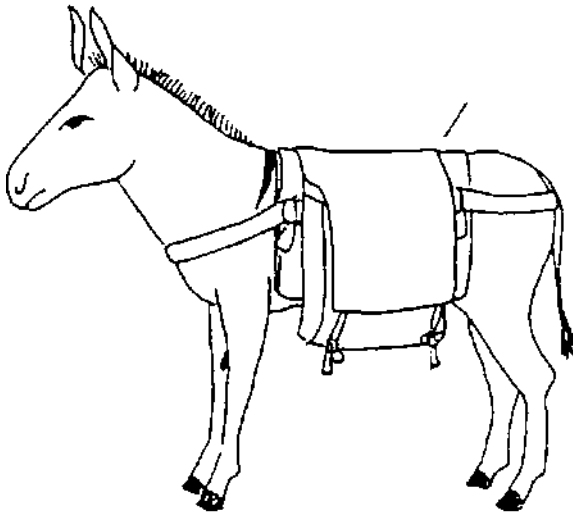
#### **4.5 Pack-frames and soft baskets**

As mentioned earlier, a pack-frame should be used for most loads. The frame may be made of sticks from strong, flexible wood and must be shaped symmetrically to give even pressure on either side; see figure 9 for construction details. It should be well padded underneath for the animal's comfort and to prevent sores. The pack-frame can be held in position by a breast band and a breech strap. Frames can be specially designed to carry a wide variety of objects including logs, firewood, jerry cans and rocks.

Softer materials, like groceries for instance, can be put in saddlebags (figure 11). These can be home-made out of some strong material such as canvas, and should have flaps at the top so that they can be securely closed. Large woven baskets should be joined together (preferably during their manufacture) by a broad back cover. A soft absorbent back pad should be placed on the donkey before the saddle bags or soggies (figure 12) are put on and loaded.

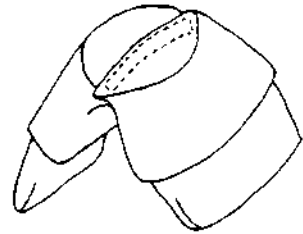
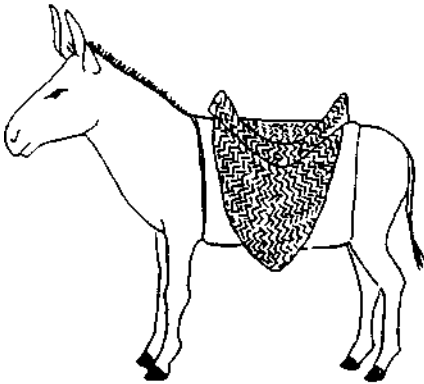
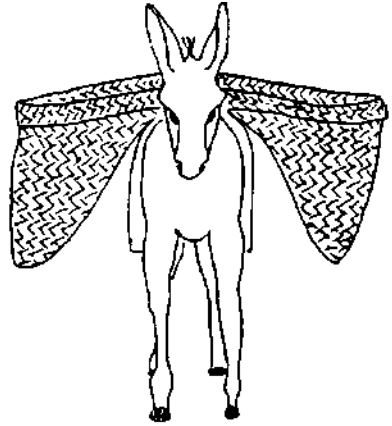
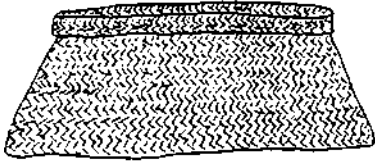


*more flexible than panniers, but still strong,  
e.g. made of canvas or sacking*



*sack or blanket should be put under  
any load to soften rubbing on donkey*

*Figure 11: Saddle bags.*



*alternative "soggie" made of  
two sacks, tops folded  
down and sewn together  
along one side*

*Figure 12: Soggies.*

# 5 Training programme

Before introducing harnesses and starting to work with a donkey, both the animal and the farmer must be trained. Training may be carried out at training centres, but when undertaken on the farm or within the village community, this provides a more practical and “homely” environment. If possible, the farmer should train his or her own donkey, because the sooner a good relationship is established between farmer and animal, the better.

## 5.1 The rationale of a training programme

Communal training is preferred in areas where donkey traction is being introduced, since it can offer a useful exchange of ideas between farmers. Such programmes can also assist in ensuring that the training is continuous because it is executed in a more formal situation.

### Guidelines for the farmer

Training of animals requires patience, firmness, perseverance and above all, consistency. Continuity of the training programme is of prime importance as the animal can soon forget previous lessons when breaks occur.

Animals undergoing training will be in close contact with unknown people, upsetting noises and physical restraints such as harnesses, halters and equipment. They must become accustomed to all of these and also learn to follow clear instructions. The following points may therefore be useful to the trainer (who is preferably the farmer):

- Keep a calm, patient and consistent approach to the animal(s).
- Follow the training steps as described and repeat until full control of the animal is obtained. Do not try to train the animal too quickly, but follow the animal’s acceptance of the training.
- Reward correct behaviour of the animal with a short rest, some choice food, given always with a word like “good!” so that in the end the word alone will function as reward.

## A sequential programme

The training programme described in this chapter is one approach, but not necessarily the only one. Improvements can probably be made, according to local experiences. Training requirements can vary greatly and depend upon both the ability of the trainer and the temperament of the animal. An experienced trainer may be able to go through the exercises much faster. It often helps if a trained animal can duplicate the training exercises alongside the “novice”.

The programme is built up in four steps:

- 1 Roping and walking (2 to 3 days), see Section 5.2.
- 2 Harnessing and walking (7 to 14 days), see Section 5.3.
- 3 Pulling loads (7 to 10 days), see Section 5.4.
- 4 Working as a team (21 to 30 days), see Section 5.5.

## Voice commands

The number of voice commands should be kept to a minimum and as short as possible. The following list of words and sounds can easily be taught to a donkey. It is useful to make use of one **standardised set of short words** that are also used by other farmers in the region, so that if a donkey changes owners, the confusion will be limited.

Word	Intended effect	Local language synonym
No	Stop the donkey's action	
Good	Verbal reward for donkey	
Come	Move donkey towards speaker	
Home	Send donkey home	
Shed	Send donkey into shed	
Harness	Donkey to stand still for harnessing	
Move	Start donkey moving	
Faster	Speed up donkey	
Stop	Stop forward movement of donkey	
Reverse	Donkey to go backwards	
Straight	Donkey to move in a straight line	
Right	Donkey to turn right	
Left	Donkey to turn left	
Leg	Donkey to lift leg	
Furrow	Donkey to follow the furrow	

## 5.2 Step 1: roping and walking

A rope loop should be made from a length of about 3.5 metres of rope (see first step in figure 5). Donkeys are not normally difficult to catch, provided that the trainer approaches slowly and quietly, preferably offering some food. Call the animal by its name, when approaching, talking quietly. Try to gain its trust. When the opportunity arises, place the rope loop around its neck. The knot should be firm so there is no chance of it tightening further if the donkey tries to pull away. If a donkey feels strangled, it will feel threatened and become frightened. The farmer should aim to achieve the opposite: to gain the animal's trust.

When the rope is tied, the animal should be encouraged to walk forwards whilst the farmer shouts "**move!**" and holds the rope from behind. It may be necessary to lightly whip the donkey's rump with the free end of the rope, but do this only if necessary. Alternatively a blunt stick can be used to poke on the rump or thigh; poking will often work better than hitting. The donkey has to be encouraged, not punished.

Now shout the word "**stop!**" giving short pulls on the rope until the animal stops. As after every successfully completed exercise, reward the animal with the word "**good**" and a rest.

If the donkey fails to stop, however, don't allow yourself to be dragged along, pulling harder and harder on the rope. It is much better to repeat the commands, apply further short pulls and follow the donkey until it finally decides to stop - now the reward can be given.

Repeat the routines several times, calming the animal after successful completion.

## 5.3 Step 2: harnessing and walking

### Placing the halter on the donkey

The untrained donkey should first be caught and the rope loop placed around its neck as described in Step 1. Calm the animal by calling its name and talking to it while caressing the neck area.



The main instrument in training donkeys is the human voice. If the donkey is calmed down sufficiently, place the halter over the head and attach a lead rope of about two metres long to the chin ring. Remove the rope loop.

### **Walking the donkey**

Hold the lead rope close to the halter. Now, standing in front and slightly to one side, give the commands practised in Step 1. At first the donkey will resist being pulled, plunging up and down when it feels the pressure. Use of its name and a calm voice will soon settle it. Give a reward in the form of some food. The word “good” should be used only when the donkey is thoroughly calm and *not* while it is still fighting the rope.

If reward does not work too well in the beginning, a second person waving something noisy, such as a leafy stick, behind the donkey can start it. Poke the donkey’s rump or upper legs.

Repeat the exercise of stopping and moving and reward the animal with a rest each time it has performed well. It helps considerably if an older well-trained donkey follows the same exercise alongside the animal that is trained. A young donkey should be trained alongside its mother.

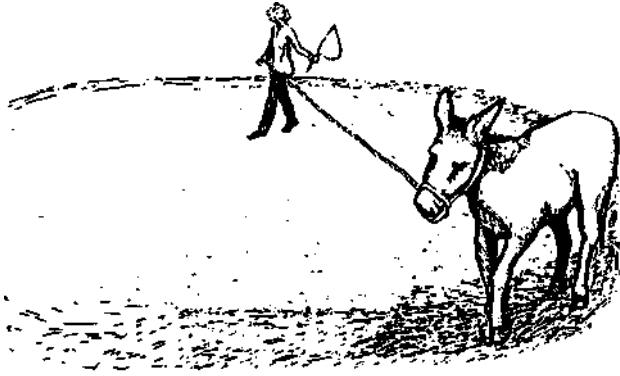
### **Introducing turns**

Continue practising the “move!” and “stop!” commands and eventually introduce “**right**” and “**left**”. When turning, hold the lead rope close to the halter and pull the donkey’s head to the side where the turn is to be made. These walking exercises on a closely held lead rope should extend over three to four days in two daily sessions of about an hour and a half.

### **Extending the lead rope**

When the above exercises are repeated, the lead rope should be gradually held further from the animal’s head so that it becomes more accustomed to obeying the voice commands than being led. The trainer can eventually stand still, holding the donkey at the end of about 5

metres of lead rope, whilst the animal circles around him or her obeying the commands (figure 13).



*Figure 13: Training the donkey at the end of a 5-m lead rope.*

### **Fitting the harness**

The animal will need to be calmed as soon as it feels the harness. Fit the breast band and straps (figure 15) or just the collar (figure 18) depending on the harness adopted, see Chapter 6, and not the full harness. This is done after the halter is already in place.

The walking exercises on a closely held lead rope should be repeated until the animal accepts the harness. Gradually the training can return to walking in circles on the long lead rope as before.

## **5.4 Step 3: pulling loads**

### **Driving the donkey from behind**

Before the donkey starts to pull a load, it must learn to be driven from behind. The halter and part harness are fitted as in Step 2 and the reins fitted to the halter or bridle with bit if preferred. Repeat the walking exercises using the commands the donkey learned before until the donkey is fully controlled from behind. This may take several days.

A new command “**reverse!**” should also be introduced at this stage. An assistant may be required to stand in front of the animal and persuade it to move backwards by holding its halter and pushing while the trainer shouts the command “reverse!” from behind.

### **Attaching the traces and pulling a load**

Harness the donkey and attach both traces together with the steering reins. The right-hand trace should first be tied to the harness so that it pulls the swingle tree over the ground but the left-hand trace is allowed to trail. Drive the donkey in a left-hand circle from behind, but with an assistant holding a lead rope on the halter so that it is well controlled and is forced to the left. The objective is to accustom the animal to the new sounds made as the hitch system drags over the ground. Normally a day or two is sufficient for the animal to become used to the new sensations and noises. As soon as this has happened, both traces can be attached to the harness and the swingle tree to the end of a light log, weighing about 10 kg. Drive the animal from behind and practice the voice commands. After a couple of days, a larger log weighing about 20 kg should be used for the exercise.

## **5.5 Step 4: working as a team**

### **Making two donkeys familiar with each other**

Before commencing the exercises, the donkeys should be fitted with the breast band or collar harness and tied to a fence for a few hours at a time for several days. Each animal should always be tied on the same side, a position that will later be maintained when working in the field.

Once the pair is familiar with each other, they should be led together from the stock with the harness fitted. Choose a training area with plenty of space and hitch the animals to a 20-kg log. An assistant should lead the animals whilst the trainer uses voice commands to direct them from behind.

After a couple of days pulling the log along the ground, the pair should be introduced to the idea of working in a furrow. Prepare a straight furrow beforehand. Now lead the donkeys to pull the log along it, the right-hand animal walking in the furrow and the left-hand one walking on the land. Always maintain the animals in the same relative positions for this exercise and repeat until they obey the voice commands and no longer need to be led by the assistant.

### **Learning to use farming implements**

Lead the animals to the furrow used for the log-pulling exercise. Hitch them to the plough and lead them to pull it along the furrow. Start by holding the share clear of the ground so there is little resistance. This allows them to become accustomed to the noise of the chains and wheel at work.

After a few practice runs, the plough can be engaged at a shallow depth. Gradually the depth can be increased and eventually the assistant should no longer be needed to lead the animals, the voice commands from the trainer being understood and obeyed.

The problem to be mastered in using the harrow, is to keep a straight line whilst the donkeys walk over the tilled land and have no furrow to follow. For this reason, the voice command “**straight!**” should be introduced.

### **Learning to pull a cart**

Normally a different harness will be used, as the animals not only need to pull, but also must be able to support some weight of the cart and to stop the cart.

The training principles remain the same. Introduce the animals first to the harness that will be adopted. Allow them time to become used to it. Hitch them to the cart and, with the help of the assistant; lead them across the training area.

# 6 Harnessing

The harness links the draft animal to the cart or implement. So, to be effective, it has to tap the power of the animal in the right places. In some parts of Africa, donkeys, horses or mules are used with withers yokes (also called neck yokes), similar to those used for cattle.

## 6.1 Purpose of a donkey harness

One reason for yoking donkeys is simply for convenience and simplicity where withers yokes for oxen are already available, and where equine harnesses are not easy to obtain. Another reason is ignorance of other harnessing possibilities.

As can be seen from figure 14, weight is best borne on the back, and the shoulders are the best place to generate pulling force. Donkey shoulders are too low to be reached by a yoke. Moreover, by pushing on the neck, a yoke can force a donkey's head to be kept low, whereas a donkey works best with its head up and looking straight ahead. The same can be said about a sling made from sacks, which is often used to connect a donkey to a cart. Much better harnesses for tapping the power of all equines are breast bands and collars.

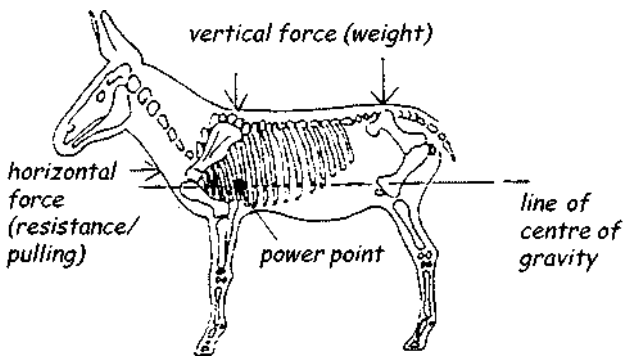


Figure 14: Placement of forces on a donkey's skeleton.

## 6.2 Harnesses in general

The **breast band** is the simpler and cheaper harness. The work force is primarily taken from a broad band of leather, rubber or strong canvas material across the animal's chest. Traces (ropes or chains) or shafts attached to either end of the breast band pass back to the implement.

One or more straps hold the breast band in position and take up the vertical component of the workload. Usually there is a neck strap crossing the withers and a back strap across the middle of the back. They are often padded on the back and referred to as "saddles". The back straps may be adjustable or made to size.

For heavy work a well-fitting **collar** around the neck is preferred over a breast band harness. It is positioned between the strongest points of the donkey (its breast and its withers) and is therefore most efficient for pulling at an angle as is required for cultivation implements (see figure 21). The collar is made in two parts so that it is easy to put on. The making of good collars requires a skilled craftsman and is therefore expensive. However, simpler designs have been made recently in an attempt to bring their cost down, without losing their efficiency.

**A harness must properly fit the donkey's body and must offer a sufficiently large contact area** to spread the load in such a way that damage to the skin is prevented. The skin of equines is sensitive to rubbing and relatively soft materials or padding are advisable. Padding is particularly important at places where harness parts have (even the slightest) tendency to rub against the skin or to cut into the flesh.

The best construction material for harnesses is leather, although this is often unobtainable or expensive in some regions. Leather needs to be well cared for, as it is prone to drying out and hardening. To prevent hardening, a leather harness should be waxed or oiled with vegetable oil or animal fat. On the other hand, a leather harness may become mouldy if allowed to be constantly damp.

There are several useful alternatives to leather. The most successful are canvas and synthetic webbing, a strong closely woven fabric. Hessian or jute sacking material is often used for making harnesses and padding, but these materials can be very rough and abrasive if they have been soaked in sweat and allowed to dry.

All harness equipment should be kept free of dirt and dampness to avoid sores and infection in the donkey. Therefore, harnesses should never be left lying on the ground, but should always be hung up somewhere out of the reach of children and animals.

### 6.3 Various pulling harnesses

#### Breast band harnesses

The webbing breast band may be made from strips of webbing which are sewn together to fit the donkey (figure 15). The width of the breast band is about 6 cm. The neck strap is 4 cm wide and not adjustable. Leather parts are used to reinforce the breast strap at the connections with the neck strap and the triangular ring. Short breast bands with one neck strap have the advantage of connecting the traces near the power point (figure 14). Long breast bands with two back straps are required where the implement needs a certain amount of lifting, like single mouldboard ploughs without a support wheel.

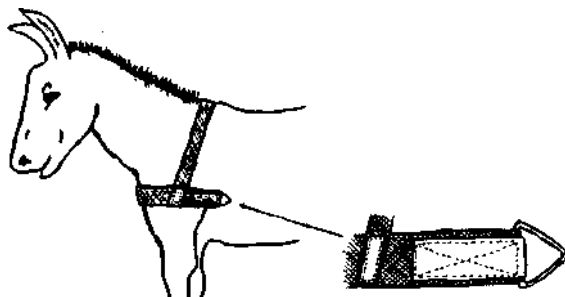
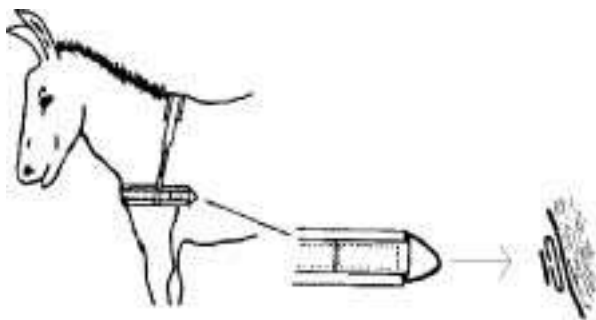


Figure 15: Design for a webbing breast band with one neck strap.

A similar design can be made with rubber from an old car tire. The breast band is cut from the tread of the tire (6 cm wide) and the neck strap from the tire casing (5 cm wide). The joints are stitched together with thin wire. To avoid hurting the donkey's skin, make sure that the wire is pulled tightly toward the outer side while stitching, so that **the wire is well sunken into the rubber** on the inner side of the breast band, which touches the donkey. Edges should be rounded. Conveyor belts, joined by bolts, can also be used instead of tire rubber. Padding must be applied to absorb sweat and to protect the skin.

When made out of leather, a 12-cm wide strap is folded twice. Over the seam a 3-cm wide strap is fixed for taking the stress (figure 16). This compiled leather strap (about 5 cm wide) distributes the pressure on the breast and acts as a cushion at the same time. Fewer sores develop from this arrangement as the major stress is on the middle of the strap instead of on the edges. In this more expensive design, the neck strap has a pad on the top to distribute the weight and it has adequate adjustment possibilities to fit many donkeys.



*Figure 16: Adjustable leather breast band harness.*

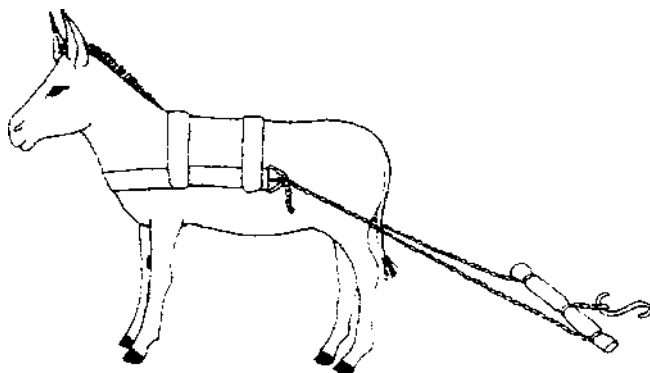
Make sure the harness is properly adjusted for the donkey. The breast band strap should run across the chest just above the point of the shoulder (figure 1). When fixed too high, there is a danger of choking the donkey; when fixed too low, the two ends may run over the shoulder points where the front leg bones attach to the main skeleton, making walking very uncomfortable for the donkey. The space for a breast



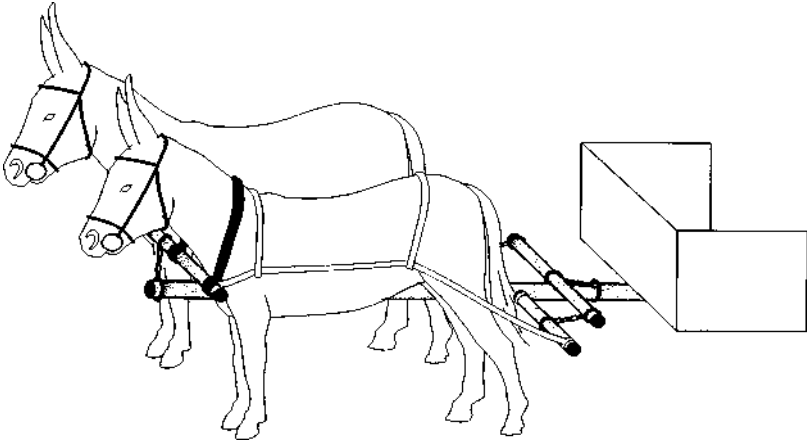
band is actually very limited on the chest of a donkey, which is a major drawback for this type of harness.

### **Zimbabwean breast band harnesses**

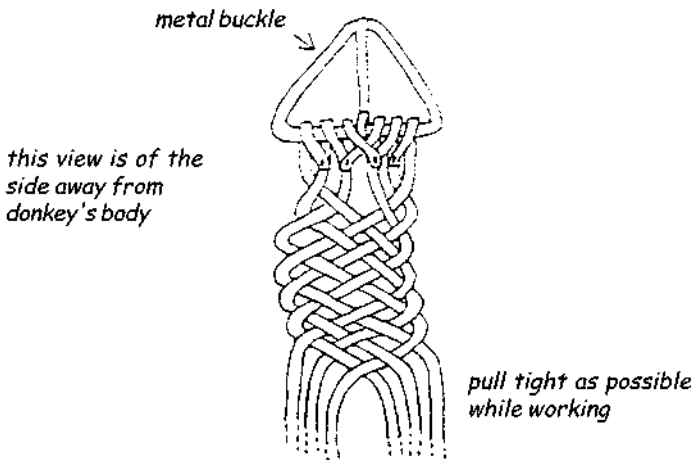
In Zimbabwe, the short and the long breast band harnesses are promoted for their simplicity and durability. They are made out of conveyor belts or other belt material. The short breast band is longer than the one discussed above, since it has two back straps. The front back strap should be joined to the breast strap at “power point”. The rear back strap serves to keep the breast band in position (figure 17). The extended breast band runs all the way to the swingle tree, making ropes or chains superfluous. If they are used on two donkeys pulling an ox-cart, two neck slings will also be needed to hold up the single shaft by means of an additional evener up front (figure 18). The coupling between the evener and the shaft should be flexible.



*Figure 17: Longer breast band harness as used for field implements. The further away the implement, the smaller the pulling angle, which puts less strain on a harness, depending on the resistance of the soil and the required ploughing depth. Greatest force is exerted where breaststrap and front-backstrap meet. For a steeper pulling angle, second backstrap should be further back, over the donkey's hip bone.*



*Figure 18: Extended breast band harness applied on two donkeys pulling an ox-cart. See for swingle trees figure 22.*



*Figure 19: Harness made out of braided goatskin. Any number of leather strips can be used but even numbers are easier.*

Since these breast bands are not adjustable, they should be made to size to be comfortable. Besides, the sharp edges of the belts, unless

filed round or padded, can cut into the donkey's skin. There is also the problem that the heads of the bolts used to connect the different straps, often catch in the donkey's hair and irritate the skin. Therefore, it is necessary that some padding be provided, preferably enclosed in material that absorbs the donkey's sweat. The best solution is to make these types of harnesses out of leather, such as braided goatskin (figure 19).

### **Breast protectors**

Most sores and wounds are caused by poor quality or ill-fitting breast bands in combination with traces that are fixed directly to a rigid part of the cart and not to a swingle tree. Instead of heavy cloth or sheep skin as padding for the above-mentioned breast bands, one may also make a simple removable and therefore easily washable breast protector. It is a cushion made of foam rubber and canvas placed between the strap and the donkey's breast, which can be buttoned to the breast strap.

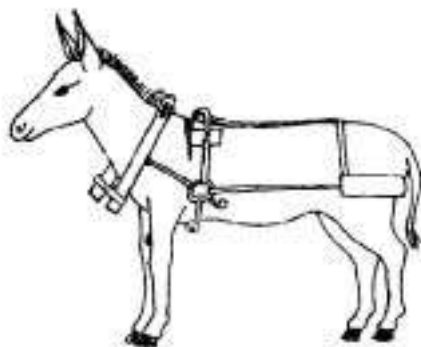
### **Collar harness with straight hames**

A recent design made in South Africa uses straight wooden bars padded with sheepskin. The hame straps are made of home-tanned leather. They are simply tied together in a way that will easily allow adjustment. See figure 20; the saddle shown is part of the full harness, including a breeching made from old fire hose, needed for pulling a cart.

### **Three-pad collar harness**

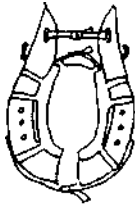
A special donkey collar harness developed in Kenya is modelled after European cattle and horse collars. The harness comprises two wooden hames, hinged by leather straps at the top and joined by a leather strap at the bottom. The hames are shaped to match the contours of the animal. The shoulders are protected from direct contact with the hames by two pads, made of canvas and stuffed with cattle tail hair, recovered from butcheries. The third pad is made of leather and is attached to the lower of the two top straps, which rests on the withers. The load is passed by nylon traces from the hames to a swingle tree. For pulling

operations, a back and girth strap with trace holders are used to prevent entanglement of the traces and the donkey's hind legs (figure 21).

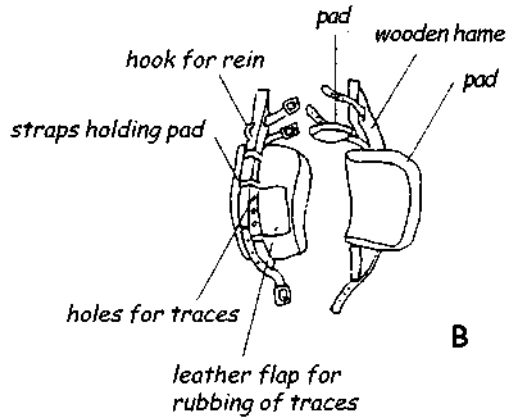


*Figure 20: South African collar with straight hames.*

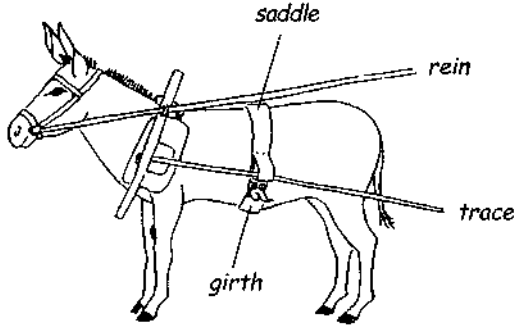
Three-pad collar harnesses are expensive compared to harnesses discussed previously, because they are produced by artisans using good quality materials like hardwood, leather and canvas. However, over one thousand of them have been made in Kenya on demand and those who can afford them like them very much for their comfort, power, efficiency and durability.



**A**



**B**

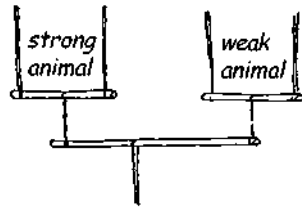
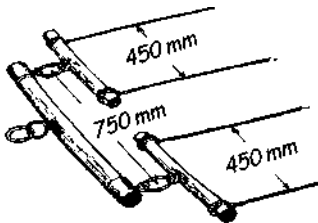


**C**

*Figure 21: Three-pad collar harness with saddle and girth.  
 A: as mounted (front view)  
 B: detached (side view)  
 C: mounted*

# 7 Hitching

As the donkey walks, its shoulders move backwards and forwards. To prevent rubbing the skin, the harness must be able to move in line with the shoulders. Ideally, the traces should be attached to a swingle or swingle tree and not directly to the implement. Linking two donkeys to a cart or implement requires the use of an evener. The implement is normally pulled from the centre of the evener, but if one animal is stronger than the other, the trek chain should be attached closer to the side of the stronger animal to compensate for the inequality in pulling force. If the traces are made from rope, notches should be filed in the wooden swingle tree so they cannot slip off (figure 22).



*to hitch together a pair of donkeys*

*compensating for a weaker animal*

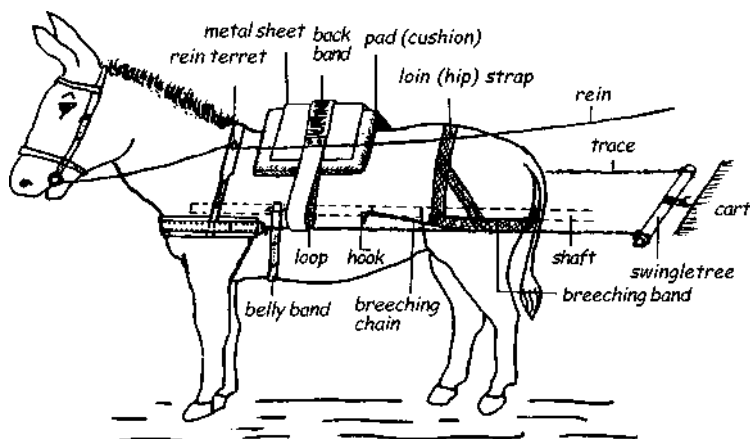
*Figure 22: Suggested sizes for the swingle trees and evener.*

## 7.1 Hitching a single donkey to a cart

The breast strap or the collar harness are designed for pulling only and provide no possibility of pushing in the opposite direction to brake a moving cart. This can be overcome by adding a **breech strap** that passes round the rump and **under** the tail of the donkey.

The vertical load that the cart imposes on the donkey through the shafts is carried over a **saddle**, held in place by the girth strap. Alternatively, a belly band can be used which connects the shafts underneath the donkey. A belly band has the additional advantage of preventing cart tipping when there is too much load in the back of the

cart. The breech strap is attached to the shafts of the cart whilst the breast band is attached to the swingle tree on either side (figure 23).



*Figure 23: The arrangement off the breast band, breech strap and saddle for harnessing a donkey to the shafts of a two-wheeled cart.*

The shafts must be able to **move forwards and backwards** through the shaft holders to some degree. When the donkey starts pulling, the shafts go backwards a little so that the traces exert the pulling force while the breech strap is slack. When the donkey starts braking (or the cart goes faster than the donkey), the shafts come forwards a bit which tightens the breech strap and slackens the traces.

A “**false breeching**” can also be used. This is a wide strap attached between the shafts right behind the donkey. This method is easier to arrange than a breech strap. The donkey is able to brake the cart by pushing its hindquarters against the false breeching.

It is also important to use a **rigid saddle** rather than just a pad to protect the backbone if the load is anything but very light. The saddle should be located right behind the withers as shown in figure 23. The saddle in this case has a metal sheet on top of the pad to make it rigid.

The belly strap keeps the saddle in place, while connections between the saddle parts keep them together.

## 7.2 Hitching two donkeys to a cart

Many two-wheel donkey carts were designed for oxen. The single shaft is normally connected to a withers (neck) yoke. Since yokes are unsuitable for donkeys, another hitching system must be used. The best solution is to replace the one shaft by three and use the arrangement described above.

Figure 24 shows a similar arrangement with four steel shafts. The vertical load comes on the back saddles and traction is taken through the collars or breast band harnesses. Commercial transporters who use their cart and donkeys daily, should consider this option.

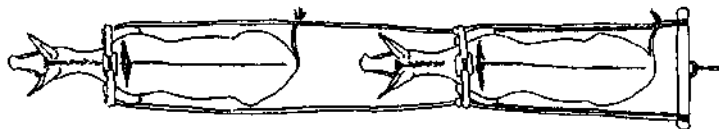


*Figure 24: Four-shaft design for hitching two donkeys with collar and saddle to a two-wheeled cart (photo: Luurt Oudman).*

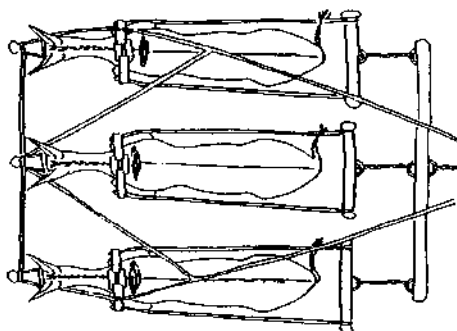


### 7.3 Other hitching arrangements for teams of two or more donkeys

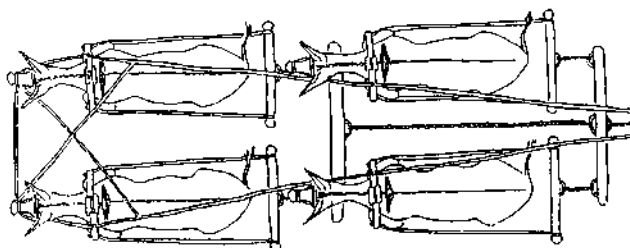
Alternative hitching arrangements for teams of two, three and four donkeys with collar harness pulling implements are shown in figure 25A,B and C.



*A: Hitching in tandem.*



*B: Hitching 3 donkeys side by side.*



*C: Tandem pairs*

*Figure 25: Several hitching arrangements*

An alternative hitching arrangement for two donkeys, called “hitching in tandem”, is shown in figure 25A. However, the traces of the front donkey should **not** be passed through holes in the hames of the collar of the rear donkey, as shown in this illustration. Instead wire loops should be fixed to this collar, just for holding up the traces when not under tension. The same arrangement may be used for a cart with two shafts. The rear donkey is hitched between the shafts in the normal way and provides support for the vertical load of the cart besides a pulling force. The front donkey is connected to its own swingle tree behind the rear donkey and provides draft force only. Tandem hitching has the advantage that donkeys of different size, and animals of different species, can be hitched together.

However, as one animal provides all the braking force, this method should be used with caution where gradients have to be negotiated, unless a mechanical brake is fitted.

Figure 25B shows the hitching of three donkeys side by side. This arrangement is too wide for ploughing, but appropriate for other pulling jobs. It is also used for pulling a cart, with the centre donkey in between the shafts.

Figure 25C shows four animals in tandem, a common arrangement for pulling a plough, cart or wagon. The rear donkeys are provided with slings to keep the front evener suspended.

If donkeys are used next to each other, a coupling between their heads will keep them at a consistent distance from each other. There are also reins going from the (front) animals to the operator for driving the donkeys in the desired direction (figure 25B and C). To attach these reins, at least a halter is needed.

## 7.4 Reining systems

Controlling a donkey’s head is the best way to control a donkey. A head rope is easy to make and to slip on to a donkey to fetch it when needed. For more prolonged use, a halter should be made of flat material, like leather or strong webbing (figure 26).

A halter should have buckles or ties for proper fitting and metal rings by the donkey's mouth to which reins for driving can be attached. Certain jobs require particularly good control of the donkey, like tillage operations or cart transport in heavy traffic. Combined with taught commands, only small amounts of pressure on the reins are necessary to give that extra control.

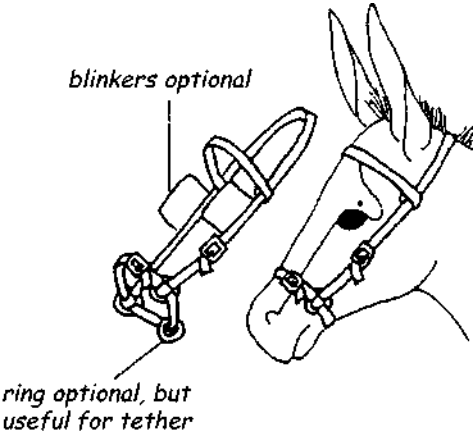
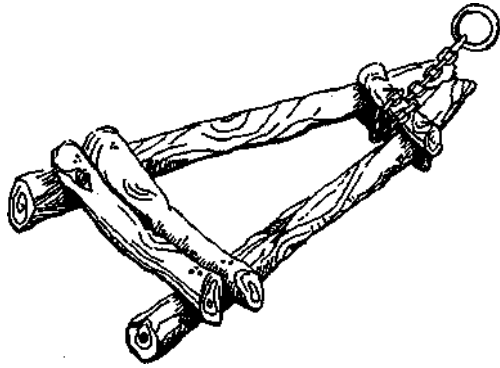


Figure 26: Halter.

## 8 Equipment for transport

Pulling is generally a more efficient way of moving things than packing, because most of the load is not borne by the animal. Moreover, the load does not have to be prepared in a special way to fit the animal. The most simple load vehicle is a sledge made out of a Y-shaped tree branch (figure 27). The sledge is attached to the animal by a trek chain.



*Figure 27: Simple wooden sledge as used in eastern and southern Africa.*

### 8.1 Sledges

The **advantages** of sledges are that they are cheap and simple to make and maintain. They have a low centre of gravity and they are narrow, enabling them to be used on tracks too narrow or steep for carts. They can often be used in sandy, muddy or rutted conditions where a cart might become stuck.

However, there are many **disadvantages**. In most conditions they require more effort to pull than a cart. They have limited clearance and can be stopped by stumps. Most importantly they tend to accelerate erosion by leaving rutted tracks, often only passable by other sledges, which become watercourses during heavy rains.

### 8.2 Carts

Carts are two-wheeled vehicles. They can be small and light, pulled by one donkey, or may carry over one ton and be hitched to a team of

donkeys. Carts are becoming very popular, especially in Africa, as they can be used on rough roads and throughout the year, while other implements can only be used for a small number of days each year.

### **Preferred designs**

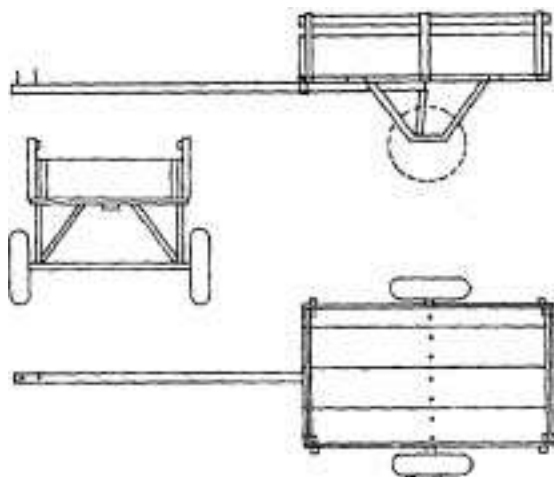
In recent years **small wheels fitted with pneumatic tires** have become the accepted standard for animal-drawn carts in many African countries. Small wheels (40-60 cm diameter) allow cart platforms to extend over the wheels, which is practically impossible with large wheels (80-180 cm). Such a design provides a wide, but not too high, loading area and easy access from the sides, and thus greater convenience for loading and unloading (figure 28).

Small wheels are more likely to be obstructed by holes and ruts than the large wheels. However, the adoption of common automobile tire sizes on carts has so many advantages that this drawback just has to be accepted.



*Figure 28: Two-wheel carts using roller bearings and factory-reject car tires. Designed for a team of oxen, but a smaller size is used with donkeys in Togo.*

Where the use of specially fabricated animal-drawn carts is common in Africa, the preferred designs have been based on straight steel axles with sealed roller bearings. A simple steel cart frame is bolted onto the axle and a wooden or steel platform is fitted into this (figure 29). While such designs are not particularly cheap, they are usually long lasting.



*Figure 29: Cart type widely used in West Africa, being based on fixed solid steel axle, roller bearings and imported wheels and tires.*

### **Scrap vehicle parts, tires and brakes**

In many countries, carts are made from old car axles or from the entire rear section of light pick-up trucks. These are generally heavier than carts with purpose-built axles, but where the necessary scrap vehicles and skills are available, such carts can be very efficient. Also, the independent stub axles from a car can be welded onto a hollow metal pipe or square section and attached to a wooden frame. If a metal frame is used, it should be bolted to the axle so that it may be easily removed in case of repair.

Old car axles and rims often come with worn down tires. Retread tires are much more reliable in that respect. An alternative approach, widely used in West Africa, is to purchase at considerable discount the reject tires from large factories. Low grade, rejected car tires can be safely used with animal-drawn carts.

Although puncture repair is often seen as a major constraint, it is widely observed that once a reasonable number of pneumatic tires (on carts, motorcycles, cars and pick-ups) are in use in an area, puncture repair services spring up in even quite small villages.

Brakes are important for making emergency stops, but also to save the animals from discomfort where steep slopes are encountered. Even on flat ground, a loaded cart pulled at normal speed has a considerable momentum, and absorbing this through the harnessing system in an emergency stop or on a downward slope can be very uncomfortable for the animals.

However, the choice of harnessing system does influence the efficiency with which animals can brake carts with their own bodies. Good breeching systems are shown in figure 23 and figure 24.

Basic wheel brakes can be made from concave wooden blocks or just bars or logs that are pushed against the wheel or tire surface. A lever mechanism is desired for emergency stops. Some manufactured wheels for carts come with internal brake shoes. Old car brakes can be quite easily adapted if mechanical parking-brake linkages are available.

### **Size and balance of the load**

Most carts are designed to withstand loads of up to 1000 kg. The ability of animals to pull such loads depends on the road surfaces and slopes. Single donkeys can generally pull loads up to 500 kg, single horses can pull 700-1000 kg, while pairs of oxen can pull 1000 kg or more.

Balancing the load on two-wheeled carts is very important, as any imbalance will cause upward or downward forces on the animals' harnessing system. The axle should be placed in such a position that a small load is always resting on the harnessing system when the cart is empty. When the load is put on the cart, it should be balanced in such a way that the load on the harness remains light but present under all circumstances, see figure 30. When a heavy load shifts backwards, a donkey can be literally lifted off its feet. Some cart manufacturers pla-

place the axle quite far to the rear to avoid such an incident, but they don't seem to realise how much unnecessary load will be put on the animal's back in this way.



*Figure 30: Two-wheel donkey cart in Mali. Provided the load is well balanced, donkeys can pull impressive loads along flat roads.*

### **8.3 Wagons**

Wagons are four-wheeled vehicles with a higher weight capacity than carts. They also have the advantage that the wheels support the whole load, so that the animal power is only needed for forward movement. Wagons can be left with loads in place even when the animals are not present. However, wagons have a more complicated design to ensure manoeuvrability and stability, which makes them heavier and more costly. They are best suited to tarred and level roads and to areas where the increased load capacity is cost-effective.



## 9 Equipment for primary tillage

Tillage involves the disturbance of soil to create the best conditions for seed germination and eventual plant growth. Tillage serves three main purposes:

- to control growth of weeds by destroying them or by inverting the soil and burying them;
- to increase the infiltration and reduce the runoff of water from rain or irrigation supplies;
- to disturb and aerate the soil to a depth which allows the plant roots to penetrate deeper.

Primary cultivation equipment has a high draft requirement and is usually more suited to larger animals than the donkey except where the soils are especially light and sandy. Teams of donkeys or smaller implements make primary cultivation with donkeys a feasible option.

Various animal-drawn implements are available. The choice depends on climatic conditions, soil type and farming system. In this chapter the following will be discussed: mouldboard plough, ard, scarifier, ripper and ridger

### 9.1 Mouldboard plough

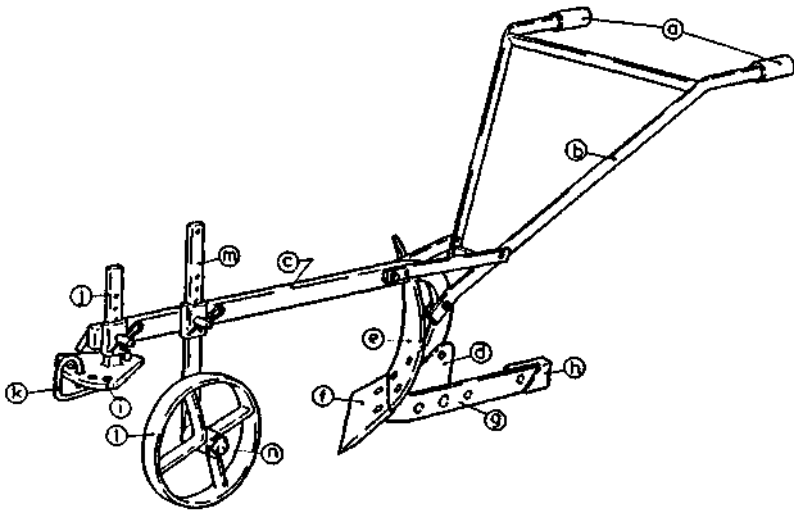
In regions of moderately high rainfall, where also the heavier soils are found, weeds are a serious problem. The weeds can be buried by inverting the soil with a **mouldboard plough**. The degree of inversion depends on the cohesion of the soil and the shape of the mouldboard. As it moves soil to one side, the mouldboard plough clears a distinct furrow. By continually turning soil into each previous furrow a farmer can systematically cultivate a field in one operation, covering both weeds and surface trash.

An additional advantage of the mouldboard plough is that it is suitable to mix organic or chemical fertilisers into the soil. When the organic

material consists of living green plants less than 30 cm tall, all of it can be ploughed in.

**Parts**

Most plough bodies comprise a central element, or *frog*, to which are attached a *share* which cuts soil, a mould board which turns the soil and a trailing landside which provides stability. The end of the landside is known as the *heel*. The heel assists in controlling the depth of the plough. Since it can be subject to rapid wear, it may be detachable to be replaced independently of the landside (figure 31).



- |                |                   |                    |
|----------------|-------------------|--------------------|
| a,b: handles   | f: share          | j: vert. regulator |
| c: beam        | g: landside       | k: hitch shackle   |
| d: frog        | h: heel           | l: wheel           |
| e: mould board | i: hor. regulator | m: wheel arm       |

Figure 31: Parts of the Rumpstad Sandy III plough.

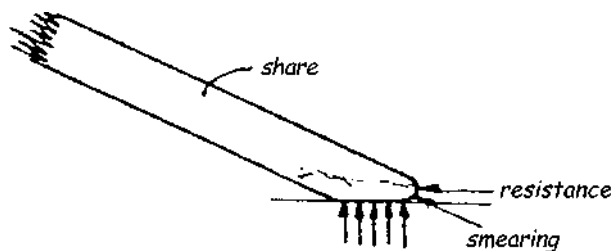
An adjustable *land wheel* is attached towards the front of the beam to reduce pitching (front moves up and down relative to the back). Many use it to restrict the depth of ploughing. However, this practice can lead to considerable loss of energy, as the vertical adjustment of the

hake should be used for depth control. The *handles* are meant for steering and **not** for depth control (figure 31).

### Share size and sharpness

The length and angle of a ploughshare determines the width that the plough cuts. The quoted size does not refer to the dimensions of the share itself but to the width it will cut (e.g. distance “a” in figure 33). Small shares require less draft power; but as each plough furrow is small, it takes longer to cultivate each hectare. Most mouldboard ploughs in use in Africa have shares of 18-23 cm. If the width of cut is 18 cm, then the maximum depth of cut that allows good inversion of the soil beam is 15 cm. So, 15-cm donkey ploughs are limited in their cutting depth.

Ploughshares need to be regularly sharpened, reworked or replaced. A worn ploughshare cuts a smaller furrow and can lead to the plough body itself becoming worn; that is much more difficult to repair. A worn ploughshare also leads to penetration problems.

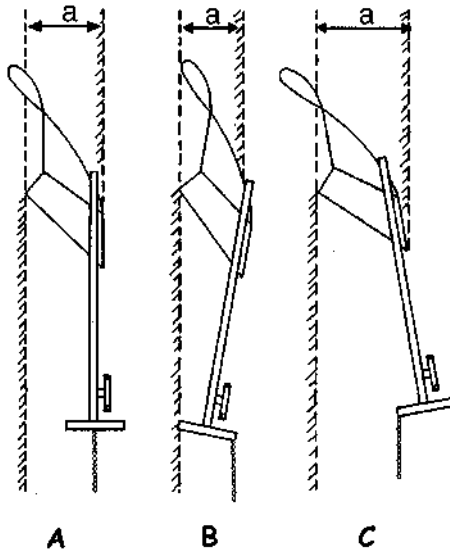


*Figure 32: A blunt share creates a plough-sole, increases the draft and makes penetration into the soil difficult.*

**Blunt ploughshares create a plough-sole** since cutting becomes smearing under most conditions. The macro-pores in the soil become sealed, which leads to a reduction in the flow of water and air through the soil. **Blunt ploughshares also require considerably more draft force** than sharp ones (figure 32).

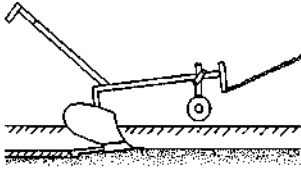
### Width and depth adjustment

Figure 33 shows (in exaggerated form) the horizontal adjustment of a plough. In picture A the chain is attached to the central position. The plough cuts the furrow equal in width to share size. In picture B the chain has been moved horizontally towards the unploughed land. The share is skewed so that it is even more angled to the direction of movement, and thus it will cut a smaller slice of soil. In picture C the chain has been moved horizontally towards the furrow and the share is pulled around so that it cuts a wider furrow.

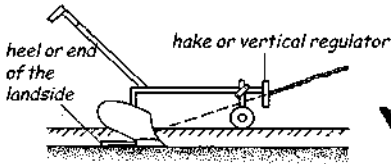


*Figure 33: Horizontal (width) adjustment of a plough; rendering is exaggerated for the sake of clearness.*

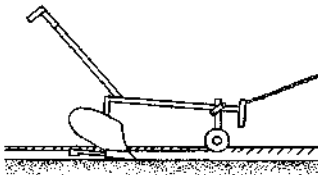
The depth or vertical adjustment on the regulator can be viewed in a similar way, as shown again in exaggerated form in figure 34. Moving the chain downwards causes the plough to pivot so that the heel presses down and the share points upwards. The share is actually being pulled out of the ground. Moving the chain upwards causes the heel to rise and the share to point downwards, hence the plough will go deeper.



*Incorrect adjustment:  
Wheel lifts off the ground and heel digs in too deeply. Problem: too much leverage low down on regulator. Solution: raise the chain attachment. A similar problem is caused if the chain is too short.*



*Correct adjustment.*



*Incorrect adjustment:  
Wheel digs into soil and heel lifts out of furrow. Problem: too much leverage high on regulator. Solution: lower the chain attachment. A similar problem is caused if the chain is too long.*

**Figure 34: Vertical (depth) adjustment of a plough; rendering is exaggerated for the sake of clearness.**

In the correct adjustment, the regulator is positioned on the straight line between point of pull (preferably the power point of figure 14 at page 37) and point of resistance (line between mould board and share).

The large majority of farmers in Africa dismantle the depth/width adjustment. This means that exclusively the operator does the steering of the plough. This is a hard job and the plough will find its own depth. After a few years a plough-pan is formed which gets harder and more impenetrable each season, and the ploughshare slides on top of this pan.

## 9.2 Ard

The practice of removing organic matter and residues is common, for example by burning or by the grazing of animals. Measures for applying extra organic material, such as green manure and animal dung, are not being exploited in most regions. In that case, inversion of soil may not be desirable as it may increase the rates at which soil moisture is lost and humus is decomposed. Under semi-arid conditions a fine tilth may be dangerously susceptible to erosion. A coarse seedbed preparation, with the ard for example, reduces these erosion risks.

Though ards have been in use for thousands of years, they still are clearly well adapted to many contemporary-farming systems. Among the design features commonly found are:

- the use of a single, symmetrical share set at a fixed angle to the ground;
- use of a long beam (as opposed to a flexible chain) between the body of the implement and the yoke;
- provision of a single handle for control;
- use of materials and construction techniques that allow fabrication by village artisans.

Numerically, ards are the most important animal-drawn implements in the world. An ard plough is symmetrical on either side of its line of draft. As the share and the body of the plough pass through the ground, the soil is fractured and disturbed equally on either side, due to the symmetrical construction.

Some ard ploughs (including *maresha*, figure 35) till a narrow width (5 cm) at a shallow depth (5-15 cm), and are therefore also called scratch ploughs, leaving small and irregular ridges and furrows.

Weed control and seedbed preparation are achieved through a series of cultivation (usually at least three) each at an angle to the others. Weeds are not covered but are generally uprooted and remain with stones and other trash at the surface. In semi-arid areas this may result in quite effective but time-consuming weed control. Assuming an ef-

fective tillage width of 15 cm and three cultivations, it takes 200 km of travel to finish one hectare. On the other hand, low draft makes this type of plough ideal for use with two donkeys.

Other ard ploughs, including some **body** ards and **sole** ards used in India and North Africa, have quite large wooden plough bodies. These follow the steel shares through the earth, breaking up relatively wide tracts of the soil (up to 25 cm), and are therefore also called breaking ploughs (figure 35). Although such ards do not fully invert the soil, they can often be used to systematically plough fields in a single pass. This allows an appropriate seedbed to be rapidly achieved through subsequent harrowing.

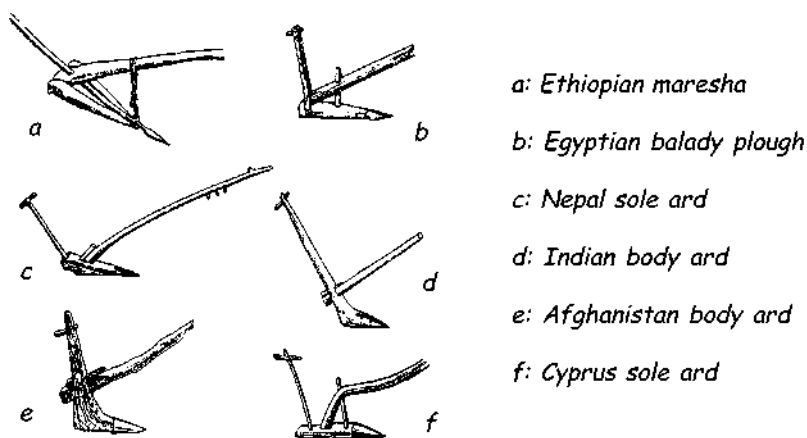


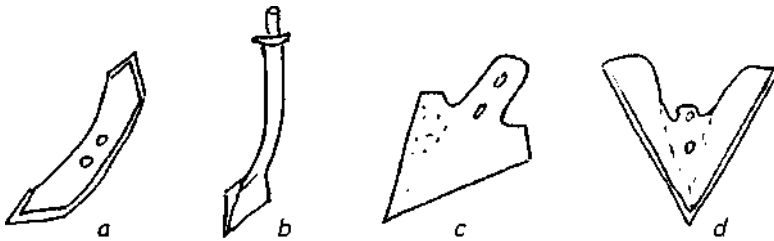
Figure 35: Some ard designs.

Although Ethiopia has the second largest donkey population in the world, estimated to be in the range of four to five million, donkeys are hardly used to pull the maresha. One reason is the type of harnessing required, since the maresha necessitates the use of a yoke. Since the withers yoke is not suitable to donkeys, a dorsal yoke has to be made. An alternative for farmers with donkeys, who like to use ard-like implements, is the use of rippers or chisel ploughs that require the regular breast band or collar harness.

### 9.3 Scarifier

Another practice in semi-arid regions, where heavy weed growth has not developed, is the use of a scarifier. The scarifier is normally equipped with rather light tines made from spring steel. These vibrate, loosening the soil and reducing the risk of damage when encountering obstacles. This implement rapidly opens the land after the first or second rain of the season to improve infiltration of the next rains.

When using a pair of donkeys, only three tines should be attached. One is placed at the front and the other two at the rear of the implement. The appropriate choice must be made according to local field conditions, and it also depends upon the type of point fitted (figure 36).



*Figure 36: Several examples of a scarifier tine: (a) The reversible point for scarifying harder soils. (b) The rigid point. (c) The duck-foot point for scarifying lighter soils and general weeding operations. (d) The sweep used for weeding.*

Under normal conditions, a team of four donkeys can pull a scarifier with five tines. Lateral spacing between each tine must be equal and varies normally between 15 and 20 cm. It is particularly important on an expanding frame such as the Houe Manga that each tine be aligned in the direction of advance (figure 37).





*Figure 37: The Houe Manga in this illustration has the four left-hand tines correctly aligned. The right-hand tine, however, needs adjusting.*

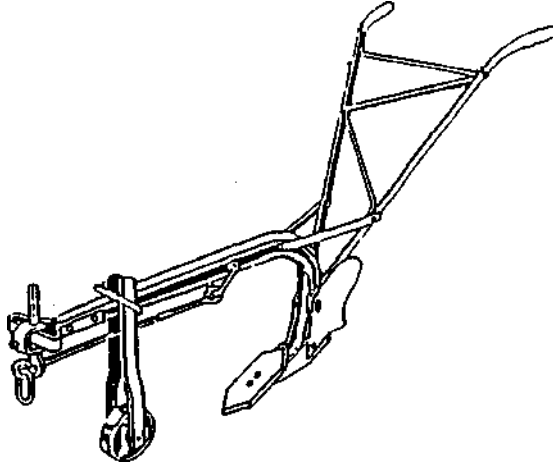
## **9.4 Ripper**

Where the soil is practically free of weeds a ripper can be used to open a narrow band of soil ready for seeding. The rest of the soil is left undisturbed, if possible under a mulch cover to keep that soil cool and moist. The ripping system is not widely used yet, but highly promoted in the interest of soil conservation.

Single, symmetrical, angled tines may be used for tillage in semi-arid conditions. These are mounted onto steel beams or toolbars, as commonly used in sub-Saharan Africa. In Zambia the Magoye ripper was developed as an attachment to a local plough or ridger frame (figure 38). It is recommended for a “breaking” operation to make planting furrows for maize instead of a ploughing operation. On heavy soils this operation should take place right after the onset of rains but on light soils it can even be done before the rains start. Dry soil shatters better and by doing this operation ahead of time, the usual high demand for labour and draft animals at planting time can be decreased.

In fields that have been continuously cultivated either with a hand-hoe or animal drawn plough, a hard layer may have formed hindering

rainwater infiltration and deep rooting. Deeper tillage is then necessary to break the plough pan. The ripper tine can perform this operation after ploughing, but more often a special subsoiler is used or a subsoiler attachment to the common plough. A subsoiler tine is built heavier than a ripper tine and consequently takes more draft force.



*Figure 38: Magoye ripper attachment on plough beam.*

## **9.5 Ridger**

Another fast system of soil cultivation is ridging. Ridging ploughs are symmetrical around their line of draft and the two mould boards turn soil to both sides (figure 39). In each pass through the soil a ridger makes one furrow and two small ridges. In normal use the furrows are so spaced that two small ridges are combined to make one larger one. Alternatively a ridger attachment is added to a common plough. Ridging will generally take only 35 to 50% of the time needed to plough, which is valued by farmers in low and medium rainfall areas. This is due both to the wide working width, and the fact that not all the land is tilled. The soil under the ridges is not disturbed.

Ridging, as a method of cultivation, developed in many African countries before animal traction was introduced. Its rapid and superficial manner of working very light soils is highly prized.

When using a properly designed ridger for direct ridging on soils where also ploughing can be done effectively, the draft requirements for these two operations will be comparable. In heavy soils however, direct ridging could lead to the formation of large aggregates that could hamper seed germination. In those conditions soil may have to be broken first with tines or a mouldboard plough and ridging becomes a secondary tillage operation, as will be discussed in Section 10.1.

Permanent ridges may lead to the development of hard layers of soil that are difficult for roots to penetrate. Even on light soils this can lead to yield reductions and increased competition by weeds. The best application of direct ridging seems to be in rotation with normal ploughing: a field that is directly ridged one year should be ploughed the following year and could be directly ridged again the third year. Consequently, direct ridging cannot replace ploughing altogether.



*Figure 39: "Inkunki" high wing ridger, manufactured in Zimbabwe.*

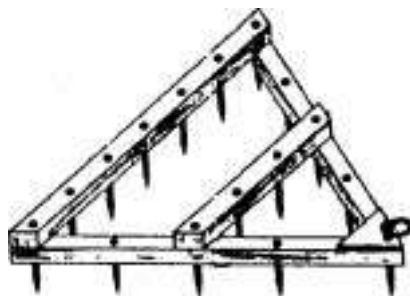
# 10 Equipment for crop husbandry

Secondary cultivation is aimed at both reducing the clod size and levelling the soil surface or forming it into the required shape by ridging.

## 10.1 Secondary tillage

### Harrow

A harrow may be as simple as a few tree branches or a wooden plank or a log, weighted down with stones or the weight of the operator and pulled across the field by the animals. However, this method of harrowing is not recommended. A common harrow consists of a wooden frame with 15 to 20 metal spikes, which breaks the clods, mixes the soil and helps to level the surface. The



*Figure 40: Sketch of a simple wooden spike tooth harrow.*

The spikes should be able to penetrate down to a depth of between 5 and 8 cm (figure 40). Excessive pulverising of the soil should be avoided as the surface will then become vulnerable to wind erosion and some soil types will later form hard crusts after rain.

The correct hitching is very important to achieve best results. The size of the animals and length of the pull chain affect the way in which the harrow floats across the surface. The implement should be one metre behind the animals hooves and remain level during the work. Excessive surface vegetation will block the tines and greatly reduce penetration. It is therefore important to correctly plough the field and to invert the soil properly beforehand.

## Ridger

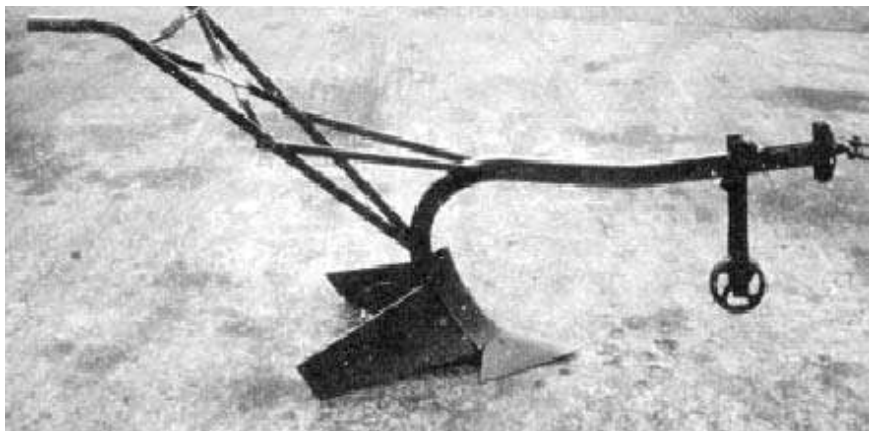
The ridger is normally used as a secondary cultivation implement after ploughing or breaking the soil. Ridges channel and collect water in the furrow and should therefore be made along contours of sloping land to limit run-off during heavy storms. If a subsoiler or a ripper-ridger combination is used prior to ridging, the run-off risk is further reduced as the rainwater quickly infiltrates in the soil before it does any damage.

On flatter land, tied ridges may assist in retaining rainwater (water harvesting). The ties can be made with either a hand hoe, by simply lifting an animal-drawn ridge-tying implement every few metres (figure 41) or with a special ridge-tying device attached to the ridger. However, the tied ridges can pose an obstacle for later inter-row weeding operations with animals.



*Figure 41: An operator lifts a ridge-tying implement to form a ridge-tie. This “Unibar” multipurpose toolbar fitted with the ridge-tier is used in The Gambia.*

Ridging requires a longer evener when two donkeys are used, or two such eveners when four donkeys are needed. With the standard size, the donkeys would have to walk on the ridges. This can be avoided by using a longer evener with a space between the attachment points of the swingles that is twice the inter-ridge spacing. If two donkeys are sufficient, they may be hitched in tandem, see figure 25A.



*Figure 42: The Agrimal ridging plough weighs 44 kg; the wings are adjustable.*

## **10.2 Equipment for sowing**

Normally, there will be a recommended row width for the crop to be sown in a particular area. Therefore the minimum working width of the animal-drawn cultivator should be studied. This implement cannot be applied if row widths are less than about 45 cm, without causing excessive damage to the crop. If weeding with donkeys hitched in tandem is planned, the row width should be at least 60 cm and preferably 75 cm or 90 cm.

### **Sowing methods**

The traditional manual techniques for sowing are broadcasting, dibbling and drilling. Animal-drawn seeders can replace these techniques.

The objective of a seeder is to obtain accurate and reliable seed placement conveniently and at an acceptable cost.

**Broadcasting** involves the scattering of seeds over the soil surface followed by some mixing with the topsoil. This is the major method of sowing grasses and small cereals such as wheat, teff and rice. Once seed is distributed in this way, plants will come up in a random pattern instead of in evenly spaced rows. Hence, further animal traction operations are virtually impossible without damaging the crop. Because of the narrow row spacing, animal-drawn multi-row seeders may replace hand scattering, but these are expensive and require ideal working conditions.

**Dibbling** involves the use of a simple hoe or stick to make holes into which seeds are dropped. The holes are then covered with soil. Animal-drawn single-row seeders can replace the manual work. However, seeders are designed for uniform areas and farmers' fields can be highly variable. With hand dibbling a skilled farmer can adjust population density very accurately to the soil characteristics within a field.

**Drilling** is the process of making a narrow furrow into which seeds are placed at regular intervals after which the furrow is covered with topsoil and loosely compressed. Most animal drawn seeders are based on this principle, and have a *furrow opener* that penetrates the soil to the required depth, a *metering mechanism* that determines the seed rate, and some form of *seed tube* that transports the seed to the furrow. There is generally some system for *covering the seeds* in the furrow and for *tamping the soil lightly*. A simple sowing system combines some of these functions while an elaborate one combines all.

Row seeding can already be achieved using a ploughshare or an ard as a furrow opener and hand metering while dropping the seeds into the furrow. If furrow depth is not constant there will be some wastage of seed. The problem of accurately aiming the dropped seeds can be overcome by the provision of a plastic seed tube that drops the seed behind the plough (figure 43).

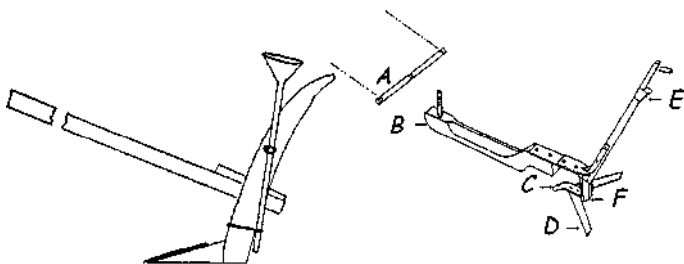


Figure 43: Simple hand-metered tube seeders. “Nan” single-row seeder used in India (left) and a simple seeder-weeder developed in Sudan (right).

A: traces to donkey; B: wooden ground beam; C: chisel point; D: sweep; E: seed chute; F: seed box.

This simple design can be adapted into a two, three or four row seeder. The seeds are hand-metered into a small wooden bowl and pass down plastic tubes to simple furrow openers. A second bowl and series of tubes can be used to make the implement into a combined seeder and fertiliser distributor. Such seeders are commonly used in India. However, for unknown reasons, they are not common in Africa.

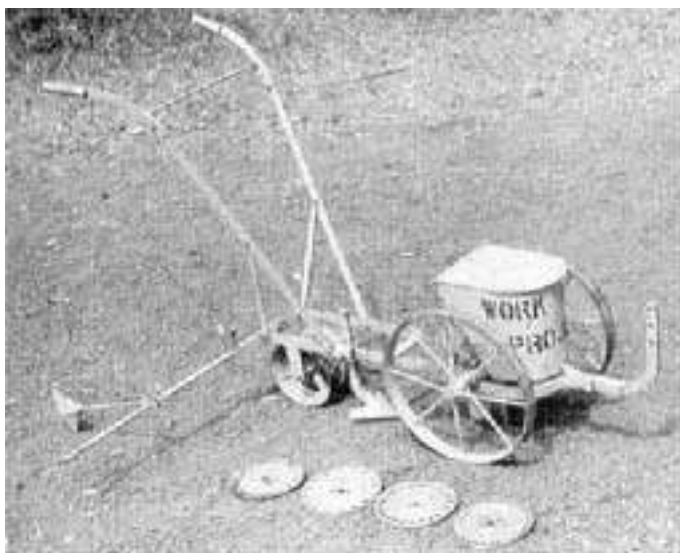
An innovation from Zambia has been accepted rapidly in eastern and southern Africa. A **simple precision seeder** is mounted on a plough-beam. A double ground wheel drives a wooden metering roller. As the implement moves forward, the roller rotates and seeds coming from the hopper drop into holes of the roller and are transferred to the seed tube. Seed rate is determined by an adjustable opening at the bottom of the seed hopper and spacing depends on the shape of the roller. Different rollers are used for different crops (figure 44).



Figure 44: Ripper-planter attachment to the common plough.



**More complex seeders** involve a mechanism that takes power from the ground wheel(s) and drives metering plates, such as the *Super Eco* seeder (figure 45). The number of holes in a plate determines inter-plant spacing and seed plates with different sizes and patterns of holes are available for maize, sorghum, millet, groundnuts, cowpeas and rice. They are used for direct planting in very light soils. Since the number of days a year suitable for planting are few in these semi-arid areas, there is no time wasted on conventional seedbed preparation.



*Figure 45: Super-Eco seeder with various distribution plates and the next-row marker extended.*

A simple aspect of the design is the “next-furrow” marker. This is a bar that draws a line on the ground parallel to the furrow being created. This mark is then followed on the next pass to ensure all rows have constant inter-row spacing.

### 10.3 Equipment for inter-row weeding

An example of animal-drawn weeding equipment is the **Arara cultivator**. The multi-purpose beam of the Arara-type implement may be fitted with either three or five spring tines for weeding between rows. To fit all five tines, the wide crossbeam of 70 cm is clamped half way along the main beam. When working with only three tines, the wide crossbeam is omitted, see figure 46.

The draft of cultivators will depend on soil characteristics and the depth and width of working. Under the worst conditions the draft of a three-tine cultivator may be similar to that of a 20-cm mouldboard plough. Unless soil conditions are very light, cultivators fitted with five duck-foot tines are likely to prove too heavy for a pair of donkeys or light oxen. Three duck-foot tines may be preferred.

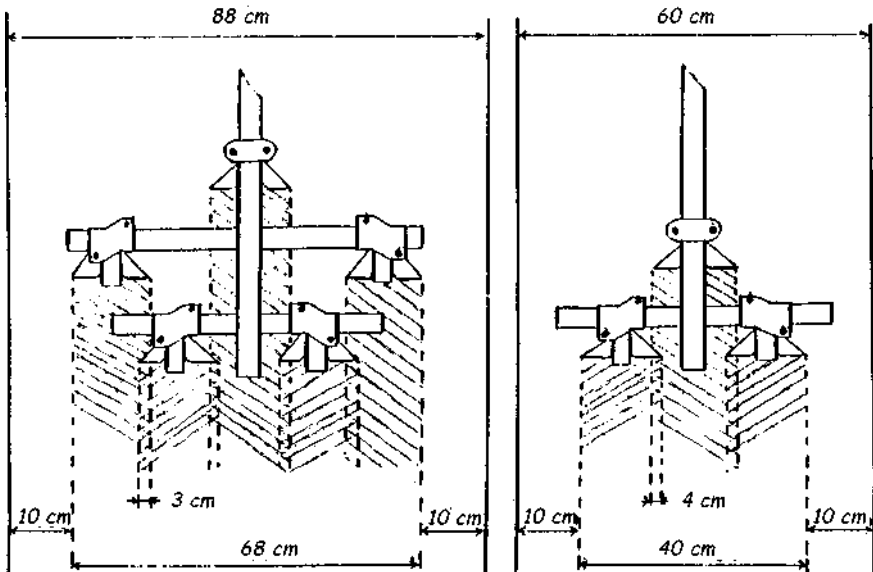


Figure 46: Arrangement for five tines (left) and three tines (right) to work with a single pass in row widths of 90 and 60 cm respectively.

Normally when working with a pair of animals, an evener length equal to double the row width should be chosen and the implement pulled from the centre. Weeding is then carried out in a single pass. When the crop becomes too tall for an evener, tandem hitching becomes necessary.

Minor adjustments can be made with a horizontal regulator of most implements so that the cultivator follows in an offset position. This may be necessary when the row spacing is wider than the working width of the cultivator. In that case the cultivator has to start at one side of the inter-row. Once the first run along all rows has been completed, a second run is made along the same rows with the cultivator offset to the other side so that the complete inter-row space is weeded (figure 47).

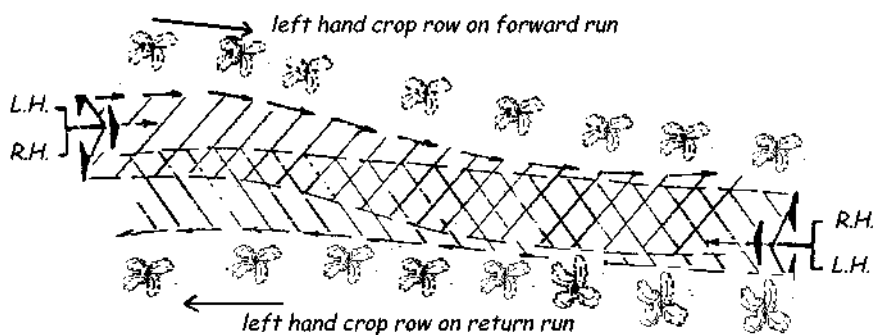


Figure 47: Illustration of the “double run” method of weeding widely or unevenly spaced rows with a small weeder.

# 11 Maintenance of farming equipment

Equipment for arable farming needs regular maintenance to ensure long-lasting and reliable functioning. For donkey traction, but also for other power sources, the following routines are recommended for proper maintenance.

## 11.1 Daily maintenance and inspections

- Scrape off the soil while still in the field.
- When returned to the farm, thoroughly clean the implement, so that a detailed inspection can be made of all parts.
- Check the tightness of all nuts and bolts with the correct spanner; never use a wrench or pair of pliers.
- Make sure that bolts and nuts used for field adjustments can be turned freely; oil them if necessary.
- Check the condition of the wearing parts and plan to replace them whenever necessary or advised.
- Check the implement for distortion. Redress any bent parts or send them for repair.
- Maintain working parts in a polished condition to stop the onset of rust and to reduce unnecessarily high draft forces when the implement is returned to work. Wipe all working surfaces with a rag soaked in oil.

Rains or the delayed onset of rains may halt tillage or cultivation for several days. Such a period of rest allows for completing repairs.

## 11.2 Maintenance at the end of the season

Follow the normal daily maintenance schedule. This will allow identification of all worn parts and damaged nuts and bolts. Take advantage of the end of the season to carry out a general overhaul:

- Completely dismantle the main components of the implement.

- Repair or replace the parts as required.
- Clean the components thoroughly, remove any rust and if necessary, repaint them. Alternatively, protect them by wiping them with an oil-soaked rag.
- Do not paint, however, the working surfaces. These should just be wiped with oil.
- Replace all damaged nuts and bolts, again wiping them with oil on assembly.
- Reassemble the implement and make sure it has all been wiped with oil.
- Store it in a safe, dry place and away from animals, sacks of grain and any stored fertiliser.

## Further reading

Aeschlimann M. & D. Austbo. **Donkey harness with straight hames**. 2000. Draught Animal News, No.32, CTVM, University of Edinburgh, UK. ISSN 1354-6953.

Dibbits H.J. **Harnessing guidelines for donkeys pulling a single donkey cart**. 1995. IMAG-DLO, Wageningen, The Netherlands.

FAO. **Draught Animal Power Manual**. 1994. Food and Agricultural Organization of the United Nations, Rome, Italy. No ISBN number.

Fielding D. and P. Krause. **Donkeys**. 1998. The Tropical Agriculturist series, CTA & Macmillan Education Ltd. ISBN 0-333-62750-4.

Fielding D. and R.A. Pearson. **Donkeys, mules and horses in tropical agricultural development**. 1991.C.T.V.M., University of Edinburgh, Great Britain. ISBN 0-907-14606-6

IMAG-DLO. **IMAG-DLO and conservation tillage: Activities and Experiences**. 1999. Wageningen, The Netherlands. No ISBN number.

Jones P.A. **Donkeys for development**. 1997. Pretoria: Animal Traction Network of Eastern and Southern Africa and Agricultural Research Council of South Africa Institute for Agricultural Engineering (ARC/IAE). ISBN 0-620-22177-1.

Kaoma-Sprenkels C. et al. **IMAG-DLO and conservation tillage: Activities and Experiences**. 1998. Wageningen, The Netherlands.

Oudman L. **Draft animal technology course for B.Sc. Agricultural Engineering**. 1997. 8141 MP 10A Heino, The Netherlands.

Palabana. **Final report on the comparative testing of ox-drawn mouldboard ploughs 1988-1991**. 1993. Palabana ADP Development Programme, Zambia.

RTS. **Donkey harnessing pamphlet**. Rural Technology Section, Institute of Agricultural Engineering, P.O. Box BW 330, Borrowdale, Harare, Zimbabwe

Starkey P. **Harnessing and Implements for Animal Traction.** 1989.  
GATE/GTZ, Eschborn, FRG. ISBN 3-528-02053-9.

Starkey P. et al. **Improving Animal Traction Technology.** 1994.  
CTA/GTZ, Wageningen, The Netherlands. ISBN 92-9081-127-7

# Useful addresses

JuanCarlos.Chirgwin@fao.org

For all information concerning "Draught Animal Power Manual"  
asstute@lantic.net

Dr. Peta Jones, author of "Donkeys for Development"  
KENDAT@africaonline.co.ke

Dr. Pascal G. Kaumbutho, Chairman of Kenya Network of Draught  
Animal Technology (KENDAT) and Chairman of Animal Traction  
Network for Eastern and Southern Africa (ATNESA)  
<http://www.ATNESA.org>  
website of ATNESA

anne.pearson@ed.ac.uk

Dr. R.A. Pearson, Editor Draught Animal News  
sanat@agric.ufh.ac.za

South African Network of Animal Traction (SANAT)  
P.H. Starkey@Reading.ac.uk  
Prof. Paul Starkey, Animal Traction Development



**Rumptstad ATM**, member of the NETAGCO group, is a specialist in the supply, and/or transfer of know-how of:

➤ Animal drawn equipment

Because of its vast amount of know-how and experience of soil tillage and local manufacturing of agricultural machinery, Rumptstad has proved to be a welcome and reliable partner. Rumptstad can offer its partners - large or small farmers, co-operatives or village blacksmiths - an extensive range of necessary facilities, for the manufacture of agricultural machinery. With the help of these facilities, our partners are



able to manufacture or use a comprehensive series of modern agricultural implements suited to local demands and circumstances.

These facilities include extensive management support and the transfer of technical knowledge, which provides Rumpstad's partners with expertise in the techniques of hardening and forging special high tensile steel. The application of this expertise makes it possible to substantially extend the working life of parts subjected to heavy wear and tear. Furthermore, Rumpstad can supply its partners with welding fixtures, which guarantee a high uniform quality of production.

- There are various methods of co-operation between Rumpstad and its partner organisations and companies mainly in Africa and South-America. Not only can Rumpstad provide training and education but also, if required, advice on how to set up workshops and factories. Rumpstad supplies many partners with raw materials, semi-manufactured products, tools and machinery.
- Village water-supply
- Training centres
- Coffee processing equipment
- Village Cotton Ginning
- Two-wheel tractors

Trade activities:

Thanks to the extensive agent network in Africa, Latin America and parts of Asia and the existing logistical know how, Rumpstad supplies high quality goods all over the world in a minimum of time. For international organisations such as FAO, EuronAid, UNOPS and a lot of NGO's Rumpstad is a reliable supplier of agricultural hand tools, tractors, trailers, generator sets and other technical items.

Rumpstad Agricultural Tropical Machinery B.V.

P.O. Box 1521

3260 BA Oud-Beijerland

The Netherlands

Tel : +31 186 622200

Fax : +31 186 610123

E-mail : [rsatm@netagco.com](mailto:rsatm@netagco.com)

# Glossary

<b>Arara</b>	a multipurpose toolbar manufactured in Benin, Niger, France and elsewhere.
<b>Ard</b>	a plough which shatters soil without inverting, usually of traditional wooden design.
<b>Breast-band harness</b>	a breast strap positioned across the breast and supported by one or two straps; the first one passes over the withers and the second one over the back.
<b>Breeching</b>	the strap that passes around the hindquarters of the harnessed animal and transmits a reverse draught to the cart. Used for braking and reversing.
<b>Bridle</b>	straps around head of an animal to which reins are attached for controlling head.
<b>Cart</b>	a type of two-wheeled, animal-drawn vehicle. The draught animal acts as the third support to balance the load and it is very important to accommodate this in the harness.
<b>Collar harness</b>	a padded collar positioned around the neck; traction is transferred from the shoulders through rigid hames and traces.
<b>Dorsal yoke</b>	a yoke positioned on the back, preferably immediately behind the withers.
<b>Evener</b>	a wooden pole to which the swingles of multiple animals attach to balance the pull from each animal.
<b>Equine</b>	any member of the family which includes donkeys, horses and zebras and also the hybrids: mules and hinnies.
<b>False breeching</b>	wide strap between the shafts of a cart right behind the animal.
<b>Gelding</b>	castrated male donkey (or horse).

<b>Girth</b>	circumference of animal's body; also strap under equine belly connecting both sides of saddle.
<b>Grooming</b>	keeping coat clean and in good condition.
<b>Halter straps</b>	or cords around head of animal which can be pulled by hand, rope or rein to control its head.
<b>Harness</b>	the whole power transmission system attaching the animal to its work load.
<b>Harrow</b>	a wooden frame with 15 to 20 metal spikes to break soil clods and to level the surface.
<b>Hinny</b>	cross between male horse and female donkey.
<b>Houe-Manga</b>	a design of small cultivator/weeder with adjustable width settings manufactured in West Africa that can be used with single donkeys.
<b>Jack</b>	adult male donkey or mule.
<b>Jenny</b>	female donkey (also called Jennet).
<b>Mouldboard plough</b>	a plough with a shaped piece of metal which diverts and inverts the soil.
<b>Momentum</b>	quantity of motion of a moving body (product of mass and its velocity).
<b>Mule</b>	cross between male donkey and female horse.
<b>Ox cart</b>	a large, heavy animal-drawn cart with a carrying capacity of about one ton or more. Fitted with one draft pole.
<b>Packing</b>	placing a load on to the back of an animal for it to transport
<b>Pliers</b>	gripping tool with parallel flat surfaces for holding small objects, bending wire, etc.
<b>Rein</b>	strap held in hand of rider or driver and attached to a bridle or halter for controlling an animal's head.
<b>Ridger</b>	a plough with two mouldboards to make a furrow and two small ridges on either side.
<b>Ripper</b>	a toolbar or plow-frame with a single angled tine used for opening a narrow band of soil for direct seeding; also called chisel-plow.

<b>Saddle</b>	wide strap across equine back for taking load.
<b>Scarifier</b>	a cultivator with rather light tines made from spring steel.
<b>Shaft</b>	one of pair of draft poles between which animal is harnessed to cart.
<b>Spanner</b>	tool for turning nut on bolt.
<b>Stub axle</b>	short axle to which a wheel is attached in a car with front-wheel-drive.
<b>Subsoiler</b>	a heavy angled tine attached to a plough-frame or toolbar for the purpose of breaking up hard underground layers.
<b>Super Eco</b>	a design of seeder manufactured in Senegal and widely used in West Africa.
<b>Swingle</b>	a wooden pole to which the traces attach at each end and the work load attaches at the center. This allows the harness to move with the shoulders, so reducing rubbing.
<b>Tandem</b>	one in front of the other, connected.
<b>Tillage</b>	preparation of land for crop-bearing.
<b>Tines</b>	the soil-contacting descending bars of a cultivator or teeth of a harrow.
<b>Traces</b>	the chains or ropes used to transmit the draft force from the collar or breast-band harness to the work load.
<b>Wagon</b>	an agricultural or freight vehicle with four wheels.
<b>Withers</b>	part of equine just behind where the neck joins its back .
<b>Withers yoke</b>	a yoke positioned on the withers; often called neck yoke.
<b>Wrench</b>	hand tool for holding parts in a tight grip; not suitable for turning nuts.
<b>Yoke</b>	strong bar, usually made of wood, which an animal can push against in order to pull an implement.
<b>Zebu</b>	type of <i>Bos indicus</i> humped cattle.