

Rechargeable Alkaline Manganese Dioxide (RAM™) Cell Chemistry

Dr. Josef Daniel-Ivad
Battery Technologies Inc.

30 Pollard St., Richmond Hill, Ontario, Canada L4B 1C3
Phone: (905) 881-5100; Fax: (905) 881-6043; e-mail: josef@bti.ca

ABSTRACT

The continuous growth of portable applications in the consumer market demands more and more battery power. Battery chemistries such as nickel-cadmium, nickel-metal hydride, lithium-ion and alkaline manganese are available to serve the various market needs. This paper discusses the low-cost RAM battery system that is a potential power source for a variety of consumer applications. RAM's performance characteristics are compared to competing rechargeable battery systems as well as primary alkaline cells. Advantages of improved charge retention at higher operating temperatures and in intermittent use are discussed and possible solutions for OEM (Original Equipment Manufacturing) applications are offered.

INTRODUCTION

BTI's proprietary RAM technology is available through BTI's licensees. Rayovac Corporation manufactures under their trademark *RENEWAL™* in the United States (1993), Pure Energy Battery Corporation (*PURE ENERGY™*) in Canada (1994), Young Poong Corporation (*ALCAVA™*) in South Korea (1998) and Grand Batteries Technologies *GRAND-CELL™* in Malaysia (1998).

CONSTRUCTION OF RAM CELLS

Figure 1 shows a cross sectional view of a RAM AA cell, which is in principle not different from the construction of a single-use primary alkaline cell. The positive electrode consists of multiple cathode rings (pellets) formulated from electrolytic manganese dioxide, graphite and additives.¹ Gelled zinc anodes for RAM are prepared from atomized zinc powders using a BTI proprietary method that involves deposition of indium on the zinc particle surfaces.² Special separators with a microporous layer are required to prevent internal shorting from zinc dendrites (a needle like buildup) formation on recharge. A brass nail functions as negative current collector. The active materials are chosen so that the zinc electrode is limiting the capacity of the cell to the one-electron discharge of manganese dioxide.

This basic construction allows applying the same low-cost manufacturing principles than single-use primary alkaline batteries do. The production cost of RAM cells is by far the lowest amongst all other rechargeable small format cells. A relative manufacturing cost comparison will result in the following approx. multiples:

- NiCad.....3 times RAM
- NiMH.....5 times RAM
- Li-Ion.....10-12 times RAM

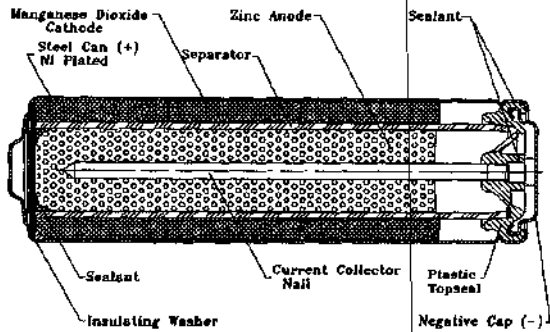

Figure 1: Cross sectional view of a RAM AA cell.

DISCUSSION

RAM cells are available in the 4 major cylindrical cell sizes AAA, AA, C and D. However, AA and AAA are the predominant cell sizes with a market share of approx. 85% and the rest is shared by C and D cells.

RAM Cell Performance

RAM cells can be basically applied in all applications where presently single-use primary cells, zinc-carbon and alkaline, are being used. They can also replace NiCad and NiMH rechargeables, provided they fall within a practical drain rate range as described below. Figure 2 shows that the ampere-hour (Ah) capacity of RAM cells increases with decreasing current rate and in intermittent use. RAM cells have a sloping discharge curve at all current rates as shown in figure 3. This provides a warning that cells need charging, e.g., by distorted sound, slower motor speed, dimmer light, etc. It also permits the use of simple low-battery warning circuitry. From figure 3, one can determine the approximate percentage useable capacity for AA RAM cells based on the cut-off (end point) voltage of the device. This parameter is important for battery appli-

cations with more cells in series. In order to maximize capacity utilization one should use this parameter to decide on the number of cells in the series configuration. For optimum performance, it is better to allow a 0.9V to 0.8V cut-off level on a per cell basis.

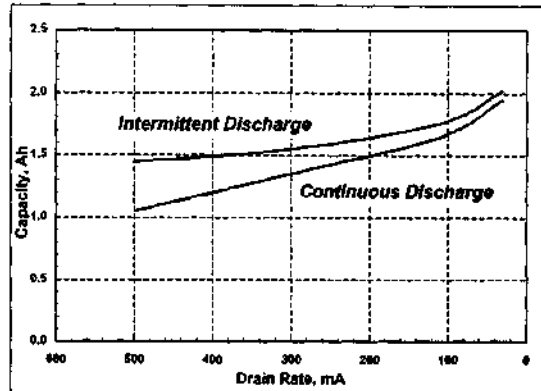

Figure 2: Initial Capacity of RAM AA Cells as Function of Discharge Rate.

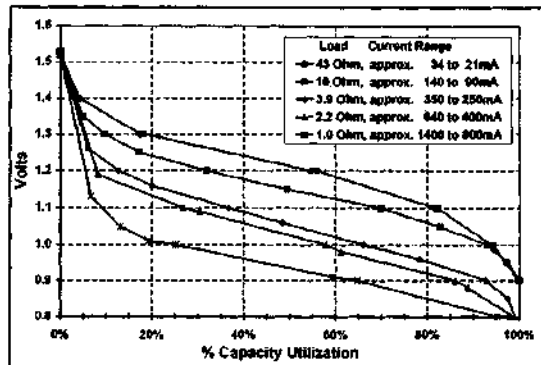

Figure 3: Deep Discharge Voltage Profiles for Various Test Loads at Room Temperature.

Figure 4 illustrates a comparison of discharge voltage profiles of different battery chemistries. As one can see, RAM cells perform at a slightly lower operating voltage as primary cells and quite comparable to NiCad and NiMH cells in the middle discharge region with a much improved capacity over NiCad and NiMH in the voltage range of 1.1 to 0.9V. Figure 5

demonstrates that RAM cells can be cycled many hundred times when not all of the capacity is removed in each and every cycle. This mode of cycling is the most efficient mode, providing the greatest cumulative capacity or cell life. In shallow discharge cycling cumulative performance of RAM over 200 cycles can reach 50 times the performance of Single-Use Alkaline cells!

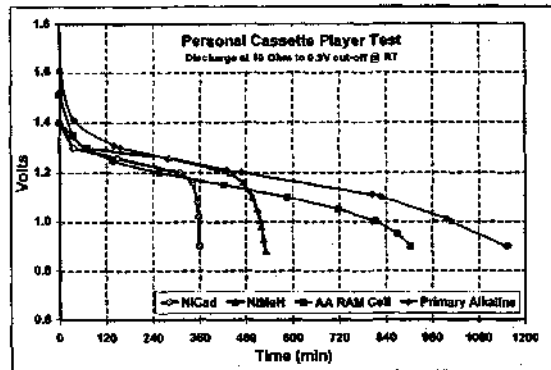

Figure 4: Comparison of Discharge Voltage Profiles for NiCad, NiMH, RAM and Primary Alkaline chemistry.

The discharge time and capacity of RAM cells decreases or fades with increasing number of discharge/charge cycles under deep discharge conditions, that is when all of the capacity is removed in each and every cycle. Under such, not recommended, operating conditions the capacity of a RAM cells reduces to approx. 40% of its initial value in cycle 25, to approx. 30% in cycle 50 and 25% in cycle 100.

As shown in Table 4, RAM cells exhibit very low self-discharge compared to Nickel-Cadmium, Nickel-Metal Hydride and Lithium-Ion systems. At higher temperatures the benefit of RAM cells is even more pronounced.³ For example, RAM cells lose only approximately 5% capacity per month at 45C, whereas NiCad lose 60%, NiMH 80% and Li-Ion 30-50%. Therefore, RAM cells are the ideal choice

for intermittent or periodic use without the need to recharge before using, even in hot climatic conditions.

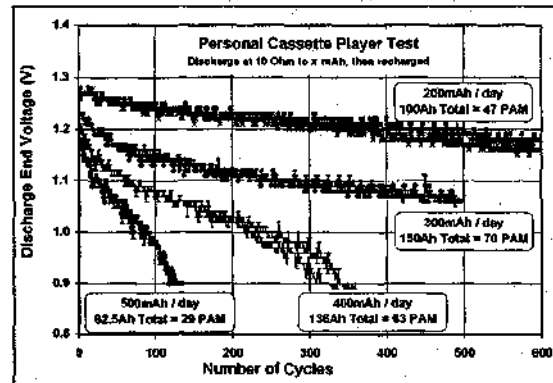

Figure 5: Cycle Life of RAM AA Cells on Various Endurance Tests

Table 4: Self-Discharge Comparison of Various Battery Chemistries.

Characteristic	NiCd	NiMH	Li-Ion	RAM
Specific Energy, [Wh/kg]	50	70	125	79 [*]
Energy Density, [Wh/liter]	150	250	300	222 [*]
Self-Discharge@ 20°C, [%/month]	15-20	20-30	8-15	1
Self-Discharge@ 45°C, [%/month]	60	80	30-50	5
Self-Discharge@ 65°C, [%/month]	100	100	Note1	20

^{*}) Initial capacity of AA-size cells calculated from averaging results of 43, 10, 3.9 and 2.2 ohm tests.

Note1: Li-Ion cells experience irreversible capacity losses of approx. 10%/week at temperatures of 60°C and higher. In addition, there is no "generic" Li-Ion chemistry available and results between different manufacturers will vary.

All tests measuring self-discharge typically involve storage at high temperature and capacity measurements at room temperature. High temperature performance of RAM has been studied at elevated temperatures of 45 and 65°C, whereby discharge and charge were performed at the elevated temperatures.

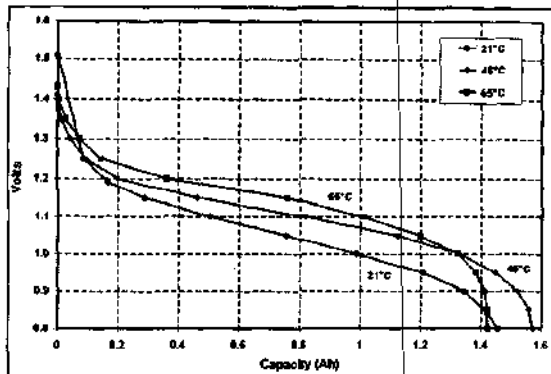

Figure 6: Discharge Profiles of RAM AA Cells at Different Temperatures for a 3.9 Ohm Load.

Figure 6 shows the discharge voltage profiles for RAM cells tested at 21, 45 and 65°C. As one can see, the operating voltage at higher temperatures actually increases, due to the lower resistance at higher temperatures, resulting in a reliable operation of any equipment. Figure 8 illustrates the capacity evolution of RAM AA cells when cycled at 45°C in comparison to room temperature performance. Unlike NiCd and NiMH cells, which rapidly lose capacity at higher temperatures, a performance gain of up to 30% is achieved at high temperature for RAM cells, making the system an ideal choice where reliability at higher temperatures, e.g. desert conditions, is of essence.

RAM Cell Charging

RAM cells are charged by means of voltage-controlled charging to avoid overcharging. Typically, the discharged cells are removed from the battery-operated device and placed in an approved RAM charger where the cell terminals make proper contact for charging.

The cells are usually charged in parallel. Constant voltage chargers perform such that the charging current tapers off to a trickle as the 1.65 ± 0.05 volt maximum is

reached, but not exceeded. Charging times are up to overnight, depending on cell size and the depth of the preceding discharge. Pulse chargers with microchip charge control charge at a higher rate but stop when cells are fully charged. Charging times range from 2 to 8 hours, depending on cell size and the depth of the preceding discharge. Figure 8 shows a typical average voltage and current response of RAM cells for pulse charging.

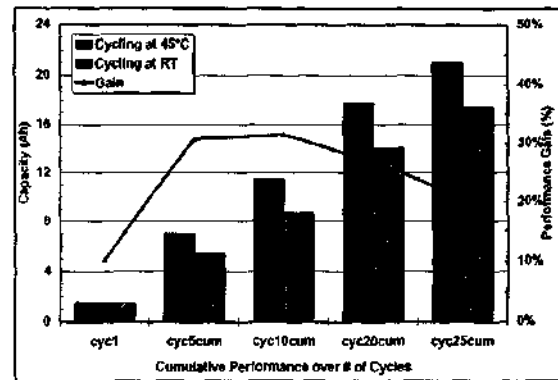

Figure 7: Cumulative Capacity of RAM AA Cells during Cycling at 21 and 45°C for a 3.9 Ohm Load.

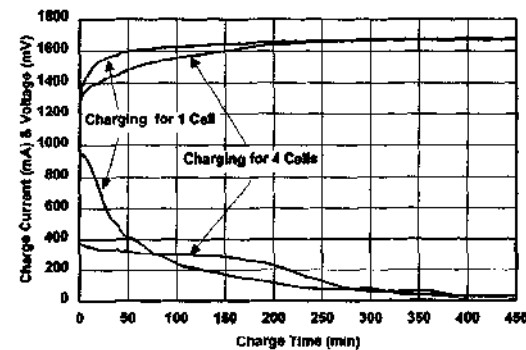

Figure 8: Typical Pulse Charge Curves of RAM AA Cells in a 4-Up Pulse Charger.

OEM applications require built-in chargers to enable recharging of the battery pack in the battery-operated device, usually in series. For series arrangements of 3 or more cells, in order to avoid overcharging and facilitate equalization, spe-

cial circuits are required to provide overflow of charging current to individual cells. Also recommended for these series arrangements is the use of diodes to protect individual cells against deep voltage reversal. A large breakthrough in application possibilities was achieved by using various very low-cost semiconductor devices (diodes, LED's and transistors) as charge overflow control, charge equalization and over-discharge preventing means in series connected cell arrangements. Also, damaging cell reversal in multi-cell strings (e.g. if forgotten on load) is greatly alleviated that way. Now RAM cells can be used in many OEM applications and do not have to be removed for charging, as was practiced before. Simply described, a battery package containing these devices behaves like a NiCad battery and can be charged with a limited constant current from a transformer plus rectifier, without sophisticated voltage controls.^{4,5}

Many portable applications/devices such as portable radios, cassette players, CD players, cordless phones, to name a few, may require only two or three cells in series to operate. Applications of this type can be easily adapted to allow for in-application charging of RAM cells in a battery pack arrangement by means of one Zener diode. Figure 9 shows the circuit for replacing 3 N-270 AA Ni-Cd battery in cordless phones with a RAM battery pack consisting of 3 AAA RAM cells in series (e.g. SANYO Componders II). If a requirement exist for individual cell removal capability, a somewhat different low-cost circuit approach can be applied, utilizing a Darlington transistor for switching off the diode circuits to prevent self-discharge on stand-by.⁶ A diode and a Darlington transistor in series determine the overflow voltage. The diode and the

transistor act like 2 diodes in series (1.65V drop) and allow a high current flow. The circuit is switched off by the transistor as soon as the charger is off, preventing self discharge. Figure 10 presents such a circuit for a 3-in-series application. The diodes can be high current diodes and used as charge equalizing devices for any number of RAM cells in series ranging from 6 to 30 V and up to 5 Ampere charge current. Utilizing these simple design principles for in-application charging of RAM batteries will ensure that the RAM system becomes a major player for many OEM applications in the future.

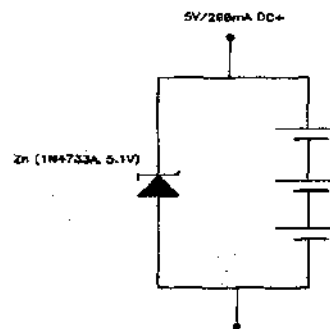

Figure 9: The 3-cell cordless phone circuit with Zener diode overcharge protection.

In addition to the low cost approaches described above, BENCHMARK Microelectronics Inc. has developed chips for in-system charging of RAM cells. Presently, a two cell in-series (bq2902) and a three or four cell in-series (bq2903) RAM control chip is available that controls the charge and also the depth of discharge.

The excellent high temperature charge retention and charge acceptance of RAM cells allows an effective use of solar energy for recharge. The solar charging of NiCad and NiMeH cells is not very successful due to the poor high temperature charge retention of these battery chemistries.

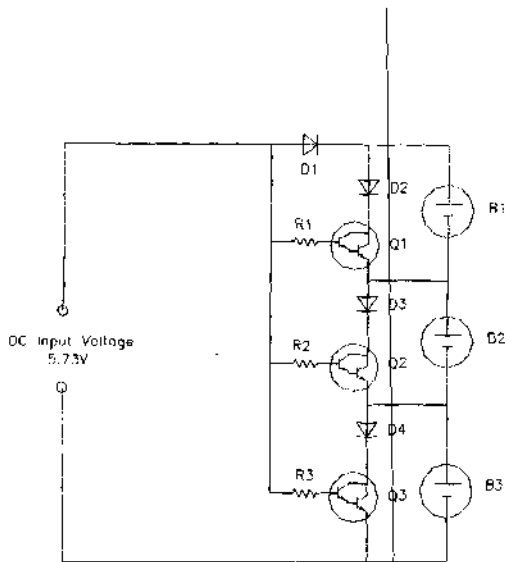

Figure 10: 3-cell Circuit for In-Application Charging of RAM with Individual Cell Equalization. D1:1N4001, D2-D4:1N4448, Q1-Q4:BC517, R1: 68K, 0.5W, R2:180K, 0.5W, R3: 300K, 0.5W, B1-B3: RAM Cells

RAM in High-Drain Devices

A trend in the electronic device market over the last two years resulted in the development and implementation of high rate primary alkaline cells by various battery manufacturers. New, high-tech devices introduced to the market place require more and more power to operate. In other words, these devices "eat up" batteries like crazy due to the short life of regular alkaline cells. High-tech devices are defined as complex, multi-functional devices often requiring higher operating voltages and higher drain rates. This category includes such devices as: cellular telephones; digital and flash cameras; camcorders; MiniDisc players; handheld televisions; radio control toys; halogen flashlights; palmtop computers; and personal digital assistants (PDAs).

In an effort to stay abreast with the new requirements of the market, BTI launched their own R&D program to develop a special high-rate (HR) RAM cell, that would

work satisfactorily in this high drain device market. Initial results of this work are very promising and resulted in a HR RAM prototype cell which can already compete with regular alkaline cells on high rate tests. Figure 11 illustrates the present capability of HR-RAM cell prototypes in comparison to regular RAM cells and regular primary alkaline cells on a very severe continuous high-rate current drain of 1500 mA. As one can see, HR RAM cells provide equivalent capacity to regular alkaline cell at a somewhat lower operating voltage.

Manufacturer's of high-rate primary alkalines claim up to 50% improvement under certain high drain test conditions compared to regular primaries. Results on HR RAM would show in the excess of 50% improvement compared to regular RAM cells on the same test. The high-rate RAM project will be continued at BTI and further improvements are anticipated. We have already identified a number of additional improvement categories in the lab that all will lower the internal resistance of RAM and thereby increase high-rate performance.

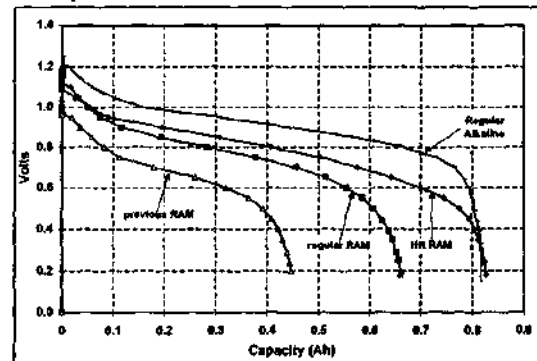

Figure 11: Initial Capacity of HR-RAM cell prototypes in comparison to regular RAM cells and regular primary alkaline cells at a high-rate current of 1500 mA.

CONCLUSION

The RAM Technology offers an environmentally responsible, low cost rechargeable battery system that can be utilized for practically all applications where Single-Use cells (alkaline manganese, zinc-carbon) are currently being used. In addition, it can replace Nickel-Cadmium and Nickel-Metal Hydride cells in low to medium power applications with much improved charge retention even at higher operating temperatures and in intermittent. Unlike NiCad and NiMeH batteries, which show a high self-discharge especially in warm climates, RAM cells work well with solar charging.

Simple, low-cost methods of charge overflow and equalization have also opened the way for OEM applications where in-application charging is of essence.

New high tech, high-drain devices requiring more power to operate can be effectively run by improved high-rate RAM cells.

REFERENCES

1. K. Tomantschger, R. J. Book., J. Daniel-Ivad US Patent 5,424,145 (1995).
2. J. Daniel-Ivad, R. J. Book., K. Tomantschger, US Patent 5,626,988 (1997).
3. J. Daniel-Ivad, K. Kordesch, E. Daniel-Ivad, 38th Power Sources Conference, Cherry Hill, NJ, June 1998.
4. K. Kordesch and J. Daniel-Ivad, 37th Power Sources Conference, Cherry Hill, NJ, June 1996.
5. K.Kordesch, et al, 38th Power Sources Conference, Cherry Hill, NJ, June 1998
6. K. Kordesch, J. Daniel-Ivad and D. Zhang, Patent Pending 1996.