

CAR BATTERY FREQUENTLY ASKED QUESTIONS 4.0

Bill Darden

February 12, 2001

A word of caution: Lead acid batteries contain a sulfuric acid electrolyte, which is a highly corrosive poison and will produce gasses when recharged and explode if ignited. This will hurt you—**BAD!** When working with batteries, you need to have plenty of ventilation, remove your jewelry, wear protective eyewear (safety glasses) and clothing, and exercise caution. Do **NOT** allow battery electrolyte to mix with salt water. Even small quantities of this combination will produce chlorine gas that can **KILL** you! Whenever possible, please follow the manufacturer's instructions for testing, jumping, installing, charging and equalizing batteries.



This FAQ assumes a 12-volt, six cell, and negative grounded, lead acid automotive battery used to start gasoline or diesel engines in automobiles, light trucks and vans. The contents would also apply to starting batteries found in trunks, motorcycles, boats, snowmobiles, jet skis, farm tractors, lawn and garden tractors, SUVs, etc. Aircraft, busses and large trucks use 24 volts and some airplanes use special purpose AGM and Ni-Cad batteries for starting. For 6-volt batteries, divide the voltage by two; for 8-volt batteries, divide by 1.5; for 24-volt batteries, double the voltage, and for 36-volt batteries, triple the voltage.

The technical stuff is in italics.

CONTENTS

1. WHAT IS THE BOTTOM LINE?
2. WHY BOTHER?
3. HOW DO I PERFORM PREVENTIVE MAINTENANCE?
4. HOW DO I TEST A BATTERY?
5. HOW DO I KNOW IF THE CHARGING SYSTEM IS OK OR LARGE ENOUGH?
6. HOW DO I JUMP START MY CAR?
7. WHAT DO I LOOK FOR IN BUYING A NEW BATTERY?
8. HOW DO I INSTALL A NEW BATTERY?
9. HOW DO I RECHARGE (OR EQUALIZE) MY BATTERY?
10. WHAT CAUSES MY BATTERY TO DRAIN OVERNIGHT?
11. HOW CAN I INCREASE THE LIFE OF MY BATTERY?

12. WHAT ARE THE MOST COMMON CAUSES OF PREMATURE BATTERY FAILURES?
13. HOW CAN I STORE BATTERIES?
14. WHAT ARE THE MYTHS ABOUT BATTERIES?
15. HOW LONG CAN I PARK MY CAR?
16. HOW CAN I REVIVE A SULFATED BATTERY?
17. WHERE CAN I FIND MORE INFO ON BATTERIES?

1. WHAT IS THE BOTTOM LINE?

- 1.1. At the first sign of slow starting, headlights dim at idle, gauges indicate discharge with engine running at high idle, or your battery seems to be losing performance, recharge, remove the surface charge, and load test it! Weak or bad batteries also can cause stress or premature failures of charging systems and starters. (Please see Section 4.)
- 1.2. Perform regular preventive maintenance, especially during **HOT** weather and before **COLD** weather. (Please see Section 3.)
- 1.3. In hot climates use non-sealed batteries, so you can replace lost water and avoid high temperatures. (Please see Section 7.)
- 1.4. Keep the battery charged, but avoid overcharging. (Please see Section 9.)
- 1.5. Buy the freshest and largest Reserve Capacity (RC) battery that will physically fit in your vehicle, making sure that the Cold Cranking Amp (CCA) rating for your climate that meets or exceeds the car's Original Equipment Manufacturer's (OEM) cranking amp requirement. (Please see Section 7.)
- 1.6. After deep discharges or jump-starts, recharge your battery, remove the surface charge, and load test it for latent damage. (Please see Section 4.)
- 1.7. **Temperature matters!** **Heat** kills car batteries and **cold** reduces the available capacity.

2. WHY BOTHER?

Because only the rich can afford cheap batteries...

A car battery is a rechargeable electrochemical device that stores chemical energy and releases it as electrical energy upon demand. When a car battery is connected to an external device, such as a starter, chemical energy is converted to electrical energy and current flows through the circuit. A good quality car battery will cost between \$50 and \$150 and, if properly maintained, it should last an average of five years. The primary purpose of a car (or SLI—Starting, Lighting and Ignition as it is known in the battery industry) battery is to **START** the engine. Its secondary function is to

filter or stabilize the power. It also provides extra power for the lighting, two-way radios, audio system and other accessories when their combined load **EXCEEDS** the capability of the charging system. Finally, a car battery provides a source of power to the electrical system when the charging system is not operating.

With a 5% compounded annual growth rate, worldwide sales of SLI batteries represent 63% of the \$27 billion annually spent on batteries.

2.1. How is a battery made?

There is an excellent description of how battery is made at the Battery Council International (BCI) web site at <http://www.batterycouncil.org/made.html>. A twelve-volt car battery is made up of six cells, each producing 2.1 volts and that are connected in series from positive to negative. Each cell is made up of an element containing positive plates that are all connected together and negative plates, which are also all connected together. They are individually separated with thin sheets of electrically insulating, porous material [“envelopes” labeled #3 in the diagram below] that are used as spacers between the positive (usually light orange) and negative (usually slate gray) plates to keep them from electrically shorting to each other. The plates [#2 in the diagram below], within a cell, alternate with a positive plate, a negative plate and so on. A plate is made up of a metal grid that serves as the supporting framework for the active porous material that is “pasted” on it. In Europe, using solid lead positive “Plante” plates is popular.

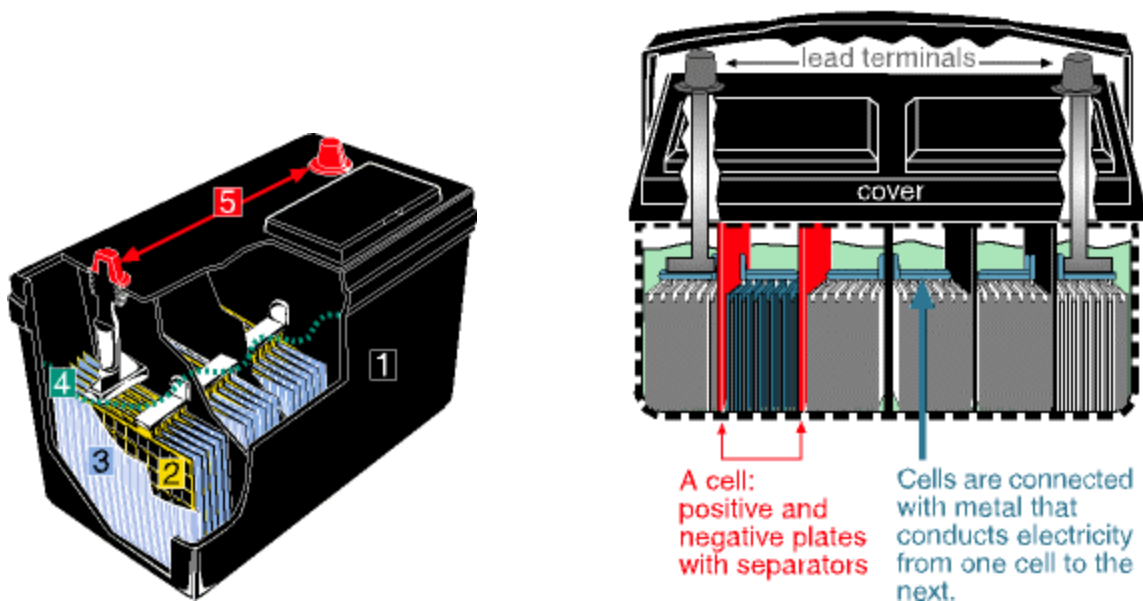

[Source: BCI]

After the “curing” of the plates, they are made up into cells, and the cells are inserted into a high-density tough polypropylene or hard rubber case [#1 in the diagram above]. The cells are connected to the terminals [#5 in the diagram above], and the case is covered and then filled with a dilute sulfuric acid electrolyte [#4 in the diagram above]. The battery is initially charged or “formed” to convert yellow Lead Oxide (PbO or *Litharge*) into Lead Peroxide (PbO_2),

which is usually dark brown or black. The electrolyte is replaced and the battery is given a finishing charge. Some batteries are “dry charged” meaning that the batteries are shipped without electrolyte and it is added and recharged when they are put into service.

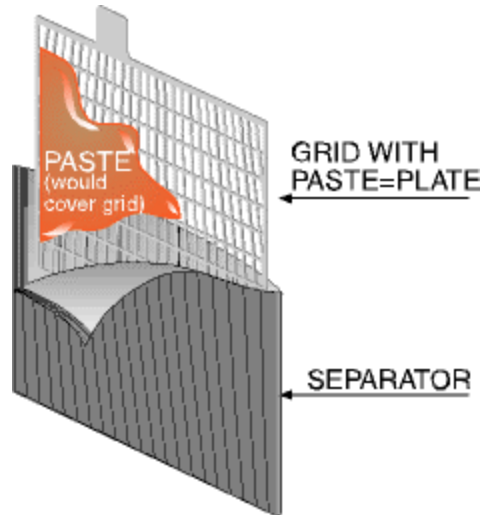

[Source: BCI]

Two important considerations in battery construction are porosity and diffusion. Porosity is the pits and tunnels in the plate that allows the sulphuric acid to get to the interior of the plate. Diffusion is the spreading, intermingling and mixing of one fluid with another. When you are using your battery, the fresh acid needs to be in contact with the plate material and the water generated needs to be carried away from the plate. The larger the pores or warmer the temperature, the better the diffusion.

2.2. How does a battery work?

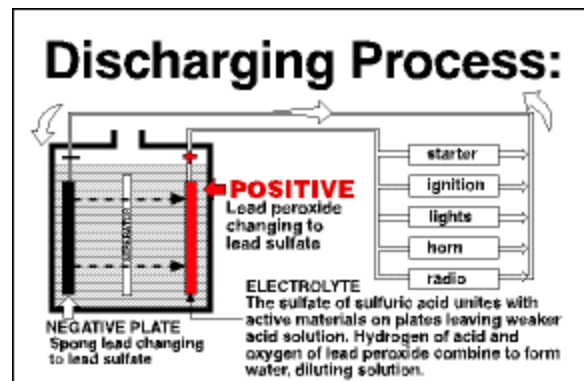
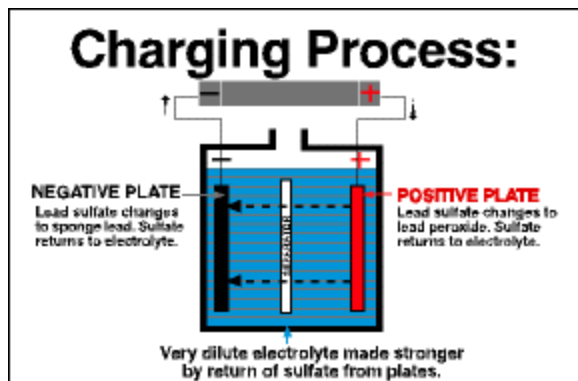

[Source: BCI]

A more detailed description of how a battery works can be found on the BCI web site at <http://www.batterycouncil.org/works.html>. A battery is created by alternating two different metals such as Lead Dioxide (PbO_2), the positive plates, and Spenger lead (Pb), the negative plates. Then the plates are immersed in diluted Sulfuric Acid (H_2SO_4), the electrolyte. The types of metals and the electrolyte used will determine the output of a cell. A typical lead-acid battery produces approximately 2.1 volts per cell. The chemical action between the metals and the electrolyte creates the electrical energy. Energy flows from the battery as soon as there is an electrical load, for example, a starter motor that completes a circuit between the positive and negative terminals. The electrical current flows as charged portions of acid (ions) between the battery plates and as electrons through the external circuit. The action of the lead-acid storage battery is determined by chemicals used, state-of-charge, temperature, porosity, diffusion, and load determine the action of the lead-acid storage battery.

2.3. Why do batteries die?

In cold climates, normally a battery “ages” as the active positive plate material sheds (or flakes off) due to the expansion and contraction that occurs during the discharge and recharge cycles. Brown sediment, called sludge or “mud,” builds up in the bottom of the case and can short the cell out. In hot climates, additional causes of failure are positive grid growth, positive grid metal corrosion in the electrolyte, negative grid shrinkage, buckling of plates, or loss of water. Deep discharges, heat, vibration, over charging, under charging or non-use accelerate this “aging” process. Another major cause of premature battery failure is lead sulfation. Please see Section 16 for more information on sulfation. Using tap water to refill batteries can produce calcium sulfate that also will coat the plates and fill the pores. Recharging a sulfated battery is like trying to wash your hands with gloves on. When the active material in the plates can no longer sustain a discharge current, the battery “dies.”

In a hot climate, the harshest environment for a battery, a Johnson Controls Inc. survey of junk batteries revealed that the **AVERAGE** life of a good quality car battery was 37 months. If your car battery is more than three years old, then it is living on borrowed time. Abnormally slow cranking, especially on a cold day, is another good indication that your battery is going bad; it should be externally recharged and load tested. Dead batteries almost always occur at the most inopportune times, for example, **AFTER** you have jump-started your car, in the airport after returning home from a long trip, during bad weather, late at night in a dark parking lot, or when you are late for an appointment. You can easily spend the cost of a new battery or more for an emergency jump start, a tow, or a taxi.

Most of the “defective” batteries returned to manufacturers during free placement warranty periods are good. This suggests that most sellers of new batteries do not know how to or take the time to properly load test or recharge them.

3. HOW DO I PERFORM PREVENTIVE MAINTENANCE?

Maintaining the correct electrolyte levels; tightening loose hold-down clamps and terminals; removing corrosion from both ends of each battery cable and both terminals; cleaning the battery top; and checking the alternator belt tension is normally the **ONLY** preventive maintenance required for a battery. The preventive maintenance frequency is dependent upon climate and

battery type, but you should perform this at least once before cold weather starts and once a month in warm weather. If the electrolyte levels are low in non-sealed batteries, allow the battery to cool. Add **DISTILLED** water to the level indicated by the battery manufacturer or if there is no recommendation, to within 1/8 to 1/4 inch (3 to 7 mm) **BELOW** the bottom of the filler tube (vent wells or splash barrels). The plates need to be covered at all times. Avoid **OVERFILLING**, especially in hot climates, because heat causes the electrolyte to expand and overflow.

4. HOW DO I TEST A BATTERY?

There are seven simple steps in testing a car battery—inspect, recharge, remove surface charge, load test, bounce back test and recharge. If you have a non-sealed battery, it is highly recommended that you use a good quality, temperature-compensated hydrometer, which can be purchased at an auto parts store for between \$5 and \$20. *A hydrometer is a float-type device used to determine the state-of-charge by measuring the specific gravity of the electrolyte in each cell. It is a very accurate way of determining a battery's state-of-charge and weak or dead cells.* To troubleshoot charging or electrical systems or if you have a sealed battery, you will need a digital voltmeter with 0.5% or better accuracy. A digital voltmeter can be purchased at an electronics store, such as Radio Shack, for between \$20 and \$200. Analog voltmeters are not accurate enough to measure the millivolt differences of a battery's state-of-charge or the output of the charging system. A battery load tester is optional. A more accurate way of testing the starting capacity of a lead acid battery is by using a conductance tester, such as a Midtronics PSR-105, costing between \$100 and \$200.

4.1. INSPECT

Visually inspect for obvious problems: loose or broken alternator belt, electrolyte levels **BELOW** the top of the plates, dirty battery top, corroded or swollen cables, corroded terminal clamps, loose hold-down clamps, loose cable terminals, or a leaking or damaged battery case.

If the electrolyte levels are low in non-sealed batteries, allow the battery to cool and add **DISTILLED** water to the level indicated by the battery manufacturer or to between 1/8 to 1/4 inch (3 to 7 mm) **BELOW** the bottom of the plastic filler tube (vent wells). The plates need to be covered at all times. Avoid **OVERFILLING**, especially in hot climates, because heat will cause the electrolyte to expand and overflow.

4.2. RECHARGE

Recharge the battery to 100% state-of-charge. If the battery has a difference of 0.03 specific gravity reading between the lowest and highest cell, then you should equalize it. (Please see Section 9.)

4.3. REMOVE SURFACE CHARGE

Surface charge is the uneven mixture of sulfuric acid and water along the surface of the plates as a result of charging or discharging. It will make a weak battery appear good or a good battery appear bad. You need to eliminate the surface charge by one of the following methods:

- 4.3.1. Allow the battery to sit for between four to twelve hours to allow for the surface charge to dissipate.
- 4.3.2. Turn the headlights on high beam for five minutes, shut them off, and wait five to ten minutes.
- 4.3.3. With a battery load tester, apply a load at one-half the battery's CCA rating for 15 seconds and then wait five to ten minutes.
- 4.3.4. Disable the ignition, turn the engine over for 15 seconds with the starter motor, and wait five to ten minutes.

4.4. MEASURE THE STATE-OF-CHARGE

If the battery's electrolyte is above 110° F (43.3° C), allow it to cool. To determine the battery's state-of-charge with the battery's electrolyte temperature at 80° F (26.7° C), use the following table, which assumes that 1.265 specific gravity reading is a fully charged battery:

Digital Voltmeter Open Circuit Voltage	Approximate State-of-Charge	Hydrometer Average Cell Specific Gravity	Electrolyte Freeze Point
12.65	100%	1.265	-75° F (-59.4° C)
12.45	75%	1.225	-55° F (-48.3° C)
12.24	50%	1.190	-34° F (-36.7° C)
12.06	25%	1.155	-16° F (-26.7° C)
11.89	Discharged	1.120	-10° F (-23.3° C)

STATE-OF-CHARGE

[Source: BCI]

Electrolyte Temperature Fahrenheit	Electrolyte Temperature Celsius	Add or Subtract to Hydrometer's SG Reading	Add or Subtract to Digital Voltmeter's Reading
160°	71.1°	+.032	+.192
150°	65.6°	+.028	+.168
140°	60.0°	+.024	+.144
130°	54.4°	+.020	+.120
120°	48.9°	+.016	+.096
110°	43.3°	+.012	+.072
100°	37.8°	+.008	+.048
90°	32.2°	+.004	+.024

80°	26.7°	0	0
70°	21.1°	-.004	-.024
60°	15.6°	-.008	-.048
50°	10°	-.012	-.072
40°	4.4°	-.016	-.096
30°	-1.1°	-.020	-.120
20°	-6.7°	-.024	-.144
10°	-12.2°	-.028	-.168
0°	-17.8°	-.032	-.192

TEMPERATURE COMPENSATION

*Electrolyte temperature compensation, depending on the battery manufacturer's recommendations, will vary. If you are using a **NON-temperature compensated HYDROMETER**, make the adjustments indicated in the table above. For example, at 30° F (-1.1° C), the specific gravity reading would be 1.245 for a 100% state-of-charge. At 100° F (37.8° C), the specific gravity would be 1.273 for 100% state-of-charge. This is why using a temperature compensated hydrometer is highly recommended and more accurate than other means. If you are using a **DIGITAL VOLTMETER**, make the adjustments indicated in the table above. For example, at 30° F (-1.1° C), the voltage reading would be 12.53 for a 100% state-of-charge. At 100° F (37.8° C), the voltage would be 12.698 for 100% state-of-charge.*

For non-sealed batteries, check the specific gravity in each cell with a hydrometer and average the readings. For sealed batteries, measure the Open Circuit Voltage across the battery terminals with an accurate digital voltmeter. This is the only way you can determine the state-of-charge. Some batteries have a built-in hydrometer, which only measures the state-of-charge in **ONE** of its six cells. If the built-in indicator is clear or light yellow, then the battery has a low electrolyte level and should be refilled and recharged before proceeding. If sealed, the battery is toast and should be replaced. If the state-of-charge is **BELOW** 75% using either the specific gravity or voltage test or the built-in hydrometer indicates “bad” (usually dark), then the battery needs to be recharged **BEFORE** proceeding. You should replace the battery, if one or more of the following conditions occur:

- 4.4.1. If there is a .050 (sometimes expressed as 50 “points”) or more difference in the specific gravity reading between the highest and lowest cell, you have a weak or dead cell(s). If you are really lucky, applying an **EQUALIZING** charge may correct this condition. (Please see Section 9.)
- 4.4.2. If the battery will not recharge to a 75% or more state-of-charge level or if the built-in hydrometer still does not indicate “good” (usually **green**, which indicates a 65% state-of-charge or better).

If you know that a battery has spilled or “bubbled over” and the electrolyte has been partially replaced with water, you can replace this old electrolyte with new electrolyte and go back to Step 3.2 above. Battery electrolyte is a mixture of 25% sulfuric acid and distilled water. It is cheaper to replace the electrolyte than to buy a new battery.

- 4.4.3. If a digital voltmeter indicates 0 volts, you have an open cell.
- 4.4.4. If the digital voltmeter indicates 10.45 to 10.65 volts, you probably have a shorted cell. A shorted cell is caused by plates touching, sediment (“mud”) build-up or “treeing” between the plates.

4.5. LOAD TEST

If the battery’s state-of-charge is at 75% or higher or has a “good” built-in hydrometer indication, then you can load test the battery by one of the following methods:

- 4.5.1. Turn the headlights on high beam for five minutes.
- 4.5.2. Disable the ignition and turn the engine over for 15 seconds with the starter motor.
- 4.5.3. With a battery load tester, apply a load equal to one half of the CCA rating of the battery for 15 seconds.
- 4.5.4. With a battery load tester, apply a load equal to one half the OEM cranking amp specification for 15 seconds.

DURING the load test, the voltage on a good battery will NOT drop below the following table's indicated voltage with the electrolyte at the shown temperatures:

Electrolyte Temperature F	Electrolyte Temperature C	Minimum Voltage Under LOAD
100	37.8	9.9
90	32.2	9.8
80	26.7	9.7
70	21.1	9.6
60	15.6	9.5
50	10.0	9.4
40	4.4	9.3
30	-1.1	9.1
20	-6.7	8.9
10	-12.2	8.7
0	-17.8	8.5

LOAD TEST

[Source: Interstate Batteries]

4.6. BOUNCE BACK TEST

If the battery has passed the load test, please go to Section 4.7 below. After the load is removed, wait ten minutes and measure the state-of-charge. If the battery bounces back to less than 75% state-of-charge (1.225 specific gravity or 12.45 VDC), then recharge the battery (please see Section 9) and load test again. If the battery fails the load test a second time or bounces back to less than 75% state-of-charge, then you should replace it because it lacks the necessary CCA power.

4.7. RECHARGE

If the battery passes the load test, you should recharge it as soon as possible to restore it to peak performance and to prevent lead sulfation.

5. HOW DO I KNOW IF MY CHARGING SYSTEM IS OK OR LARGE ENOUGH?

Your car's charging system is composed of an alternator (or DC generator), voltage regulator, battery and indicator light or gauge. While your engine is running, the charging system's primary purpose is to provide power for the car's electrical load, for example, ignition, lighting, audio system, accessories, etc., and to recharge your car's battery. Its output capacity is directly proportional to the RPM of the engine. Charging systems are normally sized by the car manufacturers to provide approximately 125% of the worst-case OEM electrical load, so that the battery can be recharged.

When the charging system fails, usually an indicator light will come on or the voltage (or amp) gauge will not register "good." The most common charging system failure is a loose, worn or broken alternator belt, so check it first. If you rev up the engine and the alternator light becomes **brighter**, then the battery needs to be fully recharged and tested. If the light becomes **dimmer** then the problem is most likely in the charging system. The next test requires use of a known-to-be-good battery. Attach this battery to the engine and run the engine at 2000 or more RPM for two minutes. Depending on the load and ambient temperature, the voltage should increase to between 13.0 and 15.1 volts for a fully charged battery. Most cars will measure between 14.4 and 14.8 volts on a warm day, depending on the battery type that the charging system was designed for.

Most voltage regulators are temperature compensated to properly charge the battery under different environmental conditions. As the ambient temperature decreases, the charging voltage is increased to overcome the higher battery resistance. Conversely, as the ambient temperature increases, the charging voltage is decreased. Other factors affecting the charging voltage are the battery's condition, state-of-charge, electrical load and electrolyte purity.

If a battery terminal's voltage is below 13.0 volts and the battery tests good after being recharged, or if you are still having problems keeping the battery charged, then have the charging system's output voltage and load tested. Also, have the car's parasitic load tested (the load with the ignition key turned off). A loose alternator belt or open diode will significantly reduce the alternator's current output. If output voltage is above 15.1 volts with the ambient temperature above freezing, and the battery's electrolyte level frequently will be found to be low or if you smell "rotten eggs"

around the battery, then you are probably overcharging the battery and the charging system should be tested.

What if you cannot keep your battery recharged and the battery tests **OK**? The vehicle's electrical load is satisfied first by the charging system, and then any remaining power, if any, is used to recharge the battery. For example, if the total electrical load is 64 amps and the charging system is producing 80 amps. Up to 16 amps will be available for recharging the battery. If the charging system is operating at maximum capacity of 80 amps, then the battery usually will be recharged within five minutes. Now let us assume that the engine is idling and the charging system is only capable of producing 20 amps. Forty-four amps from the battery are required to make up the difference to satisfy the total electrical load. The battery is being discharged further. This example is why that during short trips or while in stop-and-go traffic, the battery may never get recharged and may even "completely" discharge.

Using the example above, let's assume that you add an after-market, high-power audio system or lights that adds 20 amps of load. With a total electrical load of 84 amps, even at maximum output, the battery will never be recharged with an 80-amp system. During operation, the battery must make up the 4-amp deficit. The solution is to upgrade the charging system to 125% or more of the **NEW** worst-case load. In this example, you would need a charging system capable of 105 amps or more of electrical output.

6. HOW DO I JUMP START MY CAR?

In cold weather, a good quality booster cable with six-gauge (or less) wire is necessary to provide enough current to the disabled car to start the engine. *Larger diameter wire is better.* Please check the owner's manual for **BOTH** vehicles **BEFORE** attempting to jump-start. Follow the manufacturers' procedures because some good cars should not be running during a jump-start of a disabled one. However, starting the disabled car with the good car running can prevent having both cars disabled. **AVOID** the booster cable clamps touching each other or the **POSITIVE** clamp touching anything but the **POSITIVE (+)** post of the battery. Momentarily touching the block or frame can cause extensive, costly damage.

- 6.1. If **BELOW** 10° F (-12.2° C), insure that the electrolyte is NOT frozen in the dead battery. If frozen, check for a cracked case and thaw **BEFORE** proceeding. The electrolyte in a dead battery will freeze at approximately 13° F (-10.6° C).
- 6.2. Without the cars touching, turn off all unnecessary accessories and lights on **BOTH** cars, insure there is plenty of ventilation, and put on some protective eye ware.
- 6.3. Start the car with the good battery and let it run for at least two or three minutes at fast idle to recharge its battery and check the positive and negative terminal marking on both batteries **BEFORE** proceeding.

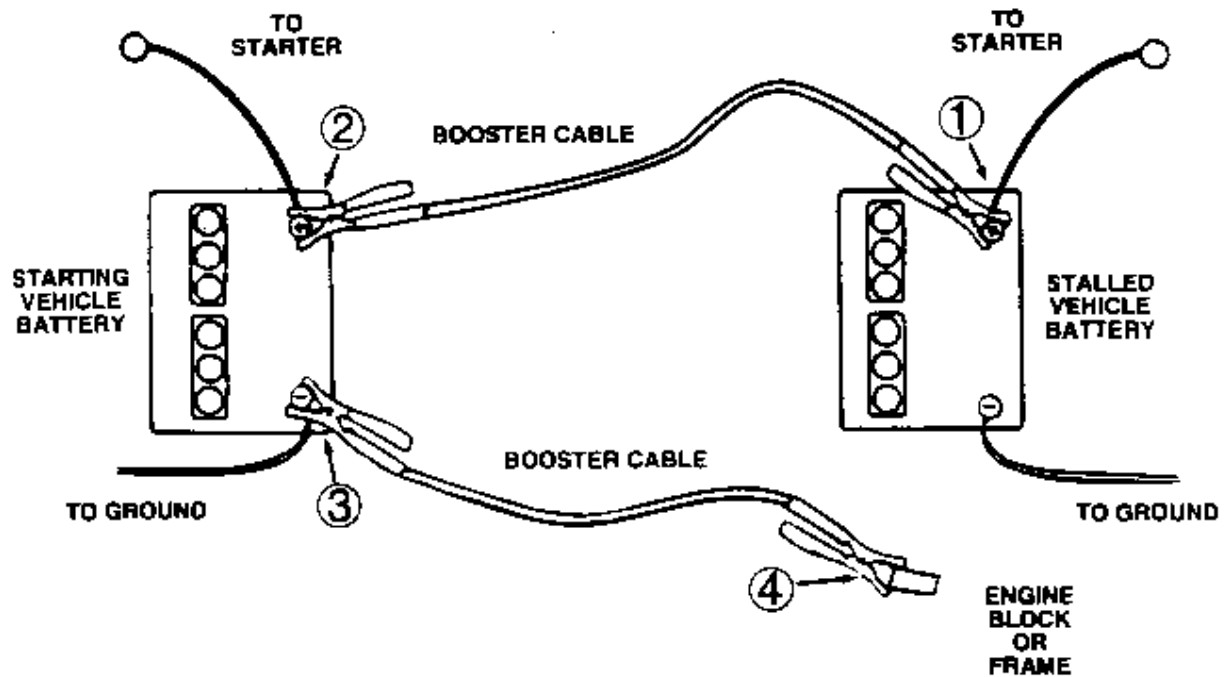

[Source: BCI]

- 6.4. Connect the **POSITIVE** booster cable clamp (usually **RED**) to the **POSITIVE (+)** terminal on the dead battery. Connect the **POSITIVE** clamp on the other end of the booster cable to the **POSITIVE (+)** terminal on the good battery.
- 6.5. Connect the **NEGATIVE** booster cable clamp (usually **BLACK**) to the **NEGATIVE (-)** terminal on the good battery and the **NEGATIVE** booster cable clamp on the other end to a clean, unpainted area on the engine block or frame on the disabled car and **AWAY** from the battery. This arrangement is to be used because some sparking will occur, and you want to keep sparks as far away from the battery as practical in order to prevent an explosion.
- 6.6. Let the good car continue to run at high idle for five minutes **OR MORE** to allow the dead battery to receive some recharge and to warm its electrolyte. If there is a bad jumper cable connection, do not wiggle the cable clamps connected to the battery terminals because sparks will occur and an explosion might occur. To check connections, first disconnect the clamp from the engine block, check the other connections, and then reconnect the engine block connection last.
- 6.7. Some car manufacturers recommend that you turn off the engine of the good car to protect its charging system prior to starting the disabled car. Check the owner's manual; otherwise, leave the engine running so you can avoid being stranded if the good car will not restart.
- 6.8. Start the disabled car and allow it to run at high idle. If the car does not start the first time, recheck the connections, and wait a few minutes. Now, try again.

- 6.9. Disconnect the booster cables in the **REVERSE** order, starting with the **NEGATIVE** clamp on the engine block or frame of the disabled car to minimize the possibility of an explosion.
- 6.10. As soon as possible, fully recharge, remove the surface charge and load test the dead battery for latent or permanent damage as a result of the deep discharge.

7. WHAT DO I LOOK FOR IN BUYING A NEW BATTERY?

Battery buying strategy for use in Canada, for example, is different than in the hot climates found in Texas or Arizona. In the colder climates, higher CCA ratings are more important. In a hot climate, higher RC ratings are more important than CCA; however, the CCA rating must be satisfied and match or exceed your car's OEM (Original Equipment Manufacturer) cranking amp requirement.

7.1. Cold Cranking Amps (CCA)

The most important consideration is that the battery's CCA rating **MEETS OR EXCEEDS**, your car's OEM cranking requirement in your climate. *CCAs are the discharge load measured in amps that a new, fully charged battery, operating at 0° F (-17.8° C), can deliver for 30 seconds and while maintaining the voltage above 7.2 volts. Batteries are sometimes advertised by their Cranking Performance Amps (CA), Marine Cranking Amps (MCA) measured at 32° F (0° C), or Hot Cranking Amps (HCA) measured at 80° F (26.7° C). These measurements are not the same as CCA. Do not be misled by CA, MCA or HCA ratings. To convert CAs to CCAs, multiply the CAs by 0.8. To convert HCAs to CCAs, multiply HCAs by 0.69.]*

To start a 4-cylinder gasoline engine, you will need approximately 600-700 CCA; 6-cylinder gasoline engine, 700-800 CCA; 8-cylinder gasoline engine, 750-850 CCA; 3-cylinder diesel engine, 600-700 CCA; 4-cylinder diesel engine, 700-800 CCA; and 8-cylinder diesel engine, 800-1200 CCA. To convert CCA, a SAE standard, to an EN, IEC, DIN or JIS standard, please refer to the table found at http://www.midtronics.com/pdf/power_sensor105_manual.pdf.

In hot climates, buying batteries with double or triple the cranking amps that exceed your starting requirement can be a **WASTE** of money. However, in colder climates the higher CCA rating the better, due to increased power required to crank a sluggish engine and the inefficiency of a cold battery. As batteries age, they are also less capable of producing CCAs. According to the Battery Council International, diesel engines require 220% to 300% more current than their gasoline counterparts; winter starting requires 140% to 170% more current than the summer.

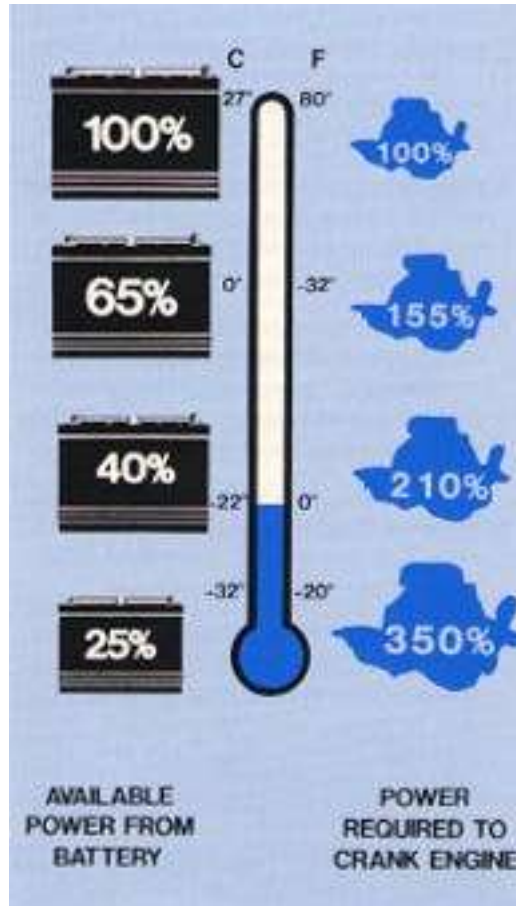

[Source: Exide]

If more CCA capacity is required, two (or more) identical 12-volt car batteries can be connected in parallel. Please refer to Section 7.2 below for more information on connecting batteries in parallel. Within a BCI group size, the battery with more CCA will have more plates because a larger surface area is required to produce the higher current.

7.2. Reserve Capacity (RC)

The second most important consideration is the Reserve Capacity rating because of the effects of increased parasitic (key off) loads and of emergencies. *RC is the number of minutes a fully charged battery at 80° F (26.7° C) can be discharged at 25 amps until the voltage falls below 10.5 volts. Deep cycle batteries are usually rated in Ampere-Hours. To convert Reserve Capacity to approximate Ampere-Hours, multiple RC by 0.4.* For example, a battery with a 120-minute RC will have approximately 48-Ampere-Hours of capacity at the 25-amp discharge rate. More RC is better in every case! In a hot climate, for example, if your car has a 360 OEM cranking amp requirement, then a 400 CCA rated battery with 120 minutes' RC and more electrolyte for cooling would be more desirable than one with 1000 CCA with 90 minutes of RC.

The following graph shows the effects of temperature vs. percentage of capacity:

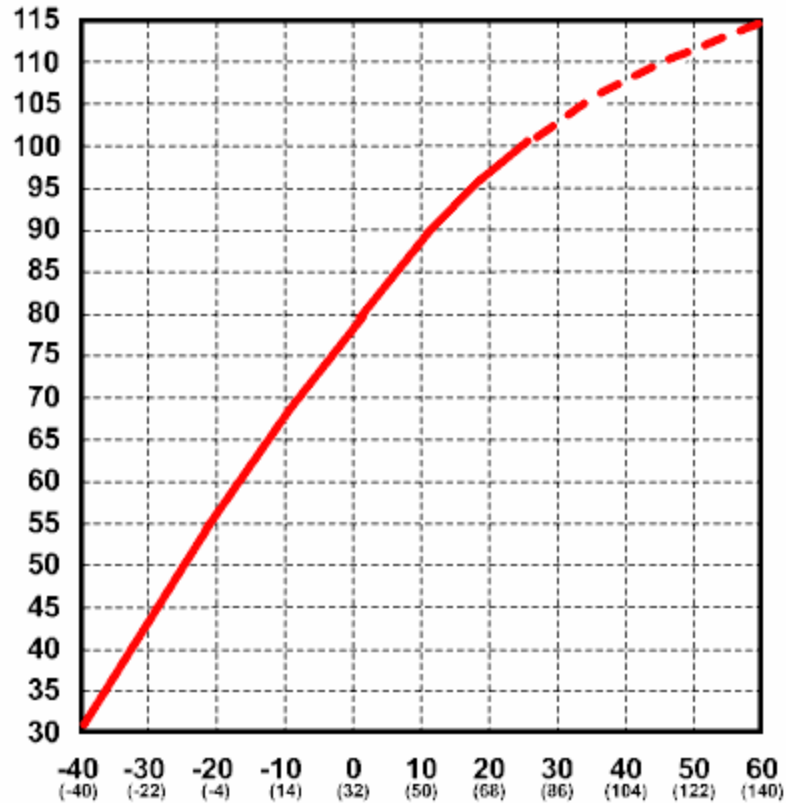

CAPACITY vs. TEMPERATURE

[Source: Concorde]

Adding more Reserve Capacity can be done in two ways. The best way is to add a deep cycle battery and a diode isolator to your existing car battery. This is a standard setup in most Recreational Vehicles (RVs). The advantage of this multi-battery setup is that the high-powered accessories can be powered from a deep cycle battery (or batteries) and the car battery is available to start the engine. The second advantage of using a deep cycle battery to power the high-powered accessories is that it can be discharged and recharged hundreds of times without damaging the battery. A car battery is not designed for deep discharges and will have a very short life if it is abused by deep discharges. A third advantage is that both batteries will be recharged automatically when the charging system has power available. An excellent and easy to understand free booklet, Introduction to Batteries and Charging Systems, written by Ralph Scheidler and about multi-battery applications, can be obtained from <http://www.surepower.com/ebrochures.html> or by calling (800) 845-6269 or (503) 692-5360.

The second way of increasing Reserve Capacity is by replacing the existing car battery with a large, 12-volt deep cycle battery or two identical large six-volt deep cycle batteries connected in **series** (connect the positive terminal of Battery One to the negative terminal of Battery Two). The deep cycle batteries must have enough current capacity to start the engine in the worst-case temperature.

If more ampere-hours (or CCA) are required, two (or more) new and identical 12-volt batteries can be connected in **parallel**. If you connect two 12-volt batteries in parallel, and they are identical in type, age and capacity, you can potentially double your original capacity. If you connect two that are not the same type, you will either overcharge the smaller of the two, or you will undercharge the larger of the two.

The recommended parallel and series connections are as follows:

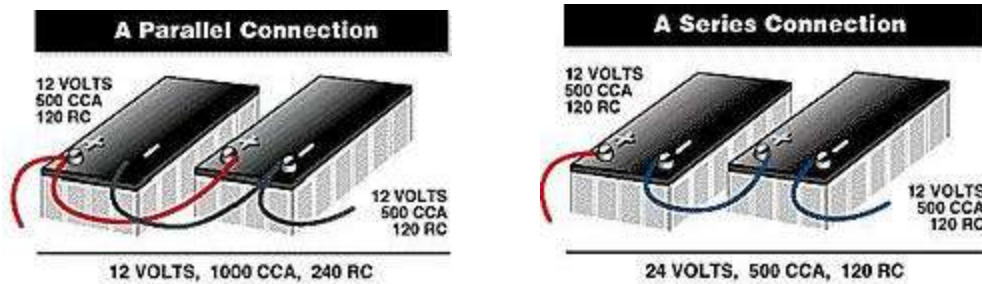

[Source: Interstate Batteries]

Connected this way the batteries will discharge and recharge equally. When connecting in series or parallel and to prevent recharging problems, do NOT mix old and new batteries or ones with different types. Cable lengths should be kept short and the cable should be sized large enough to prevent significant voltage drop [.2 volts (200 millivolts) or less] between batteries.

7.3. Type

The three most common types of **CAR** batteries are wet low maintenance (non-sealed), wet maintenance free (non-sealed or sealed), and gas-recombinant absorbed glass mat (AGM). The low maintenance batteries have a lead-antimony/calcium (dual alloy or hybrid) plate formulation. Maintenance free batteries have a lead-calcium/calcium formulation. Some of the battery manufacturers, such as Johnson Controls, build “North” and “South” battery versions to make up for the differences in climates. The advantages of maintenance free batteries are less preventive maintenance, up to 250% less water loss, faster recharging, greater overcharge resistance, reduced terminal corrosion, up to 40% more life cycles, up to 200% less self discharge, and less danger to consumers because there is less to service. However, they are more prone to deep discharge (dead battery) failures due to increased shedding of active plate material and development of a barrier layer between the active plate material and the grid metal. If sealed, a shorter life in hot climates is often experienced because water cannot be replaced. Maintenance free batteries are generally more expensive than low maintenance batteries. In hot climates, buying non-sealed “South”-type low maintenance, maintenance free or absorbed glass mat (AGM) battery is recommended.

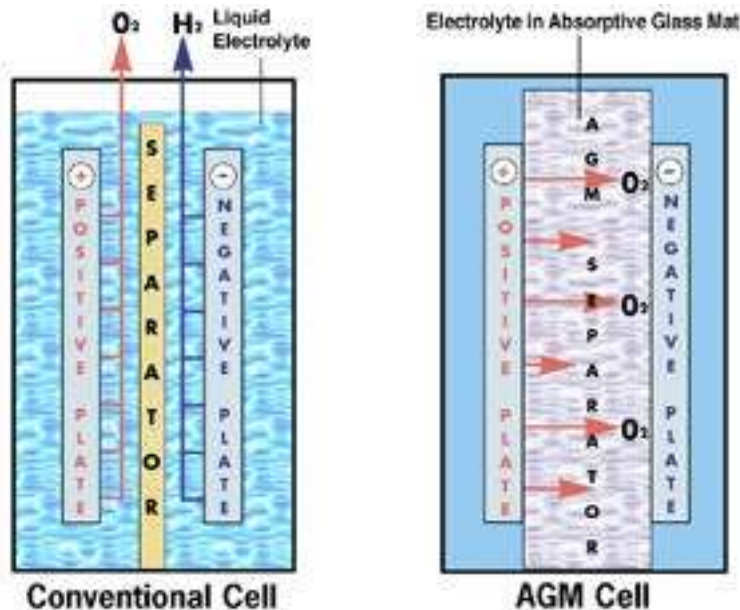

[Source: Hawker]

If you replace a sealed maintenance free battery in a GM car with a non-sealed *lead-antimony* or *lead-antimony/calcium* low maintenance battery, you will need to check the electrolyte levels more often. *This is because GM sets their voltage regulators at higher charging voltage, 14.8 volts, to recharge the sealed maintenance free lead-calcium/calcium batteries, like the original AC Delco batteries.*

Sears has introduced a DieHard Security for approximately \$170. When the ignition key is switched off, the battery will not allow the engine to be started but will provide power for the parasitic or “key off” load. Consumer Reports has tested it and indicates in the October, 2000 issue, that a car thief can defeat the security feature in less than one minute.

In the future, you can expect more expensive AGM or *recombinant gas technology (GRT)* batteries in the \$100 to \$150 price ranges. Examples of AGM batteries are Optima, Interstate’s Extreme Performance, Concorde’s Lifeline, Delphi’s Freedom Extra, Exide’s Select Orbital, AC Delco’s Platinum, and Champion’s Vortex. The use of this technology is because car manufacturers want to extend their “bumper-to-bumper” warranty periods, to relocate the battery from under the hood to avoid temperature extremes, to provide more weight in the rear, or to save under-hood space. The advantages of AGM batteries are they are maintenance free without the disadvantages of wet lead acid maintenance free batteries; they will last two to three times longer, if not overcharged. An AGM battery can replace a wet low maintenance battery, but a wet low maintenance battery cannot replace an AGM battery without adjusting the charging voltages. *Expect to see 36-volt AGM car batteries with 14/42-volt dual or 42-volt electrical systems introduced by some of the car manufacturers in 2002.*

For off road applications in trucks, recreational vehicles (RVs), 4x4’s, vans or sport utility vehicles (SUV’s), some manufacturers distribute “high vibration” or RV battery versions designed to reduce the effects of moderate vibration. For excessive vibration applications such as is experienced in off-road operation, it is best to use an AGM battery because there is no shedding of active plate material since the plates are immobilized. Some manufacturers

construct special batteries that have a higher tolerance to heat by changing plate formulations or providing for more electrolyte.

Car batteries are specially designed for high initial amps applications and shallow discharges. Cars usually start in five to 15 seconds; to start an engine typically consumes 5%-10% of the battery's capacity. Car batteries should NOT be discharged below 90% state-of-charge. By contrast, marine batteries are designed for prolonged discharges at lower amperage that typically consumes between 20% and 50% of the battery's capacity and deep cycle the batteries in a range between 20% and 80%. A "dual" or starting marine battery is a compromise between a car and deep cycle battery that is specially designed for marine applications. A deep cycle or "dual marine" battery will work as a starting battery if it can produce enough current to start the engine. For saltwater applications, AGM or gel cell batteries are highly recommended to prevent the formation of high levels of chlorine gas.

7.4. Size and Terminals

Manufacturers build their batteries to an internationally adopted Battery Council International (BCI) group number (24, 26, 70, 75, etc.). These specifications, which are based on the physical case size, terminal placement, type and polarity is used extensively in North America. *In Europe, the EN, IKC, Italian CEI, and German DIN standards are used and in Asia, the Japanese JIS standard is used.* The OEM battery group number is a good starting place to determine the replacement group. Within a group, the CCA and RC ratings, warranty and battery type will vary within models of the same brand or from brand to brand. Batteries are generally sold by model, so the group numbers will vary for the same price. This means that for the **SAME** price, you can potentially buy a physically larger battery with more CCA or RC than the battery you are replacing. For example, a 34/78 group might replace a smaller 26/70 group and give you an additional 200 CCA or 30 minutes of RC. If you buy a physically larger battery, be sure that the replacement battery will fit, the cables will connect to the correct terminals, and that the terminals will NOT touch surfaces such as the hood when it is closed.

BCI and the battery manufacturers publish application guides that contain OEM cranking amperage requirements and group number replacement recommendations by make, model and year of car, battery size, and CCA and RC specifications. You can also find BCI size information online at <http://www.exidebatteries.com/bci.cfm>. Manufacturers might not build or the store might not carry all the BCI group numbers. To reduce inventory costs, dual terminal "universal" batteries that will replace several group sizes are becoming more popular and fit 75% or more of cars on the road today.

There are six types of battery terminals—SAE Post, GM Side, "L", Stud, combination SAE and Stud, and combination S.A.E Post and GM Side. For automotive applications, the SAE Post is the most popular, followed by GM Side, then the combination "dual" SAE Post and GM Side. "L" terminal is used on some European cars, motorcycles, lawn and garden equipment, snowmobiles, and other light duty vehicles. Stud terminals are used on heavy duty and deep cycle batteries. The positive SAE Post terminal is slightly larger (by 1/16") than the negative one. Terminal locations and polarity will vary.

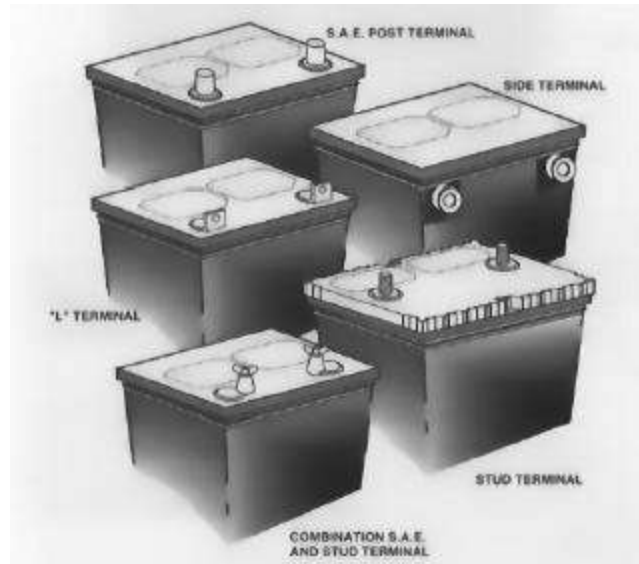

[Source: BCI]

Battery manufacturers or distributors will often “private label” their batteries for large chain stores. An alphabetical list in order of the largest battery manufacturers/distributors in North America and some of their brand names, trademarks and private labels may be found at <http://www.uuhome.de/william.darden/> or contact Bill Darden at mailto:bjb_darden@yahoo.com. Ownership, branding, Web addresses and telephone numbers are subject to change. For example, on September 29, 2000, Exide purchased GNB and Johnson Controls purchased Gylling Optima. Exide is the largest battery manufacturer in the world, and Johnson Controls is the largest manufacturer in the Americas.

7.5. Freshness

Determining the “freshness” of a battery is sometimes difficult. NEVER buy a non-sealed wet lead acid battery that is MORE than THREE months old or a sealed wet lead acid battery that is MORE than SIX months old. This is because it has started to sulfate unless it has periodically been recharged or it is “dry charged.” The exceptions to this rule are AGM and Gel Cell batteries that can be stored up to 12 months before the state-of-charge drops below 80%. Please see Section 16 for more information on sulfation. Dealers will often place their older batteries in storage racks so they will sell first. The new batteries can often be found in the rear of the rack or in a storage room. The date of manufacture is stamped on the case or printed on a sticker.

Some of the manufacturers date coding techniques are as follows:

7.5.1 Delphi (AC Delco and some Sears DieHard)

Dates are stamped on the cover near one post. The first number is the year. The second character is the month A-M, skipping I. The last two characters indicate geographic areas. Example OBN3=2000 February.

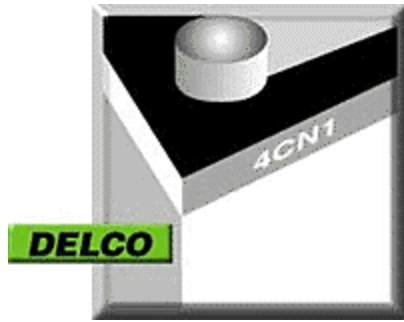

[Source: Interstate Batteries]

7.5.2. Douglas

Douglas uses the letters of their name to indicate the year of manufacture and the digits 1-12 for the month. D=1994 O=1995 U=1996 G=1997 L=1998 A=1999 S=2000 Example S02=2000 Feb.

7.5.3 East Penn, GNB (Champion), and Johnson Controls Inc. (Interstate and some Sears DieHard)

Usually on a sticker or hot-stamped on the side of the case. A=January, B=February, and the letter I is skipped. The number next to the letter is the year of SHIPMENT. Example B0=Feb 2000

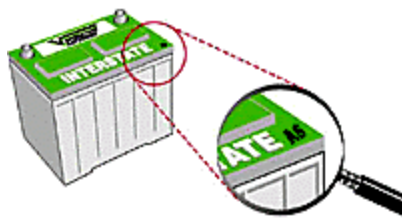

[Source: Interstate Batteries]

7.5.4 Exide (some Sears non-Gold DieHards)

The fourth or fifth character is the month. The following numeric character is the year. A-M skipping I. Example RO8B0B=Feb. 2000.



[Source: Interstate Batteries]

7.5.5 Trojan

Stamp on post, 2 Months **AFTER** manufacture date.

If you cannot determine the date code, ask the dealer or contact the manufacturer. Like bread, fresher is definitely better and does matter.

7.6. Warranty

As with tire warranties, battery warranties are **NOT** necessarily indicative of the quality or cost over the life of the battery. Some dealers will prorate warranties based on the **LIST** price of the bad battery, so if a battery failed half way or more through its warranty period, buying a **NEW** battery outright might cost you less than paying the difference under a prorated warranty. The exception to this is the **FREE** replacement warranty and represents the risk that the manufacturer is willing to assume. A longer free replacement warranty period is better.

8 HOW DO I INSTALL A BATTERY?

In a recent marketing study in the U.S., non-professional battery installers installed almost 60% of the approximately 82 million aftermarket batteries that were made in 1999. Car batteries were the fourth most popular item purchased among auto parts. The same study indicated that Wal-Mart (EverStart) has surpassed Sears (DieHard) as the number one battery seller in the United States with Auto Zone (DuraLast) as the most popular of the auto parts stores for batteries.

A car battery weights between 30 and 60 pounds (13.6 and 27.3 Kg), so the first question is, "Do I want to install it myself?" The second question is what do I do with the old battery if not exchanged for the new one? Insure that you have your radio and security codes before disconnecting the old battery. *A second battery can be temporarily connected to the electrical system in parallel before disconnecting the first one. If active when the key is off, a cigarette lighter plug can be used to easily connect a parallel battery.*

8.1. Thoroughly wash and clean the old battery, battery terminals and case or tray with warm water to minimize problems from acid or corrosion. Heavy corrosion can be neutralized with a mixture of one pound of baking soda to one gallon of warm water. Wear safety goggles and,

using a stiff brush, brush away from yourself. Also, mark the cables so you do not forget which one to reconnect.

8.2. Remove the **NEGATIVE** cable first because this will minimize the possibility of shorting the battery when you remove the other cable. It is probably a good idea to secure the cable out of the way so that it does not make any unwanted contact. Next, remove the **POSITIVE** cable and then the hold-down bracket or clamp. If the hold down bracket is severely corroded, replace it. Dispose of the old battery by exchanging it when you buy your new one or by taking it to a recycling center. According to BCI, over 96% of the old battery lead is recycled, making batteries the most completely recycled object of all recycled items. Please remember that batteries contain large amounts of harmful lead and acid, so take great care with safety and please dispose of your old battery properly to protect our fragile environment.

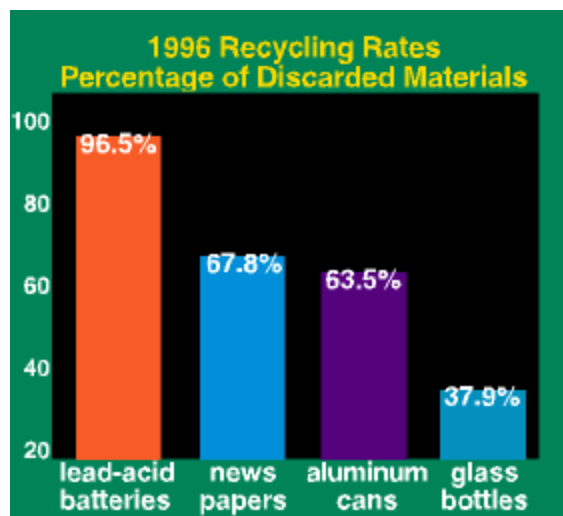

[Source: BCI]

Recycling For A Better Environment

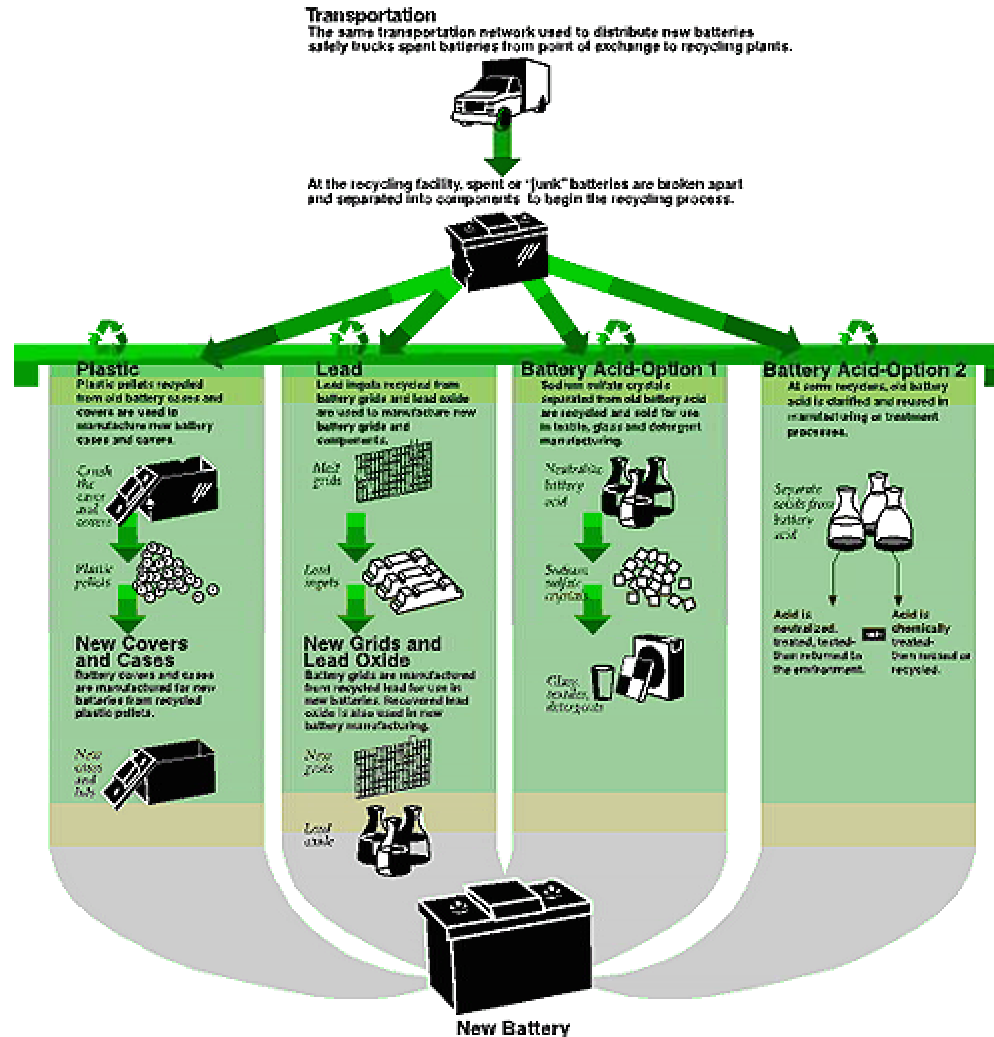

New batteries are recyclable and comprised of previously recycled materials.

[Source: BCI]

- 8.3. After removing the old battery, insure that the battery tray, cable terminals, and connectors are clean. Auto parts stores sell an inexpensive wire brush that will clean the inside of terminal clamps and the terminals. If the terminals, cables or hold down brackets are severely corroded, replace them. Corroded terminals or swollen cables will significantly reduce your starting capability because of their inability to carry the high current.
- 8.4. For SAE type terminals, use paraffin oil-soaked felt washer pads found at auto parts stores or thinly coat the terminal, terminal clamps and exposed metal around the battery with a high temperature grease or petroleum jelly (e.g., Vaseline) to prevent corrosion. Do not use the felt

or metal washers between the mating conductive surfaces with General Motors-type side terminal batteries.

- 8.5. Check the positive and negative terminal markings on the replacement battery and place it so that the **NEGATIVE** cable will connect to the **NEGATIVE** terminal. Reversing the polarity of the electrical system will severely damage or **DESTROY** it. It can even cause the battery to explode.
- 8.6. After replacing the hold-down bracket, reconnect the cables in reverse order, that is, attach the **POSITIVE** cable first and the **NEGATIVE** cable last. For General Motors-type side terminals, check the length of the bolt. Do NOT over tighten, or you could crack the battery case.
- 8.7. Before using the battery, check the electrolyte levels and add distilled water to cover the plates. Check the state-of-charge and recharge if necessary. Then recheck the electrolyte levels after the battery has cooled and top off with distilled water as required, but do not **overfill**.

9. HOW DO I RECHARGE (OR EQUALIZE) MY BATTERY?

There are up to four phases of battery charging—bulk, absorption, equalization and float. *The bulk stage is where the charger current is constant and the battery voltage increases. You can give the battery whatever current it will accept as long as it does not to exceed 20% of the ampere-hour rating and that it will not cause overheating. The absorption phase is the phase where the charger voltage is constant and current decreases until the battery is fully charged. This normally occurs when the charging current drops off to 1% or less of the ampere-hour capacity of the battery. For example, end current for a 50 ampere-hour battery is 0.5 amps (500 milliamps) or less.*

The optional equalizing phase is a controlled 5% overcharge to equalize and balance the voltage and specific gravity in each cell by increasing the charge voltage. Equalizing reverses the build-up of the chemical effects like stratification where acid concentration is greater in the bottom of the battery. It also helps remove sulfate crystals that might have built up on the plates. The frequency recommendation varies by manufacturer from once a month to once a year or is based on a specific gravity test where the difference between cells is .030 (or 30 “points”). To equalize, fully recharge the battery. At this point, increase the charging voltage to the manufacturer’s recommendations, or if not available, ADD 5%. Heavy gassing should start occurring. Take specific gravity readings in each cell once per hour. Equalization has occurred once the specific gravity values no longer rise during the gassing stage.

The optional float phase is where the charge voltage is reduced, then held constant and is used to indefinitely maintain a fully charged battery. Please refer to Section 13 for more information about storing batteries and float charging them.

An excellent and easy to understand tutorial on battery charging basics can be found at <http://www.batterytender.com/index2.html> by drilling down through Charging>Tutorials>Charging Basics. The following are four stage charging algorithms from **Deltran (Battery Tender)** for three different types of car batteries:

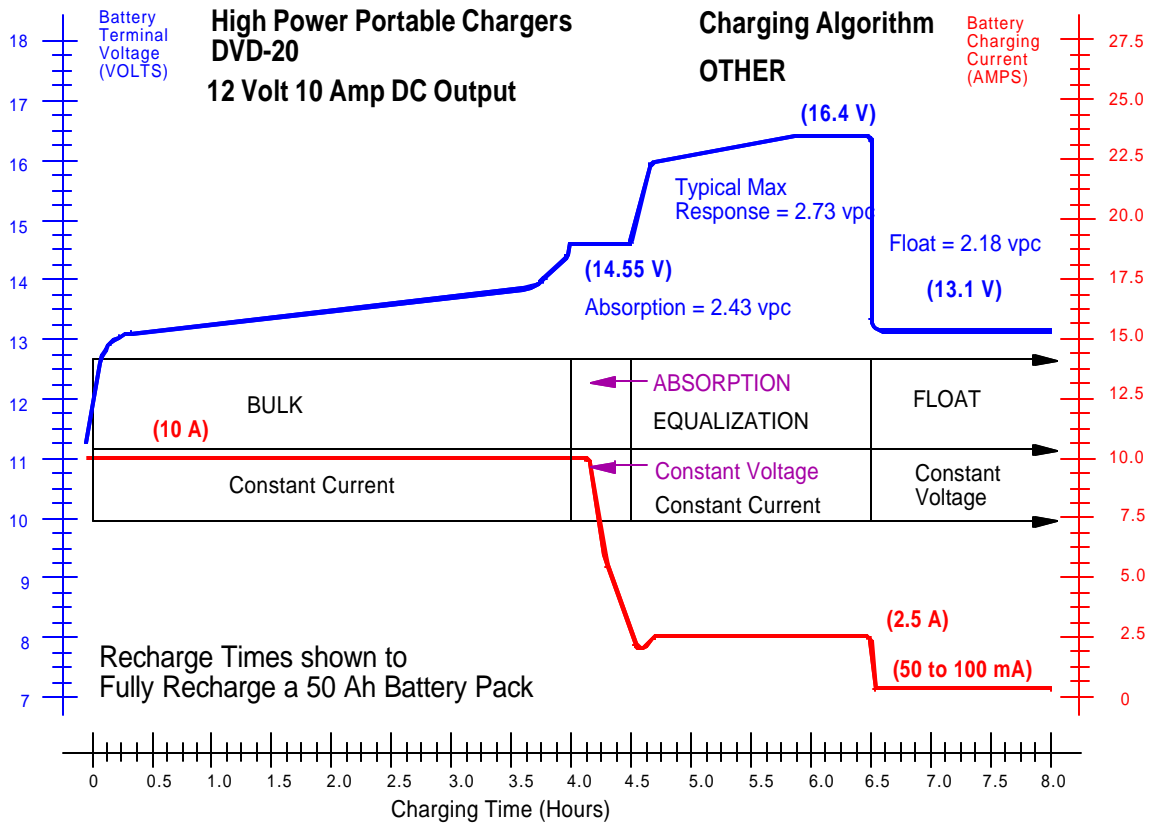

Low Maintenance (Lead-Antimony/Calcium)

[Source: Deltran]

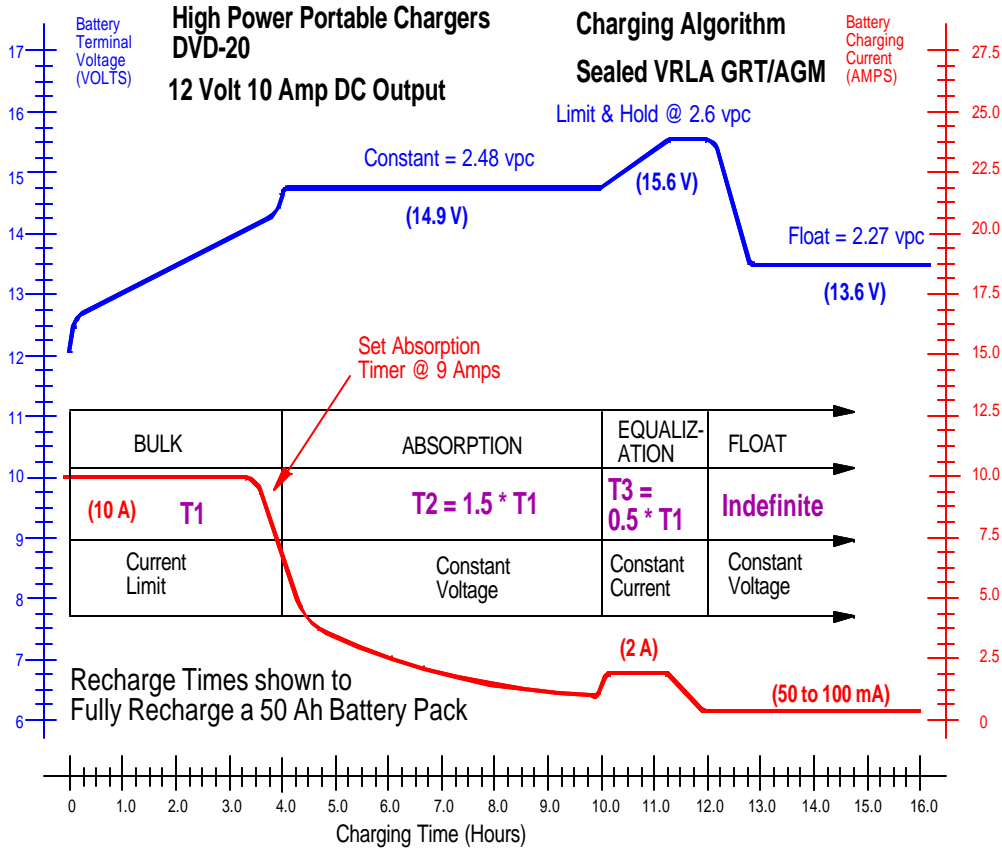

Absorbed Glass Mat (AGM)

[Source: Deltran]

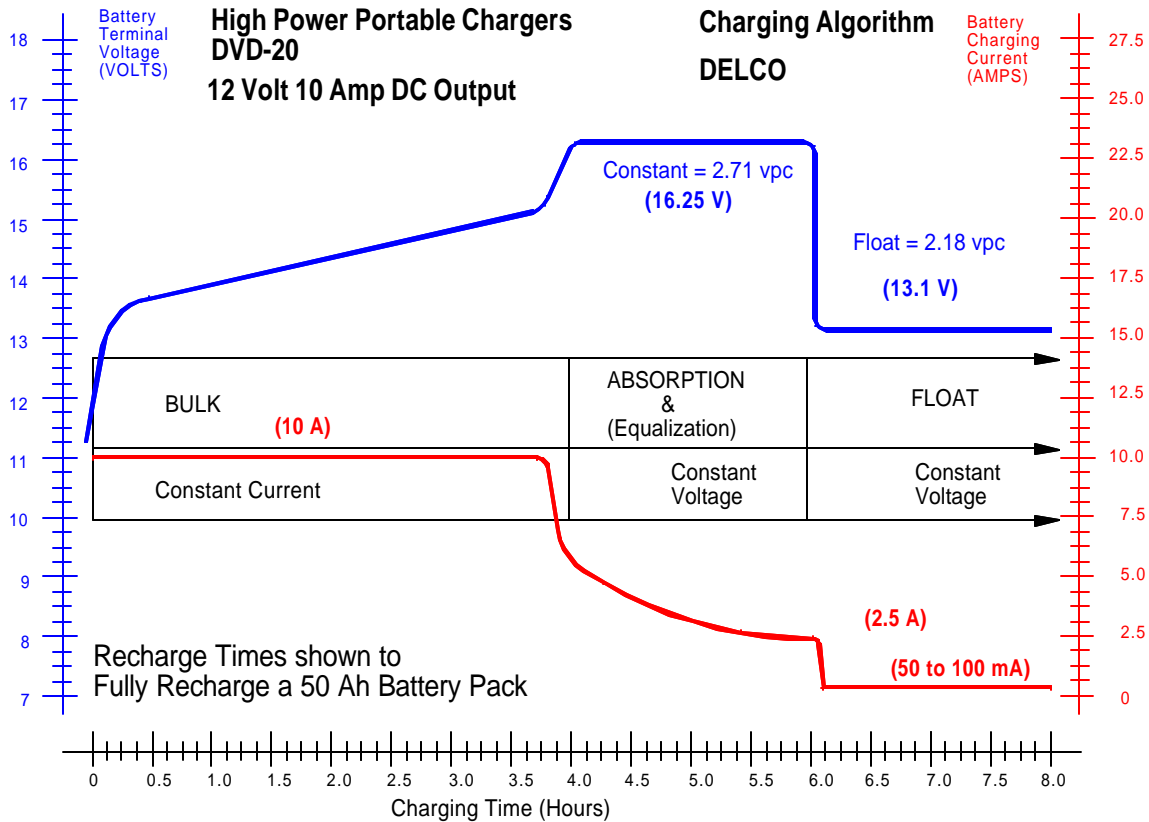

Maintenance Free (Lead-Calcium/Calcium)

[Source: Deltran]

It is important to use the battery manufacturer's charging recommendations whenever possible for optimum performance and life. In addition to the earlier cautions, here are some more words of caution:

- 9.1. **NEVER, NEVER** disconnect a battery cable from a car with the engine running, because the battery acts like a filter for the electrical system. Unfiltered (*pulsating DC*) electricity sometimes exceeding 40 volts and can damage expensive electrical components such as computers, radio, charging system, etc.
- 9.2. **BEFORE** recharging check the electrolyte level and insure it covers the plates at all times and that it is not frozen.
- 9.3. Avoid adding distilled water if the electrolyte is covering the top of the plates because during the recharging process, it will warm and expand. After recharging has been completed and the battery has cooled, **RECHECK** the levels.
- 9.4. Insure the vent caps are clean. Reinstall the vent caps **BEFORE** recharging, recharge **ONLY** in well-ventilated areas, and wear protective eye ware. Do **NOT** smoke or cause sparks or flames while the battery is being recharged because batteries give off explosive gasses.

- 9.5. If your car battery is sealed, avoid recharging with current **ABOVE** 20% of the RC (or 50% of the ampere hour) rating. For example, 24 amps maximum for a 120 minute RC (48 ampere hour) rated battery.
- 9.6. Follow the battery and charger manufacturers' procedures for connecting and disconnecting cables. Operate in a manner to minimize the possibility of an explosion or incorrectly charge the battery. You should turn the charger **OFF** before connecting or disconnecting cables to a battery. Do not wiggle the cable clamps while the battery is recharging, because a spark might occur and this might cause an explosion. Good ventilation or a fan is recommended to disperse the gasses created by the recharging process.
- 9.7. If a battery becomes hot, over 110 ° F (43.3 ° C), or violent gassing or spewing of electrolyte occurs, turn the charger off temporarily or reduce the charging rate. This will also prevent "thermal runaway" that can occur with VRLA (AGM or Gel cell) batteries.
- 9.7. Insure that charging the battery in the car with an external **MANUAL** charger will not damage the car's electrical system with high voltages. If this is even a remote possibility, then disconnect both battery cables from the battery **BEFORE** connecting the charger.
- 9.8. If you are recharging gel cell batteries, a manufacturer's charging voltages can be very critical. Sometimes, you might need special recharging equipment. In most cases, standard deep cycle chargers used to recharge wet batteries cannot be used to recharge gel cell and AGM batteries because of their charging profiles; using them will shorten battery life or cause "thermal runaway". Match the charger (or charger's setting) for the battery type you are recharging or floating.

Usually when a car is jump started, it is driven long enough to fully recharge the battery. (Please see Section 7.2.) The length of time to fully recharge the battery depends on the amount of discharge, the amount of surplus current that is diverted to the battery, how long the engine is run, engine speed, and ambient temperature. That is, an alternator is sized by the car manufacturer to carry the maximum accessory load and to maintain a battery and NOT to recharge a dead battery. *For example, if 300 amps were consumed for two seconds to start a car from a fully charged battery, it will take an 80 amp charging system approximately nine seconds to replace the power used. If 25 amps are available to recharge the battery, it will take 30 seconds and twelve minutes at one amp. With a dead 120 minute RC battery, it would take approximately 45 minutes at 80 amps, 2.4 hours at 25 amps, or 60 hours at one amp to obtain a 90% state-of-charge.*

If you have added lights, audio amplifiers, two-way radios or other high powered accessories to your vehicle and engage in stop-and-go driving, the alternator might NOT produce enough current to keep your battery fully charged. You might need to increase the capacity of the charging system. *Ideally the combined load of all the accessories should be less than 75-80% of the charging system's maximum output, so that at least 20-25% is available to recharge the battery.*

A better method to recharge batteries is to use an external constant current charger, which is set not to deliver more than 12% of the RC rating of the battery and also monitors the state-of-charge. A timer that will turn off the charger will help prevent overcharging the battery. For fully discharged batteries, the following table lists the recommended battery charging rates and times:

Reserve Capacity (RC) Rating	Slow Charge (RECOMMENDED)	Fast Charge
80 Minutes or less [32 ampere hours or less]	15 Hours @ 3 amps	5 Hours @ 10 amps
80 to 125 Minutes [32 to 50 ampere hours]	21 Hours @ 4 amps	7.5 Hours @ 10 amps
125 to 170 Minutes [50 to 68 ampere hours]	22 Hours @ 5 amps	10 Hours @ 10 amps
170 to 250 Minutes [68 to 100 ampere hours]	23 Hours @ 6 amps	7.5 Hours @ 20 amps
Above 250 Minutes [over 100 ampere hours]	24 Hours @ 10 amps	6 Hours @ 40 amps

[Source: BCI]

The **BEST** method is to **SLOWLY** recharge the battery at 70° F (21.1° C) over a ten-hour period (*C/10*) using an external constant voltage (or tapered current charger). This technique allows the acid more time to penetrate the plates and there is less mechanical stress on the plates. *C-rate is a measurement of the charge or discharge of battery overtime. It is expressed as the Capacity of the battery divided by the number of hours to recharge or discharge the battery. For example, a 120-minute RC (48 ampere-hour) battery would have a charging or discharging rate of 4.8 amps for ten hours.* A constant voltage or “automatic” charger applies regulated voltage at approximately 14.4 volts with the electrolyte at 70° F (21.1° C). A 5-amp constant voltage charger will cost between \$25 and \$50 at an auto parts store and is suitable for most simple automotive recharging charging applications. More expensive three-stage microprocessor-controlled chargers are available that will automatically provide bulk, absorption and float charging. A four-stage charger also will provide an equalizing charge in addition to the bulk, absorption and float charging.

To prevent damage to a fully discharged battery, the current should be less than 1% of the CCA rating during the first 30 minutes of charge. With a taper charger, a high current, up to 30 amps, can be applied to non-sealed batteries for a short period up to 30 minutes maximum; the current is then regulated downward until the charge state reaches 100%. An excellent automatic constant voltage battery charger is a 15 volt regulated power supply that has been adjusted to the manufacturer’s recommendations or, if not available, to voltages in the table below with the electrolyte at 70° F (21.1° C):

Battery Type	Charging Voltage	Float Voltage	Equalizing Voltage
--------------	------------------	---------------	--------------------

<i>Wet Low Maintenance</i>	14.4	13.2	15.1
<i>Wet Maintenance Free</i>	14.8	13.4	15.5
<i>Sealed & VRLA</i>	14.4	13.2	15.1
<i>AGM</i>	14.4	13.6	15.5
<i>Gel Cell</i>	14.1	13.2	N/A
<i>Wet Deep Cycle</i>	14.5	13.2	15.8

*To compensate for electrolyte temperature, which has a negative temperature compensation coefficient, adjust the charging voltage .0028 (2.8 millivolts) to .0033 (3.3 millivolts) volts/cell/degree F. For example, if the temperature is 30° F (-1.1° C), then **INCREASE** the charging voltage to 15.19 volts for a wet low maintenance battery. If 100° F (43.3° C), then **DECREASE** the charging voltage to 13.81 volts.*

If left unattended, cheap, unregulated trickle or manual battery chargers can overcharge your battery because they can “decompose” the water out of the electrolyte. Avoid using fast, high rate, or boost chargers on any battery that is sulfated or deeply discharged. The electrolyte should **NEVER** bubble violently while recharging because high currents only create heat and excess explosive gasses.

10. WHAT CAUSES MY BATTERY TO DRAIN OVERNIGHT?

Parasitic (or key off) drain is the cumulative load produced by electrical devices, for example, clocks, computers, alarms, etc., that operate after the engine is stopped and the ignition key has been switched off. *Parasitic loads typically run 20 to 120 milliamps.* Glove box, trunk, and under hood lights that do not automatically turn off when the door is closed and shorted diodes in alternators are the most common offenders. Cooling fans, power seat belt retractors, radios and dome lights left on, alarm systems, and electric car antennas have also caused batteries to drain. Leaving your headlights on will generally discharge a fully charged battery, with 90 minutes of Reserve Capacity [36 ampere hours], within a couple of hours.

There are two methods that are commonly used to test the parasitic load without the engine running, underhood light disconnected and the car doors closed:

- 10.1. Connect a 12-volt bulb in series between the negative battery cable terminal clamp and the negative battery terminal. If the bulb glows brightly, then start removing fuses one-at-a-time until the offending electrical component is identified.
- 10.2. A better approach is to use a DC amp meter inserted in series with the negative battery terminal. Starting with the highest scale, determine the current load. If the load is above 120 milliamps, then start removing fuses one-at-a-time until the offending electrical component is identified.

11. CAN I INCREASE THE LIFE OF MY BATTERY?

- 11.1. Protecting your battery from high under hood temperatures and keeping your battery well maintained are the **BEST** ways to extend the life of your battery. For cold climates, keeping the battery fully charged and the engine warm will help increase the life of the battery. In warmer climates and during the summer, the electrolyte levels need to be checked more frequently and **DISTILLED** water added, if required. This is due to high under hood temperatures. In a study conducted by the Society of Automotive Engineers (SAE), the under hood temperature has increased 30% since 1985. Chrysler studies have shown that relocating the battery outside the engine compartment has increased the average battery life by eight months. Heat shielding or relocating the battery to the trunk or passenger compartment, as Mazda did in their Miata a number of years ago, is becoming more popular. This battery placement is being used by a number of car manufacturers to protect the batteries from the high under hood temperatures. However, gel cell or AGM type batteries should be used because they produce little or no gas. Some battery manufacturers build “hot climate” or “South” versions by increasing the amount of electrolyte in the battery to provide more “cooling” or by special plate formulations.
- 11.2. In the warmer climates and during the summer, “watering” is required more often. Check the electrolyte levels and add distilled water, if required. Never add electrolyte to battery that is not fully charged—just add distilled water and do not overfill. The plates must be covered at all times. Keep the top of the battery clean.
- 11.3. Turning off unnecessary accessories and lights **BEFORE** starting your car will decrease the load on the battery while cranking, especially when it is cold.
- 11.4. Leaving your lights or other accessories on and fully discharging the battery can ruin your car battery, especially if it is maintenance free. If this should occur, you should load test the battery **AFTER** it has been fully recharged and with the surface charge removed to determine if there is any latent or permanent damage.
- 11.5. Reducing the parasitic (key-off) load to 120 milliamps or less.
- 11.6. In cold climates, increasing the diameter (smaller numbered wire gauge) of the battery cables will increase the power available to the starter motor.

12. WHAT ARE THE MOST COMMON CAUSES OF PREMATURE BATTERY FAILURES?

Normally, premature battery failures are caused by one of the single failures listed below. Prior to 1980, plate or grid shorts were the most common failure. Since then the manufacturers have significantly improved the reliability by using improved separators and plate alloys to reduce corrosion. Batteries that have been in use for longer periods of time will typically fail from multiple causes. All batteries will fail at some point in time.

- 12.1. High under hood heat or overcharging causes a loss of water (which account for over 50% of the failures) and accelerated positive grid corrosion or plate-to-strap shorts.

- 12.2. Sulfation from water loss, undercharging, or prolonged periods of non-use. (Please see Section 16.)
- 12.3. Deep discharges (such as leaving your lights on).
- 12.4. Misapplication or using an undersized battery that causes discharges greater than 10%.
- 12.5. Excessive vibration due to a loose hold down clamp.
- 12.6. Using tap water causes calcium sulfation.
- 12.7. Freezing.

13. HOW CAN I STORE BATTERIES?

Batteries naturally self discharge while in storage, and sulfation will begin occurring when the state-of-charge is 80% or less. Please see Section 16 for more information on sulfation. Cold will slow the process down and heat will speed it up. Here are six simple steps to store your batteries that will protect them from sulfation and premature failure.

- 13.1. Physically inspect for damaged cases, remove any corrosion, and clean the batteries.
- 13.2. Check the electrolyte levels and add distilled water as required, but avoid overfilling.
- 13.3. Fully charge or equalize [*controlled overcharge to equalize the voltage and specific gravity in each cell*] the batteries.
- 13.4. Store them in a cool dry place, but not below 32° F (0° C). Depending on the ambient temperature, periodically test the state-of-charge using the procedure in Section 4. When it is 80% or below, recharge using the procedures in Section 9, with an automatic [voltage regulated] charger.
- 13.5. An alternative would be to connect an automatic [*voltage regulated*] “trickle” charger to batteries using 13.8 volts and equalize the batteries every couple on months. An automatic charger will keep you from overcharging the batteries.
- 13.6. Equalize only wet (flooded) or AGM batteries when you remove the batteries from storage, using the procedure in Section 9.

14. WHAT ARE SOME OF THE MYTHS ABOUT BATTERIES?

- 14.1. Storing a battery on a concrete floor will discharge them.

A hundred years ago when battery cases were made of porous materials such as wood, storing batteries on concrete floor would accelerate the discharge. Modern battery cases are made of polypropylene or hard rubber. These cases seal better, so external leakage-causing discharge is no longer a problem, provided the top of the battery is clean. *Temperature stratification within large batteries could accelerate the internal “leakage” or self-discharge if the battery is sitting on a cold floor in a warm room or is installed in a submarine.*

14.2. Driving a car will fully recharge a battery.

There are a number of factors affecting an alternator’s ability to charge a battery. The greatest factors are how much current from the alternator is diverted to the battery to charge it, how long the current is available and the temperature. Generally, idling the engine or short stop-and-go trips during bad weather at night will not recharge the battery. Please see Section 5.

14.3. A battery will not explode.

Recharging a wet lead-acid battery normally produces hydrogen and oxygen gasses. While spark retarding vent caps help prevent battery explosions, they occur when jumping, connecting or disconnecting charger or battery cables, and starting the engine. While not fatal, battery explosions cause thousands of eye and burn injuries each year.

When battery explosions occur when starting an engine, here is the usual sequence of events: One or more cells had a high concentration of hydrogen gas (*above 4.1%*) because the vent cap was clogged or a defective valve did not release the gas. The electrolyte levels fell below the top of the plates due to high under hood temperatures, overcharging, or poor maintenance. A low resistive bridge or “treeing” formed between the top of the plates such that when the current started to flow, it caused an arc or spark in one of the cells. That combination of events ignites the gas blows the battery case cover off and spatters electrolyte all over the engine compartment. The largest number of battery explosions while starting an engine occurs in hot climates.

When an explosion happens, thoroughly rinse the engine compartment with water, and then wash it with a solution of one-pound baking soda to one gallon of warm water to neutralize the residual battery acid. Then thoroughly rewash the engine compartment with water. Periodic preventive maintenance (please see Section 3), working on batteries in well-ventilated areas or using Valve Regulated Lead Acid (AGM or gel cell) type batteries can significantly reduce the possibility of battery explosions.

14.4. A battery will not lose its charge sitting in storage.

Depending on the type of battery and temperature, batteries have a natural self-discharge or internal electrochemical “leakage” at a 1% to 25% rate per month. Thus, over time the battery will become sulfated and fully discharged. Higher temperatures accelerate this process. A battery stored at 95° F (35° C) will self-discharge twice as fast than one stored at 75° F (23.9° C). (Please see Sections 15 and 16.)

14.5. “Maintenance free” batteries never require maintenance.

In hot climates, the water in the electrolyte is “decomposed” due to the high under hood temperatures. Water can also be lost due to excessive charging voltage or charging currents. Non-sealed batteries are recommended in hot climates so distilled water can be added when this occurs. (Please see Section 3. for other preventive maintenance that should be performed on “maintenance free” batteries.)

14.6. Test the alternator by disconnecting the battery with the engine running.

A battery acts like a voltage stabilizer or filter to the pulsating DC produced by the alternator. Disconnecting a battery while the engine is running can destroy the sensitive electronic components connected to the entire electrical system such as the emission computer, audio system, cell phone, alarm system, etc., or the charging system itself because the peak voltage can rise to 40 volts or more. In the 1970s, removing a battery terminal was an accepted practice to test charging systems of that era. That is not the case today. Just say NO if anyone suggests this.

14.7. Pulse chargers, aspirins or additives will revive sulfated batteries.

Using pulse chargers or additives is a very controversial subject. Most battery experts agree that there is no conclusive proof that more expensive pulse chargers work any better than constant voltage chargers to remove sulfation. They also agree that there is no evidence that additives or aspirins provide any long-term benefits.

14.8. On really cold days turn your headlights on to “warm up” the battery up before starting your engine.

While there is no doubt that turning on your headlights will increase the current flow in a car battery, it also consumes valuable capacity that could be used to start the cold engine. Therefore, this is not recommended. For extremely cold temperatures, externally powered battery warmers or blankets and engine block heaters are highly recommended. AGM and Ni-Cad batteries will perform better than other types of batteries in extremely cold temperatures.

14.9. Car batteries last longer in hot climates than in cold ones.

Car batteries last an average of two thirds as long in hot climates as cold ones. Heat kills car batteries, especially sealed wet lead acid batteries. (Please see Section 11.1.)

14.10. Charging Cables or an Auto Jump Starter will start your car.

The cigarette lighter charging cable’s advertising states “charges weak batteries in minutes.” The charging cable products will certainly recharge your car battery if you have enough time and your battery is in good condition. Cigarette lighters are normally fused at 10 amps, so to be

safe they probably limit current flow to 7.5 amps. Given the size of the cord, the amount might be even less.

They work by applying higher voltage from the good battery to “recharge” the bad one. Now let’s assume it is a hot day and that you need just of 15% of the battery’s capacity to start the engine and that it is a 50 ampere-hour battery. This means you will need 7.5 amps for at least 60 MINUTES to flow from the good battery to the bad one. Now let’s also assume that it is a cold day and you have left your lights on. You will need at least 50% capacity or 25 amps to start the car. This will take at least 200+ MINUTES to charge the dead battery. Unless the engine is left running in the car with the good battery, you run the risk of running the good battery down to a point that it might not be able to start a car.

An auto jump starter uses special high current batteries to provide up to 900 peak amps to start your engine. It can provide 200-300 amps for up to 8-10 seconds. After this, the unit has to be recharged for 24 to 48 hours. Standard AA alkaline batteries are used to trickle charge the special batteries. This type of emergency starter should start all but diesel engines up to six or eight times, depending on the condition of the engine and the temperature.

14.11. A larger capacity battery will damage my car.

A starter motor will only draw a fixed amount of current from the battery, based on the resistance of the load. A larger current capacity battery supplies only what is required but will give you more starting capacity and will not damage your car. Using batteries with higher voltage can damage your car. Using batteries that are too large physically can also damage your car.

14.12. Car batteries have memories.

Lead acid batteries do not have the “memory effect” found with first generation Ni-Cad batteries. Deep discharges can damage car batteries and will shorten their lives.

14.13. Bad batteries will not harm the charging system or starter.

A bad or weak battery causes more stress on a charging system or starter and can cause premature failures due having to compensate the voltage or current. If you replace a battery, alternator, voltage regulator or starter, you should test the other components for latent or permanent damage.

15. HOW LONG CAN I PARK MY CAR?

The amount of time, usually referred to as “airport or garage time,” that you can leave your car parked and still start your engine is based on such things as the state-of-charge of the battery, the Reserve Capacity, the amount of natural self discharge and parasitic load, and temperature. Car manufacturers normally design for at least 14 days or more airport time; they assume a fully charged battery in good condition, moderate weather, and no additions to the original car’s parasitic load (for example, an aftermarket alarm system). When a battery drops to 80% state-of-charge or less, sulfation starts occurring, and this will reduce the capacity of the battery.

If you leave your car parked for more than two weeks, then you have several options:

- 15.1. The best option is to connect an automatic electric or solar float “trickle” charger to your car battery. *You will need 13.8 VDC and at least 0.5 amps to overcome the natural self-discharge and parasitic load.*
- 15.2. Install a battery with a larger reserve capacity.
- 15.3. Jump the battery and hope that there is no latent damage.
- 15.4. Connect a large, deep cycle battery in parallel.
- 15.5. Disconnect the negative terminal, but be sure that you have saved any security codes or radio stations that will have to be reprogrammed.
- 15.6. Plan to replace the battery if it fails to retain a charge, especially if it is over three years old or sealed, and you live in a hot climate.
- 15.7. Have someone drive your car during the day on the highway every two weeks 10 to 15 minutes to recharge the battery.

16. HOW CAN I REVIVE A SULFATED BATTERY?

Lead sulfation occurs when lead sulfate cannot be converted back to charged material and is created when discharged batteries stand for a long time. When the state-of-charge drops below 80%, the plates become coated with a hard and dense layer of lead sulfate that fills up the pores. The positive plates will be light brown and the negative plates will be dull, off white. Over time, the battery loses capacity and cannot be recharged.

16.1. Light Sulfation

Apply a constant current from one to two amps for 48 to 120 hours at 14.4 VDC, depending on the electrolyte temperature and capacity of the battery. Cycle (discharge to 50% and recharge) the battery a couple of times and test its capacity. You might have to increase the voltage in order to break down the hard lead sulfate crystals. If the battery gets above 110° F (43.3° C) then stop charging and allow the battery to cool down before continuing.

16.2. Heavy Sulfation

Replace the electrolyte with DISTILLED water, let stand for one hour, apply a constant current at four amps at 13.8 VDC until there is no additional rise in specific gravity, remove the electrolyte, wash the sediment out, replace with fresh electrolyte, and recharge. If the specific gravity exceeds 1.300, then remove the old electrolyte, wash the sediment out, and start over with distilled water. You might have to increase the voltage in order to break down the hard lead sulfate crystals. If the battery gets above 110° F (43.3° C) then stop charging and allow the battery to cool down before continuing. Cycle (discharge to 50% and recharge) the battery a couple of times and test capacity. The sulfate crystals are more soluble in water than in electrolyte. As these crystals are dissolved, the sulfate is converted back into sulfuric acid and the specific gravity rises. This procedure will only work with some batteries.

17. WHERE CAN I FIND MORE INFO ON BATTERIES?

Additional information sources about batteries can be found in the Battery Related Links on the Web server at <http://www.uuhome.de/william.darden/>. Most of the battery manufacturers have a Battery FAQ posted on their web sites in addition to product information. Web addresses will often change, so you can use an Internet search tool like <http://www.google.com/> or <http://www.dogpile.com/> to locate the new addresses.

Bill Darden always welcomes comments and questions at mailto:bjb_darden@yahoo.com. For additional information on deep cycle batteries, the Deep Cycle Battery FAQ maybe found on the Web server at <http://www.uuhome.de/william.darden/> or by requesting one via email from mailto:bjb_darden@yahoo.com.

[NOTE TO WEBMASTERS: I highly recommend that you link to <http://www.uuhome.de/william.darden/> for this FAQ rather than republishing it. This is because the FAQs and other information will be revised periodically to keep up with the advancements in batteries and the changing resources. Major revisions will have a new version number. Minor changes will be indicated with a new date. This RFQ is in the public domain and can be freely reproduced or distributed without permission.]