



This is a digital copy of a book that was preserved for generations on library shelves before it was carefully scanned by Google as part of a project to make the world's books discoverable online.

It has survived long enough for the copyright to expire and the book to enter the public domain. A public domain book is one that was never subject to copyright or whose legal copyright term has expired. Whether a book is in the public domain may vary country to country. Public domain books are our gateways to the past, representing a wealth of history, culture and knowledge that's often difficult to discover.

Marks, notations and other marginalia present in the original volume will appear in this file - a reminder of this book's long journey from the publisher to a library and finally to you.

### **Usage guidelines**

Google is proud to partner with libraries to digitize public domain materials and make them widely accessible. Public domain books belong to the public and we are merely their custodians. Nevertheless, this work is expensive, so in order to keep providing this resource, we have taken steps to prevent abuse by commercial parties, including placing technical restrictions on automated querying.

We also ask that you:

- + *Make non-commercial use of the files* We designed Google Book Search for use by individuals, and we request that you use these files for personal, non-commercial purposes.
- + *Refrain from automated querying* Do not send automated queries of any sort to Google's system: If you are conducting research on machine translation, optical character recognition or other areas where access to a large amount of text is helpful, please contact us. We encourage the use of public domain materials for these purposes and may be able to help.
- + *Maintain attribution* The Google "watermark" you see on each file is essential for informing people about this project and helping them find additional materials through Google Book Search. Please do not remove it.
- + *Keep it legal* Whatever your use, remember that you are responsible for ensuring that what you are doing is legal. Do not assume that just because we believe a book is in the public domain for users in the United States, that the work is also in the public domain for users in other countries. Whether a book is still in copyright varies from country to country, and we can't offer guidance on whether any specific use of any specific book is allowed. Please do not assume that a book's appearance in Google Book Search means it can be used in any manner anywhere in the world. Copyright infringement liability can be quite severe.

### **About Google Book Search**

Google's mission is to organize the world's information and to make it universally accessible and useful. Google Book Search helps readers discover the world's books while helping authors and publishers reach new audiences. You can search through the full text of this book on the web at <http://books.google.com/>



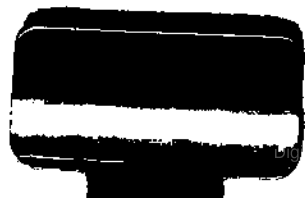





# STORAGE BATTERIES

A Handbook on the Storage Battery  
for Practical Men

by

C. J. HAWKS



Published by  
THE WM. HOOD DUNWOODY INDUSTRIAL INSTITUTE  
MINNEAPOLIS

COPYRIGHT, 1920, BY  
THE WILLIAM HOOD DUNWOODY INDUSTRIAL INSTITUTE  
MINNEAPOLIS, MINNESOTA

244974  
MAY -4 1921  
TNN  
H31

6970570

## CONTENTS

---

|   |       |
|---|-------|
| Foreword . . . . .  | 5     |
| Course—Object, advantages, scope . . . . .  | 7     |
| Introduction—primary and secondary batteries, battery use . . . . .   | 8-10  |
| Storage battery: parts . . . . .  | 11-13 |
| History of the storage battery . . . . .  | 14-17 |
| Groves gas cell, Faraday's lead cell, Plante's cell, pasted plates, Edison's nickel-iron cell.  |       |
| Chemical action. . . . .  | 18-24 |
| Chemical formulas explained, electrolyte, voltage, discharge, building-up capacity, chemical action.                                      |       |
| Lead cells: characteristics. . . . .  | 25-38 |
| Specific gravity, climate effect, state of charge, ampere-hour defined, temperature effect, voltage, capacity, life, internal resistance. |       |
| Nickel-iron cells: characteristics. . . . .   | 39-44 |
| Specific gravity, voltage, capacity, life, internal resistance.   |       |
| Storage battery efficiency. . . . .   | 45-51 |
| Parts, manufacture of. . . . .  | 52-67 |
| Types of plates, plate straps, plate separators, cells, cases, terminals.   |       |
| Assembly and electrical treatment . . . . .   | 68-74 |



|   |         |
|---|---------|
| Care and operation. . . . .   | 75-87   |
| Two classes of batteries, charging, E. M. F. cells,<br>routine and periodic tests.  |         |
| Tests and inspection. . . . .   | 88-94   |
| Voltage reading, high rate discharge test, cadmium test,<br>internal inspection.  |         |
| Internal symptoms. . . . .  | 95-103  |
| Buckled positives, cracked grids, growing plates, scaled,<br>loss of material, change in color, changes in consistency,<br>appearance of negative, separators, containers.  |         |
| Repair . . . . .  | 104-117 |
| Removing top sealing, welded connectors, cell covers,<br>cells from cases, dismantling elements, positive and neg-<br>ative groups, separators, jars, reassembling, electrolyte.  |         |
| Storage. . . . .  | 118-123 |
| Freezing, wet-storage, trickle charging.  |         |
| Design of batteries . . . . .   | 124-137 |
| Starting, lighting and ignition—aeroplanes, farm<br>lighting, emergency, meter testing, exciter, propulsion,<br>submarine, automobile, telephone, railway car lighting,<br>signals, mine lamps.   |         |
| Auxiliary apparatus. . . . .  | 138-157 |
| D. C. control, A. C. converters, mercury arc rectifier,<br>Tungar rectifier, electrolytic rectifier, commutator, ro-<br>tary converter, vibrating rectifiers, lead burning,<br>meters, hydrometers, thermometer, voltmeter, am-<br>meter, ampere-hour meter, tools, testing devices, pack-<br>ing for shipment. |         |

## FOREWORD

It is the custom of Dunwoody Institute to develop new courses of instruction largely through evening classes. These courses give extension training to workmen already employed in a trade during the day. As the instruction is given in a series of short units, each bearing on some important part of the trade, the information furnished the student must be very direct in its application to his needs. Frequently, no text on the market meets the situation and the instructor must, therefore, prepare his own lesson sheets.

These lessons are first mimeographed for use by the students. From year to year corrections and additions are made until it is felt that the material is ready for publication. Thereupon, a book is issued from the printing department of the school.

In this way this book on Storage Batteries was developed from the lesson sheets written by Mr. C. J. Hawks, Superintendent of the Minneapolis Depot of the Exide Battery Company, and instructor in Storage Batteries at the Dunwoody Evening School. From his experience in the use of the mimeographed lesson sheets he has adapted their contents in final form for this book which it is hoped will not only serve the needs of day, part-time and evening classes on storage battery work and service at Dunwoody, but be of use elsewhere as well.

C. A. PROSSER  
Director.



**LESSON I.**  
**THE COURSE.**

**OUTLINE.**

**I.—OBJECT.**

- (a) To provide a more scientific and complete knowledge of the electric storage battery.

**II.—ADVANTAGES.**

- (a) *Opens way to*
  - 1. Better positions.
  - 2. Individual business.
- (b) *Well informed men bring*
  - 1. Better care for batteries.

**RESULTS.**

- (a) Longer life for batteries.
- (b) Increased favor with public.
- (c) Greater volume of business.
- (d) More money to the battery worker.

**III.—SCOPE.**

- (a) *Theory*
  - 1. Definitions and parts (Lesson I.)
  - 2. History and development (Lesson II.)
  - 3. Chemical action (Lesson III.)
  - 4. Characteristics and efficiency (Lessons IV., V. and VI.)
- (b) *Practice*
  - 1. Manufacture (Lessons VII. and VIII.)
  - 2. Care (Lesson IX.)
  - 3. Diagnosis of difficulty (Lessons X. and XI.)
  - 4. Repair (Lesson XII.)
  - 5. Storage (Lesson XIII.)
- (c) *Unusual points*
  - 1. Construction of types (Lesson XIV.)
  - 2. Auxiliary apparatus (Lesson XV.)
- (d) *Sales methods*
  - 1. Operation of a service station (lecture only).

## GENERAL INTRODUCTORY REMARKS.

Before going into the subject of storage batteries, it is well for the student to bear in mind the two great classes of batteries, namely, those known as *primary* batteries; and second those known as *secondary* or *storage* batteries.

### PRIMARY BATTERIES.

Primary batteries are those which are used as generators of electric current and which furnish or originate their own energy. When the charge is exhausted in this type of battery it becomes necessary to renew one or both of the elements and the electrolyte.

### SECONDARY BATTERIES.

There is another class of battery, however, in which the component parts of the elements are insoluble at all times and the material at the end of discharge, although chemically changed, is still in the same mechanical position as it was at the beginning of the discharge. It is possible to recharge batteries of this nature by simply passing a current through the cell, in a direction opposite to the discharge current, until a somewhat greater number of ampere hours has been passed in this direction than was taken out on discharge. This converts the components of the elements and electrolyte or liquid back to their original chemical state and makes the battery ready for the next successive discharge of equal or greater capacity than the first. This class of battery is called a *secondary* or *storage* battery and also an *accumulator*.

### ELECTRICAL STORAGE.

There is a great deal of misunderstanding on the part of beginners in storage battery work as to what a storage battery actually does or what it stores.

It is natural for one to assume that a storage battery actually stores electricity. This is not the case, as there is not the slightest trace of actual electrical energy in a storage battery whether charged or discharged. There is a piece of apparatus which actually stores electricity in minute quantities, known as the condenser.

**ENERGY CHARGE.**

The purpose of the storage battery, however, is to convert electrical into chemical energy, which is stored until the poles of the battery are brought together through an external circuit, when an electric current is immediately set up and the *chemical energy* of the storage battery converted into electrical energy.

**ENERGY DEFINED.**

For those who do not understand the meaning of the term energy, it becomes necessary to explain that energy represents an indestructible force present in the universe in two great forms; namely, potential or static energy, which is energy at rest or in storage; and dynamic or kinetic energy, which is the energy of motion. Energy may not be destroyed, though it can be converted from one form to another as is done in the storage battery. Examples of static energy would be a weight placed upon a shelf; the chemical energy stored in the storage battery; and what is known as static electricity. Examples of dynamic energy would be an electric current, heat, light and motion.

**ENERGY LOSS.**

It will be readily understood, if the subject is given a little thought, how in most transformations of energy—for example, the conversion of electrical energy into the energy of motion in the electric motor—there is no energy lost. In a storage cell we do not get as much electricity out as we put in; nor as much out of a motor as we put in. The facts that the cells grow hot on charge and warm on discharge, and that, in the motor, in the same manner, most of the lost energy goes into heat, through friction, either electrical or mechanical, and is dissipated into the atmosphere, account for the major portion of these losses. In other words, what apparently is lost or destroyed energy is really converted into the energy of heat.

**BATTERY USES.**

Almost everyone is familiar with one or two of the uses of storage batteries and in this lesson we intend to bring to the student's notice the major ones. By referring to the following diagram an idea can be gotten of the immense field already open to storage batteries and the prospects of its enlargement. Appended to this list, we have a list of the special government uses in war work, which are of national interest.

**STARTING AND LIGHTING**

Motor cars  
Trucks  
Tractors  
Motor boats  
Aeroplanes  
Motorcycles (lighting only)

**FARM LIGHTING****CENTRAL STATION**

Emergency (insurance)  
24 Hr. service  
Oil switch control  
Meter testing  
Exciter

**PROPULSION**

Submarines  
Automobiles  
Trucks  
Mining locomotives  
Industrial trucks  
Industrial tractors  
Street cars  
Motor boats

**TELEPHONE****TELEGRAPH**

Fire alarm  
Police alarm

**WIRELESS TELEGRAPH****WIRELESS TELEPHONE****EDUCATION**

*Electrical Laboratory*  
Constant potential  
Portable  
*Physics*  
Constant potential  
Portable

**RAILWAY**

*Signal*  
Operation  
Lighting  
Car lighting  
Interlocking  
Bridge operation

**STEEL PLANTS**

Regulating

**ELECTRIC RAILWAY**

Regulating  
Emergency lighting

**MISCELLANEOUS**

Mine lamps  
Time recording apparatus  
School bell ringing

**WAR WORK.****NAVY**

Submarine propulsion  
Ship wireless  
Ship auxiliary lighting  
Turret auxiliary lighting  
Interior communication  
Telephone reserve supply  
Ignition and lighting motor boats  
Starting and lighting motor boats  
Turret auxiliary power  
Auxiliary steering power  
Submarine chaser  
Speed boat searchlight  
Gyrocompass  
Gun firing  
Aero starting and lighting  
Clothing heating  
Motion camera motor drive

**ARMY**

Aircraft bomb tests  
Motorcycle  
Aero radio  
Chronographs  
Air service mobile field light  
Air service landing light  
Liberty motor ignition  
Telephones  
Ordnance magazine lights  
*Signal Corps*  
Land radio  
Tank radio  
Telephone  
Field radio  
*Ordnance*  
Bag loading plant  
Industrial trucks and tractors  
Shell loading trucks  
Radio tractor  
Motor transport

## THE MAKE-UP OF THE STORAGE BATTERY.

### CLASSIFICATION OF PARTS.

The parts of storage batteries in general are classed under four great headings; namely, cells, cell cases or racks, cell connectors and terminals.

### CELL AND BATTERY DEFINED.

It is well in this connection to note the exact difference in meaning between the words cell and battery. The latter means an entire unit of storage equipment in use at any one point with all its immediate parts, while the word cell simply means one of perhaps many individual *containers*, each holding an *element* with its *electrolyte* or *liquid*.

### PARTS OF A CELL.

In the above, we have drifted, unconsciously, into a definition of the parts of a cell, which are: element, electrolyte and container.

### ELEMENT.

The element is usually taken to mean all those active and solid parts within the cell; that is, the positive and negative plates and their connecting straps, the separators and separator holddowns.

*Plates*—Under elements there is a further subdivision of the two plates. These always have two parts, the grid or support, and the active material. The construction of plates differs very much in various types, but these two parts are always present and their uses are well explained by their names.

### ELECTROLYTE.

The electrolyte, of course, includes only one thing, the liquid in which the element is immersed.

### CONTAINER.

The container, which holds all of the other parts of the cell, includes the jar or tank, as the case may be, the cover, and in some instances a suitable vent.

### CASE OR TRAY.

The cell case or tray, as it is sometimes called, is used to hold the cells together mechanically, in convenient form, for use. This sometimes takes the form of a simple rack and in some cases very large cells merely stand on the floor or suitable insulators.

### CONNECTORS.

The cell connectors are used to connect the cells electrically.



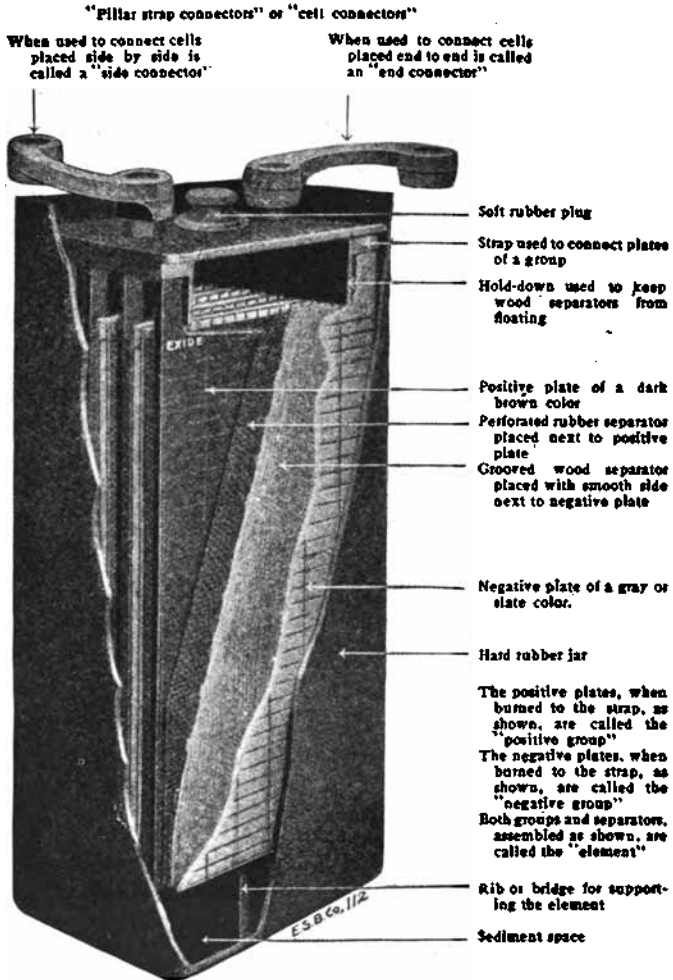

One 9-MV "Exide" Cell, Showing Parts Used and Method of Assembly

Fig. 1.

Those used at the ends of the individual groups of cells generally take a somewhat different form and are known as terminals. Figure 1 shows the parts named in the foregoing and their arrangement in the cell.

#### TERMINALS.

The terminals act as mediums of connection between the end cells and the external circuit or individual cell units. They are often made with a view to ready disconnection and reconnection; and again, the connections, especially in large stationary installations, are of a more permanent nature.

The forms which these parts take will be described later under other headings, the purpose of the foregoing being simply to impress on the student the different meanings of the part names in order to eliminate a great deal of confusion which arises in battery practice at the present time through lack of understanding of the meanings of these terms.

#### QUESTIONS.

1. To what class of cell does the ordinary "dry cell" belong and why?
2. May a primary cell be recharged by the passage of an electric current and why?
3. When an accumulator is fully charged, how much electricity is there in it?
4. What is stored in a storage cell?
5. How does the energy in an accumulator compare with that in a moving belt or shaft?
6. Could one storage battery be used to charge fully another of equal capacity?
7. State reason for your answer to number 6.
8. Name ten uses for storage batteries, other than auto starting and lighting and electric vehicle propulsion.
9. If you were called on to make a cell, what parts would you order out?
10. How would you make a battery, using this cell?

## LESSON II.

### HISTORY AND DEVELOPMENT.

In 1801, Gautherot, a French investigator, found that hydrogen and oxygen (formed by decomposing water by means of current passed between silver or platinum electrodes through a sulphuric acid solution) would reunite and cause a reversed current, if these electrodes were joined and the original source of current removed. One of two other investigators experimented further, until an Englishman, Sir Wm. Grove, developed a "Gas Battery" sufficiently large to maintain an arc lamp. This was simply a glass vessel containing dilute sul-

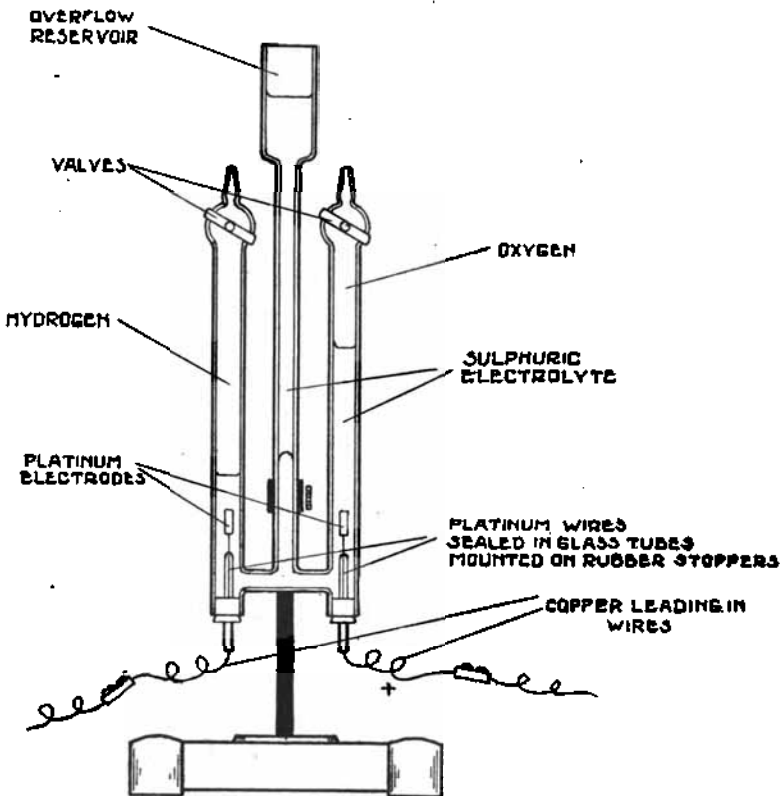

FIG. 1. GROVE'S GAS CELL, CHARGED.

phuric acid and equipped with platinum electrodes, for passing current through the liquid. In this apparatus, oxygen was liberated at the pole where the current entered, or positive, and hydrogen at the other. One form of this piece of apparatus was approximately like Fig. I.

This was the first storage battery principle, although of only laboratory interest and no commercial value, on account of the small capacity, expense and fragility of construction.

#### PARTS OF GROVE'S GAS CELL.

In this combination, the *active material* was really hydrogen and oxygen, the platinum electrodes being merely for carrying current and making contact with the electrolyte; in other words, the forerunners of the present *grid*. The electrolyte was simply water, which is composed of hydrogen and oxygen, with the sulphuric acid added to make the solution conductive. Pure water is a comparatively good insulator. At the end of the discharge, all of the gasses were reunited and returned to the electrolyte or liquid, in the form of water.

#### EARLY EXPERIMENTS WITH LEAD CELLS.

In 1834, Faraday, another great investigator of electrical phenomena, found that lead peroxide, deposited on suitable electrodes, could produce a reversed current, which would result in its decomposition. Others later used this substance in connection with plates of lead or silver and with the same result.

In 1859, a Frenchman, named Gaston Planté, began a series of experiments with the idea of developing a storage battery of commercial value. He found that if the plates of lead were immersed in a dilute sulphuric acid solution and a current passed from one to the other, a change in color of the lead would occur and the gas bubbles would not be liberated at once. The plate by which the current entered the cell (positive) would color brown, and the other would assume a grayer shade, on the order of slate. This combination was also capable of delivering current, in the reverse direction of the *charge*. By *recharging* the cell in the opposite direction, after each successive *discharge*, the combination would increase in *ampere hour* capacity, within certain limits, but up to a point where it could be of some real value. Fig. II shows his first well developed form of cell. In this form, he used two sheet lead plates, oblong in shape and very much longer than wide. These were rolled together with

strips of rubber or felt between, serving as the first separators, and the whole immersed in the electrolyte, contained in a suitable glass or earthenware vessel.

In this cell, the lead of course served as the grid. The active material was developed, on its surface, by the successive charges and reversals and to a greater depth each time. As the capacity of a storage cell is dependent mainly on the amount of active material in service, the capacity would naturally increase, the limit of course being the plate thickness. Active material is not sufficiently strong (mechanically) to hold together without a support and, as the action in this cell would go deeper on each discharge (complete), the life of these cells was limited to a point where the supporting lead would be all *formed* into active material. This storage battery principle, with modifications in manufacture to eliminate defects and expense, is still in use. Planté experimented about thirty years.

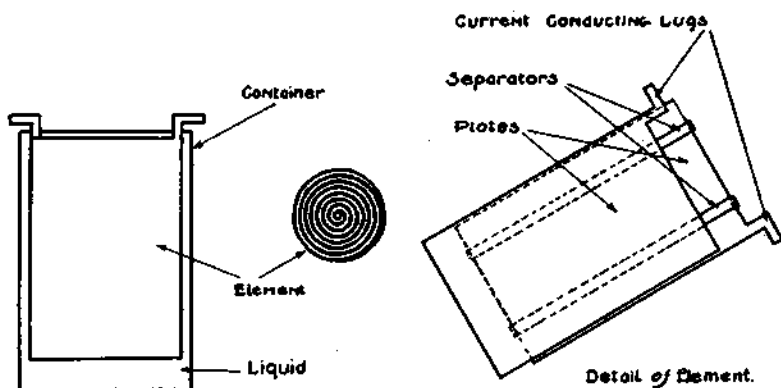

Fig. II. Planté's Cell.

#### PASTED PLATES.

Simultaneously and in 1881 another Frenchman, named Faure, and Brush, an American, conceived the idea that the chemicals developed by electrical action on the plates of Planté's cell could be reproduced by other means, apart from the cell, and placed, in the form of paste, on a supporting plate or grid. The idea was intended to do away with the long and costly system of charges and reversals necessary to work up the Planté cell to commercial capacity. It was a complete success, resulting in a form of cell which had much greater capacity with relation to weight; although the Planté cell, with its

modifications, would outlast the pasted product. For this reason, both types have lived, their characteristics making them suitable for different services. As a matter of fact, in pasted types the active material is not pasted in the plates in its final form. A short preliminary charging process was found essential to change the compositions of the pastes to their final forms on plates of both polarities, this method giving the necessary porosity and surface better than any attempt to produce these materials directly. This charging stage is known as *forming*.

#### USE OF ZINC IN STORAGE CELLS.

There were a number of other storage cell combinations developed; but none ever got beyond the laboratory, with one exception. For example, zinc used as a negative plate proved to give higher voltage than the lead to lead combination; but unless the elements and electrolyte were absolutely pure, local action would set in.

#### THE NICKEL-IRON CELL.

The one exception mentioned was the nickel-iron-alkaline combination. In this, the elements were nickel and iron with an alkaline electrolyte, differing radically from the lead cells in this respect. Its characteristics are also markedly different and there are some advantages. The idea was developed by T. A. Edison and put on the market in its present form in 1910. In the foregoing, we have avoided any discussion of the exact chemical actions which took place, or of later developments and manufacturing processes. These will be fully discussed in a later lesson.

#### QUESTIONS.

1. How long ago was the first storage cell principle discovered?
2. Describe it.
3. What were the elements?
4. Name two radically different principles in use today.
5. Describe the different principles on which all *lead* cells are used at the present time.
6. Give their respective advantages.
7. What prevented some of the principles from getting into commercial use?
8. What part did America play in storage battery history?
9. What is "forming" and why is it necessary?
10. Along what lines do you think storage batteries could be improved?

### LESSON III.

#### CHEMICAL ACTION.

The chemical action of the gas cell has already been outlined in Lesson II. In this lesson, we will confine our attention to the chemical actions of those cells representing principles in commercial use at the present time.

##### PLANTE CELLS.

In the Planté cell with electrodes of ordinary lead, the action of the electric current produces Lead Peroxide or Dioxide on the plate through which it enters. This is called the Positive Plate. This layer of Lead Peroxide, from its color, causes that electrode to turn a chocolate brown.

Lead Peroxide is a conductor of electricity. It is known by the color given above and is represented by the formula,  $PbO_2$ . In this, "Pb" stands for lead (from the Latin, Plumbum) and "O" for Oxygen.

##### CHEMICAL FORMULAS EXPLAINED.

All compounds or substances are either elementary in character; that is, composed of one substance, chemically known as an element; or complex, being composed of two or more elements. Elements are substances the decomposition of which is impossible so far as we know now. Lead and oxygen are examples. Lead is common enough, but Oxygen, though even more common in nature, is less generally understood. When uncombined, or free, this is a gas and, in this state, represents approximately one-fifth the contents of the earth's atmosphere or air. In combination with hydrogen, another elementary gas, it represents one-third the composition of water. In fact it is the commonest substance in nature.

Now these elements, while not decomposable, are *divisible* into minute particles known as *atoms*. In combinations of elements these atoms arrange themselves, according to set formulas, in a certain way, to form one *molecule* of the compound. In Lead Peroxide, for example,  $PbO_2$  means that one atom of Lead and two of Oxygen are in combination in every molecule of this oxide.

Every element is chemically represented by a letter, such as the above, and this is generally the first letter of the name. In some

cases, however, this letter is already in use, so the first one or two of the Latin are substituted, as with lead. This Latin name is represented in the old name for Graphite, Plumbago, which the Ancients thought was related to Lead. Compounds of elements have generally few, if any, of the characteristics of their various components.

To return to the action in the Planté cell, the same current reduces the surface suboxide of lead ( $Pb_2O$ ) to pure Lead ( $Pb$ ) on the plate by which it leaves (the Negative), and free Hydrogen is given off. Most metals are covered or coated with a lower Oxide, from standing in contact with the air, and this coating is what gradually causes them to lose their lustre. Now in these two actions, the O, from the Oxide, and  $O_2$  to make the Peroxide, must be accounted for, as elements are indestructible and cannot be made. They must come from, or go, somewhere.

#### THE ELECTROLYTE.

So far we have omitted to mention the liquid through which the current passes, or *electrolyte*. This is made of dilute Sulphuric Acid, or Sulphuric Acid ( $H_2SO_4$ ) and Water ( $H_2O$ ). "S" represents Sulphur or brimstone, an element very well known, and "H" Hydrogen, a very light gas, used commercially to fill balloons and which burns readily with a hot blue flame in air, combining with its oxygen to form Water. This fact readily illustrates our earlier statement that compounds may possess none of the characteristics of their components, as water is a liquid and its two elements gases.

To return to the electrolyte, it becomes apparent the  $O_2$  must come from it, to make the Lead Peroxide on the Positive by decomposing the water, leaving 2 ( $H_2$ ). A certain amount of this  $H_2$  combines with the O of the suboxide on the Negative, thereby reducing it to Lead. The balance comes up from the Negative in the form of gas. The breaking up of the water raises the specific gravity of the liquid slightly. *We now have a cell*, with its positive coated with Lead Peroxide ( $PbO_2$ ), its Negative with Lead ( $Pb$ ) and an electrolyte of Dilute Sulphuric Acid ( $H_2SO_4 + H_2O$ ).

#### FACTORS FIXING VOLTAGE.

Practice has shown that this combination will show a Difference of Potential or Voltage of about two volts. This and other basic facts in Chemistry are unexplained, they simply occur; but we know that the same combination always gives the same result. Hence, the Voltage of a Cell is dependent on its components and *not size*.



There is another fact interesting here which is, that electrodes to produce a Voltage must be unlike. This is realized in the Lead and Lead Peroxide, which are different.

When a Voltage or Pressure is present, Electricity teaches us that it merely becomes necessary to close the circuit, when a current will flow, the value of which is dependent on the resistance of the circuit. (See Ohm's Law.)

We now have a cell *capable of producing Electric current*, and we will proceed to connect the electrodes or poles, thereby closing the circuit, and discharge this cell, to see what happens.

#### THE CHEMICAL ACTION ON DISCHARGE.

As the current flows, our Lead Peroxide (PbO<sub>2</sub>) and the acid of the Electrolyte (H<sub>2</sub>SO<sub>4</sub>) combine to form Lead Sulphate (PbSO<sub>4</sub>) on the plate and leaving Water (H<sub>2</sub>O) in the liquid with a certain amount of free oxygen. The Lead (Pb) of the Negative also combines with the acid (H<sub>2</sub>SO<sub>4</sub>) to form Lead Sulphate (PbSO<sub>4</sub>) on the plate, leaving the H<sub>2</sub> free to combine with the O left from the Positive to form more water (H<sub>2</sub>O). When the plates are all reduced to Lead Sulphate, the action stops, as they are then alike. In the process much acid has been decomposed and extra water formed so that the specific gravity is reduced. It becomes apparent why specific gravity is an indication of State of Charge *in a lead cell*. The actions outlined above are represented graphically as follows:

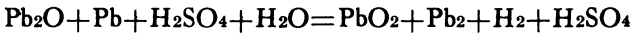

*On Initial Charge*

#### PLANTE CELL.

Charge

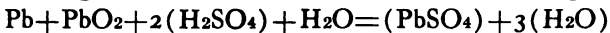

Discharge

*Later Cycles.*

#### BUILDING UP CAPACITY.

*When the totally discharged or zero voltage state is reached*, Planté made a practice of carrying on the current in this direction, thereby charging the battery up reversed. In this process the material which was peroxide becomes converted into lead. On account of its structure, this lead is of a spongy nature, with greatly increased surface and resultant capacity. The peroxide is now formed on the other plate. Successive reversals of this sort developed a deeper layer

of peroxide and sponge lead or active material, thereby building up capacity very much. In later years, this reversal process has been done away with, by the action of nitric acid or chlorine. Care must be used afterward to remove these agents, as they would otherwise go on "forming" the plates to a breaking point. Also a grid of lead and antimony alloy is often used, even in Planté plates, to eliminate certain warpings and growings and otherwise increase the life, by being less subject to the forming action of the current at ordinary temperatures. The importance of excluding certain impurities from the liquid can readily be understood from the above.

#### PASTED TYPES.

Now as stated in Lesson II, Faure and Brush shortened the forming process in another way. They made grids of lead and filled them with pastes made from the lower oxides of lead and sulphuric acid, giving a short forming charge only after drying. Today these grids are highly developed castings of antimonious lead, the negative being pasted with litharge (PbO) mixed with acid and the positive with red lead (Pb<sub>3</sub>O<sub>4</sub>) and ammonium sulphate. This serves as an expander. Other ingredients are also used, depending on the manufacturer, as binders. On charge the litharge is reduced to Lead of a spongy texture from the first on account of the elimination of the oxygen; and the Red Lead is elevated to Lead Peroxide. Later actions are the same as given for the Planté types.

The following diagram, however, gives a more exact idea of the commercial cell:

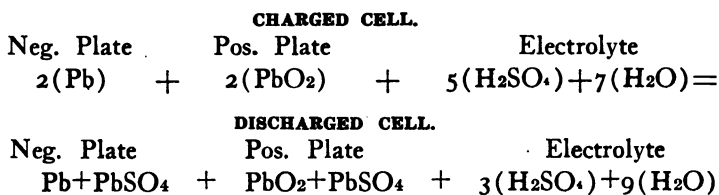

#### CHEMICAL ACTION IN BRIEF.

*In summing up these actions, it makes a good, brief, and easily understood explanation to say that on discharge the acid enters the plates and is driven out on charge. This is true only chemically, of course. When the charge is complete, the acid is all driven out and the specific gravity of the electrolyte stops rising. Thus we have the basic rule for determining the finish of charge for lead storage batteries.*

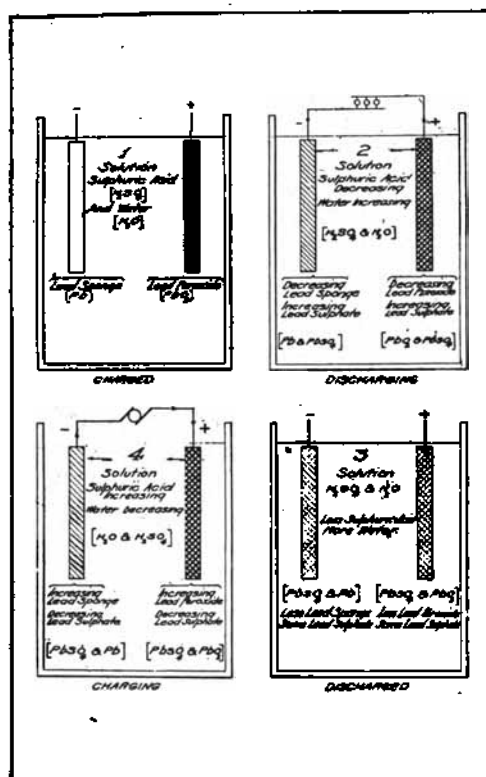

FIG. J. PICTORIAL OUTLINE OF CHEMICAL ACTION IN LEAD STORAGE BATTERY.

#### NICKEL-IRON-ALKALINE CELLS.

After covering the chemical actions of the lead storage cell types, it becomes necessary to say a few words about those of the *nickel-iron-alkaline* types, as these are used to a large extent and represent the only other type of present commercial importance. Here we have a positive plate of nickel-plated steel, filled with a mixture of flaked nickel and nickel hydroxide  $Ni(OH)_2$  and a negative of nickel-plated steel, filled with powdered iron oxide ( $Fe_2O_3$ ). "Fe" is from the Latin "Ferrum", Iron.

The electrolyte is a 20% solution of Potassium Hydroxide commonly known as Caustic Potash (KOH) and also as Potassium Hydroxide, with a little Lithium added. The "K" in the above formula is from the Latin "Kalium" or potassium. It is a metal, not com-

monly seen free, though its salts or compounds are well known. Potash is an oxide. Lithium is another metal closely related and commonly found in mineral waters, in the form of Lithia.

A twenty per cent solution or one part Caustic in four of Water has a specific gravity of 1,200. During the initial charge, the Nickel Hydroxide is raised to Nickel Peroxide ( $\text{NiO}_2$ ) and the Iron Oxide or Rust is reduced to Metallic Iron ( $\text{Fe}$ ). On discharge the nickel salt is changed again, but to a lower oxide ( $\text{Ni}_2\text{O}_3$ ), and the Iron is converted back into Rust ( $\text{Fe}_2\text{O}_3$ ). Subsequent recharges produce again Nickel Peroxide and so on throughout the life of the cell. No change is apparent in the electrolyte, during any of these actions. Although some of its salt is decomposed, it is immediately reformed in equal quantity. The average discharge voltage of these cells is 1.2. In the earlier designs, flaked graphite was used in the plates, instead of metallic nickel. In the absence of any change in specific gravity during charge and discharge, this cell must be charged by Voltage or Ampere hours. The electrolyte density does change, during the life of the battery; but this is due to loss of the salt, through absorption of Carbon Dioxide or Carbonic Acid Gas from the air and the formation of a creeping salt. When a certain point is reached, new electrolyte must be put in. To retard this loss, water, which is not only pure, but free from dissolved air, must be used.

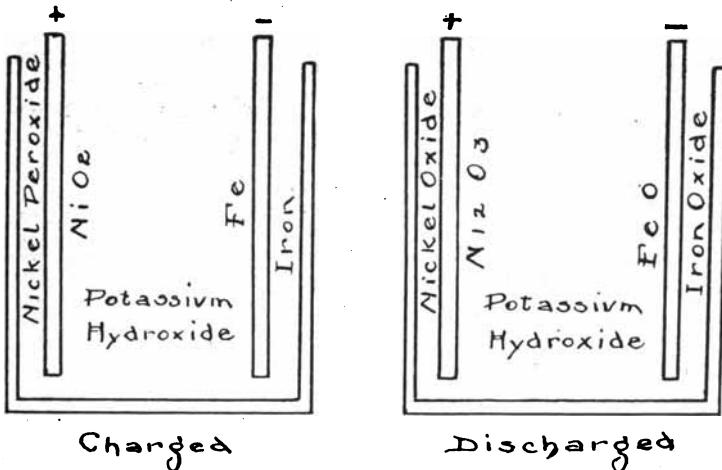

PICTORIAL EXPLANATION OF CHEMISTRY  
OF NICKEL-IRON CELL.

## ACTIONS SHOWN GRAPHICALLY.

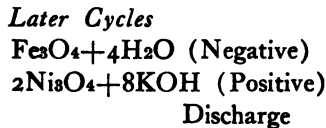
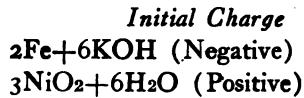
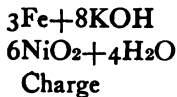
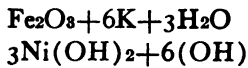

## QUESTIONS.

1. What color is a charged lead, positive plate and what causes this color?
2. What color is a charged lead, negative plate and what gives it this color?
3. Without using technical terms, what would you tell a man who asked you what went on within a lead storage battery?
4. How would you answer the same question, to a man whom you knew to be technically inclined?
5. Explain in detail what is meant by  $\text{H}_2\text{SO}_4$ ?
6. How does a knowledge of storage battery chemistry help in their operation? Give details.
7. What radical differences are there in the composition of lead and nickel-iron cells?
8. What differences in the actions which take place?
9. Why has nickel-iron auto lighting battery five cells, while its lead equivalent has but three, and what definitely fixes this relation?
10. In an emergency, how could a nickel-iron battery be used to purify the air in a room or vessel; for example, a submarine?

## REFERENCES.

Encyclopedia Britannica (Accumulator); Lamar Lyndon, S. B. Engineering; The Edison Alkaline Storage Battery (No. 804). Pub. by The Edison S. B. Co., Orange, N. J.

## LESSON IV.

### CHARACTERISTICS OF LEAD CELLS.

It has been explained that the two existing types of storage cells are lead and nickel-iron. We will first take up the characteristics of the lead cell. Characteristics are details of performance, under varying conditions. These are specific gravity, voltage, capacity, life, and internal resistance.

#### SPECIFIC GRAVITY.

Specific Gravity is the relation between the density or weight per unit of volume of any substance and a standard. For gases, the density of Hydrogen is considered one, as it is the lightest gas. Water is considered one, for liquids and solids, as it is the most common. The specific gravity of Sulphuric Acid, ordinarily pure, is 1.835. This means that a cubic foot of it would weigh 1.835 times as much as a cubic foot of water. In a mixture of the two, the specific gravity is proportional to the percentage of acid. Hence, the specific gravity of the electrolyte is a measure of the percent of acid.

We already know that, in a lead cell, the electrolyte or liquid is made of a mixture of Sulphuric Acid and Water. The proportions of the two depend on two things, the design of the cell and the climate in which it is to be operated. In mixing electrolyte and to avoid explosion, water is always added to acid. Never the reverse.

#### EFFECT OF DESIGN.

With a few exceptions, the percentage of acid in lead cell electrolyte is apparently adjusted so that they will be normally discharged at 1.160 specific gravity.

When, for reasons of design, there is a large amount of the electrolyte in comparison with plate weight, the range in specific gravity, meaning its variation from full charge to complete discharge, is less. When the weight of electrolyte is lower in proportion to plate weight, the range is greater. This is because, when discharging, plates absorb chemically a certain amount of acid per pound of active material. Let us assume that this amount in a certain cell is one-tenth pounds. We will also assume that there is one pound of electrolyte per pound of plate. Under these conditions and during a discharge, the density would drop a certain number of points. Now let

us assume that we put the element in a larger jar, with two pounds of acid per pound of plate. The drop in density, during discharge, would be one-half the other figure. On charge, of course, the density returns to its original point.

#### VARIATION IN RANGE.

In practice, lead cells in glass jars or lead lined tanks have a small range. These have a large amount of space all around the plates and wide plate spacing and, hence, there is much electrolyte, in proportion to plate weight. This range is generally about fifty points. In temperate climates, these are adjusted to 1.210 Sp. Gr., at 70° F., when fully charged. These cells are used in stationary work. Semi-portable cells, in rubber jars or lead-lined tanks, for railway car lighting, have a smaller amount of acid space, in proportion to plates, and a larger range. These are adjusted to 1.220, under the same conditions. Farm lighting cells, in glass, come next with 1.250 final specific gravity. Cells, in rubber jars, for propulsion and farm lighting services, with less space for liquid above and below the plates and closer plate spacing, are adjusted to a final specific gravity of 1.280. The very small portable types, used particularly in Starting, Lighting, and Ignition service, represent the limit in condensation of space occupied and their final specific gravity is 1.300.

#### FEATURES LIMITING RANGE.

Thirteen hundred (1.300) specific gravity, as it is commonly called, is the upper limit at which a lead storage cell will properly charge. Eleven sixty (1.160) seems to be the lowest point at which good voltage regulation can be gotten, at high discharge rates. As plates charge more efficiently in lower density electrolyte, it becomes essential to design a type cell with the lowest charged specific gravity for the service required and space available. There are, however, some special reasons why the lower limit is exceeded. In signal work, a type has been designed, discharging to 1.050 at the low rates required, which is comparatively free from injury from long standing in this state and which it is almost impossible to overdischarge. There is another type for propulsion service with an immense range (1.280-1.100) permissible on account of unusually good allowance for circulation in the liquid.

#### EFFECT OF CLIMATE.

In tropical climates, lead cells will give increased capacity, mainly because the electrolyte resistance is less when hot. At higher tem-

peratures, the effects of certain impurities and of the electrolyte on the interior cell parts is increased. As cells give more capacity when hot, it is permissible to reduce the specific gravity, thereby lowering the capacity to the temperate value and nullifying the harmful effects of heat. Cells adjusted for temperate climates should never be allowed to exceed 110 F. It is customary to reduce the temperate climate adjustment 75-80 points for tropical climates in Starting and Lighting Service and the same per cent for other services. Cells may be worked at temperatures up to 125 F., with this adjustment. Sometimes cells are worked in localities having very hot weather in summer while cold in winter. In these instances, it is impractical to adjust the bulk of the cells, from season to season, and a large shortening of cell life is only avoided by great care in operation.

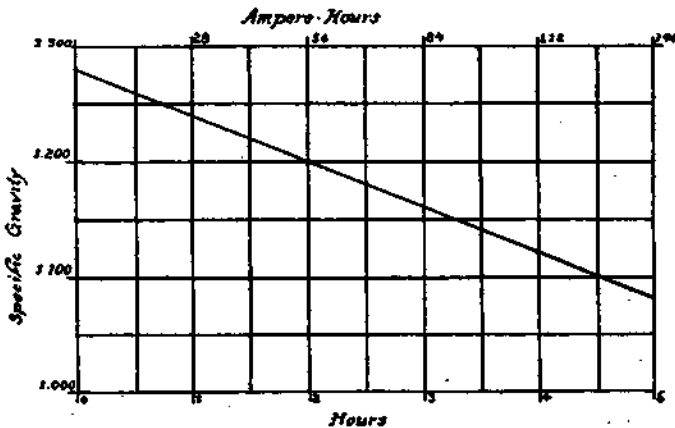

FIG. 1.

#### EFFECT OF DISCHARGE ON SPECIFIC GRAVITY IN REPRESENTATIVE PORTABLE LEAD CELL

##### EFFECT OF STATE OF CHARGE.

As stated previously, specific gravity decreases during discharge and increases during charge in lead cells. This variation is directly proportional to the state of charge or per cent of full capacity left in the cell. For example, if the range in specific gravity of a cell is 180 points or 1.100-1.280, the ampere hour capacity is 126 and the specific gravity reading happened to be 1.190, it would be safe to assume the cell half empty or half discharged. Points of specific gravity and ampere-hours can be translated one to the other, if the



above factors are known. In the example given, each ampere-hour would represent  $180/126$  or 1.52 points and a point of specific gravity would be  $126/180$  ampere-hours or .70.

AMPERE-HOUR DEFINED.

All cell capacities are measured in ampere-hours. This unit is obtained from the product of amperes or rate of current flow and of the time in hours. If a current of 28 amperes flows for  $4\frac{1}{2}$  hours, we have 28 times  $4\frac{1}{2}$  or 126 ampere-hours.

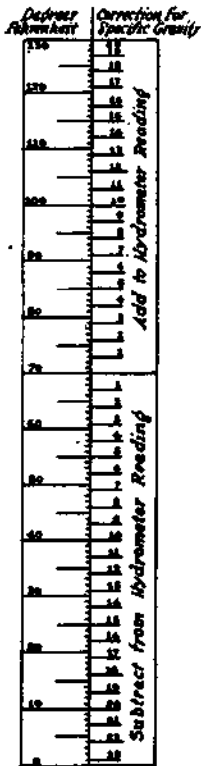

FIG. II

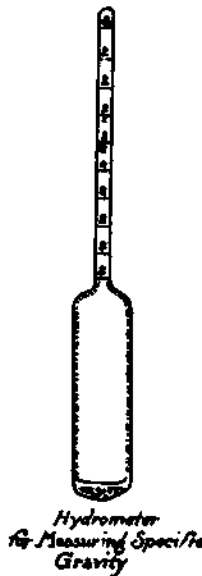

FIG. III

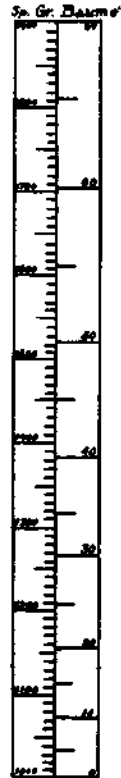

FIG. IV

EFFECT OF TEMPERATURE.

The apparent reading of specific gravity in an electrolyte is subject to a variation from its temperature. In order to get uniform results from tests made at different times, a correction must be made. For all practical purposes, a correction of +1 point for every three

degrees above 70°F. should be made to the apparent reading and -1 for every three below. For example, if a cell specific gravity showed 1.263 at 100°F. on Monday and 1.273 on Tuesday at 70°F., the actual density is the same. The correction is shown for all temperatures in Figure II.

#### SPECIFIC GRAVITY MEASUREMENT.

Specific Gravity is measured by an instrument known as a Hydrometer. This generally has a tube, with scale enclosed, and a bulb of shape to suit the service, so weighted that the instrument will float upright in a liquid. It floats higher in heavy liquids and lower in light. Density is marked directly on the scale. One form is shown in Figure III. Some have flat bulbs to go in narrow spaces. These are floated directly in open jars. Others are enclosed in glass

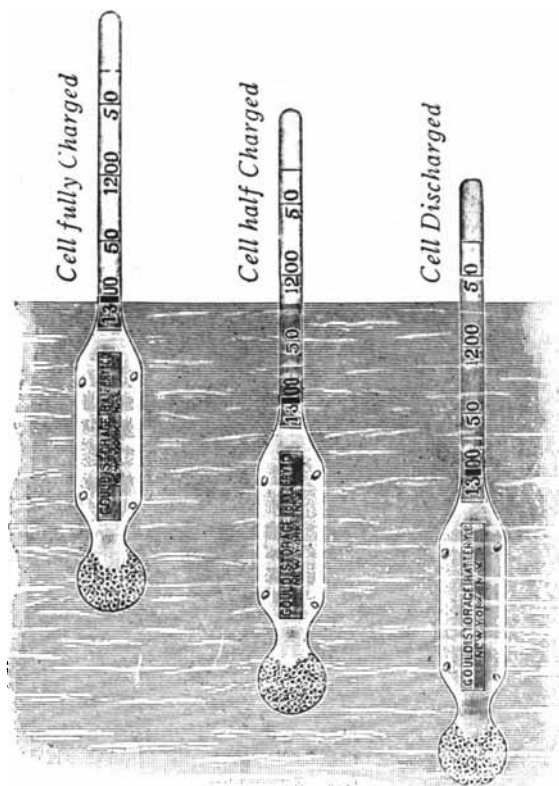

GOULD S.B. CO.

FIG. IVA.

syringes for use in sealed jars. Two scales are used: The Baumè and Specific Gravity. The comparison is given in Figure IV. Fig. 4A shows method of reading hydrometer.

#### VOLTAGE.

In a lead cell, the average discharge voltage is 1.95. Voltage is varied by four things: the temperature of the electrolyte and element, the age of the plates, the state of charge and the conditions in the external circuit. *Cell size has nothing whatever to do with it.*

#### EFFECT OF TEMPERATURE.

The hotter a lead cell interior is, the higher will be its voltage on discharge, other conditions being equal. This is partly due to the fact that the electrolyte has a lower resistance to the current when hot. Ohm's law for electrical circuits teaches us that with lowered resistance, at the same current, less voltage is required. External voltage is the difference between the internal and the loss due to cell resistance. With less voltage required to overcome cell resistance, the external voltage is higher. On charge, this effect is reversed.

#### EFFECT OF AGE.

As lead plates grow older, their discharge voltage remains about the same, but that required for charging is generally lower. In everyday words, the voltage does not come up as high on charge. This is very likely due to the increased absorption of acid into the internal parts and the consequent lessening of the internal resistance. Of course, as batteries grow *very* old, compared to their average life, the capacity drops off and a discharge is over sooner. This is an indirect lessening effect on discharge voltage.

#### STATE OF CHARGE.

When fully charged, of course, cells will give greater voltage. This effect is pretty well tied up with that of the external circuit conditions.

#### CONDITIONS IN EXTERNAL CIRCUIT.

On charge, at normal rate, lead cell voltage rises from about 2.15 to 2.55. The curve in Figure V shows details of this rise. Increase in rates raises the value of voltage at any point in the curve and decrease lowers it.

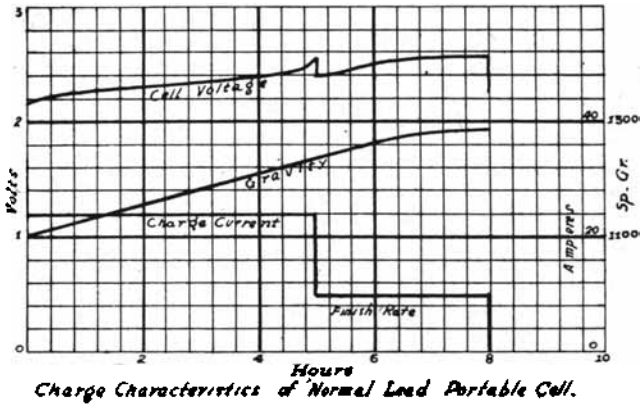

FIG. V.

GASSING.

When the cell voltage passes 2.4, gas is evolved from the electrolyte. This is due to the increased depth of the material yet to be reduced, which in turn prevents the current from reducing this material at the same rapid rate. The current not utilized falls to decomposing water from the electrolyte, evolving the gases of its composition. It is customary to limit the charging rate, when this gassing starts, as it is evidence that not all of the current is being used. This effect and temperature are the only limits for charge rate.

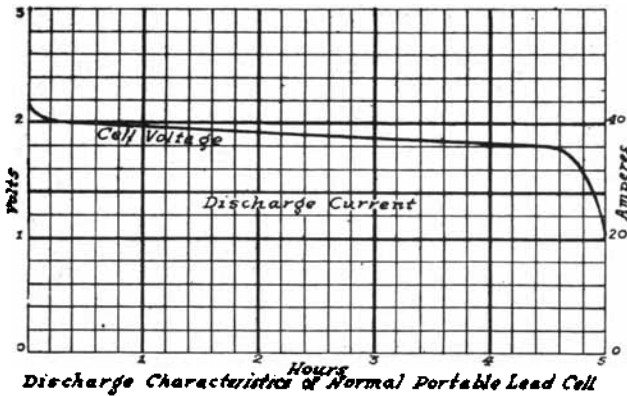

FIG. VI.

On discharge the voltage decreases from about 2.10 to 1.70. Increases in rate decrease this voltage. Details of a normal discharge are shown in Figure VI. Discharge could, of course, be carried on

to zero; but, if the student will examine the curve in Figure VI a sharp turn from 1.80 to 1.70 will be noticed. Sulphate of lead occupies more space than the fully charged active materials and, as the discharge progresses, gradually closes the plate pores, in time shutting out access to the electrolyte. Voltage falls off, as the cells make an effort to keep up the same current. As most forms of commercial apparatus depend for service on a fixed voltage, it is impossible to get any value from the discharge of a battery at the lower voltages. Certain plate distortions also occur, which will be handled as a separate subject later.

On open circuit, voltage varies a small amount, from full charge to complete discharge; but the amount is so small that *voltages, taken in this manner, are of no value in determining state of charge*. If a cell has already reached a voltage of 1.70 on discharge, for example, due to the effect mentioned above; on open circuit, it will recover at once as the electrolyte can enter the partially closed pores at a reduced rate. This allows the voltage to pick up, when there is no discharge to reduce it.

#### CAPACITY.

Capacity of cells is dependent on weight of active material in service. Plate area and thickness mainly influence this, but the make-up of a plate does also. For example, Planté plates have less active material in service per pound than Faure types, and, therefore, larger plate areas and thicknesses are used to get equal results.

Capacity is varied by Temperature, Amount of Service, Discharge rate, and Specific-gravity Adjustment. Capacity of a *battery* in ampere-hours is the same as that of one *cell* in a series. For parallel connection, and series-parallel, it is the sum of the capacities of parallel cells. Watt-hour capacity of a battery is the sum of all the cell watt-hour capacities, no matter what the arrangement.

#### WATT-HOUR CAPACITY.

Of a cell, watt-hour capacity is simply the ampere-hour capacity, multiplied by the average discharge voltage for the rate used.

#### EFFECT OF TEMPERATURE.

Cells should give their normal capacity at 70°F. For each degree higher, the capacity of a lead cell is increased one-half of one per cent ( $\frac{1}{2}\%$ ), and, for each degree lower, is decreased by the same amount. At 40°F., for example, the available capacity would be

$70^{\circ}-40^{\circ}=30^{\circ}\div 2=15\%$  correction.  $100\%-15\%=85\%$  at  $40^{\circ}$ . With the capacity 126 ampere-hours at  $70^{\circ}$ , at  $40^{\circ}$  it would be 126 times .85 or 107.1 ampere hours. We mean here the actual temperature of the electrolyte and not of the outside air. Curve on Figure VII gives the per-cent effect for all temperatures.

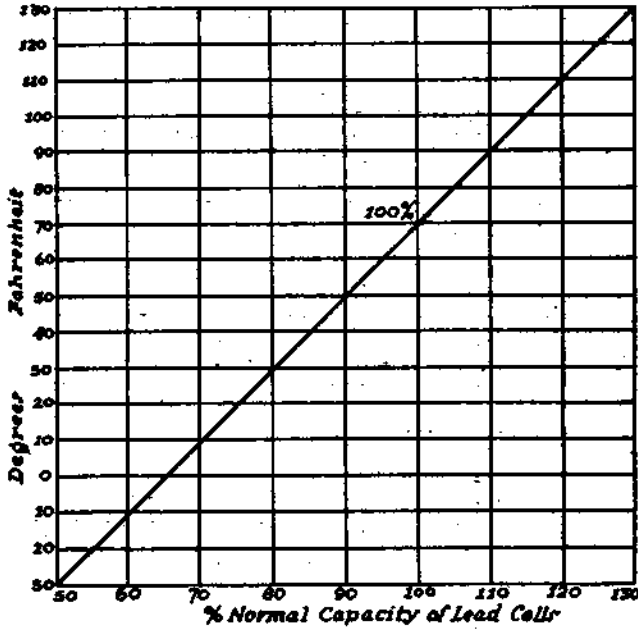

FIG. VII.

**EFFECT OF SERVICE.**

In service, lead cell capacity builds up, at first, and then decreases, as the end of cell life draws near. The effect is more rapid, if each discharge is carried to completion, and practically nil in batteries which float fully charged all the time. It is due to deepening of the layer of active material, with each cycle, particularly on the positives. In pasted types, the negative material is all active after the initial charge; but that of the positives is only so on the surfaces.

**CYCLE DEFINED.**

A cycle in storage battery operations is a discharge with its ensuing charge.

## CAPACITY INCREASE EXPLAINED.

As cell life goes on, the layers of active material on both sides of the plates grow together and limit the deepening and the resultant increase of capacity. Loss of material, at the surface, or grid disintegration gradually catches up with the effects mentioned above, causing capacity first to remain constant and then decrease. Capacity variation, during the life of a lead cell and under average conditions, is shown in Figure VIII.

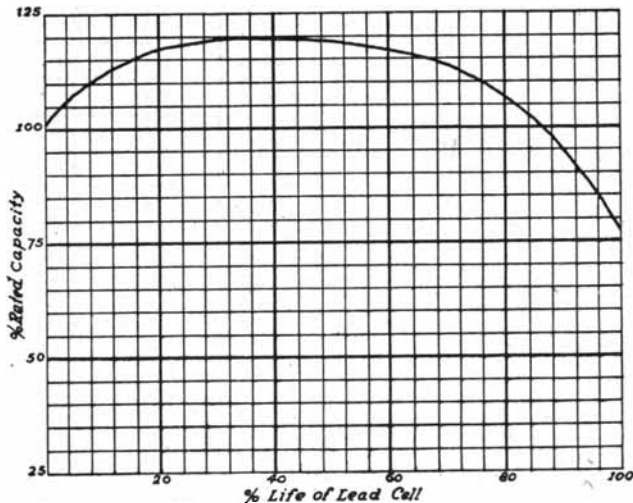

FIG. VIII.

## EFFECT OF DISCHARGE RATE.

At the higher rates, lead cell capacity is reduced. Roughly, if a Planté cell gives 100%, at the eight-hour rate, its five-hour capacity will be 87½%. At the three-hour rate 75% is obtainable, and at its one-hour capacity, 50%. For example, we will assume that a cell capacity is 100 ampere-hours, at the eight-hour rate, or 12½ amperes. For five hours it would give 17½ amperes; for three, twenty-five amperes and, for one, 50 amperes. For all rates, this variation is shown in Figure IX.

The variation in the Faure types is, if 100% at five hours, 85% at the three-hour and 65% at the one-hour rates. Figure X gives the variation for all rates. By placing one on the other and viewing them against a light, the difference can be noted; that is, a slight advantage, at the higher rates, for Faure types.

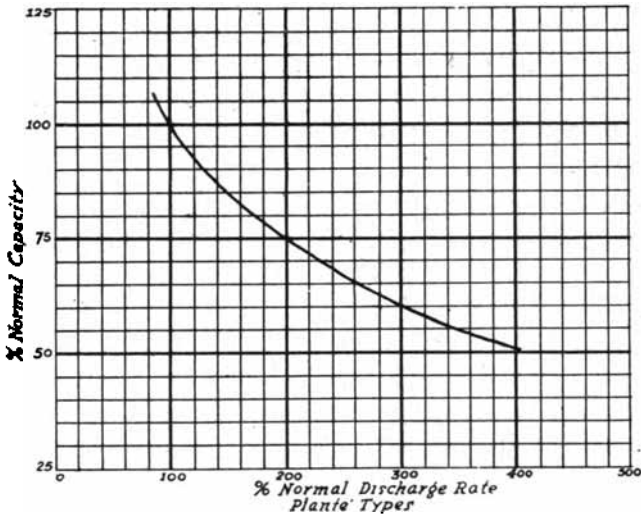

FIG. IX.

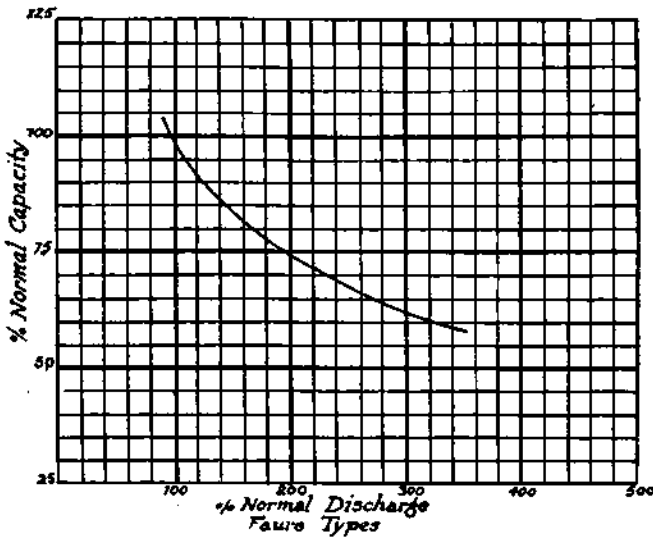

FIG. X.



**SPECIFIC GRAVITY ADJUSTMENT EFFECT.**

In a lead cell low specific gravity adjustment causes a drop in capacity and vice versa; but the effect is small compared with variation in specific gravity. This can be judged from the immense correction possible for tropical climates.

**INTERMITTENT SERVICE.**

The recovering effect, mentioned under voltage, also has an effect on capacity, raising this in intermittent service. On the average, this effect is greater in larger cells, and, of course, depends upon the exact nature of the service.

**LIFE.**

Life of cells is usually measured in cycles, the definition of which is given above and under that heading. It is varied by construction, manufacturing details, and care. Guarantees may be expressed in time, miles, ampere-hours, or other units; because they are more easily determined, but the makers generally have in mind average cycles under these conditions. To go into a little more detail, life is really measured in charges, as most of the disintegrating effects take place during this process; but, of course, each charge is generally followed by its discharge, making the cycles. The possible exception to this is with cells which are floated continuously with a generator or which stand idle for long periods. The life of these cells is affected by time.

**EFFECT OF CONSTRUCTION.**

Planté types last longer than the Faure, good makes averaging from 1000 to 3000 cycles, in the various services and with good care. Standard Faure types average from two to eight hundred cycles, under the same conditions. With these, variation in design plays a great part. Very thin plates, more of which can be gotten into a jar than of the thicker ones, may be used to get immense capacity on a single discharge or high voltage at high discharge rates, due to lessened resistance. The life of thin plates in cycles is shorter, but the total ampere-hours on all discharges throughout the life is usually about the same as with thicker plates. Hence, this variation in design makes the lead cell more flexible and able to meet variable conditions.

**MANUFACTURING DETAILS.**

There are around 100 lead storage battery manufacturers in the United States. The quality of their product is mainly determined

by its life in the service for which designed. The fact that the bulk of the business is divided among a few is evidence that details of manufacture, such as formulas for paste, etc., influence this characteristic to a great extent.

#### EFFECT OF CARE.

This effect is more or less self evident and true of all forms of apparatus. With storage batteries, however, its effect is more pronounced on life than on other characteristics and there is usually very little external warning of its influence until the end is at hand.

#### INTERNAL RESISTANCE.

In lead cells, the internal resistance is very low, being measured in one-thousandths of an ohm. For example, .003 ohms. It is varied by temperature, specific gravity, and plate area as explained above.

#### EFFECT OF SPECIFIC GRAVITY.

The specific gravity of minimum resistance is 1.224. It increases for variation in density either way. When cells are connected in series, their individual resistances are added to give the resistance of the battery. If connected in parallel, the resistances of the cells are divided by the number of cells in parallel.

#### QUESTIONS.

1. When questioned as to how they charge batteries, some men say, "Until the specific gravity comes up to about 1.300." What is the objection to this rule?
2. Suggest one better suited to lead battery characteristics.
3. Some classes of automatic charging apparatus open the circuit when the battery voltage reaches about 2.55 volts per cell. What might occur to prevent a battery, charged in this manner, from getting the correct charge?
4. Upon unpacking a new battery, received from the factory, a Distributor tests the voltage of each cell and finds them reading two volts. Is the battery charged and ready to sell or isn't it?
5. What effect has cold weather on the mileage per charge of an electric vehicle and why?
6. Would the same vehicle give as much mileage per charge in Duluth, which is very hilly, as in Minneapolis, which is fairly level, and why?

7. In what way does the quality of a battery, made by one of the standard storage battery factories, show up over a cheap competitor?
8. Why are Auto Starting and Lighting Batteries made with thin pasted plates, when other types would probably last longer?
9. It is customary to test dry cells by putting an ammeter across their terminals. Why cannot this test be applied to storage batteries?
10. If one storage cell has a resistance of .005 ohms, how much resistance would a six-cell battery have, if connected thus:

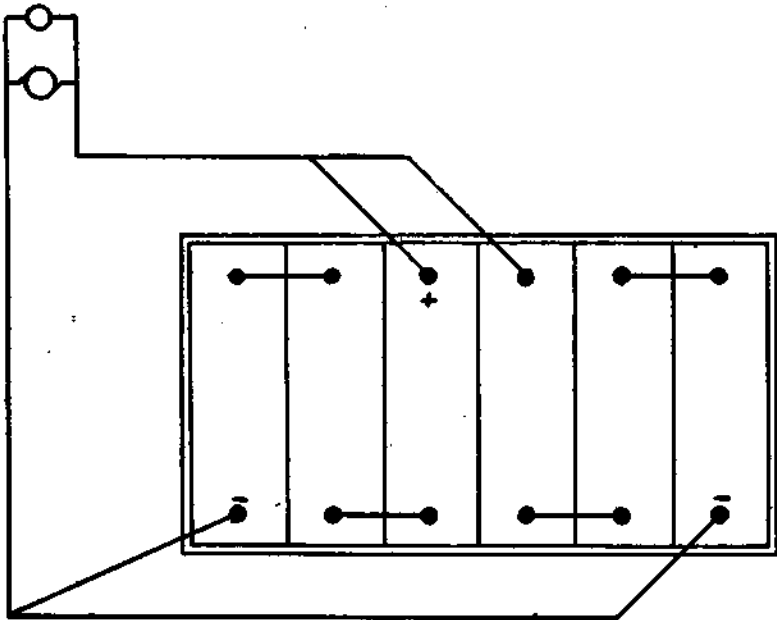

Also what voltage?

#### REFERENCES.

- Instruction books and manuals for various services:  
 The Electric Storage Battery Company.  
 The Willard Storage Battery Company.  
 Electrical Engineer's Pocket Book—Foster

## LESSON V.

### CHARACTERISTICS OF NICKEL-IRON CELLS.

#### SPECIFIC GRAVITY.

In a Nickel-Iron Cell, the electrolyte is made of Potassium Hydroxide (Caustic Potash) and Water. Normally, the density of the solution may be from 1.170 to 1.200. There is no variation made for design of cells or climate. Neither is there any range in specific gravity from full charge to complete discharge.

#### SPECIFIC GRAVITY CHANGE.

During the life of a Nickel-Iron Cell, the electrolyte density drops off gradually. This is due to absorption of Carbon Dioxide from the air, and the formation of Creeping Salts. When the density reaches 1.130, the cells should be entirely emptied and refilled with new solution. The rate at which this change goes on varies with the service. On the average, it necessitates a change of solution every  $1\frac{1}{2}$  to 2 years.

#### EFFECT OF TEMPERATURE.

This is probably about the same as on lead cell electrolyte; but as density change cuts so little figure with Nickel-Iron Cells no corrections are made in practice.

#### MEASUREMENT OF SPECIFIC GRAVITY.

This may be done with the same instruments which were used with the lead cells. Care must be used, however, that these instruments are entirely free from acid.

#### VOLTAGE.

The average discharge voltage of a Nickel-Iron Cell is 1.2. This is varied by temperature, state of charge and the external circuit conditions.

#### EFFECT OF TEMPERATURE.

As temperature increase decreases the resistance of a Nickel-Iron Cell, it effects a raise in voltage on discharge. The opposite is true of temperature decrease, of course; but the effect is not uniform.

When a temperature of 40°F. is passed, the loss of voltage becomes very great. On charge, these effects are reversed.

#### STATE OF CHARGE.

When full charged, Nickel-Iron Cells give greater voltage in about the same manner as lead cells.

#### CONDITIONS IN EXTERNAL CIRCUIT.

On charge, Nickel-Iron Cell voltage varies normally from 1.55 to 1.80. The curve in Figure XI gives details. Increase in charge rate raised the voltage anywhere along the curve, without changing its shape materially and the opposite is true of decrease. Gas is given off *during the entire charge*. These cells are usually charged at a constant rate. Temperature should be kept below 115°F.

On discharge, the voltage ranges from 1.50 to 1.10, at the normal five hour rate and as shown in Figure XII.

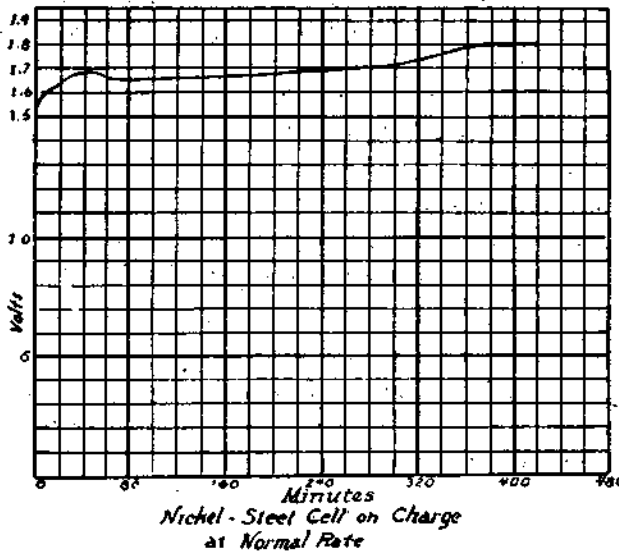

FIG. XI.

#### GASSING.

These cells gas *during discharge* as well as charge, and give off considerable heat in both processes. The continuous gassing necessitates close attention to the level of electrolyte and frequent filling with water. The gas evolved is very explosive, as is that given off from lead cells.

The discharge curve in Figure XII shows a peculiarity of the Nickel-Iron Cell. It will be recalled that lead cell voltage eventually reaches zero on discharge, because the plates become chemically alike. In the Nickel-Iron Cell this is not the case and another reason must be found for the same phenomenon. The curves marked "Iron" and "Nickel" in the figure, were obtained by testing in addition to the total cell voltage, the voltages from the respective plates to a test electrode of Nickel Oxide, held in the electrolyte. They show the part each plate plays in producing the external cell voltage and their algebraic totals are always equal to this value. It will be noticed that the iron plate changes very little, but that the Nickel plate goes below zero as the discharge progresses. In time, this action neutralizes the voltage produced from iron to electrolyte, reducing the cell voltage to zero.

Open circuit voltage recovers in about the same degree as with lead cells, and no dependence should be placed on readings taken in this manner.

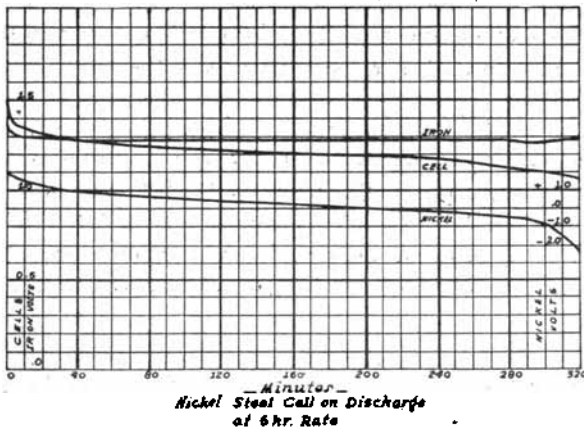

FIG. XII.

## CAPACITY.

Of Nickel-Iron Cells, capacity is determined by plate area and thickness; that is, the weight of active material in service. It is varied by temperature, amount of service, specific gravity, and discharge rate.

The capacity of Nickel-Iron Cells is much greater per pound than that of lead cells, but less per cubic foot of space occupied. In comparison, the equipment of the average two-ton electrically-propelled motor truck may be taken as follows:

| Kind of Cell      | No. of Cells | Ampere Hours | Watt Hour | Pounds | Cu. Ft.          | Voltage Discharge |
|-------------------|--------------|--------------|-----------|--------|------------------|-------------------|
| Lead .....        | 42           | 220          | 18,040    | 2,400  | 16 $\frac{1}{4}$ | 72                |
| Nickel-Iron ..... | 60           | 300          | 21,600    | 1,600  | 26               | 65                |

This is a practical example. The reason for not comparing equipments of like voltage can be explained in this manner. Forty-two lead cells, rising at the end of charge to 2.56 volts each, can be charged from an ordinary 110 v. D. C. circuit. This is commonly done in this class of service. The Nickel-Iron Cell rises to 1.80 volts at end of charge. Hence, but 61 cells can be charged. Sixty are generally used in the class of service named. On account of the lower discharge voltage of the Nickel-Iron Battery, a *special motor must be used*, so that the speed of the vehicle will not be affected. The above comparison applies in like manner to all services.

#### EFFECT OF TEMPERATURE.

A hot battery, during discharge; that is 120° to 130°F., will give the greatest capacity, if the temperature has been kept between 75° and 80° on charge. The output will be reduced, if charging is done at less than 50° or more than 105°. There is also the critical point of 40° at which discharge is materially reduced.

#### EFFECT OF SERVICE.

Nickel-Iron Cell capacity builds up in service, in a manner similar to lead cell. It is safe to say that this effect reaches its maximum in from twenty to thirty cycles, due to a betterment of the positive or nickel plate, which is also a parallel to the reason for the effect in lead cells.

#### EFFECT OF SPECIFIC GRAVITY.

Low specific gravity naturally causes low capacity. When, for reasons explained above, this drops below 1.130, the electrolyte should be renewed.

## EFFECT OF DISCHARGE RATE.

Higher discharge rates than normal reduce Nickel-Steel Cell capacity in a manner shown by the curve in Figure XIII. This can be viewed against the light, for comparison with lead cell curves in Lesson No. 4.

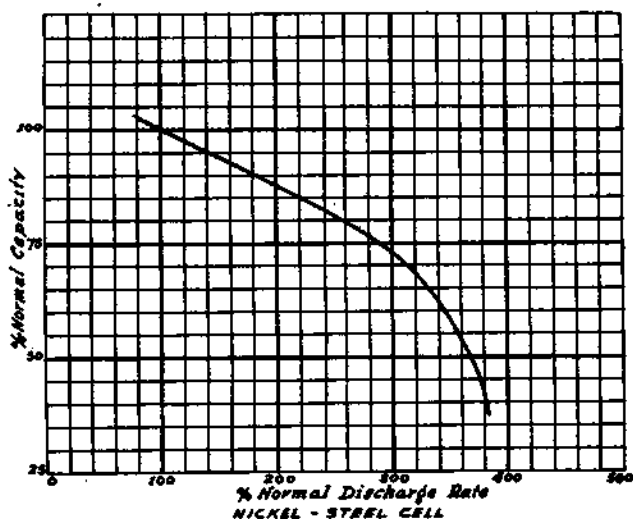

FIG. XIII.

## LIFE.

The life of Nickel-Iron Cells is probably double that of the comparative lead type. In the U. S. they are manufactured by but one concern and there is no variation in design, simply two plate sizes and thicknesses and a variable number per cell, to give capacities of from  $18\frac{3}{4}$  ampere-hours upward. These facts eliminate life voltage of the charge. Hence, the two values diverge, giving variations, due to difference in manufacture (as mentioned under lead cells). Regarding the effect of care, it may be said that they appear to be very rugged and able to resist great abuse.

## INTERNAL RESISTANCE.

In Nickel-Iron Cells, this factor is comparatively high. With the resistance of lead cells considered as one, it is about correct to give that of the Nickel-Iron as from  $2\frac{1}{2}$  to 3. This feature eliminates this cell from certain heavy discharge services, and notably the



auto starting and the bulk of the central station fields. This is on account of poor voltage at the very high rates required; a natural result of high internal resistance. This resistance varies somewhat from full charge to complete discharge, rising gradually toward the completion of discharge with a sharp increase at the end of the normal five-hour performance.

#### QUESTIONS.

1. The hydrometer does not play a very important part in the daily operation of a nickel-iron battery as with a lead battery. Why is this?

2. Why do makers of nickel-iron batteries recommend that the water used for replacing evaporation be kept in closed vessels?

3. Suppose two storage battery locomotives, one equipped with lead and other with nickel-iron, were left standing in a freezing temperature. What would be the relative effects on their mileage and speed on that charge?

4. (a) How many nickel-iron cells should be used to supply 110 average volts for a farm plant? (b) In the first place, why would this number of cells be used and, secondly, what would be the voltages on the lamps at the start and end of discharge?

5. Compare this with the performance of a 56 cell lead battery, used in the same manner?

6. What would be the generator voltages required to charge both batteries?

7. Suppose, in normal weather, the battery mentioned in question four gradually began to lose its ability to light the lamps for the rated period. What would you look for?

8. Name some points wherein the nickel-iron battery has the advantage of the lead.

9. What is the comparative internal resistance, *battery for battery*, on equipments of like discharge voltage?

10. What is the effect of this relation?

#### REFERENCES.

"Instructions for Installing and Operating the Edison Storage Battery, Type A and B."

"The 1910 Edison Storage Battery," by W. E. Holland; published by The Edison Storage Battery Company, Orange, N. J.

## LESSON VI.

### COMPARATIVE EFFICIENCY.

Efficiency is the relation between the amount of energy put into any piece of apparatus and the amount which can be gotten out in a useful manner. It is figured in this manner:

$$\frac{\text{Output}}{\text{Input}} = \text{Efficiency} \quad \left( \frac{O}{I} = \text{Eff.} \right)$$

#### STORAGE BATTERY EFFICIENCY.

Of storage batteries, there are two general types of this efficiency. These are Ampere-Hour and Watt-Hour Efficiency. The former is always higher, because it does not take into account the higher voltage at which charging is done. It is used mainly in connection with ampere-hour meters in regulating duration and quantity of charge.

#### EFFECT OF FIELD OF SERVICE.

The efficiency of storage batteries varies greatly with the particular line of work in which the battery happens to be engaged. For example, batteries floated with a generator and rarely completely discharged operate at a very low efficiency. Examples of this would be the familiar Auto Starting and Lighting battery and the Central Station emergency equipment. It is readily appreciated, however, how these batteries justify operation even at the low figure of efficiency.

#### AVERAGE EFFICIENCY.

The subject of this lesson will be the greatest efficiency of the two existing forms of storage batteries, which is available under average conditions. We shall designate this Average Efficiency. This is the value of common interest.

#### LEAD CELL AMPERE-HOUR OR CURRENT EFFICIENCY.

Where a battery of this form is discharged completely or nearly so at least once a week, the relation between ampere-hours put in and available on discharge is about .85, figuring according to the formula given above. This is called 85%.

## WATT-HOUR OR ENERGY EFFICIENCY.

You have been told that lead cells discharged at an average voltage of 1.95 and that on charge this voltage varied from 2.15 to 2.55. The average voltage of the charge is 2.3. The two average voltage figures expressed thus:  $1.95/2.3$  give us what might be called Voltage Efficiency or 85%. As ampere-hours times volts equal watt hours, it is only necessary to multiply ampere-hour efficiency by voltage efficiency to get Watt-hour efficiency. In the present instance the latter value is  $72\frac{1}{4}\%$ . Another way to get the same result is shown as follows:

Output 126 Ampere-hours, for example.

Input (figuring 85% ampere-hour efficiency) =  $126/.85 = 148A\cdot h$

$126 \times 1.95 = 246$  Watt-hours, Output.

$148 \times 2.3 = 340$  Watt-hours, Input.

$246/340 = .723 = 72.3\%$  Watt-hour Efficiency.

## EFFECT OF DISCHARGE RATE.

As the discharge rate increases, the average voltage of the discharge is lowered. There is, of course, no effect on the average voltage of the charge. Hence, the two values diverge giving increasingly lower voltage efficiency, and, as a result poorer watt-hour values. This effect is necessarily reversed for reductions in rate of discharge.

Regarding the decreased ampere-hours available at high rate it may be said that this does not influence ampere-hour efficiency, as the charge succeeding such a discharge is reduced in proportion. Each ampere-hour produced sulphates so much lead, which in turn requires its proportional number of ampere-hours for reduction again.

The average discharge voltage of a Faure type, at multiples of the normal rate is shown in Figure XIV. The effect on watt-hour

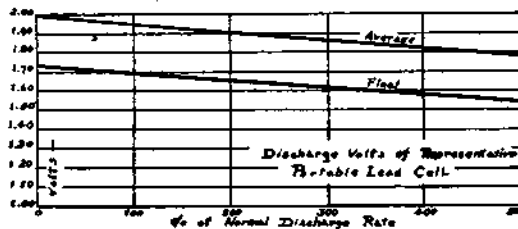

FIG. XIV.

efficiency can be calculated from this, in the manner described above. The final limits for discharge voltage, at the same rates, are also given in this figure.

#### EFFECT OF TEMPERATURE.

As a decrease in temperature causes increased internal resistance, which in turn causes increased charge and decreased discharge voltage, the effect of such a temperature change can be readily seen. As the charge and discharge voltages are further apart, the voltage and watt-hour efficiencies are reduced.

Increase in temperature gives the opposite effect.

#### EFFECT OF STANDING IDLE (Sulphation).

It has been explained that lead sulphate is formed in the active material on discharge. This salt has two distinct forms: namely, the Amorphous, or paste like state, and the Crystalline state. The name of the latter form is self-explanatory. The Amorphous form is always produced first on lead storage battery plates, but it assumes a crystalline form if allowed to exist for any length of time. The first small crystals unite, in time, to form larger ones and more are produced until, eventually, the active material is entirely crystalline and very hard. It is now "Sulphated", in battery speech. The "unhealthy sulphate" has various stages, causing plates to lose their original pasty texture and pass gradually from gritty or granular textures to almost glass hardness. The amorphous lead sulphate is very readily reduced by the action of the charging current, but the other form is less so. If properly treated "*unhealthy sulphate*" has no other effect than a temporary reduction of efficiency (both ampere and watt-hour). This lasts until it has all been reduced by continued charging. Lead sulphate is a non-conductor and its presence, in any form, tends to raise internal resistance. The continuance of unduly high resistance—from the persistence of lead sulphate existent in the manner described—is responsible for a large percentage of efficiency reduction. The excess current required to reduce the crystalline form accounts for the balance. Roughly, if the period after the last charge is one month, as with signal or auto lighting operation; ampere-hour efficiency is reduced to fifty percent, with a corresponding decrease for longer periods.

**LOCAL ACTION.**

If a lead cell stands idle in a fully charged state, sulphation could not take place at first. If the cell is not periodically boosted, however, it loses its charge from the effects of local action. This is simply internal discharge, generally resulting from impurities in element or electrolyte. It is apparent that this discharge cannot be made use of and yet it represents an actual discharge, which must be corrected by freshening charges. Hence, another reduction in efficiency, resulting from standing idle.

Lead storage cells to be kept in a fully charged state should be boosted every two weeks. No permanent injury is done, however, if no boost is given in from one to four months, depending on the type. A simple treatment for sulphate, to be handled in a later lesson, must be given in this case before the cells are put in operation again.

**AMPERE-HOUR EFFICIENCY OF NICKEL-IRON CELLS.**

The 300 ampere-hour cell has for its charging rate 60 amperes. This rate is carried on for  $5\frac{1}{2}$  hours, to get rated output, making  $60 \times 5\frac{1}{2}$  or 330 ampere-hours put in. Figuring against the rated output, this is  $300/330$  or 91%.

**VOLTAGE EFFICIENCY.**

This factor with nickel-iron cells is 72% or  $1.2/1.67$ . This may also be used to figure watt-hour efficiency from ampere-hour efficiency as follows:  $.91 \times .72 = 64.8\%$ .

**COMPARISON.**

The student may see, from the foregoing, that lead and nickel-steel cells compare very favorably on ampere-hour efficiency; but the poorer voltage efficiency of the latter gives a decreased watt-hour or ultimate efficiency, meaning higher charging cost per ampere-hour output. The exact ratio is  $72/65$  or 10% excess cost at rated output.

**NORMAL INPUT.**

When the normal charging rate is carried on for seven hours, giving what is called Normal Input, the current efficiency is reduced to 82% and that of the energy to 58%. This means 25% additional charging cost over that of lead cells.

**EFFECT OF DISCHARGE RATE ON NICKLE-STEEL.**

Increase in discharge rate decreases volt efficiency and, therefore, watt-hour efficiency. The opposite is true of decrease in rate. There is no effect on ampere-hour efficiency.

**EFFECT OF TEMPERATURE.**

Decrease in temperature, by increasing internal resistance, lowers volt and watt-hour efficiencies. There is no effect on ampere-hour efficiency.

**EFFECT OF CHARGE RATE AND AMOUNT OF CHARGE.**

Nickel-iron cells have ampere-hour and watt-hour efficiencies as high as 99% and 75% respectively, after short charges or on low output. Low rates on charge also have a bettering effect on efficiencies down to two-thirds normal. Their rated output is placed at a point where the drop in efficiency for output increase takes a decided turn for the worse. See details of Figure XV., for performance at various outputs and charging rates. Figure XVI. shows

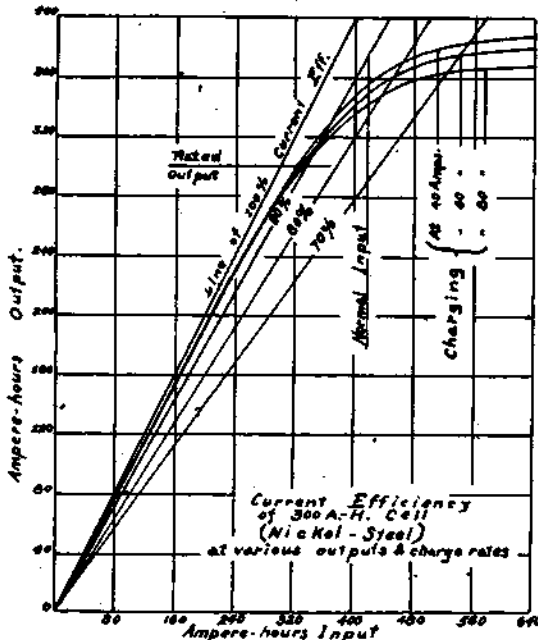

FIG. XV.

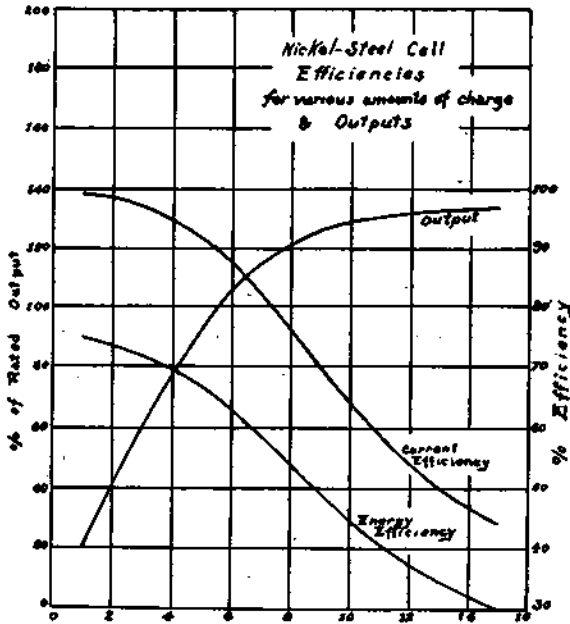

FIG. XVI.

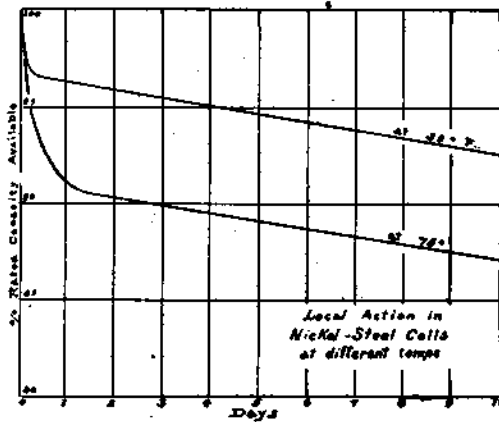

FIG. XVII.

variation in ampere-hour and watt-hour efficiencies for different lengths of charge at normal rate. It is a great advantage, at times, to be able to work a battery up to the larger outputs, available after a nine or ten hour charge; even with the reduced efficiencies.

**EFFECT OF STANDING IDLE.**

There is no parallel to sulphation in Nickel-Iron Cells and, as far as this effect is concerned, no reduction in efficiency over long idle periods. There is a certain amount of local action as with lead cells, the amount of which is best shown in Figure XVII. If cells are kept cold while standing the effect is less marked. On the whole, the nickel-iron cell shows up remarkably well in tests of this sort and is well adapted for service requiring long periods of idleness with intermittent service. For example, the 75° curve, in Figure XVII, indicates that a battery would still have some of its charge after standing six months.

**QUESTIONS.**

1. By what characteristic do engineers judge of the relative operating economies of various pieces of competitive apparatus?
2. How does this apply to storage batteries in particular?
3. Suppose a lighting and ignition battery of a lead type is rated at 150 ampere-hours capacity and that it is completely discharged. About how long would a current of ten amperes have to be maintained in order to recharge it?
4. If this were a six volt battery, how much would the charge cost, figuring electricity at ten cents per kilo-watt hour?
5. What would it cost to charge an equivalent nickel-iron equipment?
6. If the lead battery lasted 2½ years and cost \$40 and the nickel-iron lasted five years, costing \$80; which would be the better proposition?
7. Suppose one were figuring on a generator, to charge these batteries from the power developed by the automobile engine. What would be the comparative sizes and the comparative drag on the engine?
8. Generally speaking, how should charging costs compare in Alaska and Florida?
9. Which would cost the more to produce; the output from a telephone battery, where the discharge is near normal rate, or that of a mine locomotive battery, where the load is heavy?
10. When would high operating cost of a battery be justified?

**REFERENCES.**

- W. E. Holland's "The 1910 Edison Storage Battery".  
Lamar Lyndon's "Storage Battery Engineering".



## LESSON VII.

### MANUFACTURE OF CELL AND BATTERY PARTS.

The manufacture of storage batteries is mainly centered on the making of the plates; as on the quality of these depends, to an extent greater than on any other part, the life and performance of the battery.

There are always two kinds of plates in a cell, positive and negative, and each is composed of two main parts; namely, the active material and the grid or supporting framework. The second named also conducts the current to and from the first. This grid, in most modern cells, is either square or rectangular in shape, with a projection at the top, called a lug, for connection to the strap or bus-bar.

#### POSITIVE PLATES, PLANTE TYPES.

Several types of Planté Positives are in use today in stationary work or where weight is no disadvantage, for example, railway car lighting. These can be grouped into two classes; those which are cast from pure lead and the active material formed directly on the casting and those which have a cast grid of antimonious lead, with active material formed on pure lead supported by the casting.

#### PLANTE POSITIVES, PURE LEAD GRIDS.

The two forms most widely used are known as The Tudor, a German invention, and The Rolled Positive.

#### TUDOR POSITIVE.

This plate is cast in one operation ready for the forming charge. The casting, of pure lead, has an immense surface and is accessible to the electrolyte clear thru from either side, giving it very good high rate discharge characteristics. Like all plates entirely made of pure lead, however, it is very liable to buckle or grow in service and is comparatively heavy, because much lead must be used in framework to give it strength. Pure lead at best is not very strong.

The exact form of the casting may be judged from Fig. 1.



FIG. I.

TUDOR POSITIVE PLATE.

**ROLLED POSITIVE.**

This plate is first cast and then machined, before being formed. A simple pure lead casting is made in the form of a sheet of the width and height required in the finished plate, though somewhat thinner. This is passed between a pair of arbors on which disk knives are mounted. These knives are spaced about  $\frac{1}{16}$  inch apart. As they go over the casting deep grooves or scores are cut and the displaced lead squeezed out between the knives, increasing both thickness and surface of casting. Horizontal and vertical ribs of unscored lead are left to give the finished plate more strength. The form is shown in Figure 2. This plate has all the disadvantages of the Tudor with none of its advantages.

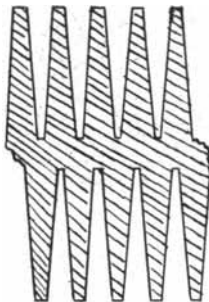

FIG. II.

CROSS-SECTION "ROLLED" PLATE.

## PLANTE POSITIVES ANTIMONIOUS GRIDS.

Only one form has remained on the market to any extent; namely, a British invention known as The Manchester Positive.

## MANCHESTER POSITIVE.

Here we have a separate grid, cast under heavy air pressure from lead and antimony alloy (approximately 92% lead). The lead is shot into a mould, with suitable gates and risers, by the air pressure, giving an absolutely compact and uniform casting of the exact width and height of the finished plate, but somewhat thinner. This casting contains holes, the diameters of which are smaller in the center, as shown in Figure III.

Pure lead ribbon is first crimped and then rolled into scroll-like buttons of uniform size, by a special machine. These are arranged in a template containing recesses to match the holes in the grid casting, large enough to hold the buttons and deep enough to center them in the grid. On this template and buttons, the finished grid is placed and on the two another template with its recesses downward. Hydraulic pressure of several tons forces the two templates together and centers the buttons in the grid holes. The buttons protrude about  $\frac{1}{16}$  inch on each side.

The plate is now ready for forming. It has the advantages of extreme ruggedness, comparatively lighter weight, and freedom from distortions. Its voltage characteristics are good.



FIG. III.  
MANCHESTER POSITIVE PLATE.

## NEGATIVE PLATES, PLANTE.

Negatives have been made in all of the forms described under positives and some additional, but all but one, for various reasons,

have been discarded. The existing type is the Rolled Negative, which is constructed in the same manner as the positive of that name.

#### POSITIVE PLATES, FAURE TYPES.

The existing types are all supported by a staggered lead and antimony grid, which is cast by hand in a very intricate mould. The most common form has vertical ribs, extending from surface to surface, with a surrounding framework and horizontal staggered bars, to support the active material. A special form, known as The Diamond Grid, substitutes diagonally crossed bars for the horizontal.

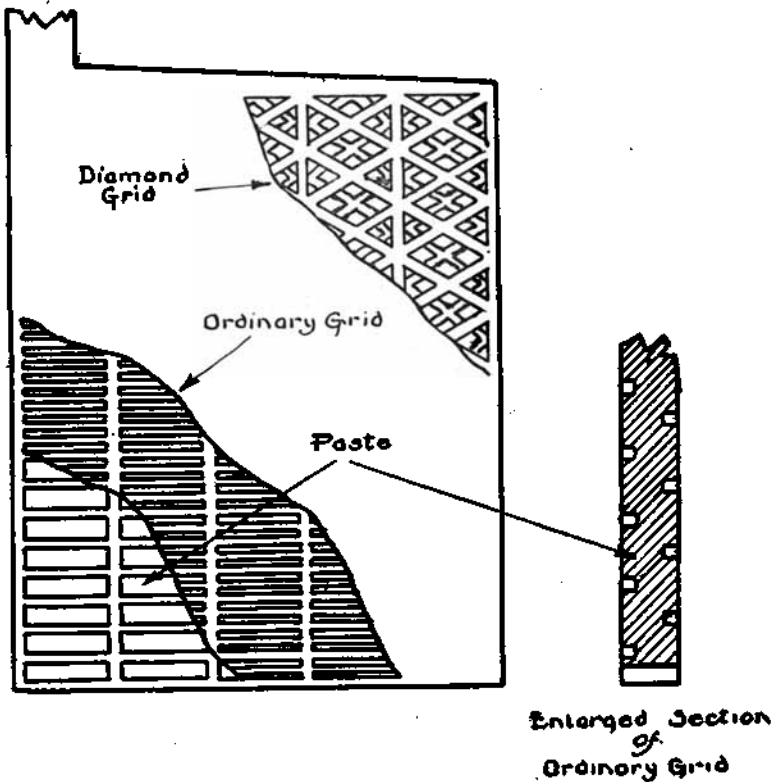

FIG. IV.

PASTED PLATE GRID CONSTRUCTION.

Figure IV shows the forms. The moulds for these grids represent very fine machine work and much money. As the capacity of a plate depends on the weight of active material in service, it becomes essential to use a grid of the smallest cross-section allowed by strength requirements. The smaller the cross-section, the more expensive the mould. Hence, we have one of the advantages obtained by the larger manufacturers.

#### PASTING.

The finished positive grid is filled with a stiff paste made from Red Lead (Minium) and Ammonium Sulphate, which acts as an expander. At present, this is mixed and applied by hand, with the aid of a wooden paddle and marble slabs. The paste also contains suitable binding agents, which differ with manufacturers. The exact proportions and ingredients are trade secrets. Both metals and materials for making paste must be of the utmost purity, to keep down local action in the finished product. Strict regard to this feature also introduces an item of manufacturing expense not easily absorbed by a small manufacturer.

#### DRYING.

After pasting, plates are arranged in wooden frames, with grooves for supporting the plates by their edges, and stored away to dry. This fits them for the forming charge.

#### "IRONCLAD" POSITIVE.

There is a very special form of Faure positive, developed from the invention of a Frenchman named Philipot and known by the trade name of Ironclad.

This consists of a pressure cast alloy grid, composed of a horizontal bar, of special shape, and a series of vertical cylindrical bars each of which has a series of flat places arranged alternately at right angles. Over the vertical bars are placed tubes of hard rubber (vulcanite) ribbed on opposite outside surfaces and slotted between the ribs. These are filled, in a special machine, with powdered red lead and other ingredients in dry form. Another horizontal bar is then welded onto the vertical bar ends, holding the tubes in place and making the plate ready for forming. The outside edges of the outer tubes are not slotted. Figure V shows this construction.

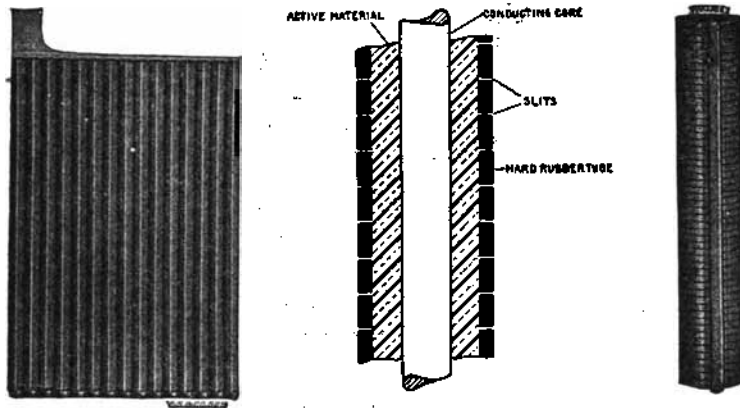

FIG. V.

## IRONCLAD POSITIVE PLATE AND DETAILS OF PENCILS

These positives are worked against ordinary pasted negatives, the top and bottom edges of which are sheathed in hard rubber to prevent short circuits to the unprotected bars on the positive. This makes an extremely long-lived combination of medium high capacity.

## NEGATIVE PLATES, FAURE.

The form of support is generally the same as in the positive. The paste, however, is of Litharge and dilute Sulphuric Acid. Negative paste may be successfully mixed and applied by machinery and this is done at present to a large extent. Binders are omitted from negative formulas, in certain services, they being unnecessary.

There are two additional forms of existing grids for pasted negatives, which are used particularly in stationary and railway carlighting work against the Planté positives. These are the Shelf and Box negatives, the latter a German idea.

## SHELF NEGATIVES.

The name is very descriptive, in this instance, as the paste is supported on a series of shelves. The grid is cast, of lead alloy, in the form shown in Figure 6. The balance of the manufacture is the same for the regular staggered grid.



FIG. VI.  
SHELF NEGATIVE PLATE.

#### BOX NEGATIVES.

Here we have an alloy box, cast in two lateral halves; which when placed together, form the supporting and conducting grid for the active material. Figure VII shows details. Ordinary negative paste is applied to square holes in a wooden form. These squares of paste are pushed out into one-half of the box described above. The other half is then welded on and the plate dried. These plates are often shipped unformed.



FIG. VII.  
BOX NEGATIVE PLATE.

#### FORMING.

In all of the foregoing, we have simply described the manufacture of supports for the active material or the bases, from which it is later made. The actual "formation" of the active material in a

plate is always done by a process of charging, aided in a few instances by the actions of chemicals.

In the Planté types named, the corrosive action of nitric acid or chlorides is often used to deepen the layer of active material formed on one charge to a point of commercial capacity. These chemicals are afterward entirely eradicated, to prevent further action and disintegration.

The Faure types are all formed by simple charging, at a comparatively low rate in weak acid. The displacement of oxygen, from the negative paste, gives the necessary porosity. You have been acquainted, under chemical action, of the exact changes taking place. In general a grid of alloy is acted on to a less extent than one of pure lead and, therefore, retains its strength and shape much longer in service.

After formation, plates may be used, without drying, in batteries, and this is done to a great extent in smaller factories, where investment and storage capacities are limited. Otherwise, and in cases of knocked-down parts shipments, plates must be dried again after forming. Stationary types for assembly in glass jars or lead-lined tanks are always shipped knocked-down.

#### PLATE STRAPS (CONNECTING STRAPS)

These are hard cast of pure lead or alloy to suit the service in various forms. They always contain, however, holes for the plates and tails or posts for connection. Often posts of different polarities have different size, to avoid errors in connecting up. Sometimes a separator hold-down is incorporated in the casting. They serve to connect the plates of like polarity; for example, all the positives, for conducting current to and from the cells. Connection is made to the plate lugs by the process of lead welding, known in battery speech

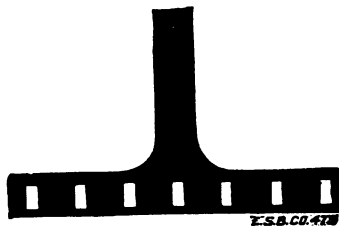

FIG. VIII.

STATIONARY TYPE OF PLATE STRAP



as lead burning. Some forms are shown in Figure 8. Plates of like polarity, in a cell, with their connecting straps, together form what is called a group. There is a positive and a negative group in each cell, although each group may have but one plate.

Plate lugs, in the larger stationary installations, are often burned to an alloy strip, called a bus-bar, which serves, at once, as positive strap in one cell, negative strap in the other, and intercell connector.

#### PLATE SEPARATORS.

In order to insulate plates of the two polarities from one another and yet allow for free passage of the electric current, various substances have been tried of a porous character.

Among the first were asbestos and glass wool. Later rubber, with many small perforations, was tried. These all depended, for porosity, on definite openings visible to the naked eye and through which, in time, active material would pass. This eventually bridged from one group to the other and destroyed the efficiency of the cell, or the separator became so clogged as to impede circulation of the electrolyte and still render the cell useless. Again, as the spaces between the openings are solid, non-conducting material, the area of current path is considerably reduced and its resistance increased. Internal cell resistance is, therefore, increased by the use of these materials.

Wood was first introduced as a separator material about the year 1890. It is entirely porous; that is over its entire surface, and ordinarily, when saturated with electrolyte, offers little more resistance to current flow than as much solid electrolyte. It gets its porosity from minute passages through which the sap travels in the tree, and which are invisible to the eye. At first the sap left in wood had a harmful effect on plates, but this has been eliminated by a patented process of treating with an alkaline solution. Separators must be kept wet, after this treatment. Where positive plates are fully charged a large portion of the time, as in propulsion services, a thin sheet of perforated rubber between them and the wood separators is essential to prevent the charring action of the high lead oxide. Charged positives also are generally softer than otherwise and the rubber acts as a mechanical support. Wood separators generally have grooves, placed against the positive plates to allow the escape of gas formed there and prevent its interference with cell

action. In the Ironclad Positive, described in the foregoing, rubber separators and groves are incorporated so that a simple, flat, wooden "Veneer" is used for separation. All woods have been used for separators; but California Redwood, Gulf Cypress, and White Cedar have been found most suitable. Very thick wood separators, used principally in railway carlighting work, are often grooved on both sides. Separators for stationary work are of horizontally grained veneer, with vertical dowels for stiffening and spacing, and hang from a rubber pin in the center (see Fig. IX).

Recently a process of incorporating threads of cloth in a grooved rubber separator has been perfected. This eliminates the definite openings in the rubber, without destroying the action through the porous places so left.

#### SEPARATORS HOLD-DOWNS.

As separators, especially wood, have a tendency to float in the electrolyte, it becomes necessary to hold them in position. This is done, in open stationary cells, by simply laying glass strips along the tops of the separators and at right angles to the plates. Sealed cells have wooden or hard rubber blocks under the connecting straps, metal fins cast on the connecting straps themselves or the separators extend clear up to the bottoms of the straps.

#### CELL CONTAINERS.

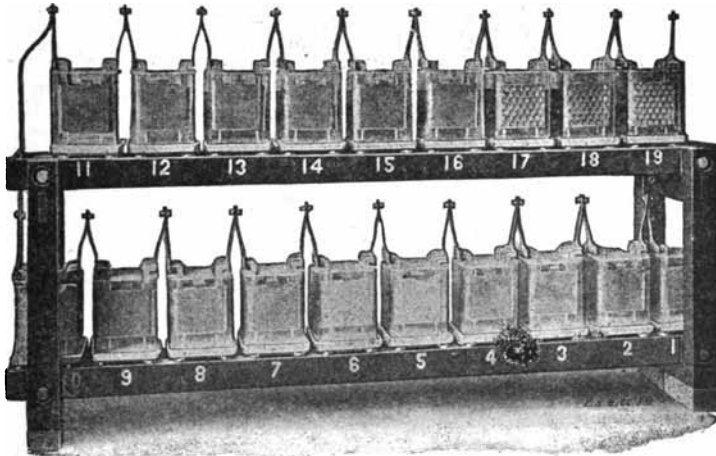

FIG. IX.

REPRESENTATIVE GLASS JAR SETUP, SHOWING COUNTER CELLS  
(NOS. 17-19.) AND SEPARATOR DOWELS.

Stationary cells are usually contained in a rectangular glass jar, in the smaller sizes. The elements are supported, away from the bottoms of the jar, by special lugs cast on the plates (see Fig. II). This allows sediment to collect, from active material shed during plate life, without interfering with cell action. Sufficient space, over the plates, is also provided, to insure their being covered by the electrolyte and provide a surplus to reduce the attention necessary to replacement of evaporation. Figure IX shows a representative glass jar set-up.

Larger stationary cells are placed in lead-lined tanks of long-leaf yellow pine. The wooden shell is painted, inside and out, with asphaltum paint, which is acid resisting, and the shell is dovetailed and dowelled for strength. Very large tanks are placed with their long sides together, but the end cells must be specially reinforced with steel rods, to take up the immense stresses imposed by weights of elements and electrolyte. Plates are supported in tanks by heavy notched glass plates placed inside the tanks at the plate edges. Fig. X shows a tank setup.

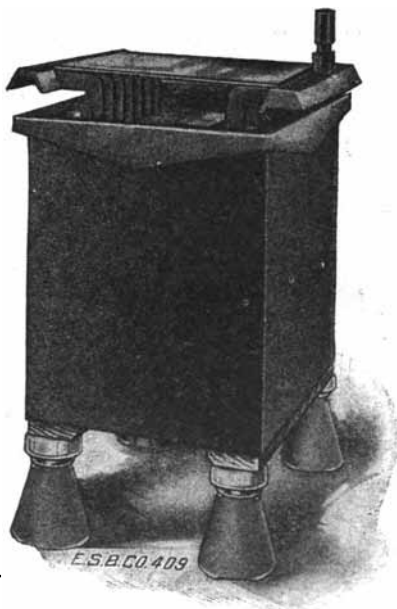

FIG. X.

TYPICAL LEAD-LINED TANK SETUP OF LEAD CELL.

Covers for the containers described above consist of simple glass sheets, laid across the tops. Gas escapes and attention is given through the open spaces on either side of the cover, so no definite vent is necessary.

Semi-portable cells, for railway carlighting, are also placed in lead-lined tanks or rubber jars. In the tanks, the elements are supported on porcelain blocks of triangular cross-section. The jars have ribs moulded into their bottoms for the same purpose. In either case, the container is entirely sealed by the cover. The latter is of hard rubber or alloy and is provided, in some cases, with a soft rubber edge to hold it in place, or is sealed in place with a compound of pitch or asphaltum. A hole or vent must be provided in these covers, for replacing evaporation and taking specific gravity readings. This is closed, when not in use, with a plug designed to allow the escape of gas.

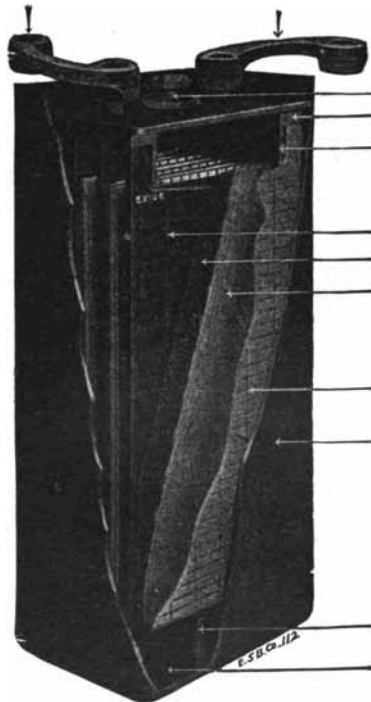

FIG. XI.

CUTAWAY PORTABLE CELL.

All portable cells have the jar, cover, and vent in forms similar to those described above. They are, however, generally less liberal in dimensions, as space is very important in other fields. There are numerous ways of making the joints around the edges and strap posts acid tight. The former is done by soft rubber edges and sealing compounds, either in special grooves or not, and the latter by compound, rubber gaskets (held tight by lock or sealing nuts), and strap construction.

Vents vary from simple holes; with soft or hard rubber plugs, perforated to allow escape of gas; to very detailed mechanisms to prevent overfilling. Figure II shows a portable cell cut-away to show construction.

#### CELLS, CASES OR TRAYS.

This battery part is omitted or modified in most stationary work. Glass jars are placed in flat trays, containing sand to equalize standing stresses, which are in turn placed on insulators and wooden racks in one or more tiers or layers. Figure IX is a two-tier set-up. Racks are made of yellow pine, asphaltum painted.

Tanks are placed on insulators, containing oil in a groove to prevent dampness forming a continuous film and destroying their usefulness. This groove is protected by a lead cap, with a small hole for replenishing the oil. Even if moisture or electrolyte gets into the groove, the oil will float and still do its work. These insulators are usually set on a glazed earthenware pedestal of cone shape and the whole is leveled with porcelain and lead shims.

Railway carlighting cell containers are usually set in compound in two-cell wooden boxes, equipped with porcelain skids or rollers and side and end insulators of the same material.

Propulsion cells are mounted in lighter wooden trays, with iron or steel handles and no compound around the jars.

Smaller portable types are also floated, or set in compound in wooded cases. Sometimes through-bolts, reaching between the cells and with suitable wood spacers to take up space above and below the bolt, hold the cells tightly without compound and again sometimes the cells are simply packed tightly in the cases. In general, the absence of any compound makes the battery easier to repair and has no harmful effects, if the cells are installed tightly.

Battery cases or trays are made of birch or maple (as these woods are least absorbent) with dovetailed or locked joints, especially at the bottoms, where acid is liable to corrode metal fastenings; brass screws where metal fastenings are used; and bottom drainage and expansion room. The whole is then painted inside and out with a coat of thinned asphaltum paint, which will penetrate the wood, and another of full strength, to give finish.

#### INTER-CELL CONNECTORS.

In stationary work this battery part is incorporated with the straps, the tails of which are bolted together, or with the bus bars of larger cells. Again, some portable forms use a strap arranged for bolted connection, which does away with the connector. The balance of the styles of set-up include a lead, alloy, or lead-covered brass or copper connector welded or bolted to the strap posts. Forms are shown in Figure XII. In general the welded connection is most reliable.

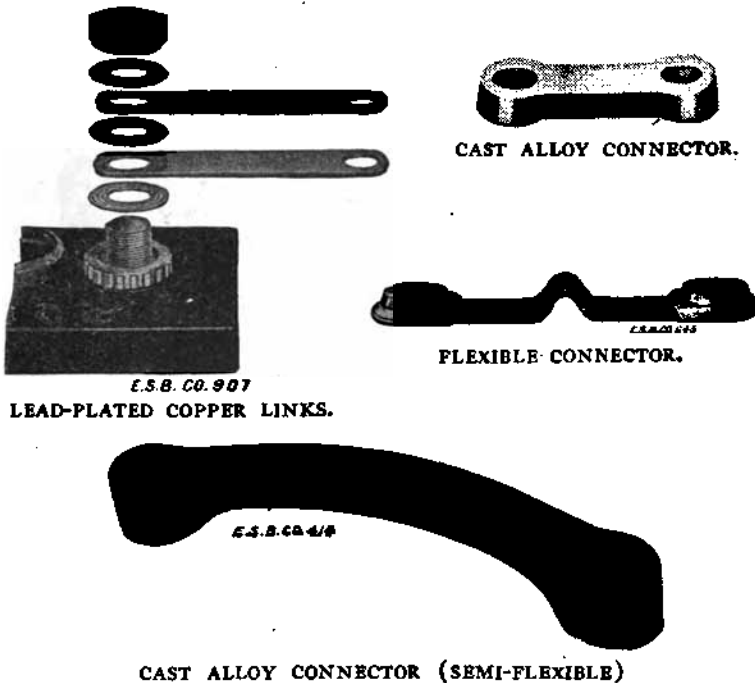

FIG. XII.

VARIOUS TYPES OF INTERCELL CONNECTORS.

## TERMINALS.

This is perhaps the most varied of all battery parts. Its design ranges from a bus bar, with cast in lugs, to small brass or alloy parts, equipped with set-screws, wing-nuts, tapered plugs, etc. The types shown in Figure XIII are sufficiently descriptive to eliminate further explanation.

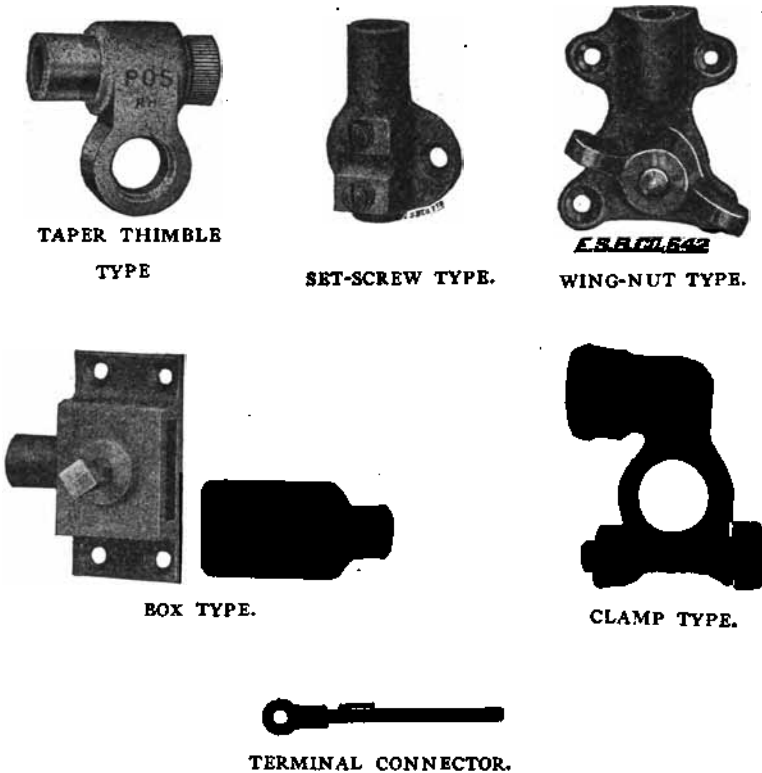

FIG. XIII

FORMS OF TERMINALS AND TERMINAL CONNECTORS.

## QUESTIONS.

1. If you desired to make plates for a storage battery, what parts should first be considered before going ahead?
2. Assuming that these plates were wanted for a service requiring good voltage regulation and life without regard to weight or cost, how would the manufacturer proceed and what might the product be called?
3. Suppose great durability, irrespective of other characteristics, is desired?
4. How would you go about making plates which can deliver the highest capacity possible to the pound of weight, to suit a service requiring this?
5. In what manner is this plate, just described, modified to give greater life?
6. Having a set of plates made, in what manner are they connected to the circuit and describe forms of the part used.
7. The term "Insulator" is often used to designate a wood separator. Why is this term a misnomer?
8. Altho rubber separators will sink in water, they show more tendency to float in electrolyte. Why is this and how is it prevented?
9. Why are not lead cell containers made of metals like steel, brass, tin-plate, etc., instead of such fragile materials as glass, hard rubber, or lead?
10. Batteries are generally used in places where the fine wood, workmanship, and fastenings on their cases are not visible. Why would not boxes of cheaper design do just as well?

## REFERENCES.

Descriptive literature furnished by the Electric Storage Battery Co., the Williard Storage Battery Co.



## LESSON VIII.

### GENERAL ASSEMBLY AND ELECTRICAL TREATMENT OF LEAD AND NICKEL IRON CELLS.

#### GENERAL ASSEMBLY IN STAGES.

The first step toward assembling a battery and after the parts have been made, is to group the positive and negative plates with their respective straps.

#### LEAD BURNING.

These are joined, as mentioned above, by a system of lead welding known as lead burning. In this, the surfaces to be joined are first carefully cleaned and then *intense local* heat is applied, from a special flame or other source. If the heat is not sufficiently intense, it will be conducted to the surrounding metal in the additional time required to fuse the surfaces to be joined and melt everything down. Ordinarily the surrounding metal acts as a holder for that being melted and the emergency mentioned above is called a "Run-down". Extra metal of the same composition as in the parts being joined is melted in, *after the joint has been made*. No flux is used and solder will not do, as sulphuric acid will attack the tin and destroy the joint in time.

#### ELEMENT ASSEMBLY.

When the groups have been made, a negative and positive group are put together, with plates of each polarity alternating. Elements generally have one extra negative, bringing negative plates on both outsides. However, extra positives are often used, to give extra capacity. The life of this combination is less, on account of distortions produced in positives worked on one side only.

Separators are now installed with their hold-downs. Grooves, if used, are placed against the positives and the rubber sheet, in the wood and rubber combinations. The element is now complete.

#### BALANCE OF CELL ASSEMBLY.

Pasted elements, installed in rubber jars, are made reasonably tight; that is, so that a little pressure is required in addition to the

element's weight. This insures minimum shedding of material and maximum life. Covers are next installed and sealed. Vent plugs are usually put in last, after the electrical treatment.

#### BATTERY ASSEMBLY.

Cells are now packed, bolted, or floated into their cases or trays and the connectors and terminals burned or bolted on. Compound is then flowed over everything but the protruding terminals in some types. *Cells are connected positive to negative throughout the battery.*

Stationary types are generally shipped knocked down and assembled where used, from their weight and bulk. Glass jar set-ups are, however, assembled as far as the groups and there are many farm-lighting types which are shipped ready to use, set up in glass.

#### COUPLE TYPE.

There is a special glass stationary set-up, known as the Couple Type and used particularly in signal and alarm work. Here we have a number of narrow glass jars, with glass covers, and mounted in groups of ten or less on long sand trays. Each jar contains but two plates; each of which forms half of a "couple" of plates, of opposite polarity, which are joined by a strip of lead. The strip is bent over the adjacent jar edges, allowing one plate to stand in either jar. The cover is notched to allow for the strip. End plates are held to their jar sides by a special alloy casting. This setup is cheaper than the smaller capacities of "Multiple" Types and easier to install. No separators are used in the couple types. Fig. XIV is descriptive of this assembly.

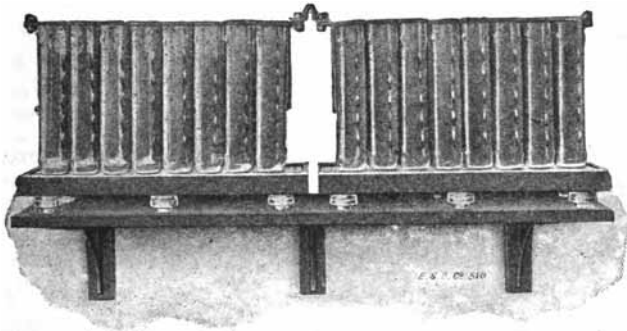

FIG. XIV.  
EXAMPLE OF "COUPLE TYPE" ASSEMBLY.

**PUTTING IN ELECTROLYTE.**

When fully formed or charged negatives are dried in air, their material oxidizes and heat is evolved. When electrolyte is put on such plates, the oxides are sulphated at once, more heat is evolved, and the electrolyte density is reduced. A further reduction also takes place, where wood separators are used, from mixture of their water with the electrolyte.

Before any charge is put into newly filled cells, they are allowed to stand until the temperature has dropped again to at least 90°F. Specific Gravity for filling ranges from 1.300 to 1.350 and the immediate drop is generally to the completely discharged point or lower. It remains for the initial charge to bring this acid out of the plates again. Some plates are soaked in acid, after forming and drying, and shipped as "sulphated" plates. Filling gravities for these are lower (1.210) and initial charges longer. As there is no heat given off when filled, charge is started at once. Other plates are dried away from the air (in an atmosphere of steam, for example) and their material is neither oxidized nor sulphated. These plates require the highest filling gravities and least initial charge. They are, however, affected by moisture and not stable in storage. The process described first seems to be a happy medium.

**ELECTRICAL TREATMENT.**

Even though plates were taken direct from the forming baths, batteries must be given an initial charge, after the electrolyte is put in, due to short exposure to the air during assembly.

Planté types come up more quickly and are charged at the normal rate, until the gravity of the electrolyte has been constant for ten hours. At least sixty hours charging time is required. Faure types require slower charging, at one-half normal rate, and a longer maximum period (twenty-four hours constant gravity) or about five days steady charge.

Where capacity is of the greatest importance, as in propulsion services, a test discharge follows the initial charge. If rated capacity is not obtained, successive discharges (carrying each one to zero) are run to build it up.

**FINAL ADJUSTMENT OF SPECIFIC GRAVITY.**

You have been told, in Lesson IV, the final specific gravity values for various services. It is a physical impossibility to adjust all the various cells in a battery to these points and have them stay

that way for any length of time on account of uneven evaporation, its replacement, and the like. In practice limits are set. Stationary cells, with a nominal final point of 1.210 are adjusted 1.205 to 1.215 at 70°F. Propulsion cells (nominally 1.280) are adjusted 1.275 to 1.285 and the smaller portables (nominal final 1.300) from 1.275 to 1.300.

#### TESTING.

Readings of specific gravity on a "pilot cell" are taken throughout the initial charge, with the temperature for correction purposes (see Effect of Temperature on Specific Gravity, Lesson IV). Final "individual cell" readings of specific gravity and voltage are used to determine, first, the basis for final specific gravity adjustment and secondly the quality of the cells. Altho voltage is varied by a number of conditions (see Effects on Voltage, Lesson IV), these effects are generally uniform in a particular battery and, therefore, individual cell readings should be nearly alike. A variation of .05 volts on charge is allowed in most new work. The particular point of voltage plays a small part, as it may vary from 2.3 to 2.8 in a fully charged cell, charging current flowing.

If a discharge is taken individual cell voltages determine its close, with a temperature correction for battery capacity (see Effect of Temperature on Capacity, Lesson IV).

Finally and just before shipment of portable sets a heavy discharge test with individual cell voltages and specific gravities shows any faulty joints or slight internal defect not noticed on the previous "bench tests". Tipping a portable set in various directions tests the sealing.

#### NICKEL-IRON BATTERIES.

These contain the same parts as in lead batteries.

#### POSITIVE PLATES.

A punching of medium weight nickel-plated sheet steel is first gotten out, representing the framework for the finished plate. Pencils are made to fit the frame, of very thin, corrugated and perforated nickel-plated sheet steel. The sheets are rolled into a spiral tube, which is in turn filled with alternate layers of excessively thin, flaked nickel and the nickel-hydroxide. When completed the pencils are sealed on the ends and pressed into the supporting punching by very

heavy pressure, insuring good contact. They are held, top and bottom, by the squeezing together of small fins on the punching. Nickel-plated steel rings, placed at regular intervals on the tubes, prevent their swelling.

#### **NEGATIVE PLATES.**

Here we have a similar punching with vertical slots a short distance apart. These slots are filled by pockets or rectangular flat boxes made from the same corrugated and perforated material as the positive pencils. These are, however, filled with iron oxide and pressed together flat and the pocket, as a whole, squeezed into the plate punching.

#### **STRAPS.**

Each plate has a hole through one upper corner, and, by this, plates of one polarity are threaded onto a nickel-plated steel bar, spaced with bushings of the same material, and the whole made tight by threaded nuts on the ends. This bar has an upright tapered post fastened to its center for intercell connection.

#### **SEPARATORS.**

The positive and negative groups now completed are put together with plates interleaved and negatives on both outsides. Separation is provided by a framework of square rods of hard rubber, with cross ribs, placed across the plate edges, holding them apart.

#### **CONTAINER.**

The element, thus assembled, is placed in a container of nickel-plated steel, with corrugated sides to give strength. Insulation, between the outside negatives and container, is provided by a thin, unperforated sheet of hard rubber. The posts of the plate straps are inserted in holes in the nickel-plated steel cover, bushed with hard rubber. The positive bushing is red and the negative black to distinguish polarity. These posts are held in by nuts, so that the element is suspended from the cover. All joints in the container and between it and the cover are welded with oxy-acetylene flame. A heavy "boss," welded to the jar sides, acts to support the cells in their cases or trays.

The cover also has an opening the lid of which can be thrown back for filling the cell with electrolyte and replacing evaporation. When closed a mechanism in this lid acts to allow escape of gas formed by the charge or discharge, at the same time preventing the admission of air (see Effect of Air on Electrolyte, Lessons III and IV).

**ELECTROLYTE AND FORMING.**

Cells are filled with potassium hydroxide solution of 1.200 specific gravity and given three cycles, before being shipped.

**CELL CASES OR TRAYS.**

These are, in most ways, similar to those for lead cells. A different paint is used, however, which is mainly insulating and alkali resisting. Its trade name is "Esbalite." The cell containers are also painted on the outside and, in addition, are separated in the trays by special insulators. All this is necessary on account of the conducting material of which containers are made, to prevent damage from short-circuits or grounds.

**INTERCELL CONNECTORS.**

These are of nickel-plated copper rod, bent in the shape of an arc and welded at each end to eyes of the same material, which are made to fit the tapered plate-strap posts. They are held in place and tightened by a nut.

**TERMINALS.**

These are generally simple, nickel-plated copper lugs, to be "sweated" to the wire from the external circuit.

**QUESTIONS.**

1. Why is it considered essential to group lead plates by welding or lead-burning, while those in a nickel-iron cell are bolted together?
2. Do lead elements always have more negatives than positives and give reasons.
3. Why are cells connected positive to negative within a battery, while the positive terminal is connected to the positive of the charging source?
4. Why is the grooved side of a wood separator placed against the positive plate and why are rubber separators used with the wood in certain designs.
5. Instructions for Plante' types of stationary cells call for an initial filling with electrolyte of 1.210 sp. gr. and a final adjustment to the same point. Does this mean that the cells are charged as soon as the electrolyte is put in?
6. Suppose one were in doubt as to whether the plates in a battery just assembled were "Sulphated," "Dry Process" or "Dry Charged." What sp. gr. electrolyte should be put in and why?

7. Suppose, at the end of this initial charge, a Locomotive Propulsion Battery averaged 1.200 sp. gr., after an initial filling with 1.210. What process plates did it have and what is there to be done?

8. Textbooks generally state that lead cells rise to about 2.56 volts on charge. Suppose a telephone battery just installed only reached 2.3 in all cells. What conclusion could be drawn?

9. Why is such care taken, in nickel-iron cells, to prevent short-circuits or grounds between the metallic containers?

10. What is the process, known to the trades, as "sweating in" and mentioned in connection with terminals on nickel-iron batteries?

#### REFERENCES.

Descriptive literature furnished by The Electric Storage Battery Company; The Willard Storage Battery Company; The Edison Storage Battery Company.

## LESSON IX.

### CARE AND OPERATION.

#### LEAD CELLS.

Care, as a factor on which storage battery life is so dependent, was mentioned in Lesson IV. Aside from the usual meaning of the word, the various phases of storage battery "operation" or the charging and discharging of every day use are included. Obviously, it is impossible to tell how to take care of a battery without telling where abuse could occur, or, in other words, outlining "operation." On the other hand, it is impossible equally to give any routine of operation without bringing in cautionary points or care. Hence, the words care and operation are generally used together.

#### CLASSES.

There are two general classes of storage battery operation, wherein the care is of a radically different nature. These include batteries operated in conjunction with an automatic generating equipment and batteries the charging and discharging of which are regulated entirely by the operator. These classes, of course, are not clearly defined; and there are some services which are semi-automatically controlled. Hereafter we shall call the class first named Class 1 and the other Class 2.

#### CLASS I: WHERE USED.

The most familiar and complete examples are the Auto. starting, lighting and ignition and the automatic isolated house lighting plant fields, together with railway carlighting where an axle generator is used.

Semi-automatic isolated plants or the central station installations which float on the line are dependent to a certain extent, on manual control and therefore on the border line between the classes.

#### AUTO. S. L. & I. FIELD (OWNER'S VIEW POINT)

It is useless to tell an owner, in this service, to keep his battery cool or watch his charging rate or a host of other things, because these



are features which the owner cannot control without curtailing the usefulness or pleasure gotten from the entire equipment. The proper instructions are very simple. They are, "Keep liquid above the plates, in the cells, by addition of *pure water*" and "Buy a hydrometer syringe and test the sp. gr. of all cells *periodically*, (at least monthly), just before adding water." Finally, "If any of the sp. gr's. are below 1.250, go at once to the local battery expert." Owners, not wishing to do any of the above themselves should be prevailed on to call at the local expert's for this attention. Free inspection cards or reduced rate inspection tickets are often issued, with this end in view.

#### BATTERY EXPERT'S SIDE (EFFECT OF SULPHATE).

Contrary to the general impression, batteries in this service are supposed to be floated fully charged *most* of the time. Their capacity for delivering energy is to be held in reserve, for emergencies such as lights while standing, starting ignition, and turning the engine over. The student has already covered the effect of standing in a discharged state (Lesson VI, Effect of Standing Idle, Lead Cells). The high specific resistance of lead sulphate was mentioned. The statement was also made that "abnormal sulphate" does no harm, if properly treated.

Auto starting and lighting systems, in use today, charge their batteries at a very nearly constant rate, irrespective of the state of charge. This rate is fixed at a value sufficient to replace the ampere-hours, used in normal service, with a margin for losses in the battery (see Efficiency). It is commonly two and three times the normal charge rate for the cells used. As long as a cell is normal, this does no harm. If, however, low electrolyte levels or unhealthy sulphate exist, local heating of the plates is produced. In the case of low level this is from reduced current path area and resultant higher resistance. The high specific resistance of lead sulphate explains the other effect.

It is well known that heat, in an electrical unit of any sort, is directly proportional to resistance, in the circuit, and to the square of the current flowing through it. In other words, the energy used in producing heat equals  $I^2 R$ , where  $I$  is current and  $R$  resistance. To return to the battery, local heating causes unequal expansion stresses and resultant buckling of the positives, because these plates are composed of inelastic material. Heating also shortens wood separator life and that of the plate grids.

It becomes apparent that the way to prolong battery life, in this service at least, is to keep sulphate reduced. When it exists, as shown by a reading of less than 1.200 of the periodic sp. gr. test, get rid of it at once, by a charge *from an external circuit*. This source of charge offers a more constant and nearer normal rate than possible with the generator on the car, reducing the sulphate in the shortest possible time and without injury to the plates. Where batteries habitually fall below 1.250, the generator charge rate should be raised. Where they require filling with water more often than twice monthly or the sp. gr. stays around 1.300, the rate should be reduced. The reason for this is obvious. When, however, one cell or more shows greater than a 25 point variation, from *any* of its fellows, an internal inspection becomes necessary. (Methods and Conclusions handled under Diagnosis of Difficulty, later lesson.) Charging, from separate sources of power is handled in the same manner as those described under Class II., this lesson.

#### OTHER SERVICES.

The same rules apply; which, expressed in simple English, are, "See that the battery is getting enough food and water." This is determined by periodic inspections of sp. gr. and electrolyte level. Automatic isolated plants generally have, in their make-up, an ampere-hour meter, with contact-making devices controlling the limits of charge and discharge. The percentage excess ampere-hours, required on charge, is given by calibrating the meter to run slower in that direction. Figuring 85% average ampere-hour efficiency (see Lesson VI); a 17½% overcharge is required or the meter should run 15% slow on charge. In this service and as the battery is completely discharged each cycle and not simply floated full, inspections are necessarily made immediately after a charge has stopped.

#### SEMI-AUTOMATIC EQUIPMENT.

These generally have an automatic feature (contact maker), whereby charge is automatically stopped, when completed. The operator's duty is to start it again, before the battery has delivered *more* than its rated ampere-hours.

#### EFFECTS OF OVER-DISCHARGE AND DISCHARGE RATE.

The products of discharge, occupying more space than those of charge, not only restrict the openings of plate pores (see Lesson VI,

Effect of Discharge on Voltage) but eventually fill the pores entirely and tend to expand them, if the discharge is repeatedly carried too far. Hence, "over discharge" causes swelling of the active material. *There is no limit to the "rate" at which lead batteries may be discharged*, within the limits of ampere-hour capacity.

#### CLASS II. FIELDS OF SERVICE.

In propulsion, railway car lighting, auto lighting and ignition, isolated plants, central stations, and a host of less important fields, batteries are handled on the "straight manual charge and discharge" basis.

#### ORDINARY CHARGING.

Ordinary charging is carried on at a rate within the limits regulated by gassing and heating. This rate may be four or five times normal, for a fully discharged battery, and one-half or a lower fraction of the same value, toward the end of charge. The limit of gassing is best learned by experience, but it can be said that it should not be violent enough to carry spray of electrolyte or cause that liquid to get white. The temperature limit, for temperate climates, is 110°F. and for tropical 125 (See Lesson IV). For ordinary convenience, normal rates are usually given, which will complete a charge in from eight to ten hours. Using the highest rate permissible, by watchfulness or automatic regulation, this time may be reduced to 3½ hours. There are services which require this speed in charging, and the subject will be handled under a suitable heading later in this lesson. As far as possible damage to a battery is concerned, there is no advantage to carrying a charge through at a low rate; but *harm will result* if this rate is too high at the finish.

#### INDICATIONS OF COMPLETION.

An ordinary charge is complete when 90% of the acid has been driven from the plates, the voltage has reached a maximum or the cells gas freely, at the normal rate. No particular point of voltage is of value, from the varying effects given in Lesson IV.

#### EQUALIZING CHARGE.

In services where the time length of a cycle is short; that is, less than a week, it has been proven more efficient to divide the charges into two classes; namely, Ordinary and Equalizing. The small amount of lead sulphate left in the plates at the end of the ordinary

charge is reduced once a week by continuing this charge, at one-half normal rate, to a one-hour maximum of gravity or at least three hours additional charge. Three "thirty minute" readings of sp. gr. on a pilot cell should be alike to realize this condition.

#### BATTERIES CHARGED INFREQUENTLY.

Where batteries are charged but once weekly, or less frequently, *each charge* should be an equalizing charge, as outlined above. Where the charges occur but once monthly or less frequently, as in Auto lighting and ignition service, each charge should be carried to a five hour maximum of sp. gr. or until six hourly readings on the pilot cell are alike.

#### "THE BOOST" OR FRESHENING CHARGE.

Short charges, to a partial state of completion, are perfectly permissible; but should always be followed, as soon as is possible, by a complete charge.

#### RAPID CHARGING.

In services requiring twenty-four hour operation daily, of a storage-battery-propelled vehicle, as in Mine Locomotives, two batteries must be operated, using one while charging the other. However, this service can be closely approximated, with one battery, by charging in the most rapid manner, either automatically or by close attention. The automatic scheme is the Constant Potential Method.

#### CONSTANT POTENTIAL CHARGING.

By this method a healthy battery may be completely charged in  $3\frac{1}{2}$  hours or 50% of the capacity can be returned to a spent battery in an hour.

As cells commence to gas at about 2.4 volts, the theory of charging at a varying rate, which will keep the cells just under that point was originated. In practice 2.3 volts is the point adopted. Forty eight cells may thus be charged from a 110 V. D./C. circuit. Aside from this advantage (42 cells only possible on gassing schemes) less water is decomposed, making attention to level less, and cell life is prolonged thru the absence of the effects of gassing or shedding of actual material. The absence of gassing also means greater current and energy efficiencies. Cells are simply kept on charge, from a circuit having a voltage of 2.3 times the number of cells, until the ampere-hour meter has reached zero reading or the rate has dropped to its minimum.

Equalizing charges are conducted weekly, in the regular manner by raising the line voltage. Batteries may be put on charge, in any state of charge, and rate will automatically adjust itself to the highest safe value. Curves in Fig. I explain these phenomena.

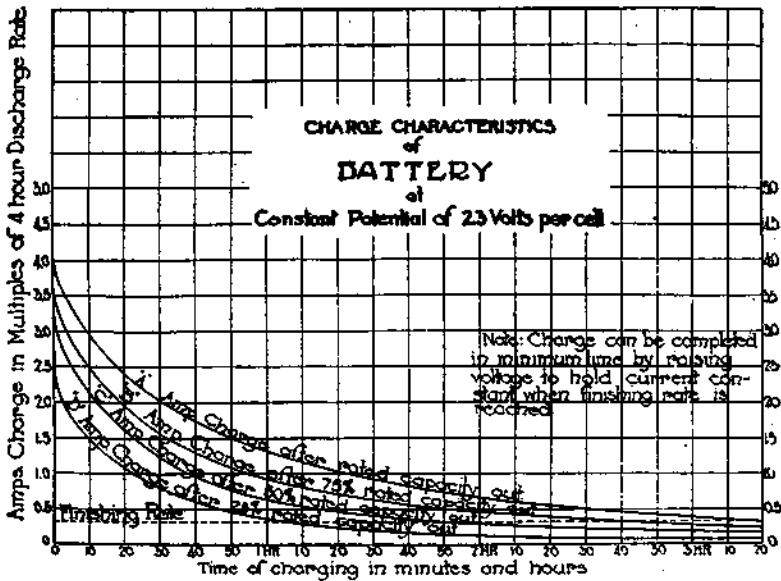

FIGURE I.

CHARGE CHARACTERISTICS OF REPRESENTATIVE LEAD CELL AT A CONSTANT POTENTIAL OF 2.3 VOLTS.

#### REGULATING APPARATUS.

Where this system of charging is used in connection with large commercial equipments, no regulation is generally necessary, as batteries are all of a like number of cells and the constant potential source can be adjusted accordingly.

In instances, however, where there are two or more different groups of cells to be charged, the voltage of the source is set for the highest number of cells. A means of cutting this voltage, for the smaller sets, must be provided. Rheostats, of any sort, will *not* do, as the voltage lost in them varies with the current. It has been explained how charging current varies, in the constant-potential scheme.

Another form of regulator, known as a Counter E. M. F. Cell or simply Counter Cell, is used, which meets the requirements of this service.

COUNTER E. M. F. CELLS.

These usually consist of cells, made in the glass or lead lined tank form of setup; but using, instead of regular plates, empty grids. As they have little or no capacity, they will immediately build up a counter or reversed e. m. f. or voltage of from  $2\frac{1}{2}$  to 3 volts, which tends to nullify the impressed voltage. This back e. m. f. is very nearly constant, within the capacity for carrying current, of the counter cell, being present even on open circuit. The current limit corresponds to the three-hour discharge rate of the regular cell of the same size.

For example, suppose we wanted to charge a 40 cell equipment, from a line adjusted for 48 or at 110 v.  $40 \times 2.3 = 92$  volts required.  $110 - 92 = 18$  volts to be reduced by counter cells.  $18 \div 3 = 6$  counter cells required.

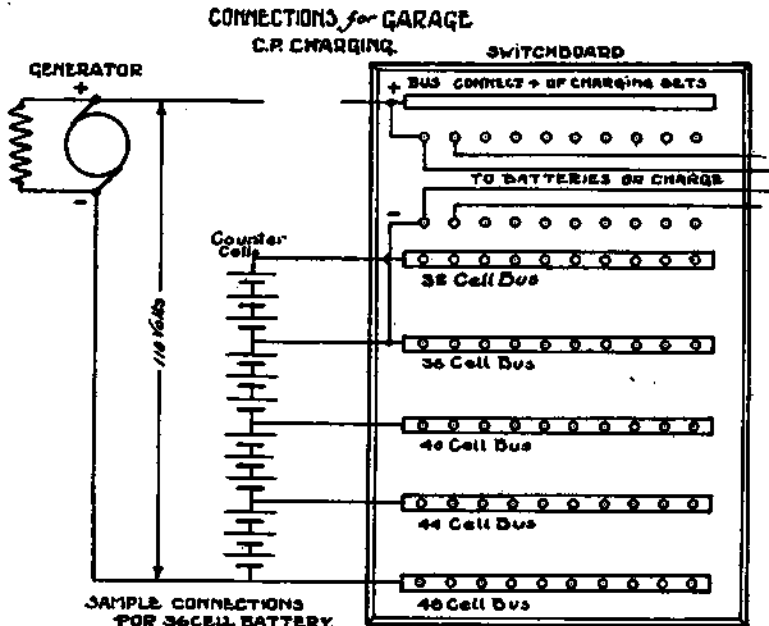

This scheme may be adapted to public garages, where all sizes of batteries are charged, by using the connections shown in Figure 2.

#### OTHER RAPID CHARGE METHODS.

Where constant potential charging imposes too much of a load on charging apparatus at the start, a fixed resistance is sometimes introduced to limit this rate. This gives us the Modified Constant-Potential Method. Of course, the effect of the resistance is greatest at the start and very little at the finish of charge, which is exactly what is needed.

#### CONSTANT CURRENT BOOSTS.

Using the ampere-hour meter reading (showing amount of discharge) and the available charging time, the maximum *constant* current, which may be maintained for that time, has been calculated for all cells and shows in Figure 3.

| Ampere-hours<br>of Discharge | ¼ Hr. | Maximum Constant Amperes for: |     |       |     |    |    |          |  |
|------------------------------|-------|-------------------------------|-----|-------|-----|----|----|----------|--|
|                              |       | ½                             | ¾   | 1 Hr. | 1¼  | 1½ | 1¾ | 2 Hours. |  |
| 20 . . . . .                 | 16    | 13                            | 11  | 10    | 9   | 8  | 7  | 6        |  |
| 40 . . . . .                 | 32    | 26                            | 23  | 20    | 18  | 16 | 14 | 13       |  |
| 60 . . . . .                 | 48    | 40                            | 34  | 30    | 26  | 24 | 22 | 20       |  |
| 80 . . . . .                 | 64    | 53                            | 45  | 40    | 35  | 32 | 29 | 27       |  |
| 100 . . . . .                | 80    | 66                            | 57  | 50    | 44  | 40 | 36 | 33       |  |
| 120 . . . . .                | 96    | 80                            | 68  | 60    | 53  | 48 | 43 | 40       |  |
| 140 . . . . .                | 112   | 93                            | 80  | 70    | 62  | 56 | 51 | 47       |  |
| 160 . . . . .                | 128   | 106                           | 91  | 80    | 71  | 64 | 58 | 53       |  |
| 180 . . . . .                | 144   | 120                           | 103 | 90    | 80  | 72 | 65 | 60       |  |
| 200 . . . . .                | 160   | 133                           | 114 | 100   | 89  | 80 | 73 | 67       |  |
| 220 . . . . .                | 176   | 147                           | 126 | 110   | 98  | 88 | 80 | 73       |  |
| 240 . . . . .                | 192   | 160                           | 137 | 120   | 106 | 96 | 87 | 80       |  |

FIGURE 3.

#### HAND REGULATIONS.

A rule, which may be used for all charging, is that any battery may be charged, in *amperes*, at a rate equal to the *ampere-hours* of discharge. For example, if a battery ampere-hour meter showed two hundred ampere-hours taken from the battery, the charge could be started at 200 amperes and continued until the cells gassed. In other words, the constant-potential scheme of charging may be closely approximated, by hand, by regulating the current so that the ammeter reading follows that of the ampere-hour meter. This tapers the charge, but, of course, requires close attention.

**DISCHARGING.**

This is generally regulated by conditions in the external circuit. The *rate* at which it is carried on does no harm and no attempt should be made to regulate it or the usefulness of equipment will be curtailed.

It is within the operator's power, however, to prevent battery injury by limiting the *duration* of discharge. Readings of ampere-hours, specific gravity or miles are often used as indications, with varying degrees of accuracy. Voltage, while current is flowing, may also be used. For example, if a 40 cell equipment is discharging at a normal rate, the discharge should be stopped when the voltage reaches  $40 \times 1.7$ , or 68 volts. In a vehicle, for example, the normal rate may be approximated by reducing the speed or loading the motor a little by slight use of the brake.

**REPLACEMENT OF EVAPORATION.**

Pure water should be added, in equipments charged and discharged, frequently, just before the equalizing charge. This allows a perfect mixture before any readings are taken. Batteries which are charged infrequently should have this attention, before *every* charge. Electrolyte level should be about  $\frac{1}{2}$ " over plate tops. In portable types, a more easily applied rule calls for filling to within  $\frac{1}{2}$ " of the cover.

**ROUTINE AND PERIODIC TESTS.**

In the larger stationary installations, ordinary charges often fall due daily, as in telephone work, and these are carried to within five points of the sp. gr. maximum established on the last equalizing charge. Floating batteries, as in emergency central station equipments, are maintained as nearly as possible to five points from the last sp. gr. maximum. This is accomplished by periodic readings on a pilot cell, in which the electrolyte level is kept constant, and adjustment of the regulating apparatus or number of "end cells" in circuit, according to this reading. In any event, equalizing charges are run each week and a full set of individual cell sp. gr. and voltage readings taken and recorded for detecting low cells.

In propulsion service, ordinary charges are carried to within ten sp. gr. points of the last maximum, until the cells are all gassing at the normal rate, for the finish of charge, or until the ampere-hour pointer has reached zero. Batteries, in this service, are often given



# BATTERY-MONTHLY RECORD

Month of \_\_\_\_\_ 191\_\_

User \_\_\_\_\_ Address \_\_\_\_\_

Battery of \_\_\_\_\_ Cells, Type \_\_\_\_\_ Plates, P. C. \_\_\_\_\_ (fill on Mono Plate)

Used in \_\_\_\_\_ Car Model \_\_\_\_\_ Year \_\_\_\_\_

## DAILY READINGS

**DIRECTIONS.**—Before charging record **Chamber and Amperes Hour Meter Readings**; also specific gravity and temperature of pilot cell.—Start charge at high rate except on auto plate, recording time and ampere.—Just as soon as battery is gassing freely, reduce current to low rate stamped on same plate, recording time and ampere.—When gassing freely at the low rate, stop charging (except when an overcharge is to be given) and record time.—Select a conveniently located cell as a pilot cell, and immediately after each charge is completed, take and record its specific gravity and temperature, if possible so do this.—Once every week give battery an overcharge in accordance with instructions under "Overcharge Readings," replacing evaporated with **PURE WATER** (not acid) before the charge is started.—In "Remarks" column mark dates of overcharge and note any unusual conditions or attention given the battery.

| Date | Chamber Reading |           | Pilot Cell |       | Current on Charge |         | Gassing Freely |      | Gassing Freely at Low Rate |      | Overcharge |       | Pilot Cell |  | REMARKS |
|------|-----------------|-----------|------------|-------|-------------------|---------|----------------|------|----------------------------|------|------------|-------|------------|--|---------|
|      | Cells           | Discharge | Sp. Gr.    | Temp. | Amps              | Amperes | Amperes        | Time | Time                       | Time | Sp. Gr.    | Temp. |            |  |         |
| 1    |                 |           |            |       |                   |         |                |      |                            |      |            |       |            |  |         |
| 2    |                 |           |            |       |                   |         |                |      |                            |      |            |       |            |  |         |
| 3    |                 |           |            |       |                   |         |                |      |                            |      |            |       |            |  |         |
| 4    |                 |           |            |       |                   |         |                |      |                            |      |            |       |            |  |         |
| 5    |                 |           |            |       |                   |         |                |      |                            |      |            |       |            |  |         |
| 6    |                 |           |            |       |                   |         |                |      |                            |      |            |       |            |  |         |
| 7    |                 |           |            |       |                   |         |                |      |                            |      |            |       |            |  |         |
| 8    |                 |           |            |       |                   |         |                |      |                            |      |            |       |            |  |         |
| 9    |                 |           |            |       |                   |         |                |      |                            |      |            |       |            |  |         |
| 10   |                 |           |            |       |                   |         |                |      |                            |      |            |       |            |  |         |
| 11   |                 |           |            |       |                   |         |                |      |                            |      |            |       |            |  |         |
| 12   |                 |           |            |       |                   |         |                |      |                            |      |            |       |            |  |         |
| 13   |                 |           |            |       |                   |         |                |      |                            |      |            |       |            |  |         |
| 14   |                 |           |            |       |                   |         |                |      |                            |      |            |       |            |  |         |
| 15   |                 |           |            |       |                   |         |                |      |                            |      |            |       |            |  |         |
| 16   |                 |           |            |       |                   |         |                |      |                            |      |            |       |            |  |         |
| 17   |                 |           |            |       |                   |         |                |      |                            |      |            |       |            |  |         |
| 18   |                 |           |            |       |                   |         |                |      |                            |      |            |       |            |  |         |
| 19   |                 |           |            |       |                   |         |                |      |                            |      |            |       |            |  |         |
| 20   |                 |           |            |       |                   |         |                |      |                            |      |            |       |            |  |         |
| 21   |                 |           |            |       |                   |         |                |      |                            |      |            |       |            |  |         |
| 22   |                 |           |            |       |                   |         |                |      |                            |      |            |       |            |  |         |
| 23   |                 |           |            |       |                   |         |                |      |                            |      |            |       |            |  |         |
| 24   |                 |           |            |       |                   |         |                |      |                            |      |            |       |            |  |         |
| 25   |                 |           |            |       |                   |         |                |      |                            |      |            |       |            |  |         |
| 26   |                 |           |            |       |                   |         |                |      |                            |      |            |       |            |  |         |
| 27   |                 |           |            |       |                   |         |                |      |                            |      |            |       |            |  |         |
| 28   |                 |           |            |       |                   |         |                |      |                            |      |            |       |            |  |         |
| 29   |                 |           |            |       |                   |         |                |      |                            |      |            |       |            |  |         |
| 30   |                 |           |            |       |                   |         |                |      |                            |      |            |       |            |  |         |
| 31   |                 |           |            |       |                   |         |                |      |                            |      |            |       |            |  |         |

## OVERCHARGE READINGS

**DIRECTIONS.**—Once every week give the battery an "Overcharge." To do this, do not stop the charge when the battery is gassing freely at the low rate, but continue charging until the specific gravity of the pilot cell and the battery voltage show no further for three consecutive readings taken at intervals of one hour. Start and record these readings when current is returned to the low rate.

## INDIVIDUAL CELL READINGS

**DIRECTIONS.**—Once each month, immediately after an overcharge, take and record specific gravity of each cell in the battery also the voltage of each cell individually, just before the overcharge is stopped.

| Overcharge given (date) |         |            |       |      |         | Overcharge given (date) |       |          |                  |         |          | Readings taken on (date) |         |         |       |  |  |
|-------------------------|---------|------------|-------|------|---------|-------------------------|-------|----------|------------------|---------|----------|--------------------------|---------|---------|-------|--|--|
| Time                    | Amperes | Pilot Cell |       | Time | Amperes | Pilot Cell              |       | Cell No. | Specific Gravity | Voltage | Cell No. | Specific Gravity         | Voltage |         |       |  |  |
|                         |         | Sp. Gr.    | Temp. |      |         | Sp. Gr.                 | Temp. |          |                  |         |          |                          |         | Sp. Gr. | Temp. |  |  |
|                         |         |            |       |      |         |                         |       | 1        |                  |         | 20       |                          |         |         |       |  |  |
|                         |         |            |       |      |         |                         |       | 2        |                  |         | 20       |                          |         |         |       |  |  |
|                         |         |            |       |      |         |                         |       | 3        |                  |         | 20       |                          |         |         |       |  |  |
|                         |         |            |       |      |         |                         |       | 4        |                  |         | 20       |                          |         |         |       |  |  |
|                         |         |            |       |      |         |                         |       | 5        |                  |         | 20       |                          |         |         |       |  |  |
|                         |         |            |       |      |         |                         |       | 6        |                  |         | 20       |                          |         |         |       |  |  |
|                         |         |            |       |      |         |                         |       | 7        |                  |         | 20       |                          |         |         |       |  |  |
|                         |         |            |       |      |         |                         |       | 8        |                  |         | 20       |                          |         |         |       |  |  |
|                         |         |            |       |      |         |                         |       | 9        |                  |         | 20       |                          |         |         |       |  |  |
|                         |         |            |       |      |         |                         |       | 10       |                  |         | 20       |                          |         |         |       |  |  |
|                         |         |            |       |      |         |                         |       | 11       |                  |         | 20       |                          |         |         |       |  |  |
|                         |         |            |       |      |         |                         |       | 12       |                  |         | 20       |                          |         |         |       |  |  |
|                         |         |            |       |      |         |                         |       | 13       |                  |         | 20       |                          |         |         |       |  |  |
|                         |         |            |       |      |         |                         |       | 14       |                  |         | 20       |                          |         |         |       |  |  |
|                         |         |            |       |      |         |                         |       | 15       |                  |         | 20       |                          |         |         |       |  |  |
|                         |         |            |       |      |         |                         |       | 16       |                  |         | 20       |                          |         |         |       |  |  |
|                         |         |            |       |      |         |                         |       | 17       |                  |         | 20       |                          |         |         |       |  |  |
|                         |         |            |       |      |         |                         |       | 18       |                  |         | 20       |                          |         |         |       |  |  |
|                         |         |            |       |      |         |                         |       | 19       |                  |         | 20       |                          |         |         |       |  |  |
|                         |         |            |       |      |         |                         |       | 20       |                  |         | 20       |                          |         |         |       |  |  |
|                         |         |            |       |      |         |                         |       | 21       |                  |         | 20       |                          |         |         |       |  |  |
|                         |         |            |       |      |         |                         |       | 22       |                  |         | 20       |                          |         |         |       |  |  |
|                         |         |            |       |      |         |                         |       | 23       |                  |         | 20       |                          |         |         |       |  |  |
|                         |         |            |       |      |         |                         |       | 24       |                  |         | 20       |                          |         |         |       |  |  |
|                         |         |            |       |      |         |                         |       | 25       |                  |         | 20       |                          |         |         |       |  |  |
|                         |         |            |       |      |         |                         |       | 26       |                  |         | 20       |                          |         |         |       |  |  |
|                         |         |            |       |      |         |                         |       | 27       |                  |         | 20       |                          |         |         |       |  |  |
|                         |         |            |       |      |         |                         |       | 28       |                  |         | 20       |                          |         |         |       |  |  |
|                         |         |            |       |      |         |                         |       | 29       |                  |         | 20       |                          |         |         |       |  |  |
|                         |         |            |       |      |         |                         |       | 30       |                  |         | 20       |                          |         |         |       |  |  |
|                         |         |            |       |      |         |                         |       | 31       |                  |         | 20       |                          |         |         |       |  |  |

**FIGURE 4.**  
**MONTHLY ROUTINE REPORT, PROPULSION SERVICE.**

two charging rates; namely, starting and finishing. The step is made from higher to lower, when gassing starts. Equalizing charges are conducted weekly and individual cell readings made monthly. A very good form for recording such a routine is shown in Figure 4. The conclusions to be drawn from these readings will be covered in Lesson X.

#### PATENTED NON-OVERFILLABLE VENTS.

Some batteries have automatic mechanisms, in the vent, to prevent overfilling. This is accomplished by locking up the air space enclosed by the cover, either by placing the finger over a hole or a valve actuated by the vent plug. Where batteries are equipped with the last-named device, charging should be done with the plugs in tightly or the valves turned artificially. Where these patented features are used, water is added, until it commences to rise in the vent well.

#### NICKEL-IRON CELL OPERATION

Charging is usually done at a rate corresponding to the rated five-hour discharge rate (60 amperes for 300 A. H. Cell). This may be varied, within certain limits. For example, higher rates may be used at the start of charge, to be tapered later. Very low rates should not, however, be used nor the cells allowed to get hot on charge. 105°F. is given as the limit (See Effect of Temperature on Capacity, Lesson V). Any amount of charge may be given, according to the output and efficiency desired, up to about fifteen hours. The normal charging period is seven hours (See Lesson VI) and this may be reduced to five, by high rate charging, for normal output. The ampere-hour meter and voltage maximum are other methods of fixing time.

#### DISCHARGE.

This is regulated by the external circuit, as with lead cells. The *rate* is limited by the ability of the battery to deliver current and the temperature, as these cells heat materially on discharge. 130°F. is given as the limit. *Duration* of discharge is limited by the cells capacity for delivering a voltage sufficient to do the work required.

#### REPLACEMENT OF EVAPORATION.

Pure water, free from dissolved air, is required. An automatic filling device, ringing a bell when the proper level has been reached, has been used with much success. Periodic attention to this is essential.

**OTHER ATTENTION.**

Creeping salts should be removed periodically and the entire battery equipment and compartment washed in hot water, as the electrolyte used attacks wood. Regular tests should also be made of the sp. gr.'s of all cells and the electrolyte renewed and sediment removed, when these reach 1.130.

**ADVICE FOR ALL BATTERIES.**

"Cleanliness is next to Godliness" in storage battery practice, as in other lines of work. It is a big factor in prolonging the life of external parts and in keeping down surface leakage of electricity.

Cleanliness also prevents charring of wooden parts by electrolytes and explosions from sparks started by this carbon formed.

*Ventilation* is very essential in allowing gasses to escape as rapidly as possible. Fire and open lights must be kept away from batteries, *at all times* because of the explosive nature of gasses formed.

All *charging* is conducted with the *positive* battery terminal connected to the *positive* of the current source. Only *direct current* (D/C) may be used. If only alternating current (A/C) is available, apparatus must be provided for its conversion.

**QUESTIONS.**

1. Why do storage battery makers advocate periodic inspection of the sp. gr.'s. of the cells in Auto Starting Batteries?
2. In detail, why do service station men recommend removing the battery from the car, to recharge it, if the above test shows low?
3. Suppose you wanted to charge a lead battery with no meters or instruments of any sort handy. How would you go about it?
4. Suppose in operating an Industrial Truck it was desired to operate on a 20 hour daily schedule with one battery and that this battery would only hold up for ten hours continuous duty. How could the above result be realized?
5. Suppose this was a lead battery replacing one nickel-iron in a large fleet, where the charging voltage was suited to the latter. What means should be used to reduce it?

6. Suppose a 200 ampere hour battery, which would under ordinary circumstances run a Commercial Truck all day, became three-quarters empty by noon on account of snow or rough going. What charging rate could be maintained constant during the noon hour and about what would the ampere-hour meter show at the end of that period?

7. Assuming that it was desired instead to watch the battery closely for this hour and taper the rate from the highest safe rate, what would this highest safe initial rate be?

8. In the absence of an ampere-hour meter, how would the driver of an electric vehicle know when the battery was discharged?

9. Could a nickel-iron battery be used to float on a line, like a lead battery in Central Station service, and give reasons?

10. To what features must attention be given in the construction of battery rooms and compartments?

#### REFERENCES.

The instruction books from Storage Battery Manufacturers.

## LESSON X.

### DIAGNOSIS OF DIFFICULTY. LEAD CELLS (EXTERNAL TESTS AND INTERNAL INSPECTION METHOD).

#### SPECIFIC GRAVITY READINGS.

In the preceding lesson, mention was made, in connection with the routines for various services, of periodic and individual cell specific gravity readings. As all the cells in a battery should be in the same state of charge at any one time, it follows that the specific gravity of their electrolytes should be within the limits prescribed in Lesson VIII. In practice, however, there are influences which cause these limits to enlarge gradually. Hence, a somewhat greater margin is allowed before trouble is anticipated. For example, in propulsion service, you were told that specific gravities were adjusted 1.275 to 1.285 at 70°F., when sets were first made. From the small variation in capacity due to specific gravity variation (see Lesson IV) cells in the service named will work reasonably well with fully charged specific gravities of 1.250 or better. The fact that 1.300 specific gravity is the highest point at which cells will charge properly (see Lesson IV) sets the upper limit. Hence, we have a rule for propulsion service, which is "If, at the end of an equalizing charge, any cells show specific gravity reading of more than 1.300 or less than 1.250 trouble should be investigated and corrected."

In the smaller portable sets (starting, lighting, and ignition batteries) the original and more liberal limits of manufacture are also given as the limits for future operation.

In stationary work (original limits 1.205 to 1.215) the operation limits are set at 1.180 to 1.215. It is not anticipated that specific gravities will ever get higher than 1.215, on account of the possible close attention to liquid level, so, in this service, the limit for operation is extended downward only.

In any case, where specific gravities come up above the limits for operation, it can be assumed that evaporation has been replaced, at some time, by electrolyte or acid. This is called "Doctoring with acid" and is often resorted to by the uninitiated, where specific gravity is low for some cause. This condition should be corrected, by removing some electrolyte and replacing with water, without further investigation.

Where specific gravities do not rise to a point within the limits for the service, further tests should be made.

#### LEAKY CONTAINER.

Cells showing low level, repeatedly, and in connection with low specific gravity, may be assumed to have leaky containers. These cells are commonly called "leakers." The container should be replaced at once, as it is impossible to repair satisfactorily any containers used today, except lead-lined tanks. Electrolyte, of the same average specific gravity as that in the balance of the cells, should be used, and the battery given an equalizing charge, when final specific gravity adjustment may be made.

A leaker is sometimes much more evident than as above, of course, but that paragraph rather covers the more difficult to locate, known generally as "slow leakers."

#### VOLTAGE READINGS.

The voltage of an entire battery varies in the same ratio, under various conditions, as that of the individual cells. However, its use is limited to judging the state of charge, from the fact that it does not show the performance of the cells singly. Voltage readings of each cell, taken with a suitable, low-reading voltmeter, were mentioned in operation routine along with those of specific gravity.

#### INDIVIDUAL CELL VOLTAGES.

For the reason mentioned above under "Specific Gravity Readings" in this lesson, cell voltages should also be substantially alike, at one time. A variation of .05, from the highest to the lowest, was allowed under Lesson VIII. This may be extended to .2 for old work. Readings should never be taken while the battery is on open circuit, but rather while it is charging or discharging at or above normal rates. The particular point of the voltage does not matter. For example, with old plates, kept rather warm and charging at a low rate, the voltages of all cells might not come above 2.3 (see

Effects on Voltage, Lesson IV). If, however, all read from 2.45 to 2.55, except one, which was 2.3, trouble should be looked for in the one.

#### OTHER EXTERNAL INDICATIONS.

Non-uniformity in the gassing of cells at the end of charge is another indication of trouble in those not gassing.

Undue heat, developed on charge, or any heat, developed on discharge shows an abnormal condition.

Continuous gassing on discharge or while cells are idle is indicative of trouble.

#### SUMMING UP.

In general, if the specific gravities, voltages and gassing of a battery are uniform, in all cells, no trouble need be looked for further, unless the abnormal heating or idle gassing, mentioned above, are present.

If specific gravities are not within the limits for operation, but the voltages and gassing are uniform, the difficulty has been probably caused by uneven or overfilling with water, which causes slopping of electrolyte. A readjustment of the specific gravities is all that is necessary in this instance. The condition of the trays, cases or racks, should, however, be checked to verify this finding and the operator notified of the trouble he is causing, not only in the acid-soaked wood but the labor involved in correcting the specific gravity adjustment.

The fact that specific gravity, voltage and gassing are low in a cell or cells, together at times with abnormal heating or idle gassing, is a sure sign of internal trouble. Further diagnosis *must* be in the form of an internal inspection.

#### HIGH RATE DISCHARGE TEST.

Testing cell voltages while the battery is discharging at a very high rate (about 25 amperes per positive plate in starting, lighting and ignition service) is a much used method of testing, not only cell condition, but the quality of the connections. When used with the specific gravity test, it makes a complete test. The same limits and conclusions apply as outlined above.

#### CADMIUM TEST.

Use is made, in storage battery factories, of another test, in designing types. Here, a separate electrode of cadmium or lead peroxide

is used. Cadmium is a metal in the same group with magnesium and zinc, which are more common. A parallel test was mentioned in Lesson V, under Voltage of Discharge, using, in that case, a substance more suitable to Nickel-Iron cells. In the Lead Cell also, such a test will, under certain conditions, show the relative states of positive and negative plates separately. There are, however, a great many correcting features, such as temperatures, rate and condition of the cadmium. Certain battery men, with manufacturing experience, make a great play on the use of cadmium for "telling whether the trouble is in the positive or negative plate." Considering that the foregoing tests have shown that trouble exists, the cells must be opened anyway and internal inspection is necessarily the last word in diagnosis. Therefore, the cadmium test, saving nothing and further complicating the work, is not recommended.

Furthermore, as an indication of completion of charge, the "maximum of specific gravity" from its chemical base (see Lesson III) is evidently the best test or indication obtainable.

#### INTERNAL INSPECTION (THE FINAL TEST).

In the above tests, "low cells" have been noted. These are either marked or identified by their numbers. In the lead-lined tank types of cells, used in some stationary services, the internal inspection can be made from the open tops, aided by a spotlight. Sediment is tested with a thin stick, thrust to the tank bottom between plates. The glass jar setups are even more visible to external view. Sealed types, however, require the cutting out, dismantling and inspection of the affected cells, for getting at repairs necessary to these cells or the *whole battery*.

#### CONCLUSION ON ENTIRE SET, FROM ONE OR TWO CELLS.

In cases of leaky containers or accidental "shorts" the conclusions arrived at generally affect only the cells examined. Otherwise, they often mean repairs necessary to the entire set or predict the end of its life, if beyond repair. It must always be remembered that, during the operation of a battery, each and every cell has been subjected to the same charging, discharging, heat, other abuse, etc. Therefore, all cells will be in the same general condition. If a set were constructed like "The Deacon's One-Hoss Shay" very likely all its cells would wear out at once, but they don't in reality. A battery, like



a chain, is only as strong as its weakest link. Hence, one or two cells' defects may be the cause of recommendations on the entire battery or set.

#### INTERNAL INSPECTION METHOD

Having concluded, firstly, which cells to inspect, from the results of the above tests, we go on with the method of getting at this work.

#### REMOVING CONNECTORS.

Bolted connectors or intercell connections in general are, of course, simply unbolted. Where the cell examined is not a terminal cell, two connections must be loosened. See Figure 1.

Drill here      Inspected cell      Drill here

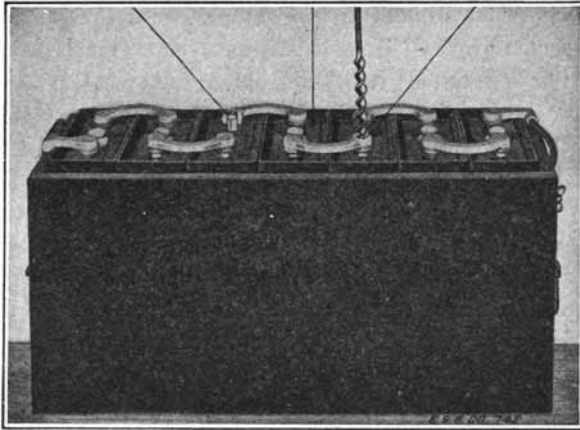

FIGURE 1.

#### MODES OF DISCONNECTING INNER CELL, FOR INTERIOR EXAMINATION.

This is done on the ends of the connectors farthest from the cell to be removed and as shown in the figure. Welded or burned connections are either drilled or loosened by heat. In the case of the former, a drill, the size of the strap post, is run into the metal of the joint, immediately over the post. This drilling is carried to a depth of about  $\frac{1}{4}$  inch or until the post end has been reached. After this, the drilled connector end can be loosened from the post by wobbling it with pliers. Figure 1 also shows position of drill. Con-

nectors are melted or burned off, by application of the lead-burning flame, in place of the drill and accompanied by wedging, upward pressure from a screw-driver or similar tool. A strip of iron is usually placed on the top edge of the wood case, to prevent any marring by this tool. A strip of wet cloth over the vents will prevent explosions.

#### UNSEALING.

In assemblies, where connectors are flooded over with compound, this must be done in two stages and the first stage must come before "Removing Connectors." This first stage is accomplished with the aid of hot wood chisels, one heating while another is in use, and the method is dictated by common sense (avoiding rubber part breakage) and the knack acquired by practice.

The second stage, that is, loosening the sealing of the jar cover, is best accomplished by steam or very hot water. *Flames should never be brought near cells.* In the absence of steam or hot water equipment, hot chisels or putty knives are used. Figure 2 shows a typical "steamer" for auto starting, lighting and ignition cells.

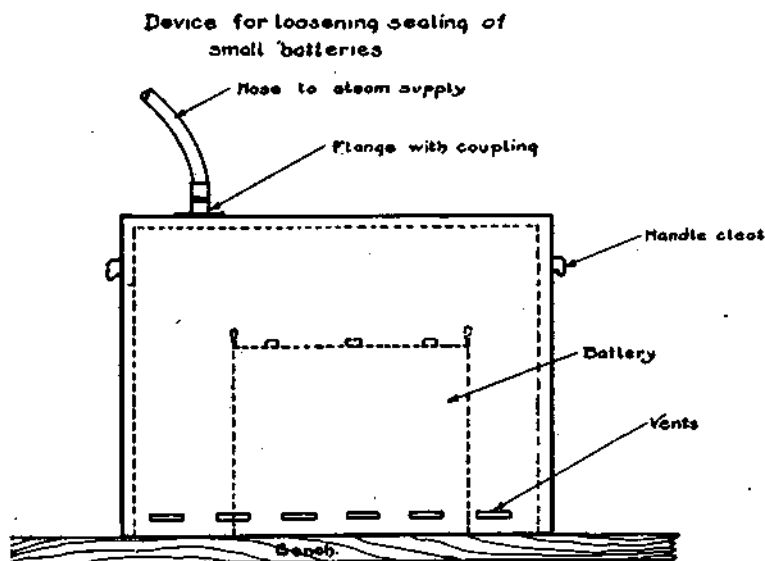

FIGURE II.

**ELEMENTS FROM JAR.**

With the cover unsealed or compound softened, the element may be lifted from the jar without removing the latter from its case. Light cell units have often to be held down, in this process, by the feet, special device or outside help. The element is not, at first, entirely withdrawn, but is allowed to rest, in a slightly tilted position (to prevent its falling back into the jar), in the extreme top of the jar, until all electrolyte has drained out. This prevents damage to clothing, floor, etc., and incidentally, saves the electrolyte for possible future use.

The element with its attached cover, connector or connectors, may be laid on a clean bench or board for examination.

**QUESTIONS.**

1. Suppose, at the end of an equalizing charge, sp. gr's. in a telephone battery ranged from 1.190 to 1.230. What could be assumed?
2. The cell on the negative end of a starting battery habitually requires more water than the others and the sp. gr. is increasingly lower. What should be done?
3. Some isolated plants have panels mounting a voltmeter which gives the voltage of the battery, yet the instructions call for a voltage reading on each cell periodically. Why is this?
4. Suppose these readings, taken at the end of an equalizing charge, ranged from 2.3 to 2.5, except one cell, which read 2.1. What does this indicate?
5. What else might this cell be expected to show?
6. Describe a good "all round" test for a starting battery service station.
7. Having made all the assumptions mentioned in questions 4 and 5, what is the way to verify them?
8. Why is it that an owner often takes a battery to a service station to have a "dead cell" examined, only to have them advise a new battery?
9. Suppose an owner brought in a starting battery, saying, "It will not hold its charge." Describe in detail what you would do.
10. Suppose this battery tested O. K. in every way. Where else, in detail, might the trouble be located?

## LESSON XI.

### DIAGNOSIS OF DIFFICULTY (INTERNAL SYMPTOMS AND CONCLUSIONS THEREFROM)

#### APPEARANCE OF ELEMENT, POSITIVE PLATES.

Positive plates are subject to the following: buckling, breaking of grids, growing, scaling, loss of material and changes in color and consistency.

#### POSITIVES ARE BUCKLED.

This effect is described graphically in Figure 3. Its cause has been given in Lesson VIII, under "Effects of Sulphation." If only slight or so that, with new separators installed, the element would, in the opinion of the inspector, return fairly easily to its jar, the plates may be passed. Otherwise and if new separation becomes necessary (see conclusions on separators, later in this lesson) they must be replaced. There is no remedy for badly buckled positives. Because of their inelastic character (except Plante types made entirely of pure lead) any attempt at pressing or other methods of straightening usually results in their breaking.

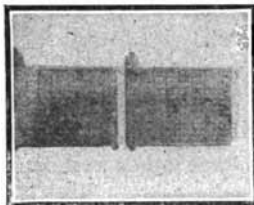

OVERHEATED PLATES.



SULFATED PLATES.

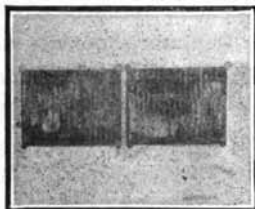
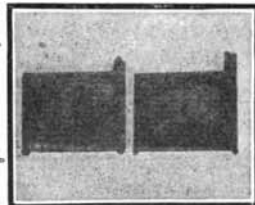

DAMAGE CAUSED BY  
FILLING WITH ACID.



BUCKLED OR  
WARPED PLATES.



FIGURE 3

EXAMPLES OF PLATE DISTORTION.

**GRIDS ARE CRACKED.**

No further description of this effect is necessary. It is generally caused by undue heating and its existence means that the grid has probably been formed to the breaking point by heat. This means lessened conductivity of the grid and poor service capacity of the plate. Hence, grid breaking is evidence of trouble far in excess of its usual first slight appearance and is sufficient cause for renewing positives, if any repairs are to be made.

**GROWING PLATES.**

This effect is also shown graphically in Figure 3. It is caused in the same manner as buckling or breaking, particularly in all lead plates. It does no harm, in itself, until the plates won't fit in their container, but lays the element open to edge short circuits. Furthermore, this effect seldom occurs in the best makes of plates, with antimonious-lead grids, and is, therefore, an earmark of poor manufacture or fearful abuse.

**SCALED.**

Positives, which have been sulphated, are often of a scaly appearance, from comparatively large pieces of active material being knocked off by further mistreatment. This effect is readily distinguishable from ordinary shedding of active material from regular use.

**LOSS OF MATERIAL.**

This occurs gradually, in normal service. When the accumulated effects of this and Scaling, if any, reach a point where capacity obtainable will not warrant labor costs in making repairs, new positives are, of course, necessary, provided also that other cell parts warrant their use. This wear occurs more heavily toward the plate bottoms (probably from greater electrolyte density there). The above "renewal point" may be assumed to have been reached, when "windows" or loss of material clear through the plate commence to appear at any point. In brief, loss of positive material, with none of the foregoing grid distortions, is indicative of natural wear or the absence of any abuse. Occurring too soon, the same may mean poor manufacture. Violent gassing also hastens this effect.

**CHANGE IN COLOR.**

Lead sulphate being white and peroxide dark brown, the colors of positive plates naturally vary from very dark, when charged, to

slightly lighter, when discharged. This change is very slight, however, in normal service. Very light color, therefore, is traceable to an abnormally discharged state, which, in turn, is usually caused by internal short circuits, leaky containers, plates broken from their straps, etc.

#### CHANGES IN CONSISTENCY.

Normal positive material is soft for a little depth and then fairly firm underneath. In the action of the cell, the soft layer is continually deepened and the outer material sheds (see Effect of Service on Capacity, in Lesson IV). Unusual heating often softens up all the material, shortening possible life. Generally speaking, plates worked continually in a partial state of charge are harder than those always fully charged. For example, positives in auto starting, lighting and ignition practice are generally rather hard, eliminating the necessity for the hard rubber sheets, placed against them in propulsion service. The life of plates in the auto starting, lighting and ignition field is usually limited by grid distortion or breaking.

#### APPEARANCE OF NEGATIVE.

These are subject to Mossing, Swelling, Loss of Material, Changes in Consistency and Invisible Changes influenced by age.

#### NEGATIVE MOSSED.

This effect is an indirect effect on the negative. We made the statement earlier in this lesson, that positive material loss is made more rapid by excessive gassing. This gassing has a mechanical loosening effect on the material. Naturally, this should fall to the space provided at the cell bottoms. Excessive gassing, however, creates a strong upward current of bubbles and electrolyte, along the faces of the positives, carrying material with it. The quiet area over the negatives allows this to settle and it soon makes contact and is converted into negative material. Just after a violent gassing charge, both plates often appear positive in color, from this effect. The danger from mossing is from the accumulation of deposited material forming short-circuits. *Its presence does not condemn negatives*, as it can be readily scraped off during repairs. It is very often accompanied by undue loss of positive material or other effect of heating from the high charge rates necessary to make the gassing. Gassing and heating usually go hand in hand. A form of

mossing often occurs on the vertical edges and bottoms of plates. It is known as "treering."

#### NEGATIVES SWELLED.

This effect has a tendency to increase the thickness of active material and make it bulge from the grid. It is caused by overdischarge (see Lesson IX). Negatives may be pressed back into shape and serviceability, so that this effect is not sufficient reason for condemning negatives.

#### LOSS OF MATERIAL.

Ordinarily, negative material has such consistency that there is little or no loss. The addition of acid to the electrolyte, however, changes this to such an extent that negatives may become as soft as positives. This effect is easily recognized from the plate consistency and any great loss, of course, condemns the plates.

#### CHANGES IN NEGATIVE CONSISTENCY.

These have been described in detail, under Effect of Standing Idle or Sulphation in Lessons VI and IX. The remedy is charging, after possibly removing any existing short circuits or leaky containers.

#### EFFECT OF AGE ON NEGATIVES.

Negatives, in normal service, seldom appear to wear out, even after one or more sets of positives have been used against them. While their appearance keeps up, however, invisible effects are at work, particularly where they have been worked against worn out positives. These effects appear in increased local action, in the cells. Depositing of copper on the negatives, from corroded terminals, etc., is a visible effect with the same result. To offset the *invisible* effects, an "age limit" on negatives is recommended. This varies, with the thickness, from 18 months to 2½ years. When, for example, very thin negatives are over 18 months old and their positives are condemned, new negatives should also be recommended.

#### REVERSED CELLS.

Where cells have been connected, in the reversed order of polarity, for some time and worked that way, there is a gradual interchange in plate color, from positive to negative and vice versa. The inherent distortions and other effects, on both plates, also become mixed, as the reversal is seldom complete. Reversed cells may be made right, by continued charging in the proper direction. The appearance of the plates, with regard to wear and distortions, is the gauge of possibility, in this instance.

**SEPARATORS.**

The natural color of wood separators is retained for a short time after they are put in service. They gradually get darker and softer. Excessive heat often makes them nearly black and very soft. In this condition, they are liable to part and cause short-circuits and should be renewed. In making an examination of an element, particular attention should be given to the edges of the separators, so as to detect any short-circuits resulting from material bridging across. Buckled plates often wear through the separators or actual checks, holes or cracks also cause these "shorts." Aside from actual defects, wood separators are usually renewed, if any other repairs are made. If removed from the element for any cause, the chances are they will be broken in an effort at reinstallation and must be renewed. Wood, after the action of the electrolyte in service, is not strong enough to be handled to any great extent, though fully strong enough to serve its purposes in storage battery work.

Rubber separators do not wear out in service. Their life is only limited by warping or other distorting actions of heat and the breakage in handling.

**CONTAINERS (SEDIMENT)**

The diagnosis of leaking containers or jars, has already been covered in this lesson. Aside from such mechanical defects, container life is unlimited. It is possible, however, to get evidence of overheating from the warped condition of hard rubber containers. This depends, to a great extent, on the method of support, in the case or tray, and the structure of the latter with regard to the spaces between side slats. Good practice indicates that these do not exceed 1" in width.

One very important thing, determined from the container, is the amount of sediment in the spaces provided at the bottom. When this *approaches* the lower plate edges, the efficiency is impaired and uneven specific gravity, voltage and unusual heat result. If allowed to reach the plates, this sediment will do great harm. Its removal from the entire set of cells is imperative, when it has approached to within  $\frac{1}{4}$ " of the plate. This operation is usually accompanied by wood separator renewal, to insure against further trouble. On the other hand, any existing sediment is removed, whatever the nature of any general repairs.

**COVERS.**



The life of this cell part is unlimited, barring mechanical imperfections and distortion from heat.

#### ELECTROLYTE.

Where there is positive assurance that no impurities exist, the life of electrolyte is unlimited. However, as tests for these are not easily made, by all concerned in making battery repairs and as it so cheap, it is usually renewed when other major repairs are made.

#### CASES, TRAYS OR RACKS.

When figuring on battery repairs, it is essential that some assurance can be had that cases, trays or racks will outlast the battery, when repaired. Prodding acid-soaked portions with an awl, screw-driver or chisel, gives the investigator an idea of how much unaffected wood remains (from the color and resistance to the tool) and enables one to judge the possible life.

The relation between acid soaked cases and specific gravity limits has already been discussed in this lesson.

#### INTERCELL CONNECTORS AND TERMINALS.

Connector life is unlimited, if properly handled. However, sometimes the labor in cleaning and otherwise refitting for use this rather inexpensive part is more than the cost of the new ones.

Terminal castings and cables, being mainly constructed of copper and brass, protected by rubber or lead, are subject to corrosion, by the acid of the electrolyte. The point, at which they should be renewed, is easily determined by common sense.

#### SUMMING UP.

After going through with examination of cell and battery parts, as outlined above, necessary repairs decided upon may be tabulated in this manner:

| MINOR REPAIRS.<br>(FEW CELLS) | MAJOR REPAIRS.<br>(ALL CELLS) |
|-------------------------------|-------------------------------|
| New Jar                       | Sediment Removed              |
| New Cover                     | Wood Separators Renewed       |
| Chance "Short" Removed        | Positive Plates Renewed       |
| Faulty Connection Fixed       | Negative Plates Renewed       |
|                               | Complete Element Renewal      |

#### REPLACEMENT (ENTIRE BATTERY)

For convenience, a form of setting forth the condition of each part should be used. A sample is shown in Figure 4.

| Received from |          | Date                     | 19             |
|---------------|----------|--------------------------|----------------|
| No. of Cells  | Type     | in                       | Cases or Trays |
| Old Number    | When new | Car                      |                |
| QUANTITY      | KIND     | PART                     | COST           |
|               |          | Pos. Plates or Groups    |                |
|               |          | Pos. Straps              |                |
|               |          | Neg. Plates or Groups    |                |
|               |          | Neg. Straps              |                |
|               |          | Connectors, side to side |                |
|               |          | Connectors, end to end   |                |
|               |          | Separators, Wood         |                |
|               |          | Separators, Rubber       |                |
|               |          | Electrolyte              |                |
|               |          | Jars                     |                |
|               |          | Inner Covers             |                |
|               |          | Outer Covers             |                |
|               |          | Vent Plugs               |                |
|               |          | Gaskets                  |                |
|               |          | Seal Nuts                |                |
|               |          | Cell Cases and Trays     |                |
|               |          | Terminal Connectors      |                |
|               |          | Terminals                |                |
|               |          | Hrs. Labor               |                |
|               |          | K. W. Hrs. charge        |                |
|               |          | Transp. In               |                |
|               |          | Transp. Out              |                |
|               |          | TOTAL                    |                |
|               |          | Cost of New Batt.        |                |
|               |          | Allowance for old        |                |
|               |          | Net cost of replacement  |                |

FIGURE IV.

EXAMPLE OF FORM FOR ESTIMATING.

Many parts, not mentioned specifically in the above classes of jobs, are decided on from the form. Battery dates or put-out numbers often influence final cost, from a standpoint of guarantee, and are, therefore, very important. For this reason, *battery nameplates should never be discarded*. In complicated layouts, a diagram of arrangement of cells and connections is often put on the back of the form shown.

#### REPAIR VERSUS REPLACEMENT.

Naturally after deciding what the repairs found necessary or advisable will cost, one begins to ask how this would compare with the cost of a new battery. If the two are alike or repair cost is the greater, there is no question which is the better thing to do. Even in cases where repair cost is less, other factors, such as exchange value of the old battery or the prospect of loss or great inconvenience from battery failure, occurring before the proper time, turn the balance in favor of replacement. This is a question requiring careful consideration, from every angle before making a decision. Too hasty recommendation of replacement soon leads to distrust by and loss of otherwise good customers.

#### NICKEL-IRON OPERATION.

The value of *specific gravity readings* in determining the point at which electrolyte renewal is necessary has been discussed in Lesson IX.

As in lead cells, *uniformity of cell voltages* is an indication of relative internal condition.

*Leaky containers* are just as evident.

Conditions of *intercell connectors, terminals and trays* are easily judged from outside indications.

In the event of internal cell trouble in The Edison Storage Battery, the one existing American make, no recourse, except shipment of the defective cell to their factory at Orange, N. J., is available.

#### QUESTIONS.

1. What are the common symptoms in plates used in starting and lighting service and their causes?
2. Under what conditions might a renewal of negative plates only become necessary?
3. Old text books so often say, "Do not short-circuit storage batteries." What would this cause?

4. It is a well known fact that storage battery cells will recover, to a certain extent, after discharge. Suppose an electric vehicle stalled for lack of current and was made to do additional mileage after standing a while. What would be the effect of repeating this?

5. Why do propulsion batteries, which show buckled or broken positive grids and soft, dark wood separators, usually have mossed negatives?

6. Under what conditions might battery failure be attributed to natural wear and not abuse?

7. What can be done with a battery accidentally charged in the wrong direction?

8. In primary cells it is often necessary to change the electrolyte and we often hear of this being done, by the untutored, on storage cells for curing low capacity. Describe the right way of curing such ills.

9. When, however, might a change of electrolyte be necessary, in a lead cell?

10. How might a troublesome nickel-iron battery be tested and and the trouble remedied?

#### REFERENCES.

The Instruction Books of Storage Battery Manufacturers.

## LESSON XII.

### REPAIR.

#### MINOR REPAIRS.

Minor repair operations, being made on but one or two cells of a battery, are gotten at in the manner described in Lesson X, for making an Internal Examination. No special electrical treatment is necessary, except that following a leaky jar renewal, which was also given in Lesson X. The subsequent assembly, carried on in the reverse order to the opening of the cells, covers the same general operations to be described later in this lesson.

#### MAJOR REPAIRS.

Having decided that one or more of the operations given under this heading in Lesson XI are necessary and advisable, it becomes the next step to dismantle the battery completely and separate its dismantled parts.

This is carried on in stages and in a manner similar to that used for making cell inspections, but to a more complete point.

#### REMOVING TOP SEALING, IF ANY.

Certain of the older designs of smaller portable storage battery units have a sealing compound "flooded" over the tops of the cells, extending to the edges of the case all around and of such a depth as to cover all but the terminals and vents. Intercell connectors are covered. This must be removed as the first step, prior to further dismantling. No better method than that of cutting and prying this compound loose, with hot chisels, has been found. Tools of various widths are used, to enable one to reach all the narrow places and to make speed on the wide ones. Great care is exercised, to avoid prying against any hard rubber or other breakable parts and to keep from bridging metal connections with the tool, as this would cause sparks which might ignite gas and cause an explosion. Tools are heated on an ordinary gas hot-plate or, more conveniently, in a gas soldering-iron furnace. One is used while others are heating, thus speeding up the work.

**REMOVING WELDED CONNECTORS.**

In addition to the methods of drilling or melting off the connectors, already described in Lesson X, there are, for some services, special pulling tools sold, which act as shearing and pulling instruments. When they work successfully, these instruments have the advantages of leaving the connectors in better shape for re-use and of leaving the strap posts in better condition, thus saving considerable time in the reassembling.

**REMOVING CELL COVERS.**

The use of steam, in this operation, saves excessive breakage of rubber parts. In the portable types, used in propulsion service, by covering the top of the entire battery or a single tray unit with a piece of sheet rubber or rubber apron, the steam, from a hose introduced under the apron or sheet, can be confined to the point desired. The "steamer" illustrated in Lesson X does very well for the smaller types. Any nuts, used to lock the covers in place on these types (seal nuts) must, of course, be removed first. In any event and before the covers cool, all adhering compound should be removed with a putty knife.

In the absence of a convenient steam source, covers may be loosened before removal, with a hot putty knife.

Covers having soft rubber edges and no sealing compound are, of course, simply pulled out.

**REMOVING CELLS FROM CASES AND ELEMENTS FROM JARS.**

In instances where the element is a tight fit, force may be applied in removing them, but the use of steam or hot water, by softening the jar, serves the same purpose with less breakage.

In automobile starting, lighting and ignition types, the operations of steaming for removing covers from cells, removing cells from cases, and elements from jars, are combined in one, using the steamer shown in Lesson X. Propulsion cells, with their covers removed as described, are pulled from their trays and set in hot water, held, preferably in a lead-lined tank, until the jar is softened. Elements can then be withdrawn very easily. A form of device, for forcing elements from jars is shown in Figure 1.

Device for forcing elements from jars.

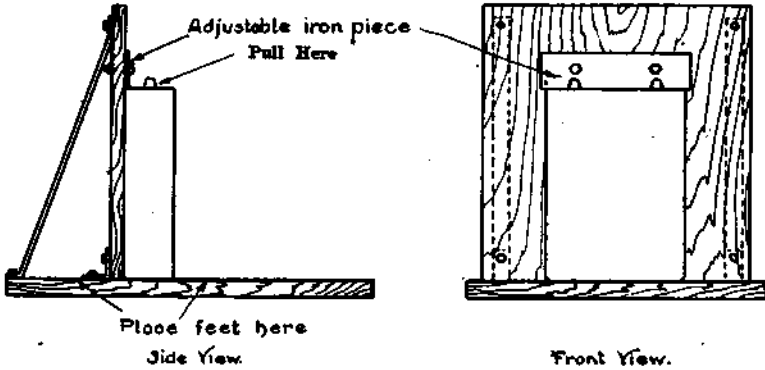

FIGURE I.

In the absence of any of the above, holding the jar between the feet, while pulling on the strap posts with pliers is a good way. Rubber overshoes increase the traction and save shoes, in this instance. This is shown in Fig. IA.

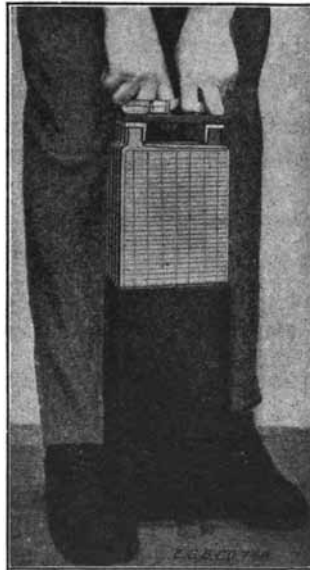

FIGURE IA.

## DISMANTLING ELEMENTS.

By grasping the positive and negative straps firmly, one in each hand the groups can usually be worked apart. Difficult cases may require removal of the separators first. This is done by pushing them downward from the plate tops, with one hand, while pulling them out, from the bottom, with thumb and forefinger of the other hand. If the groups are pulled apart first, the separators will drop out, possibly, however, requiring a little further loosening. Care, in dismantling an element, is essential, to avoid breaking rubber separators or plates from their attachment to groups.

## STATIONARY TYPES.

On account of their open assembly and liberal container space, dismantling of stationary types is somewhat different in character. However, the steps are the same. Bolted connections are, of course, simply unbolted. Plates, attached to bus bars, are clipped off, with special lug cutters. Containers, if very large, are often not moved, unless repairs are necessary. Sediment is very often removed by circulation of water or electrolyte or with special scoops and paddles. There are no particular "dodges" about the balance of repair operations on these types, and the methods are in fact dictated by common sense.

## CARE OF PARTS, AFTER DISMANTLING.

Many of the phases of care of parts after dismantling are taken care of along with these operations. For example, the care of the covers, already mentioned.

## POSITIVE GROUPS (SCRAP VALUE OF OLD PLATES).

These are either in such shape that they cannot be re-used (see symptoms of Positive Plates, Lesson XI) or it has been decided they are to be re-used. In the first named instance, they are scrapped. This scrap lead brings a price, making its saving worth while, in any locality. Plates *cannot* simply be melted into lead, but must be smelted. The best plan for the ordinary battery worker is to sell this scrap to the local junk man or ship it to a smelter.

If positive plates are to be reinstalled, a *gentle* stream of water should be played over them, then they should be stood aside, so placed as to prevent their being knocked over. The water stream should be smooth; that is, from a hose minus the nozzle.



**NEGATIVE GROUPS.**

The same two initial possibilities apply to negative groups, as positives and scrap plates represent the same value.

Plates to be re-used should be scraped on all edges, the top particularly, to remove moss. Swelled plates will have to be pressed. This is best done on fully charged plates. Hence, a charge should precede a repair job. The apparatus for pressing may be a vice, arbor press or a special machine lead-lined and with flat surfaces tightened by a threaded bar. Boards, of the correct thickness, are placed between the plates and heavier ones on the outsides. Figure 2 shows the method, using a vice.

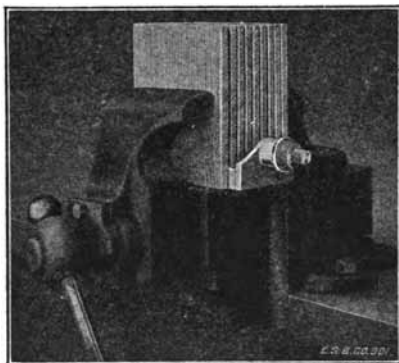

**FIGURE II.**  
**PRESSING NEGATIVES IN A VICE.**

Following all of this, a washing removes any loose material and makes subsequent operations easier on the fingers. The stream need not be so gentle, with negatives.

When exposed to the air, charged negatives will oxidize and get hot. This does no harm, except to lengthen the charging necessary after repairs. On adding electrolyte to a cell, the oxide, thus formed, sulphates, so that the cell starts off in a more discharged state. If it is necessary to stand negatives aside for very long before completing repairs, placing them in their jars and covering with water eliminates the oxidizing effect.

**PARTIAL PLATE RENEWALS.**

In instances where, from some accidental cause, some plates in a few groups or isolated groups in a battery are markedly defective, while the balance, of like polarity, are fair or better, it is proper to replace the defective plates. Otherwise, partial plate renewals are not considered a good plan, but rather a wastage of a large portion of the life of the new plates installed.

Some manufacturers insist on selling groups, rather than plates and straps, because they can do the work cheaper and more accurately. For repairing groups or assembling them, the devices shown in Figure 3 are used.

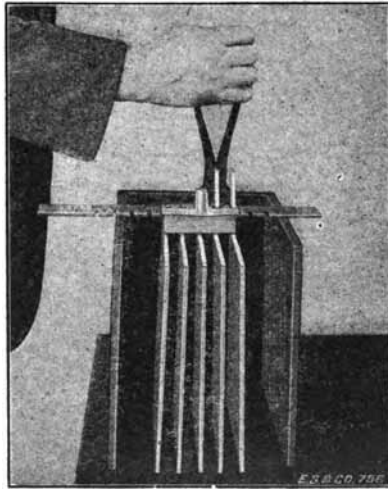

**FIGURE III.**  
**DEVICE FOR PLATE GROUPING.**

**SEPARATORS.**

As explained in Lesson XI, wood separators are never re-used when once removed from the elements.

Rubber separators are simply washed thoroughly and placed away in piles, until needed. The flat kind, used in connection with wood and against positive plates, may be badly warped by heat. If washed in hot water, piled in a press and kept under pressure until cool, this difficulty is overcome. Broken ones are simply replaced.

**JARS (SEDIMENT).**

The bulk of the sediment or deposit in jar bottoms is removable by inverting the jars, after pouring off electrolyte and bumping their edges on a box, using care to avoid jar breakage. This sediment, saved in the boxes and collected from sinks and drains, has also considerable scrap value.

After sediment is dumped, jars are either thoroughly washed by hand or piled on their sides and washed with a hose. In the latter instance, a strip of wood is put under the bottoms, to raise them and allow waste water to run out. Weighted boards keep the water from disturbing the piling. Hot water, in connection with this scheme will, from the nature of the piling, remove any side bulging effects, which the jars have gotten in service. Figure 4 shows details.

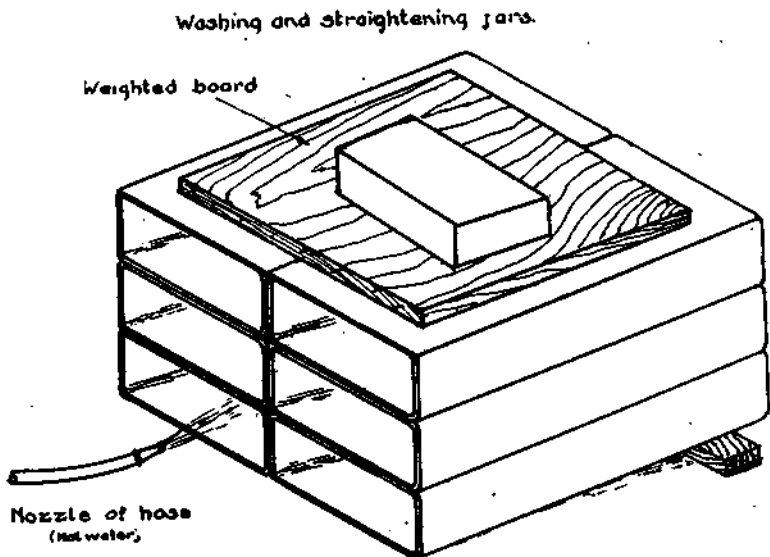

Aside from the removal of sediment from and subsequent cleaning of jars, including removal of all compound from their upper edges, there is nothing to be done except to separate the good from the bad. Hard rubber scrap is valuable, in some localities, depending on the distance from the ultimate purchasers, the rubber manufactur-

ing companies. A test for readily detecting small checks or holes which would cause leakers may be made by placing the jars on a metallic form, connected to one terminal of an induction coil secondary and passing a metal ring over them which is connected to the other terminal. The metal form is either made in various sizes or one is made variable in size and with slots in the top to admit the jar ribs. A safety gap  $\frac{5}{8}$ " long is put on the coil, to limit the test voltage. Figure 5 shows connections.

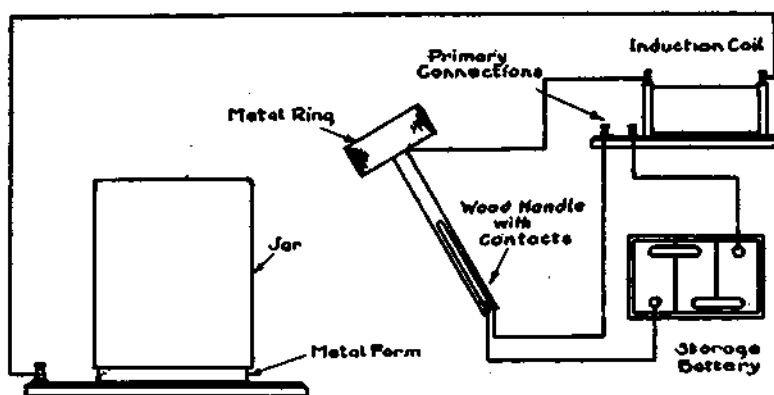

Connections for Jar Tester

FIGURE V.

This test is used extensively in new work also. It has the advantages of speed and thoroughness over other methods. Jars to be tested must, of course, be dry.

In those classes of service where jars are floated into their cases with compound, they are not removed unless defective. In these instances, for example, railroad car lighting and some automobile starting, lighting and ignition types, jars and cases are cleaned, etc., as a single unit.

#### COVERS.

Flat covers, if warped, are given a hot press and held under pressure until cold, for straightening. Other repair routine consists simply in removing sealing compound, washing and scrapping defective ones.

**TRAY, CASES OR RACKS.**

Having determined that these are to be re-used, it is merely necessary to scrub them with soda solution or other acid neutralizer. After drying, they are repainted with acid resisting paint.

**TREATMENT OF VENTS AND TRAY FITTINGS.**

Hard rubber vent plugs need no treatment, if unbroken, or are otherwise replaced. Soft rubber plugs or the gaskets on the hard rubber types, however, gradually become hardened in service. This condition often necessitates their replacement, although it may be temporarily relieved by boiling them in soda solution.

Tray fittings, consisting of terminals, handles, etc., are freed from corrosion by washing with soda solution. Boiling, in this solution, will remove the most obstinate deposits of corrosion. Subsequent treatment of handles, with paint, and terminals, with mineral grease, is essential.

**REASSEMBLING THE CELLS.**

On completion of those repair processes, covered under the headings of dismantling and inspection of parts, and on assembling the new material needed for replacement, the next step, that of re-assembling, is in order.

With the positive and negative groups interleaved on a clean bench as described in Lesson VIII, new wood separators are installed, in a manner also described in that lesson. If flat rubber separators were used, these must be reinstalled, against the positives, with a percentage of new added to replace those defective or broken.

Elements should now be placed in the jars and the covers installed and sealed. The elements should require a little outside pressure; that is, not drop in of their own weight. An extra wood separator on one or both sides of the element, with its grooves against the jar wall will remove any looseness occurring. Sealing compound is best worked with a putty knife and in a *nearly* liquid state. Heating the knife, afterward, in a flame enables one to finish the job. Covers are best warmed before use, to eliminate breakage.

Cells are now placed in their cases, unless the elements have been placed in jars not previously removed by reason of being floated in with compound. Strict regard to the polarity of the battery being repaired is essential in placing cells; that is, so they may be connected

positive to negative and bring out terminals *of the same polarity at the same location* as in the original makeup.

Intercell connectors and terminals are now welded or bolted on making the repaired set ready for addition of electrolyte.

Sometimes repaired batteries are set up without sealing in the covers and with temporary connections until after putting in electrolyte and giving the final electrical treatment. This is on the ground that any cells showing defects are more easily adjusted. However, sealing is a more difficult and less secure job after rubber parts have been wet by electrolyte. They may be cleaned, with a soda or ammonia-soaked rag, but the job is often leaky. There is no reason either why defects should develop, after careful repairs, and closer attention to this will be easier than the double work of reassembling sets in two stages.

#### ELECTROLYTE.

The re-use or replacement of electrolyte has already been discussed. If saved, a sufficient quantity of new electrolyte, of the same specific gravity as the old, should be added, to replace that lost with the sediment and old wood separators, spilled or washed from the plates. If all new electrolyte is used, its specific gravity should be at about the normal completely discharged point or, in other words, between 1.100 and 1.200. *It doesn't matter if it is too low*, as it may be adjusted upward, at the end of charge, and sulphate reduces more readily in weaker acid. However, *it does matter if it is too high* as there is danger of getting a false maximum at 1.300 (see Lesson IV). In either event, cells should be filled to the level given in Lesson VIII, and charge started immediately.

#### ELECTRICAL TREATMENT (TESTING).

The charge immediately following repairs, also known as the initial charge, is usually started at double normal initial rate. Initial charge rates are usually set at one-half the normal finishing rates by the manufacturers. After one-half hour of charging at the double figure, individual cell voltages are taken. *This tests the polarity* of connections and charging, for any cells reversed would read less than two while they *should* read more than two volts (see Lesson IV). On completion of the polarity test, the rate is reduced and the charge continued until the proper maximum is established (24 hours for pasted types, which usually means 120 hours continuous charge).

## ELECTROLYTE ADJUSTMENT.

Cells filled as outlined under "Electrolyte" will probably come up to low, from the water in the new wood separators. This necessitates adjustment, which must be done before any discharge tests if the variation is beyond service limits (see Lesson X). The quickest and most reliable method is as follows: Dump all the electrolyte of the battery into a common container, using care that the cells do not fall from their cases or trays. Measure its specific gravity. Calculate how many points this is from the nominal correct point. Raise the specific gravity to that many points over and refill. For example, suppose the dumped electrolyte of a propulsion battery reads 1.200. The nominal fully charged point is 1.280, so the dumped electrolyte is actually eighty points too low. It should be raised, by the addition of 1.4 electrolyte, to eighty points over or 1.360 and poured back in the battery. Fourteen hundred (1.400) electrolyte is the highest specific gravity which will not evolve heat, when added to lower specific gravities or water. The reason for bringing the specific gravity of the electrolyte to be put back, higher than normal, is to counteract the low specific gravity of that held in the wood separators. The variation in this electrolyte causes a slighter variation in specific gravity after dumping, and, in some cases, two dumps are necessary. A charge of at least an hour follows each dumping, to allow the acid to diffuse and equalize. Small upward adjustments are often made by simply replacing some of the top electrolyte with other of 1.4 specific gravity and giving the hour charge. In stationary service, this is the only method available, unless electrolyte is added to replace evaporation for the first few times in low cells. This last method is very dangerous, in untaught hands, as it tends to form the habit of *adding acid, which is very bad practice* (see Lesson X).

Readings, taken on the above tests, are best recorded on a form similar to that shown in Figure 6.

## FINAL TEST (BEFORE DELIVERY).

Especially in cases where temporary connections have been replaced after the foregoing electrical treatment, connections, polarity and cell condition should be tested *immediately* before delivery. These tests may be incorporated in the high discharge test as follows: Take all specific gravities. Put the set on discharge at a high rate (25

**BATTERY REPORT**

Date..... No.....  
 No. of cells..... Type.....  
 ....Charge Started .... A. M..... 192.. Ended..... A. M..... 192..  
    P. M.   P. M.

| Cell No. | First Volt. |  | Gravity End of Charge | Voltage End of Charge | Gravity After dumping and evening electrolyte |
|----------|-------------|--|-----------------------|-----------------------|---|
| 1        |             |  |                       |                       |   |
| 2        |             |  |                       |                       |   |
| 3        |             |  |                       |                       |   |
| 4        |             |  |                       |                       |   |
| 5        |             |  |                       |                       |   |
| 6        |             |  |                       |                       |   |
| 7        |             |  |                       |                       |   |
| 8        |             |  |                       |                       |   |
| 9        |             |  |                       |                       |   |
| 10       |             |  |                       |                       |   |
| 11       |             |  |                       |                       |   |
| 12       |             |  |                       |                       |   |
| 13       |             |  |                       |                       |   |
| 14       |             |  |                       |                       |   |
| 15       |             |  |                       |                       |   |
| 16       |             |  |                       |                       |   |
| 17       |             |  |                       |                       |   |
| 18       |             |  |                       |                       |   |
| 19       |             |  |                       |                       |   |
| 20       |             |  |                       |                       |   |
| 21       |             |  |                       |                       |   |
| 22       |             |  |                       |                       |   |
| 23       |             |  |                       |                       |   |
| 24       |             |  |                       |                       |   |
| 25       |             |  |                       |                       |   |
| 26       |             |  |                       |                       |   |
| 27       |             |  |                       |                       |   |
| 28       |             |  |                       |                       |   |
| 29       |             |  |                       |                       |   |
| 30       |             |  |                       |                       |   |
| 31       |             |  |                       |                       |   |
| 32       |             |  |                       |                       |   |
| 33       |             |  |                       |                       |   |
| 34       |             |  |                       |                       |   |
| 35       |             |  |                       |                       |   |
| 36       |             |  |                       |                       |   |
| 37       |             |  |                       |                       |   |
| 38       |             |  |                       |                       |   |
| 39       |             |  |                       |                       |   |
| 40       |             |  |                       |                       |   |
| 41       |             |  |                       |                       |   |
| 42       |             |  |                       |                       |   |
| 43       |             |  |                       |                       |   |
| 44       |             |  |                       |                       |   |
| 45       |             |  |                       |                       |   |
| 46       |             |  |                       |                       |   |
| 47       |             |  |                       |                       |   |
| 48       |             |  |                       |                       |   |

FIG. VI.



**BATTERY REPORT (2)**

Pilot cell to be inside cell near center of battery. Electrolyte in pilot cell to be kept at uniform height at one-half inch above plates by addition of distilled water only. Water to be added at least one-half hour in advance of readings. Any additional readings wanted can be put in blank columns (proper headings being filled in) of page 1 of this report.

Battery filled with.....Sp. Gr. ....A. M. ....192..  
P. M.

Battery Recharged.....FROM .....A. M. ....192..  
P. M.

PILOT CELL NO.....TO .....A. M. ....192..  
P. M.

| Date |         |  |  |  |  |  |  |  |  |
|------|---------|--|--|--|--|--|--|--|--|
| A.M. | Temp.   |  |  |  |  |  |  |  |  |
|      | Rate    |  |  |  |  |  |  |  |  |
|      | Sp. Gr. |  |  |  |  |  |  |  |  |
| A.M. | Temp.   |  |  |  |  |  |  |  |  |
|      | Rate    |  |  |  |  |  |  |  |  |
|      | Sp. Gr. |  |  |  |  |  |  |  |  |
| P.M. | Temp.   |  |  |  |  |  |  |  |  |
|      | Rate    |  |  |  |  |  |  |  |  |
|      | Sp. Gr. |  |  |  |  |  |  |  |  |
| P.M. | Temp.   |  |  |  |  |  |  |  |  |
|      | Rate    |  |  |  |  |  |  |  |  |
|      | Sp. Gr. |  |  |  |  |  |  |  |  |

REMARKS:

amperes per positive for starting, lighting and ignition and 50 for propulsion types). After fifteen seconds take all cell voltages. If all are over 1.75 and within .05 of one another, the set may be considered O. K. (Poor connections or reversed cells will show higher voltages. Poor cells will show lower). Stop the discharge.

#### QUESTIONS.

1. Before dismantling for repair batteries used in certain services it is well to give an equalizing charge. Why?
2. In detail, how would you take apart a starting battery, for repairs?
3. Give the method for a central station "Standby" battery.
4. The question is often asked, "Do they make old plates over and re-use them?" Answer this.
5. Some experts say that washing positives, before reassembly, wastes active material. What is your opinion of the value of such material, which would be lost by washing as described in the lesson?
6. Suppose some positive plate in a battery were worn out, while others had considerable life left, though not nearly as good as new. Why not renew only the poor ones?
7. Is there any good method of repairing a defective rubber jar?
8. One often hears the question, "What gravity of acid do I use, after repairs, to make the cells come up right?" How is the result gotten at in practice?
9. Why is the high-rate discharge test a good plan, finally, even when sets have just come off charge and been tested there?
10. In general, repairs made by good electricians, auto mechanics, etc., who have no detailed battery knowledge, fail to hold up although their assembly appears good. Why?

#### REFERENCES.

See instructions for various services gotten out by  
The Electric Storage Battery Co.  
The Willard Storage Battery Co.

## LESSON XIII.

### STORAGE.

#### NECESSITY.

Considerable has been said, in preceding lessons, on the various temporary and permanent effects of allowing lead cells to stand idle and abuses which go with it.

Briefly, it was stated that idle periods have various temporary effects, through Sulphate and Local Action, but that there is danger of permanent plate distortion and other injury from abuse of various sorts following or during idle periods. It is, therefore, customary to make some sort of provision for storing lead cells, when an idle period impends.

A common example, in the Northwest, occurs when an owner lays up his automobile, during one of the severe winters there. In this instance, storage also prevents freezing of a battery, with its resultant damage to parts, in addition to preventing other abuse.

#### FREEZING TEMPERATURES.

While a fully charged automobile starting, lighting and ignition cell is practically free from danger of freezing, a discharged one is not. This conclusion may be proven by reference to Figure 1, which shows the temperatures at which sulphuric electrolytes, of various densities, freeze. For example, 1.300 or fully charged specific gravity for the above service freezes at 95 below zero (-95 F.), while a battery normally discharged freezes at a temperature slightly above zero. As batteries often become abnormally discharged, it is easily possible for them to freeze during even a mild winter, if proper precaution is not taken.

#### EFFECTS OF FREEZING.

We are all familiar enough with cracked water pipes, milk bottles and other common objects, caused by the expansion effect of freezing liquids. In storage batteries the most apparent effect is the same; namely, that of broken cell containers or jars. Another effect, which usually becomes apparent when replacement of these containers is attempted is in the extreme swelling and disintegration of the plates.

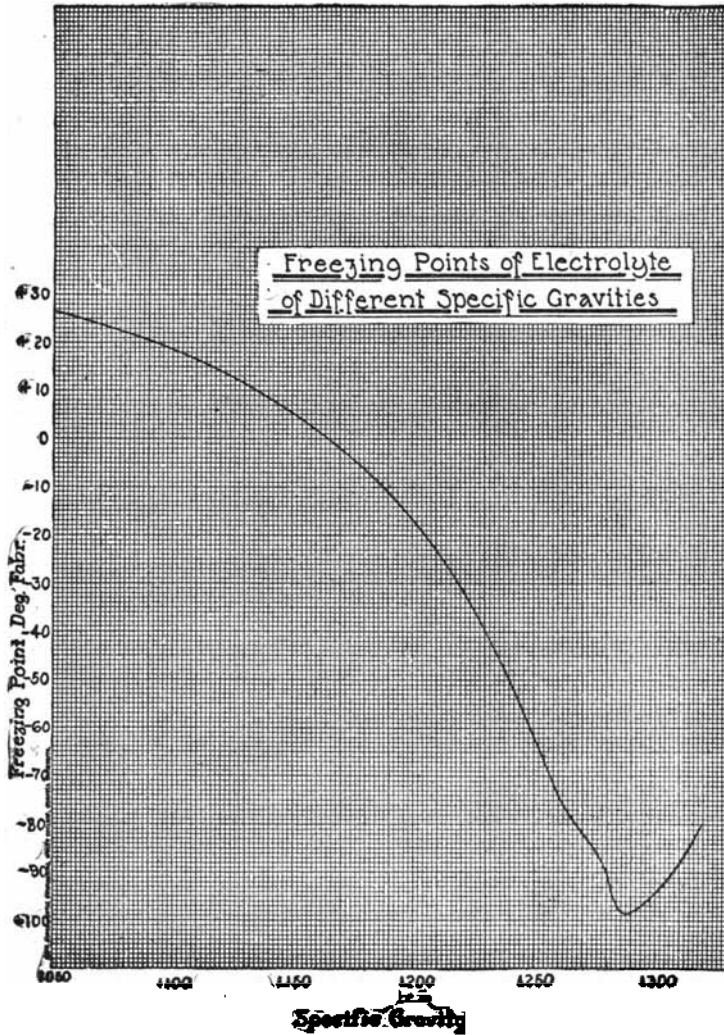

FIGURE I.

from the expansion, on freezing, of the liquid contained in their pores. In short, when a battery freezes repairs necessary are often of so extensive a nature as to warrant replacement.

#### NICKEL-IRON CELLS.

As the electrolyte density in nickel-iron cells does not change from full charge to complete discharge, and also as there is no effect parallel to sulphation in lead cells, no particular attention should be given to idle batteries. In other words, keeping liquid above the plate tops and keeping the exterior parts clean and dry, as in regular service, are the sole necessities. The balance of this lesson covers treatment of lead cells in storage.

#### CLASSES OF STORAGE.

When it becomes necessary to store a lead battery, the probable period of storage should be taken into account. If this is to be over six months or an examination shows the battery to be in need of repairs or it is impossible to give the battery proper care in storage, Dry Storage is the proper method to be used. If, on the other hand, the battery proves to be in good condition internally and the storage period is to be less than six months, the battery may be stored Wet.

The question of internal condition, mentioned above, is best settled by the methods given under Diagnosis of Difficulty.

#### WET STORAGE METHODS.

Where sufficient notice, before putting the battery back into service, can be obtained, wet storage may be safely carried on by giving the battery periodic boosts or equalizing charges at rather long intervals. This interval varies, with plate and separator thickness, from one to four months. For example, thin plates with close spacing and used in automobile starting, lighting and ignition fields, should be charged once a month, while thicker ones in propulsion and farm lighting services may be allowed to stand three or four months without charging.

Preceding such periods, however, cells should be filled rather full with water and an equalizing charge given. This charge and replacement of evaporation should also be given between each period *and just prior to removal from storage.*

Putting in water at any time other than before an equalizing charge is liable to cause freezing in the top layers of electrolyte.

The same method, of boosts and watering, may be applied where it is necessary to keep a battery ready for instant service, but the intervals are limited to weeks instead of months. In other words, in order to keep an automobile starting, lighting, ignition battery ready for service, it should be flushed or filled with water and boosted weekly.

#### TRICKLE CHARGING.

As the last named conditions of storage are common enough and as weekly boosts entail an immense amount of labor in moving, connecting, disconnecting and removing a large number of batteries, the system known as Trickle Charging has been devised to store batteries wet and ready for immediate service. It is particularly applicable to large battery service stations.

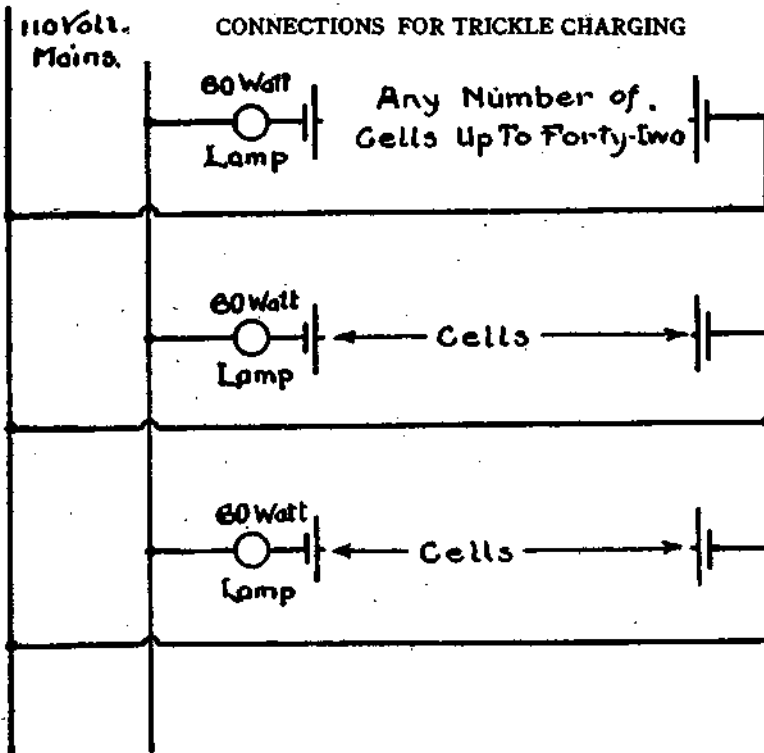

FIGURE II.

The batteries, to be so handled, are connected up, as they stand on their storage racks, in series circuits of the maximum number of sets which can be charged from the source of current used. For example, if the direct current charging voltage is 110, forty-two *cells* or fourteen six volt *batteries* may be connected in one series. These series are connected in parallel to the charging source, and through a fixed resistance. This fixed resistance should be in the form of a lamp, as the lamp acts as a pilot (to show whether or not the circuit is closed) as well as a resistance. For the 110 volt circuits, a 110 volt, 60 watt Tungsten lamp has been found to work very well, if the circuits are kept connected up.

The only other routine necessary with this scheme, is a periodic (monthly) specific gravity test followed by replacement of evaporation. The test checks the state of charge, as in batteries in service (see Lesson IX).

Figure II shows a representative diagram of connections for trickle recharging.

#### DRY STORAGE.

If the storage period is to be long or the tests outlined in Lesson X, have shown the battery to need repairs, dry storage must, of course, be resorted to.

Before dismantling a battery for this purpose it is not necessary to go through with any special electrical treatment or bother with the electrolyte, as is often given in old textbooks on the subject. In some services, however, where swelling of the negatives is common, for example, propulsion service, it is best to precede dismantling by an equalizing charge. This prepares these plates for the pressing, to correct the swelling (see Lesson XI).

After this equalizing charge, if given, dismantling is proceeded with, in exactly the same manner as that preceding repairs (Lesson XII). The parts are all washed and otherwise cared for, as outlined in Lesson XII but the plates are allowed to dry. Negative plates may heat, in this process. Wood separators are thrown away, to be replaced with new ones when the job is reassembled. The same applies to any defective parts, for example, buckled positives, etc.

A reasonable time (approximately two weeks) before the battery is to be put into service, reassembly must be commenced. There is no difference in this operation, whether following repairs or dry storage and there is, therefore, no need of repeating the procedure

outlined in Lesson XII. The same electrical treatment, adjustment and tests follow and these are recorded in the same manner as outlined in that lesson.

To eliminate this rush of repairing in the spring, it has recently been found advisable to reassemble the battery completely, without electrolyte, keeping the vent plugs in tightly during storage. Batteries may be stored in this manner for a period up to one year.

#### FINAL TEST.

Finally, the high discharge test, made immediately before delivery, as recommended in Lessons X and XI, assures the battery man that everything is all right with the battery, as to quality of cell interiors, connections and polarity. Omission of the test after wet or dry storage or repairs or recharging often leads to ten times the labor involved in the test, by necessitating disconnecting and removal of the set from its service position in order to locate trouble that would otherwise have been located before installation.

#### QUESTIONS.

1. Why do storage battery experts recommend "Winter Storage"?
2. How and why does the nickel-iron cell excel in this respect?
3. Will a battery freeze?
4. One often hears this, "Which is best, wet or dry storage?" What is your complete answer?
5. Tell how to put batteries in Wet Storage. Give details.
6. If you figured on doing a large business in Winter Storage, at a service station you happened to be operating, how would you prepare for and go about it?
7. How would a Central Station battery be taken from service for an indefinite period?
8. How would the same thing be done with respect to a Propulsion set?
9. Suppose a battery had been allowed to stand idle for a long period, with no attention, resulting in considerable evaporation of the liquid, self discharge, sulphate, etc.? What would be the way to put it in shape?
10. How are the batteries mentioned in questions 7 and 8 returned to active service?



## LESSON XIV.

### VARIATION IN DESIGN.

#### SERVICE REQUIREMENTS.

The various fields, mentioned in Lesson I, in which storage batteries are operated, naturally require batteries with various characteristics. For example, operating voltage, ampere-hours, internal resistance, weight, space, accessibility, life and first cost all influence the ultimate design of a storage battery equipment. That is, in some services, greater weight, space and first cost are often tolerated to gain increased life, for example. The lead storage battery is capable of being built in a number of ways, to meet varying service requirements, some of which ways were outlined in Lessons VII and VIII. The nickel-iron battery may be varied to meet some of the changing conditions named above, for example, operating voltage and ampere-hours. As one *principle* only is used in making this battery, the other characteristics are not variable except as mentioned in Lesson V.

#### HOW MET.

Operating voltage is, of course, varied by the number of cells used in series. Better operating voltage characteristics are often obtained in lead cells, at the higher discharge rates, by the use of very thin plates, spaced closely, or by a design of plate which allows ready diffusion of the electrolyte (see Tudor Positive, Lesson VII). Ampere-hour capacity is varied by the use of different plate sizes, numbers of plates or plate constructions and again sometimes by operating cells in parallel. Plate construction variation occurs in the lead battery only and includes the differences embodied in the Planté and Faure principles as well as the variations in grid construction, shown in Lesson VII.

Watt-hour capacity, being a result of both voltage and ampere-hour capacities, is naturally varied by any of the design changes mentioned under these two headings.

Internal resistance is co-related, to a certain extent, with ampere-hour capacity, as a cell of larger capacity usually has a relatively lower resistance. However, for special service, relatively lower internal resistances are often obtained by the use of thinner plates with

closer spacing. As these changes increase plate area, they also increase ampere-hour capacity, but the effect on resistance is comparatively greater. Internal resistance may also be increased by the use of high resistance separators, between the plates. It is often considered advantageous to sacrifice along these lines, in order to gain greater life. Sometimes a very much larger cell, with rubber separators, for example, is used to do the same work, which a smaller one without rubber separators will do. The larger combination, of course, makes a more expensive but longer lived battery, for use where these characteristics are desired.

Weight, space, accessibility, greater life and first cost, are requirements met in lead cells by practically the same design variations. Accessibility and life, it has been stated, may often be immensely more important than any of these other characteristics. The use of glass jars or lead-lined tanks, of Planté plates of wide plate spacing all tend toward ready accessibility and greater life. Accessibility is often sacrificed to a greater or less degree, to provide for portability, by the use of sealed-in set-ups in rubber jars. The position in which a battery may be operated or the amount of jarring the set may get in service, often influences the cover and vent construction. Sometimes the requirements are mixed and a battery of Faure plates with closer spacing may be installed in lead-lined tanks, for infrequent heavy discharge work. Again the same combination may be put into sealed-in glass jars, to provide a battery which may be shipped set up and charged, but after shipment used in a stationary position.

To illustrate all of the foregoing, we will name over the various fields of operation, as given in Lesson I, at the same time enumerating their requirements and how these are met by manufacturers.

#### STARTING, LIGHTING AND IGNITION.

This is a field requiring batteries of a very portable character, good voltage regulation at high output rates, and rugged construction. Batteries are operated in conjunction with a generator, which charges when the speed of the vehicle exceeds a certain value. They are supposed to be floated fully charged, on the average acting as reservoirs of energy to start the engine, supply ignition until the car reaches a certain speed, and supply current for lighting when the engine is not running.

From six to thirty volts are required, so that batteries of from three to fifteen cells are used. Batteries average about six hundred (600) watt-hours capacity, so that six volt sets have larger cells and the higher voltage sets correspondingly smaller cells. The voltage used depends on the idea of the individual designer of the system. Each has some advantages, but the six volt system is by far the most used and cheapest to operate.

Batteries, to meet the above requirements are made with comparatively thin ( $3/32''$ — $1/8''$  positives) pasted plates with close spacing, mounted in rubber jars and sealed with covers of the same material. Cells are set in tight hardwood boxes, with or without compound. The unit assembly, allowing for ease in repair is increasing in favor, although some styles are still finished off with a layer of compound on top. All connections, including straps, connectors and terminals, are welded and of heavy construction. In some styles, a core of copper is used, with a coating of lead alloy, and in others solid alloy of larger cross-section is used. Where wood separators only are used, smaller cells will do the same work, making a cheaper combination. There is an increasing demand, however, for larger cells, equipped with wood and rubber or all rubber separators and making more lasting product.

Batteries in this service weigh from 40 to 100 pounds, occupy about one cubic foot of space and cost from \$30.00 to \$90.00, depending mainly on the voltage. Six volt sets are the cheapest. The average life of the low-priced combination, mentioned previously, is 18 months, while batteries with the larger, thicker plates and rubber separators average double that figure at a first cost probably 50% greater.

#### MOTOR CARS, BOATS AND CYCLES.

These services have the same general requirements, as described above, although the motorcycle battery, being used for lighting only, is small (90 watt-hours). Motorcycle batteries are set up in three-compartment rubber jars, eliminating the use of separate wood cases.

#### TRUCKS AND TRACTORS.

Batteries for this service must be extremely rugged, because of the springless character of the vehicle and the rough roads on which used. Jars are set in their cases in compound and held doubly tight by through bolts, connections are flexible and plates supported on soft rubber pads attached to the jar ribs.

**AEROPLANES.**

Batteries in this service have the additional requirement of inverted operation, for short periods. This is met by allowing a large surplus space over the plates, in which the electrolyte may drop, clear of the element, when the battery is inverted. A long filler plug extends above the electrolyte, in this position, and prevents its escape. Normally, gas may escape through the hole in this plug. These features are shown in Figure 1.

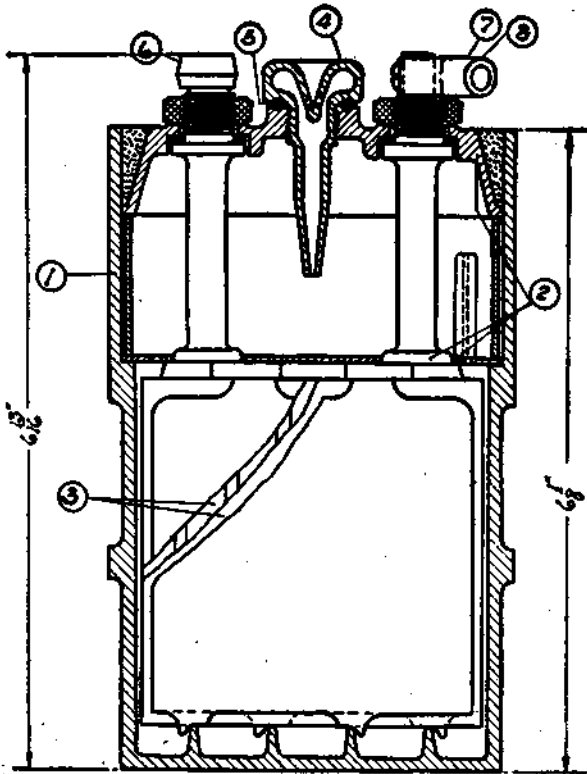

1 Rubber Jar. 2 Plate Strap. 3 Wood and Rubber Separators 4 Vent Plug.  
5 Vent Gasket 6 Inter-cell connector 7 Terminal lug 8 Hole for "Sweating in"  
wires

FIGURE 1.

SECTION SHOWING THE PRINCIPLES EMBODIED IN THE CONSTRUCTION OF AN AEROPLANE BATTERY.

**LIGHTING AND IGNITION ONLY.**

This is a field which grew up largely before the vehicles named above were electrically equipped by their manufacturers. Batteries in this service are generally operated without a generator. Plates are thicker, their spacing wider and connections lighter in construction. Batteries have about the same weight, space, cost and life as where starting is included among their duties. Voltages range from four to eight.

**FARM LIGHTING.**

This field also covers those small, isolated, lighting plants which are used for residences and industrial enterprises located apart from the lines of the power companies. The battery is required for 24-hour service, while only running the engine and generator during heavy load periods, for emergencies requiring large output (operated in parallel with the generator) and in cases of temporary derangement of the engine or generator.

There are two classes of installation, low voltage and high. The first is cheaper and is applicable where runs of less than 500 feet are required to the centers of load distribution. It will be remembered that lower voltage requires higher amperage, for the same energy output. On long runs, the high amperage requires copper of large cross-section and prohibitive cost to reduce the percentage of volts lost in the line to a reasonable figure. The standard low voltage is thirty-two (32). High voltage plants are commonly 110 volts, though sometimes 220.

Batteries are stationary in this service and the types shown in Figures 9 and 14 of Lessons VII and VIII, with Planté plates were formerly used exclusively. The class of users, however, has lately influenced the design, because the original types could not be shipped assembled and charged. Many of the older batteries have been spoiled, because the local installers failed to carry out the instructions for initial treatment. Hence, the advent of the sealed-in glass jar types and the rubber jar assemblies of today. These assemblies, using pasted plates, also have the advantages of cheapness.

Sixteen cells are used with low voltage plants. Where lights are required during charging hours, counter cells (see Lesson IX) are used to reduce the excessive voltage. From 40 ampere-hours capacity upward are provided. Plates are comparatively thick (7/32"

positives) and range from 6 to 8 inches square. Five and upward are used in one cell. These plants may be automatic, semi-automatic or manually operated. Automatic features for starting the engine and the charge and for stopping the charge are controlled, through solenoids or electro-magnets, by ampere-hour meters. These meters are compensated to run slow on charge, thus providing for the battery losses (see Lesson VI).

From 56 to 62 cells are used for 110 volt plants and they range upward in capacity from 25 ampere-hours. In general, these plants are larger and more of the older Planté types are used in them. The number of cells varies with the amount and class of discharge voltage regulation required. Fifty-six cells vary on discharge, from 118 to 94 volts. In the cheaper plants, this variation is put up with. Constant discharge voltage is obtained by using 62 cells, in connection with counter cells or by varying the number of "End Cells" in circuit. Counter cells are cheaper, but more wasteful and, hence, are used on the smaller plants.

The average life of good pasted types in isolated lighting and power service is  $2\frac{1}{2}$  years. Planté types last twice as long.

#### CENTRAL STATIONARY EMERGENCY.

In some of the larger cities in the United States power companies are penalized for interruptions in their service. These interruptions also represent loss from the watt-minutes or hours of energy undelivered or unsold. As *Insurance* against such losses, batteries are installed. These are floated fully charged and only used in cases of transmission line failures, accidents to machinery or other cause of current failure. When the emergency occurs, the battery is thrown in circuit automatically and its voltage regulated by end cells. As most power systems are 110-220 volt three wire, about 250 cells are used, with a neutral connection in the center. Terminals are also carried up at the extremes and between each of the End Cells. The large number of cells is used because discharges are usually carried on at extremely high rates and to a final voltage of one volt per cell. The "twenty-minute rate" is common. Pasted plates are used and the most common size is 15" by 30". The largest batteries of this type have 133 plates to the cell. The tank assembly (see Figure 10, Lesson VII) is used, the largest being 6' long by 2' wide by about 5' high at the top edge. The cost of the largest installa-

tions exceeded one million dollars, but this expense is soon repaid. These batteries average fifteen years in life, if discharged not more than twenty times yearly.

Where alternating current is delivered to the consumers, these "Standby Batteries" are made applicable by the use of reversible splitpole, rotary-converters, which transform A/C into D/C or vice versa, depending on whether the battery is charging or discharging. This amounts to storage of alternating current, until recent years believed impossible.

The performance of these plates in service has long since exploded the old theory (so often advanced today) that high discharge rates cause plate buckling.

#### TWENTY-FOUR HOUR SERVICE.

This field approximates that described under Farm Lighting. Smaller power stations have use for batteries in this service, carrying what is known as "Off Peak Load." Glass jar, Planté assemblies are generally used, although the size may warrant lead-lined tanks. Plates run 8, 11 and 15" square, delivering about 40, 80 and 160 ampere-hours per positive respectively. The 15" plates are always assembled in tanks. The average life is five years.

#### OIL SWITCH CONTROL.

High tension alternating currents are controlled exclusively by remote-controlled oil switches. The actuating device is either a D/C motor or a solenoid. Current is supplied by a battery floating from the exciter bus. The battery absorbs the heavy jolts of current required by these devices and prevents variation in the exciter voltage, which would in turn disturb the A/C line voltage. Sixty cells of an average 80 ampere-hour size are used. The 8 by 8" Planté-glass-jar assembly is used and the average life is ten years.

#### METER TESTING.

Many smaller, portable cells are often used in central stations, for furnishing an absolutely constant potential for calibrating or comparing voltmeters with a standard. Ammeters are compared with the aid of one or two larger, portable cells.

#### EXCITER.

This field is closely allied to oil switch control, as the battery for that use may be used to furnish the exciter current in an emer-

gency, that is, during temporary disabling of the exciting generators for the A/C generator field coils.

#### PROPULSION.

Batteries in this service are all constructed with pasted plates in rubber jars. They are all of semi-portable construction. The other requirements and how met will be mentioned under the individual headings.

#### SUBMARINES.

For submerged propulsion, submarines get their power from a 60 cell battery, installed in the lower part of the vessel. The plates (45 in number) are like the Standby Battery plates in size and construction. The most recent assemblies strongly resemble the unit cell setups used in automobile starting, lighting and ignition, only of course, immensely larger. The ampere-hour capacity is from 7,000 to 30,000, depending on the discharge rate or speed of the boat. The rubber jars and covers are ribbed and reinforced with sheet steel (imbedded in the material) and lowered into tight-fitting compartments. The bolted, flat connector and strap (shown in Figures 8 and 12, Lesson VII) are used, in the latest assemblies.

#### AUTOMOBILES.

The type of cell shown in Figure 2, Lesson VII is used. From 20 to 42 constitute a battery, depending on the design of the vehicle. The 42 cell assembly is almost universal in recent models as it is most efficiently charged from 110 v. D/C. Plates approximate 6 by 8" in size and the positives vary from 1/8 to 7/32" thick, depending on the capacity desired on a single charge. Cells range in capacity from 100 to 175 ampere-hours in capacity. For the sake of handling during removal from or installation in the vehicle, they are set up in trays holding from three to ten. Batteries weigh from 600 to 1500 lbs. Their average life is three years. The Ironclad type (Figure 5, Lesson VII) is often used, averaging five years life, at 60% increased first cost. Batteries in this service cost from \$200.00 to \$500.00.

#### TRUCKS.

This service has the same requirements as automobile propulsion, except that larger batteries are used. From 40 to 48 cells are used, having capacities of 100 to 400 ampere-hours. The same plate size



and thicknesses are used as in the above service, but batteries weigh from 1200 to 4000 pounds. An example of size, etc., was given for a two-ton truck in Lesson V. The Ironclad type is more valuable in this and locomotive service, approximating three years life, as against one to two for other types. Batteries cost from \$500.00 to \$2000.00.

#### LOCOMOTIVES.

In this service, the conditions of truck service are closely approximated and, hence, the types used. The larger cells are generally used and the number is either 44 or 88. These large cells have two posts on each strap, with two intercell connectors between each cell, for added current carrying capacity.

#### INDUSTRIAL TRUCKS AND TRACTORS.

The same types of cell, generally known as Vehicle Types, are used. They range from 12 to 40 in number, with about 10,000 watt-hours capacity to the battery.

#### STREET CARS.

Storage battery street cars are sometimes used for short runs or where trolleys or third rail are impractical. For example, under the Elevated in New York City. The requirements and batteries used so closely approximate those in locomotive-service as to preclude further description.

#### MOTOR BOATS.

This field is a rather limited one and is restricted mainly to boats used at amusement parks. The types and size are the same as for automobile propulsion.

#### TELEPHONE.

In this service, batteries are used to operate exchanges, supply talking current for signal lamps and ringing current. The last is supplied through a special motor-generator set or ringing machine. Eleven or twelve cells, of the Glass or Lead-Lined Tank-Planté setups, are used. Ampere-hour capacities range up to one or two thousand.

For private branch exchanges, small couple type batteries are often floated on the line locally.

In connection with the automatic operating and harmonic ringing systems, higher numbers of cells are often used.

These batteries have an insurance feature, as well as their regular work, as they are charged at a certain per cent of discharge rather than when empty. In other words, a certain fixed percentage of the capacity is always held in reserve for emergencies. Charging is usually done from a gas-driven generator.

#### TELEGRAPH (POLICE—FIRE) ALARMS.

In the neighborhood of sixty cells, of the Multiple-Planté-Glass Setups, are used in regular telegraph work, for furnishing the line current. Alarms are usually actuated by smaller numbers of the couple type cells. The steadiness of storage battery current is a big factor and the ease and cleanliness of operation have been responsible for the supplanting of the old gravity primary cells.

#### WIRELESS TELEGRAPH.

All wireless stations have sixty cell Planté-Glass Batteries for emergency operation.

Ships are required by law to carry enough reserve power to operate their set at full power for five hours. This is usually held in a sixty cell storage battery, using vehicle type cells. The details of the trays are somewhat different, as they are set in a tight-fitting, lead-lined box, with lid to prevent damage from salt water. All handles and connections are accessible from the top and trays are provided with porcelain skids and side insulators. Capacities range from 100 to 200 ampere-hours.

#### WIRELESS TELEPHONE.

This represents a rather new field. Hence, at present, no fixed styles or numbers of cells can be given. It is safe to assume, however, that these will approximate those used in Wireless Telegraph service, under like conditions.

#### EDUCATION.

Universities, colleges and industrial institutes generally have a glass jar Planté battery of about sixty cells for demonstrating constant-potential phenomena and the applications of the various uses named in this lesson. Such a battery may be included in the equipment of the electrical or physics laboratory, as the subject of Electricity is included in Physics. About an eighty ampere-hour set is generally used.

Portable sets are also used, of three or four cell 100 ampere-hour size, for supplying various small current required in these laboratories or for meter testing, at the same time demonstrating the features of portable construction.

#### STEAM RAILWAYS.

Storage batteries have supplanted nearly all the old fashioned gas equipments for Railway Car Lighting. In this service, Planté plates are used almost exclusively. Assembly is made in 2 cell tray units, equipped with porcelain skids and side insulators. Eight units or sixteen cells constitute a battery. Standard 32 volt lamps are used. Plates are usually 8" square with liberal spacing and set up in sealed-in rubber jars or lead-lined tanks. Wood separators, grooved on both sides, or ribbed and perforated rubber separators are used. Cells have capacities from 150 to 350 ampere-hours and units (2 cell) weight from 200 to 400 pounds. Batteries are operated on the "Straight Storage System" or are charged by an axle generator. Some roads use a power plant in the baggage car, for charging, operated by steam from the locomotive and known as "The Head End System."

*Block Signals* are often operated and lighted by small portable storage batteries in their bases. The Harriman Lines use two 2-cell units (operated in a series) of 75 ampere-hour capacity. Batteries are replaced, with fully charged sets, every four weeks and taken to a charging station.

*Interlocking Signals and Signal Bridges* are operated from a sixty cell stationary equipment, installed in the signal tower. About 80 to 160 ampere-hours capacity is used.

#### STEEL PLANTS.

Where generator loads are subject to wide variation, as in rolling mills, a storage battery, so arranged as to absorb the momentary fluctuations, cuts down the investment required in electrical machinery, steadies the voltage and increases the operating efficiency of the entire plant. The efficiency is increased because the machines are able to operate at full load. The regulation is obtained by a "Carbon Regulator" and "Shunt Booster." A Booster is a direct-connected, low voltage motor-generator set. The motor is operated across the line, but the generator is placed *in series* with the battery. The carbon regulator varies the amount and direction of the current in the shunt field of the booster generator in proportion to the variations in the line load. Thus, if the load is high, the booster adds its

voltage to that of the battery, allowing it to discharge, and vice versa. Readings, on a pilot cell, are taken periodically to keep the battery from becoming totally discharged. In other words, the battery absorbs the momentary fluctuations, but the slower variations in load are easily compensated for by adjustments to the carbon regulator. These regulators are sometimes made to make this adjustment, for permanent load variations, automatically. The attachment is called the Automatic Average Adjuster. Figure 2 shows the load under which generators operate in this service, with and without a battery.

Planté plates, generally 18" by 18", mounted in lead-lined tanks, have been used almost exclusively in this service, although the Iron-clad is gaining favor. The number of cells is generally the nominal operating voltage divided by 2.1, as this is the voltage at which cells float. For example, 120 cells are used on a 250 volt system. Capacities vary from 2800 to 8800 ampere-hours, using 25 to 75 plates per cell, at the regulating rates.

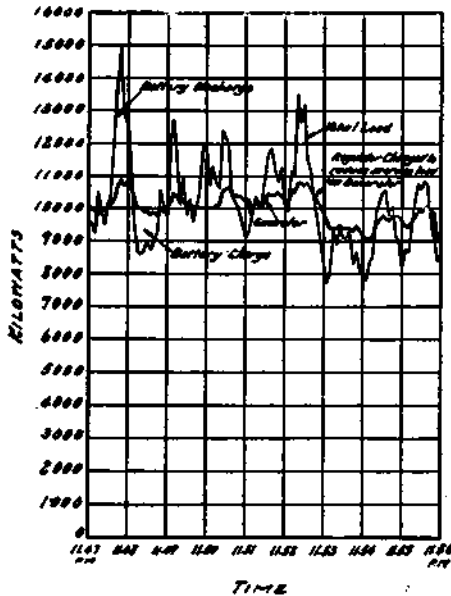

FIGURE II.

PERFORMANCE OF A REGULATING BATTERY IN A STEEL MILL.

N. B.—The heavy line shows the average generator load (note reduction). The light jagged line is the total load. Battery charges below heavy line and discharges above.

**ELECTRIC RAILWAYS.**

For regulating, batteries in this service answer the same general description as given in the foregoing. As these systems are usually 500 to 600 volts, from 240 to 286 cells are used in a series.

For emergency lighting, on electric lines, portable, low-voltage sets are often mounted under the seats of cars. The car crew does the necessary switching, where the lamps operated from the regular power fail. Separate lamps (6 or 8 volt) are used with the emergency equipment.

Cable car lines are often lighted entirely with similar equipment, batteries being charged in the car barns, thus supplanting oil lamps.

**MINE LAMPS.**

The use of one small (10 ampere-hour) portable cell, attached to a miner's belt, in connection with a two volt lamp and reflector, is growing, especially where open flames are dangerous. The cells are designed to be operated in any position, except directly inverted. They run in size, about 1 by 3 by 4 inches high and weigh one or two pounds.

**TIME RECORDING AND SCHOOL BELLS.**

Controlling clocks, placed about buildings or schools, and operating bells or signals from a master clock, is an increasing field. Ten or twelve cells of the couple type are generally used. We have an example of this use in The Dunwoody Institute.

**WAR WORK.**

The uses in this field are mainly specialized duplications of those in ordinary industry. We will, therefore, omit further description.

**NICKEL-IRON CELLS.**

These are used in many fields in competition with lead cells. The number of cells is always higher, in proportion to the difference in their average discharge voltage.

First cost, high internal resistance, cold weather performance and other characteristics exclude these cells from a number of fields. Examples are automobile starting, lighting and ignition and central station work.

In other services, however, they show up better, as where the discharge is intermittent and the handling rough and inexpert. Automobile lighting and ignition only is a fair example of these conditions. A type may be developed which will overcome these difficulties, in the near future.

## QUESTIONS.

1. What influences the design of a storage battery?
2. Suggest a storage battery design for the new wireless telephone operation from an aeroplane, to eliminate the air-driven generator used. This service requires 130 volts, very limited capacity, but light weight (not over 25 lb.) and the other requisites of aeroplane service.
3. Describe an Aeroplane starting, lighting and ignition battery.
4. What is a Standby Battery?
5. Is there any way of storing Alternating Current?
6. Why are glass jar sets sealed in, for Farm Lighting?
7. How many cells in the ordinary telephone battery?
8. What is a regulating battery?
9. What is a booster?
10. What number of cells and type would you suggest for emergency operation of a drawbridge, regularly operated from 550 volt D. C. circuit and where the battery room, mounted on piling, is subject to an occasional jar from passing boats?

## REFERENCES.

Catalogues and Descriptive literature, gotten out by various manufacturers.

## LESSON XV.

### AUXILIARY APPARATUS AND PACKING FOR SHIPMENT.

For the charging of storage batteries, of course, Direct Current (D/C) is required of a voltage sufficient to overcome the voltage of the cells and force the proper amount of current through them. It often happens that the voltage available is in excess of this value or that the current to be had is of an alternating character (A/C). These conditions and the need for current measurement or control give rise to the use of the various forms of Charging Equipment.

#### D/C CONTROL.

Direct-current control is obtained by either Rheostats or Counter Cells (see Lesson IX), for varying the voltage impressed on the battery or switches, circuit-breakers, ampere-hour meters, ammeters, etc., for regulating the duration and limits of charge.

#### RHEOSTATS.

Rheostats or variable resistances, placed in series with a battery fix the amount of current flowing through it by fixing the impressed voltage. The formula for the performance of a rheostat is a modification of Ohm's Law, as follows:

$$I = \frac{E - e}{R + r}$$

In this instance, I represents the current in amperes, flowing through the battery; E the line voltage, e the battery voltage, R the rheostat resistance in ohms and r the battery resistance. In other words and for a given line voltage, the rheostat resistance required to give a certain charging current is dependent mainly on the number of cells and their size. In practice a variable resistance is very often used and the resistance set by reference to the ammeter or current indicator.

Resistance material may be made of metal, carbon or liquids. High resistance wire or ribbon or iron, german-silver, or other

alloys constitute the resistance element in the metal forms. These are supported in air, on porcelain tubes or imbedded in enamel. All the leading manufacturers of electrical equipment make good types. In ordering, reference should be made to the maximum ohms required, the ampere carrying capacity and the number of steps.

Plates of carbon have the peculiar property that, if a number are arranged face to face and the pressure upon them varied, the resistance of the lot is varied. This is the principle of the carbon rheostat, variation in pressure on a "pile" of carbon plates being obtained in practice with a screw. These rheostats are rated in Watts and have no steps and the latter fact is their principle advantage. They also have less weight and occupy less space than other kinds. The Allen-Bradley Company, of Milwaukee, specializes in Carbon Rheostats.

Liquid or "Water Rheostats" are in the main only makeshifts and used temporarily. Lead plates, immersed in very dilute sulphuric acid which is contained in wooden or earthenware vessels, constitute one form. The plates are made movable, so as to vary the distance between to increased or decreased resistance. Further variation is obtained by varying the amount of acid in the solution. Iron plates and a solution of washing soda or common salt are very often substituted.

Rheostats, switches, meters, etc. are usually arranged on a suitable switchboard for convenience and are sold in that manner by leading electrical supply houses.

#### A/C CONVERTERS.

When only alternating current is available, it becomes necessary to provide some sort of a Rectifier to convert it into D/C. The forms in common use are the Motor-generator Set, Mercury Arc Rectifier, "Tungar" Rectifier, Electrolytic Rectifier, Commutator, Rotary Converter and Vibrating Rectifier. These all have advantages but varied characteristics. A brief description of each follows:

#### MOTOR GENERATOR SET.

These are just what the name implies, a motor (A/C) and a generator (D/C). The two may be direct-connected; that is, on the same shaft, within the same frame, or belt-connected. Again they may be on the same horizontal plane or superimposed, the



latter combination making the "vertical type." The vertical type, of course, occupies less floor space. Motor-generator sets, in general, cost more at first than other forms of charging apparatus. Their average efficiency is also lower than some forms. However, they are made in larger capacities than any other form and there is practically no upkeep on the machine. These features and the fact that charging rates are capable of being varied to any extent (in other words, their convenience of operation) are responsible for their wide-spread use. In fact, the Motor-generator set is more common than any other form of current rectifier. Figure 1 shows some points of comparison with the Mercury-arc Rectifier.

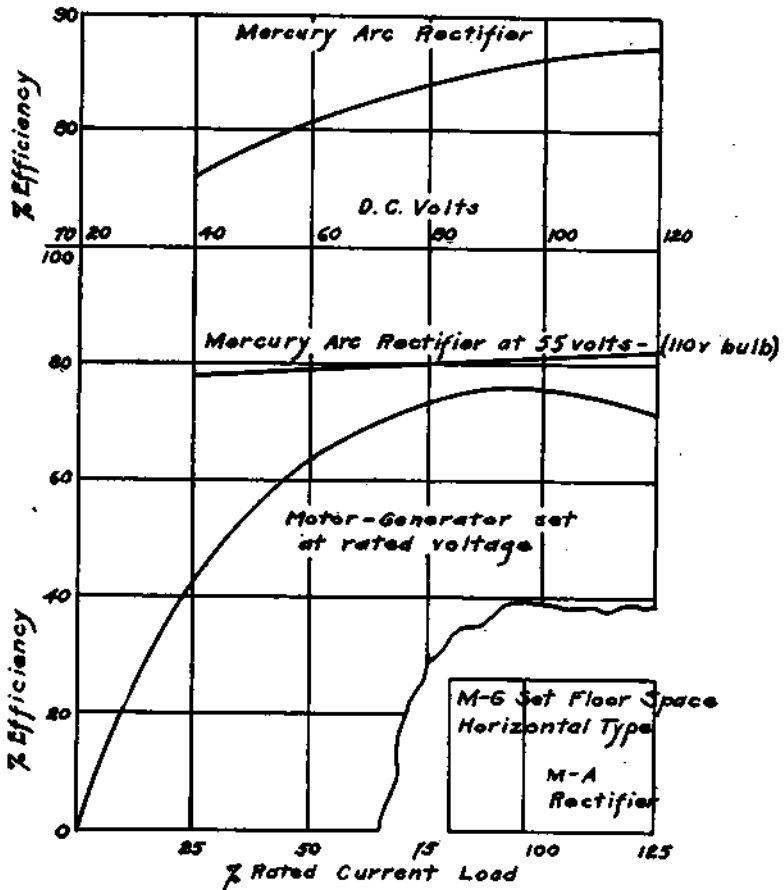

FIG. 1.

MERCURY-ARC RECTIFIER.

The principle part of this machine is the bulb. This is of glass, from which the air has been exhausted. On either side of the bulb arms protude. These have sealed-in carbon electrodes, which form anodes or negative poles. Mercury is held in the bottom of the tube and is connected to another contact, making the cathode or positive pole. Close to this is a small arm, with contact into which the mercury will flow when the bulb is tipped. In the completed machine, this forms the starting anode; as, when the bulb is tipped it starts an arc. When the proper changes in connection are made on the switchboard provided, this arc jumps to the regular anodes and continues between there and the cathode. The other parts

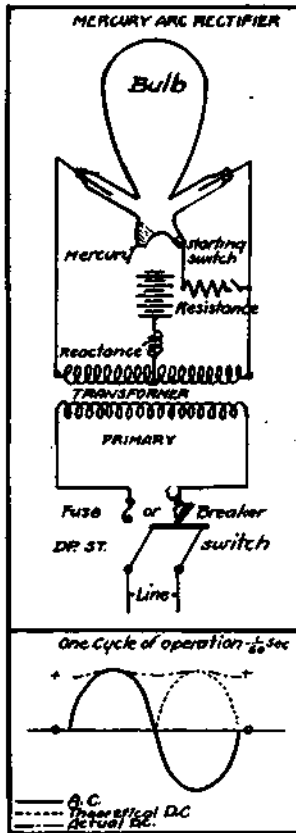

FIG. II.

of this machine are a transformer, for bringing the line voltage down or up to that required for charging, and reactances which sustain the arc. It must be remembered that common alternating currents reverse their polarity 120 times per second. The fact that the current will only flow from anode to cathode inside the bulb explains its ability to rectify these pulsations. Figure II shows a diagram of connections, with explanation, including a diagram of the current waves before and after rectifying.

The mercury-arc rectifier has a relatively high efficiency (Fig 1), occupies little floor space and its first cost is reasonable. However, there is considerable upkeep, as the bulb life is only 1000 hours (at full current load), on the average, and they are rather costly. Again they may not be operated at less than a certain minimum current, which is  $\frac{1}{2}$  to  $\frac{1}{4}$  full load. as the arc will go out. These machines have been made to restart automatically, but do not generally do so. The accompanying control panel usually has a circuit-breaker, to protect the bulb from overload; starting switch; line switch; voltmeter; ammeter and regulating steps. Outfits, using one bulb, are made to deliver from 10 amperes 30 volts D.C. to 50 amperes 220 volts D.C., using 110 or 220 volts A.C., although any A.C. voltage could be used.

#### TUNGAR RECTIFIER.

The General Electric Co., of Schenectady, N. Y., has recently gotten out an improved bulb rectifier, eliminating most of the defects present in the Mercury Arc. The Tungar bulb is shaped very much like an ordinary Nitrogen-filled Tungsten lamp. In place of the usual tip blown into the top, the Tungar bulb is elongated and carries another electrode, the anode. In the bulb is an inert gas—Argon. The combinations of the heated filament and the gas makes it possible for the current to flow in but one direction from Anode to Cathode. Therefore, current may only flow from Cathode to Anode or positive to negative in the external circuit, made up of batteries charging.

This machine is comparatively cheap, bulb upkeep is small, and any variation in charge rate, from zero to full capacity may be secured. Furthermore, it automatically restarts, after current interruptions. Efficiency and cost of operation are shown in Fig. III.

Figure 3

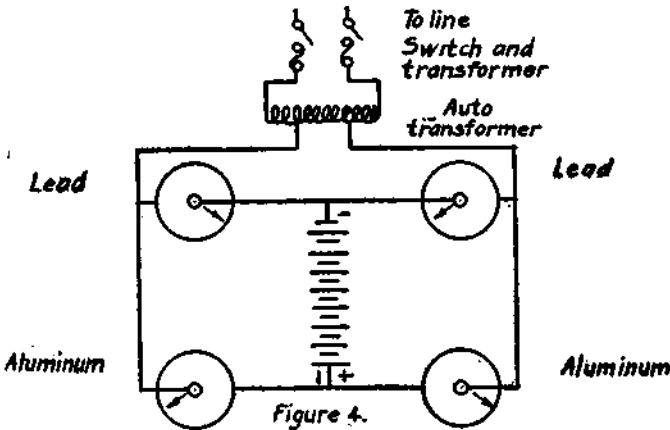
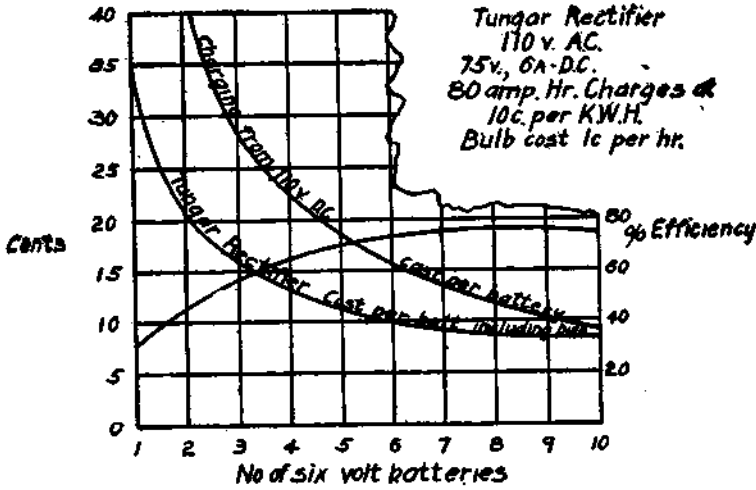

Electrolytic Rectifier Connections  
for using both pulsations of AC.

Many service stations, for automobile starting, lighting and ignition batteries, are equipping with a Tungar for light loads and a motor-generator set for heavier loads. This enables them to work their M.G. at a higher efficiency (see Figure 1).

## ELECTROLYTIC RECTIFIER.

When electrodes of lead and aluminium (aluminum) are immersed in certain electrolytes, the combination acts as an electrical check-valve, as current can only flow from aluminum to lead, within the cell. Solutions of Sodium Phosphate or Micro-Cosmic Salt are used as electrolytes. Four cells may be arranged, according to Figure iv, to allow all pulsations of current to be used, that is, of both directions, as in the Mercury-Arc Rectifier. The Electrolytic Rectifier is little used, on account of its low efficiency, limited capacity and messiness. It heats readily and both electrolyte and aluminum must be renewed periodically.

## COMMUTATOR.

In the armature of a direct-current generator, the current alternates in direction as the conductors pass field-pole pieces of opposite magnetic polarity (north or south). This is rectified (made unidirectional) by the commutator, which is familiar to all workers on this class of machinery.

If a separator commutator is driven in step with the alterations of commercial A.C. (synchronous speed) the same rectifying effect is obtained. This is accomplished by the use of a Synchronous motor, driving a suitable commutator. The machine is comparatively very small, especially in large capacities, and very efficient, as only a small motor ( $\frac{1}{8}$  to  $\frac{1}{4}$  H.P.) is required to drive the commutator. The energy used by this motor and the losses in the wiring and connections represent the only loss. There is sometimes difficulty with sparking in machines worked at heavy loads and often a fan is placed on the motor shaft, next to the commutator, to blow out the sparks and cool the segments.

We are indebted to the Stahl Rectifier Company of Chicago for the following figures:

|                  |                                      |                    |
|------------------|--------------------------------------|--------------------|
| Type SX Capacity | { 30 to 60 volts }<br>{ 36 amperes } | from 110 volt A.C. |
|------------------|--------------------------------------|--------------------|

Efficiency full load 83%.

## ROTARY CONVERTER.

This form of apparatus depends for its action on the fact that part of the current in the armature of any synchronous motor may be commutated and taken out as direct-current. The machine has

all the features of any shunt-wound D.C. generator with the addition of collector rings, for carrying the A.C. to and from the armature, placed on the end opposite the commutator. Any direct-current generator may be made into a Rotary Converter by taking off connections from the commutator, and carrying them to collector rings. Figure v shows a two-pole, single phase connection.

FIGURE 5.

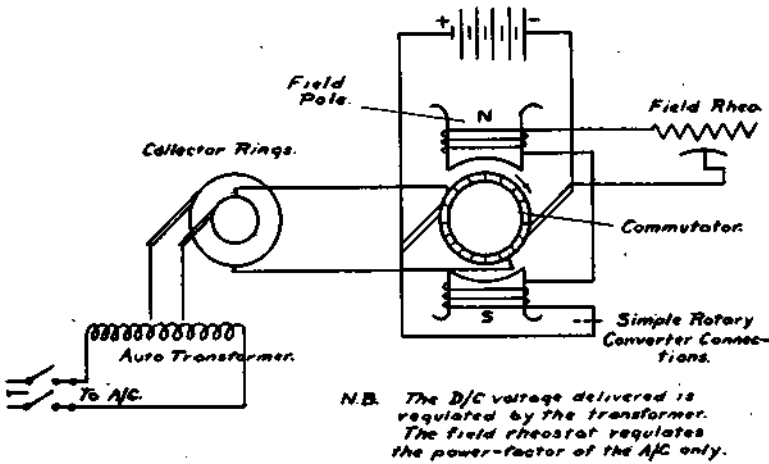

Connections are made from diametrically opposite commutator bars to two rings for single phase, at ninety degree points to four rings for two phase and 120 degrees apart for three phase. There must also be an additional set of connections for each added pair of field-pole pieces. A.C. is supplied to the rings, driving the armature at synchronous speed. D.C. is commutated at the other end of the shaft, part of which energizes the field coils. Two or three phase machines have more capacity as Converters than as Synchronous Motors, D.C. or A.C., or double-current generators. This machine is a double current generator, when belt-driven from an outside source of power supplying A.C. at one end and D.C. at the other. As a converter, the efficiency is high, the space occupied and upkeep low. It is, however, rather unstable in operation and is limited in use to large Central Station work. An example was given in Lesson XIV under that heading.

## VIBRATING RECTIFIERS.

For charging of one or a few automobile starting, lighting and ignition batteries, a form of current converter called The Vibrating Rectifier has been used to a great extent. This instrument utilizes a permanent magnet and electro-magnet. It is well known that opposite magnetic poles (north and south, for example) tend to draw together, while there is a repulsion between like poles. In the vibrating rectifier, the electro-magnet is mounted in such a way that its poles are between or adjacent to those of the permanent magnet. Because the coils of the electro-magnet are energized from an alternating current, its poles change from north to south in synchronism with the alternations. As the polarity of the permanent magnet remains fixed, there is a tendency to alternate repulsion and attraction, in tune with the current frequency, between the two magnets. By making the electro-magnet small and hinging it with springs, as in the armature of a door bell, it becomes possible for this magnet to vibrate, in tune with the alternating current. By providing it with a contact-maker, one pulsation of the alternating current is stopped, making a form of pulsating direct current suitable for charging batteries. Voltage regulation is obtained by the usual transformer. Large machines have two units, operating in parallel. This apparatus is cheap, low in upkeep and efficient. Renewal of the contact-making surfaces is occasionally needed. The limited capacity possibly excludes it from more general use.

## LEAD BURNING.

In Lesson VIII mention was made of the method of lead-welding called Lead Burning. We will here describe the apparatus needed to get the very hot flame used. The blast flames secured by the mixtures of city gas, gasoline or alcohol with air, while hot enough to melt lead, are not "fast" enough for lead burning. The earliest successful flame was that made by burning *hydrogen* with a blast of *air*. Hydrogen was made in a generator, using zinc or iron and dilute sulphuric acid. Increasing cost of these metals and the messiness of a generator caused *Tank Hydrogen* made electrolytically, to displace this form of apparatus. Later it was found that *city gas*, burned with a blast of *oxygen* was hot enough. As this combination eliminates the need of an air compressor and as oxygen is more widely obtainable, it has displaced the other forms, except where city gas

is not connected. In the latter instance recourse is had to the oxy-acetylene flame. All makers of oxy-acetylene welding apparatus make lead burning outfits. These may be used with oxygen, in connection with the city gas or acetylene, and are simply smaller counterparts of the regular welding torches. Small places often have recourse to a red hot soldering iron used as a source of heat. No tinning or flux is used and the method of running the melted surfaces together is the same.

For inspections on larger batteries or for portability, the Arc-Burning Outfit is often preferred. This is simply a clamp, with handle of wood or fiber, made to hold a small, carbon ( $\frac{1}{4}$ " diameter) pencil. To the clamp is attached a piece of No. 6 flexible cable of convenient length, which is in turn attached to a C clamp. For melting and reburning external connections on a battery the C clamp is attached to another connection "Twelve cells away" in either direction. See Figure 6. As soon as the carbon touches the place to be melted, an arc may be drawn, furnishing heat for lead burning. By using three cells, instead of twelve, and holding the carbon on the joint continuously, the carbon will get white hot and furnish sufficient heat. This method takes a higher current, but does a cleaner job. Dark glasses should be worn by the operator in either case. These methods are also applied to other lead burning operations by using an outside current source, for example, a six volt storage battery or transformer. In these instances, another cable must be used to carry the current from the remaining pole or terminal of source to the work.

#### METERS

In the preceding lessons, meters of various sorts have been mentioned frequently in connection with battery routine and testing. Those most used are Hydrometers, Thermometers, Voltmeters, Ammeters (Ampere Meters) and Ampere-hour Meters.

#### HYDROMETERS.

These are made in two scales, Specific Gravity and Baumé, as shown in Lesson IV. However, the latter scale is very little used in the United States. In open stationary types the instrument itself floats directly in the electrolyte of the cell. Where the cells are sealed in, however, this is impossible. Recourse was had at first to a syringe and small test tube, the hydrometer being floated in a sample of the electrolyte thus taken. The advent of the *Hydrometer*



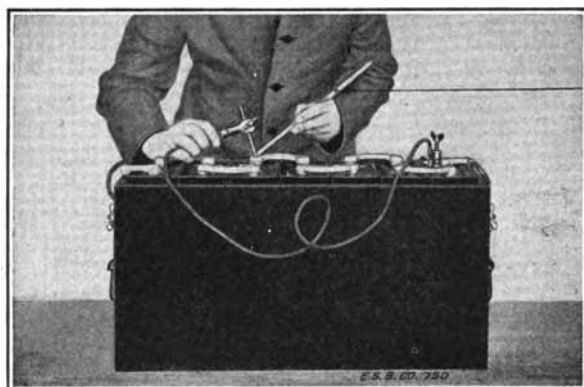

Extra  
Lead



Soldering  
Iron

Extra  
Lead

FIGURE VI.

METHOD OF USING CURRENT FROM BATTERY FOR REPAIRS OR  
INSPECTION AND WITH ARC BURNING OUTFIT.

*Syringe* cut out the use of the Acid Testing Set. Hydrometers for large stationary work are usually mounted permanently on the pilot cell and arranged to signal at a certain high or low point in specific gravity. Again they often record the readings at all times, on a chart form provided, in addition to signalling the danger points. Pilot cells are equipped with Automatic Cell Filler to keep the level constant. All firms making storage batteries sell hydrometers of types to fit the fields of operation covered by their product.



FIGURE VII.

HYDROMETER SYRINGE.

**THERMOMETERS.**

Special battery thermometers, made to float in the electrolytes of open cells or insert in the vent of others and with correction scale

for specific gravity attached, are made by the storage battery manufacturers. The Dairy Thermometer is also popular for these purposes. The Fahrenheit scale is used exclusively in this field in the United States.

#### VOLTMETERS.

Switchboard and Vehicle Types of instruments, for judging state of charge, are made with ranges to suit the numbers of cells commonly used by all instrument manufacturers. The D'Arsonval Galvanometer Type, being polarized, is the most suitable. This means that the meter will show reversed polarity.

Portable instruments, for individual cell reading, should have a three-volt range, with divisions allowing for readings to within .01 volt. When the cadmium (Lesson X) is used, this range should be limited thus: -.2-0-2.8; that is, an allowance made for reversed readings down to -.2 volts. Meters of this sort are carried in stock by battery and meter firms. A polarized meter is also essential for any portable work. These instruments are usually equipped with flexible leading wires and prods. Good prods are made of steel ice picks, obtainable from any hardware dealer.

#### AMMETERS.

Switchboard and Vehicle Types, with ranges to suit the service, are often installed to show battery load or charging rate. It is customary to place zero in or near the center of the scale.

The meter reads "Charge" on one side and "Discharge" on the other. The D'Arsonval Galvanometer principle, being polarized, is best. The use of "non-polarized" meters, in cheap outfits, has often resulted in damage to a battery from injurious reversed charges.

#### AMPERE-HOUR METERS.

An instrument reading directly in ampere-hours is one of the surest indications of state of charge in any storage battery. These meters are usually made to run away from zero on discharge and back on charge, as this gives a direct indication of the amount of capacity which has been taken from a battery at all times. These meters are commonly made to run slow on charge, to allow for battery losses, (Lesson VI). Other compensations are made for idle periods and high discharge rates. Totalizing circles, to show total charge, discharge or both, are often added as a guide to battery

efficiency over long periods. Again, a contact at zero is often used to actuate a circuit breaker and stop the charge. The Sangamo Electric Company of Springfield, Illinois, specializes in these meters and "breakers."

#### TOOLS AND OTHER EQUIPMENT.

Under this heading is included Hand Tools, Benches, Sinks, Wood Separator Tanks, Holding Racks and Special Testing Devices.

#### HAND TOOLS.

Special wrenches, Connector Pullers, etc., may be purchased from the battery makers. The balance of the tools used in battery practice are carried in stock by all hardware dealers. Examples are Wood Chisels ( $\frac{1}{4}$  to 1" wide), for removing top sealing; Putty Knives (1" wide), for sealing or unsealing cell covers; Tweezers, for removing fragment of lead from cells; Spatulas of various lengths, for loosening cells in cases; Cutting Pliers; Screw Drivers; Dowel-pin Pointers, for cleaning connectors; File Brushes, for cleaning all sorts of surfaces and so on. Of course, the regular run of tools, such as Braces and Bits, Drills, Hammers, etc., come in handy in battery work very often. The foregoing are merely a few examples of perhaps many uses for ordinary tools in this work.

For large stationary types special Burning Irons, Tongs or Moulds and also Lug Cutters and Punches are supplied by makers of these battery types.

The most useful file for lead cutting is the Vixen. This form has superseded most of the Rasps of former use, as it cuts smoother and does not fill up. S. R. M. Orum, of North Philadelphia, Pa., specializes in storage battery tools.

#### BENCHES.

For storage battery work, where much acid is spilled, a covering of lead, over painted wood, is very lasting. This may be made to slope into the nearby sink, making a cleaner place in the long run. Charging benches must not be lead covered, however, as such a covering would tend to connect electrically all the jar exteriors and cause burns and leakers. To prevent accumulation of acid which would rot battery cases and the benches themselves, these benches are often made of slats or in the form of a wooden grating.

## SINKS.

Sinks and drains should be lead-lined and designed to prevent battery mud (sediment) from going into the sewer pipe, where it would soon settle and clog. The design shown in Figure 8 has this feature. The pool of water held also tends to dilute immediately any acid poured in this sink, preventing damage to sewer pipes, if the water is kept running during repair operations. Figure 8 shows also a method of lining a box with lead, without the necessity of burning any joints.

## LEAD LINED BATTERY WASH SINK.

FIGURE 8.

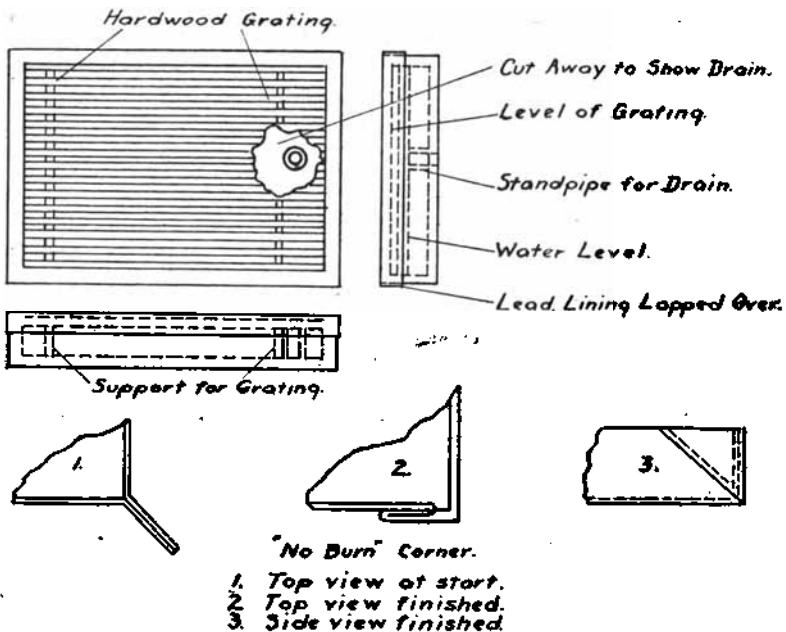

## WOOD SEPARATOR STORAGE.

Where wood separators are stored for many months, because of the necessity of keeping them wet, mildew often forms. A small amount of sulphuric acid in the water will prevent this. A lead-lined box, with dust-proof lid, makes a very nice storage place.

**BATTERY HOLDING OR STORAGE RACKS.**

These are often constructed of painted wood, using four tiers, each tier being made of two 2 by 12" planks. The uprights are usually of 4 by 4" stock and the crosspieces of 2 by 4's all mortised together, as well as nailed, for extra strength. Ten feet of plank will store fifteen six bolt batteries, as many as can be connected to a 115 volt trickle-charging circuit (see Lesson XIII). The use of two narrow strips of wood, glass or porcelain, fastened lengthwise to the upper surfaces of each plank, gives the batteries drainage and prevents damage to their cases from standing in acid. The use of 2x4's, edge up, instead of the planks, is another means to this same end.

**SPECIAL TESTING DEVICES.**

A machine for giving the heavy discharge test, mentioned in foregoing lessons, can be made of an ammeter, voltmeter with prods and a variable resistance. The Allen-Bradley Company of Milwaukee makes such an apparatus, already assembled, using one of their carbon rheostats. Another form of this apparatus tests one cell at a time. Here, a handle, with prods, fastened the proper distance apart, a Voltmeter and a fixed resistance are put together in one piece. By placing the prods on the cell terminals, current flows in the fixed resistance and the voltmeter is deflected. Comparison between cells is the same as in other tests. Such a tester is made by The Service Station Supply Co., Detroit, Mich.

In automobile starting, lighting and ignition service stations, where it is thought desirable to locate troubles of any sort, that is, not only battery troubles, an instrument known as "The Ambu" has been gotten out. It is made and sold by The American Bureau of Engineers of Chicago. With its aid, it is claimed the troubles on any electrically equipped automobile may be located, provided no changes have been made to the car wiring, of course. This eliminates the necessity of knowing details of all the many systems.

**ACID HANDLING APPARATUS AND MIXING.**

Sulphuric acid, for storage battery use, usually comes in boxed carboys or large bottles. Either full strength (1.835 sp. gr.) or approximately half strength (1.400 sp. gr.) may be used for all purposes. The full strength heats when diluted but entails less expense in transit, as there is no freight on contained water. Full strength acid should be handled in glass, earthenware, porcelain or lead-lined

vessels. Hard rubber darkens it. The latter substance may, however, be used for half strength or lower. A carboy inclinor is the best form of apparatus for getting acid from carboys. E. H. Sargent & Co. of Chicago list such an article. Recourse to the syphon is often had for half strength acid or lower. A very convenient piece of apparatus for drawing 1.835 acid from a carboy is made of two pieces of glass tubing and a rubber stopper, perforated with two holes, which fits the carboy neck. One of the two reaches just inside, but the other goes clear to the bottom and is bent in an arc over the stopper to direct the acid into the waiting vessel. Gentle air pressure,

TABLE OF SULPHURIC ACID SOLUTIONS.

Based on one part acid of 1.835 sp. gravity at 60° F.

| Specific Gravity of Solution (70F.) | Parts of water to one part acid |           | Percentage of Sulphuric Acid in Solution |
|-------------------------------------|---------------------------------|-----------|--|
|                                     | By Volume                       | By Weight |  |
| 1.100                               | 9.8                             | 5.4       | 14.65                                    |
| 1.110                               | 8.8                             | 4.84      | 16.                                      |
| 1.120                               | 8.                              | 4.4       | 17.4                                     |
| 1.130                               | 7.28                            | 3.98      | 18.8                                     |
| 1.140                               | 6.68                            | 3.63      | 20.1                                     |
| 1.150                               | 6.15                            | 3.35      | 21.4                                     |
| 1.160                               | 5.7                             | 3.11      | 22.7                                     |
| 1.170                               | 5.3                             | 2.9       | 24.                                      |
| 1.180                               | 4.95                            | 2.7       | 25.2                                     |
| 1.190                               | 4.62                            | 2.52      | 26.5                                     |
| 1.200                               | 4.33                            | 2.36      | 27.7                                     |
| 1.210                               | 4.07                            | 2.22      | 29.                                      |
| 1.220                               | 3.84                            | 2.09      | 30.2                                     |
| 1.230                               | 3.6                             | 1.97      | 31.4                                     |
| 1.240                               | 3.4                             | 1.86      | 32.5                                     |
| 1.250                               | 3.22                            | 1.76      | 33.7                                     |
| 1.260                               | 3.05                            | 1.66      | 35.                                      |
| 1.270                               | 2.9                             | 1.57      | 36.1                                     |
| 1.280                               | 2.75                            | 1.49      | 37.3                                     |
| 1.290                               | 2.6                             | 1.41      | 38.5                                     |
| 1.300                               | 2.47                            | 1.34      | 39.65                                    |
| 1.320                               | 2.24                            | 1.22      | 42.                                      |
| 1.340                               | 2.04                            | 1.11      | 44.1                                     |
| 1.360                               | 1.86                            | 1.01      | 46.3                                     |
| 1.380                               | 1.7                             | .92       | 48.4                                     |
| 1.400                               | 1.56                            | .84       | 50.5                                     |

from a hand pump is applied, through a hose, to the short tube. These are made by The Duriron Castings Co., of Chicago or The Pyrene Co. The table on page 154 is a good guide for making all strengths of electrolyte from 1.835 acid by weight or volume.

#### PACKING FOR SHIPMENT.

The crate, for battery shipment, is of special construction. The peaked top, handles and slatted lids are shown in Figure IX. Before crating and after the final tests (Lesson VIII), batteries should be wrapped, top and sides, with a layer of oiled paper covered by manila paper. The first prevents acid from getting onto the second. Of course, vent plugs should be securely in place. Crates should be large enough to allow two or three inches all around the battery cases or four inches, if handles are to be reached. Four inches of planer shavings or excelsior, firmly pressed into the bottoms, should bring the battery tops even with the bottoms of the peaks. The same packing material is pressed tightly into the space all around the batteries, even with their tops. The space within the peaks is left empty. Notations as, "Liquid in this case, keep this side up"; "Handle Carefully," should be stencilled or otherwise marked on the lid slats.

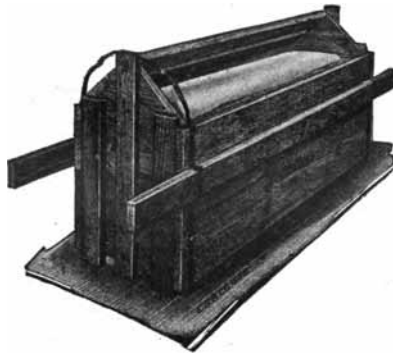

FIGURE IX.

#### PACKING CRATE FOR CHARGED STORAGE BATTERIES.

Expressed shipments of charged batteries require the special express form of white label. Freight shipments are described on the Bills of Lading as "Electric Storage Batteries, Assembled" and should have *no label*. The use of labels, where none are required



is as much a breach of the Interstate Commerce Commission rules as omitting to use labels where required. Heavy penalties are possible under the law.

Sulphuric Acid of lower specific gravity than 1.363 (47%) may be shipped by freight as "Electrolyte" in Carboys with hoods or crated jugs and requires *no label*. Higher specific gravities are billed as Sulphuric Acid and require a white label of the special freight form.

By express, twelve gallons of 25% (1.210 or lower) electrolyte may be shipped in one outside container and bearing a white label (Express form). The limit for higher gravities is one quart, also using the white label. If, however, a metal outside container is used, this limit is raised to eight quarts.

Wood separators, wrapped in oiled paper and boxed, may be shipped by freight or express as "Battery Separator Partitions, Wooden, K. D."

Battery paint, having a low flash point, carries no label and is billed as "Paint (No label required)."

Empty carboys must be hooded and sealed, as though they were filled. They must be shipped by prepaid freight and billed as "Empty Carboys Returned, Boxed."

The following is a list of proper freight billings for other parts:

| PART.   | BILLING.                      |
|---|-------------------------------|
| Plates or Groups.....                                 | Lead Battery Plates.          |
| Rubber Jars .....                                     | Rubber Battery Jars.          |
| Glass Jars .....                                      | Glass Battery Jars.           |
| Covers, Vents, Rubber Separators, etc. ....           | Rubber Goods, N. O. S.        |
| Straps, Connectors, Burning Strips, etc. ....         | Lead Castings, N. O. I. B. N. |
| Meters, Switchboards, Wire Cable, Apparatus, etc..... | Electric Fixtures.            |
| Old Plates and Sediment.....                          | Scrap Lead Plates.            |

## QUESTIONS.

1. If you were first on the ground, at the installation of a new storage battery and before the regular charging apparatus arrived; how would you improvise a means of regulating the D/C charging source?

2. Suppose the source were A/C?

3. In starting up a starting and lighting battery service station, what would be the best combination of apparatus, to charge from one to fifty six-volt sets?

4. For lead burning, why is it necessary to go to the expense of providing oxygen when city gas and an air blast will melt lead or alloy?

5. What might happen, if the meters with which an isolated plant switchboard was equipped were not of a polarized type?

6. Suppose it were considered essential to show the state of charge of the battery on this switchboard. What instrument would be used?

7. Why do many service stations use 1.400 electrolyte, when 1.835 is more economical to transport?

8. Sketch your proposal for the layout of the service station, from what you have learned, mentioned in question 3, indicating thereon the locations and dimensions of the various articles of equipment.

9. Describe, in detail, how you would pack and ship a charged battery by freight, conforming to all the regulations on the subject.

10. How would the various parts of a "knocked-down" isolated plant be described on a Bill of Lading?



|  |                                |  |  |  |  |  |  |
|--|--------------------------------|--|--|--|--|--|--|
| <p>water more than once a week in summer or twice monthly in winter.</p> | <p>evenly within .2 volts.</p> | <p>liquid and replace with water.</p>                      | <p>rate too high for operating conditions.</p>             | <p>or battery too near engine.</p>                         | <p>or battery too near engine.</p>                         | <p>or battery too near engine.</p>                         | <p>cell for leaking jar or short-circuit.</p>              |
|  | <p>Uneven.</p>                 | <p>Cell with lowest voltage probably shorted. Inspect.</p> | <p>Cell with lowest voltage probably shorted. Inspect.</p> | <p>Cell with lowest voltage probably shorted. Inspect.</p> | <p>Cell with lowest voltage probably shorted. Inspect.</p> | <p>Cell with lowest voltage probably shorted. Inspect.</p> | <p>Cell with lowest voltage probably shorted. Inspect.</p> |













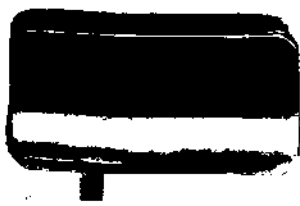
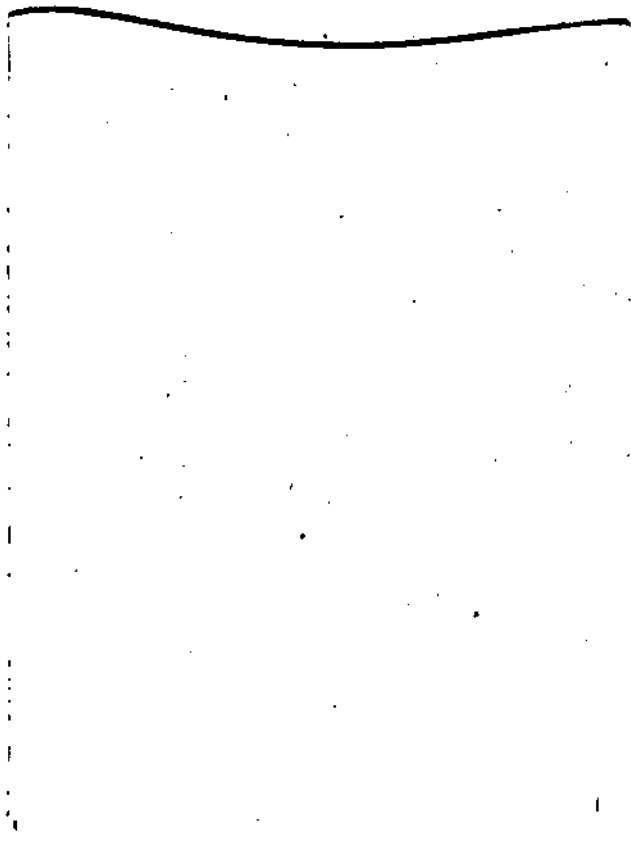

89089716799



b89089716799a