

AT MICROFICHE
REFERENCE
LIBRARY
A project of Volunteers in Asia

A Beekeeping Guide

By: Harlan H.D. Attfield

Published by: Volunteers in Technical Assistance, Inc.
1815 North Lynn Street, Ste. 200
Arlington, VA 22209-2079

Available from: Volunteers in Technical Assistance, Inc.
1815 North Lynn Street, Ste. 200
Arlington, VA 22209-2079

Reproduced with permission.

Reproduction of this microfiche document in any form is subject to the same restrictions as those of the original document.

A BEEKEEPING GUIDE

by HARLAN H.D. ATTFIELD

illustrated by MARINA F. MASPERA

published by

**VOLUNTEERS IN TECHNICAL ASSISTANCE, INC.
1815 North Lynn Street, Suite 200
Arlington, Virginia 22209-2079 USA**

Fourth printing, 1989

ISBN: 0-86619-154-2

TABLE OF CONTENTS

THE BEE COLONY	1
The Queen.	1
The Drone.	2
The Worker	3
Cell	3
RELATIVES OF HONEY BEES.	4
WHAT BEES NEED TO LIVE	5
Beeswax.	5
Nectar	5
Water.	6
Flowers.	7
A Home	7
BEEHIVES	9
Langstroth Hive.	10
Newton Hive.	17
Simple Hives	22
SOME SIMPLE EQUIPMENT NEEDED FOR BEEKEEPING.	24
HOW TO MOVE BEES INTO A NEW HIVE	25
INSPECTING THE COLONY.	31
HELPING A COLONY MAKE MORE HONEY	33
WHAT TO DO BEFORE THE HONEYFLOW.	35
First-year Swarms.	35
Before the Honeyflow	35
Prevent Swarming	35
WHAT TO DO DURING THE HONEYFLOW.	37
HARVESTING THE CROPS (HONEY AND BEESWAX)	38
APPENDIX: SPECIES AND VARIETIES OF BEES.	41
The Rock Bee or Giant Bee.	41
The Little Bee	42
The Indian Bee	42
The European Bee	43
REFERENCES	45
INFORMATION AND MATERIALS.	45

ABOUT VITA

Volunteers in Technical Assistance (VITA) is a private, non-profit, international development organization. VITA makes available to individuals and groups in developing countries a variety of information and technical resources aimed at fostering self sufficiency--needs assessment and program development support; by-mail and on-site consulting services; information systems training; and management of long-term field projects. VITA promotes the application of simple, inexpensive technologies to solve problems and create opportunities in developing countries.

VITA places special emphasis on the areas of agriculture and food processing, renewable energy applications, water supply and sanitation, housing and construction, and small business development. VITA's activities are facilitated by the active involvement of VITA Volunteer technical experts from around the world and by its documentation center containing specialized technical material of interest to people in developing countries. VITA also publishes a quarterly magazine and a variety of technical papers, manuals, and bulletins. For more information, write to VITA, 1815 North Lynn Street, Suite 200, Arlington, Virginia 22209 USA.

ACKNOWLEDGMENTS

This manual presents construction details for several kinds of hives, guidelines for selecting sites and caring for hives, instructions for proper clothing, etc. It is based on the experiences of the Sylhet Package Program of International Voluntary Services, Inc., a community development effort in Bangladesh. Harlan H. D. Attfield, the author, has been a VITA Volunteer for many years and is the author of a number of books and articles published by VITA, including Raising Rabbits.

A BEEKEEPING GUIDE

Keeping bees can be extremely fascinating. It can also be profitable. A beginning beekeeper needs to have some knowledge of the habits of bees, good locations for the beehives, and a small amount of materials.

THE BEE COLONY

Honeybees live in a home of wax comb. These six-sided wax cells are very strong and house the brood (immature bees) during development and provide storage space for honey and pollen. In nature, bees usually live in a sheltered cavity, such as a hollow tree or rock crevice. The colony is composed of a queen, drones, and workers.

The Queen

There is only one queen bee in the colony (family). As mother of the colony, her purpose in life is to lay eggs. She may lay several hundred eggs in one day. These eggs may hatch into drones (males), workers, or new queens. The queen can determine which type of egg she is going to lay. She lays only the type that she feels the colony needs.

It takes sixteen days for the queen to develop from an egg into an adult. About the seventh day after hatching,

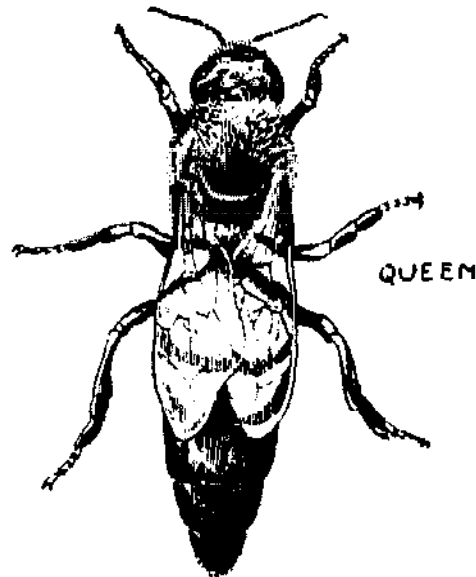

the queen flies from the hive and mates with one or more drones. This is the only time in her life that the queen mates, though she may live four to five years.

The queen is larger than the worker and longer than the drone. Her wings are shorter in proportion to her body length than those of the drone or worker. She has a long, tapering abdomen. When undisturbed, a mated, laying queen will usually be found on or near the comb containing the eggs in the hive.

The Drone

The number of drone bees in a colony varies seasonally. There may be none when the bees have little food, but up to 1,000 during the honey-collecting season. When the honey season is over and food and water become scarce, the drones are driven out of the hive to die.

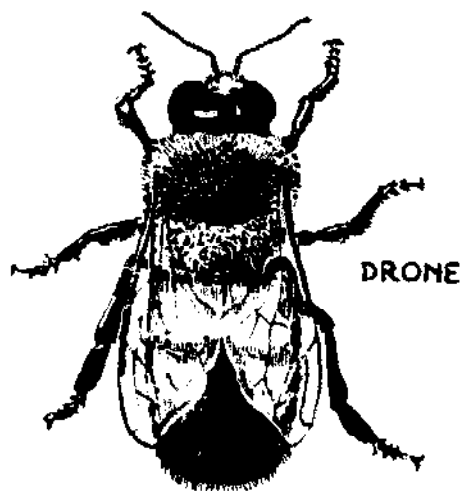

It takes 24 days for a drone to develop from an egg into an adult. The drone does no work in the hive. His only function in life is to mate with the virgin queen outside the hive. He dies after mating with her. The drones are the only male bees in the hive.

Drones are larger and fatter than the queen or the workers. Their bodies are not as long as the queen's. The drone has a short tongue he uses to take food from workers and from stored honey in the hive. He does not have legs fit to carry pollen, and he is unable to produce wax. He has no stinger to defend himself. Children enjoy handling drones!

The Worker

There are 5,000 to 75,000 worker bees in a colony. They do all the house and field work. Some workers go out of the hive to bring in water, pollen, nectar, and propolis (bee glue). Other workers remain in the hive to guard against enemies. Still others clean the hive, build wax comb, nurse the young, and control the temperature of the hive. Workers eat honey to produce heat in cold weather and fan their wings to keep the hive cool in hot weather.

It takes 21 days for a worker to grow from an egg into an adult. During the honey-collecting period, workers live about six weeks. Workers have special legs equipped with pollen baskets. They also have glands that produce wax and the scent necessary for carrying out their many duties. Workers are smaller than either the drones or the queen. They have a stinger, which, unlike the queen's, is barbed on the end. When a worker stings something, the stinger remains behind and the bee dies.

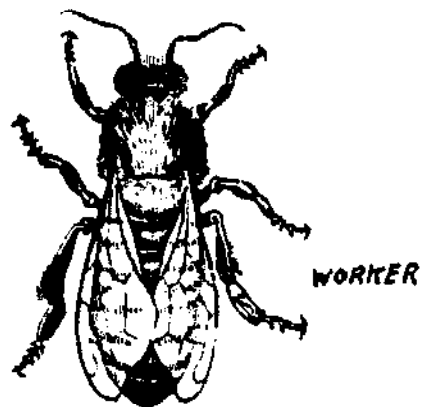

Cells

The cells of the queen, drone, and worker all differ, as shown.

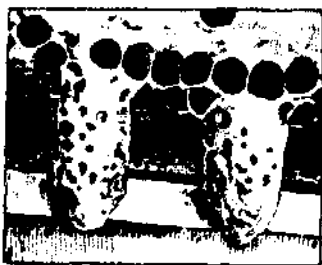

QUEEN CELLS

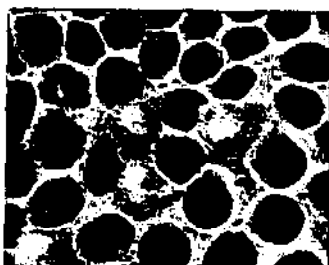

DRONE CELL

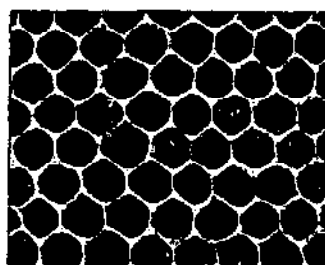

WORKER CELLS

RELATIVES OF HONEYBEES

Wasps are not bees but are sometimes mistaken for bees by people. (A black wasp and brown wasp are shown below.) Their homes are made of mud or paperlike materials. Many wasps are parasitic, laying their eggs in or on the bodies of other insects or spiders. Wasps are not good for honey production.



BROWN
WASP



BLACK
WASP

Several kinds of bumblebees are found around the world. Although color varies a great deal, some common bumblebees are blue-black or black and yellow. They make their homes at or near ground level, often in empty mouse nests. Like wasps, they are not good for honey production.

Dammar bees are the smallest of the honey yielders and are known by many people as stingless bees (*Melipona* spp. and *Trigona* spp.). However, it is not completely correct to call them this because they do have stingers although imperfect for use. These bees do not sting but bite instead. They resemble a honeybee somewhat, but are much smaller. They build their homes in the hollows of trees, rocks, walls, keyholes, and roof cracks. Although these bees store honey, the yield is too little to warrant keeping them.

WHAT BEES NEED TO LIVE

In order to live and produce honey, bees need the following:

- . Beeswax
- . Nectar
- . Water
- . Flowers
- . Tree and flower buds
- . A home

Beeswax

Bees need beeswax in order to make wax comb. They store honey and pollen and raise their young in the wax comb. Workers produce beeswax in wax glands located on the underside of their bodies. As it is made, beeswax changes from a liquid into tiny wax scales. Workers then use these wax scales to build wax comb.

Workers must eat large amounts of honey or nectar to produce wax. They keep the hive temperature between 92° and 97°F (33° and 36°C) while making wax.

Many beekeepers help their bees to start making wax by putting sheets of beeswax foundation in the wooden or bamboo frames of the hive (see Figure 1 on page 11). The foundation wax fits into hive frames and forms the base of the honeycombs. It helps speed up comb construction and gives the bees a pattern to follow for building straight and easy-to-remove honeycombs. Honeycomb foundations can be ordered from bee supply companies (see notation in back of this Bulletin).

Nectar

In order to make honey, bees must have nectar. Nectar is a liquid, sugary substance produced by flowers and is the raw material of honey. Honey is the bees' main source of food.

Nectar is generally one-half to three-fourths water. After the workers carry nectar to the hive, they evaporate most of the water to thicken it. They then seal the full honeycomb cells with a thin layer of wax.

Many flowering plants make nectar, but only a few grow abundantly or produce enough nectar to be considered good sources. The best sources of nectar vary from place to place. As a beekeeper, you will want to know the plants in your area that are best for honey production.

The days when a good number of plants have nectar to be foraged by honeybees is called a honeyflow period. If the nectar yield is abundant from a good number of the plants of a single kind, it is called a major honeyflower period. When the amount of nectar plants is available in large numbers, providing one or two major honeyflow periods and minor honeyflow periods during other parts of the year, then beekeeping can be successful. In the best beekeeping areas, the unproductive period is not long in duration.

The color and flavor of honey depend on the kinds of plants from which bees collect nectar. Honey may be clear, golden, or even brown. Its flavor can range from mild to strong.

Many of us have planted various types of fruit plants near our homes. Mustard grown for oil-seed provides an abundant source of nectar and pollen, often for two or three months. The honey is light yellow and granulates, becoming firm like sugar very quickly.

Water

Bees must have water in order to live. Bees add water to honey before eating it. During hot weather, they may stop collecting food and start collecting water to cool the hive. Some water is obtained from nectar, but a colony that cannot collect water from other sources will die within a few days. Beekeepers often maintain an open supply of water during dry periods.

Flowers

Bees need flowers from which to collect pollen. Pollen is the powdery material found in most flowers, which fertilizes other flower parts to produce seeds. Many wild flowers, weeds, trees, and agricultural crops produce pollen that bees can use.

Workers place pollen in pollen baskets on their hind legs and carry it back to the hive. The pollen is stored as "bee bread" in the cells of the honeycomb. Later it is fed to young bees. Pollen is needed before and during the honey-producing season so that young bees will have enough food.

As the bees move from flower to flower, the tiny grains of pollen stick to their bodies. This is how bees provide their important service of pollination, or uniting the male and female parts of the flower so that seed is produced. Farmers are greatly appreciative of this service, which increases their productivity.

Tree and Flower Buds

In order to make propolis, bees need tree and flower buds. Propolis is a sticky, gummy material that bees collect from tree and flower buds. Bees use propolis to seal cracks and to waterproof the hive.

A Home

To keep bees, you will need to provide them with a home or "hive." Bees need a place to raise their young, to build their wax comb, and to store their pollen and nectar. They also need a hive for protection from wind, rain, heat, cold, pests, etc.

Some things that should be considered when building a hive are:

- . The hive should be built so that it will be easy to remove the surplus honey.

- . After the surplus is collected, it should be easy for the bees to start storing honey again in the hive.
- . The hive should be well made so that it will house the bees for many honey-producing seasons.
- . There should be enough space in the hive for bees to build new combs for brood rearing and food storage.
- . The entrance hole of the hive should be just big enough to let the bees come in and go out. If the hole is too big, however, it will be difficult for the bees to defend their stored honey from pests.
- . The hive should protect the bees from cold or hot weather. In a warm country, the hive should be placed in partial shade.
- . There must always be a supply of water nearby, as well as a good source of nectar and pollen within 2-3 miles.
- . A hive should be placed where the bees are unlikely to sting anyone.

BEEHIVES

Many types of beehives are used by beekeepers all over the world. The hive used will depend on materials available in the area. Some materials that beehives can be made of are:

- . Wood.
- . Straw woven into rope that is twisted around in a circle or square to make the beehive.
- . Large rectangular cans such as empty kerosene tins.
- . Tree trunks, which are cut into sections and hollowed out.
- . Clay or mud jars.
- . Bamboo or woven reeds coated with clay or mud.

Wooden hives are used by many beekeepers throughout the world. If you want to build your own wooden-frame hive, you can use the plans and dimensions in this Bulletin. Make all parts exactly the same and keep all dimensions the same, so that the parts will fit together well and can be easily interchanged with the parts of other hives.

Of special importance is the space left between the frames, floor (bottom board), wells, and cover inside the hive. For most beehives, this "bee space" is 0.96cm (1/4") (see Figure 9, page 18, "side view"). If the space is less, the bees will not be able to pass through, and they will seal it up with propolis. If the space is wider than 0.96cm (1/4"), the bees will build honeycombs in it. Neither of these conditions is good for the beekeeper.

There are many types of wooden-frame beehives throughout the world. The two most popular ones for use with bees of the size of the Indian bee are the Langstroth and Newton types shown in

this Bulletin. Although these hives differ in size, both have basically the same parts.

Langstroth Hive

Figure 1 shows the Langstroth hive and its parts as follows:

1. Bottom board. This is the floor of the beehive and can be made by using a piece of wood 55.88cm long X 41.28cm wide X 1.91cm thick (22" X 16-1/4" X 3/4"), or by joining two wooden boards together and nailing them in position.

Along the bottom edge of both sides is nailed a wooden strip 55.88cm X 1.91cm X 1.27cm (22" X 3/4" X 1/2"); and another wooden strip 37.46cm X 1.91cm X 1.27cm (14-3/4" X 3/4" X 1/2") is nailed along the back edge.

The front is provided with another strip of wood that is 37.47cm X 1.91cm X 1.27cm (14-3/4" X 3/4" X 1/2") and has an entrance 7.62cm long X 0.97cm in height (3" X 3/8"). If necessary, the entrance opening can be made larger.

2. Brood chamber. This provides space for eggs and brood although sometimes the queen will lay eggs in a few combs in the honey super. The brood chamber is a rectangular box without a top or bottom and is made of 1.91cm (3/4") thick wood.

Its length on the outside is 50.80cm (20") and on the inside 46.99cm (18-1/2"); its width on the outside is 41.28cm (16-3/4") and on the inside 37.47cm (14-3/4"); and its height is 24.46cm (9-5/8"). A rabbet (shelf) 1.27cm (1/2") deep and 0.97cm (3/8") wide is cut along the entire inside top edge of both width boards. The "side view" of Figure 9 (see page 18) shows how the wooden frames rest on this shelf.

3. Honey super. This is the storage area for surplus honey. Wooden frames support the wax comb. More honey supers are added to the hive if the bees need more space.

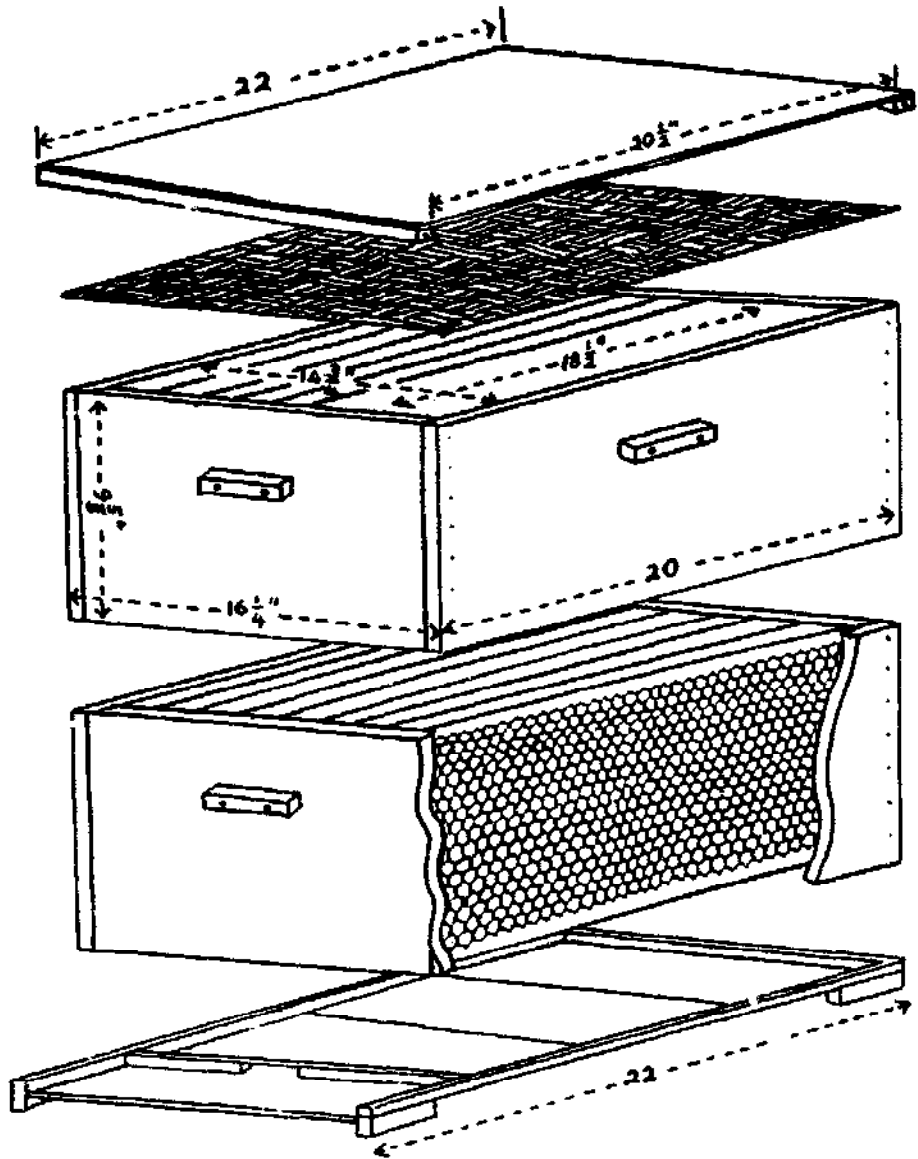

Figure 1. Langstroth beehive

The dimensions of the super and the super frames should be the exact size of the brood chamber and brood chamber frames.

4. Wooden frames [for brood chamber and honey super]. Nine frames are usually used in each brood chamber and honey super, although each is capable of holding ten frames each. This extra space makes it easy to move the frames around when inspecting the hive or to take the frames out when extracting honey. Once the nine frames are filled, most beekeepers usually add the 10th. By this time, there is less need for routine examinations of the frames.

Figure 2 shows the staple-spaced frame. Frames should be made from good, clean lumber. The frames must be carefully made so they will fit easily into the hive.

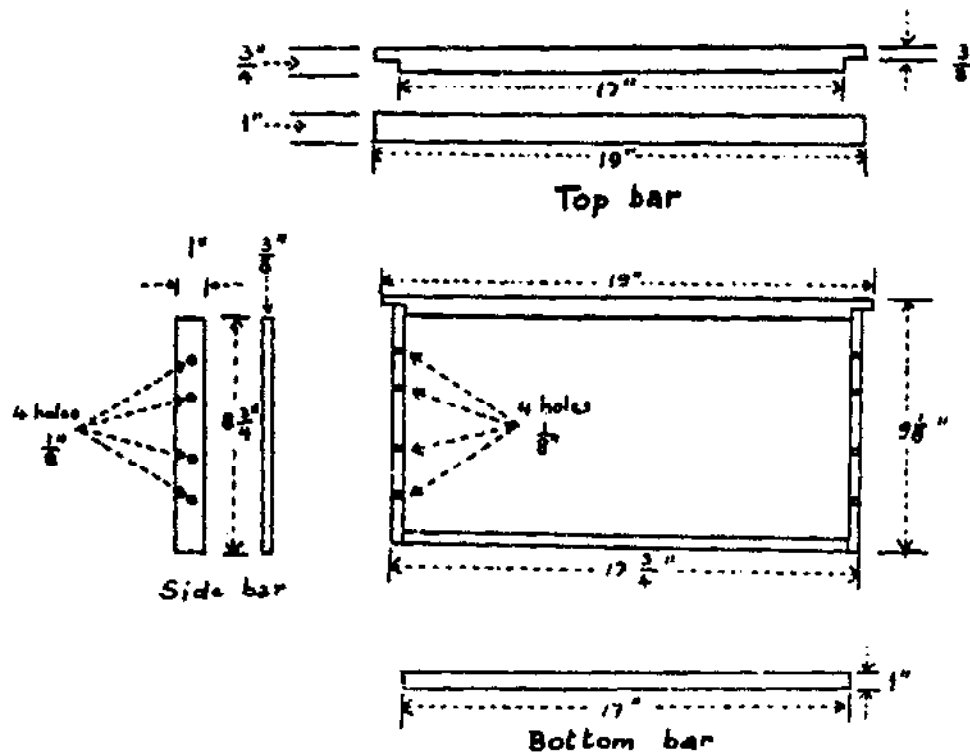

Figure 2. Langstroth frame

The frames can be wired so they will support wax comb or sheets of wax foundation. This can be done by drilling three or four holes in each side bar and then stringing tinned wire (28 gauge) tightly through the holes (see Figure 3).

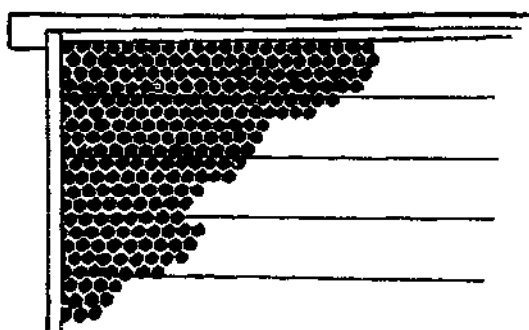

Figure 3. Sheet of foundation wax

Good wiring prevents the foundation and combs from sagging and allows the beekeeper to handle the combs at any time. If beeswax foundation sheets are available, they should be used. Combs built on foundation sheets are very sturdy. Brood combs and honey super combs can be used for several years and are very important to the modern beekeeper. Wax foundation sheets are attached to wired frames by dripping a thin layer of melted beeswax along each wire and pressing to the foundation sheet. Wax foundation sheets can be attached to wires with a small tool called the "spur embedder" (see Figure 4).

The spur embedder is heated in hot water and then rolled along each wire, which is pressed to the foundation sheet. The hot, metal "wheel" of the spur embedder melts the wax foundation all along the length of each wire. The melted wax foundation quickly cools leaving the sheet nicely secured in the frame. To make the job of wire-embedding easier, many beekeepers start by fastening an edge of the foundation sheet with melted (heated) beeswax in the groove on the lower side of the top bar.

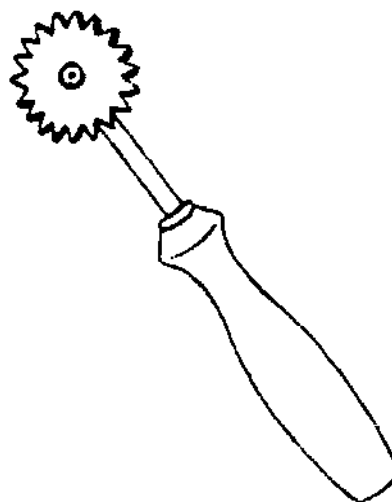

Figure 4. Spur wire-embedder

Figure 2 shows this groove. If the frame is used again, the groove may be cleaned with a nail or piece of hard wire. New foundations are now available that have built-in reinforcement and requires no wire. If wax foundation is not available, pieces of old comb from a wild hive can be tied to the frames to help the bees start storing honey and rearing brood (see Figure 5).

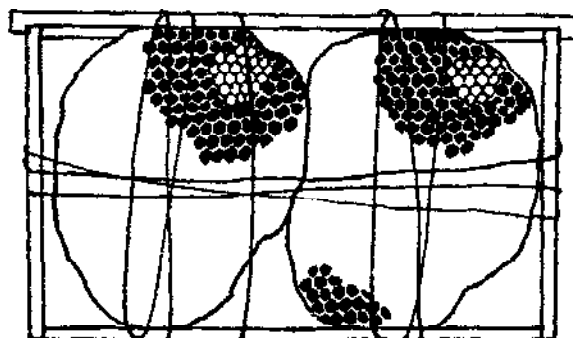

Figure 5. Tying old comb to a frame

Dimensions for the staple-spaced frame are:

- Top bar: 48.26cm long X 2.54cm wide X 1.91cm thick (19" X 1" X 3/4"). It is cut to 0.97cm (3/8") thickness on both

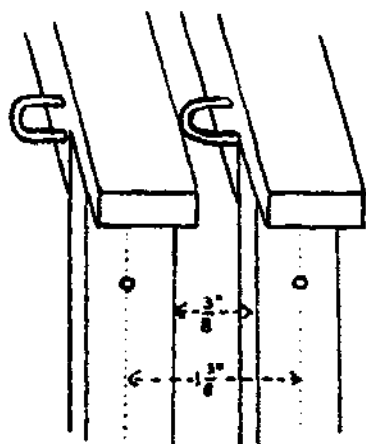

Figure 6. Staple-spaced frame

ends for a length of 2.54cm (1"). It has a groove in the middle of its lower side for affixing the comb foundation sheet. Two 1.60cm (5/8") staples or "U-nails" should be driven in the top bar on its opposite sides, at opposite ends, leaving only 0.97cm (3/8") of each U-nail or staple on the outside. This will allow for a 0.97cm (3/8") spacing between frames (see Figure 6).

- . Side bar: Each is made of 0.97cm (3/8") thick wood and is 22.23cm (8-3/4") long and 2.54cm (1") wide. There are four holes in each side bar for wiring the frames (see Figure 2, page 12). These holes should be drilled before assembling the frame.

 - . Bottom bar: 43.18cm long X 2.54cm wide X 0.97cm thick (17" X 1" X 3/8").
5. Inner cover. This helps insulate the bees from heat and cold. It also keeps bees from building comb and propolis under the outside cover. The inner cover is made from wood, fiber mat, or jute sackcloth cut to the same length and width as the honey super.
6. Outside cover. This protects the frames and supers underneath. A flat-top cover can be made of 0.97cm (3/8") thick boards nailed to a rectangular frame 5.08cm (2") high, all covered with galvanized sheet metal, tar paper, or other waterproof material. A simple, flat-top cover is shown in Figure 1, page 11. The boards are nailed to two strips of wood made to overlap the front and back top edge of the honey super. Any cracks are filled neatly with coal tar spread from the outside surface of the cover. Clay, putty, or other crack sealants can also be used.

A sloping-top cover is shown on the Newton beehive (see Figure 9, page 18). This type of cover can be used with either the Langstroth or Newton hives. Many beekeepers prefer a sloping cover, which sheds rainwater quickly. It is usually made to fit loosely over the hive and is provided with a 2.54cm (1") diameter screened ventilation hole on the front and back.

7. Handles. For ease in handling, one handle should be placed in the center of each side of the brood chamber and honey super--a total of four handles on each chamber or super.

Most beekeepers prefer to place their beehives off the ground on a wooden, rock, or brick stand so the bees can better

protect their home from ants and other insect pests. Figure 7 shows a pole stand. The pole is made with a log about 10.16cm (4") in diameter and well soaked in wood preservative (solignum) or a mixture of equal parts old crankcase oil from the petrol station and kerosene or paint thinner. It is then buried in the ground leaving 30.48cm (12") above the ground. A board (also soaked in wood preservative) 40.64 X 30.48cm (16" X 12") is nailed or screwed in place on the top of the log. The hive is placed on this platform and sometimes tied down with ropes to prevent disturbances.

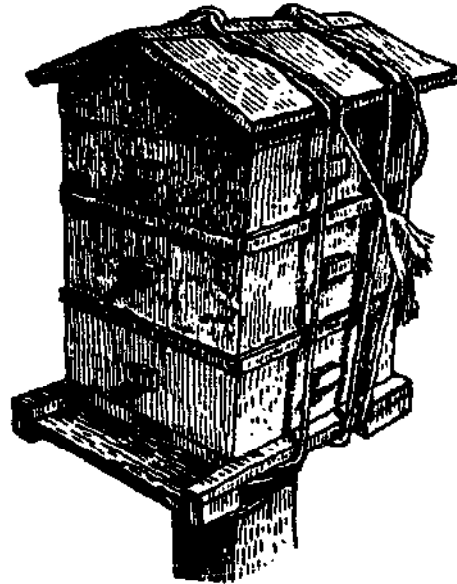

Figure 7. Pole stand

Figure 8 shows a beehive raised 22.86cm (9") off the ground by using simple leg stand. Stands should be made strong and hold the hive in a level position.

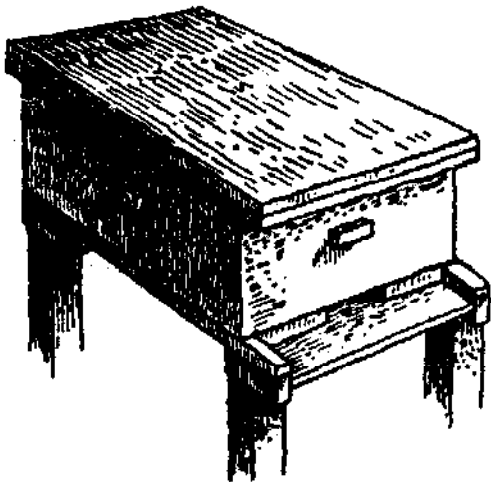

Figure 8. Leg stand

Try to make your beehives from light, well-seasoned, good quality wood. The wood should not have too strong a smell. The outside wood of the hive should be painted with a light-colored exterior paint to protect the wood from weathering too quickly. A mixture of equal parts of old crankcase oil and kerosene can be used as "paint" for the outside of the beehive. If possible, glue all hive parts together with a waterproof glue before nailing securely.

Newton Hive

The Newton hive is smaller than the Langstroth type and allows the bees to control the temperature in the hive with less effort. Small colonies in large hives may have their brood chilled during cold winter nights and early mornings. The bees will leave the outer frames and upper frames to cluster in a tight mass in the center of the brood chamber.

It should be remembered when selecting a beehive design that a hive is merely the tool of the beekeeper. A proper system of management can make one kind equally as successful as another.

Figure 9 shows the dimensions for the parts to the Newton hive, as follows:

1. Bottom board. This is made of wooden planks the same width as and 10.16cm (4") longer than the brood chamber. Wooden strips 1.27cm X 2.24cm (1/2" X 7/8") are nailed along the back edge and two side edges. The front is provided with another strip of wood and has an entrance 8.89cm X 0.97cm (3-1/2" X 3/8"). Although seldom necessary, the entrance opening can be made larger by removing the wooden strip.
2. Brood chamber. This is a box without top and bottom and made of 2.24cm (7/8") thick wood with outer dimensions 28.27cm X 27.31cm X 16.21cm (11-1/8" X 10-3/4" X 6-3/8") and inner dimensions 23.83cm X 22.86cm X 16.21cm (9-3/8" X 9" X 6-3/8"). A groove shelf 1.27cm deep X 0.97cm wide (1/2" X 3/8") is cut along the entire inside top edge of both width boards. The "side view" shows how the frames rest on this shelf.

The brood chamber provides space for eggs and brood, although sometimes the queen will lay eggs in a few combs in the honey super. The brood chamber and honey super are exactly the same size.

3. Honey super. This is the storage area for surplus honey. Wooden frames support the wax comb. More honey supers are

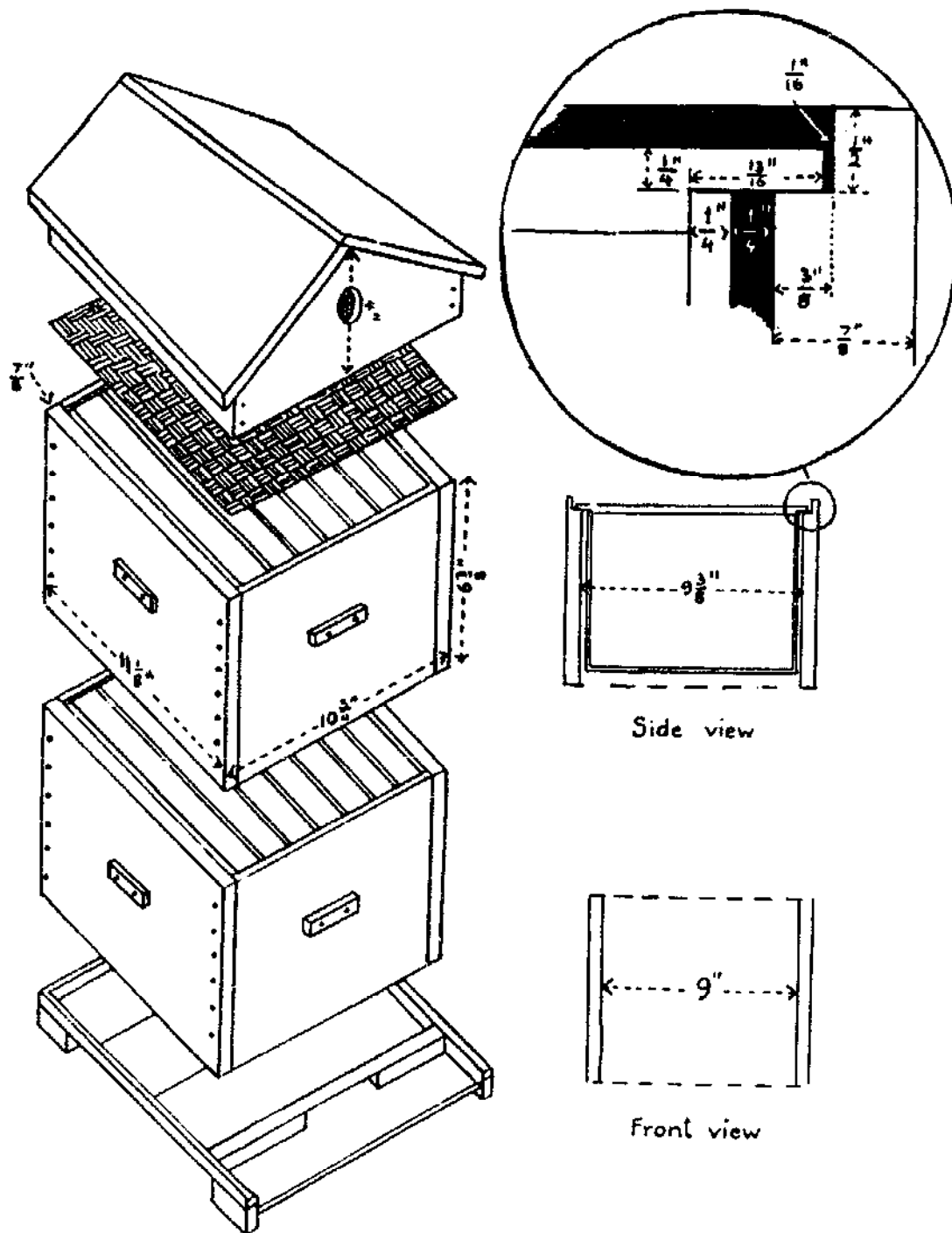

Figure 9. Newton hive

added to the hive if the bees need more space. The dimensions of the super and the super frame should be the same as those for the brood chamber and brood chamber frames.

4. Wooden frames [for brood chamber and honey super]. Seven frames are usually used in each brood chamber and honey super. The brood chamber can be used with six frames and one "division board" (see Figure 10). The division board is a

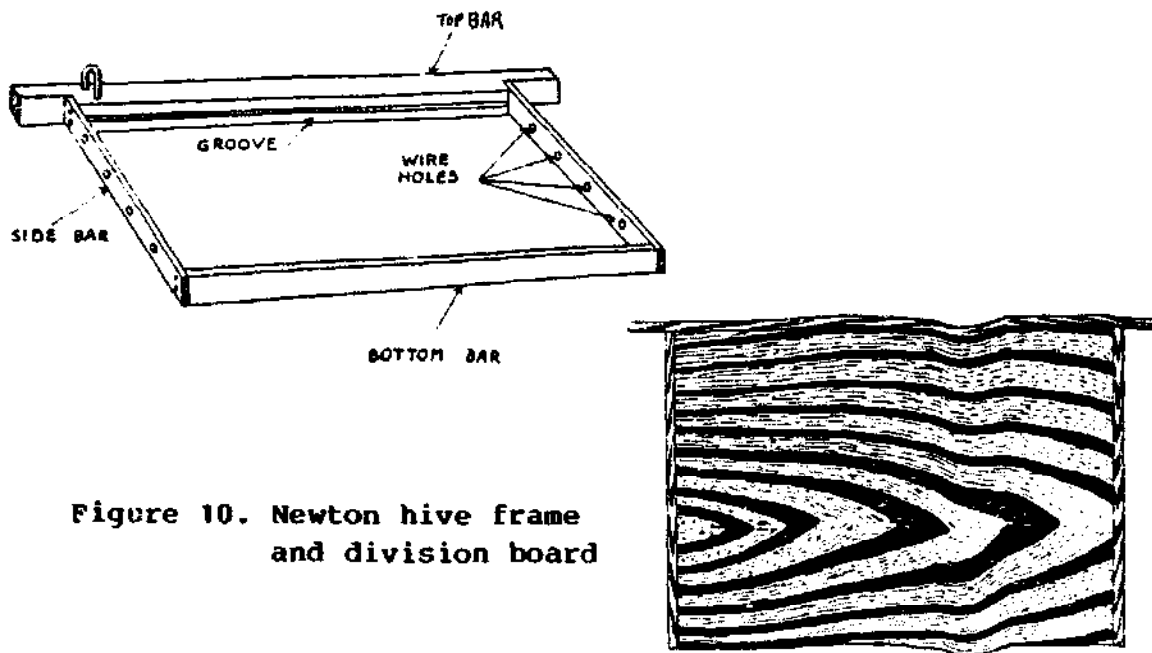

Figure 10. Newton hive frame and division board

wooden partition that serves as a movable wall and is used to reduce the space inside the brood chamber so that bees can keep the brood warm and well protected from pests and periods of cold. The frames can be wired by following the steps given for the Langstroth frame on page 12.

The dimensions for the Newton staple-spaced frame and division board are as follows:

- . Top bar: 25.4cm long X 2.24cm wide X 1.27cm thick (10" X 7/8" X 1/2"). It is cut to 0.64cm (1/4") thickness on both sides for a length of 2.06cm (13/16"). It has a groove in the middle of its lower side for affixing the comb

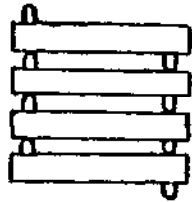

Figure 11. Staple placement

foundation sheet. Two 1.60cm (5/8") staples or "U-nails" should be driven in the top bar on its opposite sides, at opposite ends (see Figure 11), so that the frames stand 0.97cm (3/8") apart.

- Side bar: Each is 13.97cm long X 2.24cm wide X 0.64cm thick (5-1/2" X 7/8" X 1/4"). There are two or three holes in each side bar for wiring the frames (see Figure 12). These holes should be drilled before assembling the frame.

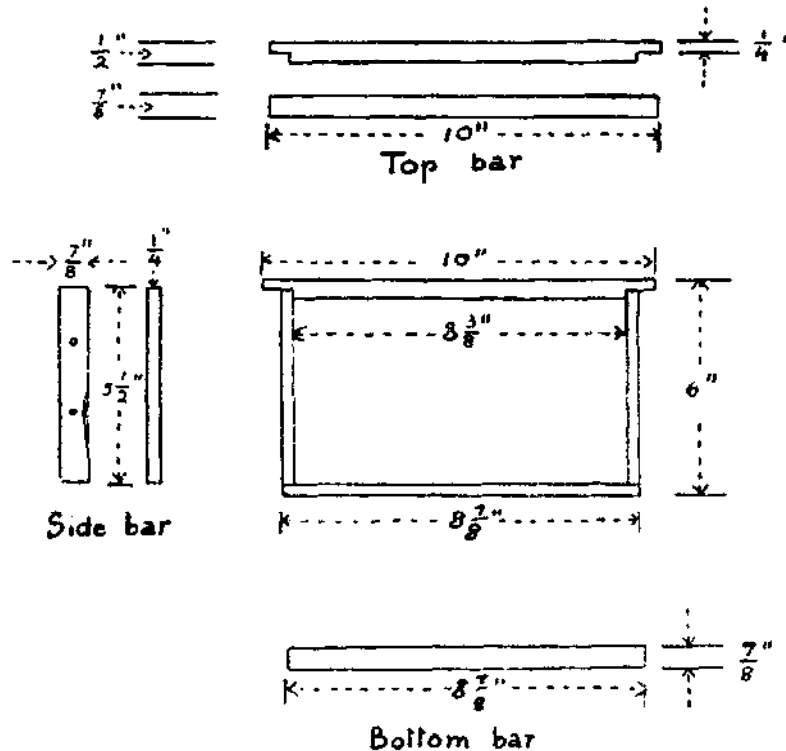

Figure 12. Newton frame

. Bottom bar: 22.56cm long X 2.24cm wide X 0.64cm thick
(8-7/8" X 7/8" X 1/4").

5. Inner cover. This helps insulate the bees from heat and cold. It also keeps bees from building comb and propolis under the outside cover. The inner cover is made from wood, fiber mat, or jute sackcloth--cut to the same length and width as the honey super.
6. Outside cover. This protects the frames and supers underneath. Many beekeepers prefer a sloping cover, as shown in Figure 9, page 18, because it sheds rainwater quickly. It usually is made to fit loosely over the hive and is provided with a 1" screened ventilation hole on the front and back.

In the simple, flat top cover shown in Figure 1, page 11, boards, 0.97cm (3/8") thick, are nailed to two strips of wood made to overlap the front and back top-edge of the honey super. The full outside length of the cover is 33.35cm (13-1/8") and 28.27cm (11-3/8") between the inside edges of the two wood strips. Any cracks in the cover should be filled neatly from the outside with coal tar, putty, clay, or other type of wood sealer.

7. Handles. For ease in handling, one handle should be placed in the center of each side of the brood chamber or honey super--a total of four handles on each chamber or super.

Beehives should be placed on stands off the ground like the ones described for the Langstroth hive on page 16. Stands should be made strong and should hold the hive in a level (or slightly slanted forward) position.

It is suggested that the hives be made from light, well seasoned, good quality wood. The outside of the hive should be painted with a light-colored, exterior paint to prevent the wood from weathering too quickly. A mixture of equal parts of old crankcase oil and kerosene can be applied as "paint" for the outside of the hive. If possible, all hive parts should be assembled with a waterproof glue before being nailed securely.

Simple Hives

Simple, or single body, beehives are combinations of brood chamber and honey super. The queen will tend to lay her eggs in a concentrated circle, leaving the bordering areas for honey storage. These hives are only practical in regions where there is no nectarless seasons. Areas with nectarless seasons require beehives where honey can be stored to support the bees.

There are many kinds of simple hives the beekeeper can make, depending upon available material. Several types are shown below.

Figure 13 shows a kerosene tin hive fitted with staple-spaced frames or transitional frames (see Figure 14). The transitional frame is similar to the staple-spaced frame but uses half side bars, saving the cost of bottom bars and half of the side bars. Thus, the cost of the frame is reduced by nearly half and the use of wires is not necessary. Bees will build straight comb as far down as they can, but great care must be taken not to break the comb through improper handling.

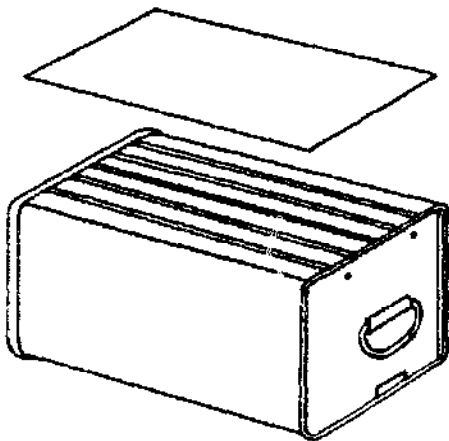

Figure 13. Kerosene tin hive

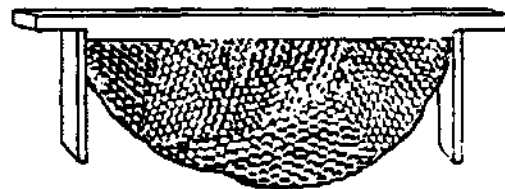

Figure 14. Transitional frame

The tree trunk hive can be used when a colony of bees are found living in the trunk of a dead tree. If the tree is not too large, the section holding the colony can be cut out and secured to a stand. Supers can be added to the top as the bees need more space for honey storage (see Figure 15).

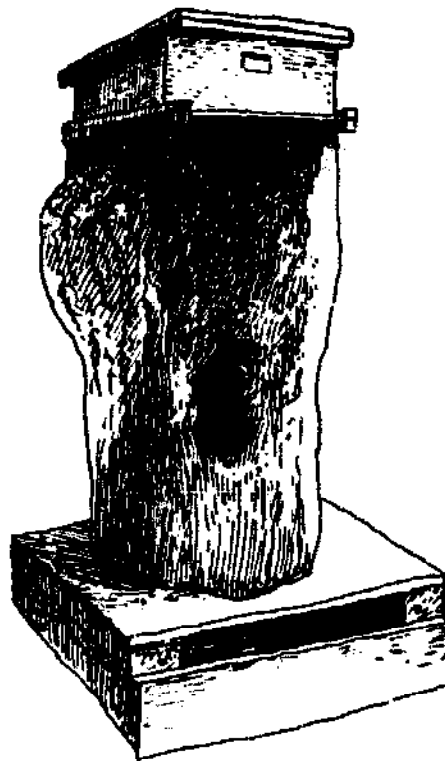

Figure 15. Tree trunk hive

The transwoven hive is made of bamboo or woven reeds and is often coated with clay or mud. This hive (see Figure 16) can be used with full staple-spaced frames or transitional frames with Newton hive dimensions (see page 20). These hives are simple to make, but last only for a few honey seasons because the material weakens with age.

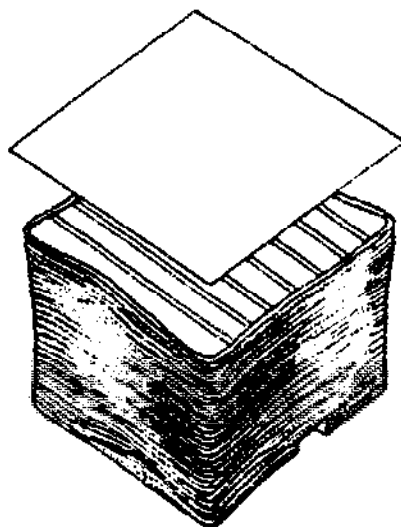

Figure 16. Transwoven hive

SOME SIMPLE EQUIPMENT NEEDED FOR BEEKEEPING

A beginning beekeeper will need some simple equipment to help his work with the bees and to protect him from bee stings. The equipment needed can be seen in Figure 17.

1. Hat with netting. This is used to protect the neck and face from bee stings. A veil can be made from any wide-brimmed hat and a piece of mosquito netting or wire screening, 45.72cm (18") wide and as long as the circumference of the hat brim. After this has been sewn into a cylinder, it is sewn to the hat. At the back center of the netting are sewn two "tapes" each 137.16cm (54") long. At the front are sewn curtain rings about 20.32cm (8") apart.

When the veil is put on, the tapes are passed under the arms and through the rings. Pulling the tapes tight pulls the edge of the netting tight against the shoulders. The remaining tape is passed back under the arms to stretch the front flat and is then brought, again, to the front to be tied.

2. Gloves. These are used to protect the hands from bee stings. Gloves used in beekeeping are usually the "work-type." They are often made of soft leather or canvas-type cloth. Sleeves are sewn to the glove tops to protect the beekeeper's arms from stings. The sleeves can be tightened to the arms by the use of string or elastic bands. Experience shows gloves are unnecessary and even detrimental.
3. Smoker. This is used to distract the bees. When worker bees smell smoke, they fill themselves with honey. It is difficult for a bee with a full stomach to sting because it cannot double up. Light puffs of smoke at the entrance and on top of the opened hive are usually enough.

Some beekeepers use a straw torch and blow smoke into the hive. This is not good because burnt grass is also blown



Figure 17. Proper equipment for beekeeping

into the combs making the honey dirty. The hot embers could singe the bees making them more apt to sting.

In most countries a smoker is used in which the burning material is contained inside. Figure 18 shows a smoker with a bellows attached, while Figure 19 shows a more simple smoker made from a round tin and a couple of pieces of metal tubing. The beekeeper must use the tube to blow smoke from the tin. The longer end should be wrapped with a layer of cloth so it does not get too hot.

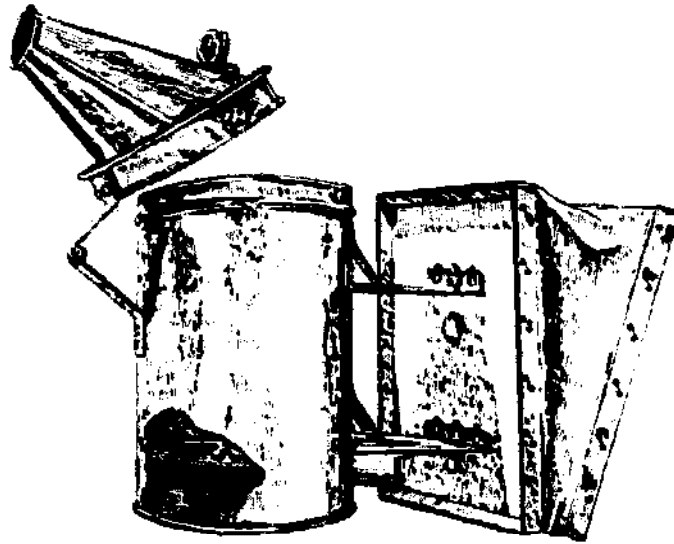

Figure 18. Bellow smoker

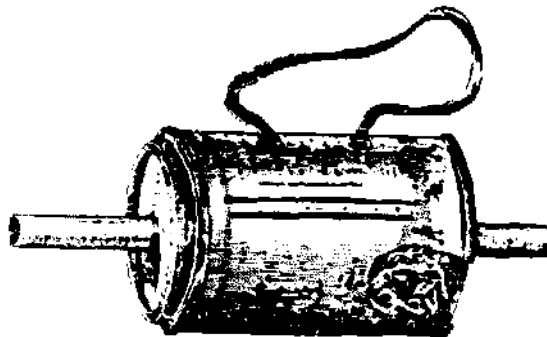

Figure 19. Can smoker

The best material to burn in the smoker is old, dry sacking or rotten wood, since these burn slowly and give off a cool smoke. Rags, cotton waste, wood shavings, cowdung, dried corn cobs, and dry leaves also make good fuel for the smoker.

The material should be lighted nearest the longer mouthpiece tube so that the smoke is filtered through the unburned fuel.

4. Hive tool. This helps to pry apart the hive boxes and frames. It can be purchased from a bee equipment company or made by the beekeeper from an old truck "leaf-spring" cut to 20.32cm or 25.40cm (8" or 10"). The sharp edge is used for scraping wax and propolis from inside the hive.

HOW TO MOVE BEES INTO A NEW HIVE

Once a source of bees has been found, they will have to be moved into the hive. Bees are best moved when they are swarming. Swarming is a process of producing a new colony. Bees usually start swarming when a colony has become overcrowded just before the honey season. Bees may also swarm or leave the hive when food sources or water become scarce, when there are small food reserves in the hive, or when the hive is destroyed.

Before the bees swarm, the queen lays a single fertile egg in each of the prepared queen cells. She then leaves the hive, with about half the bees, in search of a new home. The remaining bees in the hive wait for a new queen to mature. The new queen mates with the drones and the colony life goes on.

Swarms may be found hanging on tree limbs or under overhangs of buildings. Once a swarm is located, it should be caught immediately and transferred to a hive. Figure 20 shows a swarm of bees that have landed on a tree limb. With a hard shake, the bees are knocked into the beekeeper's basket and then shaken into the brood chamber of an empty hive.

Bees in a swarm seldom sting, but a face net and smoker will make the transfer safer.

A source of bees may be transferred from a tree, house, or old hive to a new hive. The best time to transfer these bees is during the honey season.

One way to transfer bees to a new hive from a tree or building is to first get the smoker ready and be sure to wear proper clothing. Then use the smoker continuously and make noise by hitting the tree or building with a board or hammer. Soon a swarm should come out of the old hive. They will collect on a nearby tree limb or other object. The old comb may be cut out and sections of it tied into a frame with string. The swarm is



Figure 20. Collecting a swarm

then shaken into the new hive and left undisturbed for a few days. It will not take long for the bees to fill the rest of the frame with wax comb and begin storing food and raising young.

INSPECTING THE COLONY

The best time for inspecting the colony is a bright, sunny day when the bees are working normally. Bees should not be disturbed on cold, rainy, or windy days or at night.

After lighting the smoker, the hive should be approached from the side to avoid blocking the bees' entrance. A few puffs of smoke should be given at the entrance. The inner cover should be lifted a little with the hive tool, and smoke blown into the hive, and the inner cover replaced. After a few moments, the inner cover should be removed and placed upside down against the hive. The frames should be pried apart with the hive tool, taken out, and examined one by one. They should be handled carefully over the open hive and turned as shown in Figure 21.

During this work, the queen should always be kept in mind. The frame on which she is located should be placed back in the hive early. The frames should be handled gently and crushing the bees should be avoided.

If you should be stung by a bee, the sharp edge of a hive tool or fingernail should be used to take out the stinger as quickly as possible. Never squeeze it out with your finger tips. Rubbing only causes more irritation. Some persons are allergic to bee stings. If stung by even a single bee, they develop a rash over their body and have difficulty breathing. They shouldn't go near hives. For most people, however, pain is felt for only a few minutes, with any swelling lasting for just a short time.

After inspection of the colony is finished, all the hive parts should be carefully returned to their proper places. Opening the hive too often will upset the life of the colony and could cause them to abandon their home in search of a quieter place to live.

When inspecting a hive, look carefully for pests and remove them from the hive.

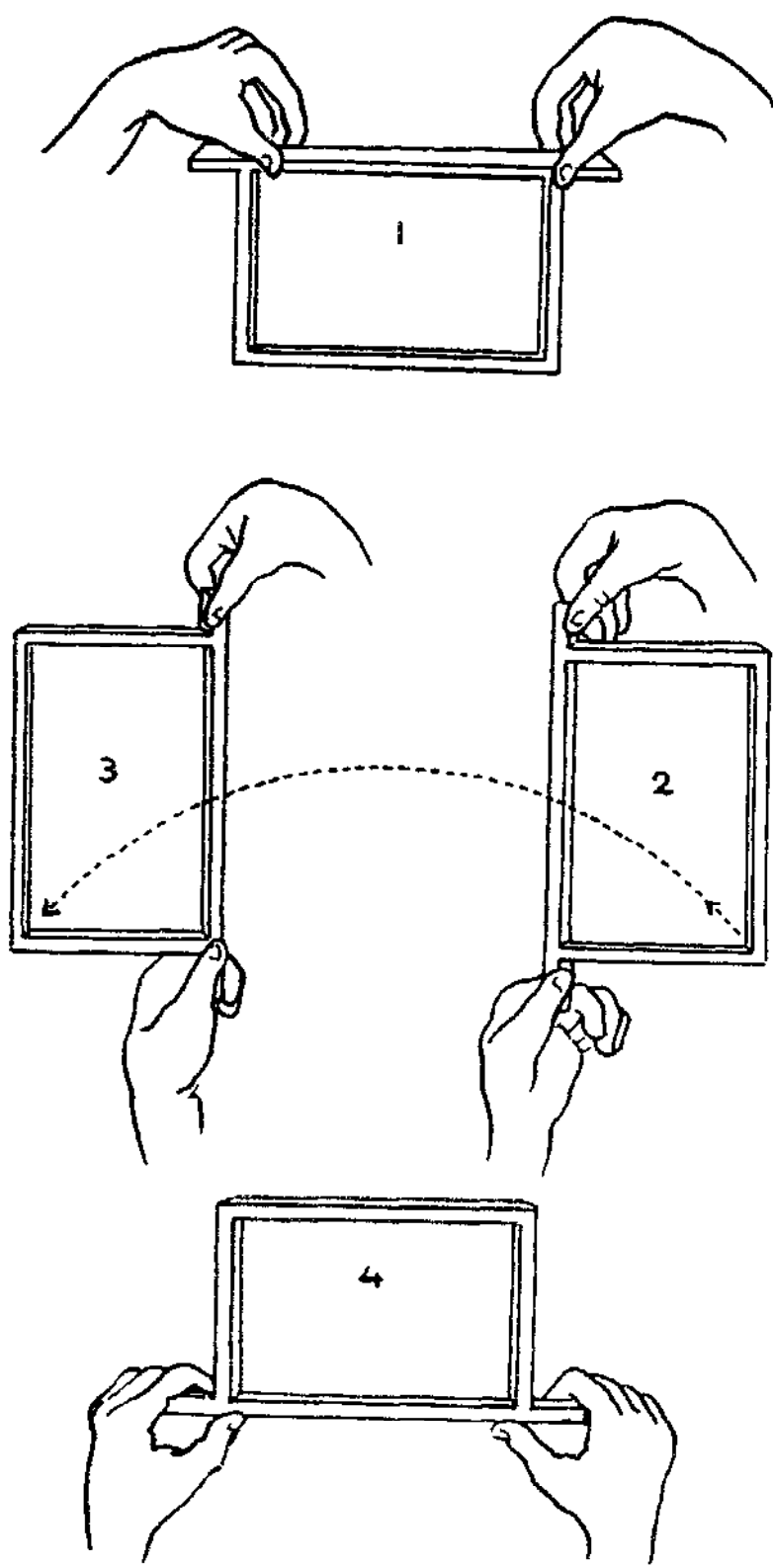

Figure 21. The correct way to handle a frame

HELPING A COLONY MAKE MORE HONEY

There are many things that can be done to help bees make more honey. Experience will make the beekeeper more aware of ways to increase honey production. A few ways to make beekeeping a success are listed below:

1. Do not keep colonies that are mean and hard to handle. Keep only those colonies that are calm and quiet, produce lots of honey, swarm little, and defend their hives against moths, wax beetles, ants (see Figures 22 through 25), and robber bees from other hives.

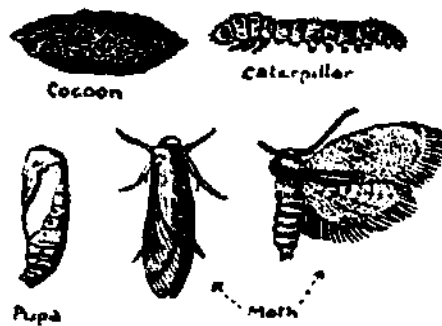

Figure 22. Lesser wax moth



Figure 23. "Death's Head Moth

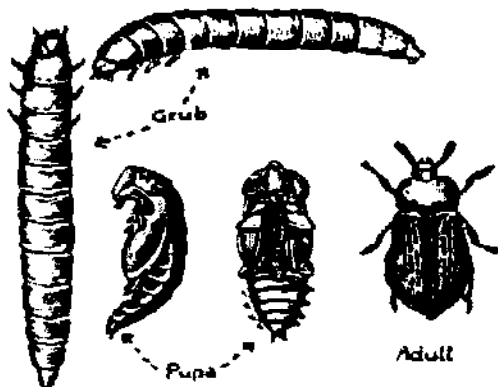

Figure 24. Wax beetle



Figure 25. Ant

2. Prevent swarming. About one-half of the bees are lost when they swarm. A crowded brood chamber is one of the main causes of swarming. Always make sure that bees have enough room in the brood chamber and honey super by adding additional brood boxes or supers before current ones are completely filled.
3. Locate hives properly. Hives should be placed near good sources of nectar, pollen, and water. The hives should be protected from direct wind and hard rains.
4. Timely visits. Getting a good honey crop is a year-round job. Bee colonies should be checked every month (except during cold winter days) for honey and pollen supply, population, and condition of the queen and brood.
5. Remove pests from the hive. The most serious pests are those that come to breed in the hive, like some kinds of beetles and moths. These pests will lay their eggs in any combs not defended by the bees. The larvae (grub, worm-like young) feed on pollen and other food in the cells, chewing large holes and tunnels in the combs.

The legs of hive stands can be made antproof with an application of sticky grease or "tangle-foot." Care must always be taken to prevent weeds and grass from growing up under the hives. Sometimes birds (Figures 26 and 27) will be noticed catching bees in the air and eating them. Usually the number of bees lost this way is not a serious problem to the beekeeper. Beekeepers in other countries have been known to shoot these birds or trap them with thin nets stretched high in the air.

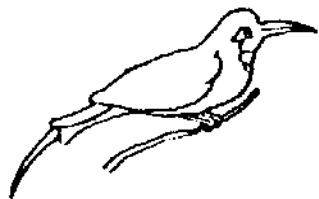

Figure 26. Bee eater

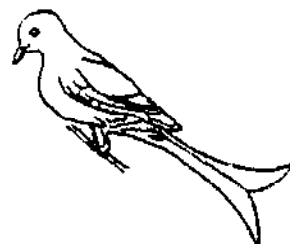

Figure 27. King crow

WHAT TO DO BEFORE THE HONEYFLOW

To make a good job of beekeeping, make sure your colonies are "humming" with young bees at the time of the honeyflow. Young bees are the best gatherers of honey and pollen.

The times of major and minor honeyflows vary from place to place. A successful beekeeper must learn to adjust hive management to seasonal changes in the life of the colony.

First-year Swarms

A swarm captured shortly before the major honeyflow and placed in a new beehive will probably use most of the honey they make to build combs for brood rearing and honey storage. The colony's honey stores should not fall below three kilograms (kg) (6-1/2 lbs) or about 2 full frames.

Before the Honeyflow

Examine each beehive and clean the inside of pests and dirt. If a colony is below average strength, it can be helped by adding a frame or two of capped (sealed) worker brood from a stronger colony. Another good practice is to make the strength of all colonies equal, so they all require your attention at about the same time, and respond equally to one kind of treatment. New colonies should be fed a 50% sugar solution until the honeyflow begins.

Prevent Swarming

Generally the swarming season comes just before the major honeyflow. Swarming is the colony's way of satisfying its natural urge to reproduce itself. By this method, the number of bee colonies is increased. The desire to swarm varies among

different colonies of bees. Swarming can be caused by an onrush of a sudden honeyflow, the sudden failure of the queen to lay eggs, a hot or poorly ventilated beehive, lack of space for egg laying and honey storage, and honeycombs in the worker brood area. If the bees feel crowded, they will surely swarm--or worse, desert the brood and beehive completely. Be sure to keep beehives in the shade and, if necessary, make the entrance opening to the hive larger during hot periods. If the bees cluster at the entrance on warm nights, it could mean they are feeling crowded and need more frames or supers, although this is normal in a busy hive.

The natural order of the frames in the brood chamber should not be disturbed. Only poor, irregular combs, or combs filled with drones, should be removed. Combs of drones should be placed in the honey super or outside the frames containing brood. In this way these frames will not act as barriers to the queen as she moves from one frame to another.

Frames in the brood chamber filled with honey and pollen should be moved to the outside of the brood area or into supers above. The frames should be carefully arranged with your fingers and spaced evenly apart. Prevent crowding by giving the bees enough well-drawn combs for brood rearing and honey storage.

Some beekeepers feed their weak colonies a sugar-water mixture of 1/2 sugar and 1/2 water to encourage them to rear more brood. A bee feeder is easy to make. All that is needed is a small container--a tin or glass jar--with a removable lid. Tiny holes are made in the lid. The sugar-water mixture is placed in the container and the lid is replaced. The container is then turned upside down and placed on the top of the inner roof hole inside the hive. An extra brood box without any frames is placed over the feeder and topped with the outer roof. This prevents the building of combs above the frames. The bees will go under the container and extract the sugar-water from the tiny holes in the lid. Feeding should be done with care, as this often causes robbers from other colonies to attack the weaker colonies having cans of sugar-water.

WHAT TO DO DURING THE HONEYFLOW

As nectar and pollen are being placed in the beehive, try to remain ahead of the bees in giving more frames and supers. The second super should be added between the first super and the brood chamber, not directly above the first super. Additional supers may be added in the same way, just above the brood chamber and below the other supers.

Colonies should be examined once a week. Frames full of honey are removed to the sides of the brood chamber or placed in the honey super. New frames with wax foundation should be placed next to the frames containing brood but not between brood frames where they will act as barriers to the queen.

When the honeyflow begins to slow down, the frames containing capped honey are removed. Harvesting must start while the bees are still bringing in nectar, otherwise robbing of weak colonies by stronger ones may begin. Such lawlessness in the beekeeper's apiary (the place where beehives are kept) will often cause a weak colony to desert the beehive, leaving the brood to die. When selecting frames of honey, be sure not to take combs that are not yet sealed with wax. This honey has not fully ripened and still contains too much water. Honey of this type will ferment quickly and should be avoided. When harvesting the crop, take out a frame of filled honeycomb and hold it near the entrance of the hive to shake or brush off the bees. The frames of honey are placed in covered empty supers and taken away for extracting (emptying the combs of honey). When the honeyflow has finished, unnecessary supers are removed, and the bees left with a proper store of honey to last until the next honeyflow begins.

HARVESTING THE CROPS (HONEY AND BEESWAX)

Beekeepers usually measure honey production in kilograms or pounds. The yearly production of surplus honey varies depending on the strength of the colony and the region where the beekeeping is taking place.

Probably the most efficient way to get honey out of the comb is to uncap, or remove, the thin cells covers with a warm knife and spin out the liquid honey with a honey extractor (see Figure 28). The honey extractor is made with a drum and basket fitting inside that holds two or four wooden frames. The honey is neatly removed and the combs returned to the hive to be refilled with more honey.

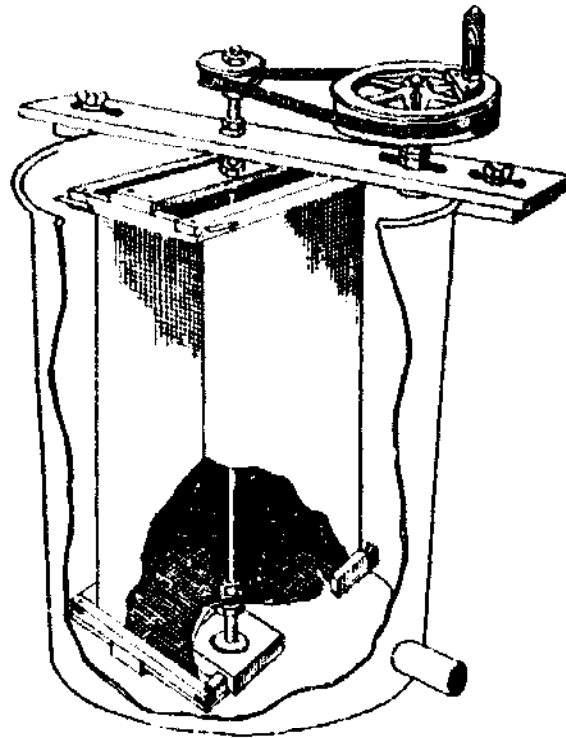

Figure 28. Honey extractor

It may be too expensive to buy or make an extractor for the amount of honey produced by a few colonies. Several nearby beekeepers might like to share this expense.

A less expensive (but wasteful) way to harvest liquid honey is to cut out the entire comb (leaving a 2.54cm [1"] strip along the top), squeeze the honey from it, and then strain the honey through a coarse cloth (jute sackcloth) to remove wax particles (see Figure 29). Although the crushed comb cannot be used again by the bees, you can melt it and sell the beeswax.

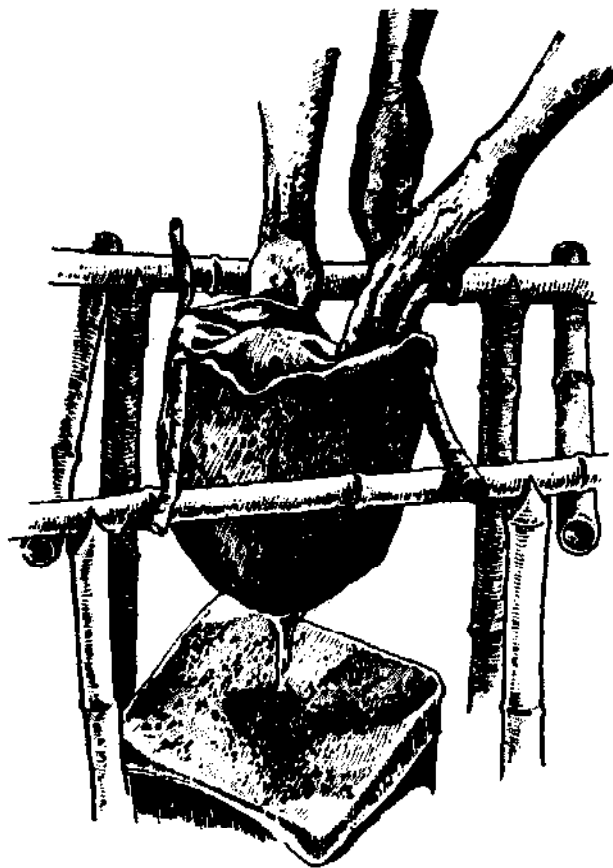

Figure 29. Squeezing out honey

The beginner can melt and clean wax in a large tub or pot. The bits of wax and comb material should be put in the tub or pot and covered with water. The container should be on a sturdy,

fireproof stand so a fire can be built underneath it. Heat the water until it boils. The beeswax will rise to the top of the container. Do not let the water boil over the top of the container since the hot wax will burn.

When the wax is completely melted, strain the mixture through a piece of jute sackcloth or screen wiring. This will remove any remaining large particles. If the mixture is strained into a pail that is larger at the top than at the bottom, the wax cake can be removed easily after it cools and hardens. Pure wax will be on the top. Unwanted particles at the bottom of the cake can be removed by trimming and scraping. it can then be used to make candles or sold in the market.

APPENDIX

SPECIES AND VARIETIES OF BEES

Honeybees are the most widely studied insects in the world. There are many types of honeybees throughout the world and many differences between them. Local universities, extension agents, or experienced villagers can help a beginning beekeeper determine which types of bees are best for their area. They can also give advice on proper management techniques for each type.

THE ROCK BEE or GIANT BEE (Apis dorsata)

Rock bee colonies move from place to place to avoid extreme cold or in search of honey plants and water. They fly fairly high and fast and make a sound similar to, but fainter, than that of a passing airplane. This sound is sometimes heard by farmers working in their fields.

A rock bee colony builds a single large comb fastened to the branches of tall trees. Sometimes the comb may be seen hanging from roofs or ceilings of neglected buildings. Sometimes many colonies of the rock bees are found living close together.

The worker is light brown in color while the queen is darker and longer. The drone is black in color and is the same size as a worker.

Rock bees are good honey gatherers and have been seen to begin the day's work earlier and stop later than the Indian bees. They store surplus honey, usually in the front portion of the comb, which is harvested two or three times during the year by professional honey gatherers. A single colony may yield up to 35kg (77 lbs) of honey during a year.

Unfortunately, rock bees have ferocious tempers and have been known to attack people and animals when disturbed or excited. They are, however, controllable with smoke and are as successfully managed in this way as any other species of honeybee. Professional honey gatherers and modern beekeepers are able to handle them with little difficulty. Some beekeepers have tried to keep rock bees in box hives, but the bees prefer their homes in high places and soon leave after a few days.

THE LITTLE BEE (Apis florea)

These bees move about often and seldom remain at one place for more than five months at a time. They make a single small comb about the size of the palm of the hand. The comb can be found hanging from branches of bushes, trees, empty boxes, piles of dried sticks, or the ceilings of buildings.

The workers are very noticeable. The portion of the bee's body just behind the legs and wings is bright orange, with black and white stripes near its end. These workers are much smaller than the golden brown queen and black drones with smoky grey hair.

Although little bees are more gentle than rock bees, their small comb yields only 0.5-1kg (1-2 lb), and they prefer to remain in the wild.

THE INDIAN BEE (Apis indica)

This is the best bee for producing honey and can easily be housed in wooden boxes, packing crates, kerosene tins, earthen jars, and wall recesses. Unlike its rock bee and little bee sisters, the Indian bee makes several combs for storing honey.

There are several regional varieties or strains of the Indian bee. Two common strains are the hill and plains varieties. The worker bees of the plains variety are comparatively smaller and have a deeper yellow color. At higher altitudes larger and darker bees are found.

The habits of this bee vary from strain to strain. Generally speaking, it is a bee with a gentle temper and is easy to handle even by the beginner. It responds to smoking; but in several cases, bees showed a little uneasiness.

On the average, colonies yield 3-5kg (7-11 lbs) of honey each year at higher altitudes and 1-3kg (2.2-7 lbs) each year on the plains. Experienced beekeepers in other parts of Asia have recorded yields of 13-18kg (29-40 lbs) of honey per year using special, movable frame hives, described in this Bulletin. By continually selecting the best honey-producing colonies and discarding all the rest, some experienced beekeepers have had hives yielding as much as 25-40kg (55-88 lbs) in one year. This requires much skill and a location where the bees will find good honey plants.

The Indian honeybee is a good producer but has a few defects to keep in mind. Sometimes colonies will leave the hives of the beekeeper and return to living in the wild. At other times, a strong colony will rob the honey from weaker hives in the beekeeper's yard causing its death. In addition, the bees use little propolis and are often helpless against certain types of wax-moth, which enter the hives and damage the combs.

THE EUROPEAN BEE (Apis mellifera)

This bee is worth learning about because of the large amount of honey it is able to produce. Average yields of 45-180kg (99-396 lbs) per colony in groups of 500 or more colonies are common in the United States. The best yield recorded to date is that of 45.3kg (100 lbs) from a colony in the USA.

The European bee is found all over Europe and has a large number of well recognized varieties and strains. The Italian variety is considered to be the best and has been introduced in almost all countries of the world. It is similar in habits to the Indian bee in that it makes its home in enclosed places and builds several combs for storing honey. Queens are good layers; the bees have gentle tempers, good honey-gathering habits, and

guard their home against all bee enemies except wasps. It has adapted itself particularly well to the movable-frame hive and modern methods of management. Man has even developed special strains for gentle temperament, honey gathering, pollination, and other qualities.

Importation of the European bee should be restricted to well equipped Government-sponsored establishments with quarantine arrangements. Private beekeepers are urged not to import foreign bees to avoid several bee diseases, which are common among bees available in Europe and America.

REFERENCES

First Lessons in Beekeeping, Dadant & Sons, Inc.

Rearing Queen Honeybees, Roger A Morse, Wicwas Press, 1979.

Beekeeping, B. R. Saubolle and A. Bachmann, Sahayogi Prakashan, 1979.

INFORMATION AND MATERIALS

All India Beekeepers' Association, 424 B, Shaniwar Peth, Poona, 2 India.

International Agency for Agriculture Development, 3201 Huffman Boulevard, Rockford, Illinois 61103 USA.

PRODUCTION LOGS

HONEY FLOW

HIVE #

DATE

LOCATION

QUANTITY

COMMENTS

HIVE #

DATE

LOCATION

QUANTITY

COMMENTS

HIVE #

DATE

LOCATION

QUANTITY

COMMENTS

HIVE #

DATE

LOCATION

QUANTITY

COMMENTS

HIVE #

DATE

LOCATION

QUANTITY

COMMENTS

HIVE #

DATE

LOCATION

QUANTITY

COMMENTS

HIVE #

DATE

LOCATION

QUANTITY

COMMENTS

HIVE #

DATE

LOCATION

QUANTITY

COMMENTS

HIVE #

DATE

LOCATION

QUANTITY

COMMENTS

HIVE #

DATE

LOCATION

QUANTITY

COMMENTS

BLOOM DATES

VARIETY

DATE/DURATION

LOCATION

QUALITY

COMMENTS

VARIETY

DATE/DURATION

LOCATION

QUALITY

COMMENTS

VARIETY

DATE/DURATION

LOCATION

QUALITY

COMMENTS

VARIETY

DATE/DURATION

LOCATION

QUALITY

COMMENTS

VARIETY

DATE/DURATION

LOCATION

QUALITY

COMMENTS

VARIETY

DATE/DURATION

LOCATION

QUALITY

COMMENTS

VARIETY

DATE/DURATION

LOCATION

QUALITY

COMMENTS

VARIETY

DATE/DURATION

LOCATION

QUALITY

COMMENTS

VARIETY

DATE/DURATION

LOCATION

QUALITY

COMMENTS

VARIETY

DATE/DURATION

LOCATION

QUALITY

COMMENTS

WAX PRODUCTION

HIVE #

DATE

LOCATION

QUANTITY

COMMENTS

HIVE #

DATE

LOCATION

QUANTITY

COMMENTS

HIVE #

DATE

LOCATION

QUANTITY

COMMENTS

HIVE #

DATE

LOCATION

QUANTITY

COMMENTS

HIVE #

DATE

LOCATION

QUANTITY

COMMENTS

HIVE #

DATE

LOCATION

QUANTITY

COMMENTS

HIVE #

DATE

LOCATION

QUANTITY

COMMENTS

HIVE #

DATE

LOCATION

QUANTITY

COMMENTS

HIVE #

DATE

LOCATION

QUANTITY

COMMENTS

HIVE #

DATE

LOCATION

QUANTITY

COMMENTS

SWARMING

HIVE #

DATE

LOCATION

SIZE

COMMENTS

HIVE #

DATE

LOCATION

SIZE

COMMENTS

HIVE #

DATE

LOCATION

SIZE

COMMENTS

HIVE #

DATE

LOCATION

SIZE

COMMENTS

HIVE #

DATE

LOCATION

SIZE

COMMENTS

HIVE #

DATE

LOCATION

SIZE

COMMENTS

HIVE #

DATE

LOCATION

SIZE

COMMENTS

HIVE #

DATE

LOCATION

SIZE

COMMENTS

HIVE #

DATE

LOCATION

SIZE

COMMENTS

HIVE #

DATE

LOCATION

SIZE

COMMENTS

