

AT MICROFICHE
REFERENCE
LIBRARY

A project of Volunteers in Asia

Small Scale Beekeeping
Peace Corps ATFD Manual No. M-17

by: Curtis Gentry

Published by:
Peace Corps
Information Collection and Exchange
806 Connecticut Avenue, N.W.
Washington, DC 20526 USA

Available from:
Peace Corps
Information Collection and Exchange
806 Connecticut Avenue, N.W.
Washington, DC 20526 USA

Reproduction of this microfiche document in any
form is subject to the same restrictions as those
of the original document.

APPROPRIATE TECHNOLOGIES FOR DEVELOPMENT

Small Scale Beekeeping

Peace Corps

INFORMATION COLLECTION & EXCHANGE

MANUAL M-17

INFORMATION COLLECTION & EXCHANGE

Peace Corps' Information Collection & Exchange (ICE) was established so that the strategies and technologies developed by Peace Corps Volunteers, their co-workers, and their counterparts could be made available to the wide range of development organizations and individual workers who might find them useful. Training guides, curricula, lesson plans, project reports, manuals and other Peace Corps-generated materials developed in the field are collected and reviewed. Some are reprinted "as is"; others provide a source of field based information for the production of manuals or for research in particular program areas. Materials that you submit to the Information Collection & Exchange thus become part of the Peace Corps' larger contribution to development.

Information about ICE publications and services is available through:

Peace Corps
Information Collection & Exchange
Office of Program Development
806 Connecticut Avenue, N.W.
Washington, D.C. 20526



Add your experience to the ICE Resource Center. Send materials that you've prepared so that we can share them with others working in the development field. Your technical insights serve as the basis for the generation of ICE manuals, reprints and resource packets, and also ensure that ICE is providing the most updated, innovative problem-solving techniques and information available to you and your fellow development workers.

Peace Corps

SMALL SCALE BEEKEEPING

by

Curtis Gentry

illustrated by

Stacey Leslie

Peace Corps
Information Collection and Exchange
Manual M-17
December 1982

Beekeeping

December 1982

Prepared for the Peace Corps by
Curtis Gentry
under Contract No. 81-043-1028

Available through
Peace Corps Information Collection and Exchange
806 Connecticut Avenue, N.W.
Washington, D.C. 20525

Acknowledgements

The ideas of many people went into this manual. The exact source of many of these ideas is lost as they came from beekeepers in many places with whom I've worked or whose writings I've read. Thanks to all these friends and teachers.

The care and patience of many people also went into the manual. For all their help in typing, editing, proofing, laying out, and commenting, I thank:

Mark Coleman
Jean Cummings
Liz Davidson
Calvina Dupre
Valerie Flynn de Villa
Donna Frelick
Shannon Green
Mary Lou Haag
Sharon Hagen
Marie Kabelitz
Rob Kingsolver
John Oliver
Fay Reilly
Jose Villa
Dr. Lucas Villa

Table of Contents

	About This Manual	iii
	Acknowledgements	iv
	Preface	vii
Chapter		
1	Bees and Humans Bee-killing, Bee-having, Beekeeping; Why Develop Beekeeping?	1
2	Project Planning Beekeeping as an Integrated Activity; Beekeeping as an Educational Activity; Beekeeping as a Cooperative Activity.	11
3	Bee Basics Types of Bees; Climate and Beekeeping; Life Cycle of the Honey Bee; The Castes; Resource Needs of the Colony; Swarming, Supersedure, and Absconding.	19
4	The Essence of Beekeeping Management Schemes.	45
5	The Bee Space and Beehives The Bee Space; Types of Hives.	59
6	Intermediate Technology Beekeeping Why?; Some Considerations before Starting; Getting Started - The Hives; Getting Started - The Apiary; Getting Started - Equipment; Getting Started - Bees; Management Practices.	69
7	High-tech Beekeeping Inputs and Possibilities; Problems in Small-scale Development.	131
8	Hive Products Honey; Beeswax; Pollen; Bee Brood; Others.	147
9	Diseases, Pests, and Insecticides	161

Appendix

A	Resources and Bibliography	179
B	Hive Plans	189
C	Equipment Plans	197
D	Uses for Beeswax	207
E	Making an Artificial Swarm	211
F	Honey Bee Anatomy	213

Preface

This is a manual for getting started with small-scale beekeeping development projects. The intention is to provide an overview of beekeeping and its possibilities as a tool for development.

No attempt is made to duplicate technical information given in other readily available resources on beekeeping. The idea is to provide an orientation to the realities of small-scale development beekeeping. Once oriented to these realities, you should be able to adapt more technical material to the situation in your community.

There are intermediate levels of beekeeping technology which can be self-sustaining using only local resources. Information on this scale of beekeeping is hard to find. Much of it is presented in a technical form in beekeeping journals. This manual offers a guide to these intermediate technology beekeeping systems and methods.

The reality of most small-farmer situations makes "high-tech" beekeeping unviable. High-tech beekeeping is well covered in other readily-available sources. Therefore, this guide does not cover this scale of beekeeping in detail. High-tech beekeeping is covered here to point out its possibilities as an ultimate development goal. The problems that often arise when trying to carry on high-tech beekeeping where inputs are difficult to obtain are also discussed. For more details, an annotated list of sources is given in Appendix A.

A bee-human relationship exists throughout the world, except in the arctic and the extensive desert regions. In many regions, this relationship is carried on at a low level of technology and understanding of bees. This guide provides the information necessary to assess the local level of the bee-human relationship and to determine an appropriate beekeeping technology for your area.

Bees and Humans

Interest in bees started with the hunting and robbing of wild colonies in hollow cavities in trees or rocks. Until the refining of sugar cane developed in the 19th century, honey was the only sweetening agent widely available. It was prized not only as food, but for its uses in folk medicine.

People have observed and studied bees with the object of increasing the production of hive products and making it easier to gather them. Bees have also intrigued many people because of their highly social nature. Analogies have often been proposed between the sociality of bees and humans.

The accumulated knowledge on bees allows the modern beekeeper to manage them. The beekeeper can gather hive products with an ease and efficiency far greater than the honey hunter or gatherer.

Although humans have learned much about bees and how to keep them, the bee itself has not changed. Unlike most of the animals and plants used in agriculture, the honey bee of today is the same as it was thousands of years ago. In short, humans have not domesticated the honey bee.

The bee is still essentially a wild animal. People can keep bees and manage them for greater production, but control over bee genetics and behavior has not been achieved to the same degree as with domesticated animals and plants.

Bee-killing, Bee-having, Beekeeping: The scope for development

There are three basic stages in the historical development of the bee-human relationship. These are bee-killing, bee-having, and beekeeping. Modern beekeeping is the most developed stage. The most basic stage, or bee-killing, is still common in some parts of the world.

STAGES IN THE BEE-HUMAN RELATIONSHIP

bee-killing → bee-having → beekeeping
(bees killed) (bees maintained) (bees managed)

Bee-killing is the killing of the bees in a colony so that the combs containing honey and brood (larval and pupal stages) can be taken. Left without honey stores or brood, any surviving bees are doomed. Honey hunters usually regret having to kill the colony, but they know of no other way to obtain honey or wax.

Wild bee colonies are common in many regions of the world, and the gathering of honey from these colonies is an occasional activity for many local farmers. This often occurs when trees containing bee colonies are felled during the clearing of forest and bush for planting crops. Honey hunters or gatherers usually use fire to kill the bees. They are thought to be responsible for many bush fires in some areas.

The honey obtained is used for household consumption or marketed locally. It is often of very low quality as it is mixed with bits of old comb, brood, and ashes. Even so, there is a ready local market for honey in most regions. In some areas, honey is fermented either alone or with palm wine to make an alcoholic drink. Honey is also used by some groups as medicine.

The brood is sometimes eaten by children and is considered a treat. The 30 per cent protein content of the brood is a bonus in their diet. However, since brood is only available when wild colonies are gathered, it is not a significant nutritional factor.

The value of the beeswax is often unknown where bee-killing is practiced; it is usually thrown away or used for fuel.

Bee-killing, or honey hunting, is a traditional activity in many regions of Africa and Asia. In most other regions of the world it is an incidental activity. It is often not considered worth the effort as easier ways of getting hive products are used.



A variation on bee-killing is traditional in some regions of Africa. Straw containers or clay pots are hung in trees to attract wild colonies. After the colony has been in the container for sufficient time to have built up honey stores, the container is lowered, the bees killed, and the hive products taken. Even though the bees are attracted to a man-made container, this is still bee-killing.

Bee-having is an intermediate step between bee-killing and beekeeping. In bee-having, bees are housed in hollowed sections of tree trunks, clay pots, gourds, bark hives, or straw-and-mud containers. Combs are fixed to the containers which allows for little inspection and no manipulation (management) of the colony. Combs containing honey are removed periodically, and those containing brood are left. The wax is recognized as having value and is used locally or sold.



In bee-having the farmer provides protection to the bee colony in return for periodic harvests of honey and wax. The idea is to maintain the colony for future harvests instead of destroying it for a one-time harvest.

Both bee-killing and bee-having are carried on with very little understanding of the biology of the bee. It is not uncommon to find bee-having among farmers who have relatively sophisticated equipment which allows for management of their colonies. They remain bee-havers because they lack the training to make optimum use of their equipment.

Beekeeping implies the manipulation of a bee colony; it is predicated on some understanding of the bee. Management practices can be relatively simple, low-level technologies or fairly complicated procedures, using more sophisticated equipment. Beekeeping can be lucrative at any level of technology, but the level used should mesh with the local cultural and economic reality.

A wide range of hive equipment can be used for beekeeping.

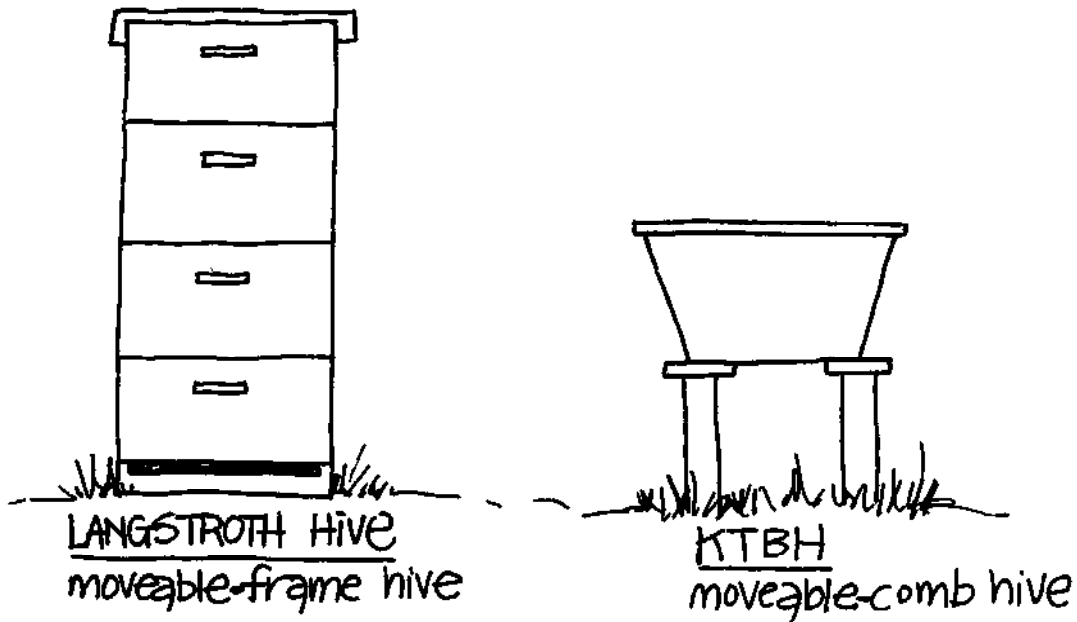

Relative to most other agricultural pursuits, "high-tech" beekeeping is a soft technology. The equipment inputs needed to carry out high-tech beekeeping can be made on a local level in most places in the world. The limiting factor is the human one of lack of knowledge to profitably utilize relatively expensive equipment.

* * * * *

"Development" should be defined within cultural and economic realities. Observing the local bee-human relationship--whether bee-killing, bee-having or beekeeping--provides an understanding of the context within which any beekeeping development effort must be directed.

These developmental stages are often discussed as distinct periods. However, in reality, like any development, the development of the bee-human relationship is a continuum.

A well-directed development effort should recognize the place on the continuum where the target program starts, and thus set realistic goals for advancing toward "development".

Why Develop Beekeeping?

Beekeeping is an activity that fits well with the concept of small-scale agricultural development. It is a labor-intensive undertaking which can be easily integrated into larger agricultural or forestry projects. Bees not only aid in the pollination of some crops used in such projects, but they make use of otherwise unused resources - nectar and pollen.

As a bee-human relationship already exists in most regions of the world, the objective of any beekeeping development effort is to introduce new and more efficient methods. The bee resource already exists; the objective is better utilization of this resource.

All the inputs necessary for carrying out a beekeeping venture can be made locally. Smokers, protective clothing, veils, and hives can be made by local tinsmiths, tailors, carpenters, or basketmakers. Thus, a beekeeping project can create work and income for these people.

A small beekeeping project can be profitable from the beginning. After a project is started and expertise is gained, it is easy for a beekeeper to increase the number of hives. A dependence on outside resources or inputs is not necessary to do this. Bees feed themselves from the existing nectar and pollen resources of the area by foraging far beyond the small amount of land on which the hives are located.

Beekeeping is a family undertaking. Although working with bees is an activity that is easily done by women, in most cultural settings it is usually considered a man's task. While men work directly with the bees, women are often involved in preparing the honey for market and in the actual marketing.

Small farmers usually consider honey a cash crop instead of a product for home consumption. Honey has a high cash value relative to its weight and bulk. Properly stored, it is essentially a non-perishable product. It is economical and easy to transport. These characteristics make honey an attractive crop for small-scale and often isolated producers.



While in most areas there is a ready local market for honey, this is not always true for beeswax. In some areas it may be necessary to create a market for the wax.

Beeswax is an easily-stored, non-perishable product. It is used in some areas by local craftsmen and artisans such as lost wax metal (usually brass) casters, wax printers and batikers of cloth, tanners and leather workers, and candle makers. Beeswax can also easily be used in the making of wood polishes.

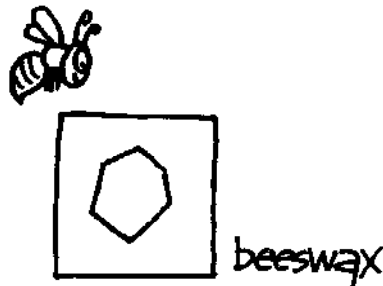

In areas of the world where the beekeeping industry is well-developed, there are markets for pollen and propolis (tree resin gathered by bees for use in the hive). While these may be potential products for a beekeeping venture, they are not feasible for beginning projects. Production of pollen is relatively difficult, and there are few local marketing outlets for these products in most areas.

Another product of beekeeping is bees themselves. Once beekeeping becomes established, a market develops for bees. Some beekeepers can supply bees to others who want to start beekeeping.

While there are ready international markets for bee products such as honey and beeswax, any development effort should aim first for local markets. A beginning project does not produce in sufficient quantity to merit seeking an international market.

Developing a local market for bee products insulates local producers from fluctuating world prices, and provides an accessible market for small producers.

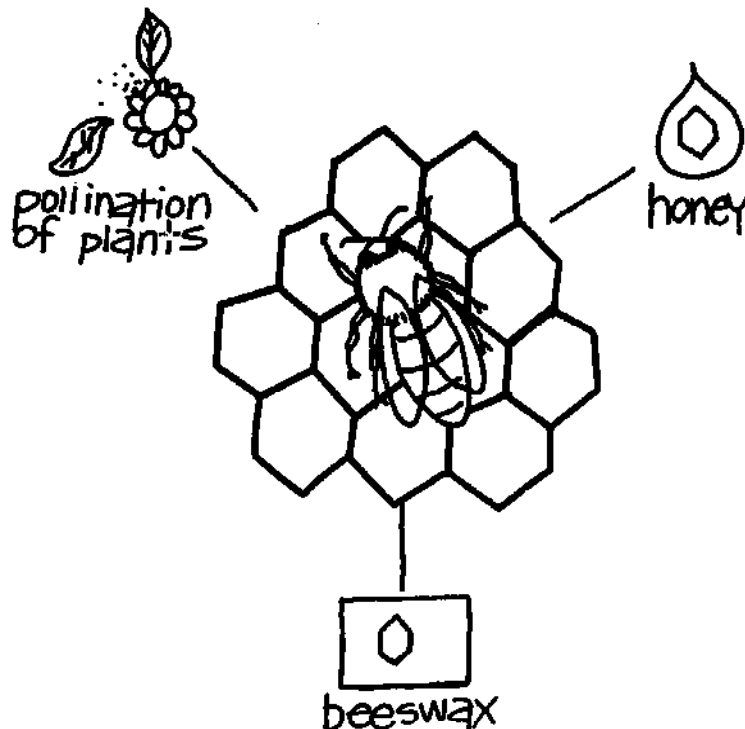

Beekeeping is an activity which fits well with the philosophy of small-scale development. There is a great potential for developing beekeeping in many areas.

Beekeeping can:

- supply an additional non-perishable food for rural people.
- provide cash crops for rural people - honey and wax.
- be a means of gainful work when the farmer is not involved in planting staple crops.
- create work for local craftsmen who make equipment.
- increase the production of other crops such as peanuts, coffee, and citrus through better pollination. Insect pollination is important for many cultivated plants.

Beekeeping is a family activity which has the following advantages over other types of agriculture:

- It needs a relatively small investment.
- It uses little land and the quality of the land is not important.
- It is a flexible activity for both sexes of any age.
- It can be carried on as a productive secondary activity with low level technology, or as a primary undertaking with more complicated techniques.
- Beekeeping does not compete for resources with other types of agriculture - the nectar and pollen of plants are a true bonus.

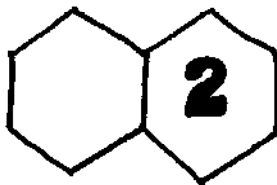

Project Planning

The first step in planning a beekeeping project is to become familiar with the bee-human relationship in your area. Talk with those in the area who are involved with bees. Accompany them when they work with bees.

If you have no experience working with bees, it is possible to learn a lot by working with local bee-killers, bee-havers, or beekeepers. By knowing how they work, you can make suggestions for improvement with more credibility, and it will be easier to adapt an appropriate beekeeping technology to the area.

Also, you should get through a couple of stinging incidents before committing yourself to beekeeping. Bee stings are an integral part of beekeeping. A beekeeper has to deal with them.

Once you become familiar with the local bee-human relationship, ideas for introducing improved methods should be formulated. Whom to work with? What equipment to use? Where to market hive products?

If you are just beginning with bees you would probably be better off working with just one or two individuals in the area. By selecting farmers who have the respect of their peers and have good contacts in the community, your efforts will be multiplied. Keeping bees yourself and using methods different from those used in the area is a step in the right direction. Word will get out, and sooner or later you will be talking with your friends and neighbors about beekeeping.

Always start beekeeping with at least two hives. This gives an opportunity to compare the progress between a number of hives, and more importantly, it allows the project to continue should one colony die out. Also, management aimed towards an apiary instead of individual hives can be stressed.

In planning a project, set realistic goals. A small project which succeeds is more meaningful than a large one which is attempted but fails.

Change is slow. It must start with an idea. The successful presentation of an idea is a realistic expectation for introducing improved methods to the bee-human relationship in some areas.

The equipment to be used in a project depends on the local situation. You should assess the availability of needed inputs as well as the technical aid available in choosing what type or types of hive equipment are appropriate.

Identifying people in an area who can make beekeeping equipment and getting it made can be success in itself. It can require a lot of patience to coordinate getting the equipment together.

Local outlets for marketing are available for hive products in most areas. Check for those people who are already using honey or beeswax. Often, they are eager for a steady supply of a good quality product. If not already using honey, local bakers and candy makers are a potential market. Check also with those who may provide potential markets for beeswax (see Chapter 8, Beeswax).

Beekeeping as an Integrated Activity

Beekeeping is an activity which meshes well with other agricultural and rural development projects. Regional development projects also offer possibilities of implementing beekeeping ventures.

Certain crops planted in such projects can yield honey for the beekeeper as well as benefit from the pollination activities of the bees. Beekeeping can provide additional income to small farmers who plant these crops or have their bees nearby.

The following crops are known to benefit from insect pollination. Those marked with an asterisk are also good nectar sources for honey bees.

- henequen
- sisal
- tung
- cashew
- tea
- papaya*
- coconut*
- coffee*
- squash
- pumpkin
- cucumber
- oil palm*
- litchi
- citrus*
- apples*
- avocado
- clover*
- melons
- watermelons
- peaches
- blackberries
- sesame
- sunflowers*
- soybeans (some varieties)*
- alfalfa

Plants benefit from insect pollination by an increased seed set. This results in increased seed production and better quality fruits. Honey bees are beneficial as pollinators in those areas where natural insect pollinators are lacking or are insufficient to pollinate large areas devoted to a single crop. (Remember though, honey bees are not attracted to all crops.)

(For more information on the pollination requirements and the attractiveness of specific crops to honey bees see Appendix A.)

People involved in forestry projects are often interested in beekeeping. Beekeeping is an income-yielding undertaking based on a forest resource, yet it is not destructive to that resource. Someone who is earning an income from beekeeping quickly becomes an advocate for preserving the forest resource. Beekeeping also lessens the likelihood of brush fires being set by honey hunters when they burn bees out of a wild colony.

Tree species used in reforestation efforts which are also good bee forage can be instrumental in the establishment of a beekeeping industry. Beekeeping is a part of the utilization of a multi-purpose forest resource.

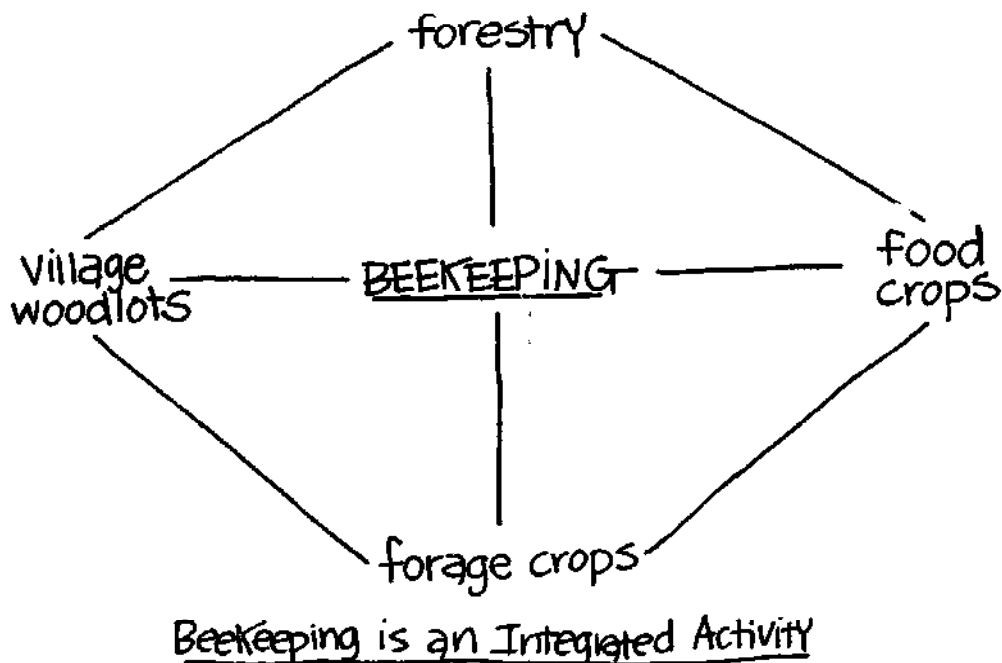

The following trees which are used for other purposes such as firewood, shelter belts, and shade also secrete sufficient nectar to produce yields of honey in some regions. As nectar secretion is dependent on many factors (climate, weather, and soil), a tree may not be a good nectar producer when introduced into a new region. Check to see if a tree species is a good nectar producer under the conditions which it will be growing before advocating its use as a nectar source for bees.

Acacia spp.
Albizia lebbek
Avicennia spp.
Calliandra calothyrsus
Eucalyptus camaldulensis
Eucalyptus citriodora
Eucalyptus globulus
Gliricidia sepium
Gmelina arborea
Grevillea robusta
Guazuma ulmifolia
Inga vera
Pithecellobium dulce
Prosopis juliflora
Rhizophora spp.
Syzygium cumini

(For more information on planting trees see PC Program and Training Journal - Manual Series Number 5, Reforestation in Arid Lands. This is available from the PC Office of Information Collection and Exchange.)

Beekeeping as an Educational Activity

Vocational and agricultural training centers and rural teacher training institutes make good sites to mount beekeeping projects. The trainees can have a multiplier effect in introducing beekeeping at the village level and the centers themselves serve as excellent demonstration sites.

Beekeeping is also a good school or youth group project. Students and members of youth groups are the farmers of the future. They are receptive to new ideas and methods and can be helpful in conveying these to their parents.

A demonstration apiary at a school not only provides a good educational opportunity, it can also provide some revenue.

(Lesson Plans for Beekeeping, PC Reprint Series Number R32 available from the PC Office of Information Collection and Exchange, is useful for teachers.)

Exhibits of bees, equipment, and hive products in regional fairs and meetings also serve to promote beekeeping and honey sales. Demonstrations actually working with colonies can help counter many popular fears of bees. An especially attention-getting demonstration is making an artificial swarm and then rehousing it (Appendix E).

A glass-sided observation hive can create a lot of enthusiasm for bees. It affords a chance to study the bees at their hive activities, thus it is a great educational tool. Since such a small hive often needs close attention and care to maintain, it gives many opportunities for teaching the management needs and practices of the colony. (See Appendix B for plans of an observation hive.)

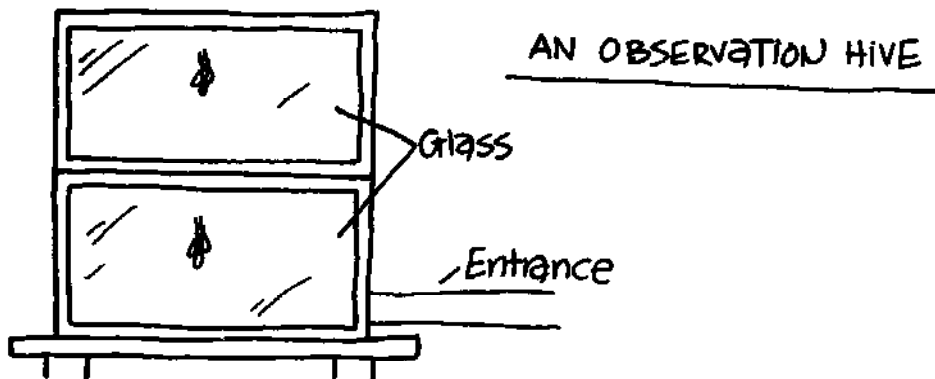

Beekeeping as a Cooperative Activity

Beekeeping also works well in cooperatives. Many cooperatives have beekeeping projects as part of their activities. In some coops, beekeeping is the sole activity. These coops supply needed inputs, access to technical aid, and markets for honey and beeswax. In some cases, beekeeping coops have been very successful.

(For more information on the organization and functioning of coops see PC Information Collection and Exchange Resource Packet P-5, Cooperatives, and Reprint R-14, Guidelines for Development of a Home Industry.)

Funding for beekeeping projects can be sought from the types of institutions mentioned above. Many missions and private donor agencies involved in small-scale agricultural projects are often interested in beekeeping.

* * * * *

Records of your experiences--both successes and failures--in setting up beekeeping projects are important for others who may want to start projects. A project report left behind when you leave will serve to encourage further development of beekeeping. Your report should include sources of bees and equipment as well as information on those who are involved in beekeeping in the area.

The information that you gather about beekeeping in your area is valuable. Time spent on preparing a report will allow your information to continue to be useful.

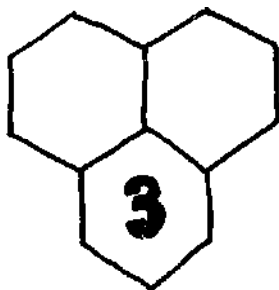

Bee Basics

Types of Bees

There are many different species of bees. Most bees are solitary, but some are social. These live together in colonies with a division of labor among the individuals.

The habit of visiting flowers makes all bees important as pollinating agents. All bees gather nectar and pollen from flowers, but only a few of the social bees store the nectar as honey. Of the bees that store honey, there are even fewer species that store it in sufficient quantity to make the effort of harvesting the honey worthwhile.

Although some "stingless" bees are robbed of their honey in tropical regions, bees of the genus Apis, the true honey bees, are the major producers of honey and other hive products. Apis mellifera, the western hive bee, has been introduced into most regions of the world for use in beekeeping.

Stingless bees

In tropical regions, some species of stingless bees - notably Trigona and Melipona - are robbed of their honey. All of these bees build their nests inside cavities. Even though these bees do not sting, they defend their colony by biting the intruder. Some secrete irritating substances along with the bite.

The brood comb of stingless bees is one cell thick and usually horizontal. These bees store honey in thimble-sized wax honey pots placed around the brood area of the nest. In some areas, these stingless bees are kept in gourds, clay pots, or hollowed logs. Honey is harvested by opening the nest cavity and removing the honey pots. The yield is very low, and marketing it is worthwhile only on a local level. Such honey is often highly prized locally for medicinal use.

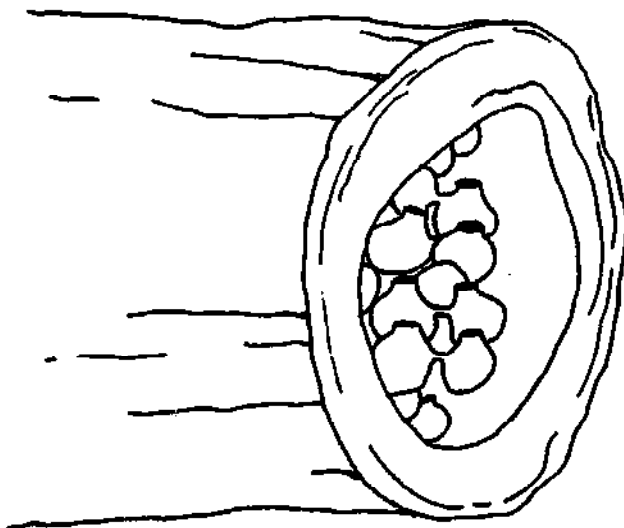

Honey pots of Melipona

The Mayas of Central America developed a system of keeping one species of Melipona in log hives. Honey was important in their religious celebrations, and they had special festivals and rituals to assure good honey harvests. This is the only case in the world where a bee culture developed with a non-Apis species of bee. Such meliponiculture still survives in regions of Central America. Yields of 10-12 kg/year are maximum with these bees.

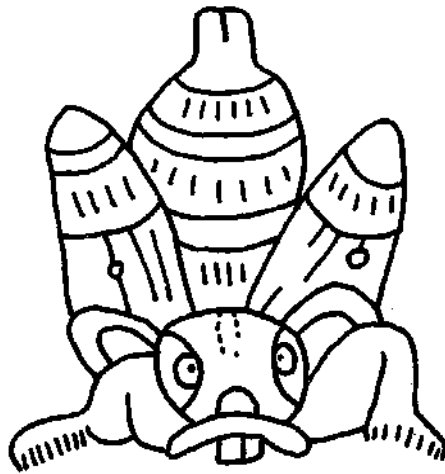

Mayan bee symbol

Since stingless bees use a different type of nest structure for honey storage and brood, improved methods for keeping these bees are limited in their effectiveness for increasing production. This, coupled with low yields, makes the keeping of these bees economically feasible only for home honey consumption.

Apis: The true honey bee

There are four species in the bee genus Apis -- three which are native to Asia and one which is native to the Euro-African region. All of these are similar in appearance, though there are size and color differences. All build vertical combs that are two cells thick.

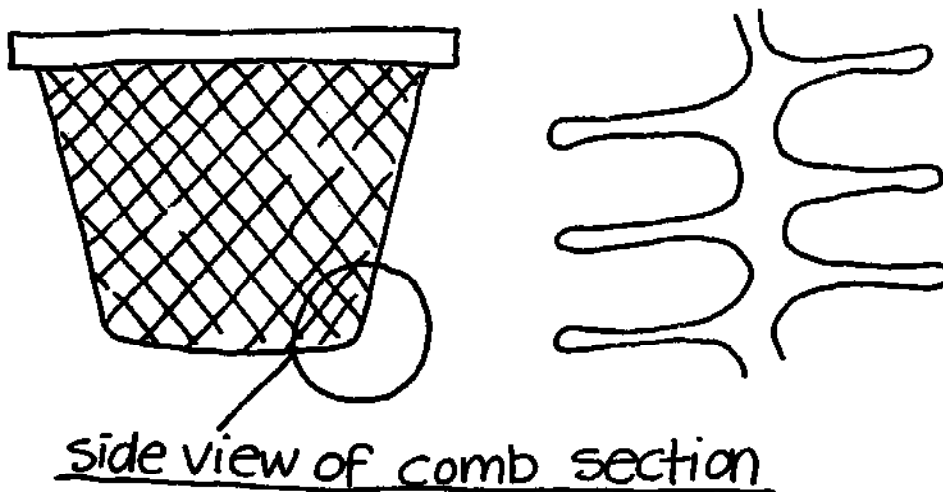

The giant or rock honey bee (*Apis dorsata*) and the little honey bee (*A. florea*) are found in Asia. Both of these bees build a single-comb, exposed nest. Nests are often seen hanging from branches of trees, roofs, or ceilings. The adult bees hang in curtains around the nest to control nest conditions. Brood and honey stores are in the same comb - the brood in the lower section and the honey in the upper section.

In some areas, methods have been devised for removing the honey section of the comb and reattaching the brood area; thus bee-having is practiced with these bees. The yields are often high enough (especially with *A. dorsata*) to make the effort well worthwhile for the farmer.

No methods of keeping either of these bees are known which are better than those currently practiced. The behavior of both species is unpredictable, and they will not live inside a hive. The giant honey bee is especially defensive of its nest. Therefore, there is little potential for development in the management of either species, though there is often potential for improving the quality of the honey by using more care in processing.

Two other species of *Apis* (*mellifera* and *cerana*) normally build multi-comb nests in enclosed cavities. These bees can be kept in hives, and methods have been devised to allow for a more rational utilization of their potential. It is with these two species that a potential for beekeeping development exists.

The western hive bee (Apis mellifera) is native to western Asia, Europe, and Africa. There is tremendous variation in this bee across its range, and at least twenty different sub-species or "races" are recognized, broadly divided into European and African groups. Several races of this bee are considered especially desirable for beekeeping.

BEE TRAITS DESIRABLE FOR BEEKEEPING

- High honey production
- Gentleness
- Low tendency to swarm
- Low tendency to abscond
- Calm on combs when colony is worked
- Disease resistant
- Little use of propolis
- Little brood-rearing during dearth periods to conserve stores

European races of the western hive bee have been introduced into most parts of the world, including the Americas, Australia, and Asia. This bee has been studied intensely from both a strict biological and a beekeeping viewpoint. Under good conditions, desirable races build large colonies and produce large surpluses of honey. Yields of 100 kg/year or better are possible under optimum conditions.

The western honey bee offers a great potential for beekeeping development. In addition to high honey yields, its ability to survive under a wide range of conditions and its availability due to past introductions or to native populations are characteristics which have made this bee popular for beekeeping. For these reasons too, the focus of this manual is on the western hive bee.

The eastern or Indian hive bee (*Apis cerana*, formerly *A. indica*) is native to Asia. Beekeeping developed with this bee in different regions of Asia, since it can be easily hived in man-made containers. Honey yields of up to 15-20 kg/year are obtained in some areas, but the average is much lower.

There is a lot of variation in the eastern hive bee across its range, and little work has been done toward selecting more desirable strains from a beekeeping point of view. Techniques of beekeeping with this bee are similar to those used with the western hive bee, though the hives used are smaller.

Development of small-scale beekeeping with the eastern hive bee deserves attention in its native area. Although yields are considerably lower than with the western hive bee, this bee has the advantage of being well adapted to the area. It is more resistant to some of the disease and pest problems found in the area. Therefore, it is better able to survive under the minimal-management conditions which often characterize beekeeping at the small-farmer level.

In recent years, there has been an effort in Asia to replace the eastern honey bee with European races of the western honey bee. This has been successful only in temperate regions and only for large-scale, capital-intensive operations where the technology is available to control disease and parasite problems of the European races. For a small-scale development effort in this area, consider the likely beekeeping conditions in choosing a species.

In any small-scale beekeeping development effort, the existing bee resource of the area should be used. Importing bees for such a project is far riskier than it is worth.

The importation of bees is often fraught with problems. Importing bees for a small-scale project often makes the people psychologically dependent upon the outside source. They do not realize that there is a locally available bee resource, nor are they motivated to make use of it.

Imported bees often are not adapted to the areas into which they are introduced. This is especially true of introductions of temperate European races into tropical areas.

Importing bees also risks the introduction of exotic bee diseases and parasites. Tragic cases of this have occurred in recent years in Europe and South America with the introduction of Varroa, a mite parasite of the honey bee.

The most notable problem of the unguarded importation of bees occurred in Brazil in 1956. A beekeeping industry based on European races of the western bee was well-established in many areas of temperate South America. African bees were imported into Brazil in an attempt to establish an industry in some of the more tropical regions. Some of these bees accidentally escaped and became established. They have continued to expand their range in the tropical lowlands, and in most cases they have actually supplanted the existing European bees.

The establishment of African bees in tropical America has caused a great disruption of the beekeeping industry. The African bee is noted for its defensiveness and unpredictability. These are characteristics considered undesirable from a beekeeper's point of view. In some cases nearby persons and farm animals have been stung to death. Adjusting to the increased number of stinging incidents and to the difficulty of managing this bee has been difficult for beekeepers. It is usually necessary to move hives away from inhabited areas when the bees become "Africanized" by interbreeding with wild colonies.

As the African bee is adapted to live in tropical regions, wild colonies become common once the bee moves into an area. This is a benefit to small farmers who want to start beekeeping since it provides a cheap source of bees. The African bee also responds less to management operations than does the European bee; it is often more amenable to low-management beekeeping. (See Appendix A for a resource on the nature of beekeeping with the African bee.)

Climate and Beekeeping

To understand the relationship of climate to beekeeping, it is useful first to understand two concepts related to bees and their environment. These are the nectar flow and the honey flow. Although beekeepers often speak of these as being the same, they are different, though similar, concepts.

The nectar flow is totally a function of plants. It refers to both the quantity and the quality (amount of dissolved sugars) of the nectar secreted by the plant. The nectar flow in an area at a given time is dependent upon the species of plants present and the weather factors affecting those plants. Climatic and edaphic (soil) factors determine the flora of an area and thus the potential nectar flow. Rainfall, temperature, and sunlight affect the plants and thus determine the actual nectar flow.

Some plant species secrete very little if any nectar, while others secrete copious amounts. The quality, or sugar content, of nectar also varies among the different plant species. Weather also has an effect on quality. High rainfall promotes nectar secretion, but such nectar is often very low in sugar content.

For most plant species, the conditions promoting optimum nectar flow are adequate rainfall previous to flowering and dry, sunny conditions during the flowering period. The timing and relative amount of rainy and dry, sunny periods vary from year to year; thus the nectar flow can be highly variable. Some plant species are less affected by weather patterns than others. These plants can be depended upon for good nectar flows every year. Other plants are very sensitive to weather patterns. These plants may give excellent flows during some years and no flow during others.

The honey flow is a function of the bee-plant relationship. It is the use of the nectar flow by the honey bee colony. While the beekeeper can do little to affect the nectar flow, good colony management is important to insure good honey flows. Strong colonies are needed at the time of the maximum nectar flow to maximize the honey flow.

Weather conditions are also a factor in the honey flow. Good flying weather for the foragers during a good nectar flow is necessary for a good honey flow.

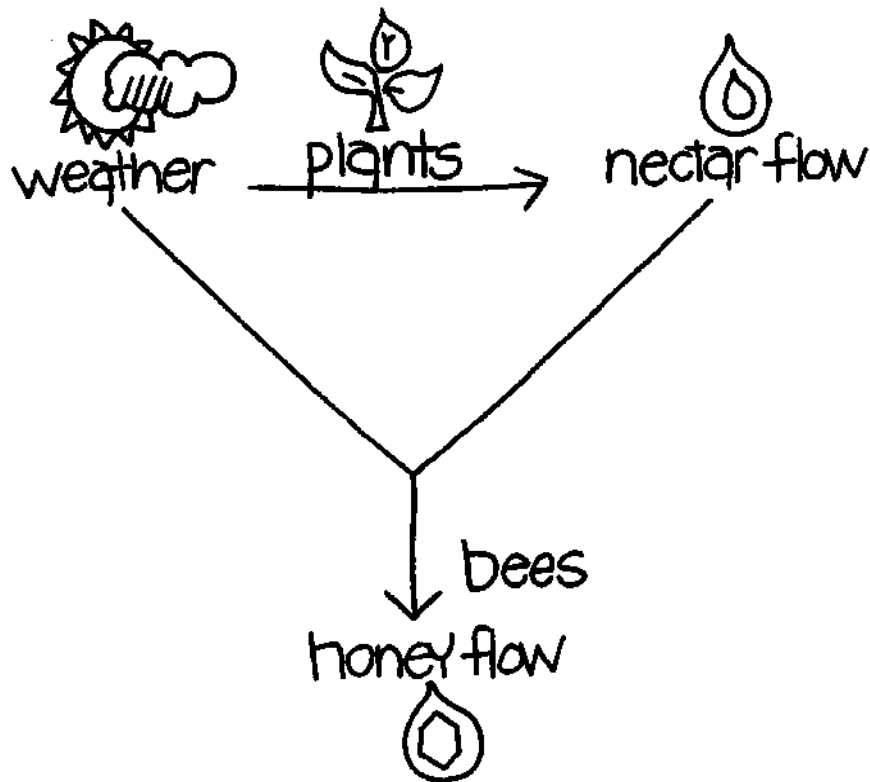

The optimum areas of the world in terms of potential honey flows are areas of deciduous forest in the wet/dry tropics. Such areas have a long dry season which allows bee colonies to build up their strength to peak population to take advantage of the maximum nectar flow. The flora of these areas is also particularly rich in melliferous (bee-attracting) plants. The dry, sunny period after the rainy season promotes a good nectar flow and provides good foraging weather. These areas can support large apiaries of up to 100 colonies with optimum yields of up to 150 kg/colony/year.

Areas with continuous cool and cloudy or rainy conditions are poorly suited for beekeeping. Nectar is usually of poor quality, and the bees have little good weather to forage in these regions. Of course, large desert regions are precluded from permanent beekeeping, even though good bee pasture may be present there for short periods during the year.

Not all plants are attractive to bees. The melliferous flora varies widely within any major climatic zone. Natural factors affect the environment, and sometimes people can alter the suitability of a region for beekeeping by their land use patterns or agricultural practices. Cutting down large areas of suitable bee forage and devoting these areas to monoculture can destroy a good bee area if the introduced crop is a poor resource for bees.

Conversely, the bee pasture of an area can be improved if marginal melliferous plants are replaced with good nectar- and pollen-producing plants. It is seldom economically feasible to make large plantings solely for improving the bee pasture, though the bee pasture of an area can be improved by selecting good melliferous plants for other primary purposes such as reforestation, windbreaks, cover crops, firewood crops, or forage crops for livestock.

Beekeeping can be carried on profitably under a wide range of nectar and honey flow conditions. These conditions figure more in determining the size and type of a profitable beekeeping operation rather than determining the profitability per se. There are many areas that would not be practical for a large-scale beekeeping venture, but would be highly suited for a small-scale project.

The planning of a small-scale beekeeping project should not put too much emphasis on bee flora. The goal of most such projects is to introduce improved methods into an existing bee-human relationship. If a bee-human relationship already exists, and the bees are producing honey, it is far more practical to assume that a bee pasture exists. It is a waste of resources to emphasize studying the region's bee flora in beginning a small-scale project.

The identification of bee flora is an integral part of the beekeeper's knowledge which is built with experience. A special study is not needed. It will be learned when there are beekeepers to observe it. The first step is to make beekeepers.

Life Cycle of the Honey Bee

The honey bee is an insect with complete metamorphosis. This means that there are four distinct stages in the life cycle - egg, larva, pupa, and adult.



Egg

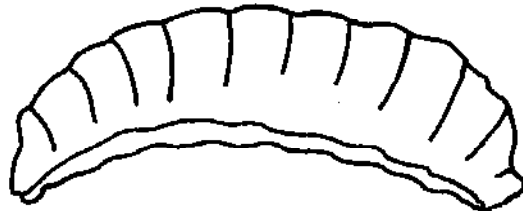

Larva



Pupa

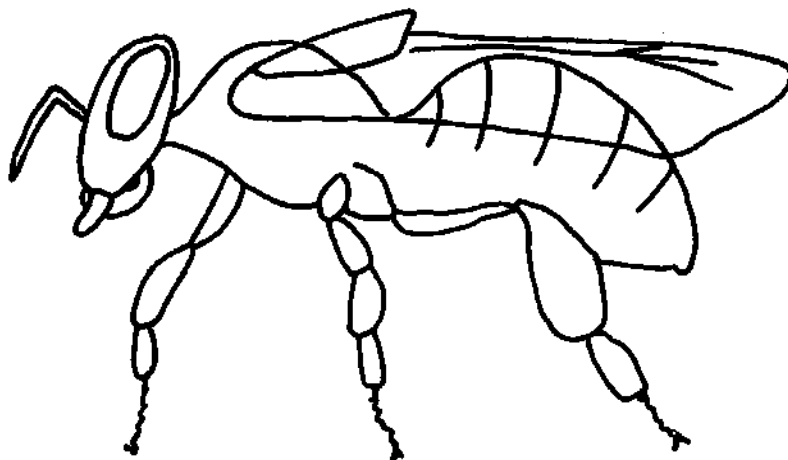

Adult

The first three stages develop in cells in the comb, and are collectively referred to as the brood. Eggs and larvae are in open cells and are cared for by adult workers. These stages are called the open or unsealed brood.

Once the egg hatches, the workers continually feed the developing larva. When the larva nears the end of the larval period, it engorges on food provided by the workers, and the workers seal the cell. This is known as the capped or sealed brood.

After the cell is sealed, the larva changes into the pupal stage. There is no feeding during this period. The pupa develops into the adult form, which emerges on its own from the cell.

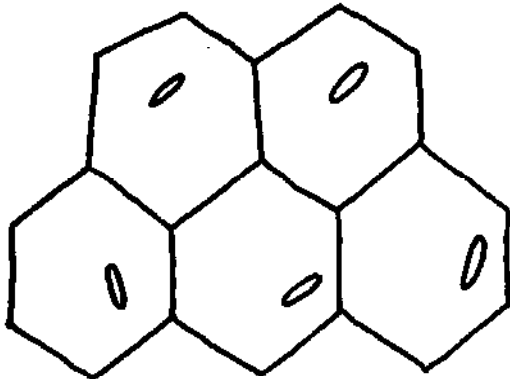

eggs

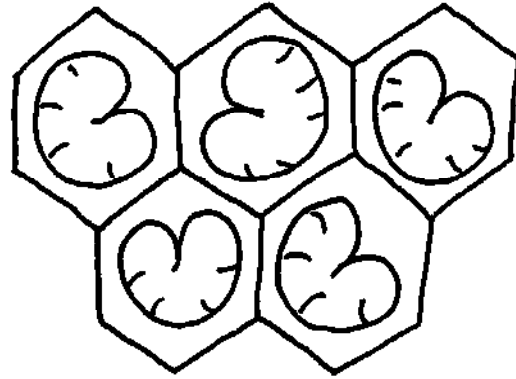

larvae

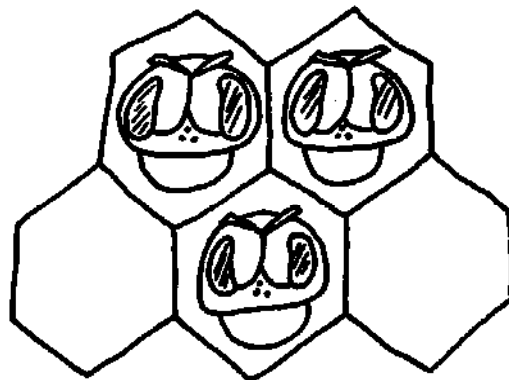

pupae (cell caps removed)

The Castes

The honey bee is a social insect with three different types of individuals or castes in the colony - queens, drones and workers. Each caste has its special function in the colony. The queen and workers are female, the drones are male.

Each caste has a different developmental time and is reared in a distinct type of cell. The developmental time of the queen, 16 days, is the shortest. She is reared in a specially constructed royal or queen cell. Queen cells appear similar to peanut shells which hang from the surface of the comb. They can be located along the edges of the comb or within the comb area. The colony constructs queen cells when there is a need to rear queens, though cells are sometimes started and then abandoned. These are called false queen cups.

The developing queen larva is always surrounded by royal jelly, a special, highly-nutritious food produced by head glands of the workers. This feeding scheme, called massive provisioning, is unique to the queen and continues throughout her entire developmental period.

All young larvae of less than two days are fed with royal jelly by the massive provisioning scheme. After the second day, worker larvae are gradually switched to a progressive feeding scheme where they are fed with a mixture of royal jelly, honey and pollen. With progressive feeding, the larvae are fed periodically, thus food is not always available to them. The different feeding schemes determine the caste of the adult bee. Thus any female egg or larva less than two days old has the potential to become either a queen or a worker.

Workers are reared in the same type of cell that is used to store honey and pollen. This type of cell makes up the majority of the comb in the colony.

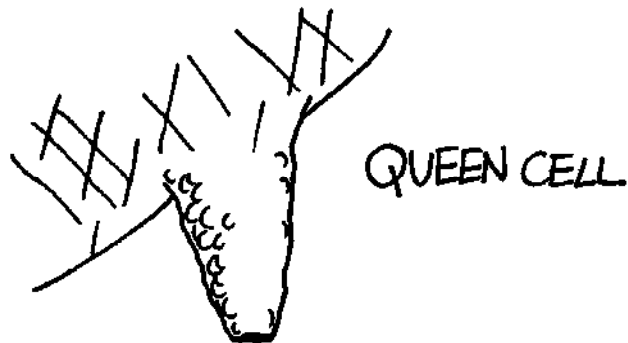

The size of the cells of naturally built (i.e. without embossed foundation) worker comb is useful for distinguishing between species and some races of Apis commonly kept in hives. The distance across ten cells of comb built by the eastern hive bee (A. cerana) in the Philippines averages 4.1 cm, and in southern India, the distance is 4.3-4.4 cm. The African races of the western hive bee build comb with measurements of 4.7-4.9 cm across ten cells, while the distance in comb constructed by common European races is 5.2-5.6 cm.

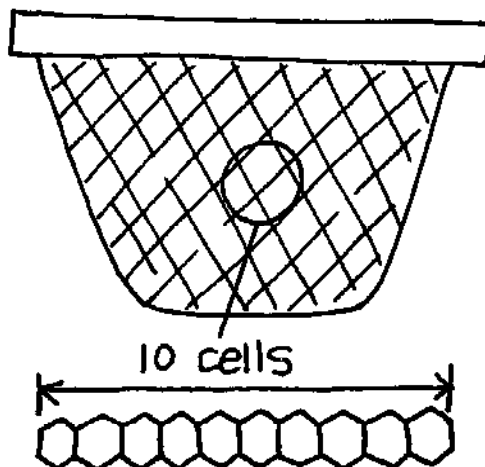

The cappings on sealed worker cells are opaque and flat. The adult worker emerges from the cell 21 days after the egg is laid.

The developmental period of drones is 23 days. Drones are reared in cells of the same shape as worker cells only larger. Drone cells are sealed with dome-shaped cappings.

The following chart summarizes the developmental periods, starting at the time the egg is laid. The figures given can vary a day or so, depending on the type (species and/or race) of honey bee, the weather conditions, or the time of year.

developmental events (days)

	<u>worker</u>	<u>queen</u>	<u>drone</u>
egg hatches after	3	3	3
cell is sealed after	9	8	10
adult emerges after	21	16	24

The queen is the only female that is completely developed sexually. This is a result of a total diet of royal jelly during a developmental period. She is distinguished by her long, slender appearance, due to the full development of the ovaries in her abdomen. She has a sting without barbs. In the colony, she is found in the area of the brood nest.

Approximately five days after emerging from her cell, the virgin queen begins to take a series of mating flights. She takes a number of such flights over a period of two to three days, and may mate with ten or more different drones. The sperm is stored in a special organ, the spermatheca, and the queen never mates again after this period.

About five days after taking her mating flights, the queen begins to lay. During favorable periods a good queen can lay more than 1500 eggs per day. Factors which affect egg laying are the weather, the nectar and pollen flows, the size of the queen, and the condition of the colony. The number of eggs laid varies with the annual cycle as available resources of nectar and pollen vary. Large amounts of incoming resources stimulate workers to give the queen more food, which in turn stimulates her to lay more eggs.

Several of the queen's glands produce a complex of compounds called the queen substance. It is distributed throughout the colony by workers that care for the queen and pass it on to other workers.

The queen substance is a combination of pheromones, chemical compounds which serve to control the behavior of other individuals of the same species. Pheromones produced by the queen and by the other individuals of the colony serve to harmonize colony behavior.

Normally, there is only one queen per colony, though sometimes two queens are present when the old queen is being superseded.

The queen can live for up to four years, but in the tropics, where the yearly laying period is longer, the queen does not live as long. Older queens do not have the laying capacity of younger queens, therefore young, vigorous queens are preferred by beekeepers. In intensive beekeeping, queens are replaced about every two years.

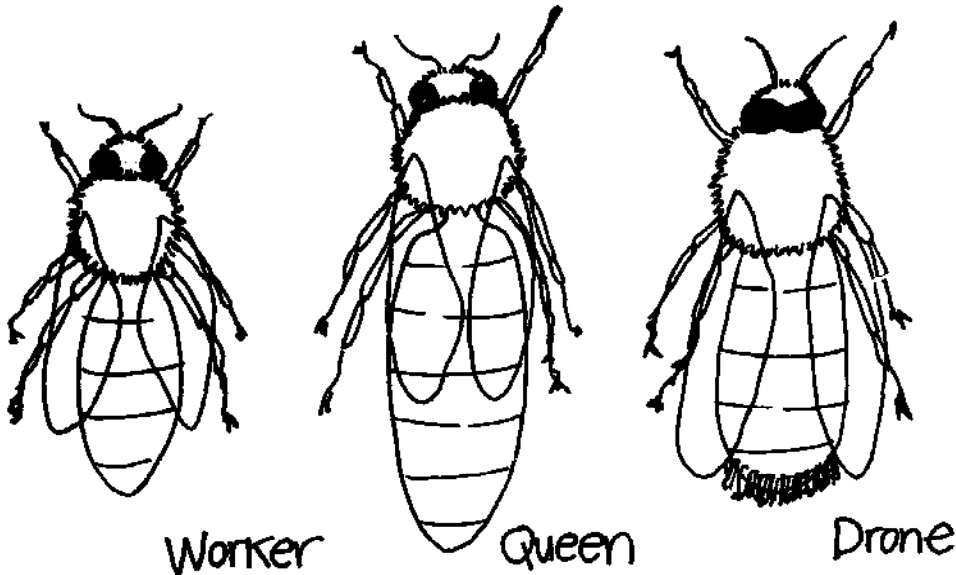

Worker

Queen

Drone

Drones, the males of the colony, are produced from unfertilized eggs. (The queen can control whether or not the egg is fertilized as she lays it.)

The body of the drone is larger than that of the worker or queen. The eyes are large and cover practically the whole head. The end of the abdomen is blunt and is covered with a tuft of small hairs.

Drones cannot sting. As the sting is a modified structure of the female genitalia, drones do not have stings. They also do not have any of the structures necessary to collect nectar and pollen.

A strong colony can have about 300 drones. But during periods when resources are scarce, the workers run the drones out of the colony. They die as they cannot fend for themselves.

The sole function of the drones is to fertilize the queen. The mating of honey bees takes place in the air away from the colony. When the weather is good, mature drones leave the colony during the afternoon and congregate in certain areas where they wait for virgin queens to fly by.

Drones sometimes return to colonies that have a virgin queen. Such colonies will accept drones from other colonies and will tolerate a large drone population while the queen is a virgin. However, after a queen mates, the workers run many of the drones out of the colony.

Workers are females which are not fully developed sexually. They do the work of the colony and maintain it in good condition. Workers have special structures and organs which are associated with the duties they perform.

structure or organ	location	function
-head glands	-front of the head	-produce brood food and royal jelly
-wax glands	-under the abdomen	-produce wax
-odor glands	-near upper tip of the abdomen	-produce scent to orientate bees when the colony is disturbed
-sting and associated glands	-tip of the abdomen	-defend the colony
-long tongue	-head	-gathers nectar
-honey stomach	-enlarged area of esophagus	-carries nectar and water
-pollen comb, press and basket	-hind legs	-comb pollen from the body, press it into pellets, and carry it to the hive. also used to carry propolis

The tasks that the adult workers perform change as they age. This is correlated with the physiological development of various glands. However, this scheme is not absolutely fixed; workers can change tasks to meet the needs of the colony.

<u>days after emergence</u>	<u>task</u>
1-2	-clean cells and warm the brood nest
3-5	-feed older larvae with honey and pollen
6-10	-feed younger larvae with products of the head glands
11-18	-ripen nectar, produce wax and construct comb
19-21	-guard and ventilate the hive - take exercise and orientation flights to learn to fly and locate the hive
22 ⁺	-forage for nectar, pollen, water or propolis

The life span of worker adults varies greatly with the time of year. During periods when the colony is relatively inactive (dearth periods), workers may live three months or more, but when the colony is active, few workers live for as long as six weeks. During these active periods, about three weeks are spent as a hive bee and the remainder as a forager. The life span of workers of tropical races of the western hive bee and the eastern hive bee is shorter.

When a colony has become queenless and there are no young larvae or female eggs from which to rear a new queen, laying workers can develop. The ovaries of some workers in the colony develop because of the absence of queen substance, and they start to lay eggs. Since workers do not have the body structure or behavior necessary to be fertilized, all of the eggs are unfertilized and thus produce drones.

Laying workers can be suspected in a colony if there is an excessive number of drones present. Close examination of brood comb can verify this. Worker cells that contain drone brood (i.e. worker cells capped with a domed cap) and cells that contain a number of eggs of varying sizes laid in a haphazard fashion confirm the presence of laying workers. A good queen lays only one egg per cell which is placed in the center of the base of the cell.

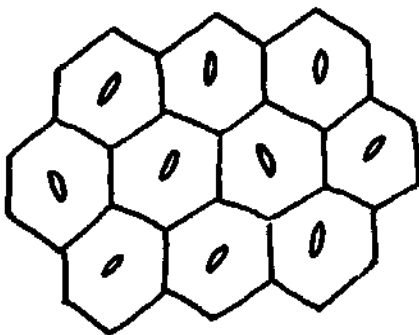

Queen-laid eggs VS.

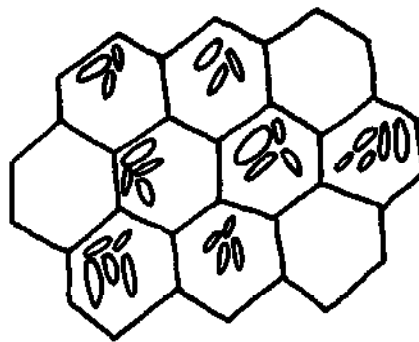

Worker-laid eggs

Resource Needs of the Colony

Foraging workers fly up to three kilometers from the colony to collect the resources needed by the colony. Of course, it is better if there are abundant resources closer to the colony. Bees will fly further than three kilometers, but this is often energy inefficient.

The four substances collected by foragers for the colony are:

- nectar
- pollen
- propolis
- water

Nectar is a sugary secretion of plants. It is commonly secreted by nectaries associated with the flowers, though some plants have nectaries located on leaves or stems. Nectar is 70% to 80% water. Higher percentages of water are found during rainy periods. The remainder is sugar and trace amounts of other organic compounds. Nectar is the carbohydrate or energy component in the diet of the bee.

Foragers take the nectar from the nectaries and carry it back to the hive in their honey stomachs. When they return to the colony, they pass the nectar to younger workers who ripen it into honey and store it in cells.

The nectar-ripening process involves evaporating the water content down to less than 19 percent and adding a small amount of enzymes. The workers do this by continually regurgitating droplets of nectar from their honey stomachs and extending the droplets from their proboscises. Increasing the surface area of the droplets in this way hastens evaporation. The action also mixes in enzymes which break down the complex sugars of the nectar into simple sugars.

Bees sometimes collect honeydew, a sugary secretion of certain insects which feed on plant sap. Honeydew is acceptable to the bees as food, but honey produced from it is dark and strong-tasting. Such honey is usually considered inferior in quality. Honeydew is more commonly collected by bees in temperate climates.

In the hive, the honey is always stored above and around the brood area of the nest. Adult bees feed on the honey, and mix it with pollen to feed older worker and drone larvae. Most colonies produce more honey than they need during good honey flows. This extra honey can be harvested. With management, the amount of extra honey can be increased. Simply removing honey stores from the colony stimulates it to produce more honey if the floral resources are available.

Pollen is a powdery substance produced by the male organs of flowers. It contains the sperm cell of the plants. Bees aid in transferring pollen from plant to plant. Such pollinating agents are very important for the cross-pollination of many plants.

Many agricultural crops are dependent on insect cross-pollination for successful seed set. These plants are often self-sterile and need to be pollinated with pollen from other plants. Such crops can benefit greatly when they are flowering by having bees nearby.

When foragers visit flowers, pollen sticks to the fine, plumose (feather-like) hairs which cover the body. Periodically, the worker removes the pollen from the hairs using the pollen comb, a structure on the hind legs. Then she forms the pollen into small pellets with the pollen press, and sticks it into the pollen basket to carry it back to the hive. The pollen press and basket are also on the hind legs.

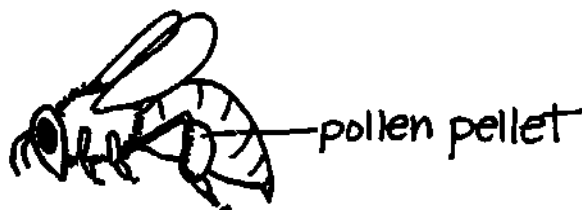

Pollen is used to feed older brood and is also eaten in large quantities by nurse bees who are producing royal jelly from the head glands. It is the protein, vitamin and mineral component in the bee diet.

Pollen is stored in cells immediately surrounding the brood nest where it is readily available for feeding brood and for consumption by the nurse bees. A complex of yeasts in the pollen acts to preserve it in a process similar to ensilaged hay.

Propolis is a resinous substance collected from plants. It is found around wounds on plants and sometimes around buds. Bees use it to seal small cracks and holes in the colony, for reinforcing and repairing old comb, and for covering dead animals in the colony which are too big to be removed.

Propolis contains chemicals called turpines which act to limit bacterial and fungal growth. Therefore it serves to help control bacteria and fungi in the colony environment. It is collected by foragers and carried to the hive in the pollen baskets.

Water is mixed with honey before the bees eat it or feed it to the brood. Bees also use water to cool the hive on hot days. When it is hot, many foragers are busy collecting water. The water is placed in small droplets around the hive, and air currents are set up by bees which stand in the colony and fan their wings. The colony temperature is lowered by evaporative cooling.

Water is carried to the colony in the honey stomachs of the foragers. A nearby source of fresh water is helpful to a bee colony. This minimizes the effort needed to satisfy the water requirements of the hive, and allows the colony to devote more effort to foraging for nectar and pollen. If no natural sources of water are available nearby, the beekeeper can profit by providing a water supply in the apiary.

Swarming, Supersedure, and Absconding

Swarming is natural colony division or reproduction. When a colony has reached a large size and there are abundant resources available, the workers will construct queen cells. These queen cells or swarm cells are usually located around the edges of the comb.

A few days before the first virgin queen emerges, the old queen leaves the colony followed by part of the workers and drones. The queen usually lands nearby and the other bees cluster around her. Scouts leave from the cluster in search of suitable nesting sites. Within a few days, the cluster usually leaves and moves to a site where it establishes a permanent nest.

The first queen that emerges in the old colony searches out other queen cells and destroys them. If two or more queens emerge at the same time, they will fight until one kills the other.

Sometimes, if the colony still has a large population, a recently emerged queen will leave the colony with a number of workers instead of destroying the other queen cells. This is called an afterswarm. It is similar to the original swarm except it is smaller and the queen is a virgin. A colony sometimes afterswarms several times.

Supersedure is queen replacement without colony division. If the old queen begins to fail, workers will construct queen cells to rear a replacement. These supersedure cells are usually located on the face areas of the comb. The old queen does not leave the colony in supersedure. The new queen mates, returns to the colony, and begins to lay.

After supersedure, it is not uncommon to find both the old queen and the new queen together in the same colony. They are not competing, therefore they tolerate each other. The old queen can be distinguished by her tattered wings and her abdomen, which is worn of hairs. She dies soon after the new queen has started laying.

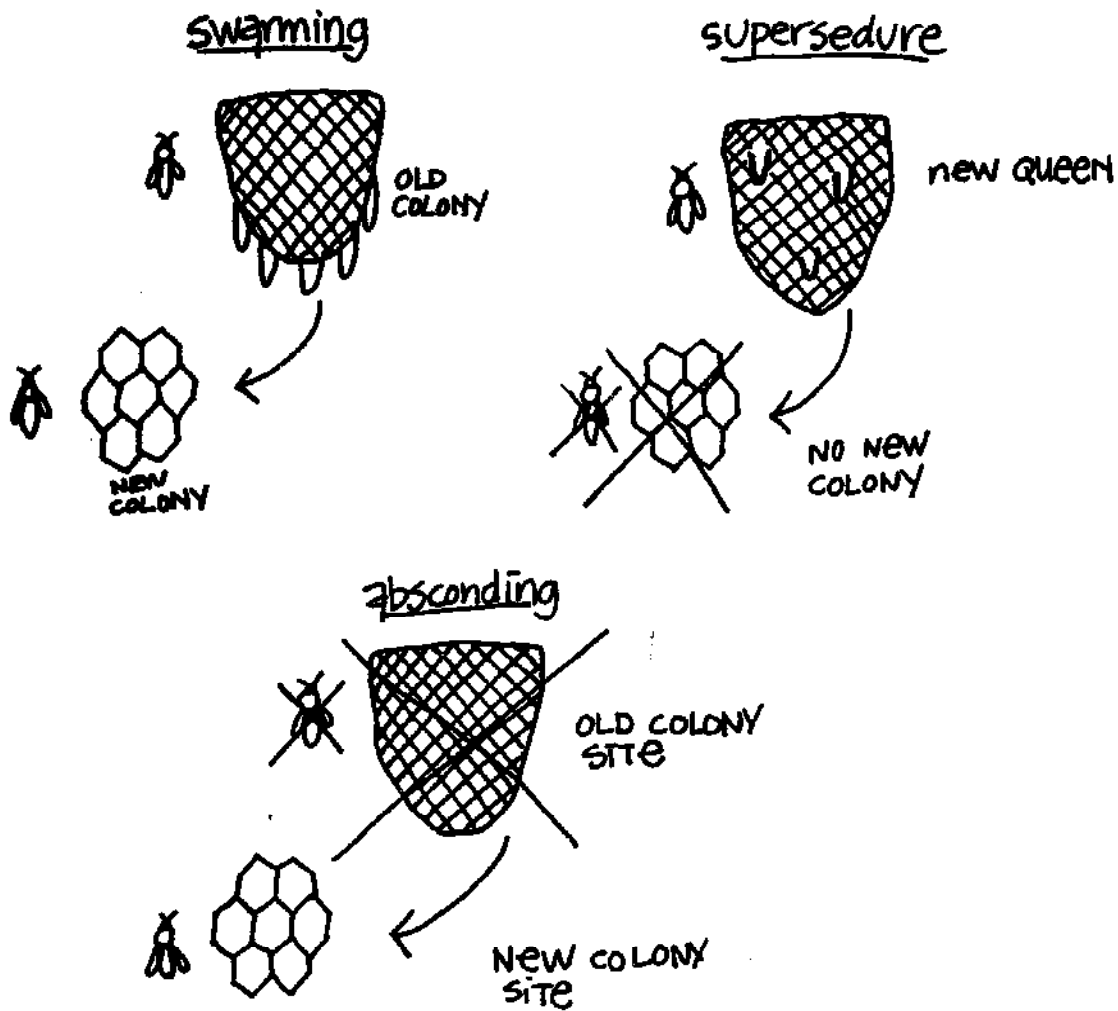

Swarm cells are on the edge of the comb.
Supersedure cells are on the face of the comb.

Absconding is the abandonment of a nest site by a colony. It is usually due to excessive disturbance of the colony by predators or beekeepers, or to diminishing resources in an area. Absconding is more common in tropical species and races of the honey bee.

This background information on the basics of honey bee biology is necessary in order to understand the nature of beekeeping and the principles of hive management. Optimum hive management can only be achieved with a good understanding of bee biology. Your knowledge of bee biology will never stop growing once you start working with bees. As with everything else, experience is the best teacher.

Helping beginning beekeepers to build a knowledge of bee biology is often a slow and difficult process in development projects. Abstract discussions, lectures, and extension material often mean nothing to persons whose learning has not been geared to such media. They need to see the thing for themselves. Actual demonstration is often the most effective teaching method in these situations.

Questioning and listening on the part of the teacher are also important. You need to learn how bees and their relationship with the environment are viewed by the target group of a bee project. You need to learn what the target group already knows.

Folk wisdom on bees is based on the bee-environment relationship as it is perceived and observed by those in the community. Often such folk wisdom is correct vis-a-vis bee biology even though the fancy words are lacking.

By finding out the local folk wisdom on bees, the person trying to teach improved beekeeping methods can reinforce what is correct and seek to change what is misunderstood. Seeking to understand and respecting the local folk wisdom will greatly increase your credibility.

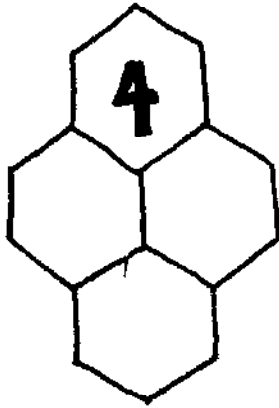

The Essence of Beekeeping *

Beekeeping follows seasonal cycles. This is important for beekeepers to understand. In tropical regions, it is more difficult to note the seasonal cycles since there is no period when the colony is totally inactive.

The yearly colony cycle can be broken into three periods: build-up, honey flow, and dearth. In temperate regions, these periods are usually well-defined, with only one of each period per year. In the tropics and subtropics, however, the periods are variable, and more than one of each can occur in a yearly colony cycle.

* Part of this material is adapted with permission from The essence of beekeeping, presented in note form by S.C. Jay in Bee World, Vol. 60: pp 140-142. 1979.

The flowering of plants, and, more importantly, nectar flows, are influenced by seasonal weather patterns. The honey bee colony responds to these changes. When resources of both pollen and nectar are plentiful, the colony is stimulated to raise more brood and thus the colony population increases. When resources are low, brood-rearing decreases, and the colony population decreases.

BUILD-UP PERIOD

pollen and nectar → brood rearing → colony population
resources increase increases increases

DEARTH PERIOD

pollen and nectar → brood rearing → colony population
resources decrease decreases decreases

Both pollen and nectar are necessary to stimulate brood-rearing. If only one is available, the colony reduces brood-rearing and stores the incoming resource. Stored provisions are used to maintain brood-rearing, but they do not stimulate increased brood-rearing.

For a high level of brood-rearing, a large quantity of incoming resources is needed. Depending on incoming resources, the workers vary the amount of food given the queen. This determines her egg-laying rate. Workers also eat eggs or young larvae to control the amount of brood reared in times of reduced resources.

Colonies with small populations emphasize brood rearing over honey storage. Such colonies tend to use most of their incoming resources to produce bees and to build comb. They have a high brood-to-adult-bee ratio; therefore many adult bees are needed in the hive to care for the brood and maintain the brood nest temperature.

As colonies grow in population, the ratio of brood to adults decreases. After a certain point of population growth (about 40,000 with European bees under temperate conditions), the rate at which the queen lays eggs also decreases. More bees are freed from duties in the hive to become foragers. The colony then shifts its emphasis to honey storage.

Beekeeping includes understanding the seasonal colony cycle and managing the colonies in such a way as to obtain a large adult colony population to coincide with the major nectar flow in an area. Success in this results in the maximum honey flow for the beekeeper.

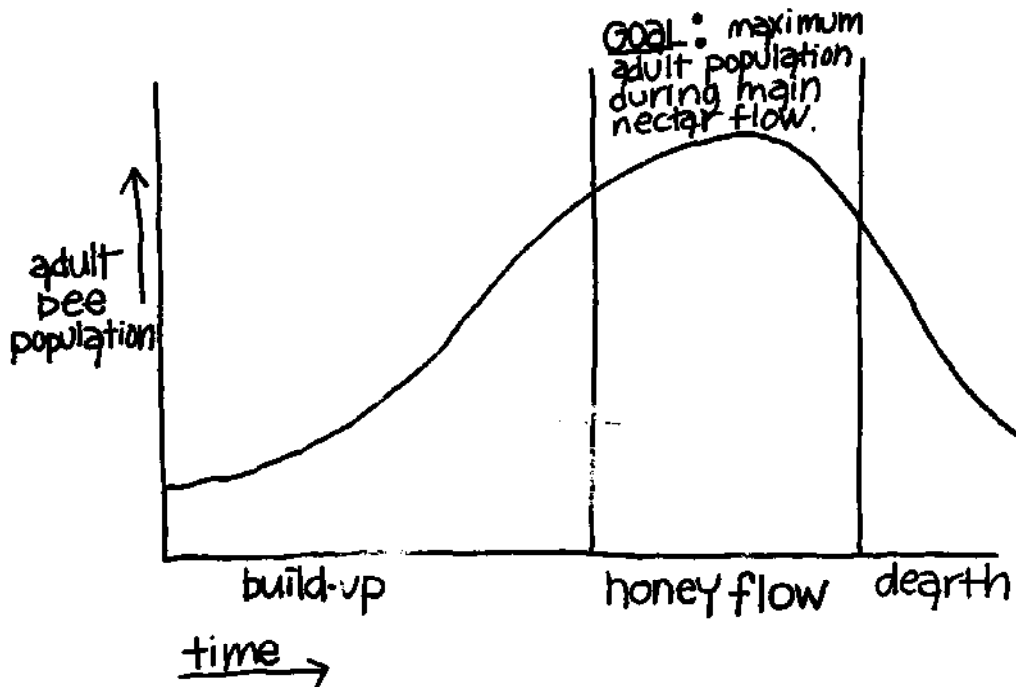

By having the maximum adult population during the time of the major nectar flow, the beekeeper can take best advantage of the flow. However, such conditions are also prime for swarming. A colony that swarms just before a major nectar flow usually produces no surplus honey on that flow. Rather, as the colony population is lowered by swarming, the colony uses the flow to rebuild its population. Therefore good beekeeping calls for maintaining colonies in potential swarming condition, yet controlling swarming through management practices. It is impossible to prevent all swarming, but with management it can be minimized or controlled.

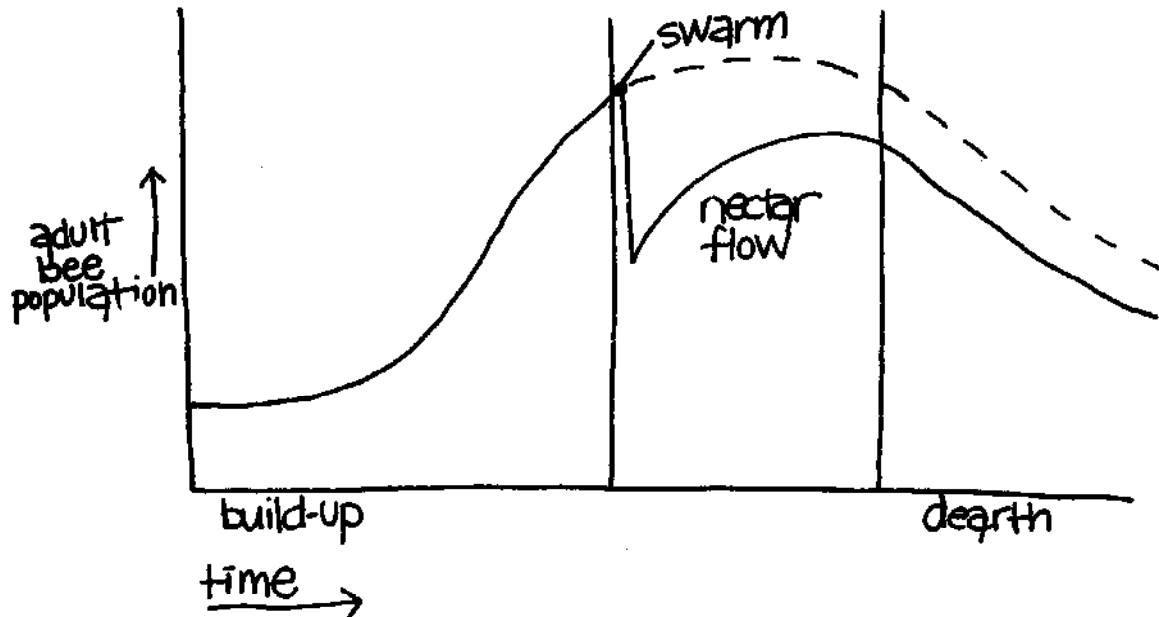

Strong colonies are also important for beekeepers who are interested in using their colonies to pollinate certain crops. For this, it is desirable to have colonies that are strong yet still building up their population toward its peak when the crop is in bloom. As there is a lot of brood-rearing in such colonies, there is a big demand in the colony for pollen. Therefore the bees will be more likely to visit the desired crop.

* * * * *

Nectar flows are generally more predictable in temperate regions. There is usually one main flow of a sequence of plant sources which lasts for several weeks, normally in late spring and early summer.

In tropical and subtropical regions there is often one main flow with several lesser flows. The beekeeper is primarily interested in the main flow, which often follows the heavy rainy period, or may come after the initial rains following a long dry period. However, it is harder to predict flows in these regions. The beginning and end of rainy periods is often highly variable from year to year.

The relative unpredictability of nectar flows in the tropics and subtropics makes it more difficult for the beekeeper to prepare the colonies.

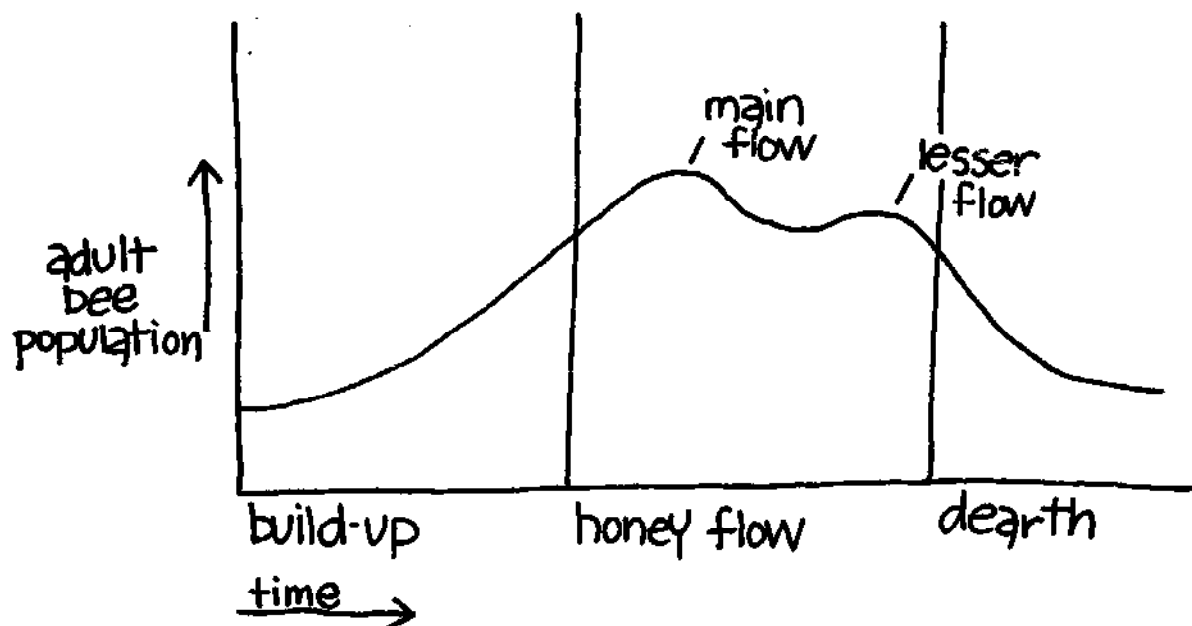

To achieve maximum honey flow, colonies should build up before the main nectar flow, not during it. Colonies that build up their peak population on the main nectar flow usually produce little surplus honey for the beekeeper. Since it takes about six weeks for an egg to develop into a foraging adult, the preparation of colony populations for a main flow must start six to eight weeks beforehand.

* * * * *

In temperate regions the dearth period is associated with cold and a total absence of resources for the bee colony. The bees form a tight winter cluster to conserve metabolic heat, and pass the period living from stores in the hive. Brood-rearing usually ceases for a period.

In warm climates there is never an absolute absence of resources, and there is some suitable flying weather for the bees throughout the year. The dearth period in these regions is often associated with heavy rainy periods when there is less flowering, nectar quality is low (low sugar content), and flying weather is poor. Pollen resources are sometimes plentiful during nectar dearths. Brood-rearing is reduced during dearth periods, but it seldom ceases in strong colonies in the tropics and subtropics.

The different character of the dearth period is a major difference between beekeeping in temperate regions and that in warmer regions. During dearth periods in the tropics and subtropics, the colony remains active.

* * * * *

Management Schemes

Honey bee colony growth and well-being are dependent upon:

- the queen's capacity to lay eggs;
- the supporting worker population's ability to maintain favorable temperatures in the brood nest and to feed the brood (i.e. size and age structure of worker population);
- availability of nectar (or honey stores during the dearth period) and pollen;
- space in the proper section of the hive for expansion of the brood nest and storage of honey.*

Management schemes in beekeeping have the objective of enhancing or improving upon these factors. The level of sophistication of a beekeeping operation determines the extent to which management operations can affect these factors.

In high-tech beekeeping, genetically-selected queens can be used, colonies can be fed sugar syrup and pollen supplements, and colonies can be moved seasonally to follow nectar flows (migratory beekeeping). Such inputs and schemes are often not available for a small-scale beekeeping venture or they are impractical because of cost.

For small farmers, the most practical management schemes are those that do not call for expensive inputs. Labor is usually the cheapest input available to these beekeepers. Management aimed at ensuring sufficient stores for the colony and providing proper space is only dependent on labor input.

Management practices which ensure sufficient honey stores in the hive for the dearth period only call for recognizing its importance. No extra effort or labor is required. However, this is probably the most neglected aspect of bee management (thus the most costly). The beekeeper is all too often the worst enemy of the bees.

*Productive management of honey bee colonies, C.L. Farrar, American Bee Journal, vol. 108, nos. 3-10. 1968.

The temptation to remove all of the honey at the end of the honey flow period is often too great for the beekeeper. Removing and selling honey often gives immediate gains; leaving it on the colony for the bees' use during the dearth periods is an investment in the future, or a deferred gain.

A sufficient amount of honey left on a colony for the dearth period assures that it will survive the period and be in good shape at the beginning of the next build-up period. Without sufficient stores, the colony may starve to death or may become so weak that it succumbs to predators.

Beekeeping which neglects this aspect of management could be called "accordion" beekeeping. The beekeeper spends each build-up and honey flow period in increasing the number of colonies only to lose most of them in the following dearth period. The accordion beekeeper goes back and forth between a large number and a small number of colonies.

The other management scheme most practical to small-scale beekeeping ventures is hive manipulation. This is management to increase or reduce space in the colony when and where it is needed.

Not only does the colony need extra space to store honey during the flow, but space is also needed to expand the brood nest during the build-up period. The bees themselves expand the area for the brood nest by using the pollen and honey around the periphery of the brood area. This frees these cells for the queen to lay in, but expanding the brood nest in this manner is a slow process for the colony and can restrict the laying of the queen. When this happens, the colony is said to be "honey-bound" as the brood nest is bounded or restricted by honey. A honey-bound brood nest is a major factor in stimulating swarming.

By exchanging the combs filled with honey on the edge of the brood nest with empty combs, the beekeeper can alleviate the honey-bound condition more quickly than the bees themselves can. This gives the queen more room to lay, and the colony builds up to a high population faster.

During the dearth period, on the other hand, the colony needs less space since the bee population is decreasing. The beekeeper should remove the unused space or combs in the hive. This compacts the colony and permits the bees to defend the colony better against predators.

In manipulating the hive to create or reduce space, it is important to remember that good beekeeping involves understanding the yearly colony cycle and carrying out management operations at the right time. A given hive manipulation made at the appropriate time in the cycle can be foolproof in giving the desired results. The same manipulation made at the inappropriate time is often doomed to failure.

good beekeeping =

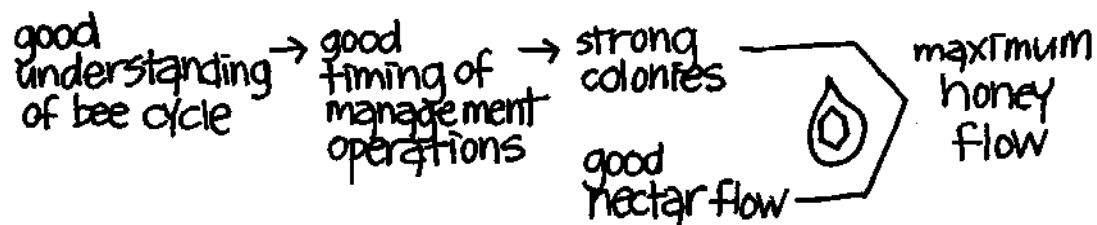

Understanding the colony cycle and the appropriate time to make hive manipulations grows out of beekeeping experience. It is the art of beekeeping.

There are three basic management problems that beekeepers face in any situation. These are:

- determining when the main nectar flow occurs;
- building up colony populations in preparation for the main nectar flow;
- deciding what to do with colonies during the post-flow (or dearth) periods.

Determining when the main nectar flow occurs is based on experience in an area. It calls for the beekeeper to observe the bees and their environment. Recognizing the main nectar flow is an outgrowth of a good understanding of bees and their relationship with their environment.

The following are aids to determining when the main nectar flow occurs. Most are not one-time things to be done before starting in beekeeping, but are ongoing observations to be made as one practices beekeeping.

- Make surveys to identify the major nectar and pollen plants of the area. Note which plants the bees visit, especially those visited in large numbers.
- Make surveys to record the flowering periods of these plants. Note weather conditions (previous and present) which are conducive to good nectar flows from these plants.
- Make seasonal records of the weight gains and losses of a few colonies kept on scales.
- Note farming practices (crops, land use, etc.) in the area.
- Examine weather records, soil data, and altitudinal variation of the area. Relate this to the flora and to the nectar flow.
- Talk with others in the area who are involved with bees. "Oldtimers" in the area often have an astute sense of the cycle of nectar flows.

Timing of management operations is critical in building up colony populations in preparation for the main nectar flow. Even though bees naturally build up their population during periods when resources are available, the beekeeper must ensure that peak population is reached before or during the nectar flow, not after it.

Specific management points which call for careful attention during this period are:

- queenrightness (the presence of the queen) and the queen performance of each colony;
- siting of the apiary (an apiary is a group of bee hives; it is also called a beeyard);
- hive arrangement within the apiary to prevent drifting and robbing problems and to facilitate work in the apiary (with drifting, foragers return to the wrong colony; with robbing, strong colonies take honey from weaker ones);
- feeding methods and types of food (this is usually not relevant to small-scale projects);
- control of diseases and pests;
- swarm prevention;
- provision of adequate space in the hive for brood and for nectar.

These will be discussed in detail in later chapters.

The post-flow care of colonies is crucial to success in beekeeping. It often receives the least attention because returns from care given during the dearth period often seem remote to the beekeeper. This is especially true with subsistence farmers whose existence and reality are based on the present.

Nonetheless, it is important to remember that this year's honey crop is made on last year's post-flow care.

The options for post-flow care are to:

- ignore the colonies--the least desirable alternative, though unfortunately often the most common practice (especially among small farmers);
- use surplus bees to increase the number of colonies;
- kill off colonies (this is only practical in areas with severe winters, and where "package" bees are readily available);
- use bees to build comb for future use (this involves feeding sugar syrup, which is usually prohibitive among small farmers);

In temperate regions:

- reduce the number of colonies for overwintering by killing or combining weak colonies;
- overwinter the colonies where they are, move them to another more protected outdoor site, or overwinter them indoors.

In the tropics and subtropics:

- maintain colonies at reduced populations.

The essence of development is better utilization of the given resources. The essence of beekeeping development is better utilization of the bee and melliferous flora (bee plant) resource.

Every apiary has its limit of colonies given the bee flora resources of the area; every beekeeper has a limit on amount of time to care for the colonies. Good beekeeping logically seeks to take advantage of the melliferous flora of the area with the least number of well-managed colonies. As stronger colonies produce more surplus honey, such a strategy minimizes the cost of equipment and reduces labor while increasing honey yields.



many poorly-managed colonies = weak colonies = less honey 

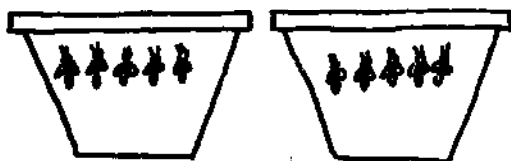

fewer well-managed colonies = strong colonies = more honey 

Good beekeepers understand bees,
recognize the needs of the colony,
and take measures to meet those needs.

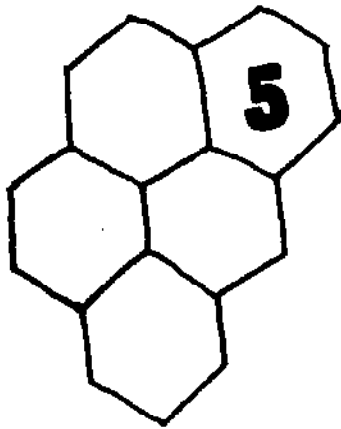

The Bee Space and Beehives

Bees usually build their nests in a cavity, attaching the combs to the upper part. The nest sites or hives of feral colonies are often inaccessible to the person wanting to gather honey. Even if a colony is accessible, it is usually necessary to destroy both the cavity and the combs to gather the hive products.

Beekeeping implies management of the honey bee colony. Management of the hive itself is based on manipulating the combs to inspect the condition or to adjust the space needs of the colony. Therefore, a practical system which allows for easy removal and replacement of combs without destroying them is a prerequisite for beekeeping.

An understanding of the "bee space" permits the building of hives which allow for the removal and replacement of combs. This also allows for the construction of hives which separate the brood nest from the honey stores, permitting separate access to each area.

The Bee Space:

the basis for beekeeping

The bee space is simply the crawl space needed by a bee to pass easily between two structures (7.5 mm \pm 1.5 mm for the western hive bee, less for the eastern hive bee). If the space between any two surfaces in the hive is too small for a bee to pass through easily, the bees will seal it with propolis. If the space is larger than a bee needs to pass through easily, the bees will construct comb in the area.

When the space between two surfaces in the hive is the right size, the bees will leave it free as a crawl space. If the bee space is considered and respected in the construction of a hive, a hive that allows for easy comb removal and replacement will result.

The Rev. Lorenzo Langstroth of Philadelphia was the first person to make use of the bee space in hive construction. He constructed the first modern hive in 1851, using moveable frames to contain the comb within the hive. The modern frame hive currently used for "high-tech" beekeeping is still sometimes referred to as the Langstroth hive.

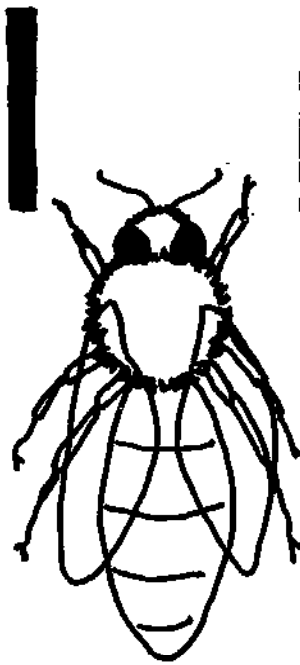

large space =
space filled
with
comb



small space =
space sealed
with
propolis

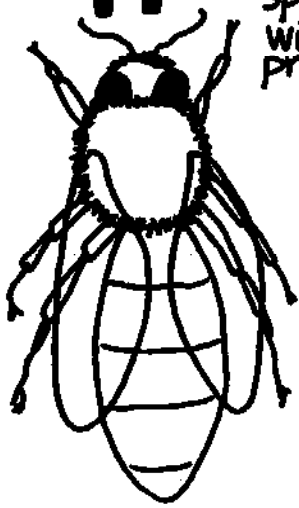

bee space =
space
respected

Types of Hives

Fixed-comb hives are no more than man-made cavities. These can be hollowed-out logs, bark cylinders, clay pots, wooden boxes, baskets of straw, bamboo, or wicker, mud-plastered wicker containers, or discarded metal cans or drums. In some areas, cavities for bees are carved in the mud walls of houses or in nearby earthen embankments.

In fixed-comb hives, the bees attach the combs directly to the upper surfaces of the hive and usually to the sides. The bees naturally leave the bee space between the combs as they construct them.

Combs can be removed from such hives only by cutting them out, and it is not practical to replace them. Thus beekeeping is impossible with fixed-comb hives. These hives allow only for bee-killing or bee-having.

Advantages of fixed-comb hives:

- Materials for their construction are usually readily available and they are cheap (free).
- Beeswax production is relatively high. (There is a ready local market for beeswax in some areas.)
- They are traditional, and methods are established for working with them.

Disadvantages of fixed-comb hives:

- It is impossible to remove combs and replace them--thus examination of the colony condition and hive manipulations are impossible.
- Swarming is often common because of limited space.
- Brood is often lost in harvesting honey.
- Honey production is hindered.
- Honey quality is usually low because it comes from old comb or is mixed with pollen, brood, or ashes.

Moveable-comb hives have a series of bars across the top which allow for attachment of the comb. These bars are spaced to give the bees sufficient room to build a comb centered on each bar and to leave a bee space between combs.

Such hives can be constructed of many materials, including straw, bamboo, mud-plastered baskets, metal, or wood. Wood is the best material for the top bars. The width of the top bars is the only critical dimension in this type of hive.

Ideally, the sides of a moveable-comb hive should slope about 120 degrees. This slope basically follows the curve of naturally built comb; therefore it minimizes comb attachment to the sides of the hive. This makes it easier to remove the combs without breakage.

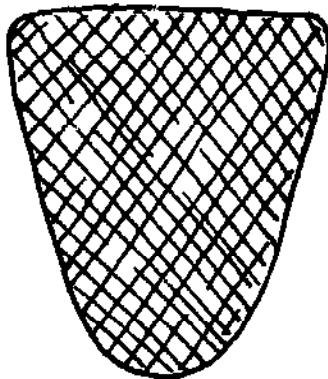

natural comb

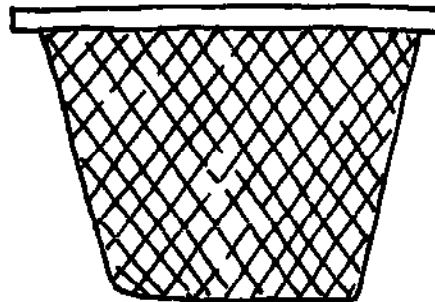

top bar with comb

If the sides are not sloped (and sometimes even with sloped sides), the bees will attach newly constructed comb to the sides of the hive. If the attachment is cut several times as the comb becomes older and propolized, the bees will cease attaching it. The remnants must be scraped off the sides of the hive each time a comb is cut out. This requires diligence and care from the beekeeper, especially when the colony is building up.

Moveable-comb hives offer a logical intermediate step between fixed-comb hives and moveable-frame (Langstroth) hives. Moveable-comb hives are often called transitional hives or intermediate technology hives. They offer a beekeeping technology that is within the technological and economic reach of most bee-killers and bee-havers who are currently using fixed-comb hives.

Advantages of moveable-comb hives:

- The combs are removeable and can be replaced without destroying them. Thus, beekeeping is possible. Swarming can be controlled, and colonies can be easily increased with simple queen-rearing methods.
- They are easier to construct because they have fewer areas where critical dimensions are important.
- They can be easily made of materials which are readily available to the small farmer. Thus, they are more economical than Langstroth-type hives.
- They offer a cheap and intermediate alternative to beekeeping for bee-killers and bee-havers who are using fixed-comb hives.
- They do not require foundation to guide the construction of comb within the frame to achieve their optimum returns.
- Beeswax production is relatively high.
- Honey can be harvested from new comb. Thus higher-quality honey can be produced.
- The top bars can be constructed so that they meet, leaving no openings along the top of the hive. This makes it easier to work with more defensive strains of bees.

Disadvantages of moveable-comb hives:

- The combs are attached only to the top bars, Thus, it is difficult to move the colonies without breaking the combs. Also, care must be used when removing combs and inspecting them.
- Since the combs are attached to the top part of the hive, the colony can only expand in a horizontal plane. This somewhat limits the expansion of the brood nest, as the natural tendency of bees is to increase the brood nest in an upward direction (vertically). (This is a negligible disadvantage in a beginning small-scale project since intensive management is rare.)

Moveable-frame or Langstroth hives are the hives used in modern "high-tech" beekeeping. In these hives, the bees construct comb in frames which contain an embossed sheet of beeswax foundation. The foundation serves as a "pattern" to ensure straight, centered combs in the frames.

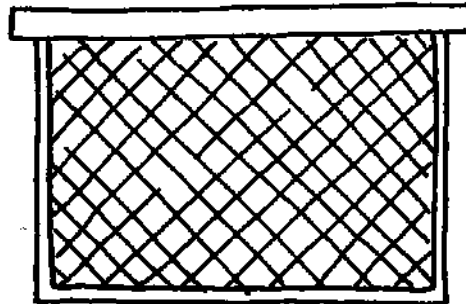

frame with comb

These hives are constructed so that there is a bee space between the frames themselves and between the frames and the box holding them. Such intricate construction demands relatively good quality wood and expertise in carpentry.

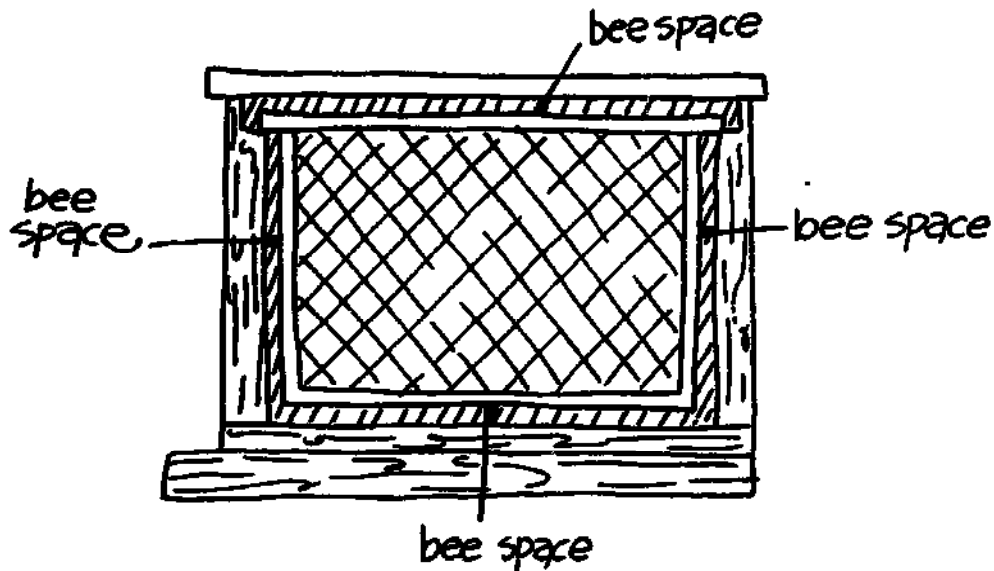

Since there is a bee space between the tops of the frames which allows the bees to pass, several boxes of frames are used to form one hive. Usually two boxes or "hive bodies" are used to make up the brood chamber. Boxes stacked on top of these are called supers, and are used for honey storage. The construction of these boxes is identical. The different names come from their relative position on the hive and thus their function.

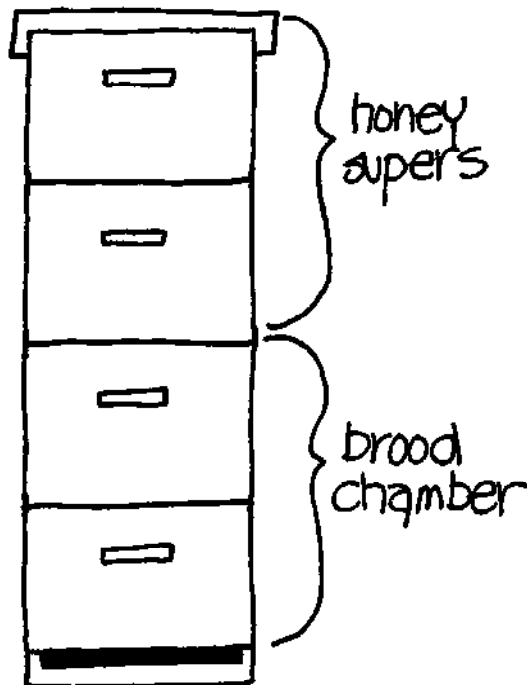

These hives permit the ultimate in manipulation and interchanging of comb. Not only can frames be interchanged, but so can boxes. Such a system permits a high level of management or "high-tech" beekeeping.

Advantages of moveable-frame hives:

- Combs can be easily removed, inspected, and interchanged since they are built in frames.
- Combs containing honey can be removed, the honey centrifuged from the combs, and the empty combs returned to the colony. This enhances honey production as the bees do not have to construct new comb.
- As only honey combs are removed and extracted, honey quality is high.
- The combs are securely attached to the frame. Less care is needed when removing and inspecting combs, and the colonies can be moved with little comb breakage. This permits migratory beekeeping or the moving of colonies to take advantage of nectar flows in different areas.
- Space in the hive can be increased in a vertical plane by adding supers. This enhances the natural tendency of the bees to expand the nest in an upward direction.
- They can be easily used to produce pollen or for the mass rearing of queens.

Disadvantages of moveable-frame hives:

- They require relatively good quality wood and expertise in carpentry to build; thus, they are expensive.
- For their optimum return, they require comb foundation and a honey extractor. These are expensive, and are often difficult to obtain.
- For their optimum return, they require much expertise in beekeeping.
- There are numerous bee spaces between the top bars of the frames. This makes it difficult to control highly defensive strains of bees.



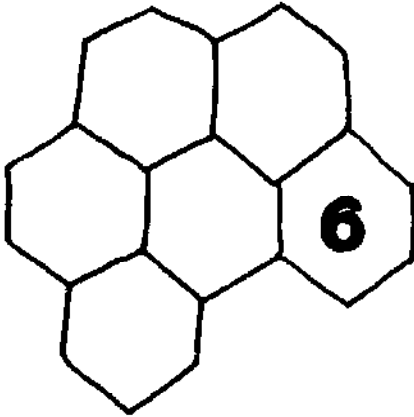

Intermediate Technology Beekeeping

Why?

The modern moveable-frame hive maximizes honey production. It is a beekeeping system that allows for the interchanging of combs both within and between colonies. It offers a wide range of management options, but it is relatively expensive. Moreover, its optimum utilization depends on inputs that are often difficult for small farmers to obtain.

To fully exploit the range of management options and to realize the potential production of a moveable-frame system, a relatively high degree of expertise or experience and timing are needed.

Small-scale beekeeping projects are sometimes started with moveable-frame hives but without readily available follow-up inputs or technical assistance. This can result in the situation where a relatively high investment is made in equipment which allows for a high return, but the technical ability to operate this equipment and realize its potential is lacking.

Economically speaking, a cheaper and simpler system would be better. Such an alternative may not allow for some sophisticated management options, but this does not matter if the beekeeper does not know of or use such management techniques. This is the essence of appropriate technology.

Intermediate technology beekeeping systems offer a cheap system for bee-killers and bee-havers who use fixed-comb hives to make the transition to beekeeping. They provide a relatively simple beekeeping system that is more within the economic and technical reach of most small-scale projects, while still allowing the user to employ the most current beekeeping knowledge. Most intermediate systems sacrifice some honey production for wax production, but wax too is a valuable product.

These beekeeping systems give the user more control over the construction of the hive and limit the need for other equipment. Intermediate technology hives give small farmers an affordable opportunity to learn about bees and beekeeping and to develop the needed expertise and capital to make use of a moveable-frame system later.

The use of an intermediate technology system in a beekeeping development program is not incompatible with "high-tech" beekeeping. Both have their place. It is the job of the program planner to determine the nature of the bee-human relationship and the cultural and economic realities of the area. From this, the planner can suggest the type of equipment to use in the program. In some areas, the use of both types may be justified. The beekeepers themselves should make the final decision.

The moveable-frame system ("high-tech" beekeeping) is the ultimate in beekeeping development. Nevertheless, such a system will remain economically and technologically out of reach of many people who might like to improve their methods of honey or wax production. Until they accrue the necessary capital and expertise to engage in beekeeping with moveable-frame equipment, an intermediate technology system can serve their needs.

Some Considerations before Starting

Bee stings are a concern of all beekeepers. Although they can be minimized by protective clothing and good work habits, an occasional sting is inevitable. Accepting this is part of the mental attitude which characterizes a beekeeper. Most people from rural settings who work with bees are more accepting of the idea that they will get stung than the development worker who comes from a "bug-free" urban environment.

Avoid perfumes and scented lotions when working with bees. Strong scents attract bees and incite them to sting.

Slow, careful, deliberate movements when working with the colonies are also important in minimizing bee stings. Bees are more attracted to quick movements. Working carefully when manipulating the hive also minimizes the risk of mashed bees. Mashed bees release an alarm pheromone or odor which alerts and incites other workers to defend the colony. (Using the smoker properly helps mask the alarm pheromone. See page 89.)

If a colony becomes out of control while working it, close it up as quickly as possible and move away. If the bees give chase, create a smoke cloud with the smoker and move slowly away through bushes and branches. Moving through these objects confuses the bees.

When a bee gets inside the veil or inside clothing, the best remedy is to mash it as quickly as possible before it can sting. Trying to release it usually leads to getting stung anyway.

Bees sometimes sting through clothing, especially where it is pulled tightly around the shoulders. Such a sting rarely has the full effect, and is called a "false sting."

When a worker bee stings, the barbed sting works its way into the victim. As the bee pulls away, the sting apparatus usually tears out of the bee's body. This apparatus consists of the sting, the poison sac, and associated venom glands. The worker ultimately dies. The muscles associated with the poison sac continue to contract and pump venom into the victim after the worker has pulled away. Therefore to minimize the amount of venom injected, remove the sting as soon as possible.



Remove the sting by scraping it out along the surface of the skin with a fingernail, knife, or hive tool. Grasping the poison sac to pull the sting out only forces more venom into the skin. A puff of smoke over the area will help mask the alarm pheromone released by the sting apparatus.

Remain calm when stung. Dropping the comb or knocking the hive only incites more bees to sting.

Local tenderness and swelling is a normal reaction after a bee sting. Swelling may be rather severe if the person has not been stung for a while. Swelling usually becomes less severe as the beekeeper's body develops an immunity to bee venom, though the initial "pin-point" pain of a sting will always be felt.

This type of reaction, no matter how severe the swelling, is a local allergic reaction. A more severe allergic response to a bee sting is a systemic reaction. This is a total body response (anaphylactic shock), with symptoms occurring away from the sting site. Symptoms of a systemic reaction may include: hives; swelling of lips, tongue, or eyelids; tightness in the chest with difficulty breathing or swallowing; abdominal pain; nausea and vomiting; dizziness; weakness or confusion; death.

These symptoms after a bee sting call for medical attention. They are treated with antihistamines or adrenaline. Individuals with a hypersensitivity to bee stings should not try to become beekeepers.

Reaction to a sting will also vary depending on the age of the bee (development of sting glands), and the physiological condition of the beekeeper, whose body chemistry can be affected by drugs used (especially antihistamines) or by different emotional states.

As the venom is already injected into the skin, there is no "cure" for a bee sting. Lotions, ice packs, and other things may be used to soothe the afflicted area, but the only "cure" is time. There are many folk remedies to sooth the effects of bee sting. Whatever is used, the swelling will disappear in a day or so, and then there may be a brief period of intense itching at the site.

Apiary sites are often limited for a small-scale beekeeping venture. Choosing a site involves balancing the needs of the bees against those sites available.

Besides nearby nectar and pollen sources, there should be a nearby source of clean water. This reduces the effort needed by the colony in foraging for water.

Hives should not be in direct sunlight during the hot periods of the day, nor should they be in constant heavy shade. The ideal site would receive sun in the morning so that the bees start to fly early, and shade in the afternoon so that the number of bees ventilating the colony and foraging for water is minimized.

The apiary site should also allow for good air circulation so that it does not remain damp for long periods after wet weather. Avoid areas that flood during rainy periods. Areas under high trees often provide good apiary sites because they dry out quickly after rains and are not excessively shady.

Avoid areas of constant high wind for apiary sites. Such winds hinder the bees from flying. If there are no natural windbreaks, they can be planted. Again, melliferous plants can serve a double purpose. Such living fences can also serve to keep livestock away from the hives.

THINGS TO CONSIDER IN CHOOSING AN APIARY SITE

- nectar and pollen sources
- water source
- sufficient shade
- air circulation
- windbreaks
- vandalism
- protection of nearby people and livestock
- protection from fire and flood
- easy access for the beekeeper
- nearby insecticide usage

Thatch shelters can be constructed for the apiary in treeless areas, or shade covers of thatch or other material can be placed over each hive. Quick-growing trees or shrubs can be planted around the apiary to shade the hives. Melliferous plants should be chosen for this whenever possible. In many areas, castor bean is a good plant to use.

For a small-scale project, it is often difficult to avoid sites near dwellings and neighbors. This can be a limiting factor to beekeeping, especially with the more defensive strains of bees. Unfortunate accidents can occur in which people and livestock may be severely stung. Deaths due to allergic reactions to bee stings can occur. This factor should be considered in areas where projects will be carried on with African races of the western honey bee.

Shrub rows that separate the hives both from each other and from dwellings can help minimize stinging incidents. If the bees are particularly defensive, it may help to work the colonies at dusk or at night. Also, a periodic gift of honey can reduce the neighbors' objections to stinging incidents.

Getting Started - The Hives

Moveable-comb hives were probably first used by the ancient Greeks. Hives that are most likely similar to those used by Aristotle to keep bees can be found in rural Greece today. These hives are made of baskets with tapering sides which are sometimes plastered with mud. Top bars cut to a width to provide the bee space between combs are placed across the top opening of the basket.



Such hives are the forerunners of the modern moveable-frame hive. They are also the forerunners of intermediate technology hives that have been developed in recent years for use in beekeeping development programs in areas where frame equipment is not economical.

The Kenya Top Bar Hive (KTBH) is a popular type of intermediate technology hive. It was developed for use in Kenya in the 1970's and has been extensively used in a beekeeping development effort directed by a group from the University of Guelph, Ontario, Canada.

This is a practical hive to use in small-farmer beekeeping projects. There are other intermediate technology hives, but the KTBH offers a relatively large number of management options when compared with some other intermediate technology hives. Its simple design also allows for the use of a wide range of materials.

The KTBH is used in this manual to demonstrate management operations. These manipulations are similar in whatever moveable-comb hive system is used.

There are two important factors in the construction of the KTBH:

1. It is important that the width of the top bars be correct so that the bees will construct only one comb per bar. For African races of the western hive bee, the width should be 32 mm. For European races, it should be 35 mm.
2. The sides of the hive should be inclined at an angle of 120 degrees to the bottom. This minimizes the combs being stuck to the sides as it follows the similar form in which bees naturally construct their comb.

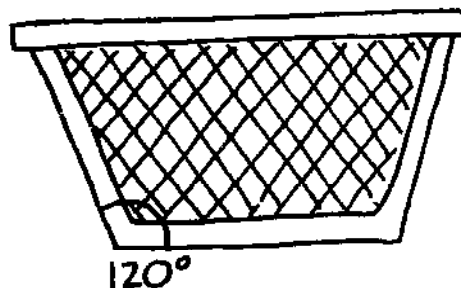
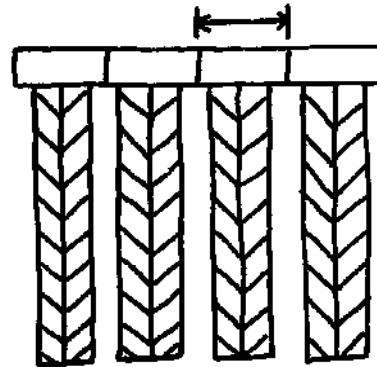

The hive can be made of any quality lumber, straw, woven reeds or bamboo covered with mud, or metal containers. Selection of materials should be based on availability and cost, balanced against how long the hive will last in the climate of the area. Several types of material can be used for demonstration hives, and local beekeepers can choose what is most appropriate for them.

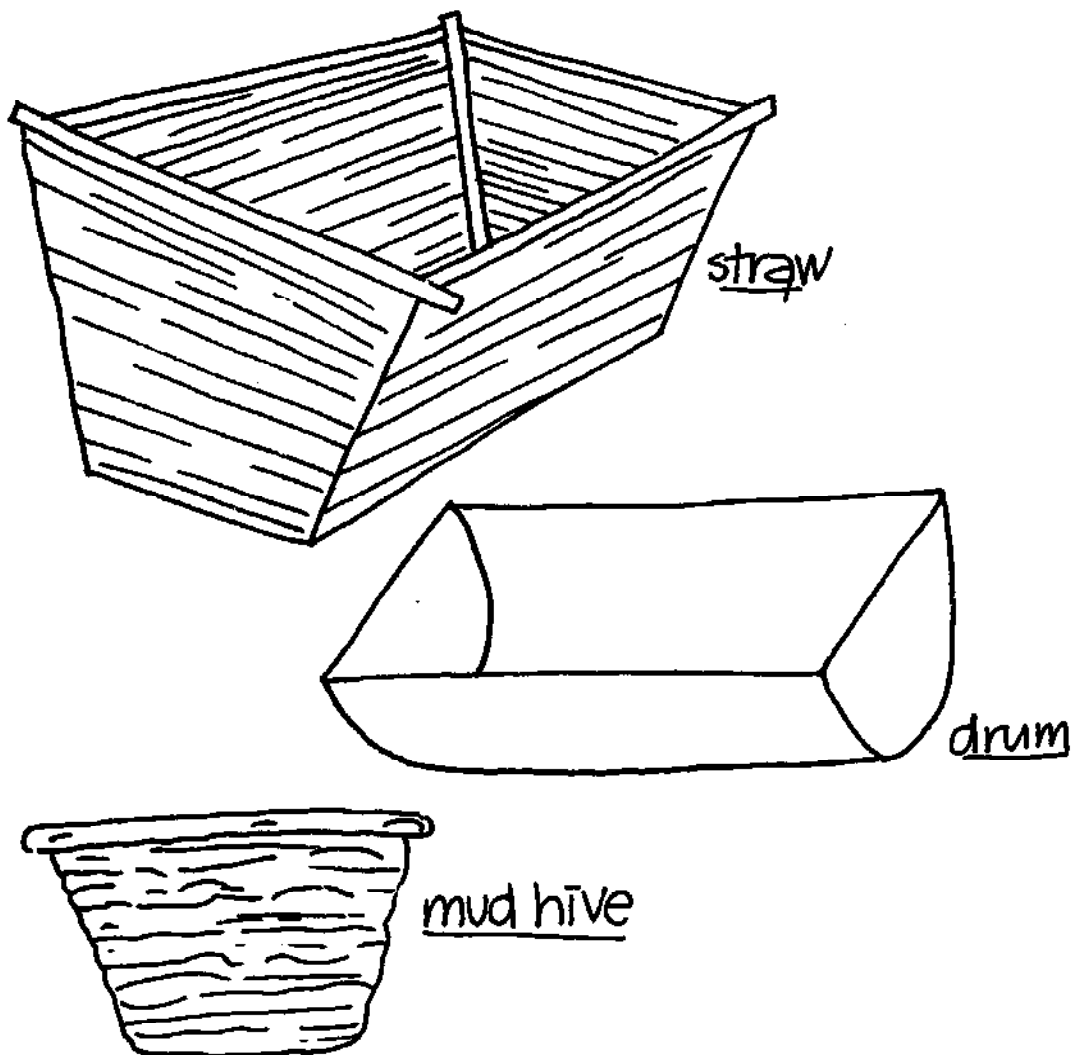

The top bars themselves are best made of strong, straight-grained wood. For easier control of more defensive strains of bees, it is important that they fit tightly together. Thus, good wood and good carpentry are important for the top bars.

(See Appendix B for more details on constructing the KTBH.)

The advantages of the KTBH system over a high-tech system for small-scale beekeeping are:

KTBH

- The number of critical dimension areas in the KTBH is far less than in a Langstroth system. Thus, the hive is easy to build with local level carpentry skills and equipment.
- The wood used in the construction of the KTBH does not have to be of high quality. The KTBH can even be built of reed matting, straw, or old oil barrels.
- An extractor is not needed for the KTBH system. Only equipment found in any kitchen is needed to harvest hive products.
- Sheets of pressed foundation wax are not needed.

Langstroth Hive

- Expertise in carpentry is necessary to build the hive. Careful attention to detail for a number of important dimensions is required, which often involves expensive carpentry equipment.
- The hive must be constructed from fairly good lumber to meet the above criteria. Such lumber is expensive and often hard to obtain.
- An extractor is necessary to make a Langstroth hive system economically viable. This is a very expensive piece of equipment. A good transportation network can alleviate this problem since many beekeepers can use a regionally located extractor, but such a network is seldom available to small-scale beekeepers.
- For a Langstroth system to work optimally, sheets of pressed wax foundation are necessary. Unless these are made locally, the village beekeeper becomes dependent on an outside supplier who may not always be reliable.

- As no frames are used, wire is not needed.
- Because of its low cost and design, it is economical to use with simple management techniques to achieve moderate increases in honey yield.
- The KTBH was designed specifically for the characteristics of the African bee. There are fewer spaces for bees to pass through when the hive is being worked, thus the beekeeper can more easily control the colony.
- The storage of combs is not necessary with the KTBH system, eliminating the need for storage facilities and chemical inputs.
- To work optimally, the frames should have wire strung in them for more support. Wire involves another expense, and is not always available.
- To make a Langstroth system economically viable, a relatively high level of beekeeping expertise and sense of timing in management operations are needed. These are generally lacking in the beginning beekeeper.
- The nature of the African bee itself makes the application of many high-level management operations with Langstroth hives difficult even for well-trained beekeepers. The African bee will soon be present in most lowland regions of the American tropics as well as in its traditional habitat.
- Proper management of a Langstroth system calls for the storage of frames with combs during dearth periods. Suitable storage space for small farmers is often non-existent. Because of damage caused by the wax moth, this storage must be done under controlled conditions and with chemical fumigants. This is not practical for most small farmers.

- The KTBH system produces more wax than the Langstroth system. However, in most areas the beekeeper's income does not suffer from this. Beeswax is a marketable product, too. Accruing a beeswax store may also be of long term interest for development of a beekeeping industry. It is needed for pressed wax foundation when conversion is made to a Langstroth system.
- The Langstroth system maximizes honey production over production of beeswax. This may not necessarily be a financial advantage for the beekeeper in most regions, however, since local markets for beeswax either already exist or can be created.
- Since the bee colony expands in a horizontal plane in the KTBH, queen excluders (see Chapter 7, page 141) are not necessary to achieve brood free combs for harvest. This eliminates the need for an expensive and hard-to-obtain piece of equipment.
- Often because of its introduction as part of a "package" of equipment for moveable-frame beekeeping, a queen excluder is believed to be indispensable. This is an expensive piece of equipment when a few relatively simple management operations alleviate the need for it. It is not necessary to use a queen excluder to achieve the goal of brood-free honey supers. The introduction of queen excluders to low-management-oriented beekeepers establishes a strong felt need for them. Bee projects can sometimes be stymied by the lack of this unnecessary input.

Other intermediate technology hives are used in some areas.

The Johnson hive which is used in Uganda is an "improved" fixed-comb hive. It provides for a separation of honey combs from brood combs by using a piece of five-mesh (five holes per 2.54 cm) hardware cloth (called coffee wire in East Africa). The workers can pass through the wire while the queen cannot, thus the comb constructed on the side of the hive opposite the queen contains only honey. Removeable sides on the hive make the harvesting of honey comb easy. This is a bee-having system since there is no possibility of managing the brood nest.

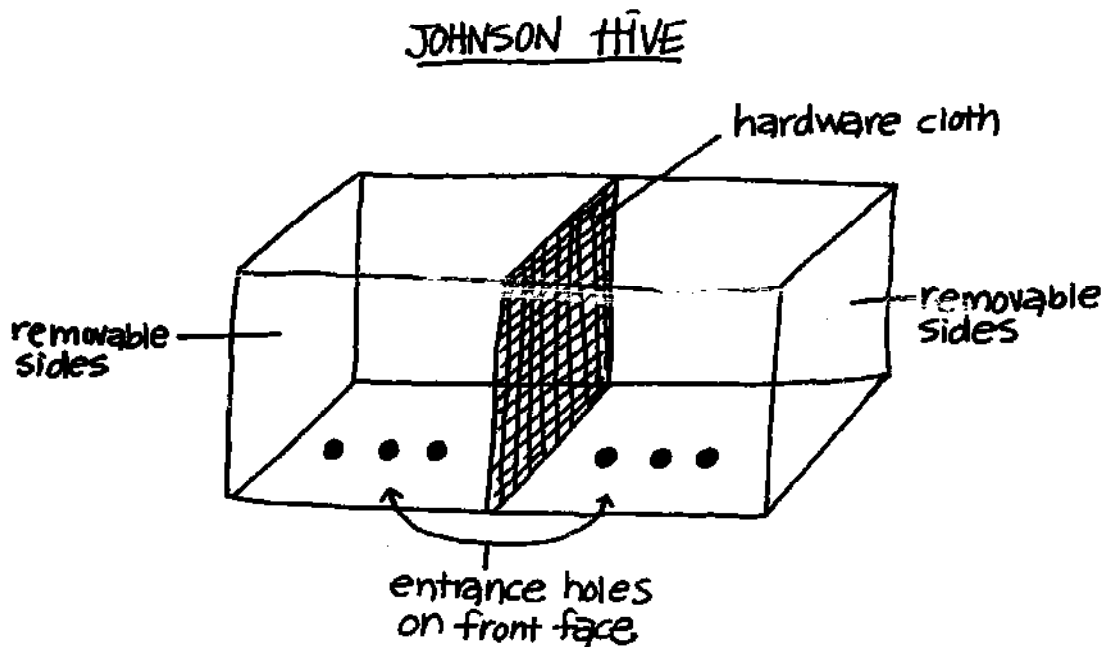

Most other intermediate technology hives are either variations of the KTBH theme or are hybrids between a moveable-comb and a moveable-frame hive. One such hive is used in East Africa. Top bars are used in the lower box, and the queen is confined there since passages to the upper box are only on the outer sides. The outer combs in the lower box are used for honey storage by the bees, and the queen will not pass the honey barrier. The bees use the upper box for honey storage. Either top bars or frames are used in the upper box.

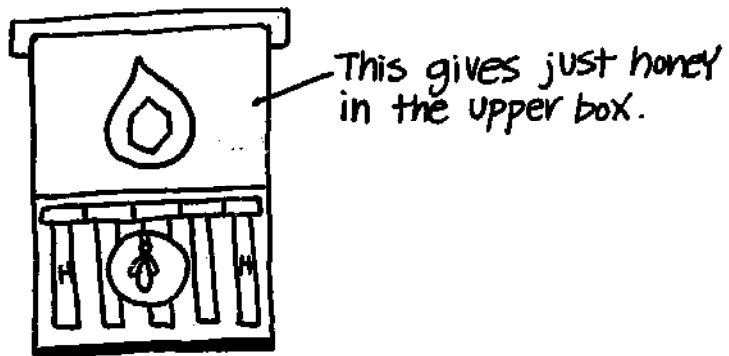
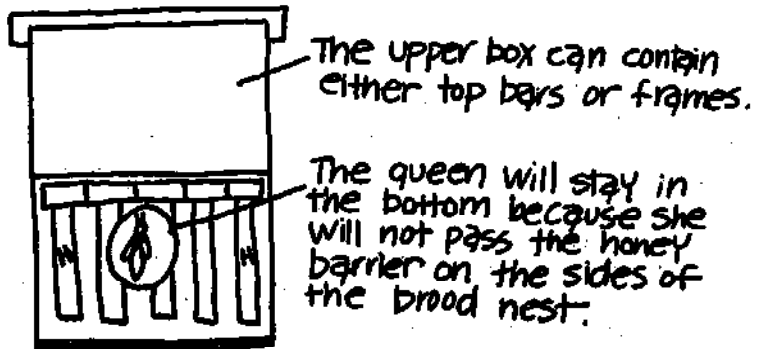
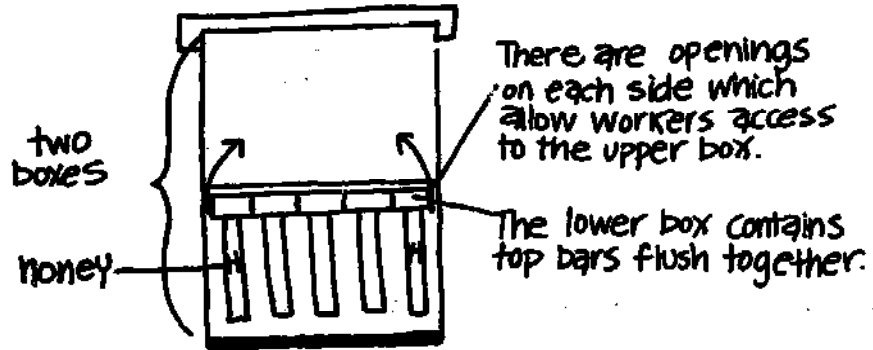
EAST AFRICAN HIVE

The East African hive is also a system for bee-having, though it could be managed and thus used for beekeeping. It does not allow for easy management of the brood nest, however. Its design is a bit more complicated than the KTBH as it uses two boxes.

Since the KTBH is simpler and more easily managed, it is probably best for most beekeeping development efforts. Management, however minimal, is a goal in any development effort. The KTBH offers a good balance between simple design and management possibility.

Getting Started - The Apiary

The arrangement of the apiary is important to help meet the needs of the bees and to help make the beekeeper's work easier.

In most areas of the tropics it is necessary to put the hives on stands to protect the bees from ants and toads. The stands should be at least 45 cm above the ground. The legs can be placed in cans that contain used motor oil, or bands of grease can be placed around them to keep ants from the hives. Check periodically to see that the oil is not washed out of the cans by rainwater or that the grease is not covered with dust. Fresh ashes spread around the legs also keep ants away, but they must be replaced continually.

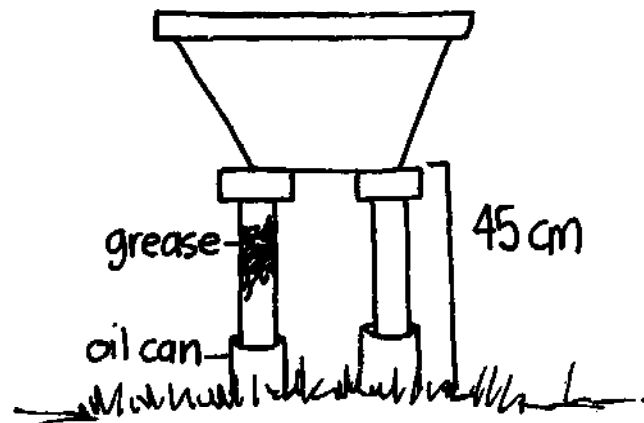

Since the KTBH consists of a single box, it can also be hung from a tree or from poles. This protects it from ants and toads and from brush fires as well. Hanging the hive also meshes with bee-killing and bee-having practices in Africa, in which traditional hives are hung from trees.

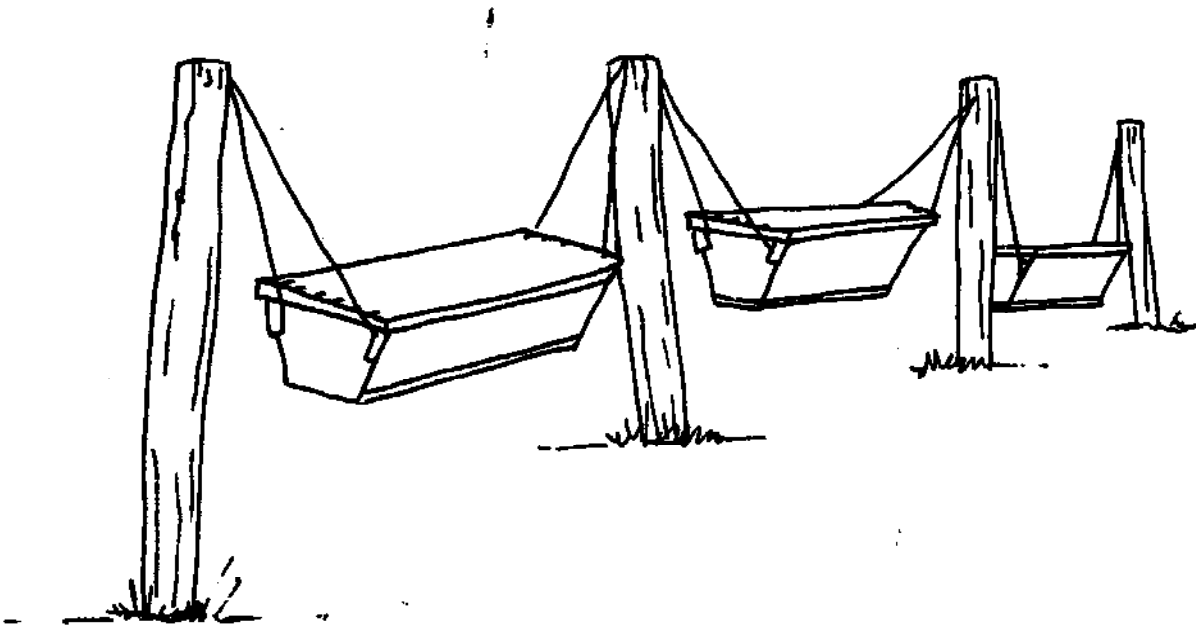

Keeping weeds cut in the apiary also reduces the ant problem. Tall weeds can provide bridges to the hives for the ants. A clean apiary also makes it easier to work around the hives. Protruding rocks and roots can cause the beekeeper to stumble or fall while working the hives.

If there is no source of water for the bees within one kilometer, a container of water with floating sticks or protruding stones can be placed in the apiary. The sticks and stones are there to prevent the bees from drowning. The waterer should have a cover to prevent feces of flying bees from falling into the water. This helps to control nosema, a protozoan disease of bees which can be transmitted by contaminated water.



Waterer for bees

Hive arrangement within the apiary is also an important consideration. Avoid placing the hives close together in long, straight rows. Such placement results in a lot of drifting or confusion of bees between colonies. Drifting can contribute to disease transmission.

To prevent drifting, the direction of the hive entrances can be varied, and lines of hives can be broken up with landmarks such as trees or shrubs. Hives should be at least 45 cm apart, and slightly tilted toward the entrance to aid the colony in removing residue that falls to the bottom. This also allows rainwater to run out.

The placement of hives should allow the beekeeper to approach the colony and work it from behind. This is less disturbing to the colony since it does not interfere with the flight path of the foragers. It also allows the beekeeper a chance to smoke the colony before the guard bees at the entrance are alerted.

Getting Started - Equipment

Besides the hive, there are several pieces of equipment that are indispensable for beekeeping. If a person is to work successfully with bees, there should be some protection from bee stings.

Protective clothing worn by the beekeeper prevents most stings. A smoker when properly used allows for some control over the bees, thus minimizing stings. A hive tool allows the beekeeper to pry top bars or frames apart gently, minimizing disturbance to the bees. All of these things can be made by local tailors and tinsmiths.

A veil is the minimum piece of protective clothing. There may be times when an experienced beekeeper may not use a veil, but for the beginner it is a necessary confidence-booster.

Veils can be made of metal or plastic screen, of nylon mesh, or of mosquito netting. They are usually made to fit over a wide brim hat which serves to hold them away from the face and neck. Elastic, rubber bands, or strips cut from an old tire tube can be used to hold them onto the hat.

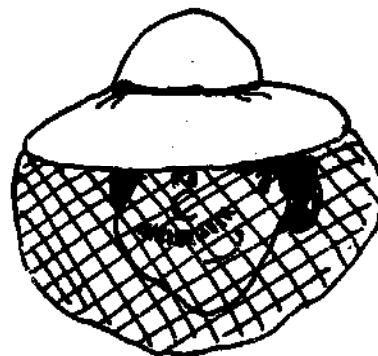

veil

The mesh material of the veil should preferably be dark. This limits reflection, which makes for better visibility when working in bright sunlight.

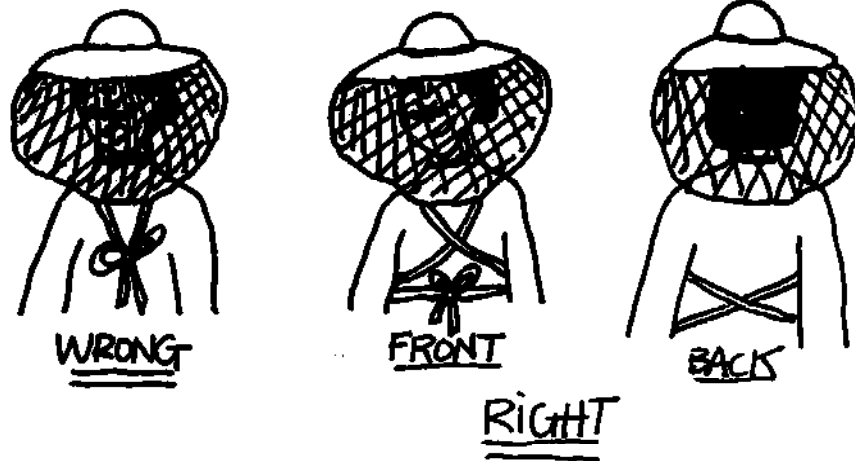

The lower part of the veil should have a long draw string that can be crossed in front, go around the back, and be tied in front. This helps to ensure that it is bee-tight around the collar. Angry bees have an uncanny ability to find any hole in a bee veil.

Gloves are often not needed if the bees are not highly defensive and they are kept under control. Working with gloves can be cumbersome, though they should be kept handy in case of need. As with veils, gloves are good confidence-boosters for beginners.

Gloves can be made of leather or of heavy, light-colored cloth. Gauntlets that reach the elbow and have elastic to hold them tight give protection to the wrists.

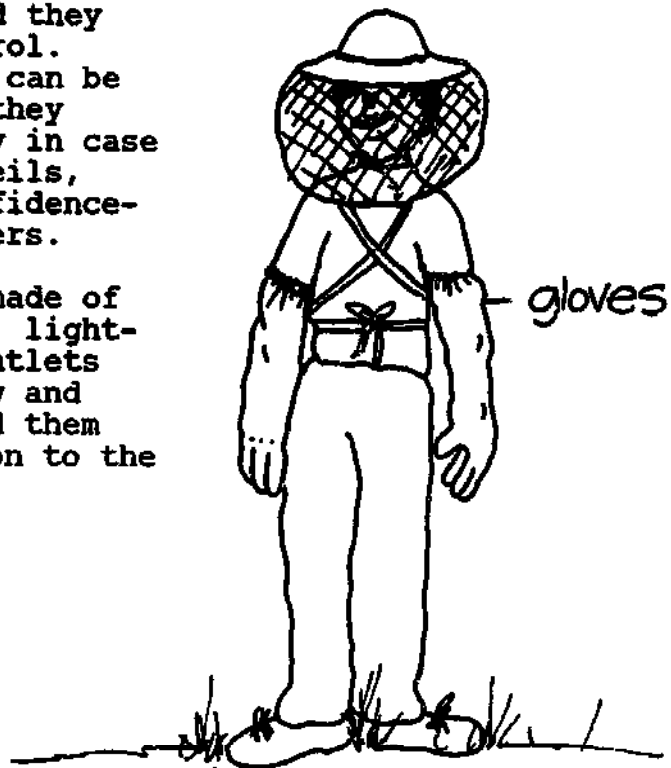

Clothing should be loose-fitting and of light-colored, smooth-textured material. Bees are less attracted to light colors. They tend to get tangled in fuzzy material, which often causes them to sting.

A collar on the shirt helps in getting the lower part of the veil bee-tight. Pant legs can be stuffed into the socks or tied down with string or elastic leg straps. Overalls (often called bee suits by beekeepers) can also be used.

The smoker is used to produce smoke which causes the bees to consume honey, reducing their tendency to fly and sting. Smoke also directs bees away from areas of the hive being worked.

The smoker consists of a firebox with a grate to hold the smoldering material, a nozzle to direct the smoke, and a bellows. The firebox should hold enough fuel so that it does not have to be refilled frequently when working with the bees.

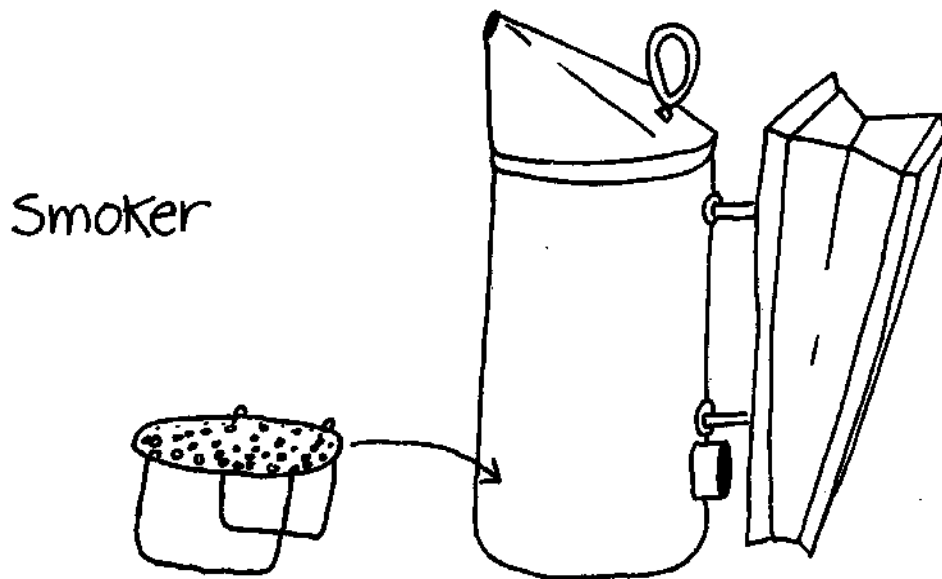

The ideal smoker fuel remains lit, burns slowly, and produces cool, white smoke. Depending on what is readily available to them, most beekeepers have a favorite fuel. Good smoker fuels are coconut husks, dried corn cobs, dried cow dung, old burlap sacks, rolls of cardboard, wood shavings, rotted wood, dried leaves, or pine needles. If these materials are slightly damp, they burn slower, with cooler, whiter smoke.

Pieces of wood and charcoal give off too much heat. Sawdust creates embers which are blown out of the smoker into the hive. The embers can burn the bees and contaminate the honey. Synthetic materials and petroleum products should not be used as they produce a dark, irritating smoke.

Local tinsmiths can make the metal parts of the smoker. Pieces of tire tube, leather, or vinyl can be used to cover the bellows; bed springs or bent, springy metal can be used for the spring in the bellows.

Locally-made smokers often need a little experimentation and redesigning to get the right amount of air properly directed into the firebox. If too much air gets in when the bellows are not used, the fuel burns too quickly. If too little air gets in, the smoker goes out easily. A few nail holes in the bottom can increase ventilation if necessary. A comfortable amount of spring in the bellows is also important. If it is too stiff, your hand quickly tires when working with it.

The extra effort of getting a good smoker made will prove well worthwhile when working with the bees. Having to stop constantly and relight the smoker is frustrating and not having smoke when it is needed can result in many unnecessary stings.

HOW TO LIGHT A SMOKER

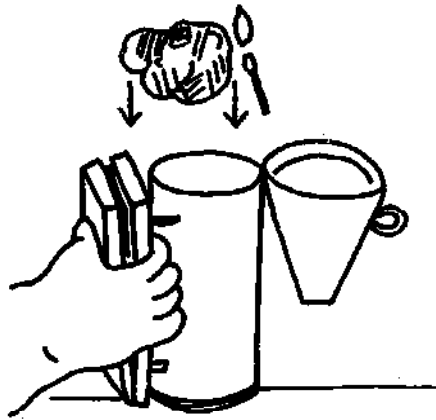

1.) Loosely crumple a piece of newspaper, light it, and push it down into the firebox.
NOTE: You can also use coals or embers to start a smoker.



2.) Pump the bellows a few times. When the paper is flaming up, slowly add fuel to the smoker and continue to pump the bellows.



3.) Once there is burning fuel, slowly pack the smoker with more fuel. Continue pumping the bellows until the fuel stays lit.

NOTE: Do not pack the fuel too tightly or the smoker will not remain lit.



4.) When the smoker is packed, put some green leaves or grass on top of the fuel to cool the smoke and catch the burning embers. Close the smoker.

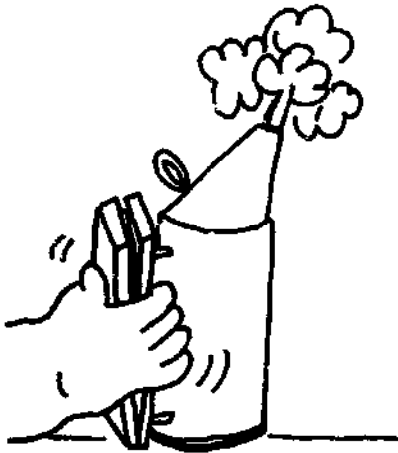

Pump the bellows periodically while working in the apiary so that the smoker remains lit.

The smoker is the beekeeper's constant companion. A well-made smoker should last for several years if it is taken care of. Do not allow the fire to burn out in a smoker. Emptying it when you are finished working will prevent damage to the firebox from excessive heat. (Be careful not to start brush fires with the embers from the smoker.) Also, do not leave the smoker exposed to the weather.

Water can be used along with smoke to help control highly-defensive bees or those that run excessively on the combs. A spray bottle works best, though a squirt bottle or a container with holes in it can be used. The object is just to wet the bees, not to drown them.

Use the water in the same way you use smoke. Wet the bees at the entrance before opening the hive, and wet the bees on the combs as they are exposed. The water cools and weighs down the bees, which prevents them from flying or running out of the hive.

The hive tool is also the beekeeper's constant companion. It is a piece of flat metal used for prying the parts of the hive apart and for scraping away the excess propolis and wax. Some hive tools have a bent end for scraping and a hole that can be used to remove nails.

A local blacksmith can make a hive tool from a bar of hardened steel. Hive tools can also be made from old cutlasses or machetes.



Getting Started - Bees

Sources of bees will vary depending on the region. In areas where bee-having or beekeeping is practiced, the most practical way to obtain bees is to buy an established colony. If the colony is in a fixed-comb hive, it can be transferred into a top-bar or frame hive.

Where "high-tech" beekeeping is carried out, bees can be bought in packages or in nuclei (nucs). A package is a screen-wire box which contains workers and a caged queen. The bees are sold by weight. A nuc is a small colony. It contains adult bees as well as frames or bars containing comb with brood and stores.

The references on high-tech beekeeping deal fully with obtaining bees in packages and nucs and installing them in the hive. If such sources of bees exist locally, information should also be available from the sellers on how to deal with the bees. In many regions, however, these sources of bees do not exist.

The source of bees should be as local as possible and readily accessible to the farmer who wants to keep bees. Importing bees is not recommended. Not only is there the risk of introducing new diseases, pests, or undesirable bee strains into an area, but also the beekeepers involved can become dependent on that source.

The idea that bees can be obtained only by importing them becomes established, and the new beekeepers are reluctant to divide their own colonies. By encouraging reliance on community resources, you can help ensure that the project will be self-supporting.

Swarms are a practical way of starting an apiary in those areas where they are prevalent. This includes those areas where there are African races of the western hive bee: sub-Saharan Africa, and soon most of the low elevation (2000 m or less) regions in the mainland American tropics. Swarms are also a practical source of colonies of the eastern hive bee in the tropical regions of its range.

(In regions of the tropics where only European races of the western hive bee are present, catching swarms is not practical. These bees, which are adapted to temperate climates, do not swarm much in the tropics.)

Using bait hives to catch swarms is a part of traditional bee-killing and bee-having in regions of Africa. A swarm is seeking a suitable cavity in which to make a nest. If empty hives are put out in suitable locations during the swarming season, there is a good chance that the hive will become inhabited.

Ideal locations for bait hives are areas which would also be ideal apiary sites--airy, semi-shady spots away from high winds. The hives should be protected from ants and checked periodically for nests of other animals.

A few small pieces of new empty comb taken from an established colony and stuck in the hive increases its attractiveness. New comb is less likely to be damaged by wax moth because it is less attractive to the female moth as an egg-laying site. Rubbing certain aromatic plants on the inside of bait hives to make them more attractive is common. Lemon grass, which contains chemicals similar to the marking pheromone of honey bees, is used in many regions.

Swarms can also be easily hived if they are found still clustered on a branch or other object.



Wild, or feral, colonies are another source of bees. In regions where swarming is prevalent, such colonies are usually common. Talk with local villagers or farmers about your interest in finding feral colonies. They probably know about a number of such colonies. If you are willing to pay or share the honey in return for information, you may be amazed to discover how many feral colonies there are in the there area.

Be aware that in some areas it is taboo to harvest honey or bother bee colonies in certain types of trees or in certain locations in the village. These colonies may be regarded as sacred or thought to be guarding some shrine or special spot. Ask about local customs concerning bees and respect them.

Small-scale beekeeping projects are usually started to improve the methods already used in the local bee-human relationship. If the purpose of a project is to introduce improved methods to those already working with bees, then the bees are already on hand. They may be feral colonies, or they may be colonies in fixed-comb hives. By talking with those involved with bees, you can easily locate the bees in your area. The problem then is not the source of bees, but rather transferring the bees into different equipment.

Management Practices

The goal of honey bee colony management is to aid the colony to build up to its maximum during the main nectar flow and to survive the dearth. Well-managed colonies assure the greatest possible return for the beekeeper.

The first management step in beekeeping is obtaining bees in a manageable hive. Once the hive is established, it should be inspected regularly and managed according to its need. Specific management practices can be broken into management during the build-up, harvesting honey, and management during dearth periods.

Retrieving swarms is the easiest and cheapest way of getting bees. You have only to wait for bees to inhabit a bait hive or to have a swarm that has clustered. If a swarm inhabits a bait hive on its own, it usually stays. Swarms that are clustered in accessible places are easily put inside a hive, though sometimes they are reluctant to stay.

Hiving a swarm involves shaking or dumping the bees into or in front of the hive. If the swarm is on a low limb or bush, remove some of the top bars of the hive, put the hive under the swarm, and shake the swarm directly into the hive. Alternatively, shake the bees in front of the hive; they will usually run in. It is also possible to cover such a swarm with a large bag, shake the swarm into the bag, and transport it to the hive. If the swarm is clustered on a high limb, cut the limb and lower it carefully with a rope.

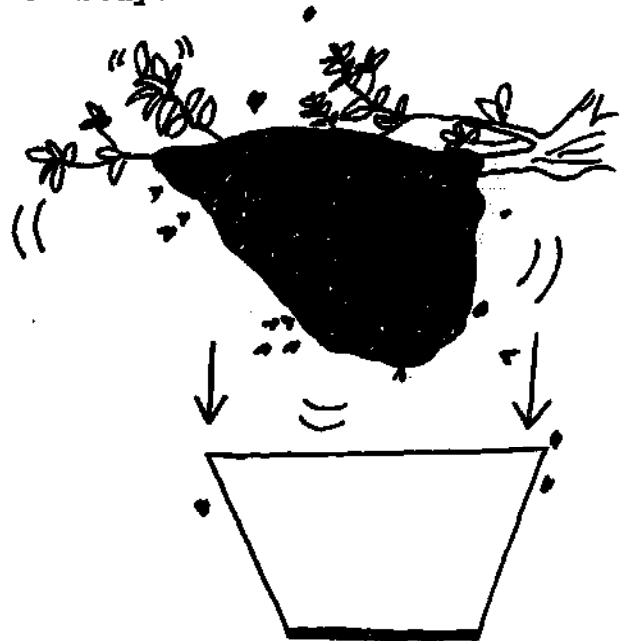

If the swarm is on an accessible limb, shake the bees directly into the hive.

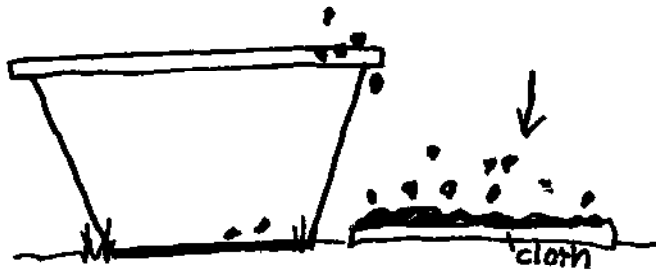

Alternatively, shake the swarm onto a piece of cloth in front of the hive. The cloth prevents the bees from becoming entangled in the grass or from becoming covered with dust.

Scoop up swarms that are clustered on a flat surface or a large object with a piece of cardboard, and dump them into the hive. Use a brush of leaves or loose grass to brush the bees into the hive. As swarms have no brood or stores to defend, they are usually docile and no smoke is needed when hiving them. However, if the swarm has been away from the colony for a while, it may be hungry, thus defensive and difficult to work with.

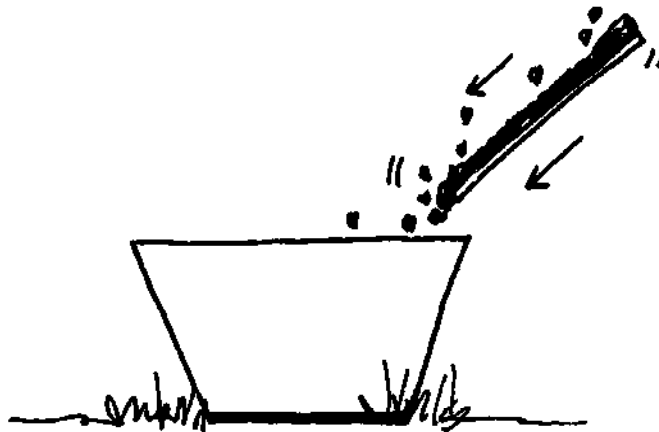

Bees can also be scooped up and dumped into the hive.

If the swarm is defensive, sugar water (two parts sugar to one part water) can be sprinkled on the swarm before trying to hive it. Smoke can also be used when hiving a swarm if it is defensive, but avoid excessive smoke as this may cause the swarm to leave.

(Bees that have constructed some comb and have brood are also more defensive. This is no longer a swarm. With comb and brood it is a colony, and its defensiveness is normal.)

Swarms are much more likely to stay in a hive if they are given some comb containing unsealed brood. If established hives are available, it is easy to remove such a comb from the colony, brush the bees off with loose grass or leaves, and give the comb to the swarm. (Do not transfer adult bees with the comb as they will fight with the bees in the swarm.) Comb containing eggs or young larvae gives the swarm a chance to rear a new queen in case the old queen is killed in the hiving process.

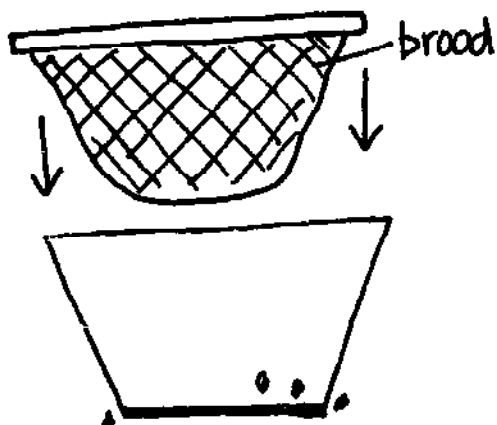

Putting some brood comb into the hive helps to prevent the swarm from absconding.

It is necessary for the queen to be in the hive if the bees are to stay. If the bees return to the original cluster site or cluster in another place, suspect that the queen is in the cluster. Try again to shake or dump the cluster in the hive.

Although it is not necessary to find the queen, it is helpful to see her and know where she is. A small screen-wire cage is handy to enclose the queen. Catch her from behind by both wings and guide her into the cage. If she is caught by one wing or by one leg she may twist and hurt herself. Never grasp the queen by the abdomen. This area is soft and you can injure the reproductive organs.

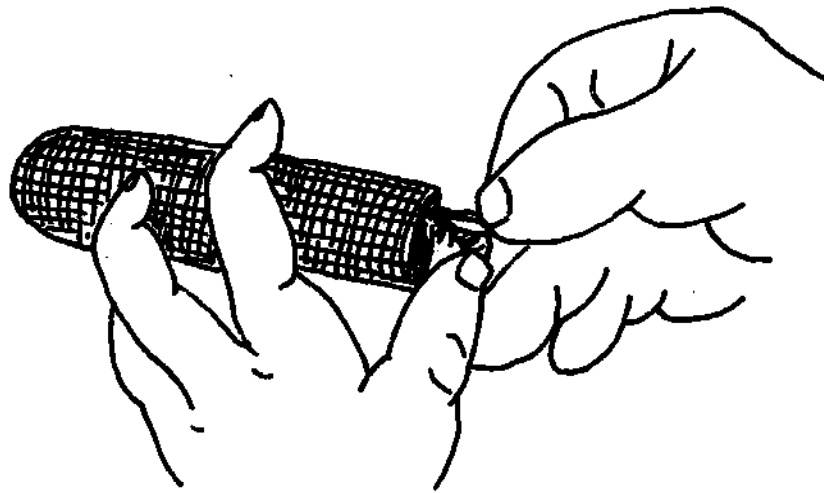

CAGING A QUEEN

If the queen is caged, her whereabouts are known until hiving is finished. When the hive is in its final site and the bees are settled, release her.

Caging the queen also prevents her from being "balled." Under the stressful conditions of hiving a swarm, transferring the colony to new equipment, or moving the hive, the workers will sometimes cluster tightly around the queen and attempt to sting her. This is called balling the queen, and the workers sometimes kill her by stinging or suffocation.

If swarm retrieval or transferring feral colonies is going to be frequent, it may be worthwhile to construct a KTBH one-half the standard length. Such a hive is usually large enough for the normal-size swarm or transfer from a feral colony. Pay special attention to making it bee-tight and easy to transport. Make a wire grid or screen to close the entrance easily.

Transfer the colony into regular-size equipment in the apiary. Swarms rapidly build up to full-size colonies, thus they will soon need more space. Hived swarms also construct or draw out comb quickly. Leaving the swarm in the small hive will restrict its build-up.

Once the bees are settled in the hive, the entrance is closed up and the colony moved. It is best to move the colony in the late evening or at night when the bees are all inside and it is cooler. Some bees will drift back to the old site if the colony is moved less than two kilometers.

Do not leave a closed colony in the sun. If the colony is to be closed for more than fifteen minutes, use some type of screen material to close the entrance. Sprinkle water through the screen if the colony is closed for long periods. This gives the bees water to drink and helps to cool the hive.

Transferring bees from fixed-comb hives to top-bar hives is best done early in a build-up period. This gives the colony time to recover from the transfer. It will be easy for the bees to build comb and build up the population so that they can survive the dearth. If the transfer is made early enough, it may even be possible to harvest some surplus honey.

The colony population is low, and there is a minimum amount of honey in the colony at the beginning of a build-up period. This makes the transfer easier, and minimizes problems of robbing from other colonies.

Colonies that have been transferred need time before a dearth period to recover and store some honey for survival during the dearth. Transfers made during a dearth period have little chance of survival unless they are fed.

Depending for feeding for colony survival is not advisable. Buying sugar to feed bees is often not practical since a large colony can need a large amount to survive. Available cash for buying this sugar is usually lacking, and in some regions, even if the money is available, sugar is scarce.

Feeding a colony during a dearth period stimulates brood-rearing. This results in a greater amount of brood than can be maintained with available natural resources so the colony becomes dependent on feeding for survival. Assessing the feeding needs of a colony is difficult for a beginning beekeeper. Once feeding is started it is often necessary to feed continuously until a honey flow starts. This is not economically practical for most small farmers, so avoid feeding altogether. (See Chapter 7, page 146.)

Transfer colonies during the build-up period so that feeding will not be necessary.

Transferring bees from feral colonies or from fixed-comb hives is essentially the same. The cavity must be opened and the combs cut out and attached to the new hive.

With fixed-comb hives, the colony is readily accessible, and the cavity is easily opened. Feral colonies are sometimes inaccessible in such locations as part of a wall, the roof of a house, or a large tree. It may not be worthwhile to tear down a structure or to cut down a tree for a colony. However, if the colony is in a limb you can cut the limb. Lower it carefully to the ground since letting it fall will destroy the comb.

TRANSFERRING A COLONY

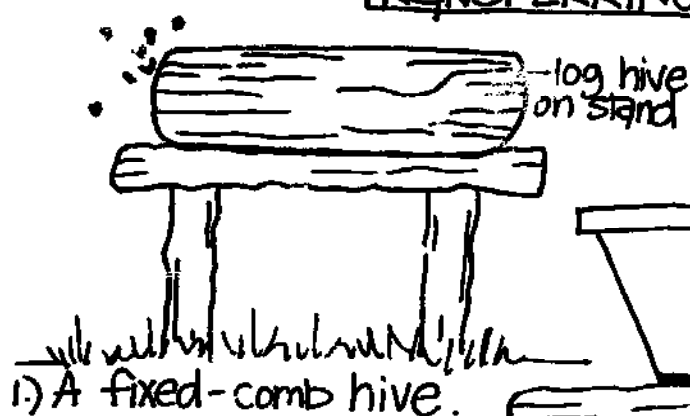

2.) Move the fixed-comb hive away from its original site and put a KTBH in its place.

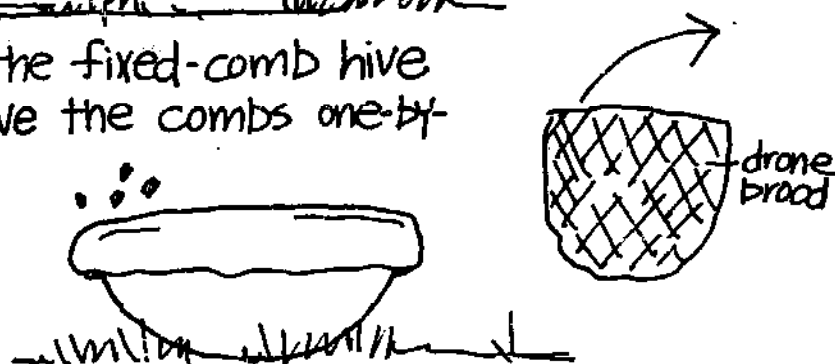
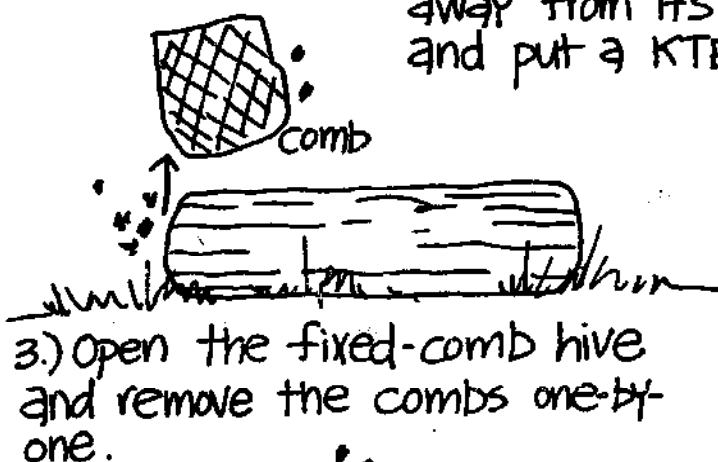

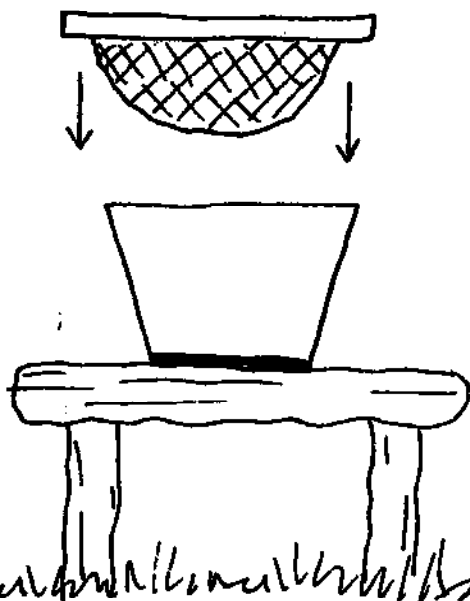

5) Attach worker brood combs to top bars and put them in the KTBH.

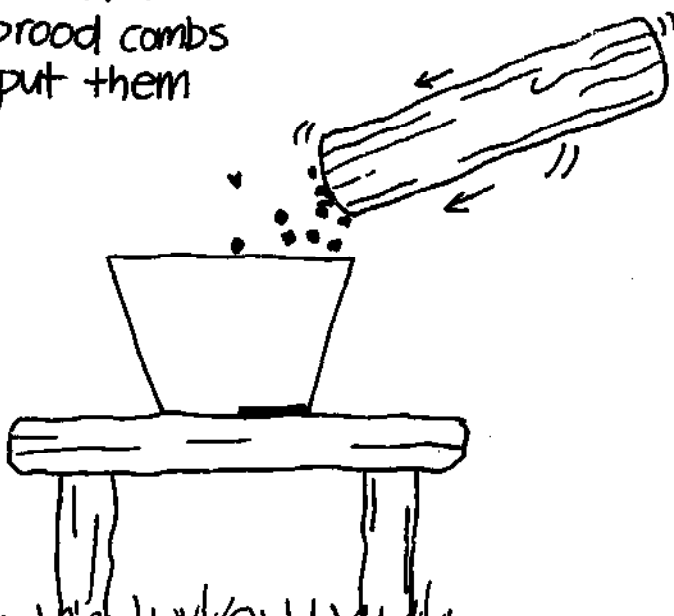

6) After all the comb is cut out, dump the remaining bees into the KTBH, close the hive, and reduce the entrance.
 NOTE: Move the old, fixed-comb hive out of the apiary to prevent the bees from being attracted to it.

To make the transfers, smoke the colony well, and, if possible, place the new hive where the old hive was located. Then move the old hive a few meters away. The bees are oriented to the site where their colony was located; thus they will go into the new hive quicker if it is in the old location.

Continue smoking the colony, turn it upside down, and open it if possible from the bottom. Cut out the combs. Set empty combs and combs with drone brood aside for their wax. Attach combs containing worker brood to the top bars with string or wire. Sharpened bamboo sticks or other skewers through holes in the top bars can also be used to hold the comb. Harvest most honey combs, but leave about one-half kilogram of honey for the colony.

WAYS TO ATTACH COMB TO TOP BARS

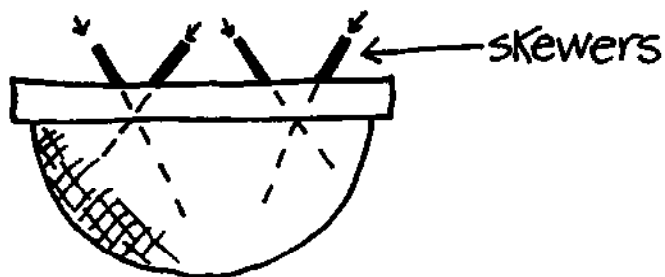
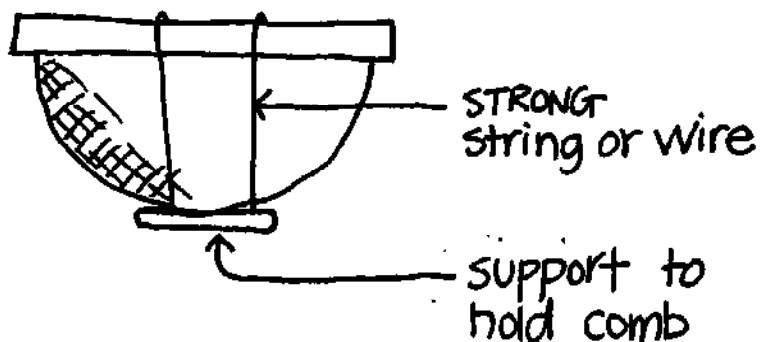

When all of the combs are attached, shake, dump, or brush the remaining bees into the new hive. Replace all of the top bars, put on the top, and reduce the entrance with a block of wood. A reduced entrance helps the colony to defend itself and deters robbing.

If the queen is found, cage her in a match box or a similar container until all the combs are attached. It is possible that she may be balled by the bees or mashed by the beekeeper in the confusion. Caging her can prevent this.

Remove the old hive from the area so that the bees will go into the new hive quicker. If the bees start to cluster away from the hive, smoke the area and check for the queen.

Try to avoid spilling the honey and keep the honey comb in a covered container. This will help reduce robbing by other bees.

Absconding is sometimes a problem with transfers. Making sure that the colony has unsealed brood and sufficient food helps control absconding. Patience and a sense of humor also help in dealing with absconding, especially with some strains of bees.

Transferring rustic hives is traumatic for both the beekeeper and the bees. It sometimes involves a lot of work, and a little experience working with bees helps. Confused bees flying around sometimes make for confused beekeepers. Many bees are killed, and some brood and comb are lost. However, making a transfer is in itself a great learning experience. If you make it through a transfer successfully, you are definitely on the way to becoming a beekeeper.

* * * * *

Inspecting the hive regularly once the colony is established is necessary to ascertain its condition and needs. During build-up periods there is intense activity in the hive, and the colony should be inspected every two weeks. Once a month is sufficient during dearth periods since the colony is less active. Colony inspections assess the status of the brood, the space needs, and the presence of adequate stores. The period of the yearly cycle determines what the beekeeper looks for.

With experience, the condition of the colony can be noted by looking at the activity at the entrance, and by removing a comb or two. However, beginning beekeepers need to make more thorough inspections while learning what to look for.

The disposition of the colony varies greatly with the strain of bees, the colony condition, and the prevailing weather.

Generally, bees are more docile on warm, sunny days during a nectar flow. On such days, a maximum number of bees are foraging. Foragers, the older bees, are more defensive of the colony as their sting glands are fully developed. In most areas, the maximum nectar flow is from early morning to mid-day. This, then, is the best time to inspect the colony since most of the foragers are away from the hive.

In areas where bees are particularly defensive, many beekeepers prefer to work with their bees at dusk. This is especially true if the hives are near houses. When night comes, the bees quickly settle back into the hive. This minimizes disturbance to neighbors and to nearby livestock. Beekeepers with highly-defensive bees also remove the honey from their colonies at night to minimize stinging.

Robbing is often a major problem when inspecting colonies during dearth periods. Bees from other colonies take advantage of the openings in the hive being inspected to rob honey. Robbing can be suspected when bees are observed fighting.

Preventing robbing is much easier than stopping it. Work fast when making inspections to minimize the time that the colony is open. Also, be careful not to drip honey about the area and do not leave honey comb exposed.

If robbing gets started, close the hive and wait until another day. If robbing is out of control, close the hive and stop up the entrance completely with grass or leaves. Also, douse the robber bees with water to help slow robbing. Remove the grass at night or the next day when the robbing has stopped. If the colony is left open, it will be robbed of all its honey and most of the bees will be killed.

The condition of the brood nest is the most important thing to note when inspecting a hive. A quick glance at a comb from the brood nest can tell you whether or not the queen is present, and by observing the brood pattern, you can determine the condition of the queen or the presence of disease.

The brood is always located on the lower portion of a brood comb. Pollen is stored around the sides and the upper edges of the brood area, and honey is found along the top edge of the comb. The layer of honey above acts to insulate the brood nest.

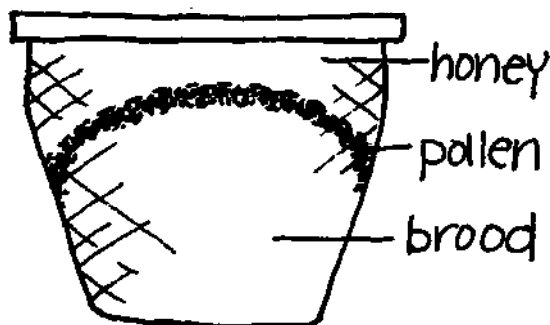

INSPECTING A HIVE

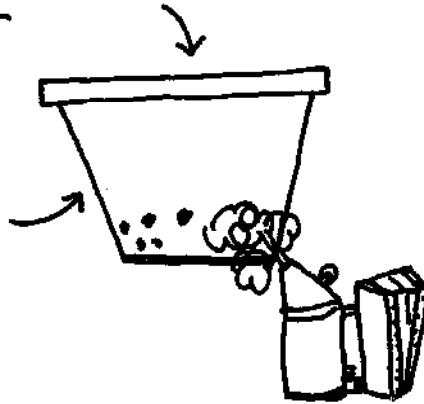

1.) Approach a hive from behind or from the side. Smoke the entrance and wait 30 seconds.



2.) Take the top off and puff more smoke over the top bars. Tap the top bars to locate the empty bars.

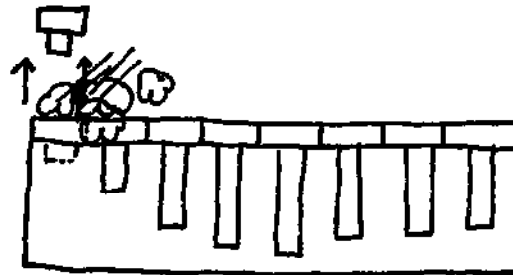

3.) Remove an empty top bar. Puff smoke into the empty space as the bar is being removed.

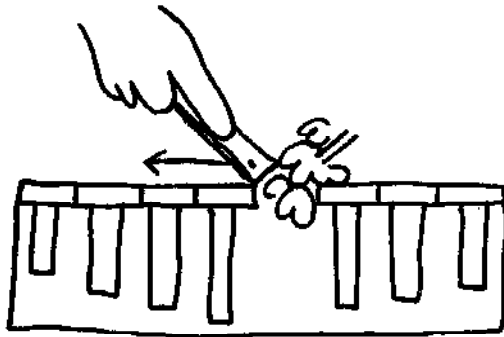

4.) Move the top bars down until you get to the brood nest. Puff smoke into the empty space periodically to keep the bees under control, though do not use too much smoke. Too much smoke can cause the colony to abscond.

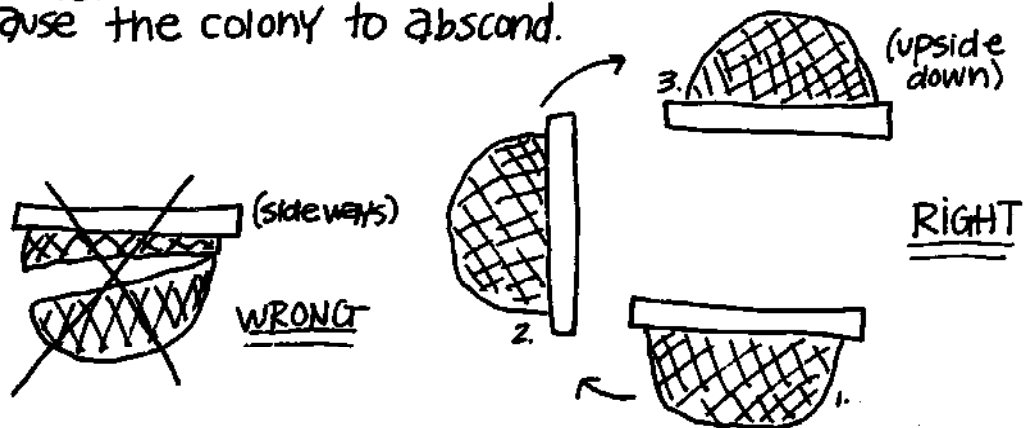

5.) Remove the brood combs one-by-one to inspect them. Be careful not to turn the combs sideways or they will break, but the combs can be turned upside down.

6.) After inspecting the colony, return the top bars to their original places and close the hive.

A good queen lays eggs in a tight pattern. She lays one egg in a cell and lays in all the cells. Once she starts laying on a comb, she moves outward on the comb laying eggs around the area containing the developing brood. When the adults emerge from the center area, she again returns to that part of the comb and begins to lay outward as the cells are emptied when adults emerge. Thus, a good brood pattern has the form of concentric circles where the rings are composed of similar-age brood.

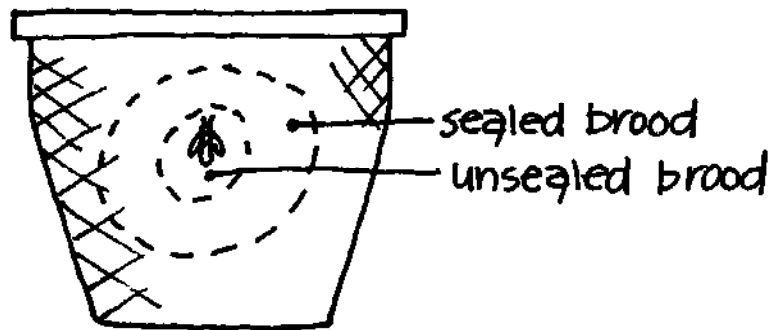

If the queen is failing, a brood disease present, or there are laying workers, the brood pattern will appear spotty--many cells will be empty in the brood area. Temporary drops in incoming nectar and pollen can also cause a spotty brood pattern, but this has only short term effects. If there is a brood disease (see Chapter 9), some cells may contain the decaying remains of the brood.

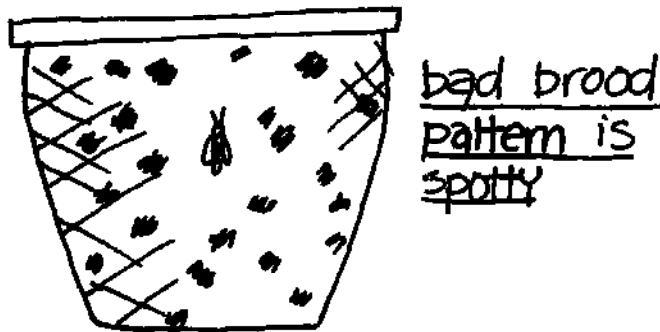

An old or failing queen lays eggs that do not hatch or are unfertilized (thus they produce drones). The colony will eventually supersede her, but you should replace her when you note the condition since this will give the colony a young queen sooner. You can requeen the colony by killing the old queen and allowing it to rear another, or by introducing a queen cell after killing the old queen and leaving the colony queenless for one day. If you are going to allow the colony to rear a new queen, add a brood comb containing eggs and young larvae (but no adults) from another colony so that you can be assured that the queenless colony has worker larvae of the proper age to rear queens.

The queen is normally found on comb containing brood. Some strains of bees are "runny"; they tend to run from the comb when the colony is disturbed. With runny strains of bees, finding the queen is very difficult. However, it is not necessary to find the queen each time a hive is inspected. If eggs are there in a concentrated pattern, the presence of a good queen is verified.

If a colony has been queenless for a long time, workers will start to lay eggs. Since the eggs are unfertilized, they will always produce drone brood.

A spotty brood pattern and worker cells sealed with domed cappings are signs of laying workers. Many eggs of varying sizes placed haphazardly in a cell is another characteristic of laying workers (see Chapter 3, page 38).

A colony with laying workers is in a hopeless situation; since only drones are produced, the colony will dwindle and die out. As the colony perceives that it has a queen, it will not attempt to rear queen from young larvae from another colony, nor will it accept queen cells from another colony.

When you find a colony with laying workers, combine it with a strong, queenright colony. (See page 128.) The workers from the strong colony will take care of the laying workers.

The presence of adequate stores is another important thing to check for when you inspect the colony. There should be at least one comb containing honey on each side of the brood nest. If the colony does not have sufficient honey stores, add honey combs (without bees) from stronger colonies, or if the colony is weak, you can combine it with another colony.

Maintaining records of hive inspections is helpful to follow colony progress and to plan for future work in the apiary. Simple written records can be kept or the position of a stone or stick on the top of the hive can be used to denote the colony condition or its needs.

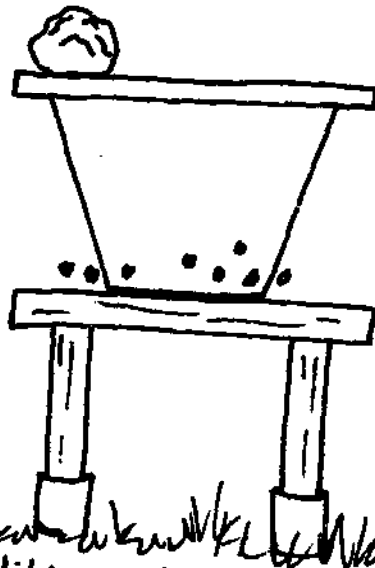

The condition of the colony can be marked by the location of a rock on top of the hive.

Note the general condition of the apiary when inspecting hives. Check for weeds or grass around the hive stands. Weeds can allow ants access to the hives. Also note broken or rotting equipment which may need replacing.

Management during the build-up seeks to provide space for the expanding brood nest in order to allow the colony to build up to its maximum population for the main nectar flow. Manipulations need to be made several times during the period to prevent the brood nest from becoming honey bound.

As the brood nest grows, it becomes crowded with brood, and the space available for the queen to lay eggs becomes limited. The brood nest becomes bounded by honey. The colony can expand the brood nest area by using the honey in the adjacent cells, but this is a relatively slow process.

By putting empty top bars or combs adjacent to the brood nest, you can quickly increase the area of the brood nest and alleviate the crowding. This manipulation allows the colony to build up both to a higher population and earlier than if it were left alone.

Space for the brood nest also helps to control swarming. For bee-havers, swarming is considered desirable, since it is the only way they know to increase their colonies. Swarming is undesirable for beekeepers, however, as swarms are often lost, and the reduction in colony population before the nectar flow prevents a good honey flow from the colony.

Swarming cannot be completely prevented, but it can be controlled. Beekeepers can divide their colonies to increase the number. They can control the process, doing it when they choose without the risk of losing a swarm.

If queen cells are found in a strong colony during the build-up period, the colony is probably preparing to swarm. Such queen cells are often called swarm cells and are normally found along the edges of the comb. If the colony has started the swarming process, there are two management options to prevent loss of the swarm. Either try to prevent swarming by destroying the queen cells and moving the colony, or divide the colony (artificial swarming).

MANAGING A HONEY-BOUND BROOD NEST (side view of hive)

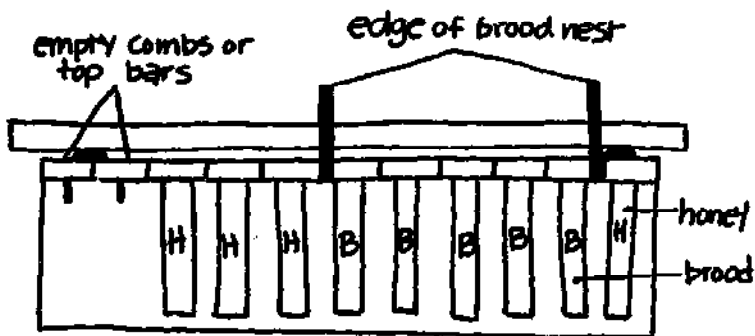

1.) Honey-bound brood nest.

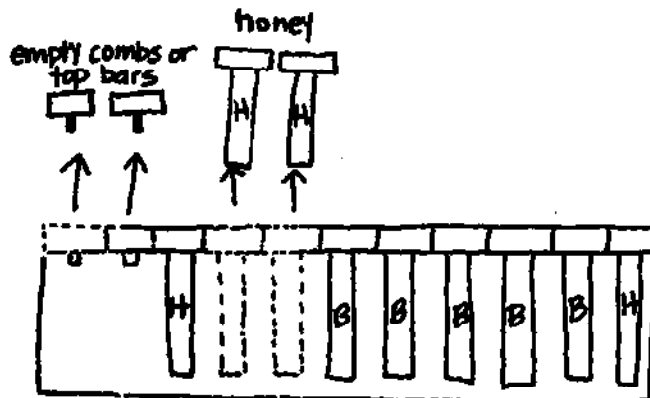

2.) Remove two honey combs from the side of the brood nest and also remove two empty combs or top bars.

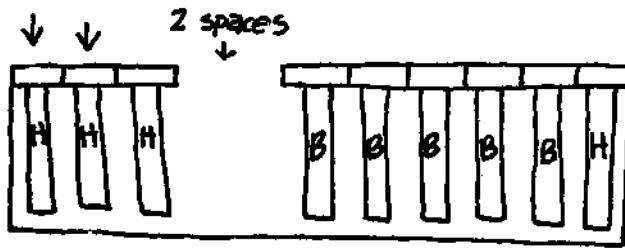

3.) Put honey combs where the empty top bars were, or they can be harvested.

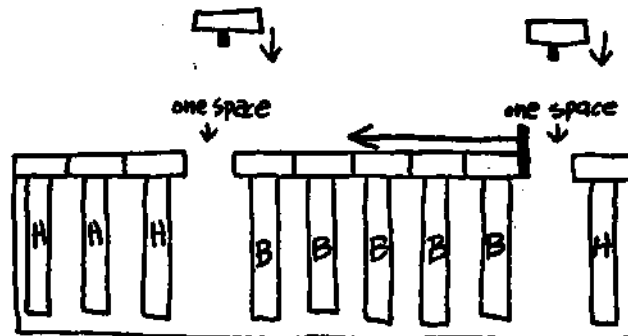

4.) Move the brood combs to make a space for an empty top bar at both edges of the brood nest.

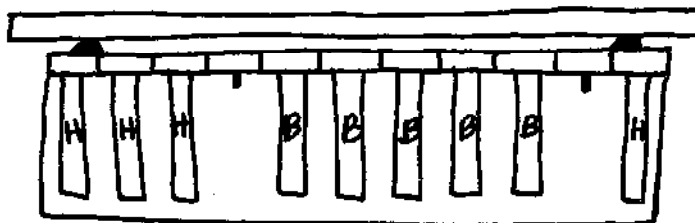

5.) Place empty top bars at the edges of the brood nest.

Once the colony has begun the swarming process it is often difficult to stop it. Try to prevent swarming first by destroying all of the queen cells in the colony. Then switch the location of the colony which was preparing to swarm with that of a weaker colony in the apiary. Foraging bees will return to the hive site to which they were oriented. A colony preparing to swarm is a strong colony. Thus by switching the hives, the strong colony will lose bees and the weaker one will gain them.

Switching colonies during build-up or flow conditions will not lead to fighting between the returning foragers and the strange hive bees. The foragers are returning with nectar and pollen, thus they will be readily accepted in the new hive.

Destruction of the queen cells combined with the loss of foragers will usually stop the swarming impulse in the colony. (Check the colony a few days later and destroy any new queen cells.)

Exchanging the location of colonies is an easy practice to equalize colony populations. It is good management to have colonies of similar strength in an apiary as this minimizes robbing.

Another way of equalizing colony populations in an apiary is to give combs of brood without adults to weak colonies to help them build up quicker. Be careful not to give a colony more brood than it can care for. Sealed brood which will soon emerge is best for this purpose since it only needs minimal care from the colony.

SWITCHING HIVE LOCATIONS

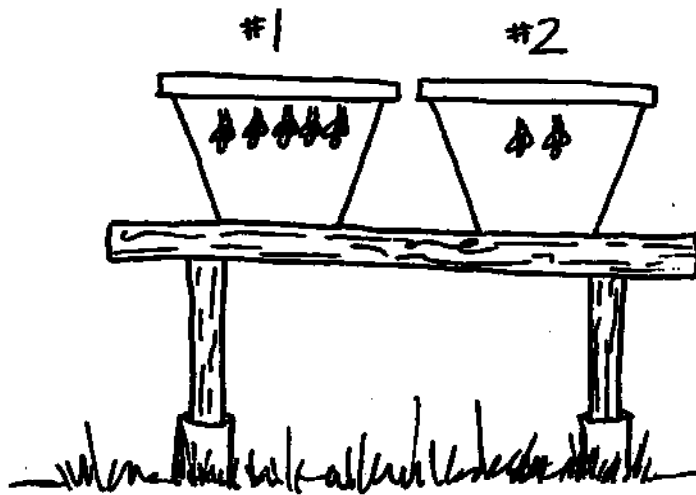

1.) Before switching, hive #1 is strong and hive #2 is weak.

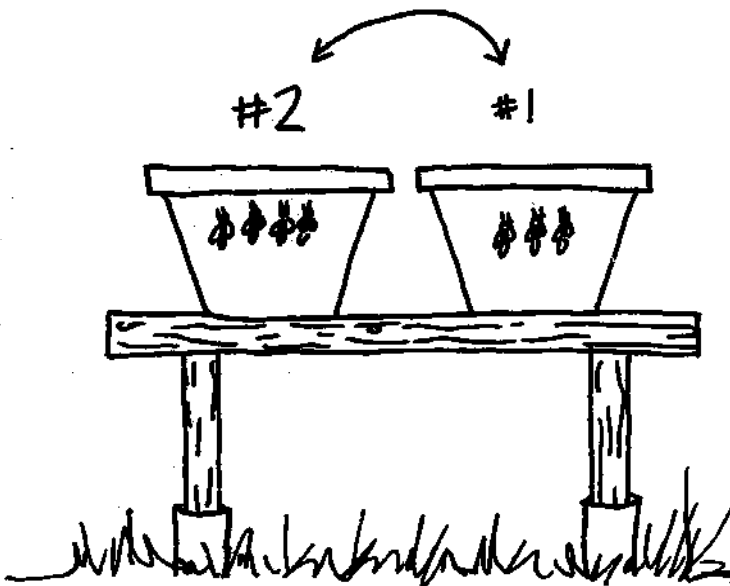

2.) After switching, hive #1 becomes a little weaker, but hive #2 becomes a lot stronger.

Dividing colonies or artificial swarming is another way to deal with colonies which are preparing to swarm. This is essentially the swarming process carried out under the control of the beekeeper. It is the most practical method for small farmers to increase the number of hives in their apiaries.

Strong colonies can be stimulated to construct queen cells and to rear queens if the queen is removed. These emergency queen cells are used to make further colony divisions if desired. The treatment of the queen cells and the process of division are the same whether swarm cells or emergency queen cells are used.

Divisions made with swarm cells rarely yield surplus honey. Swarming normally occurs soon before the main flow, thus divisions made with swarm cells do not have time to build up. Take care that such divisions have sufficient provisions to make it through the next dearth period.

The best time to divide colonies is early in build-up periods. If made early enough, the colony may build up sufficiently to produce some surplus honey.

Making divisions is always done at the expense of honey production from those hives. Remember that strong colonies yield more honey in relation to effort and equipment than weaker ones. The decision to divide colonies should center on the objective of the operation. Is it to produce bees or to produce honey?



MAKING A DIVISION

1) Begin with a strong colony.



2) Take at least two combs of sealed brood and at least two combs of honey from the colony.



3) Transfer these combs with the bees and brush some more bees from a few other combs into the new hive. Put the brood combs between the honey combs to insulate the brood nest.

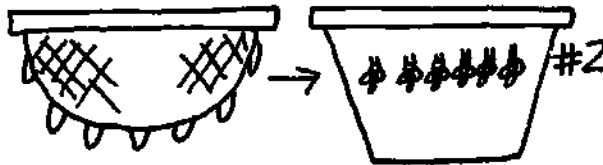

4.) Add queen cells to the new colony. These may be on a comb or they can be cut out from one comb and placed on to another.

NOTE: If no queen cells are available, the division will rear a new queen if you give them young larvae. But, it will take longer for the colony to have a queen.

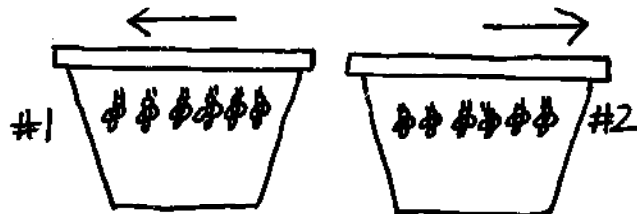

5.) Move the two colonies away from each other to minimize drifting.

NOTE: The foragers will return to the site of the original strong colony.

CUTTING OUT AND PLACING QUEEN CELLS

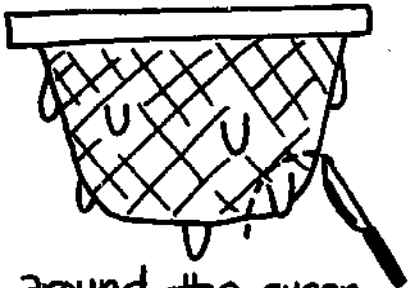

1.) Cut around the queen cell.
Be careful not to cut into the cell.

NOTE: Do not turn the queen cell on its side as this may injure the developing pupa.

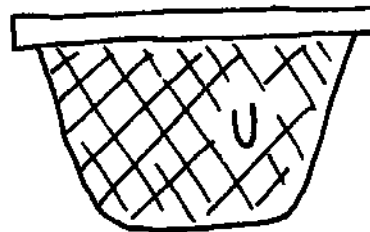

3.) Place the queen cell in the cut out section.
Remember: Always keep the cell pointed downward.

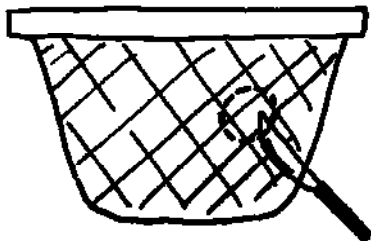

2.) Cut a section out of the face of the comb into which you will put the queen cell.



4.) Put the comb into the colony. The bees will seal the queen cell to the comb.

Harvesting honey is the beekeeper's reward. As the honey flow progresses, the outer combs of the hive will become filled with honey. Harvest these combs several times during the flow period. This prevents the colony from becoming honey-bound, and the empty space in the hive stimulates the bees to forage.

When most of a comb contains capped honey, it is ready for harvesting. The moisture content of uncapped honey is too high for the honey to be self-preserving. Such honey is called green or unripened honey, and, if harvested, will ferment. A comb in which at least two-thirds of the cells are capped contains honey that will be self-preserving. Such honey is called mature or ripened honey.

Bees are best removed from the comb by brushing them off. A little smoke can be used to get them started, but using too much smoke to clear the comb of bees will give a smokey taste to the honey.

Cutting comb off top bars

(Harvesting Honey comb)

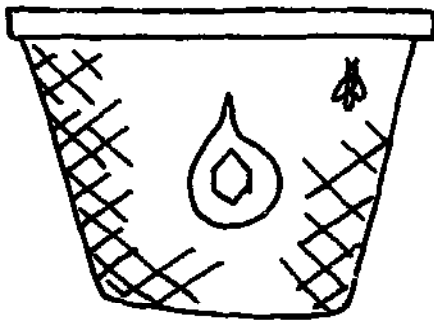

1.) Remove only comb with honey. (no brood)

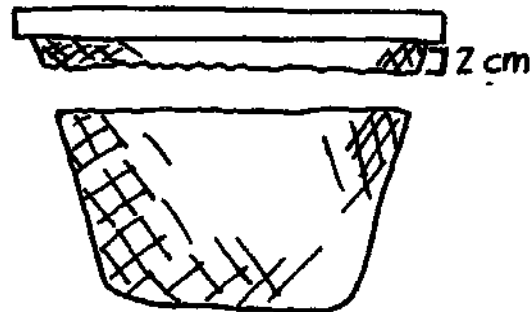

4.) Cut off comb. (leave 2cm)

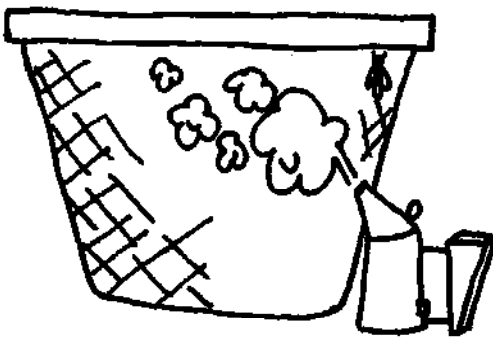

2.) Smoke the comb a little.

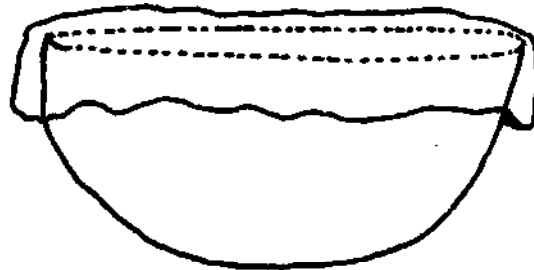

5.) Put comb in pan with wet cloth.

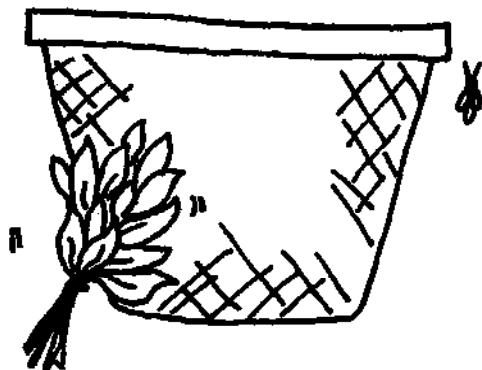

3.) Brush bees with brush or leaves.

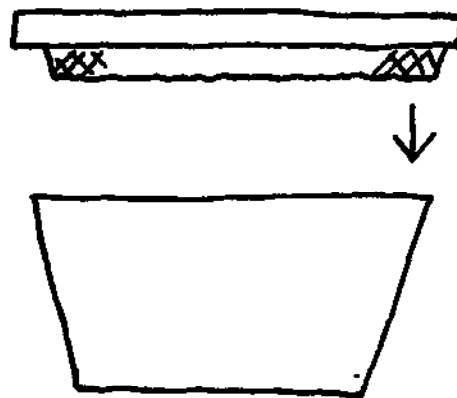

6.) Replace top bar.

NOTE: Too much smoke will give the honey a "smoky" flavor.

Management during dearth periods is different in temperate and tropical regions. In temperate regions, there is a dormant period in the colony. Good management in these regions entails ensuring that the colony has sufficient and properly-located honey stores for the period and protecting the hive from prevailing winter winds. The hive entrance is also reduced to keep out cold and mice. (Mice will sometimes enter a colony and build nests in the comb away from the bee cluster.)

There is no dormant period in the tropics. The colony population drops, but the bees remain active throughout the dearth period. Management centers on having sufficient stores and sufficient bees to cover and protect the comb in the colony from wax moth.

Having sufficient honey stores in the colony is dependent on recognizing the need for them and not harvesting all of the honey. The amount of honey to leave varies in different regions depending on the length and severity of the dearth period. This is learned with experience in an area and is part of the "art" of beekeeping. If inexperienced in an area, leave at least a full comb of honey for every two frames of brood in a colony. It is better to leave too much than not enough. If the bees do not use it, you can harvest it later.

Though feeding bees is discouraged for most small-scale beekeeping projects, it may be practical in some areas or useful in certain situations. (See Chapter 7, page 146.)

To make a feeder for the KTBH, use a piece of wood the same length as a top bar and three times the width. Drill a hole in the board such that it will hold an inverted jar or bottle. Fill the container with sugar syrup (two parts sugar to one part water) and punch small holes in the top. The holes should not allow the syrup to drip once the jar is inverted. The bees will take the syrup and store it in the hive. If syrup leaks, it may draw ants or stimulate robbing. To help prevent robbing, always reduce the entrance of a colony with a block of wood or other object when you are feeding.

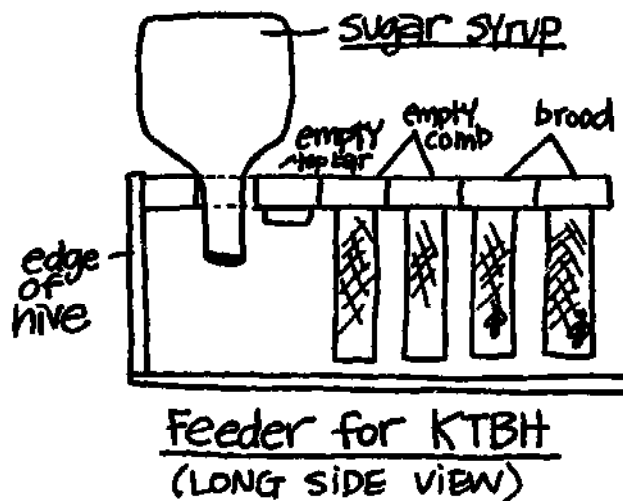

Protecting colonies from pests is another important aspect of management during dearth periods. Wax moth larvae are by far the most damaging pest to honey bee colonies, yet simple management practices can prevent this loss.

Wax moth adults may enter the colony to lay eggs or they may lay them along cracks on the outside of the hive. The larvae tunnel into the hive to the comb area where they hatch.

Wax moth

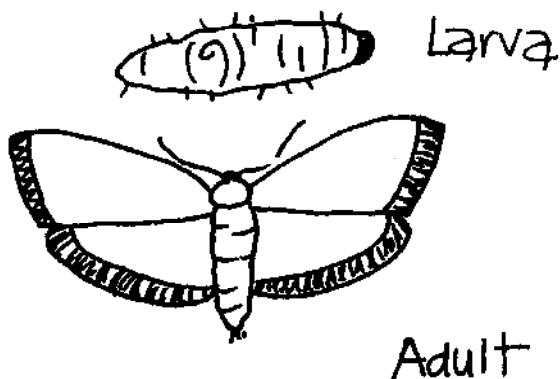

If the colony does not have enough bees to protect the comb, larvae of the wax moth begin to develop in them. The larvae tunnel through the comb eating the wax, the pollen residues, and the cocoons left by the emerging adult bees. Wax moths need more than just wax in their diet, therefore they prefer older, darker comb. They destroy the comb, leaving behind webbed masses of excrement and bits of wax.

Wax moth damaged comb

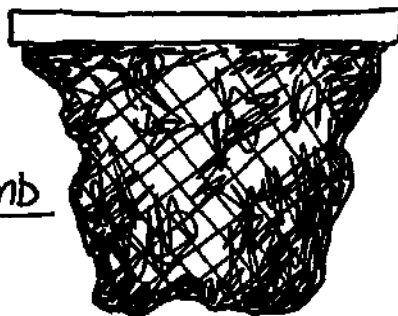

In weak colonies, wax moth larvae sometimes bore through the midrib of comb containing brood. The webbing that they leave behind entangles the developing bee pupae and prevents the adult bees from emerging from the cells. Patches or straight rows of apparently normal adults trying to emerge from the cells are the result. These bees eventually die and cell-cleaning workers remove them.

In warm regions and during warm periods in temperate regions, wax moths are always present and laying eggs. The bees in a strong colony are usually able to cover and protect all of the comb in the hive, thus they remove the wax moth larvae before they can do any damage.

However, if wax moth larvae become established in part of the comb, the bees tend to move away from the area, abandoning the comb to the larvae. At this point the colony is doomed, as the bees tend to lose their social organization. The population drops rapidly, and the few remaining bees are eventually pushed off the comb.

Wax moth problems are a result of poor beekeeping. The beekeeper takes too much honey from the colony, and it becomes too weak to guard the comb. Leaving too much empty comb in the hive during the dearth also causes problems with wax moth. The beekeeper must think of the strength of a colony both in terms of the absolute population and in terms of the ability of that population to protect all of the comb in the hive.

Good management for wax moth control is based on the following:

- Maintain strong colonies.
- Remove empty, unused comb from the hive during the dearth period. Put older, darker comb away from the brood nest so that it can be removed when it becomes empty.
- Keep the bottom area of the hive clean of residue that drops. Wax moths can build up in the residue and move onto the comb. Slanting the hive a little in the direction of the entrance helps the bees to remove this residue before it builds up.
- Do not leave comb lying around the apiary or stacked inside nearby shelters. This provides a good rearing site for the wax moth population of the area. Render unused wax into blocks instead of storing it as comb. The wax moth cannot complete its life cycle in blocks of pure beeswax.

Weak colonies can be combined to make strong colonies which have a better chance of survival during a dearth period. The queen of one colony must be killed to combine the colonies. A strong colony can be divided again later during the build-up period to increase the number of colonies. During the dearth period, the objective is survival of bees, not survival of colonies. It is better to have one colony that survives rather than two that die out.

COMBINING COLONIES

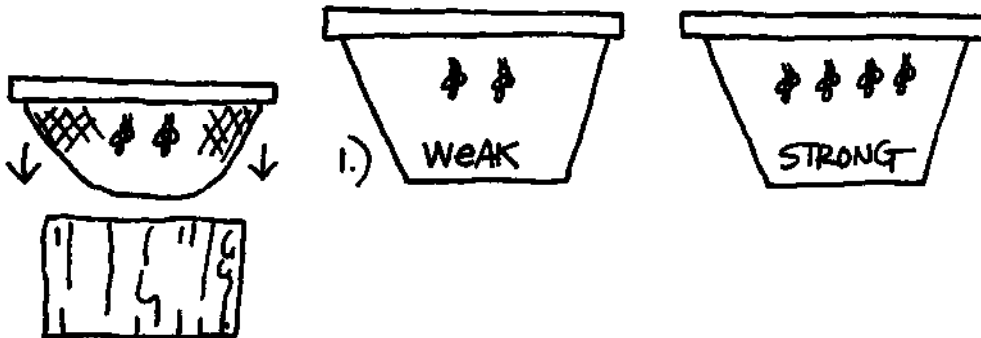

2) A special rectangular box is needed to hold the top bars of the weak colony; transfer the weak colony to the box.

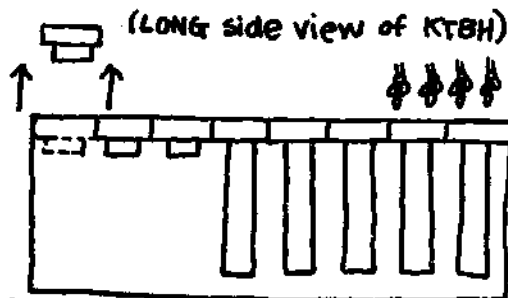

3.) Remove an empty top bar from the STRONG colony.

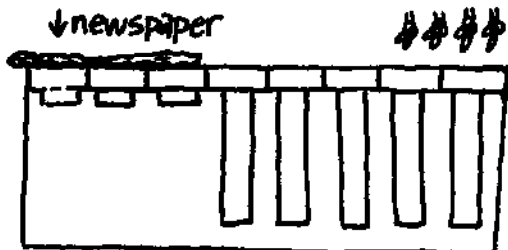

4.) Put a piece of newspaper over the empty space and slit the newspaper in a few places.

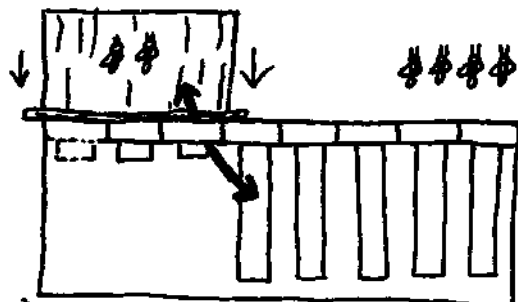

- 5.) Put the box with the weak colony on top. The bees will slowly remove the newspaper and the bees from the two colonies will combine.

NOTE: Since the bees combine slowly, they will not fight.

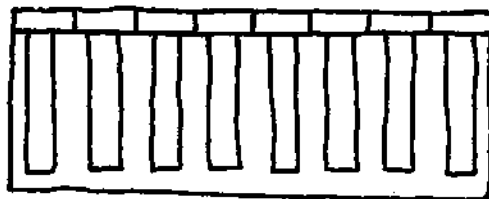
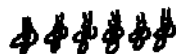

- 6.) When the bees have mingled, combine the combs and remove the box.

NOTE: The two colonies usually fuse together within one day. Also, keep the brood comb together when combining the combs.

Removing Old Comb

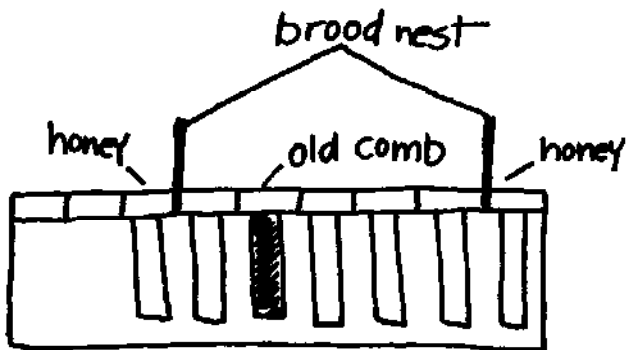

1.) Brood nest with old, dark comb.

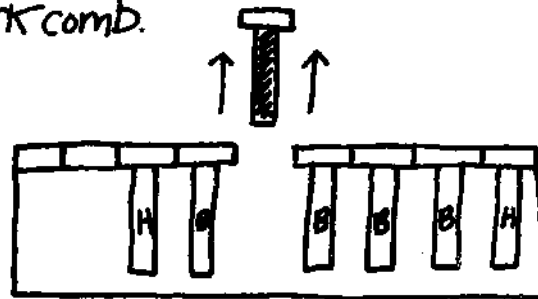

2.) Remove the old, dark brood comb from the brood nest.

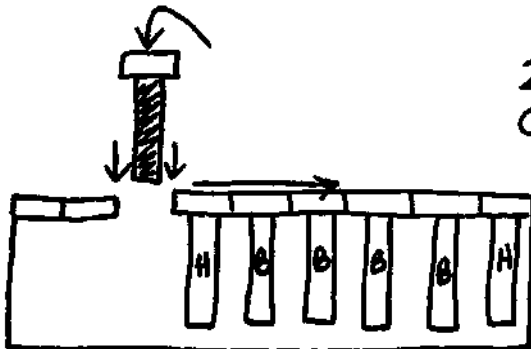

3.) Put the old comb away from the brood nest and move the remaining combs of the brood nest together.

NOTE: When all of the brood has emerged and the bees have removed the stored honey and pollen from the old comb, remove it and render it for the wax.

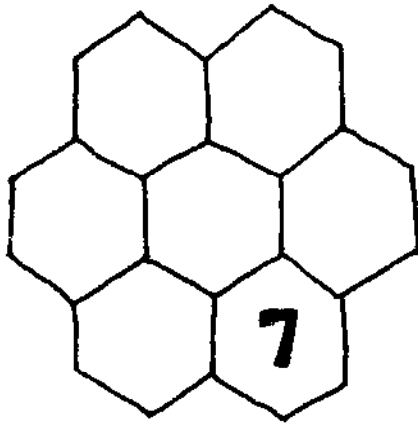

High-Tech Beekeeping

Inputs and Possibilities

Beekeeping is a simple technology. It cannot really be called high technology when compared with other high-tech agriculture. All the physical inputs needed for "high-tech" beekeeping can easily be produced in carpentry, tailoring, and tin-smith shops at the local level. A viable high-tech beekeeping system at this level would differ from that of a "developed" region primarily in mechanization. For example, human power would replace the motors of extractors.

The lack of understanding of how to construct and use the inputs is the factor that prevents the economic use of a "high-tech" beekeeping system in most small-scale development situations. The principles of hive management are the same for high-tech beekeeping as for intermediate technology beekeeping. High-tech beekeeping provides for more ease in manipulations and gives more options to the beekeeper. It also calls for a greater investment.

High-tech beekeeping will give greater return for the investment in most beekeeping situations. However, the options of a high-tech system must be fully used to realize such a return. The combination of lack of capital for investment and lack of understanding of timing, organization, and bee biology often makes the success of high-tech beekeeping difficult for small farmers.

A high-tech beekeeping system uses moveable frames in several boxes. This system allows for easy manipulation of combs. Both frames (containing combs) and boxes can be easily interchanged for management. Frames containing honey are removed from the hive, the cappings of the cells cut off with a heated knife, and the honey is centrifuged out of the comb in an extractor. The empty combs are then returned to the colony for the bees to refill.

Honey production is maximized at the expense of wax production with moveable-frame hives. Bees need to produce about eight kilograms of honey to produce one kilogram of wax. Because the empty combs are returned for refilling, honey production is enhanced.

Comb foundation, or sheets of beeswax embossed with the dimensions of worker cells are used in the frames. The main function of this is to produce strong comb centered in the frame. Sharply embossed foundation reduces the amount of drone comb constructed. Comb foundation also reduces the amount of wax that the bees have to produce, which also increases honey production.

Since the combs are attached to the frame on four sides, and the frame usually contains several strands of thin wire to reinforce the comb, hives can be easily moved with little chance of comb breakage. Therefore, migratory beekeeping can be carried out with moveable-frame hives.

In migratory beekeeping, colonies are moved to take advantage of the variations in the nectar flow between regions. This effectively increases the period of honey flow for the beekeeper. However, a good transportation system is necessary for this practice.

A moveable-frame beekeeping system also gives beekeepers the option to produce pollen, royal jelly, or queens in large numbers.

Pollen is collected by putting pollen traps on the hive entrance. These contain a wire mesh grid that scrapes the pollen off the legs of the returning foragers as they enter the hive. The pollen falls through another wire mesh too small for the bees to get through. It drops into a drawer-like collecting pan, and the beekeeper collects it regularly (usually daily).

Royal jelly is produced by using a queenless colony of bees. A strong colony of young bees is made up by shaking bees from the brood comb of several colonies. Such bees are mostly nurse bees, which have fully developed head glands and thus are good producers of royal jelly. The colony is given plenty of pollen and honey stores, but it is kept both broodless and queenless. After one day, frames with bars of artificial cell bases (queen cups) containing one-day-old larvae are given to the colony. Because of the queenless condition of the colony, the young bees are stimulated to rear queens.

To harvest the royal jelly, the larvae are removed from the cells after a few days, and the royal jelly scooped out.

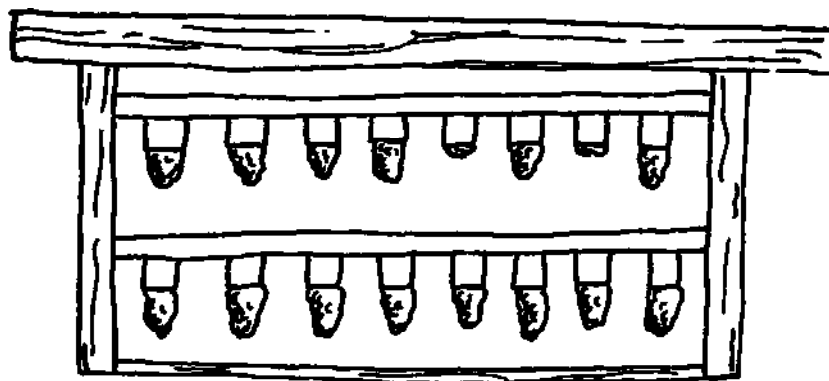

A frame of queen cells

To rear queens, the started cells are usually transferred to a strong colony for finishing. They are placed in a super with unsealed brood separated from the queen by a queen excluder, a grid which allows workers to pass through, but prevents the passage of the queen since she is larger.

Each cell is removed and placed in a small, queenless colony before the queen emerges. When the queen has mated and is laying, she is caged with a few workers and sold. Queens in cages can also be stored in colonies that do not have a free queen.

This is the assembly line production of queens. Maintaining queenless cell starter colonies and mating colonies calls for intensive management, though the beekeeper can control the process to obtain any number of queens when they are needed.

* * * * *

Good timing and organization are essential for success in rearing large numbers of queens, producing royal jelly, or producing pollen. These are specialized operations for specialized markets. They are not for beginning beekeepers nor for small-scale beekeepers.

Problems in Small-scale Development

In some areas, beekeeping development programs have introduced moveable-frame equipment to small farmers. The goal was a direct transfer of "high-tech" beekeeping. Those projects that have provided for continued technical assistance as well as continued availability of necessary inputs have been the most successful. These successful projects have often been associated with cooperatives.

In many cases, though, development programs have led to many people becoming bee-havers using relatively expensive equipment meant for beekeeping. In relation to the potential, little return was realized from their investment. These projects failed because they tried to go too far too fast. Equipment was made available, but technical assistance was poor or lacking.

You may encounter the remnants of unsuccessful projects. The equipment may be intact, though it is either not in use or not in optimum use. (If you are going to be working with an established bee project using frame equipment, consult one of the information sources given in Appendix A. Many cover the specifics of high-tech beekeeping.)

All of the management problems coming from the lack of understanding bee biology and the seasonal bee cycle are usually found in failed projects. There are also other problems which stem more directly from the attempt to use Langstroth equipment. Some of the more common problems are:

- poorly made equipment
- frames not spaced properly
- one-box brood chambers
- improper use of queen excluders
- lack of comb foundation.

The solutions to these problems are sometimes simple, but often misinformation or lack of understanding have established bad habits. Changing established practices is always difficult. Changing practices in an unsuccessful bee project is often made even more difficult because the people involved have lost enthusiasm for working with bees.

Many problems are caused by poorly-made equipment. The idea that a moveable-frame hive is merely a box with frames in it is widespread. The fact that since the hive is designed around the concept of the bee space and exact dimensions are important in construction is more difficult to grasp. Equipment is sometimes made without any regard for the bee space. This can be the result of lack of understanding or a consequence of poor workmanship. Many local carpenters lack the experience or proper tools to make precise measurements.

Boxes and frames not built around the bee space are really no better than fixed-comb hives. Frames that fit too tightly will be stuck onto the box with propolis. Removing them will be very difficult. If there is too much space between the frames and the box, comb will be constructed there. Removing the frames without destroying the comb is impossible. In these situations, any advantage of a frame system is lost.

There should also be a proper bee space between the top bars of the frames and the top of the hive. If it is lacking, the top will be stuck down with either propolis or comb. Either situation makes management difficult.

The hive with too little space between the frames and box can cause ventilation problems for the colony. This is especially detrimental in damp areas. Small spaces that the bees cannot reach also provide areas where wax moth larvae can hide.

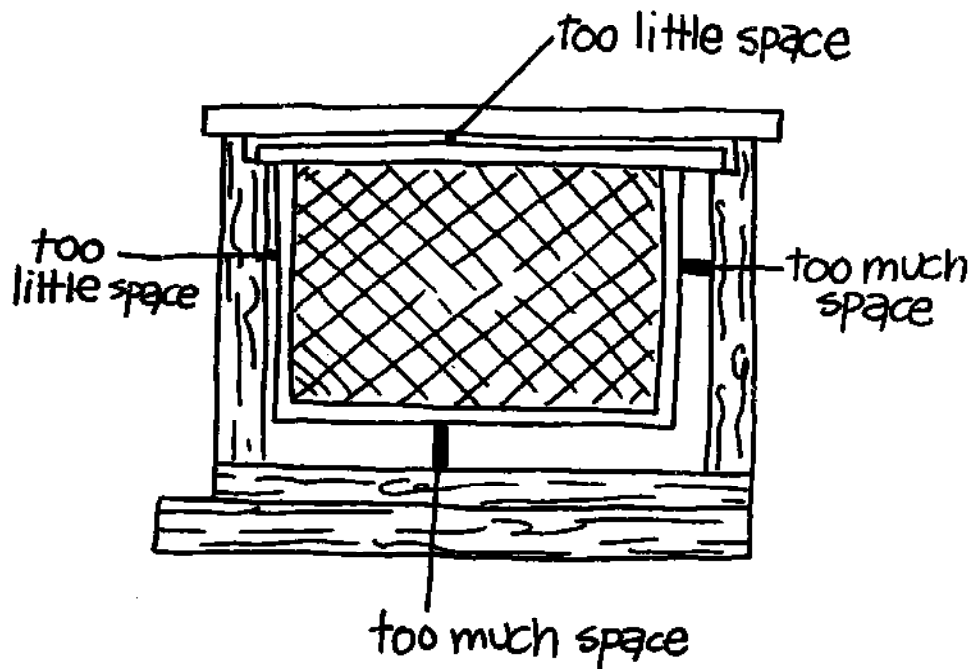

Space between the frames is also important. There should be sufficient space for the bees to construct full-size comb. Too little space will result in comb with shallow cells which cannot be used for brood rearing. Only small amounts of honey can be stored in such comb. On the other hand, if there is too much space between frames, the bees will construct comb between them. This makes frame removal difficult.

If frames are badly spaced and comb foundation is not used, the bees will construct their comb where they want. They will construct what is essentially a fixed-comb hive inside the frame equipment. Comb may even be constructed diagonally or perpendicular to the top bars. Frame removal is impossible in this situation.

Frames should be 35 mm center to center for European races of the western hive bee, and 32 mm for African races. For the eastern hive bee in India, the distance is 31 mm. Proper spacing allows the bees room to construct the comb and leave a bee space between the combs.

A bee space is needed between the top bars of the frames to allow the bees to move upward into the supers, thus frames are often constructed with a wooden ledge on the side bars to give the proper spacing. Such frames are self-spacing when pushed together. Good beekeeping habits call for assuring that the frames are properly spaced before closing the hive. Attention to this detail is often overlooked.

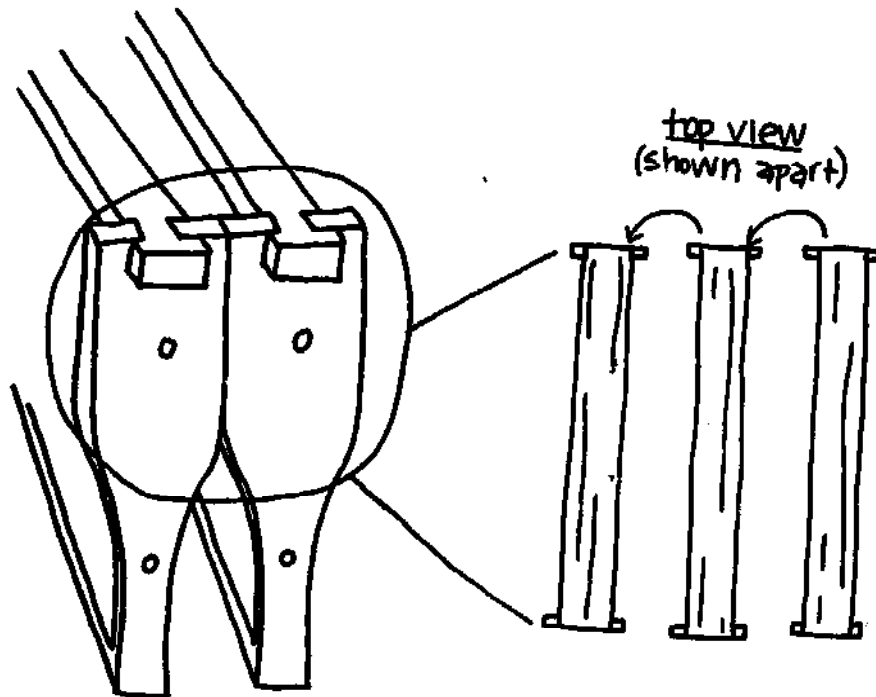

Frames that do not have the ledge on the side bars can be made self-spacing by using small nails. The nails should be on opposite sides of the frame, since this allows the frame to be turned either way in the hive and maintain proper spacing.

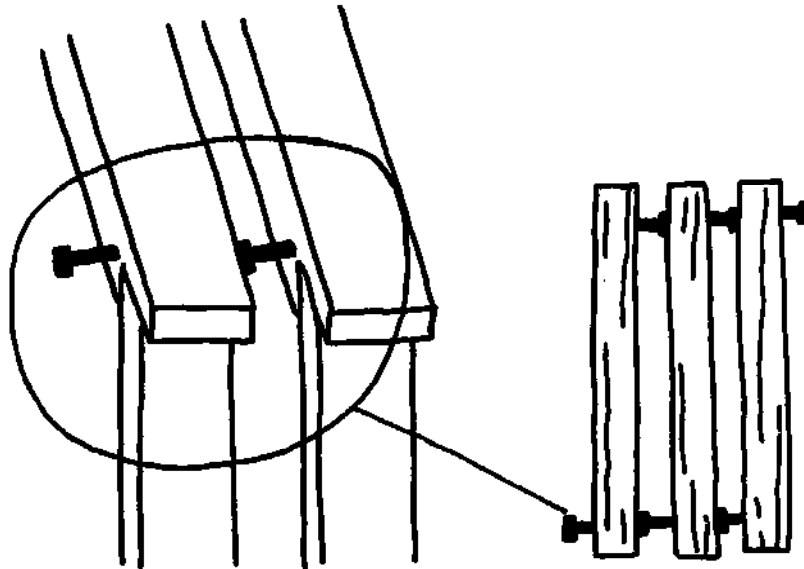

All wooden equipment should be well nailed. This is especially true of frames, which receive a lot of rough handling. Frames which break when trying to remove them frustrate beekeeping.

Wire should be used to reinforce both the frames and the comb. Use tin-coated wire to prevent rust; the zinc in galvanized wire will react with the honey, darkening it and changing its taste. An alternative is monofilament fishing line. Embed the wire or fishing line into the comb foundation with the edge of a coin.

The misconception that beekeeping with moveable-frame equipment entails the use of only two boxes is another common problem found in development projects. The erroneous idea is that one box is the brood chamber and the other is the honey super.

This idea perhaps stems from the term brood chamber. Since the term is singular, it implies that there is only one box. The brood chamber is that area of the hive that contains the brood. For a fully-developed colony, the brood chamber should consist of two boxes. Using only one brood box for the entire colony restricts its growth colony, and makes it hard to get supers containing only honey.

Good beekeeping needs at least three boxes, two for the brood chamber and one as a honey super. With two boxes for the brood chamber, the colony population will be higher. Thus, there will be better utilization of the nectar flow.

Switch the two boxes of the brood chamber periodically to provide more space for expansion of the brood nest. The natural tendency of the colony is to expand the brood nest in an upward direction. When the lower box contains mostly older larvae and sealed brood, and the queen is laying in the upper box, switch the boxes of the brood chamber. This puts the queen in the lowest box of the hive where she can again move upward as the cells in the upper box are emptied as the adult bees emerge. With this management, the queen moves upward into the brood chamber, not upward into the honey supers.

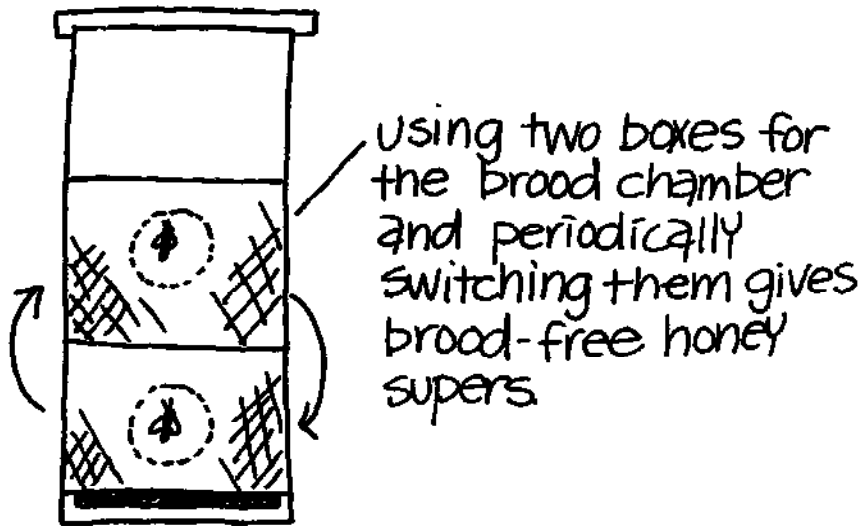

Only one super for honey increases the need for labor. The honey must be extracted several times during the flow period so that the colony always has room to store it. An alternative is to have two or more honey supers. These can be added to the hive to increase storage space. This alternative lowers labor needs, but increases investment in equipment.

Queen excluders are a necessary piece of equipment for specialized operations such as rearing and storing queens. However, they are detrimental to optimum honey production. For the hobby beekeeper who is more interested in convenience than honey yield, they are perhaps a useful gimmick. But they are not for the beekeeper interested in maximum honey production.

Queen excluders are commonly misused in development programs. They are especially expensive for these projects since they have to be imported. The fact that their use restricts honey production increases their real cost even more. The idea of their use is to produce brood-free supers, but this objective can be easily achieved through management and using more than two boxes for a colony.

Often when excluders are used in small-scale projects to restrict the queen to one box, nothing is done to alleviate honey-bound brood nests. This restricts the colony's growth and leads to a lot of swarming.

The proper use of queen excluders requires good timing and management. They are often used in place of management and left on the colony all the time. If used at all, they should be used only during the flow period. Using queen excluders during a dearth period prevents easy access by the bees, and allows wax moths to build up in the supers. This often results in high colony loss.

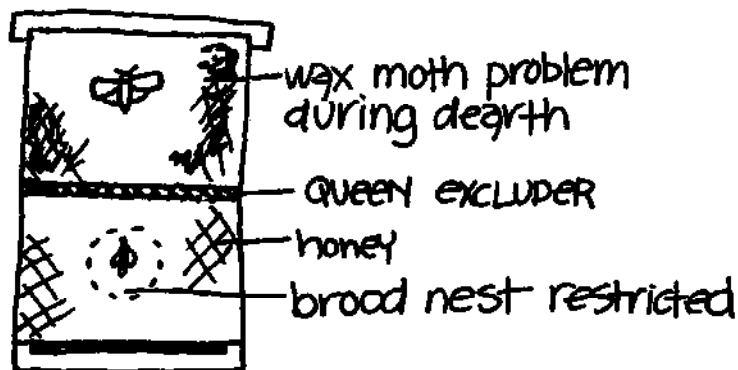

Problems with QUEEN EXCLUDER

If queen excluders are needed, a substitute for importing them is to use five-mesh (five holes per 2.54 cm) hardware cloth. In some regions this is called coffee wire. Try to use a quality of hardware cloth that is uniform and has smooth holes. Larger holes will allow the queen to pass; rough hardware cloth will tear the wings off the workers as they squeeze through. Mesh of this size may not work as well if the queens are small. This would apply to queens of the eastern hive bee and smaller queens of African races of the western hive bee.

Storing combs during the dearth season is necessary for good management of a moveable-frame beekeeping system. This is especially difficult in the tropics since the wax moth is active throughout the year. To prevent damage to the combs by wax moth larvae, the boxes containing the frames and combs should be tightly sealed and treated with chemical fumigants.

Fumigants are volatile, toxic gasses which dissipate and leave no toxic residues. Their application is limited to enclosures which are relatively gas tight. As most fumigants are extremely toxic and often highly flammable, you should be cautious in recommending their use. Using fumigants safely requires special equipment and training.

A relatively "safe" fumigant is sulfur dioxide because the gas has an irritating, obnoxious odor. It can be generated by burning sulfur moistened with alcohol. Both of these products are available in pharmacies. (The gas is also corrosive since it forms sulfuric acid in the presence of moisture.)

Another relatively safe fumigant is aluminum phosphide which is used to treat stored-grain products and is available in many agricultural supply stores. The chemical is sold as a tablet in a sealed container. When exposed to moisture in the air, phosphine, a toxic, flammable gas, is released. A sulfur compound included in the tablet releases hydrogen sulfide, a noxious gas, which makes this product safer to use.

A stack of supers sealed with mud or with strips of newspaper glued on with flour paste (any starch flour and water) can be easily treated with burning sulfur or with aluminum phosphide.

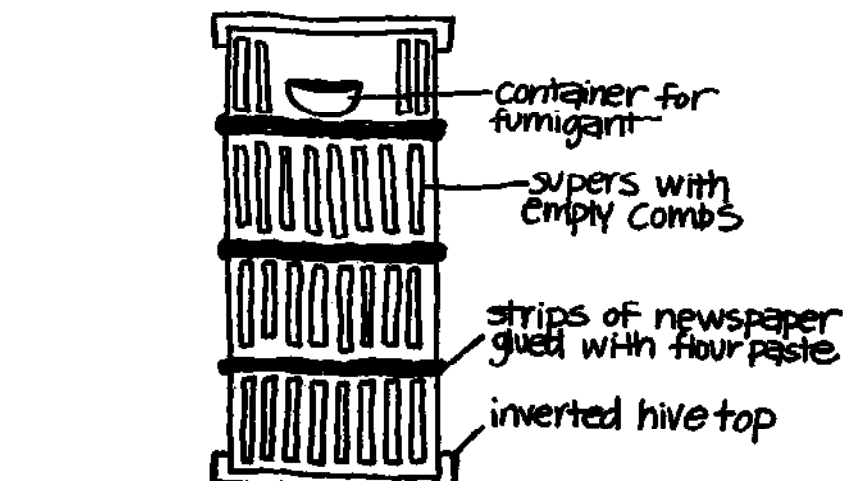

Treating supers of empty comb for
Wax moths

Remember: Fumigants are also toxic to humans and other animals. Follow all proper precautions when using them.

Once the comb has been treated, use moth balls to prevent adult wax moths from laying eggs. Check stored combs periodically for reinfestation with wax moth larvae. Do not use any type of chemical insecticide to treat comb for wax moth. These chemicals may be absorbed by the wax and kill the bees when the combs are placed on a hive.

The lack of comb foundation is sometimes a barrier to beekeeping development projects. Comb foundation is often difficult to obtain. It is also expensive. The people involved in the beekeeping project become dependent on this input since it is introduced to them with the hive equipment. This becomes a psychological barrier due to a lack of understanding of bees and why comb foundation is used in the frames. With such an understanding, you can stretch the supply of comb foundation on hand or improvise suitable replacements.

The main purpose of comb foundation is to guide the bees to construct comb centered in the frame. A narrow strip (about three centimeters) of foundation stuck in a groove centered in the top bar will serve for this. Several starter strips can be cut from each full sheet of foundation. A ridge of beeswax stuck down the middle of the top bar like that used on the top bars of the KTBH also works for this. Yet another alternative is to stick small pieces of comb on the top bars.

Starter strips of beeswax can be made by using a dip board (see Appendix C). These strips will not be embossed, but this is not important since the purpose of the strips is only to guide the bees to start building the comb.

Another minor purpose of comb foundation is to guide the bees to construct comb containing worker cells. If you are using only starter strips, you can achieve mostly worker cells if you use small, rapidly-growing colonies to construct comb. Such colonies construct little drone comb since no drones are needed in the hive.

It is also possible to make a mold to produce comb foundation. (See Appendix C.) Buying beeswax and producing foundation to supply local beekeepers can be a good business opportunity for a family involvement in beekeeping.

Remember that correct frame placement (the center to center spacing) is also important to produce centered comb. This, combined with some type of "starter guide," is necessary to get centered comb. However, full sheets of comb foundation are a beekeeping luxury, not a necessity.

A bad practice unrelated to type of equipment which is often seen in high-tech development programs is the mass feeding of apiaries. Large, open containers of sugar syrup are put in the apiary to feed the bees. This is usually done in areas where sugar is cheap and readily available.

Proper feeding of colonies should be based on the needs of the colony, and each colony should be fed individually. The practice of putting large barrels of sugar water in the apiary for feeding is wasteful. Not only does this feed the bees in the apiary, but it also feeds wild insects as well as bees from other apiaries.

Usually, only the weaker colonies in an apiary need feeding. They benefit little from mass open feeding. The stronger colonies are the ones that benefit most since they have the foragers to take advantage of the sugar water.

This feeding method also encourages robbing. When the sugar syrup is finished, the stronger colonies often rob out the weaker colonies. Thus this method can lead to the death of the very colonies it attempts to help.

Most of the food value of the sugar syrup is used by the bees in the intense flight activity of robbing. The colony that robs honey actually gains very little. Thus, the beekeeper usually loses more than is gained with open feeding.

To be economically viable, feeding colonies must be part of an overall intensive management scheme. In some beekeeping situations, feeding is wrongly used as a substitute for good management. It is not recommended for most small-scale beekeeping.

In any beekeeping development project, the transfer of knowledge, or teaching people how to use the equipment, is the most difficult aspect. It is a slow, on-going process. Patience and a sense of humor are important assets.

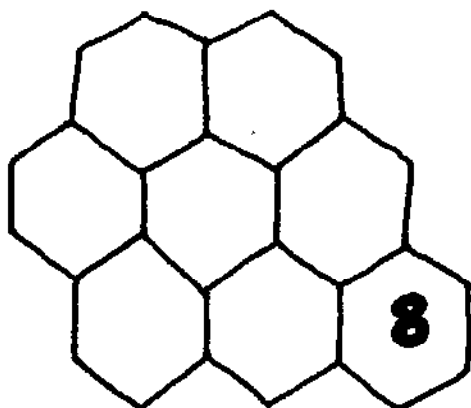

Hive Products

The best known hive product is honey, which is valued both as a food and as a folk remedy. Beeswax is another major hive product, though neither its uses nor its value are as widely known as those of honey. Honey and beeswax are products in any beekeeping project, and their production and marketing mesh well with most small-farm situations.

Other hive products are pollen, royal jelly, propolis, bee venom, bee brood, and bees (queens and packages). All of these involve either special management practices and equipment or highly-specialized markets. Their production and marketing are not practical for beginning beekeepers.

Honey is the primary hive product. It is basically nectar from which the bees have evaporated most of the water content. In converting the nectar to honey, the bees also add enzymes which serve mainly to break complex sugar molecules down into simple sugar molecules.

The characteristic tastes and properties of honey depend upon the floral sources of the nectar. Thus honey from different regions and from different periods during the nectar flow is different in taste and physical properties. Generally, darker honey is stronger-tasting.

Nutritionally, honey is virtually pure carbohydrate. It contains only trace amounts of other substances. The greatest nutritional attribute of honey is that it consists of simple sugars. These sugars do not need to be digested, but are assimilated directly by the body. This makes honey a quick energy source.

Honey is a natural sweetener. It can be eaten as is or used in any type of cooking or to sweeten beverages. In some regions, honey is traditionally used to prepare special foods for certain occasions. It is also widely used in folk medicine. Honey has a long history as a wound dressing, for example. Its bacteriostatic property (inability to allow bacterial growth) helps to control infections.

Honey is also used in some areas to make alcoholic beverages such as mead or honey wine. In parts of Africa, honey beer is a traditional and popular beverage.

Honey is a widely known and used product. Yet in marketing honey, it is important that consumers have confidence that they are getting what they are paying for. Thus the most important aspect of honey processing is maintaining quality. A good quality honey in which potential users have faith is essential to establish and maintain marketing outlets.

Absence of foreign material is the main criterion of quality in honey. Bits of wax or propolis, pollen, brood, dirt, dead bees, or ashes can contaminate honey during extraction or processing. But the most insidious honey contaminant is sugar water deliberately added by dishonest beekeepers. Good beekeepers who strive to avoid contaminating their honey either deliberately or in processing will be rewarded with a steady market for their product.

For harvesting honey, use combs that contain only honey and have at least two-thirds of the cells sealed. Preferably use only lighter-colored combs. Dark comb contains propolis, which can impart a strong taste to the honey. Using only honey comb prevents contamination from brood and minimizes the pollen in the final product.

Removing Honey From Comb By Pressing

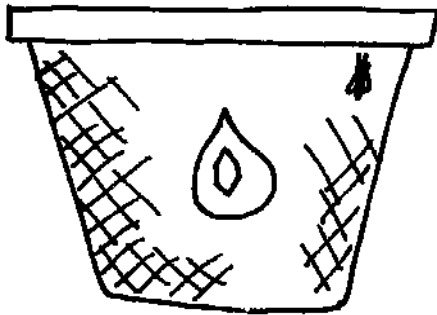

1.) Harvest only comb containing honey.

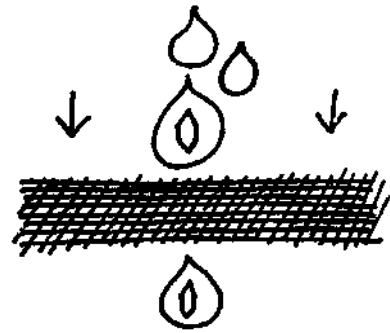

3.) Strain through fine material (cloth or screen).

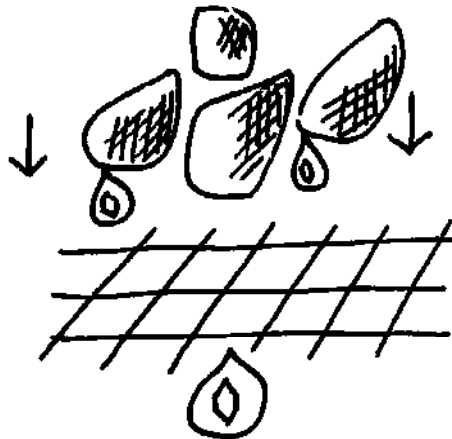

2.) Cut up the comb or squeeze with hands... strain through coarse strainer or screen wire.



4.) Bottle and cap the honey.

All honey contains some pollen. Too much pollen in honey is mostly an aesthetic concern. A high pollen content gives honey a cloudy appearance and can also give it a stronger taste. Pressed honey, or honey that is removed by squeezing it from the comb, has a higher pollen content than extracted honey. (Extracted honey is removed from the comb by centrifugal force. The liquid honey is spun out of the comb, and the solid pollen remains.)

Water content is also important to the quality of the honey. All honey contains yeasts. To prevent the growth of the naturally-occurring yeasts and the subsequent fermentation of the honey, the water content of the honey should be below 19 per cent. Such honey is said to be mature or ripened. Nectar that has a water content above 19 per cent is called green or unripened honey. Yeasts cannot grow in ripe honey because of osmotic imbalance; there is no water available to the yeast cells for growth.

Once the bees have ripened the honey, they seal the cells of the comb. Use only honey comb that has most of the cells sealed for harvesting honey. This is the beekeeper's assurance that the honey is ripe and will be self-preserving. Ripe honey stored in closed containers in cool places will keep for long periods. It does not need refrigeration.

Pressed honey is the type most easily produced in small-scale projects. To minimize the pollen content of the honey, check the comb for stored pollen before squeezing out the honey. (The pollen can be seen by looking through the comb toward the sun or a light.) Areas of comb that contain large amounts of pollen can be cut out. Remove the honey from the comb that contains pollen separately, and use it for home consumption. (The pollen and comb can also be eaten. Pollen is a nutritious food.)

After the honey is removed from the combs, put it in a sealed container. Honey is hygroscopic; it absorbs moisture from the air. If left exposed in humid environments, the moisture content will rise and the honey will ferment. Dead bees or brood in honey can also raise the moisture content as well as aesthetically contaminate the honey.



Fermented honey contains bubbles and foam.

That is why adding water to increase the volume of the honey is a no-win situation. It quickly leads to fermented honey and dissatisfied customers. Adding sugar water does not cause a problem with fermentation provided the sugar concentration is high enough, but it does lead to dissatisfaction among the users of the honey.

People who buy honey and pay honey prices want honey. They do not want sugar water mixed in the honey. Unfortunately, extending honey with sugar water is practiced by some beekeepers and by some honey sellers in local markets. Even if the beekeepers are not involved in the adulteration, they get the ultimate blame and lose the most, for it is their product which loses credibility.

Selling honey in the comb is one way to assure buyers of a quality product. Comb honey is sealed in the hive by the bees, therefore buyers can be confident that the honey has not been adulterated with sugar water. Marketing honey in the comb is especially apt for beekeepers using the KTBH or other intermediate technology systems.

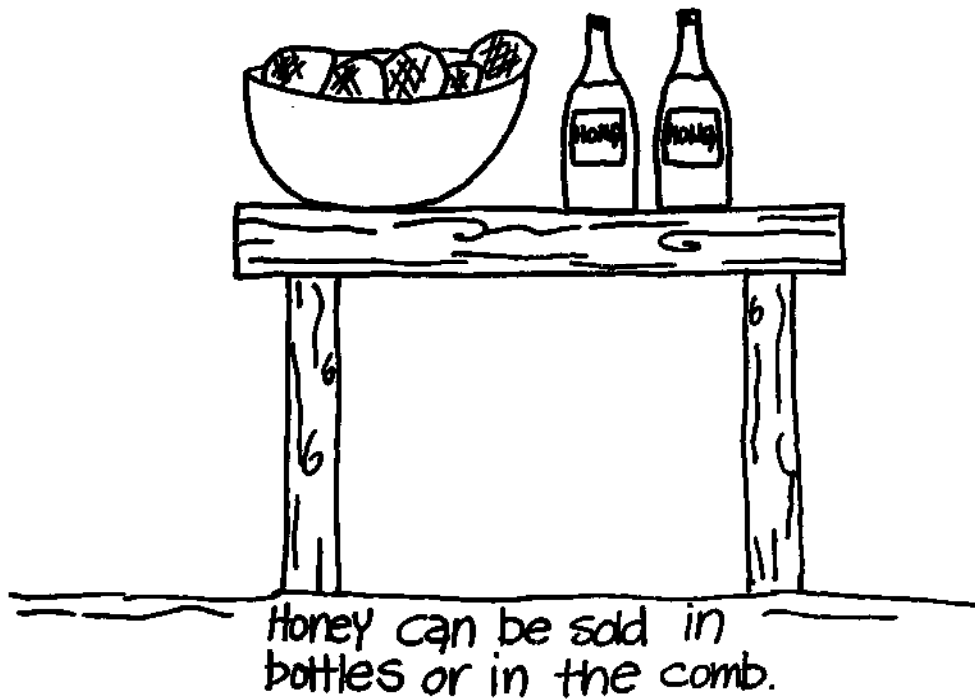

A common misconception is that granulated or crystalized honey is proof of adulteration with sugar water. Honey can granulate whether or not it has been adulterated. Honey is a supersaturated sugar solution, thus crystalization is normal. Some honey from certain floral sources is especially prone to crystalize.

Crystalized honey is not spoiled. It can be liquified by heating it slowly. This is best done by putting the container of honey in warm water since heating honey directly can caramelize the sugars, giving it a burnt taste. Heating honey does change the taste, so it is best to avoid the use of heat when processing honey for marketing.

In the bulk processing and packing of honey, heating is sometimes used to destroy sugar crystals. This prevents crystalization when the honey is bottled. (This heating is not a pasteurization process. Pasteurization kills off bacteria. This is not necessary with ripe honey since these organisms cannot grow in a sugar solution with such a low water content.)

The heating process is carefully controlled and regulated. (The temperature is maintained at 63 degrees C for thirty minutes.) Sophisticated equipment is needed since excess heat alters honey and lowers its quality. Thus for small-scale beekeeping, avoid using heat for processing.

Heat is also used to process wax and to recover the residue of honey left in the combs after they have been squeezed or drained. Use this honey for home consumption, as its quality is lower.

In rare instances, bees produce honey that is poisonous to humans. This occurs in a very few regions. It sometimes results when nectar secretion fails in the usual bee forage due to abnormal environmental conditions. The bees are then forced to collect nectar from plants which they would normally not visit.

All of the honey produced by the colony during the year would not be poisonous. Only honey made from the poisonous nectar would be harmful. This fact is often recognized by local beekeepers, and honey produced during certain periods is not harvested.

Normally, poisonous honey is not produced every year. By knowing the source of the poisonous nectar and noting when bees are visiting the flowers, the beekeeper can prevent the possibility of poisoning.

Various tests are available to bulk buyers of honey to check on the purity and quality of honey. If a bee project develops to the point where it is selling to these buyers, quality will make the difference in the price received as well as whether or not they will be able to sell at all.

The idea of quality is important to stress from the beginning. Make quality a habit. Even with fixed-comb hives, a better quality honey is possible if care is given to harvesting and processing. Many areas have a virtually untapped local market for honey. Quality is important to capture this market and to keep it.

Beeswax is a hive product whose value is not recognized at all in some areas, while in others it is considered more valuable than honey.

The wax of the western hive bee (Apis mellifera) differs from the beeswax produced by the Asian species of honey bee (A. dorsata, A. florea, and A. cerana). Wax of the Asian species is called Ghedda wax and is less desirable than that of the western hive bee for international marketing purposes.

Pure beeswax is harder and has a higher melting point (64 degrees C) than most other waxes. These properties make it more desirable for certain applications. Beeswax is used industrially in cosmetics, pharmaceuticals, polishes, and candles. Uses for beeswax on a small scale include:

- candle-making
- lost-wax casting of metals
- wax printing and batiking of cloth
- polishes for wood and leather
- strengthening and waterproofing thread for sewing
- treatment of cracked hooves of domestic animals
- making of comb foundation or wax starter strips for beehives.

Many of these crafts and practices already exist, and can furnish a ready outlet for beeswax. Check with people engaged in these activities to find leads in developing a local market for beeswax.

(See Appendix D, Uses for Beeswax.)

All old combs and pieces of wax should be saved for rendering into wax blocks. Old combs should be rendered separately from newer ones since the newer combs yield a higher quality wax. Dark combs contain propolis and cocoons which lower the quality of the wax.

Comb stored in pieces is highly susceptible to wax moth damage. With a solar wax melter, small pieces of comb can be rendered easily as they are cut from the hive and made into blocks. There is no need to accumulate a lot of comb to render at one time as is the case with rendering wax with hot water.

Comb to be rendered can be stored for short periods in sealed plastic bags with moth balls (paradichloro-benzene or PDB) to prevent wax moth damage. Check the stored comb periodically for evidence of wax moth larvae. The PDB only prevents the adults from laying eggs, it does nothing to developing larvae. Stronger fumigants can be used, but these are generally impractical for small-farmers.

Most methods of rendering wax use hot water to melt it. They are based on the fact that beeswax floats in water. A few words of caution are in order, however:

- Never use iron, zinc, brass, or copper containers for beeswax, as they discolor the wax. Use enamelled or aluminum containers.
- Be careful with melted beeswax, since it is highly flammable. Do not allow the beeswax-water mixture to boil vigorously. Boiling beeswax lowers its quality by making it more brittle.
- Blocks of rendered beeswax can be stored in cool, dry places for long periods without harm. They should be wrapped in paper or plastic.
- Never store beeswax near pesticides. Beeswax absorbs many such chemicals, and they can kill bees if this wax is used to make comb foundation.

Rendering Wax : METHOD I

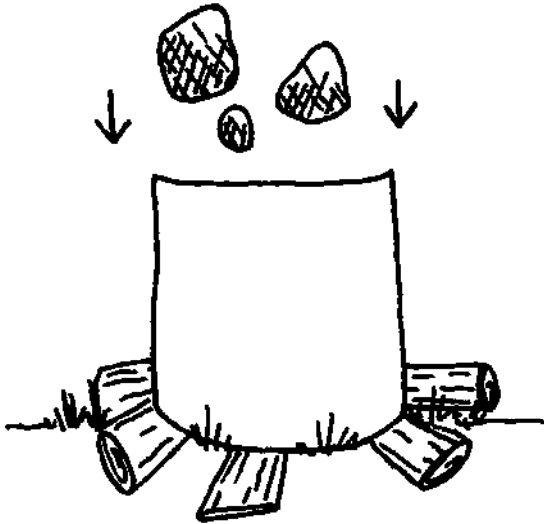

1.) Put comb in pan of water.



3.) When melted, strain through screen.

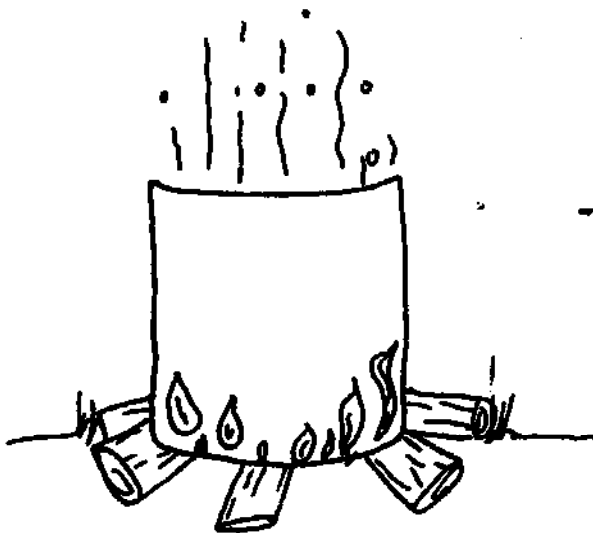

2.) Heat water until wax is melted.
(Remember - Do not boil! It's flammable!)

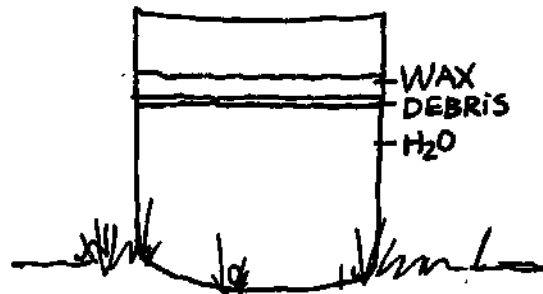

4.) Leave this until wax hardens.

5.) Remove wax block and scrape debris off bottom.

Rendering Wax : METHOD II

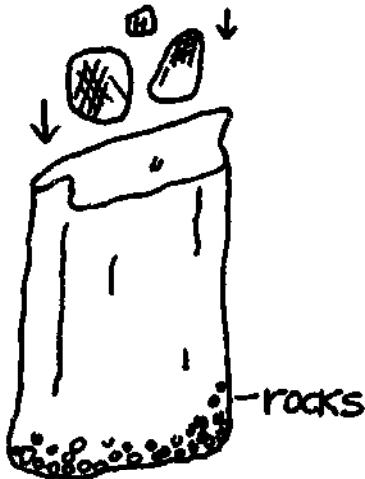

1.) Put comb in burlap bag, with rocks to weigh it down.

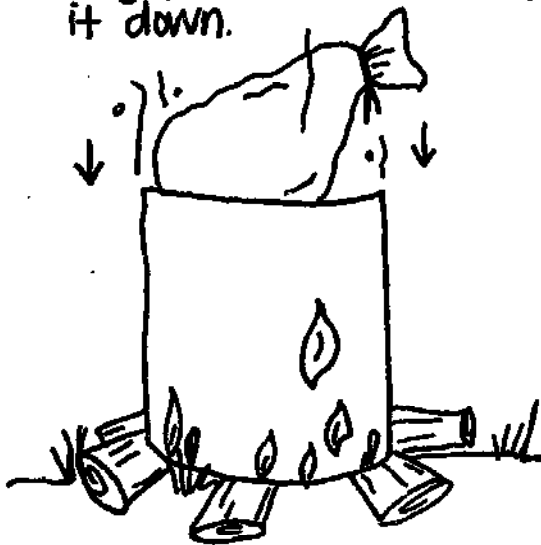

2.) Put bag in hot water.



3.) stir bag around as wax is melting.



4.) When wax is melted, set aside and allow the wax to harden.

5.) Hot wax can be poured into molds, if desired.

NOTE: If block cools slowly, there is less cracking.

Pollen has only recently been thought of as a hive product for human consumption. Previously, it was collected by beekeepers during periods of heavy pollen flows and then fed to the colonies at the beginning of build-up periods to stimulate brood-rearing.

The interest in pollen as human food is usually found only in large urban centers where there is a specialized market for natural foods. From a nutritional viewpoint, pollen is a rich source of proteins, vitamins, and minerals, though economically it cannot compete with conventional sources of these nutrients. The many medicinal claims for pollen have not been substantiated, and some people have even developed allergic reactions to ingested pollen.

Pollen is collected by forcing the returning foragers to pass through a five-mesh (five holes per 2.5 cm) wire grid. The pollen pellets are scraped from the pollen baskets on the workers' hind legs and fall into a collecting tray covered with a smaller mesh wire to prevent the bees from retrieving the pollen. Several designs of pollen trap are used. (See sources in Appendix A.)

Pollen collecting is not recommended for beginning or most small-scale beekeepers. The colony needs pollen to rear brood, thus only limited amounts can be removed or the colony will become weak. This entails monitoring the colony closely. Trapping pollen is more efficient in areas where there are intense flows. In most areas of the tropics, pollen collecting is difficult since the flows are weaker and the yields are low.

Pollen also spoils quickly. The traps should be emptied often (daily in humid weather) to prevent pollen from molding. Once the pollen is collected, it must be quickly dried or frozen. Direct sunlight and too much heat reduce the nutritional value and quality of the pollen, thus special facilities are needed for processing and storage.

The problems involved in collecting and processing pollen, coupled with its limited market, make it an impractical product for most small-scale beekeepers.

Bee brood is a potential hive product for local use. It can be used as animal food or as human food in areas where insects are accepted in the human diet.

Brood is the developing adults of the colony, so only drone brood should be used. Cut out the areas of comb that contain the brood and remove the brood from the comb by shaking or picking it out. Older larvae are easier to remove since the cells do not have to be uncapped.

After the brood is removed, the comb can be rendered for the wax. Comb containing brood can also be given directly to chickens. They will remove the larvae and pupae, though the beeswax will be lost as they destroy the comb.

For human food, the brood can be eaten raw or dried, or skewered and roasted.

* * * * *

Pollen, royal jelly, propolis, bee venom, and bees (queens and packages) are hive products which call for experience in beekeeping and specialized skills in production and marketing. Production of these is not as a rule for the beginning beekeeper nor for most small-scale farmers.

More information on these products is available in some of the sources listed in Appendix A.

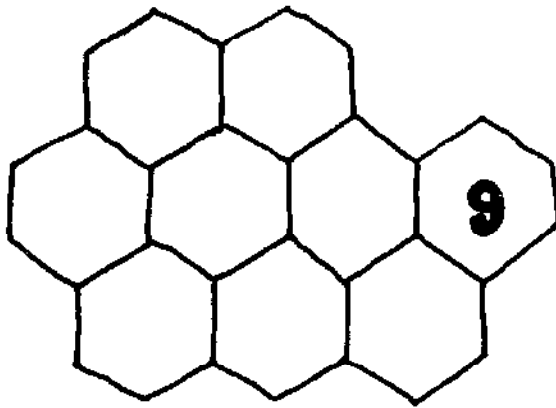

Diseases, Pests, and Insecticides

Diseases are more of a problem where intensive beekeeping is carried out because of the large numbers of colonies concentrated in small areas. The economic impact of diseases is also greatest where the financial investment in beekeeping equipment is the greatest. These two factors ameliorate the impact of disease on small-scale intermediate technology beekeeping.

The concept of disease being caused by microscopic agents is not readily accepted by many people living in developing communities. It is sometimes difficult to convince beekeepers in these communities of the need for effective disease control programs. This is especially true if such a program calls for destruction of colonies or purchasing expensive drugs. Moreover, the drugs themselves are rarely readily available in these communities.

Fortunately, many areas are free of at least some of the diseases and pests which affect honey bees. This is a major reason to limit imports of bees.

In areas where beekeeping is established, it is possible to consult with other beekeepers on diseases present and control measures used.

MAJOR HONEY BEE DISEASES

Disease	CAUSAL AGENT	STAGE AFFECTED	PRIMARY SYMPTOMS
- American foul brood (AFB)	bacteria	older larvae and pupae	<ul style="list-style-type: none"> - shotgun brood pattern - dead brood have foul smell - dead larvae are soft, sticky and ropy - sunken caps with holes in them
- European foul brood (EFB)	bacteria	young larvae	<ul style="list-style-type: none"> - shotgun brood pattern - dead larvae have foul smell - dead larvae are pasty
- chalkbrood	fungus	unsealed larvae	<ul style="list-style-type: none"> - dead larvae have yeasty smell - dead larvae form dry chalk-like mummies - whitish
- sacbrood	virus	older larvae	<ul style="list-style-type: none"> - dead larvae with tough skin forming sac with darkish liquid - no smell
- Nosema	protozoa	adult	<ul style="list-style-type: none"> - bees disoriented and wings not folded normally over abdomen
- Acarine	mite	adult	<ul style="list-style-type: none"> - similar to Nosema
- Varroa	mite	older larvae, pupae and adult	<ul style="list-style-type: none"> - presence of mite on larvae and pupae - deformed adults

Honey bee diseases that affect the brood cause the most problems. Since brood represents the future adults of the colony, these diseases can quickly weaken a colony.

American foulbrood (AFB) and European foulbrood (EFB) are the most serious honey bee diseases. (The names have nothing to do with their distribution, but describe where they were first recognized.) Bacteria cause both of these diseases. The bacteria kills the developing brood and causes its decay within the cells of the comb. The decaying mass has a characteristic putrified smell, hence the name foulbrood.

These diseases result in a spotty or shotgun brood pattern -- there appear to be many empty cells scattered about in the brood nest. A poor queen or lack of food resources can also give a shotgun brood pattern, but in this case the cells are completely empty. In a foulbrood diseased colony, the "empty" cells usually contain the decaying remnants of the larva or pupa. The adult workers are unable to remove the remains of the brood until they dry.

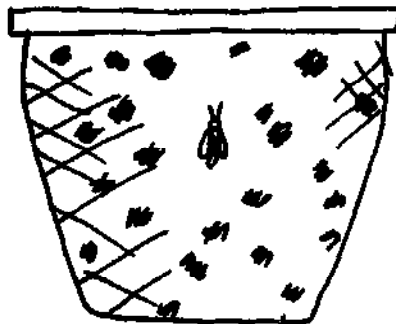

A diseased
brood pattern
is spotty.

The age of death of the brood is the main criterion for distinguishing between AFB and EFB. AFB affects older larvae and pupae, thus death occurs after the cell is sealed. When the brood dies, the cap on the cell sinks inward. The adult workers often tear a small hole in the sunken cap.

Cell caps torn open

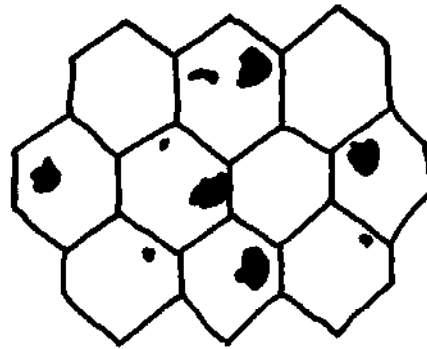

American foulbrood

EFB causes death of the larvae before the cell is sealed, thus the dying larvae can be seen. Larvae dying of EFB are creamy-white to brown in color and are twisted in the cell.

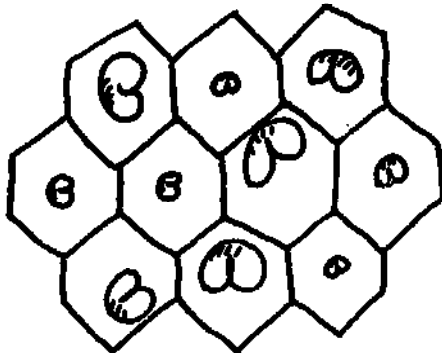

Larvae twisted in cell

European foulbrood

Another difference between AFB and EFB is the consistency of the decaying mass. In AFB, it is generally sticky and tends to "rope out," or adhere to a stick that is pushed into the mass and then pulled out. The dried scale of the AFB-killed brood also tends to adhere tighter to the side of the cell.

The bacteria that causes these diseases is often spread by the beekeeper. Be careful not to give diseased brood to a colony when adding brood to strengthen it. Also, never combine a diseased colony with a healthy one. (It may be beneficial, though, to combine two diseased colonies. It is easier to treat one colony, and a strong colony has a better chance of overcoming the disease.)

Contaminated hive tools can also spread foulbrood. After working with a diseased colony, stoke up the smoker and put the hive tool in the fire to sterilize it.

The most common mode of foulbrood transmission in poorly-managed apiaries is robbing. A diseased colony eventually becomes weak and susceptible to robbing. The robber bees take the contaminated honey back to their hive and transmit the disease. It is therefore important to recognize diseased colonies and to deal with them before they become so weakened that they are susceptible to robbing.

The possibility of transmitting foulbrood, especially AFB, between colonies is one reason why beekeepers should never feed their bees honey. Foulbrood-contaminated honey is all right for human consumption, though, since the bacteria are harmless to people.

Antibiotics are useful for treating foulbrood, but their use can lead to problems for beekeepers who do not completely understand the disease process or the proper method of treatment.

The cause of American foulbrood is a spore-forming bacteria. Antibiotic treatment of AFB-infected colonies can eliminate all symptoms, but the disease will return when treatment is stopped because the spores are not affected by the drug.

Effective control of AFB centers on destroying diseased colonies and disinfecting contaminated equipment to prevent the spread of infection. These measures are difficult to implement in most small-scale beekeeping projects.

Since the bacteria which causes European foulbrood does not form spores, this disease can be successfully eliminated with proper antibiotic treatment using proper dosage and regular application.

Correct identification of the type of foulbrood present is important since AFB cannot be effectively treated with drugs but EFB can.

Treat EFB with a mixture of sugar and terramycin. Pound or grind the sugar to powder and mix it with the drug. The mixture should be 20 per cent terramycin (by weight). Sprinkle a heaping tablespoon of this mixture in the colony near the brood nest every three or four days for one month. Even though the symptoms of the disease disappear soon after starting treatment, it is important to continue treating to eliminate the bacteria completely from the colony.

Commercial mixtures of sugar and antibiotics for foulbrood treatment are available in some areas, but it is usually much cheaper to purchase some pure terramycin and make your own mixture. Terramycin is available in livestock supply stores.

Using terramycin in sugar syrup is not recommended because the drug breaks down rapidly in a liquid medium.

Beekeepers often sporadically apply a low drug dosage to EFB-diseased colonies. They either use too little drug in the mixture or do not treat often enough. This suppresses the disease, but it does not cure it. This also creates conditions where the disease organism can develop drug resistance.

Improper use of antibiotics can also result in the harvested honey being contaminated by the drug or by breakdown products. Some countries have legal standards which prohibit the marketing of contaminated honey. Drug-contaminated honey is not pure honey, thus it cannot be marketed as such.

To avoid drug contamination of honey, do not give drugs to the colony for four weeks before harvesting.

* * * * *

Starvation is sometimes confused with disease. A starving colony will open brood cells and pull the brood out. The bees will eat some of the brood and throw the other brood out of the hive. The colony will be agitated and often will be defensive. Starvation can be confirmed by the absence of any nectar or honey stores in the hive.

The other two brood diseases, sacbrood and chalkbrood, are generally benign and self-limiting and thus do not call for treatment. (There is in fact no drug treatment for either of these.) Both are stress-induced diseases. It is important to recognize these diseases only so as not to confuse them with the more serious foulbroods.

Sacbrood is caused by a virus and is usually found only around the edges of the broodnest. It usually results when the brood has been chilled because there were not enough bees to completely cover the brood area.

Sacbrood is more likely to be confused with foulbrood than is chalkbrood. The absence of any putrid smell of the dead brood is the most distinguishing feature of sacbrood. The dead larva also remains intact as the virus does not attack the skin. This is different from foulbrood, where the dead brood becomes a mass of decayed material.

Chalkbrood is a fungal disease and is distinctly different in appearance from the other brood diseases. Infected larvae swell to fill the cell as the fungal mycelia (strands) grow. At this stage, the mass is soft and has a yeasty smell. The mass dries into a hard, whitish mummy which looks like a piece of chalk, hence the name chalkbrood. If the fungus is in the sexual phase of its life cycle, the mummy is covered with dark-colored fruiting bodies.

Chalkbrood is usually more common on the edges of the broodnest where the brood is more susceptible to being chilled. Thus, it often attacks drone brood because this is located on the edge of the broodnest.

Cool, damp conditions favor the development of this disease. After such periods, chalkbrood mummies can sometimes be seen at the entrance of the colony. Locating colonies where there is good ventilation helps to prevent chalkbrood.

* * * * *

Bee diseases infecting adults show less graphic effects on the colony than brood diseases. Adult diseases are more chronic, shortening the lives of affected bees. Since the bees usually die away from the colony, the presence of the disease is not as noticeable to the beekeeper.

Nosema is an intestinal disease of adult bees which is caused by a protozoan. It disorients the bees and affects their ability to fly. In severe cases, many bees with "unhooked" wings can be seen crawling in front of the hive. This is a general symptom of most adult bee diseases.

Nosema also causes dysentery in some cases. You can see spots of feces around the entrance of the hive, and in severe cases, in the hive itself. Transmission of the disease is through this contaminated fecal material. Protection of water sources in the apiary from fecal contamination is important in the control of nosema. A roof over such water sources prevents contamination. (See Chapter 6, Getting Started - The Apiary.)

This disease is most severe in temperate regions where the bees are confined in the hive for long periods. Serious losses due to nosema are less common in the tropics. A drug (Fumidil-B) is effective for treating the disease, but it is expensive and available only from specialized bee-equipment suppliers.

Dysentery can also be caused by bees foraging on poisonous plants. When more favorable forage is not available, bees will visit plants which are poisonous to them. This occurs when nectar secretion or pollen production fails in the normal forage plants because of adverse environmental conditions.

Mites are another problem which slowly weakens the colony, making them susceptible to attack by other diseases and pests.

Acarine disease is caused by a mite that lives in the respiratory system of adult bees. The symptoms are similar to nosema except that there is no dysentery.

The Varroa mite attacks both brood and adults. It is an external parasite and feeds on the hemolymph (body fluid) of the bee. Attacked brood either dies or results in deformed adults. Infested adults are weakened and their lives shortened. This parasite is particularly destructive to bee colonies, and has caused a lot of problems recently in Europe and southern South America where it was accidentally imported with bees.

There are other mites that live on bees or in the hive which cause little or no damage to the colony.

Treatments for mites are not practical for most small-scale beekeepers. Fortunately, many areas are still free of mite problems. These areas include sub-Saharan Africa, parts of Latin America, and most of North America.

Pests are usually easier to deal with in beekeeping. They can be seen, their effect is immediate, and the solution to the problem is more obvious to the beekeeper.

The wax moth is by far the biggest pest of honey bee colonies. It is discussed as a part of hive management in Chapter Five.

Other possible pests to colonies include: hive beetles, birds, ants, small flies, lizards, toads, mice, and insect-eating mammals.

Generally, the damage done by these pests is minimal. Their greatest damage is usually to hives which the beekeeper has allowed to become weak. In instances where they become a problem, control centers on mechanical means of removing them or preventing their access to the hive.

Beetles are sometimes found in the colony in the tropics and subtropics. These hive beetles feed on the stored pollen. Generally, the only damage is in weak colonies where the beetle larvae are allowed to burrow through the comb.

Braula, a small, wingless fly which lives on bees is common in some areas. This fly only lives on the bee; it is not a parasite. It feeds on bits of pollen on the bee and on glandular secretions from the bee. Braula are especially attracted to queens. The number of individual flies is usually small and they do little damage.

(Braula are larger than mites and have three pairs of legs, whereas mites have four pairs.)

Birds and lizards sometimes cause problems in the apiary by eating large numbers of bees. The only solution for this is to kill the animals involved, though this is usually only a temporary solution -- others soon replace them. Well-cared-for colonies are affected very little by losses from birds and lizards.

Ants are a common pest of bee colonies in many parts of the tropics. They can continually attack a colony for several nights until they weaken it sufficiently to gain entrance and destroy it. Ants are usually more interested in the brood than in the honey. Colonies that are under attack by ants at night are agitated and very defensive during the day.

Toads are also a problem for colonies in areas of the tropics. They can eat large numbers of bees from the entrance of the colony at night or capture bees as they leave the hive early in the morning. If toads are eating bees from the colony, toad feces which contain bees will be seen around the front of the hive.

In areas where ants and toads are a problem, it is necessary to have the hives on hive stands to prevent losses. (See Chapter Five for details.) Hive stands make working the hives easier and can also lessen termite damage to wooden hives. Using termite-resistant posts to make the stands can prevent termites from gaining access to the hives.

Mice can be a problem in hives during dearth periods. They can destroy large areas of comb to build their nests. A strong colony which has sufficient bees to cover all of the comb in the hive will not allow mice to build nests.

Insect-eating mammals such as the honey badger of Africa and Asia can destroy hives for the brood. Where this is a problem, the animals can be killed or a fence built around the apiary.

A fence may also be helpful in preventing vandalism. Vandalism is especially prevalent in areas where bee-having or beekeeping is new.

Where bee-killing is traditional, the idea exists that bee colonies are a community resource from the bush. Thus, the idea that bees can be owned will not be readily accepted by many people in the area. From their point of view, bee hives are a legitimate resource for them to use.

Insecticides which are used to control agricultural and household pests also affect bees. The extent to which this problem affects beekeepers varies considerably.

In some regions, insecticide use is sufficiently isolated so that it has little effect on colonies. In other regions, vast areas are made unfit for beekeeping by aerial spraying of insecticides.

Insecticide poisoning mostly affects the foragers. Many are killed in the field, but some do not die until returning to the colony. Large numbers of dead bees around colonies are a reason to suspect poisoning by insecticides.

Lessening the problem of insecticide poisoning involves educating both the beekeeper and the insecticide user. Hives can be moved from an area if insecticides are going to be used, but this option is rarely realistic for the small-scale beekeeper.

Losses due to insecticides can be minimized by choosing a chemical or a formulation of the chemical less toxic to bees yet still effective on the target insect. Unfortunately, this is difficult in many regions since only a limited number of chemicals and formulations is available to farmers.

The method and timing of application are also important in preventing high bee losses due to insecticides. Proper application prevents drifting of the chemical away from the intended crop onto bee colonies or other bee forage. Applying the insecticide when bees are not active on the crop can also reduce bee losses. This can be when the crop is not in bloom or during a time of day (or night) when bee activity on the crop is low. (This is not as effective in preventing bee kill if the insecticide used has a long residual activity.)

Fungicides, herbicides, and microbial insecticides are all relatively nonhazardous to bees. These usually cause problems only when they are applied directly to foraging bees.

The following are lists of common insecticides (generic names) which are hazardous and moderately hazardous to bees. A complete list of pesticides with their relative toxicity to bees is given in some of the sources in Appendix A.

Hazardous to honey bees

Azinphosmethyl
Benzene hexachloride
Carbaryl
Carbofuran
Chlorpyrifos
Crotonamide
Diazinon
Fenthion
Heptachlor
Lindane
Malathion
Methyl parathion
Methomyl
Monocrotophos
Parathion
Propoxur

Moderately hazardous to honey bees

Chlorodane
Demeton
Disulfoton
Endosulfan
Endrin
Oxamyl
Phorate

Convincing farmers that bees can actually increase their yields of many crops is necessary to get their cooperation in alleviating insecticide problems. Because of the given socio-economic realities in many regions, the small-scale beekeeper is often in a no-win situation when it comes to solving an insecticide problem.

Another alternative to prevent pesticide loss is to confine the bees during the period when the chemicals are applied. Screens can be placed over the entrance at night when all the bees are inside.

Make sure confined colonies are kept cool by being in the shade or covered with wet burlap or thatch. Such colonies should also be given water by squirting it into the entrance or putting it in a feeder bottle. Do not confine colonies for more than two days.

* * * * *

In recent years there has been a growing awareness of the potential of beekeeping as a development tool. This has grown out of the interest in directing development efforts to small-scale projects.

Beekeeping fits well with this approach to local development. Its potential is great. The idea needs to be disseminated. This manual will help you get started.

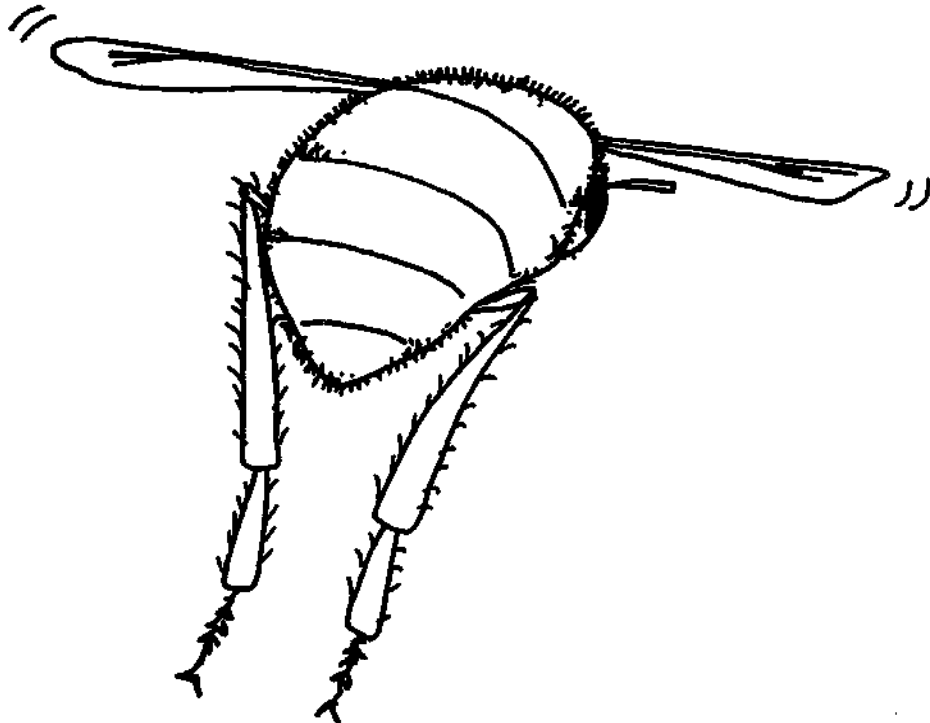

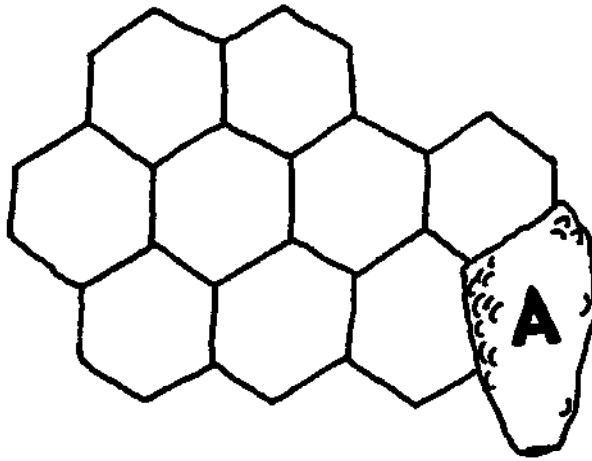

Resources and Bibliography

The International Bee Research Association (IBRA) is an international clearing house for bee research and beekeeping information. IBRA publishes Bee World, a quarterly journal of a general nature, and Journal of Apicultural Research, a quarterly technical publication.

Recently, IBRA published with financial support from the Canadian International Development Research Center a series of ten leaflets, Source Materials for Apiculture, providing information often needed and sought by beekeepers in developing countries. Individual leaflets are free to addresses in developing countries. The titles of the leaflets are:

- No. 1 Suppliers of equipment for tropical and subtropical beekeeping
- No. 2 Marketing bee products: addresses of importers and agents
- *No. 3 Planting for bees in developing countries
- No. 4 Opportunities for training in apiculture world-wide
- No. 5 Sources of voluntary workers for apicultural development
- *No. 6 Sources of grant-aid for apicultural development
- *No. 7 Obtaining apicultural information for use in developing countries
- *No. 8 Apicultural reference books for developing countries
- No. 9 Educational aids on apiculture
- No. 10 Writing about apiculture: guidelines for authors

* These are especially useful for small-scale projects.

The Bibliography of Tropical Apiculture is another publication of IBRA. This is a series of detailed bibliographies on bees, beekeeping, and beekeeping development in the tropical and subtropical regions of the world. Pertinent sections of the bibliography are available free to certain libraries and resource centers in developing countries.

Peace Corps Information Collection and Exchange has worked out an arrangement with IBRA to provide technical assistance on beekeeping for Volunteers. Specific requests for information should be sent to Peace Corps, Information Collection and Exchange, Room M-701, 806 Connecticut Avenue, N.W., Washington D.C. 20526. ICE will refer the questions to IBRA if necessary.

For more information on IBRA or to request publications write:

IBRA
Hill House
Gerrards Cross
Bucks. SL9 0NR
England

The International Agency for Apicultural Development (IAAD) is an organization of scientists, technicians, and beekeepers who are working to promote beekeeping development. The agency provides a link between its members and development funding agencies. IAAD also co-sponsors a yearly seminar each summer on development apiculture. Members of IAAD have beekeeping experience in most regions of the world and may be able to provide you with contacts in your area.

For more information on IAAD, write:

IAAD
3201 Huffman Blvd.
Rockford, Illinois 61103
U.S.A.

* * * * *

The U.S. Department of Agriculture (USDA) has a number of publications dealing with bees and beekeeping. These are for sale from the Superintendent of Documents, U.S. Government Printing Office, Washington, D.C. 20401, U.S.A. (Minimum order of \$1.00.)

The following USDA publications may be useful for small-scale projects:

**Beekeeping for Beginners, Home and Garden
Bulletin 158 (\$0.30)**

**Beekeeping in the United States, Agriculture
Handbook 335 (\$6.00)**

A good overview of "high-tech" beekeeping; thus, it is useful to gain a perspective on the possibilities of beekeeping.

**Insect Pollination of Cultivated Crop Plants,
Agriculture Handbook 496 (\$5.90)**

A comprehensive treatment of the pollination requirements and recommendations for both temperate and tropical crop plants.

Pesticides and Honey Bees, Leaflet 563 (\$0.70)

**Selecting and Operating Beekeeping Equipment,
Farmers' Bulletin 2204 (\$0.40)**

**Identification and Control of Honey Bee Diseases,
Farmers' Bulletin 2255 (\$1.00)**

Nosema Disease, Technical Bulletin 1569 (\$0.90)

**Shade and Water for the Honey Bee Colony, Leaflet
530 (\$0.35)**

Other USDA publications of a more "high-tech" nature are:

Development of Hybrid Honey Bees, Production
Research Report 168 (\$0.35)

Instrumental Insemination of Queen Bees,
Agriculture Handbook 390 (\$0.25)

Overwintering of Honey Bee Colonies, Production
Research Report 169 (\$0.35)

Trapping Pollen from Honey Bee Colonies,
Production Research Report 163 (\$0.35)

Two-Queen System of Honey Bee Colony Management,
Production Research Report 161 (\$0.35)

Using Honey Bees to Pollinate Crops, Leaflet 549
(\$0.60)

Supplemental Feeding of Honey Bee Colonies, AIB
413 (\$0.70)

Note: Single copies of USDA publications can be received free, if available, from: USDA, SEA, Information Staff, 6009 South Bldg., Washington, D.C. 20250, U.S.A. Include a brief statement on your interests and project in your request.

* * * * *

There are many books on bees and beekeeping. The following were selected for their comprehensiveness and for their usefulness to beekeepers working in small-scale development projects. The prices quoted are in U.S. dollars and are for 1982. They do not include postage; thus, include sufficient money for air mail postage when ordering these books from outside of their country of origin.

Complete ordering information is provided for all titles, including those available from ICE. However, note that titles which are available from ICE are free of charge to PCVs and staff and can be ordered by writing Peace Corps, Information Collection and Exchange, Room M-701, 806 Connecticut Avenue, N.W., Washington D.C. 20526.

ABC and XYZ of Bee Culture, The A.I. Root Company, P.O. Box 706, Medina, Ohio 44256, U.S.A., 1974, 726 pp.

A popular-oriented encyclopedia on bees and beekeeping. \$13.80.

A.I. Root also publishes Gleanings in Bee Culture, a monthly, popular-oriented journal. They also have a catalog of beekeeping supplies and equipment. (Don't overlook the educational value of a catalog.)

La Apicultura: Guia Practica, Como Trabajar con las Abejas, (In Spanish), J.D. Spence. Proyecto Desarrollo Apicola, Nebaj, Guatemala, 1980, 222 pp. Order from: Centro de Recursos para el Desarrollo, Apartado Postal 52, Chimaltenango, Guatemala.

A simple, how-to guide to the methods of "high-tech" beekeeping. Well illustrated. Recommended for those working in Spanish-speaking America. \$5.50.

Apicultura Tropical, (In Spanish), Dario Espina P. and Gonzalo S. Ordetx. Editorial Tecnologica de Costa Rica, Cartago, Costa Rica, 1981, 420 pp.

A good book dealing with "high-tech" beekeeping for those working in tropical America. \$12.50.

A Beekeeping Handbook, Bernhard Clauss. Ministry of Agriculture, Beekeeping Officer, Private Bag 003, Gaborone, Botswana, 1980, 65 pp.

Includes methods and photos of beekeeping with top-bar hives. Also includes photos of the construction of mud hives. Especially recommended for those working in Africa. About \$7.00.

The Beekeeper's Handbook, Diana Sammataro and Alphonse Avitable. Peach Mountain Press, Ltd., Box 126, Dexter, Michigan 48130, U.S.A., 1978, 131 pp.

A practical guide to bees and to beekeeping as carried on in the U.S. Recommended as an orientation to "high-tech" beekeeping. \$7.95.

Beekeeping in Rural Development: Unexploited beekeeping potential in the tropics with particular reference to the commonwealth, Commonwealth Secretariat and IBRA, 1979, 196 pp.

Case studies of the beekeeping situation in various regions and countries. Available free to addresses in developing countries from:

Commonwealth Secretariat
Food Production and Rural Development Division
Marlborough House
Pall Mall
London SW1Y 5HX
UK

Beekeeping in Zambia, R.E.M. Silberrad. Apimondia, Bucharest 1, Romania, 1976, 76 pp. (Available from IBRA.)

Provides an excellent orientation to the nature of beekeeping with African bees. \$6.60.

Beekeeping Technical Cooperation: Directory and Guidelines, W. Drescher and Eva Crane. 1982.

A guide to starting and funding large-scale development programs. Available free to addresses in developing countries from:

German Agency for Technical Cooperation (GTZ)
Postfach 5180
6236 Eschborn 1
German Federal Republic

A Book of Honey, Eva Crane. Oxford University Press, Oxford, England, 1980, 194 pp.

Discusses the composition and properties of honey, the uses of honey, and the role of honey in folklore and literature. \$7.70.

Contemporary Queen Rearing, Harry H. Laidlaw, Jr. Dadant and Sons, Hamilton, Illinois 62341, U.S.A., 1979, 199 pp.

A complete guide to the methods of large-scale queen production. Includes sections on the history of the techniques, package bee production, and bee stock maintenance and improvement. (Royal jelly is produced using the basic techniques covered in this book.) \$10.95.

The Dancing Bees, Karl von Frisch. Harcourt, Brace and World, New York, 1953, 182 pp.

A highly readable account of the life history and the senses of the honey bee. Includes a discussion of the author's work on the communication system of bees. \$3.50.

The Hive and the Honey Bee, Dadant and Sons, Hamilton, Illinois, U.S.A., 1975, 740 pp.

The most comprehensive book available on all aspects of bees and beekeeping. \$12.95.

Dadant and Sons also publishes the monthly American Bee Journal, the widest-interest journal in the U.S. dealing with bees and beekeeping. You can also request a catalog of beekeeping supplies and equipment from this company.

Let's Build a Bee Hive, Wilbert R. Miller, 2028 W. Sherman Street, Phoenix, Arizona 85009, U.S.A., 1976, 92 pp.

A carpentry book which contains plans and tips on building a wide range of "high-tech" beekeeping equipment. \$8.50.

Make Your Own Bee Hives and Make Your Own Honey
Extractor, Garden Way Publishing, Charlotte,
Vermont 05445, 1977, 8 pp. each.

Well-drawn and explained plans for building this
equipment. \$5.50 for both.

Preparation of Honey for Market, G.F. Townsend.
Ministry of Agriculture and Food, Ontario, Canada,
1976, 38 pp.

Describes commercial-scale extraction and
processing of honey using high-technology food
processing equipment. Contains a brief section on
small-scale honey extraction. The booklet also
covers the principles of maintaining high quality in
honey. About \$2.00. (You may be able to obtain
this for free if you request it on an official
letterhead.)

The following titles are available to PCVs and
staff through ICE:

Apicultura Lucrativa by Walter T. Kelley, The
Walter T. Kelley Co., Clarkson, Kentucky
42726, U.S.A., 1977, 104 pp. (Spanish only.)

This guide, written in Spanish, outlines the
procedures involved in beekeeping. Chapters
include information on beekeeping equipment,
placement and construction of the apiary, des-
cription of bee activity, treatment of diseases
and pests and collection and uses of honey,
complete with illustrative photographs. A
serviceable guide for the apiculturist working
in small-scale beekeeping projects. \$10.00.
Available to PC offices/resource centers only;
two copies per country.

Firewood Crops: Shrub and Tree Species for Energy Production, National Academy of Sciences, Washington, D.C., 1980, 237 pp.

Discusses other uses of these plants. Some are important bee forage in certain areas. One copy is free if requested on you organization's letterhead.
Order from:

Commission on International Relations
National Academy of Sciences -
National Research Council
2101 Constitutional Avenue
Washington, D.C. 20418
U.S.A.

Lesson Plans for Beekeeping by PC/Philippines, ICE Reprint R-32, 1978, 62 pp.

Step-by-step procedures and basic technical information for starting small-scale beekeeping projects, presented as a series of lessons.

Available to all PCVs and staff through ICE.

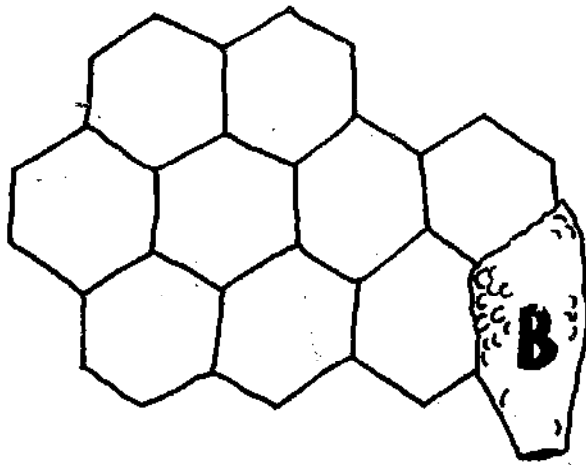

Hive Plans *

KTBH

Length of hive body is 97 cm to accommodate 30 top bars spaced 32 mm

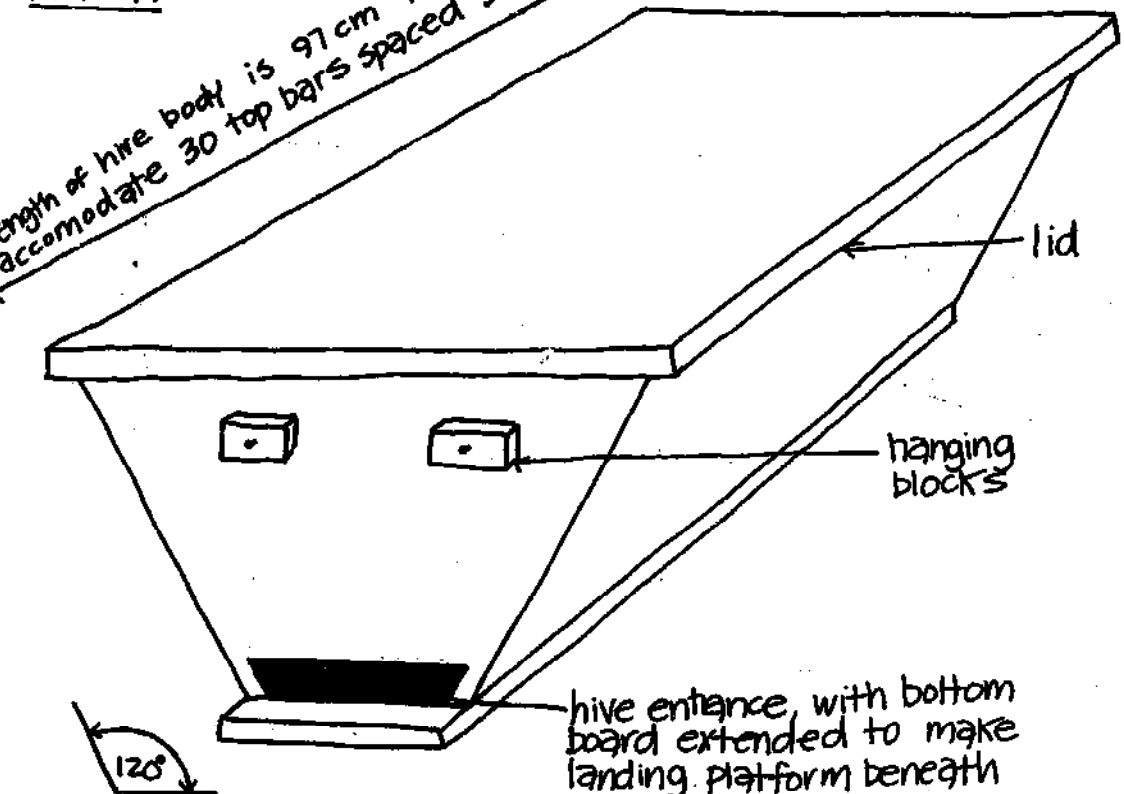

interior angle of bottom and side is about 120°

*Prepared by Rob Kingsolver.

KENYA TOP BAR HIVE (KTBH)
dimensions in cm, based on 1.9 cm lumber

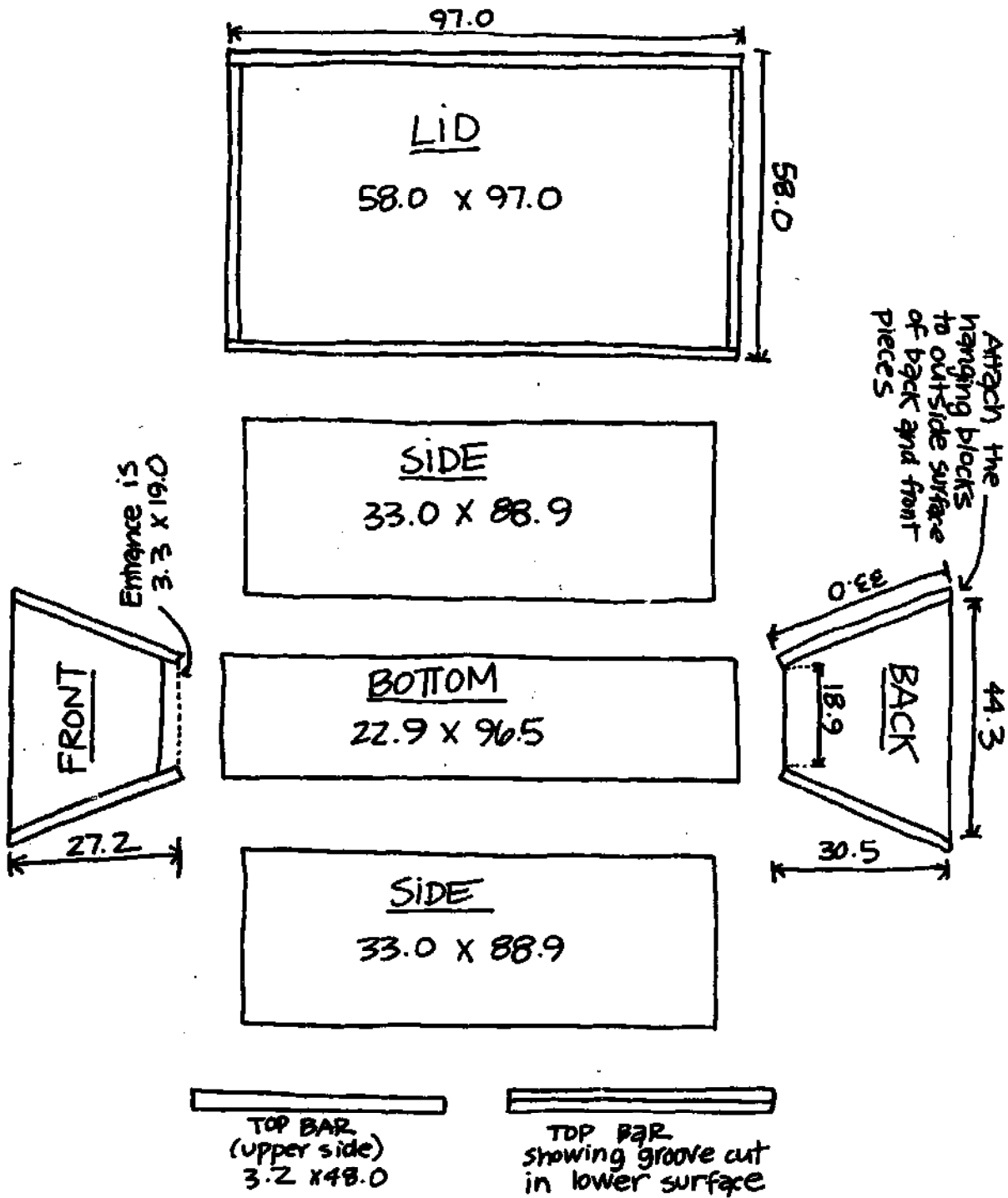

Starter Guide for Top Bars

A wax starter guide on top bars is important so that the bees construct the comb centered on the bar. There are two ways to make a starter guide:



1.) Pour a line of melted beeswax along the center of the top bar. You can also stick softened wax on to the bar.



top bar with
groove
(side view)



top bar with starter
strip
(long view)

2.) Cut a groove in the center of the top bar and insert a starter strip. Attach the strip with softened or melted wax.

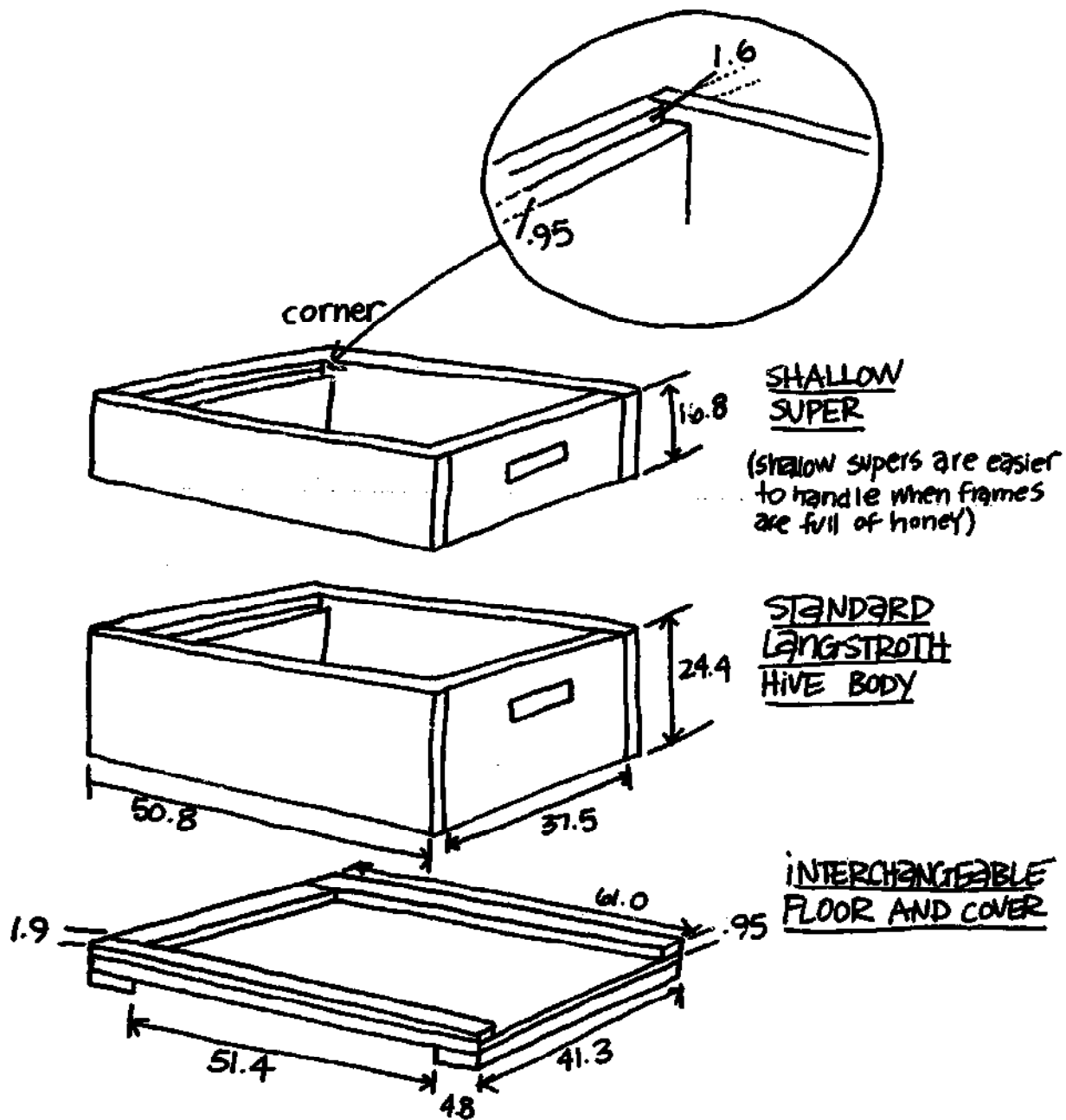

Ten-frame Langstroth Hive

(all measurements in cm, using 1.9 cm lumber)

NOTE: Do not paint inside of hive.

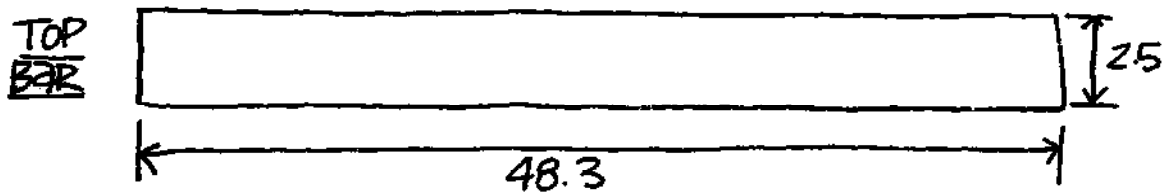
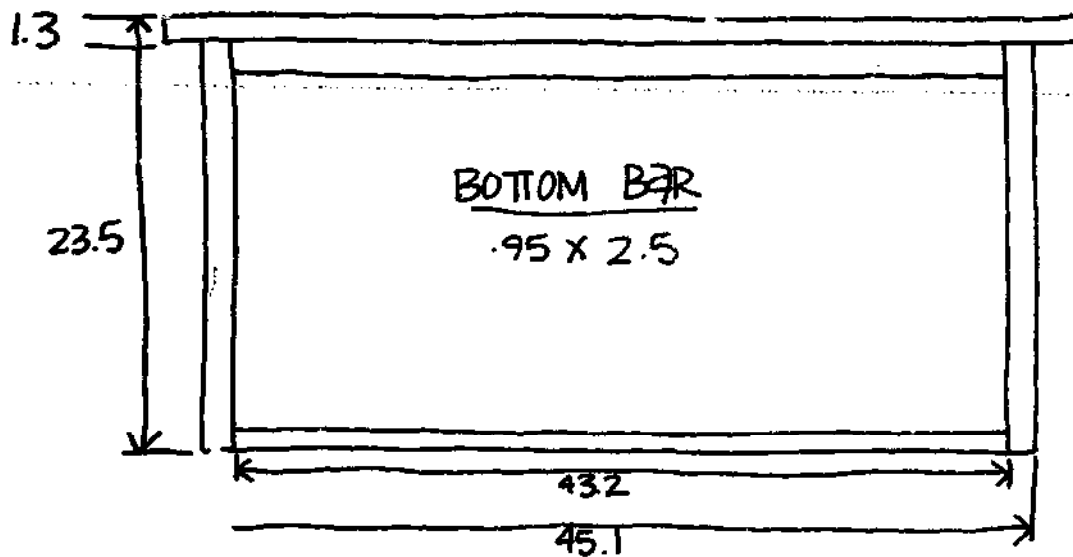
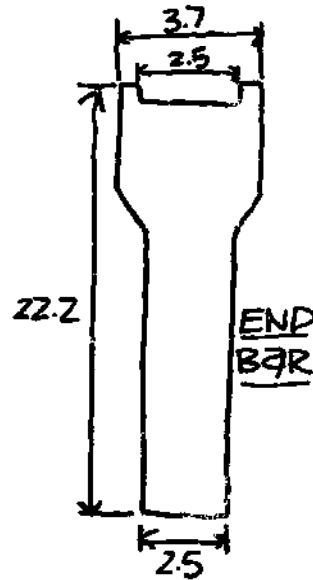

FRAME FOR LANGSTROTH HIVE BODY
(all measurements in cm)

NOTE: The overall depth for the Langstroth frame is 23.5 cm. The overall depth for a shallow frame is 15.9 cm.

OBSERVATION HIVE

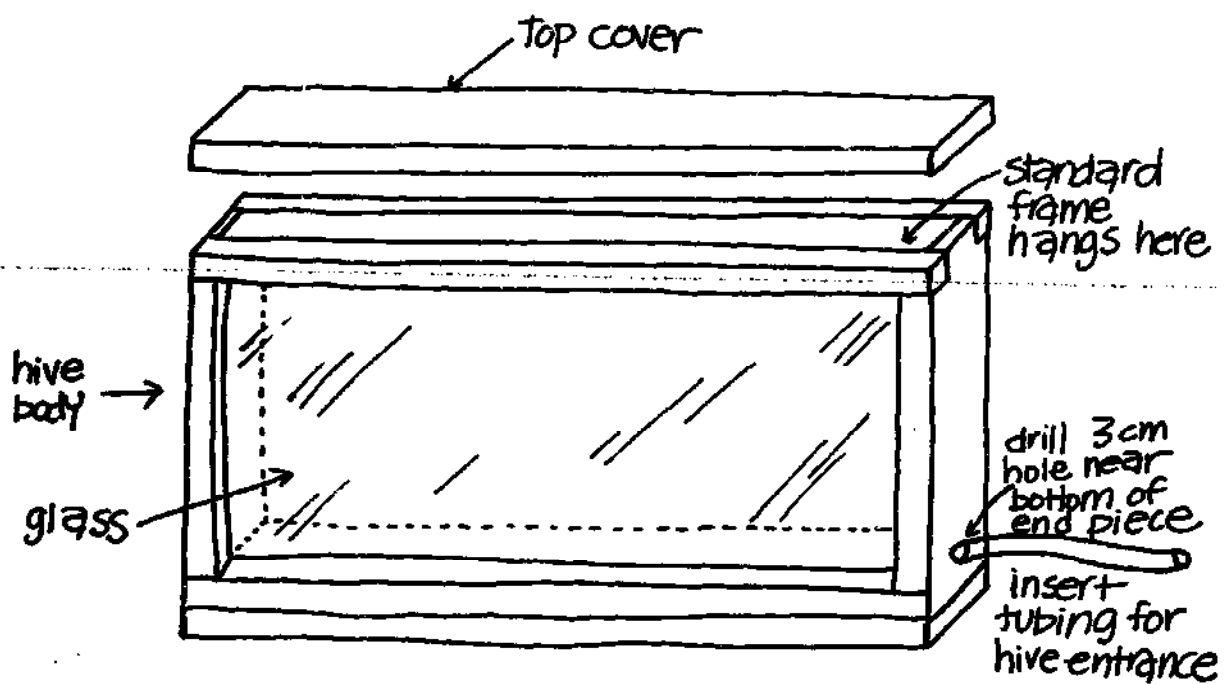

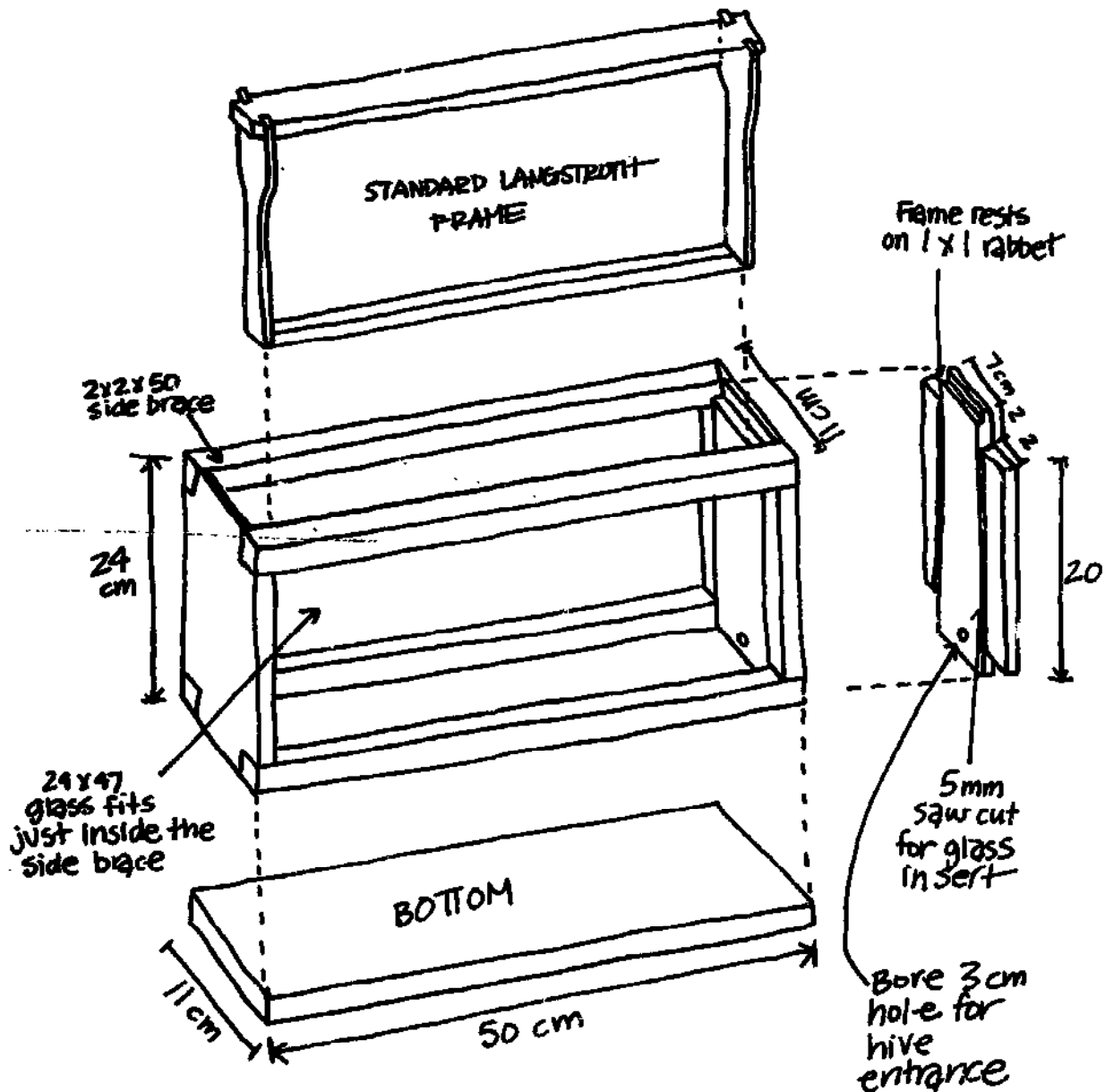

OBSERVATION HIVE

(based on 1.9 cm lumber, all measurements in cm)
 Hive body can be covered with cap of same dimensions as bottom, or several hive bodies can be stacked. Remember to leave a bee space around frame.

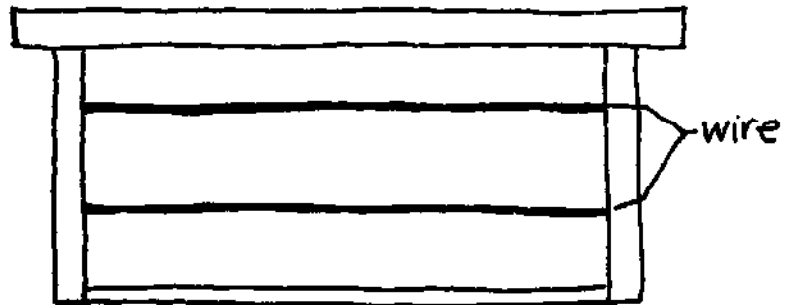

Wire is used in frames to
reinforce them.

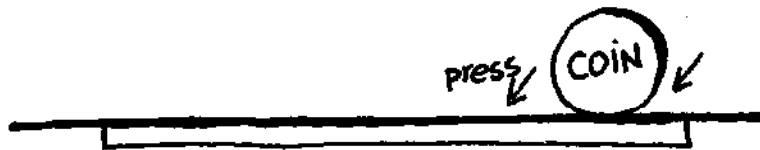

Embed the wire in the comb
foundation with the edge
of a coin.

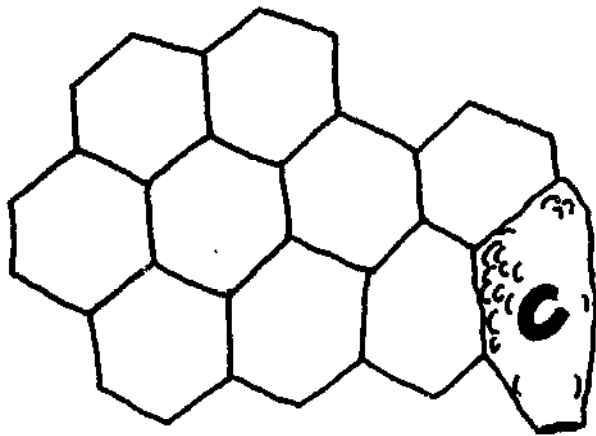

Equipment Plans *

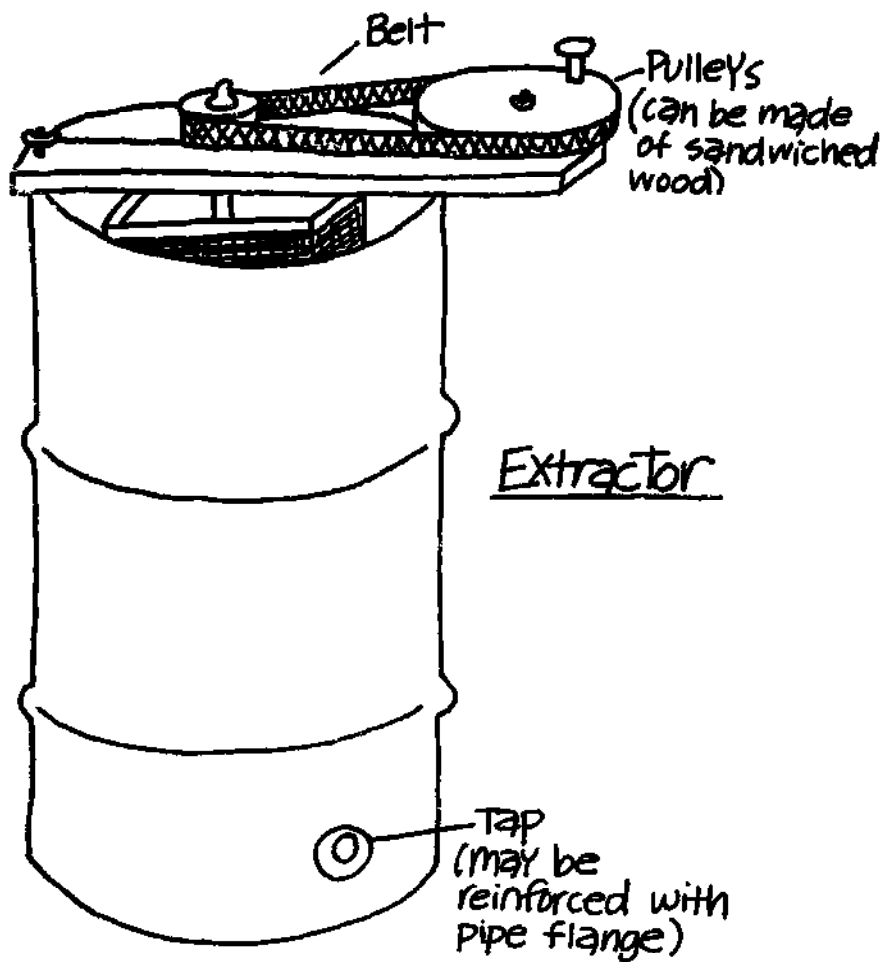

*Prepared by Rob Kingsolver.

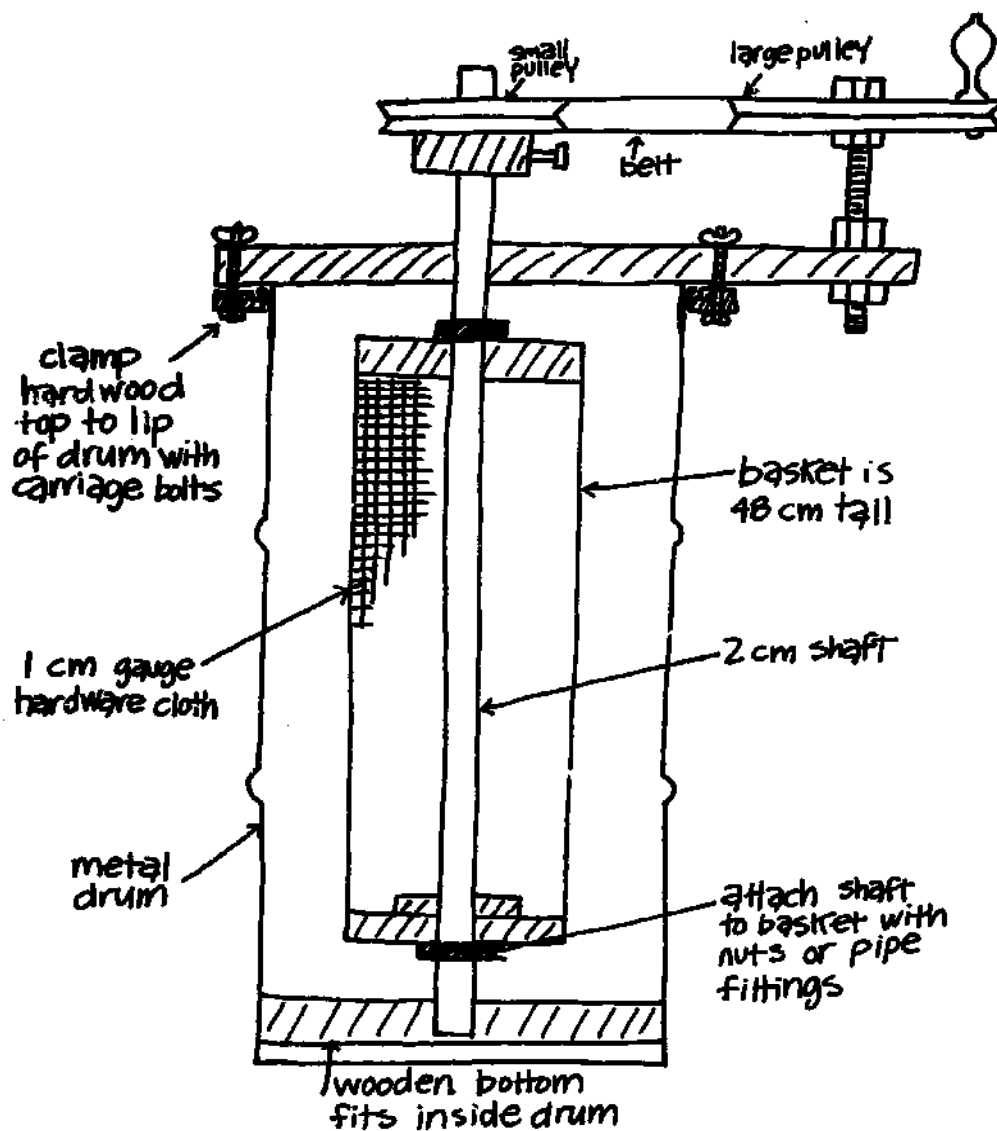

Cut off the cell cappings before extracting the frame of honey.

Partially extract the honey from one side of the comb; then turn the frame around and completely extract the other side. Turn the frame around again and finish extracting the comb. This minimizes comb breakage since it prevents the weight of the full side of the frame of honey from pressing against the empty side.

BASKET DETAILS

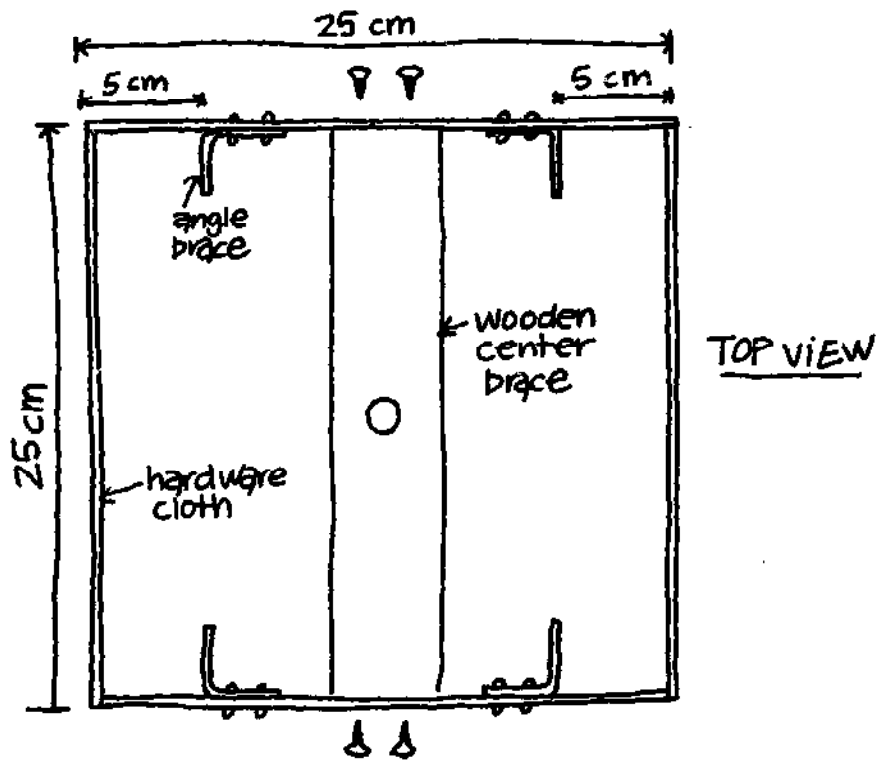
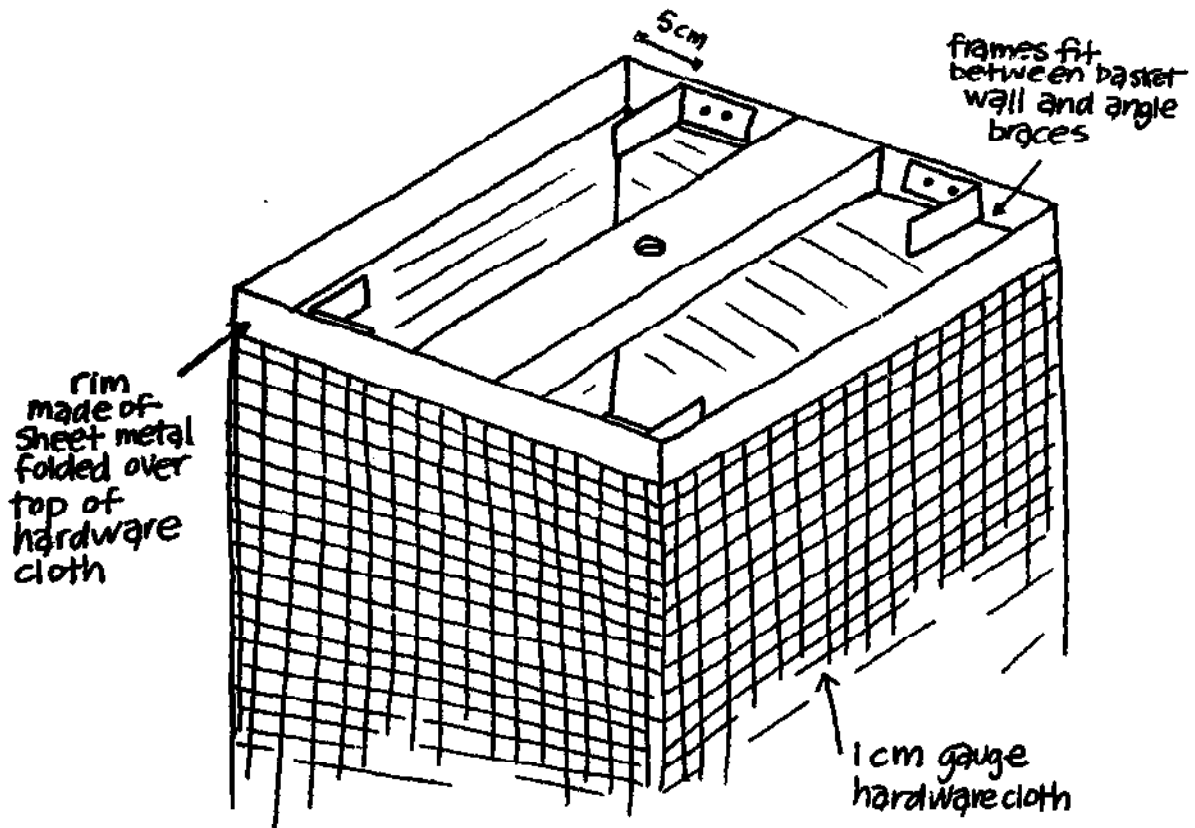



Hand-held Honey Extractor

SIMPLE SMOKER

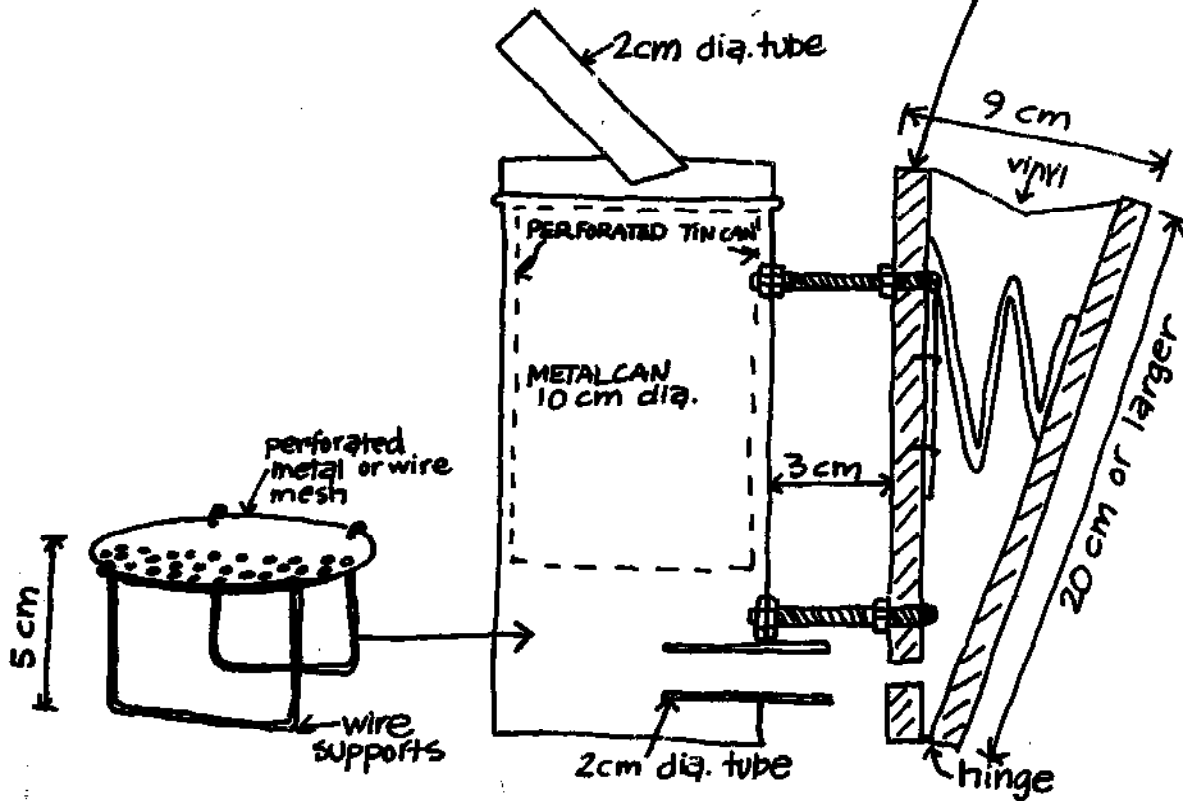
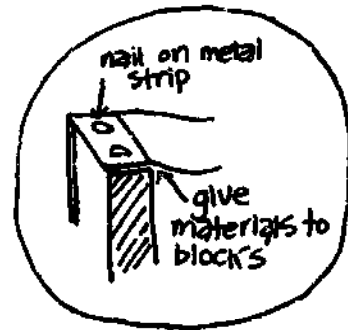
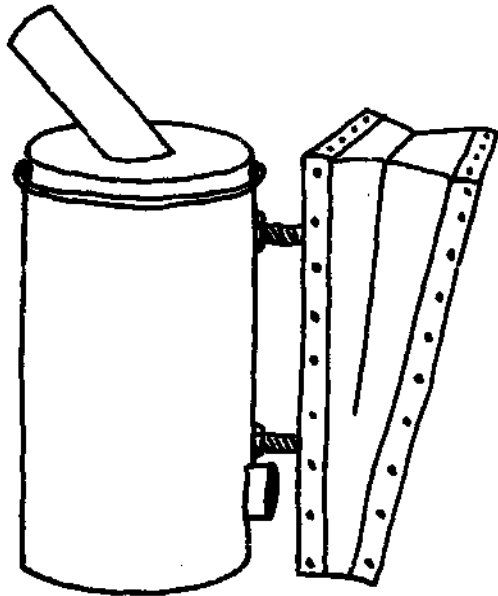

NOTE: solder tubes in place.

VEIL DIMENSIONS

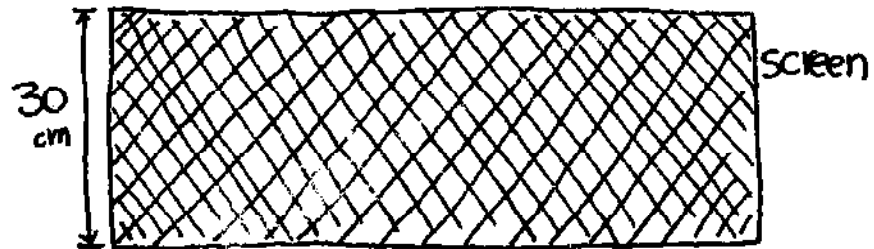
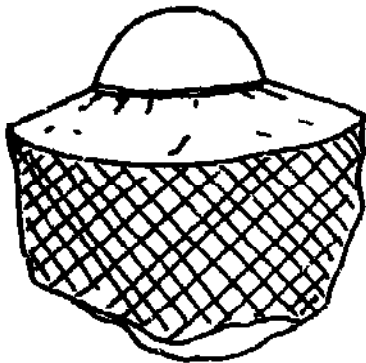

Lengths variable depending on the size of your hat

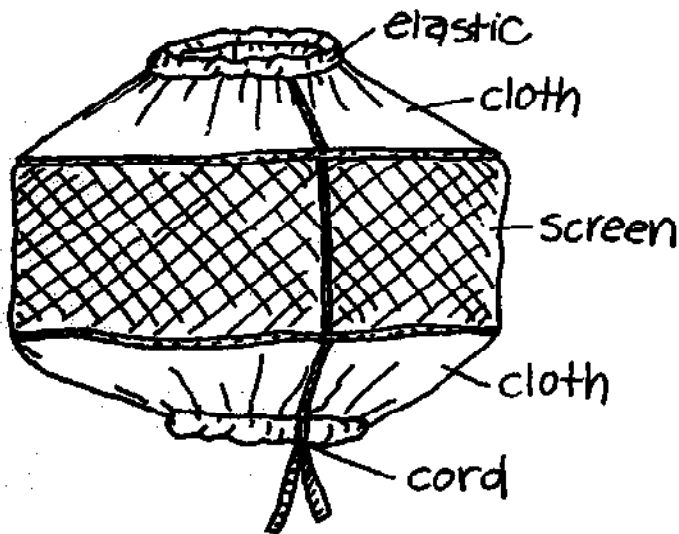

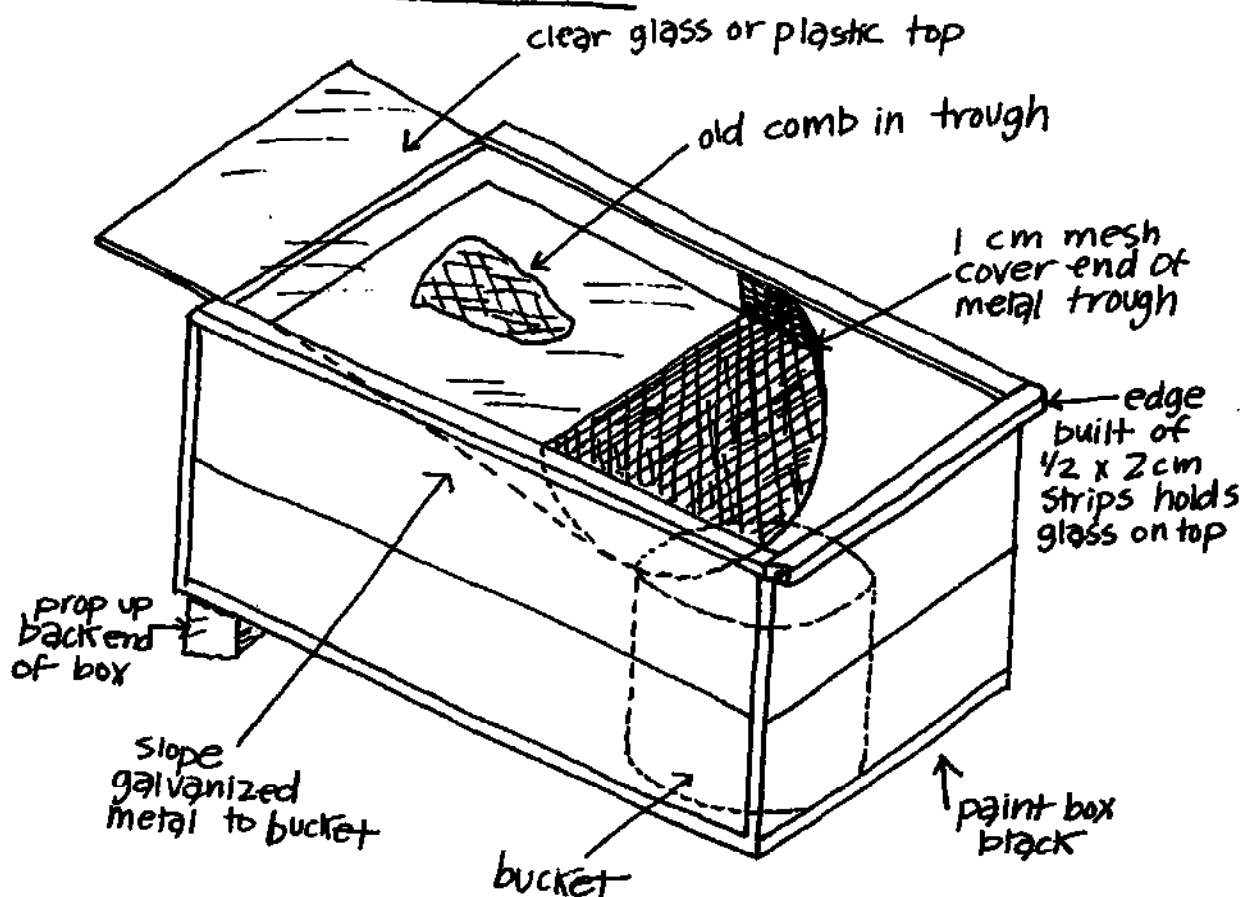
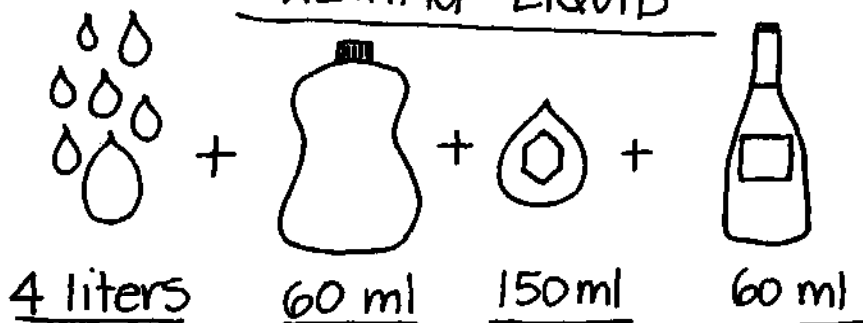
SOLAR WAX MELTERWETTING LIQUID

A mixture of rain water or distilled water, detergent, honey, and alcohol — the mixture should not be bubbly.

NOTE: Minerals in the water will cause the wax to stick.

MAKING STARTER STRIPS WITH A DIP BOARD

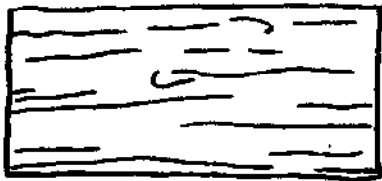

1) Use a smooth, hardwood board.

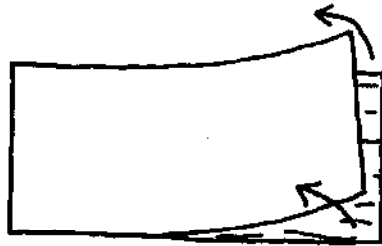

4) When the wax hardens, peel it from the board, trim it, and cut it into 2 cm strips.

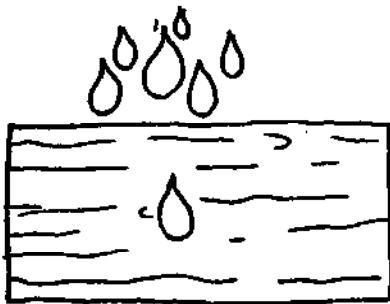

2) Wet the board with the wetting liquid.

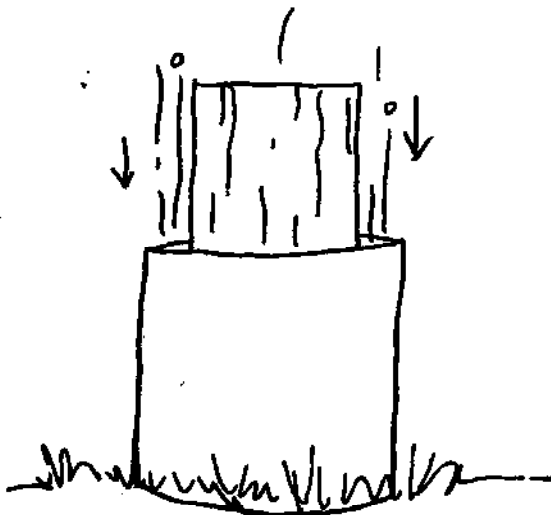

3) Dip the board into hot wax. For thicker strips, dip the board several times.

A MOLD FOR MAKING WAX FOUNDATION



1) Put frame containing a sheet of foundation on board.



2) Coat foundation with vegetable oil.

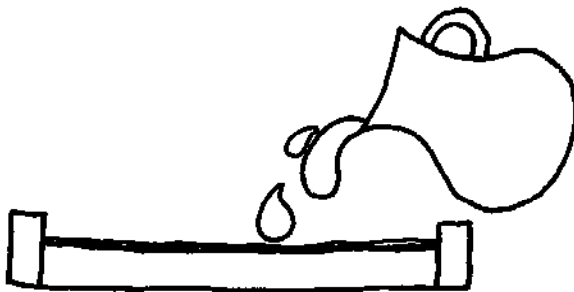

3) Pour in plaster of Paris, and allow to harden.



4) Turn over and do the other side.

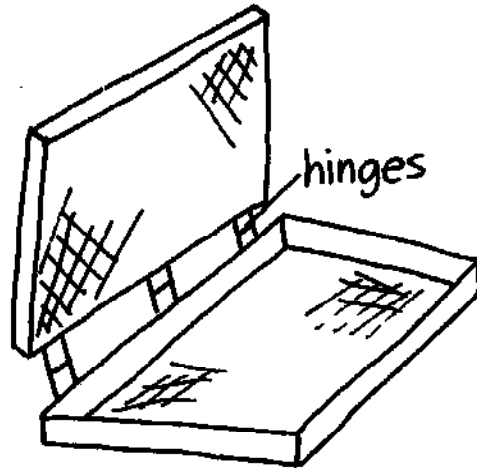

5) When the molds are hard, carefully separate them. Build a hinged frame (box) to hold the molds.

MAKING FOUNDATION

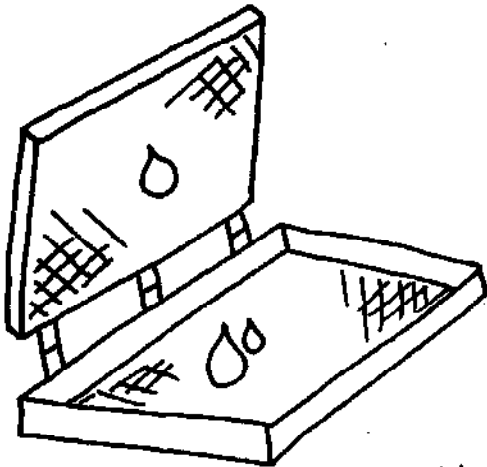

1.) Brush the mold with the wetting liquid.

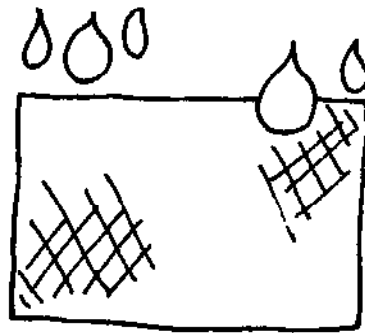

3.) Remove the wax sheet, rinse it off with cool water, and trim it.

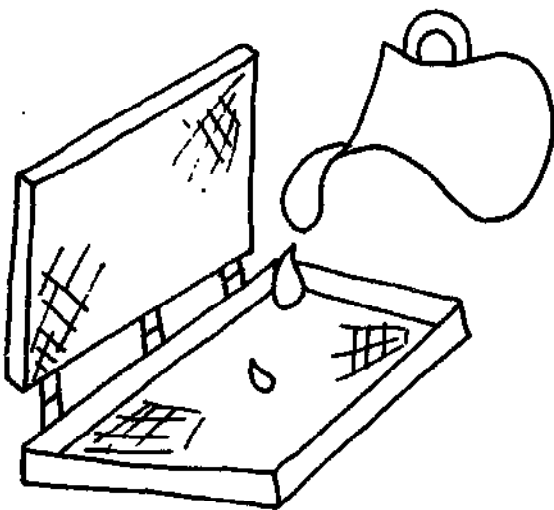

2.) Pour melted wax in the center of the mold.

NOTE: Melt the wax in a double boiler. Wax is flammable. Do not allow wax to boil - this will make it brittle.

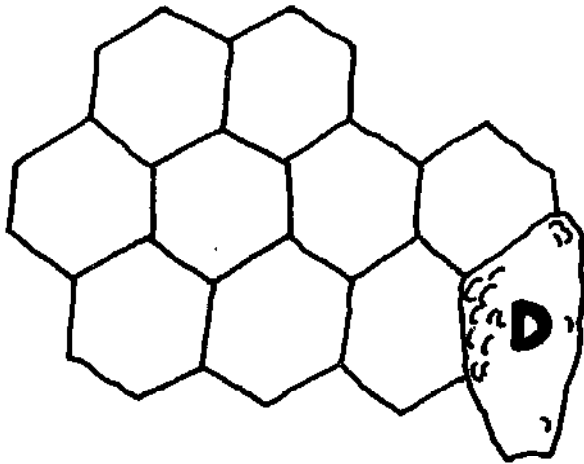

Uses for Beeswax *

Grafting Wax for Horticultural Purposes

Melt equal portions of resin and beeswax in a double boiler. Allow the mixture to cool and roll it out into sticks. Wrap in wax paper and store in a cool, dry place.

Sewing

Pull the thread through small blocks of beeswax. The wax stiffens and smooths the thread. This is especially useful when sewing hides and thick material.

Treatment for Cracked Hooves

Mix together equal parts of melted beeswax and honey for a good home remedy for cracked hooves of animals. Clean and dry the crack before applying the mixture.

*Adapted from: Practical Beekeeping for the Developing World by Henry Mulzac. 1978. Unpublished manuscript prepared for the Peace Corps.

Beeswax Furniture/Wood Polish

200 gms beeswax
 100 gms turpentine
 50 gms orange, lemon, or coconut oil

Grate the beeswax into flakes. Gradually add the turpentine to soften the wax. Add oil and mix. Store in a tin with a tight-fitting top or in a jar.

Beeswax Floor Polish

60 gms potash
 60 gms water
 120 gms beeswax
 270 gms water

Heat 270 gms of water to the boiling point and gradually add the beeswax. Mix the potash with 60 gms of water and pour this mixture into the beeswax and water. Heat until a milky fluid results.

Leather Waterproofer

750 gms beeswax
 45 gms pitch
 60 gms ground nut oil
 40 gms iron sulfate
 15 gms essence of thyme

Grate and melt the beeswax. Allow the wax to cool until it is "semi-soft". Add the remaining ingredients and mix. Store in a tight container.

Topical Ointment for Burns

18 gms beeswax
 40 gms paraffin
 10 gms pulverized aloe
 30 gms water
 1 gm borax (available in pharmacies)

Grate and melt together the beeswax and paraffin. Remove from heat and add the remaining ingredients. Store in a jar.

Beeswax Cold Cream

100 gms beeswax
200 gms water
300 gms colorless mineral oil
6 gms borax
aromatic essence (if desired)

Heavy, colorless mineral oil, which is sold in pharmacies as medicinal oil, is satisfactory. The borax, or sodium borate, neutralizes the acids in the beeswax and acts as an emulsifier.

Heat the beeswax and mineral oil to 70 degrees C. Stir until the wax is completely dissolved. Add the borax to the water and heat to the same temperature as above. Add the borax-water solution to the oil and wax while stirring briskly. Stir until a smooth emulsion is formed.

When the mixture has cooled to 60 degrees C, add the aromatic essence and stir thoroughly. When cooled to 48 degrees C, pour into jars and allow to set with the lids off.

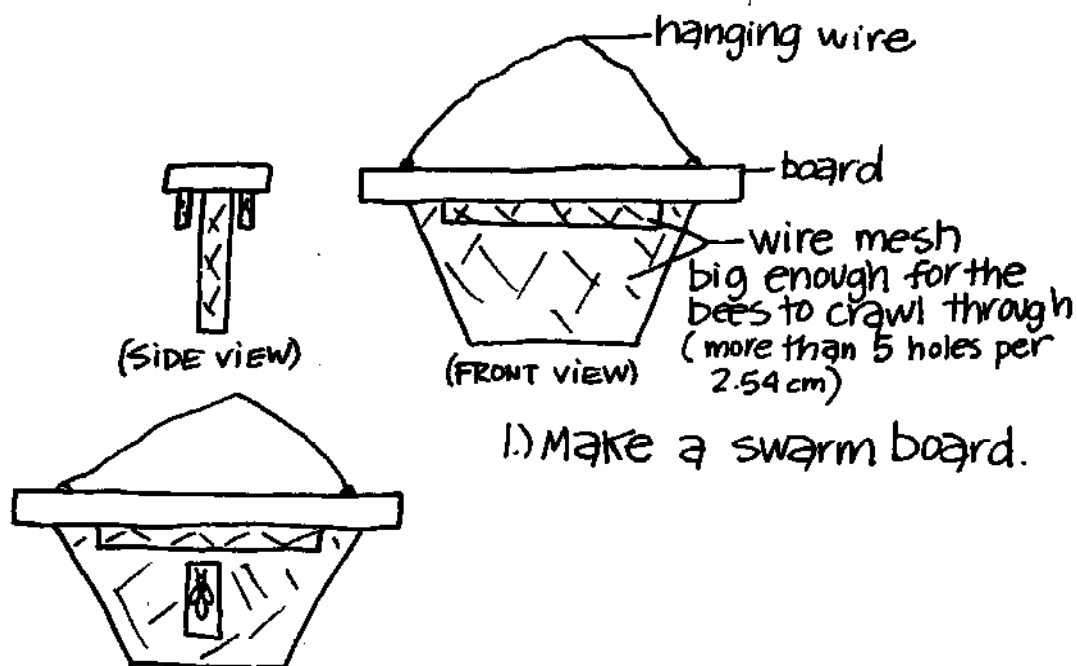

1.) Make a swarm board.

2.) Find the queen in a colony and cage her. Attach the caged queen to the mesh on the swarm board.

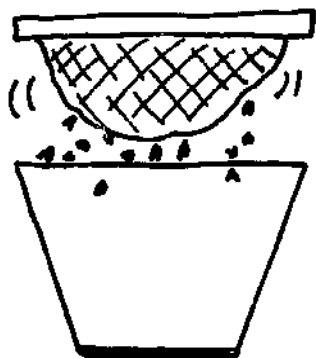

3.) Remove the combs (either on top bars or in frames) from the hive, and shake or brush all of the bees from the combs back into the hive. Set the combs aside in a closed empty box.

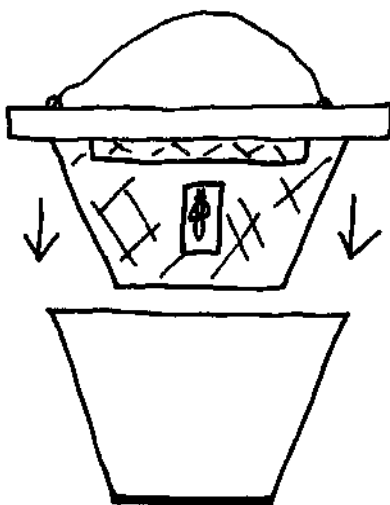

4.) Place the swarm board with the queen over the loose bees. In a few minutes, they will cluster around the queen.

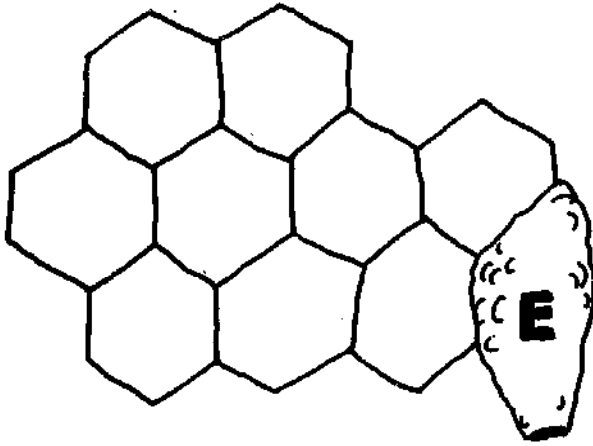

Making an Artificial Swarm



5) You can then hang the swarm up to observe it.

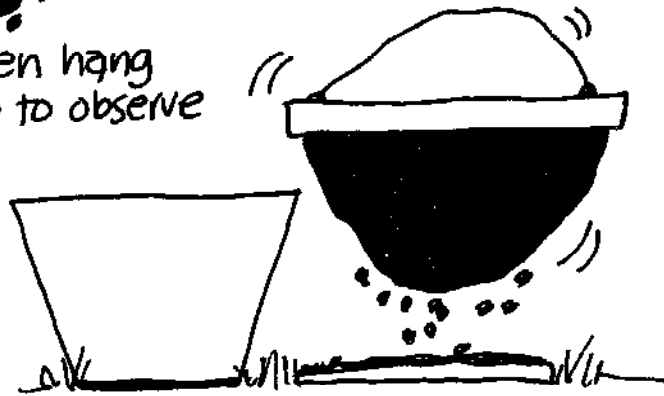

6.) To rehive the swarm, shake it on to a cloth or a newspaper in front of a hive in which you have put the comb. Release the queen into the hive.

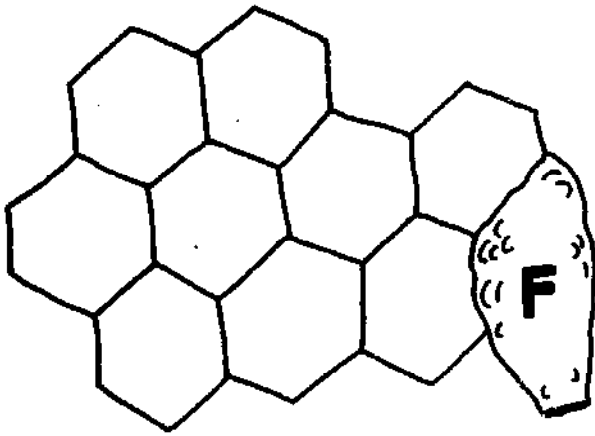

Honey Bee Anatomy

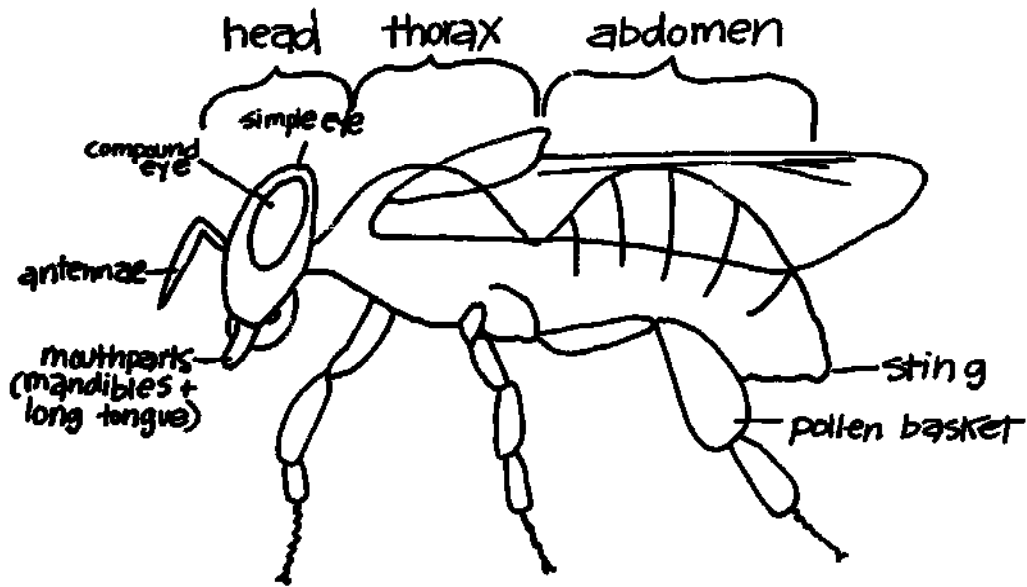

3

Since 1961 when the Peace Corps was created, more than 80,000 U.S. citizens have served as Volunteers in developing countries, living and working among the people of the Third World as colleagues and co-workers. Today 6000 PCVs are involved in programs designed to help strengthen local capacity to address such fundamental concerns as food production, water supply, energy development, nutrition and health education and reforestation.

Loret Miller Kuppe, Director
 Edward Curran, Deputy Director
 Richard B. Abell, Director, Office of Program Development

Peace Corps overseas offices:

<u>BELIZE</u> P.O. Box 487 Belize City	<u>FIJI</u> P.O. Box 1094 Suva	<u>MAURITANIA</u> BP 222 Nouakchott	<u>SIERRA LEONE</u> Private Mail Bag Freetown
<u>BENIN</u> BP 971 Cotonou	<u>GABON</u> BP 2098 Libreville	<u>MICRONESIA</u> P.O. Box 336 Saipan, Mariana Islands	<u>SOLOMON ISLANDS</u> P.O. Box 547 Honiara
<u>BOTSWANA</u> P.O. Box 93 Gaborone	<u>GAMBIA, The</u> P.O. Box 582 Banjul	<u>MOROCCO</u> I, Zanquat Benzerte Rabat	<u>SWAZILAND</u> P.O. Box 362 Mbabane
<u>CAMEROON</u> BP 817 Yaounde	<u>GHANA</u> P.O. Box 5796 Accra (North)	<u>NEPAL</u> P.O. Box 613 Kathmandu	<u>TANZANIA</u> Box 9123 Dar es Salaam
<u>CENTRAL AFRICAN REPUBLIC</u> BP 1080 Bangui	<u>GUATEMALA</u> 6a Avenida 1-46 Zona 2 Guatemala	<u>NIGER</u> BP 10537 Niamey	<u>THAILAND</u> 42 Soi Sorprasong 2 Petchhuri Road Bangkok 4
<u>COSTA RICA</u> Apartado Postal 1266 San Jose	<u>HONDURAS</u> Apartado Postal C-51 Tegucigalpa	<u>OMAN</u> P.O. Box 966 Muscat	<u>TOGO</u> BP 3194 Lome
<u>DOMINICAN REPUBLIC</u> Apartado Postal 1414 Santo Domingo	<u>JAMAICA</u> 9 Musgrove Avenue Kingston 10	<u>PAPUA NEW GUINEA</u> P.O. Box 1790 Boroko	<u>TONGA</u> BP 147 Nuku'alofa
<u>EASTERN CARRIBBEAN</u> Including: Antigua Barbados, Grenada, Montserrat, St. Kitts-Nevis, St. Lucia, St. Vincent, Dominica "Erin Court" Bishops Court Hill P.O. Box 696-C Bridgetown, Barbados	<u>KENYA</u> P.O. Box 30518 Nairobi	<u>PARAGUAY</u> c/o American Embassy Asuncion	<u>TUNISIA</u> B.P. 96 1002 Tunis-Belvedere Tunis
	<u>LESOTHO</u> P.O. Box 554 Maseru	<u>PHILIPPINES</u> P.O. Box 7013 Manila	<u>UPPER VOLTA</u> BP 537-Sarandin Ouagadougou
	<u>LIBERIA</u> Box 707 Monrovia	<u>RWANDA</u> c/o American Embassy Kigali	<u>WESTERN SAMOA</u> P.O. Box RR0 Apia
	<u>MALAWI</u> Box 208 Lilongwe	<u>SENEGAL</u> BP 2534 Dakar	<u>YEMEN</u> P.O. Box 1151 Sana'a
	<u>MALAYSIA</u> 177 Jalan Raja Muda Kuala Lumpur	<u>SEYCHELLES</u> Box 564 Victoria	<u>ZAIRE</u> BP 697 Kinshasa
<u>EQUADOR</u> Casilla 635-A Quito	<u>MALI</u> BP 85 Bamako		