

# **AT** MICROFICHE REFERENCE LIBRARY

A project of Volunteers in Asia

## The Bicycle Builder's Bible

by: Jack Wiley

Published by

TAB Books

Monterey Avenue

Blue Ridge Summit, PA 17214 USA

Paper copies are \$ 8.95

Available from:

TAB Books

Monterey Avenue

Blue Ridge Summit, PA 17214 USA

Reproduced by permission of TAB Books.

Reproduction of this microfiche document in any form is subject to the same restrictions as those of the original document.

# THE BICYCLE BUILDER'S BIBLE

How to modify, build, select, buy, use, repair, and recondition bicycles and pedal/operated vehicles . . . plus how to make novelty and specialty bicycles, and construct a pedal-driven electricity generator!

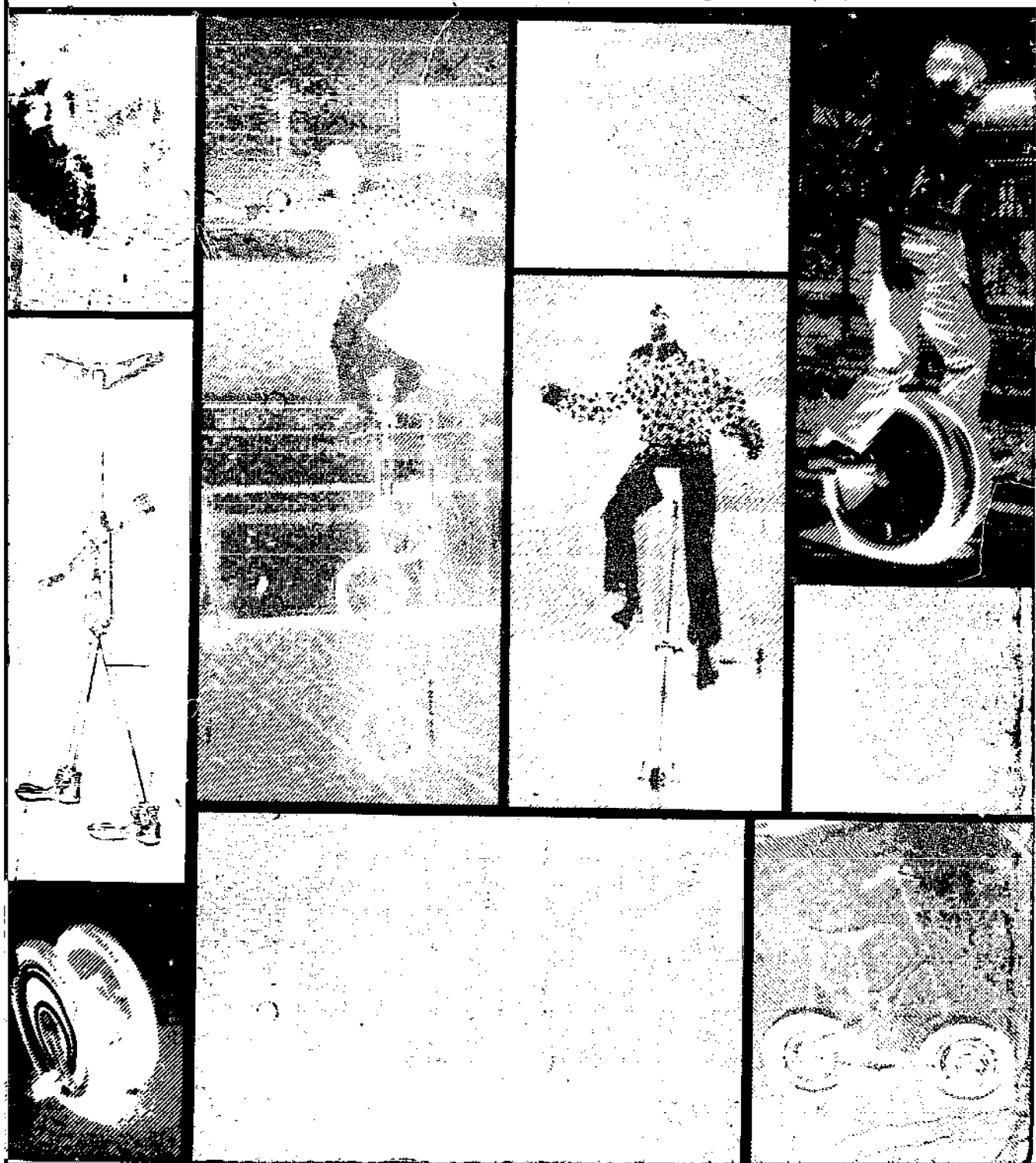

If you're an experienced rider, or if you've just discovered the benefits of bicycling and pedal power, this book will show you how to get more enjoyment and practical use out of the sport. You'll learn how you can get more for the money you invest, how to save money on maintenance and repairs, and how to create your own unique bicycle or pedal-powered vehicle by modifying existing designs or starting from scratch. No matter how inexperienced you may be with mechanical things, this book will show you how to do as much as you want to do . . . including how to generate your own electricity from a converted pedal-powered unit!

This is far more than just a fix-it book. It will help you understand the features of available bikes so you can buy more intelligently; it explains how to care for and protect, transport, park, and use your bike. You'll learn how bicycles work, and what you need to know, and have, to maintain and repair them. In addition to complete maintenance procedures, the author tells how the critical mechanical parts work, how to make adjustments, and how to overhaul and rebuild them. He also covers reconditioning procedures for those who want to salvage an old or junked bicycle.

If you want to create an unusual machine or a copy of a classic, there are detailed tips on building or converting an existing bicycle into a tandem, a folding bike, a pedal car, adult and industrial tricycles, high-rise bicycle, pivot bike, a portable, penny farthing, double-decker, bronco, miniature bicycles, walking machines, recumbent cycles, water pedal cycles, flying pedal cycles, or a unicycle. Also covered are motocross bikes, stationary exercise bikes, and artistic bicycles. Kits and conversions are covered in detail, too; each part and each step of assembly (and disassembly) are fully illustrated and explained. Whether you're a newcomer to the world of pedal power, a serious enthusiast, a do-it-yourselfer, a weekend mechanic or just enjoy riding bicycles but not paying top dollar for repairs, this book should make a welcome addition to your library.

## OTHER POPULAR TAB BOOKS OF INTEREST

### The Bicyclist's Bible

(No. 846—\$5.95 paper; \$9.95 hard)

### Mopeddaller's Handy Manual

(No. 2044—\$2.25 paper, only)

### Moped Repair Handbook

(No. 976—\$7.95 paper; \$9.95 hard)

### Motorcycle Repair Handbook

(No. 789—\$6.95 paper; \$9.95 hard)

### The Complete

### Snowmobile Repair Handbook

(No. 705—\$5.95 paper; \$9.95 hard)

### How To Make Your Own Camping & Hiking Gear

(No. 1014—\$7.95 paper; \$9.95 hard)

### 101 Practical Uses for Propane Torches

(No. 1030—\$3.55 paper; \$6.95 hard)

## TAB BOOKS

ALSO PUBLISHERS OF MODERN AUTOMOTIVE SERIES & MODERN AVIATION SERIES  
BLUE RIDGE SUMMIT, PA. 17214

Send for FREE TAB Catalog describing over 750 current titles in print.

ISBN 0-8306-1156-8

Prices higher in Canada

# THE BICYCLE BUILDER'S BIBLE

**TAB BOOKS Inc.**

BLUE RIDGE SUMMIT, PA. 17214

FIRST EDITION

FIRST PRINTING—APRIL 1980

Copyright © 1980 by TAB BOOKS Inc.

Printed in the United States of America

Reproduction or publication of the content in any manner, without express permission of the publisher, is prohibited. No liability is assumed with respect to the use of the information herein.

**Library of Congress Cataloging in Publication Data**

Wiley, Jack.

The bicycle builder's bible.

Includes index.

1. Bicycles and tricycles. 2. Bicycles and tricycles—Maintenance and repair. 3. Bicycles and tricycles—Design and construction. I. Title.

TL410.W53 629.22'72 79-25236

ISBN 0-8306-9725-X

ISBN 0-8306-1156-8 pbk.

# Contents

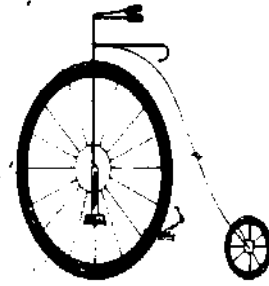

	<b>Acknowledgements</b> .....	7
<b>1</b>	<b>Introduction To Pedal Cycles</b> .....	9
	Capsule History—Pedal Cycles Today—Uses of Pedal Cycles	
<b>2</b>	<b>How To Choose a Bicycle</b> .....	19
	The Best Bike for You—Single-Speed Bikes—Internal Hub Multi-Speed Bikes—Derailleur Bikes—Riding Posture—Intended Use—Price and Quality—Comparison of Bicycles—Frames—Finish—Components—The Total Bicycle and Weight—The Rider and the Bicycle—Accessories—Price, Design, Quality and Weight	
<b>3</b>	<b>Using Bicycles</b> .....	77
	Riding—Gear Shifting—Braking—Cornering—Safety—Helmets and Head Gear—Legal Requirements—Transporting Bicycles—Bicycle Parking and Racks—Touring—Bicycling for Physical Fitness—Doing Your Thing on a Bicycle—Racing	
<b>4</b>	<b>Basic Bicycle Mechanics</b> .....	103
	Tools—Maintenance Stands—Cleaning Pans and Solvent Supplies—Parts—Some Basics	
<b>5</b>	<b>Bicycle Maintenance</b> .....	117
	Monthly Oil Maintenance—Adjustments—Cleaning, Polishing, and Waxing—Six-Month and Yearly Overhauls—The Overall Maintenance Picture—Tires and Tubes—Hubs and Freewheels—Adjusting Cones—Overhauling Hubs—Freewheels—Wheel Truing—Straightening Rims—Protruding Spokes—Wheel Lacing—Caliper Brakes—Disc Brakes—Pedals—Chains—Crank Sets—Derailleurs—Head Sets and Handlebars—Saddles and Seat Posts	
<b>6</b>	<b>Reconditioning, Modifying and Building Bicycles</b> .....	197
	The Frame—Painting—Cleaning Plated Components—Assembly—Modifications—Custom Bicycle Frame Building—Tools—Brazing and Welding—Parts and Materials—Basic Techniques—General Construction Plan	
<b>7</b>	<b>Portable Bicycles</b> .....	209
	Manufactured Models—Conversions—Making Your Own—Maintenance and Repair—Tips on Using Portable Bikes	

<b>8</b>	<b>Stationary Exercise Cycles and Bicycle Rollers</b> .....	<b>223</b>
	Exercise Cycles—Converting Bicycles to Exercise Cycles— Bicycle Rollers—Physical Fitness Programs	
<b>9</b>	<b>Motocross Bikes</b> .....	<b>235</b>
	Conversions—Motocross Courses—Technical Inspection of Bicycles—Safety Gear—Riding Tips—Maintenance and Repair	
<b>10</b>	<b>Bronco, High-Rise and Pivot Bicycles</b> .....	<b>247</b>
	Construction of Bronco Bikes—Tips on Using Bronco Bikes— High-Rise and Pivot Bicycles—The Swing Bike	
<b>11</b>	<b>Tricycles and Sidewalk Bikes</b> .....	<b>259</b>
	Maintenance and Repair—Tricycles for Adults—Manufactured Tricycles—Industrial Tricycles—Conversion Units—Care, Repair and Maintenance—Tips on Using a Tricycle—Pedal Cars— Sidewalk Bikes—Conversion of a Tricycle to a Two-Wheeler	
<b>12</b>	<b>Penny Farthings</b> .....	<b>277</b>
	Finding Antique Penny Farthings—Modern Manufactured Versions—Building Penny Farthings—Riding Penny Farthings—A Variation—Ideas for Penny Farthings	
<b>13</b>	<b>Tandem and Double-Decker Bicycles</b> .....	<b>283</b>
	Manufactured Tandems—Building Tandems—Tips on Using Tandems—Double-Decker Bikes—Construction of Double- Decker Bikes—Tips on Using Double-Decker Bikes	
<b>14</b>	<b>Artistic Bicycles</b> .....	<b>293</b>
	Manufactured Artistic Bicycles—Conversions—Care, Repair and Maintenance—Tips on Using Artistic Bikes—Ideas for Artistic Bicycling	
<b>15</b>	<b>Unicycles</b> .....	<b>301</b>
	Brief History of Unicycles—Introduction to Unicycles— Manufactured Unicycles—Building Unicycles—Standard Unicycles—Care, Maintenance and Repair of Unicycles— Learning to Ride a Unicycle—Ideas for Unicycles and Unicycling	
<b>16</b>	<b>Further Ideas for Novelty and Specialty Cycles</b> .....	<b>337</b>
	Miniature Bicycles—Walking Machines—Recumbent Cycles— Pedal Cars—Water Pedal Cycles—Flying Pedal Cycles— Railroad Bicycles	
<b>17</b>	<b>Generating Power with Bicycles</b> .....	<b>347</b>
	Materials—Construction Steps—A Pedal-Driven Winch— Archimedes Screw—Borehole Pumps—Building a Flywheel— Pedal-Driven Pumps—A Pedal-Powered Log Splitter	
	<b>Index</b> .....	<b>369</b>

## Acknowledgements

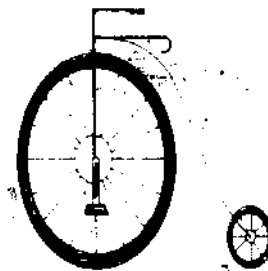

This is a book about regular bicycles and a variety of novelty and specialty cycles. Subjects covered include selecting, using, maintaining, repairing, modifying, and building pedal cycles.

I would like to thank the many individuals and companies who supplied information and materials and gave permission to reprint illustrations. I am indebted to: William M. Jenack, Editor of the *Unicycling Society of America Newsletter*; Bernard Crandell, director of the *Pontiac Unicycle Club*; Warren C. Wood, director of the *Great Y Circus*; Jess Monefield—his current stage name is Jim Dandy; Chas R. Sipe; John Jenack; Kit Summers; John Held; Brian Martin; Fred Teeman, manager, consumer relations, *Schwinn Bicycle Co.*; William J. Ennis, public relations director, *Shimano Sales Corp.*; Bob Shaver, director of product development, *The Jacobs Corp.*; Howard C. Hawkins, *Park Tool Co.*; Arthur Lipski, president, *Oxford International Corp.*; M.G. Myer, advertising manager, *Wheel Goods Division, AMF, Inc.*; Thomas D. Seifert, president, *LRV Industries*; John Nicol, vice president, marketing & engineering, *Teledyne Linair Engineering*; Raymond N. Seakan, sales manager, bike security systems division, *Acro-Fab Industries Inc.*; Barry Konig, *Proteus Design Inc.*; Bruce Danzigei, vice president, advertising & marketing, *Ross Chain Bike Corp.*; O.F. Quaas, *Bendix Corporation*; I. Taniuchi, *C. Itoh & Co (America) Inc.*; Alan B. Gobby, *Gobby Manufacturing Inc.*; Peter Rizzo, consumer relations, *Atkins-Graber Inc.*; Charles T. Willmarth, *Willmarths Co.*; Ken. Yoshigai, *Dia-Compe Inc.*; Dick Konieczny,



president, *HighStep Bicycle Co.*; Klaus J. Schulz, controller, *Cycles Peugeot (U.S.A.) Inc.*; Arthur C. Sommers, *Garton-Fox Corporation*; Harry P. Teßtmeyer, *Industrial Cycles Inc.*; *MTD Products Inc.*; *Sound Art Manufacturing Company Inc.*; *Cannondale Corp.*; *Columbia Manufacturing Co. Inc.*; *Gitane Pacific Inc.* *Altra Inc.*; *Bell Helmets Inc.*; *Zeus Cyclery Corporation*; *Trans-American-West*; *Todson Inc.*; *Kar Dol Corp.*; *Swing Bike Company*; *Toyoda America Inc.*; *State Aluminum Foundry*; *Carlisle Tire & Rubber Co.*; *Maeda Industries of U.S.A. Inc.*; and *Two Wheeler's BMX Products*.

Jack Wiley



## Introduction To Pedal Cycles

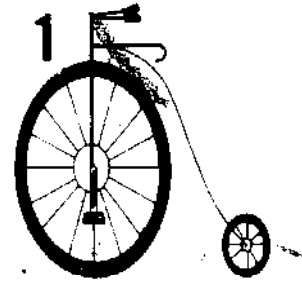

Pedal Power is a rather recent innovation—at least on a practical scale. In one sense this might be fortunate. The potential of pedal power by slave teams using oars in boats and levers and ropes on land was never fully realized.

While there is good evidence that Leonardo da Vinci (1452-1519) or one of his assistants made a drawing of a pedal-driven bicycle, it seems that the actual construction of such a device did not come until years later. Even then the route deviated widely before coming back to essentially the bicycle design shown in the supposed Leonardo drawing.

The history of pedal cycles is usually written as though the development of the modern bicycle is the only concern. However, there are many other important offshoots. Pedal power is used today in an array of cycles that include one, two, three and four wheel devices. Popular uses include recreation (Fig. 1-1 and Fig. 1-2), sport, hobby, fitness, transportation and artistic expression.

### **CAPSULE HISTORY**

In the late 1970's, Comte de Sivrac, a Frenchman, constructed a crude wooden hobby horse. The rider straddled the device and supplied power by pushing against the ground. There was no means of steering short of stopping, lifting the hobby horse off the ground, turning it a new direction and then starting forward again.

Around 1816, Baron Karl Von Drais, a German, developed a steerable hobby horse. He is reported to have made a 20-mile trip

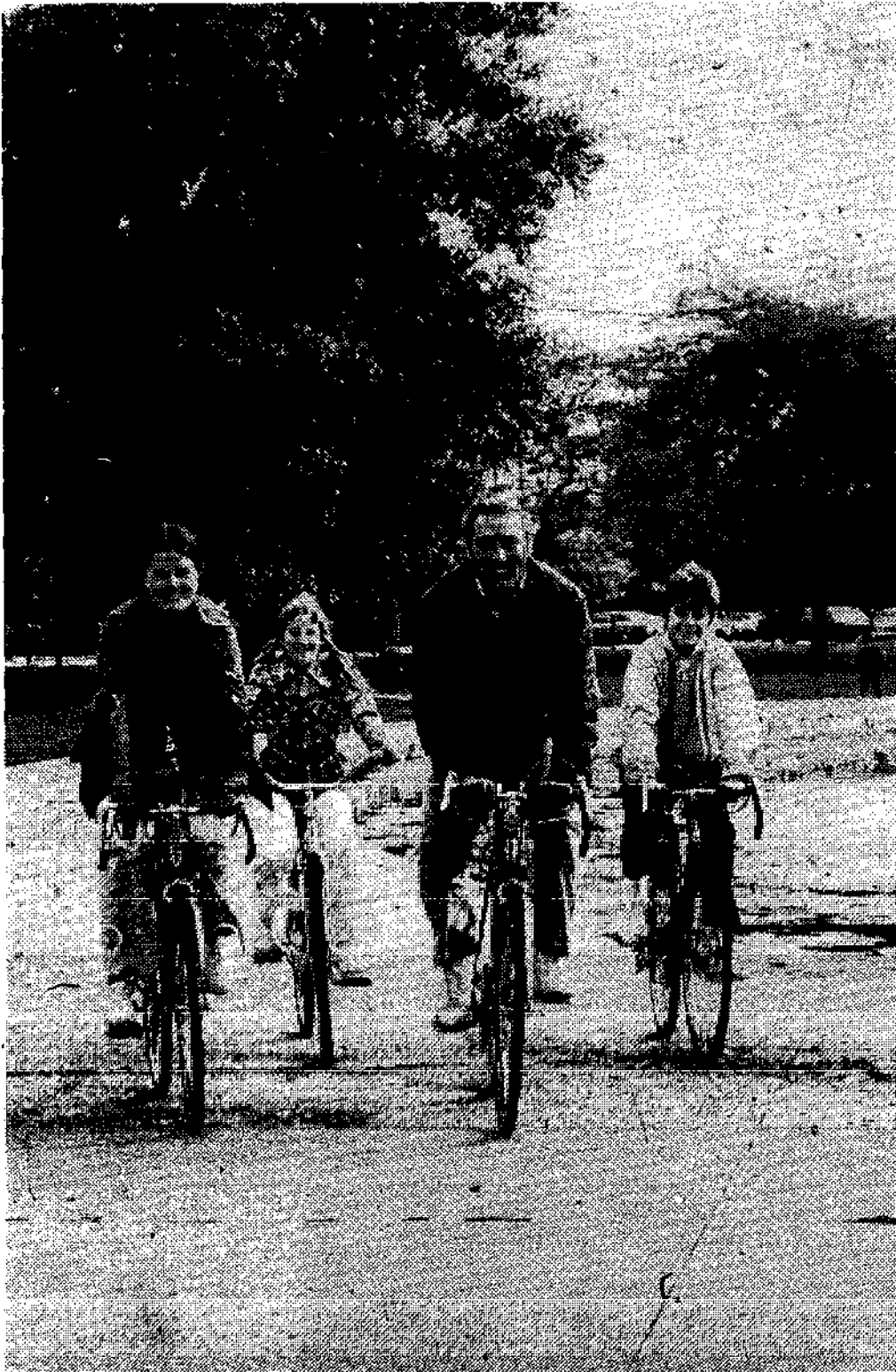

Fig. 1-1. Bicycling for recreation and fitness.

on the device in three hours. A demonstration of the device in Paris in 1818 started a hobby horse boom that swept Europe.

It is sometimes said that during this stage of bicycle development people thought maintaining balance required having both feet in contact with the ground. But almost certainly it was known that

balance could be kept while coasting downhill with the feet completely off the ground. Also, some early hobbyhorses had footrest extensions on the front axle, apparently for placing the feet after speed had been gained by pushing against the ground.

In 1840, Kirkpatrick Macmillan, a Scottish blacksmith, constructed a treadle-operated two-wheel device. It could be ridden with the feet completely off the ground. He reportedly made a 40-mile trip on the device in 1842.

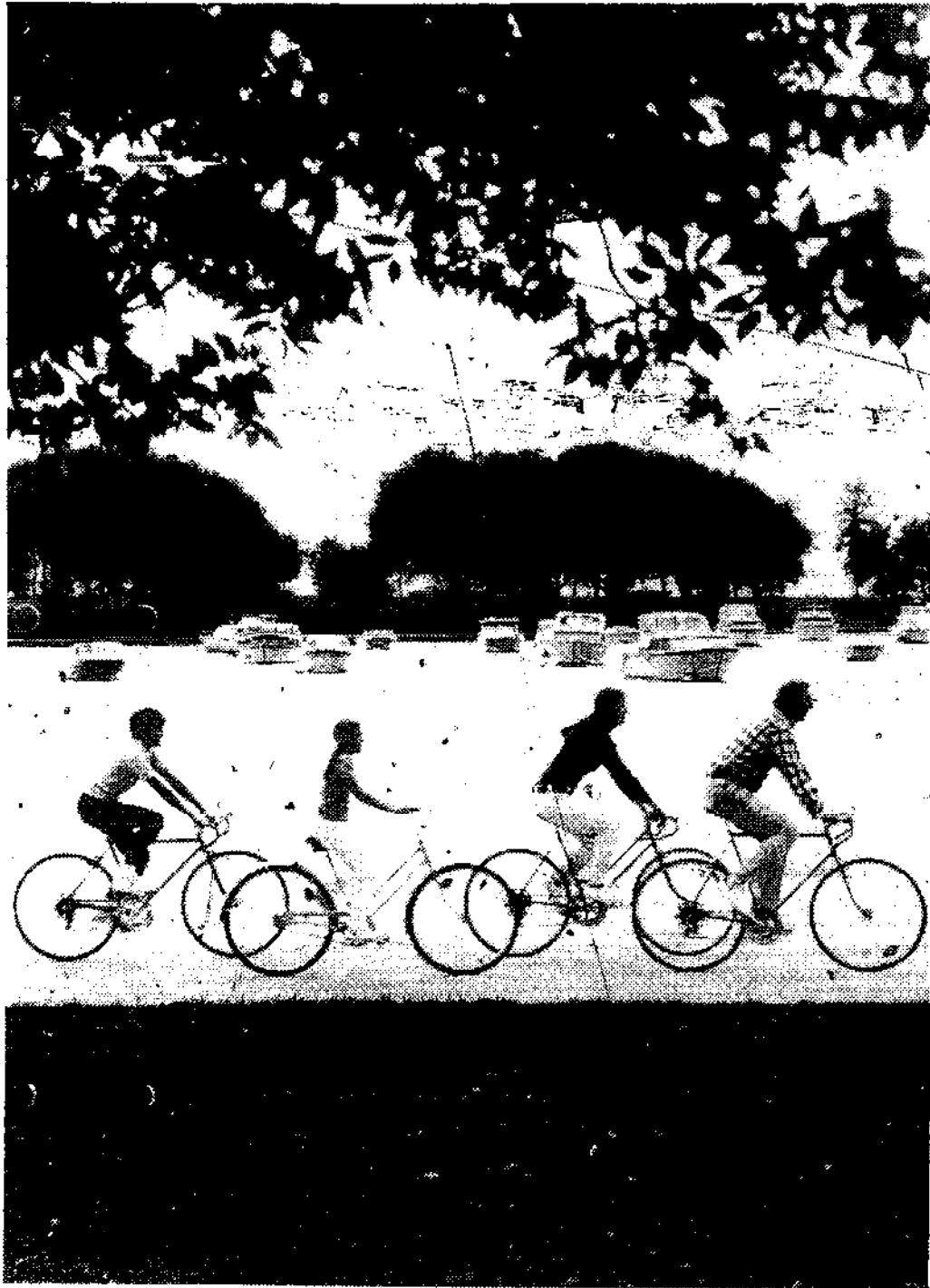

Fig. 1-2. Bicycling allows enjoying the scenery.

A device operated by pedals rotated in a circle was constructed in the 1860's by Ernest Michaux, a Frenchman. Pedal arms and pedals were connected to the front axle. The cycle had wooden wheels of equal size, a heavy iron frame, and iron tires. These cycles were appropriately called *boneshakers*.

About 1870, James Starley, an Englishman, constructed a variation of Michaux's design with a larger front wheel and a smaller rear wheel. These came to be called the *ordinary* or *penny farthing*.

These cycles soon spread to the United States. Around 1876 the *Cunningham Co.* began importing them to the United States. Shortly thereafter the *Columbia Co.*, in the United States, began manufacturing them. They started with a 70-pound model that sold for over \$300 and that was a considerable sum of money in the 1870s.

Around 1884 Thomas Stevens, an American, reportedly became the first person to pedal a two-wheel cycle around the world. He used a Columbia penny farthing.

In 1885, John K. Starley, an Englishman, developed what came to be called the *safety* bicycle. It featured a chain driven rear wheel, a diamond shaped frame and equal size wheels with solid rubber tires.

The modern bicycle is essentially improvements and features that were added to Starley's design. Examples are pneumatic tires—developed about 1888, coaster brakes—starting about 1898 and free wheeling—developed before 1900.

By the mid 1890's, the safety bicycle had, for all practical purposes, replaced the penny farthing.

This capsule history is given in terms of historic turning points, but hundreds of people made contributions. Many offshoots such as unicycles, artistic bicycles and tricycles are still popular.

The 1890s featured the first big bicycling boom. At one point there were over 400 bicycle manufacturers in the United States. The most basic features found on bicycles today, including gearing systems that allowed changes while riding, were around before 1900.

With the advent of the automobile, the bicycle became largely relegated to children. However, this did not stop the further improvement and refinement of the bicycle. The construction methods, precision and strength-to-weight ratio have generally been improved. The second big bicycle boom in the United States started in the early 1970s (Fig. 1-3).

## **PEDAL CYCLES TODAY**

The so-called "pure" bicyclist would have you believe that the

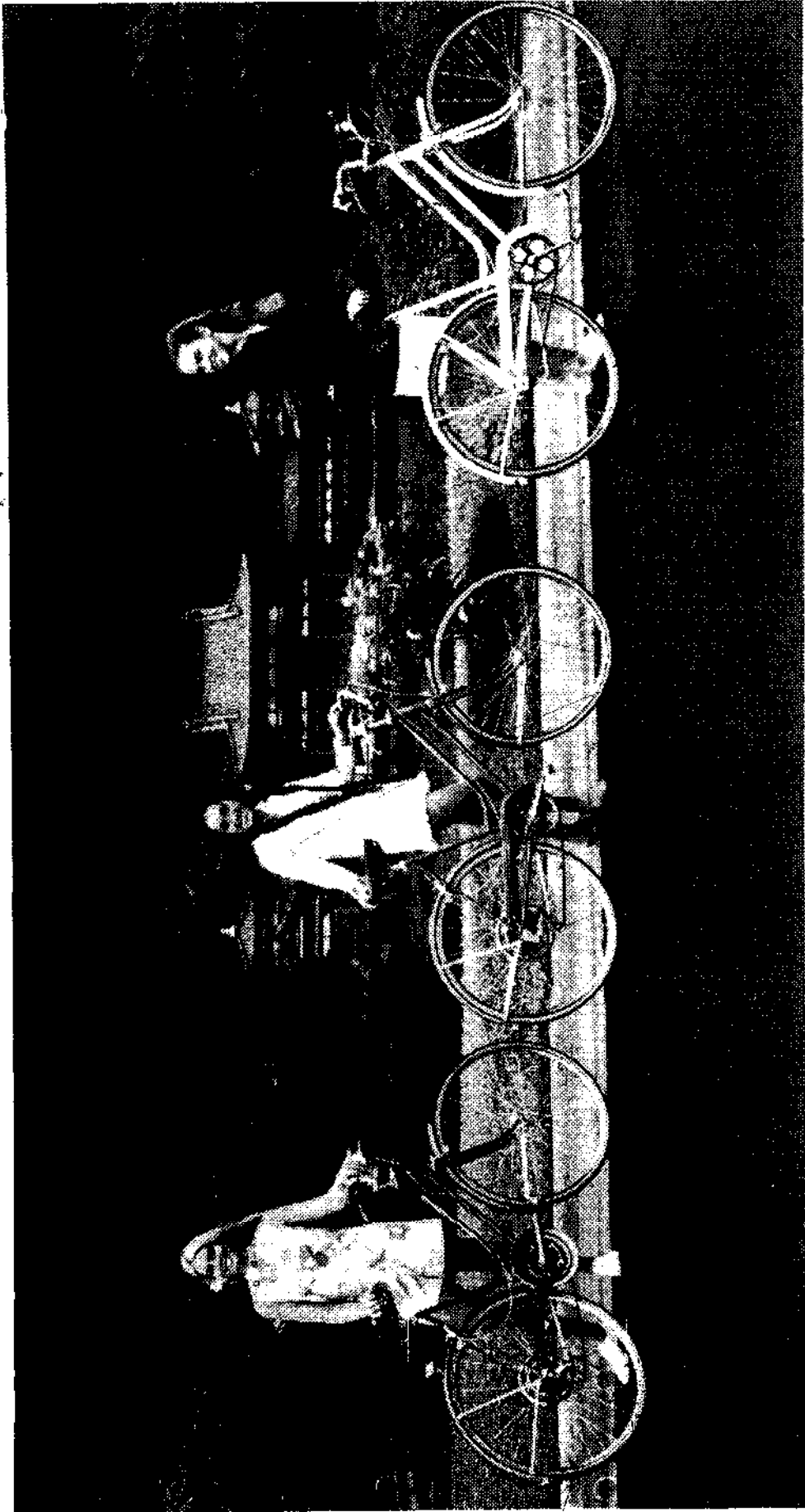

Fig. 1-3. Bicycling today.

only real bicycles are lightweight racing and touring machines and that you aren't really living unless you devote at least 27 hours a day to the care and use of your bicycle.

Such a point of view leaves out the vast majority of bicycles and bicycle users. In fact, so many types of bicycles are manufactured and in use that it is almost impossible to label any single type as being *the* standard or regular bicycle.

In addition, many novelty and special cycles are manufactured. They include tandems, penny farthings, adult tricycles, portable bicycles, stationary exercise cycles, artistic bicycles, swing or pivot bikes and unicycles (Fig. 1-4). Many other types, such as tall or upside-down bikes, recumbent cycles and bronco bikes are not being manufactured. However, they can be built and used.

One popular book on bicycling devotes almost all of its contents to precision, expensive 10-speeds. The minimum preventative maintenance schedule given for one bike amounts to a full-time job. This might be fine for the few who are so dedicated, but the simple fact is that the vast majority of pedal cycles in use today receive little or no preventative maintenance until there is an actual breakdown that will not allow the cycle to be used until some repair is made.

This book attempts to take a realistic look at pedal cycle ownership. For example, while I believe that some maintenance is beneficial even for the casual or utility cycle user, it should be practical to his or her intents and purposes. A person who occasionally rides a bicycle around the block cannot be expected to follow the same bicycle maintenance program as the racing or cross-country touring cyclist. Nor would there be any practical reason to do so.

While the bicycle is probably far and away the most important pedal cycle for most people, it's not the only one and this fact will be kept in mind throughout this book.

## **USES OF PEDAL CYCLES**

Take a closer look at how pedal cycles are used. The common element seems to be physical fitness-although a particular pedal cycle can be so much fun that you do not realize this or think of using the cycle as a fitness activity. Since you provide the pedal power, it cannot be otherwise. All pedal cycles have this in common. The stationary exercise or go-nowhere cycle is used almost entirely for this purpose.

Other than perhaps the stationary cycle, all pedal cycles provide recreation. They are fun to ride. Some of course more so than others and people have their preferences in this regard.



Fig 1-4. Kit Summers riding a unicycle.

There are some "pure" bicyclists who look down at a unicycle and there are some unicyclists who do not like 10-speeds. But there are others, myself among them, who find the two things compatible.

Bicycles, including tandems and sometimes adult tricycles, are used for transportation and they are ecologically sound in comparison to motor vehicles. Bicycling can merely be a way to get to nearby places, but some people go much further than this. They use pedal cycles, usually bicycles, for traveling long distances and many have used bicycles for taking vacations. A few have used the bicycle for extended travels and adventures. Around the world trips—or at least the land portion—have been made on penny farthings and regular and tandem bicycles. Wally Watts, a Canadian, recently completed an incredible journey around the world on a unicycle! This doing-your-thing aspect should not be taken lightly. There are few great adventures left in the realm of the average person.

The sport aspects of cycling are extremely important to some people. There are many kinds of racing events that are held on tracks or roads. Motocross bicycling—racing around a special course with a variety of jumps, turns and obstacles—is a popular sport with children in the United States. Racing on unicycles is also popular.

Various competitive games are played on bicycles and unicycles. Bicycle polo is sometimes played in the United States and bicycle ball is popular in Europe.



There are also competitions in both artistic bicycling (Fig. 1-5) and unicycling. These sports are growing rapidly in popularity. Closely related are demonstration teams and acts. Many types of cycles have been used—both at the amateur and professional level. Novelty and special cycles are popular for riding in parades and many clubs and groups have formed across the country.

At least one antique cycle, the penny farthing, is making a comeback as a novelty cycle. Perhaps it never completely disappeared.

I feel the possibilities that pedal cycles offer for building, inventing and creating are extremely important. While specific projects are detailed in this book, considerable effort is spent in trying to get the readers to go on to *originals*, as they are sometimes called. In many areas the amateur innovator stands little chance, but not so in the pedal cycle field. You can really let your imagination go and have the possibility of actually building and trying out your ideas. This is something that would likely be impossible for, say, the subject of space travel.

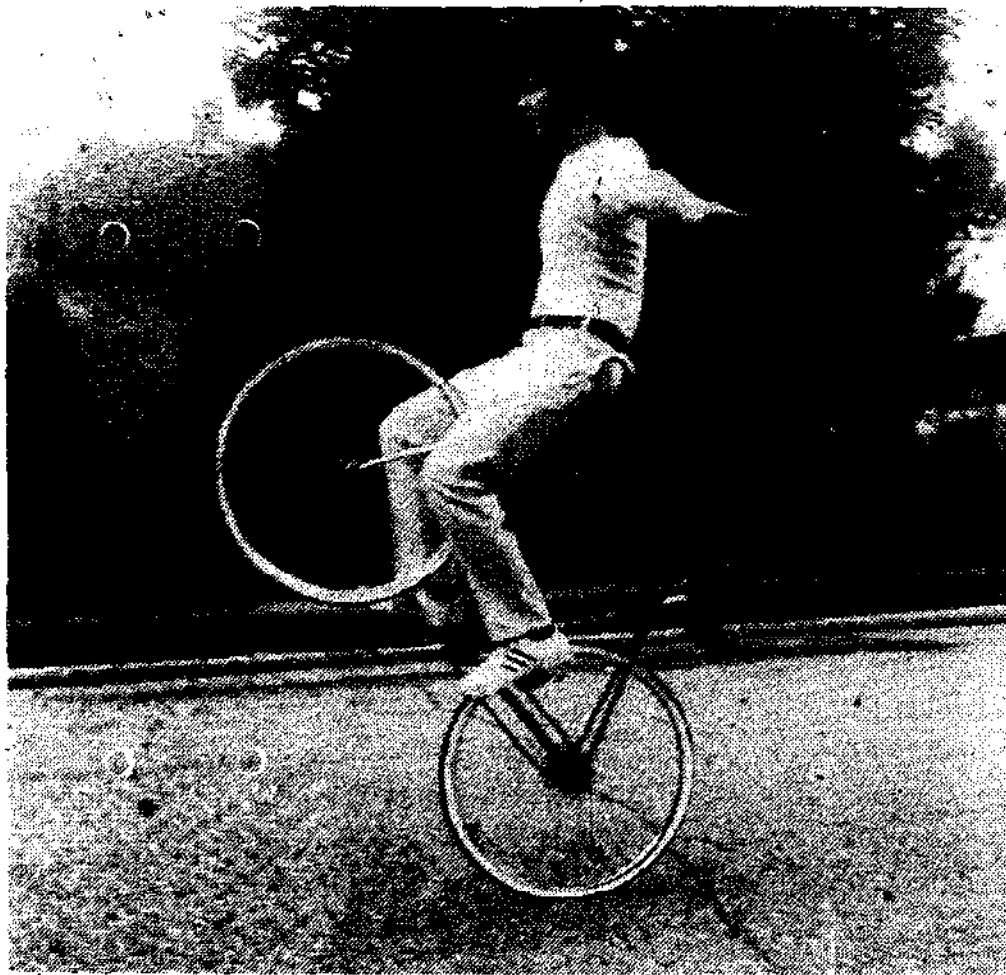

Fig. 1-5. John Jenack demonstrates his skill on an artistic bicycle

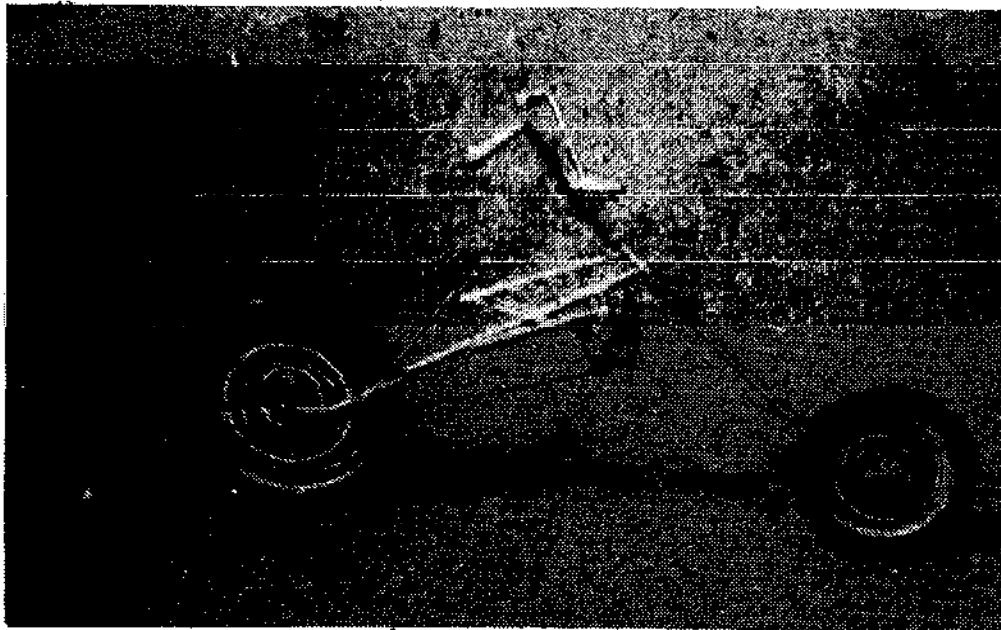

Fig. 1-6. A novelty bicycle.

The term *building*, as used in this book, might be misleading—or at least it should be qualified. First, the *building* is when it is practical to do so. In the case of manufactured cycles that are readily available, especially those that are popular and made in large numbers, it is generally impractical to build them—at least in terms of trying to save money. Second, most of the projects described in this book make use of standard bicycle parts and components and other readily available items.

Customizing and modifying bicycles and building novelty or special cycles is fast becoming a popular hobby and pastime (Fig. 1-6). A number of kits are available for making certain modifications to bicycles and converting bicycles to novelty and specialty cycles. In many cases, these provide the easiest means of going about the task.

Slightly more difficult, but still within the range of many bicycle owners, are the construction of the various novelty and specialty cycles from bicycle components and other materials without the use of kits. The amount of skill required for these building projects varies widely. Many require only minimal mechanical skills. Those that require considerable skill and special equipment, such as brazing and welding, have been set up so that, if you desire, you can do part of the work and then have the remainder done at a commercial shop. Certainly it would not pay to take up welding and purchase the necessary equipment for one or two building projects. But for the person who wants to do many projects, this might become practical.

## How to Choose A Bicycle

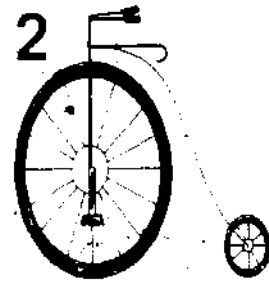

Utility, touring and racing bicycles are covered in this chapter. Various novelty and specialty bicycles, such as sidewalk and high-rise bikes for youngsters, are covered in later chapters. However, the information in this chapter will help you form the basis for choosing and equipping all types of pedal cycles.

### THE BEST BIKE FOR YOU

The first problem is to find the right bicycle for your budget and needs. This depends on how you intend to use the bicycle and how much you can afford to spend. It's possible to have too much bicycle for your intended use, as well as too little. For ordinary around-town riding, an expensive touring machine is probably more bicycle than you need. The lighter weight and greater precision make it more delicate and it requires more care and maintenance than a somewhat heavier, less precise machine. A delicate machine also leads to greater problems in protecting it from wear, damage from the environment or theft.

The performance of a bicycle is a combination of the rider and the bike. Important factors on the bicycle itself are design, precision, weight and condition. The bicycle can be considered an extension of the rider's most powerful muscles. The combination is very effective for transferring the linear motion machine—the human body—into a rotary machine, the rolling motion of the bicycle wheels. The human body, of course, is far more versatile when not on a bicycle and capable of many diverse actions, such as walking,

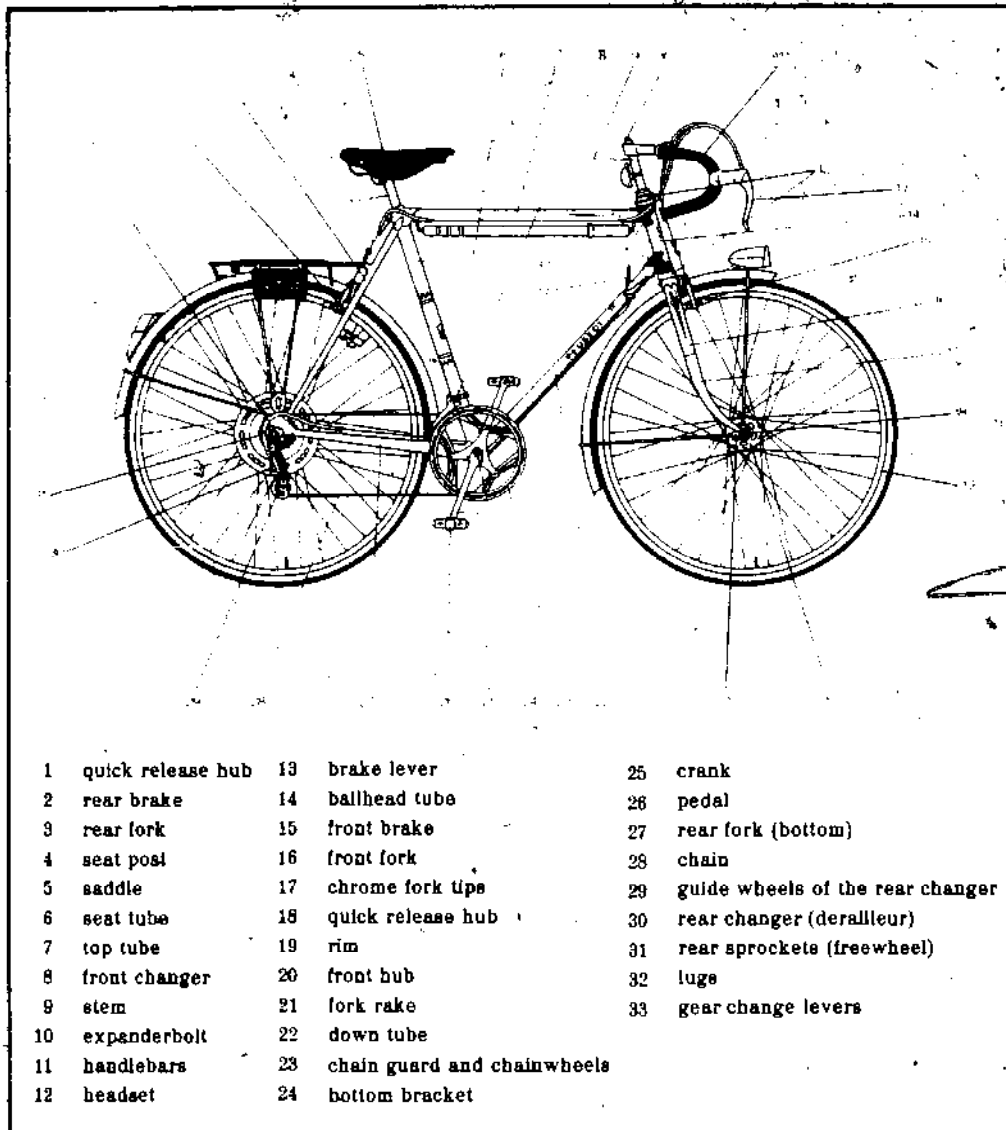

Fig. 2-1. The parts of a bicycle.

running or climbing stairs and ladders. A bicycle is far more limited and must always be combined with a person to generate a source of power. However, on smooth hard surfaces that are level or of limited grades, a bicycle can transfer human power input into very effective and efficient motion. Pedal power is, to my knowledge, the only way human power alone has managed to get a heavier than air device, a flying pedal cycle, off the ground more than momentarily from a level surface.

Bicycles are a serious compromises. The person who wishes to take up bicycling for the first time is faced with a seemingly endless number of bicycles to choose from. To complicate matters, there is no simple way to classify bicycles. To sort out the picture, I will first discuss bicycles in a general way, and then cover the specifics of design and construction.

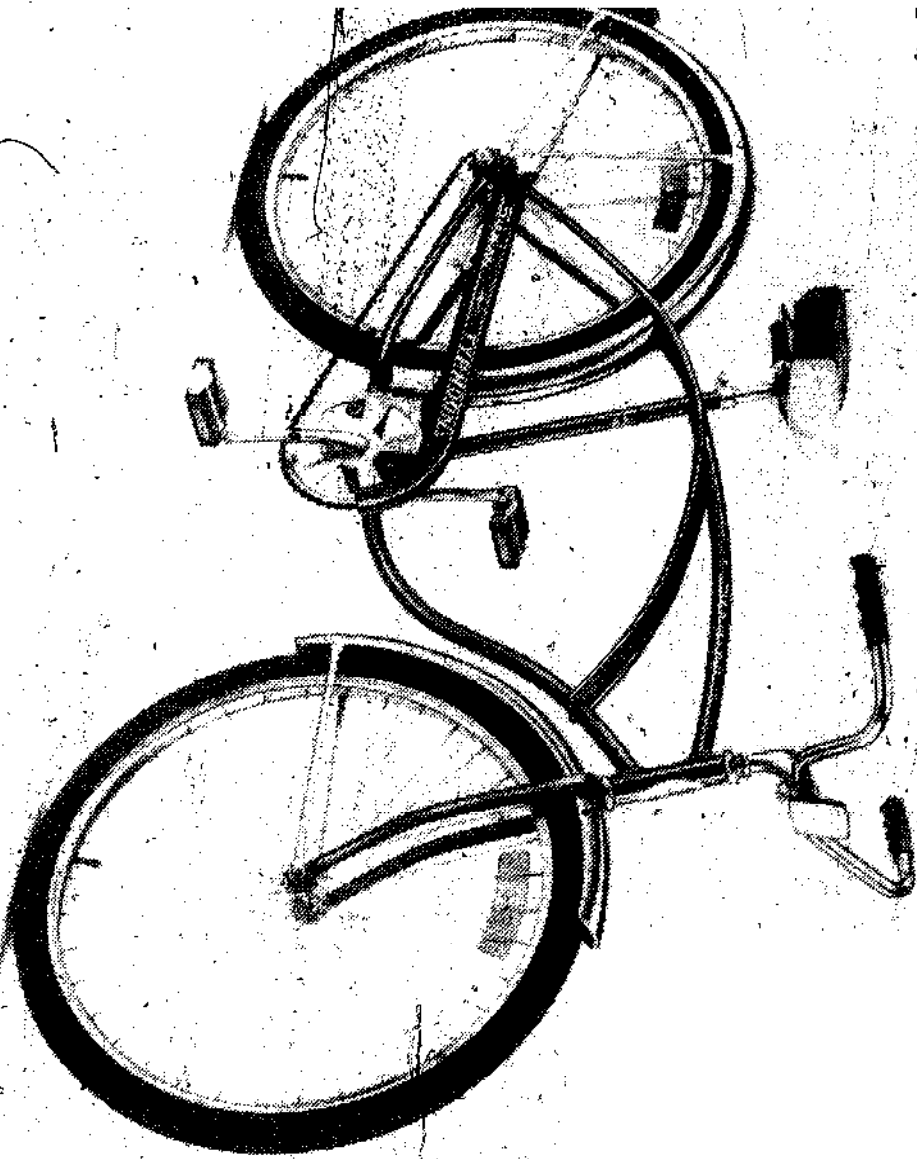

Fig. 2-2. A middleweight single-speed with coaster brake.

## SINGLE-SPEED BIKES

Perhaps the most basic bicycle in widespread use today is the single-speed. It has only one gear ratio and it is a fixed ratio. Gear ratios will be explained later in this chapter. For now, it's only important to get a general idea of the types of bicycles available. A single-speed bicycle is shown in Fig. 2-2.

There was a time when most single-speed bikes had *balloon* tires and were called *heavy weights* or *American* bicycles. Today, single-speeds are more likely to be middle weights and there are also some reasonably lightweight models on the market. Bicycle weight is discussed in detail later in this chapter. For now, it is enough to say that light weight tends to be an advantage in bicycle performance. A single-speed bicycle of the same shape, weight and precision will have the same performance as a multi-gear bicycle ridden in the same gear ratio. This might seem obvious, but it is a fact often overlooked. Many people believe that a 10-speed, disregarding the ability to change gear ratios, is automatically a better performing bicycle. This is caused in part by the fact that few medium-priced and almost no high-priced bikes are available in single-speed models. The reverse, however, is not true. Many low-priced bikes feature gearing systems.

Single-speed bicycles generally have coaster brakes. Braking is accomplished by means of back pedaling. This is an extremely convenient arrangement that allows both pedaling and braking by foot action. These bikes can usually be recognized by the absence of hand operated brake levers. Coaster brakes are sometimes supplemented with a caliper brake on the front wheel. These have one hand-lever control on the handlebars. Coaster brakes can also be recognized by a brake arm that connects to the bike frame.

Another type of single-speed bike is the fixed sprocket (non-freewheeling) track racing cycle shown in Fig 2-3. These fixed hubs are generally found only on top quality bicycles and should not be confused with freewheeling single-speeds. Freewheeling allows the wheel to continue turning even when you aren't pedaling. This coasting is a tremendous advantage for normal riding.

The main advantages of single-speed bikes are that they have no complicated gear changing mechanisms and, on most models, braking by simple back pedaling. The disadvantage is that all riding must be done in a single gear ratio.

For many purposes, especially for limited riding on fairly level surfaces, the single-speed is all that is needed (Fig. 2-4). There are many 10-speed bicycles that, after the initial novelty of shifting the

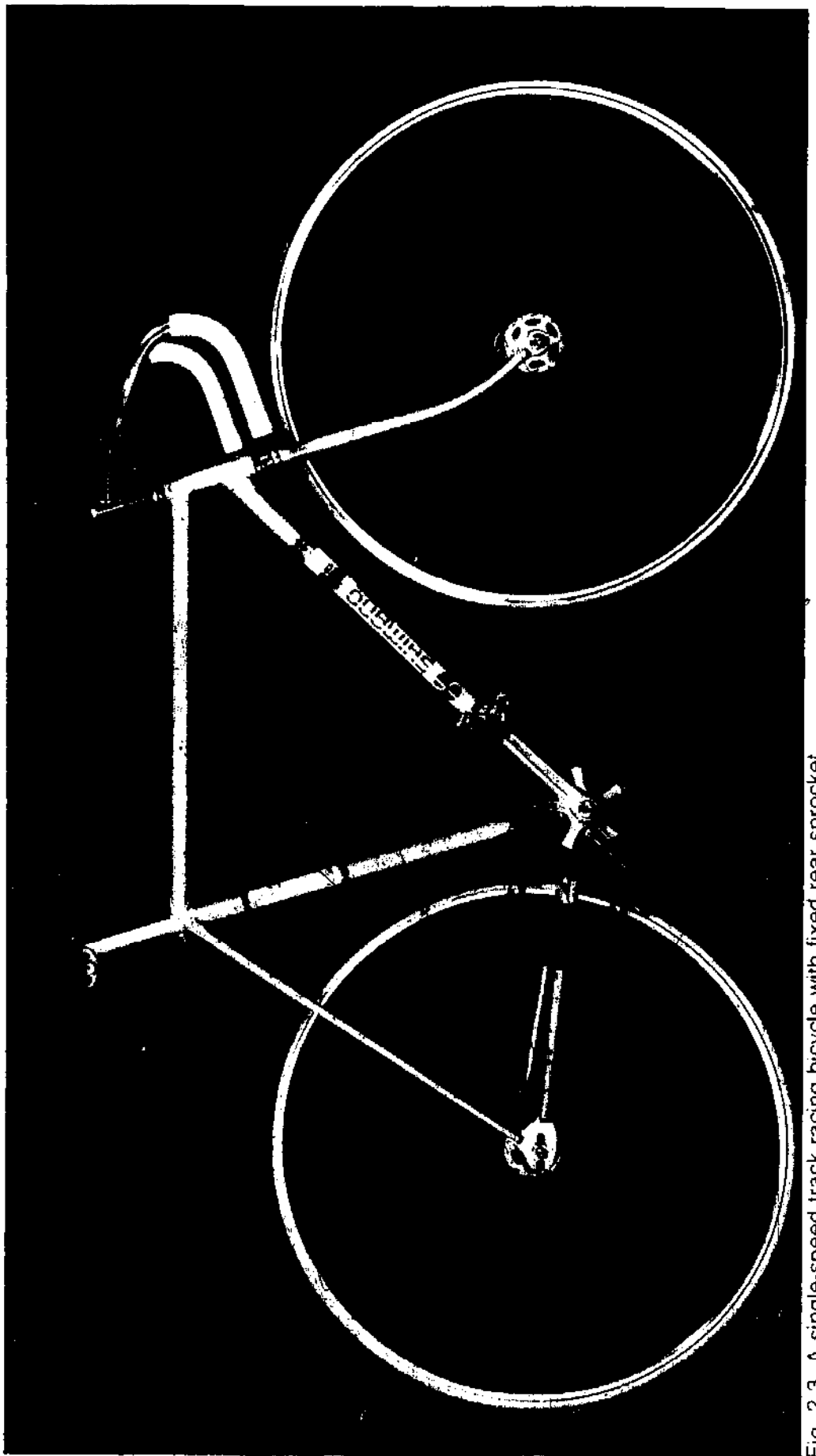

Fig. 2-3 A single-speed track racing bicycle with fixed rear sprocket.

10 gears wears out, remain set in a single gear year in and year out. This applies mainly to bicycles that are used for short hops on level surfaces. The advantages of being able to change the gear ratios becomes quickly apparent on hills and longer rides.

### **INTERNAL HUB MULTI-SPEED BIKES**

The next improvement—or complication depending on how you look at it—is internal hub gearing. This gearing most commonly offers three speeds or gear ratios (Fig. 2-5). It is also available with two-gear and five-gear ratios, as well as other numbers. Most of these are shifted by a hand lever, but models that shift automatically with changes in speed are also available.

Internal hub multi-speed gears generally present more difficult adjustment, maintenance and repair problems than single-speeds—they also offer the important riding advantage of a choice of gear ratios.

Bikes with internal hub gearing are ideal when something more than a single gear ratio is needed, but something less than a 10-speed is adequate.

While internal hub gears make riding slightly more complicated than single-speeds, they are generally much easier to operate—or at least easier to operate—than derailleur changers. The internal hub gears are more suitable for those who do not want to, or cannot, master the derailleur system.

A few years back, internal geared bikes were representative of a type called *English racers*. Today, however, the internal hub gears are used on so many types and qualities of bicycles that they no longer represent a specific type of bicycle. As is the case with single-speeds, other than fixed hub track bikes, the internal hub geared bikes are generally only available in the lower price and quality ranges. However, they often extend upward a notch or two above what is available in single-speeds, with a correspondingly higher price tag.

In general, the advantages of internal hub gears (Fig. 2-6) over derailleur systems are ease of adjustment and operation. Disadvantages are a smaller number of gear choices and difficulty in making internal repairs when they break down—which fortunately isn't often.

### **DERAILLEUR BIKES**

The next general type of bicycle is the 10-speed, with derailleur gears (Fig. 2-7). The operation of these is detailed later in this chapter. While other numbers of gears—especially five (Fig. 2-8).



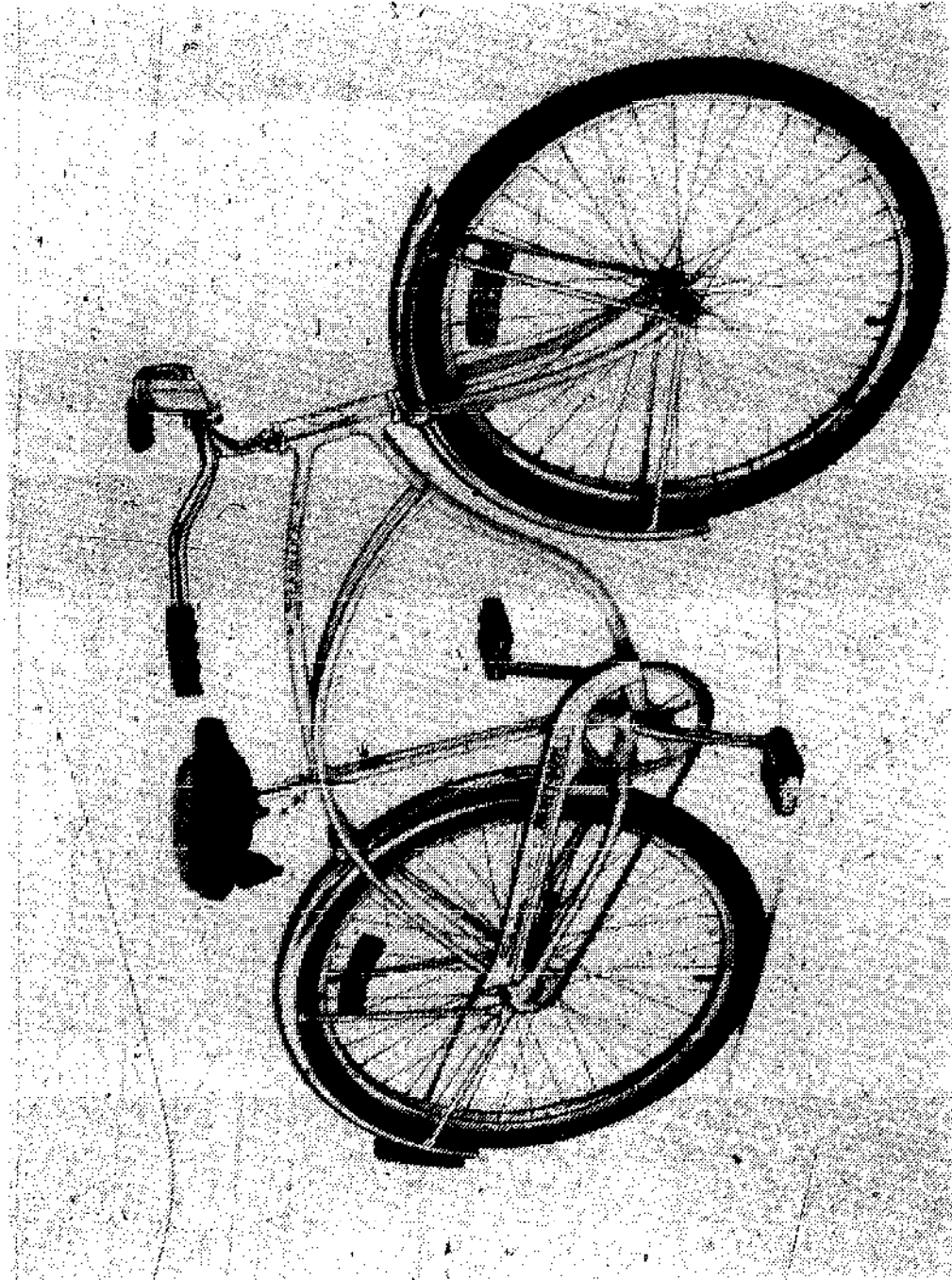

Fig. 2-4. The Schwinn Heavy-Duty bicycle is built strong, for use under heavy loads.

Fig. 2-5. Schwinn Speedster has 3-speed Sturmey-Archer gears and hand-operated caliper brakes.

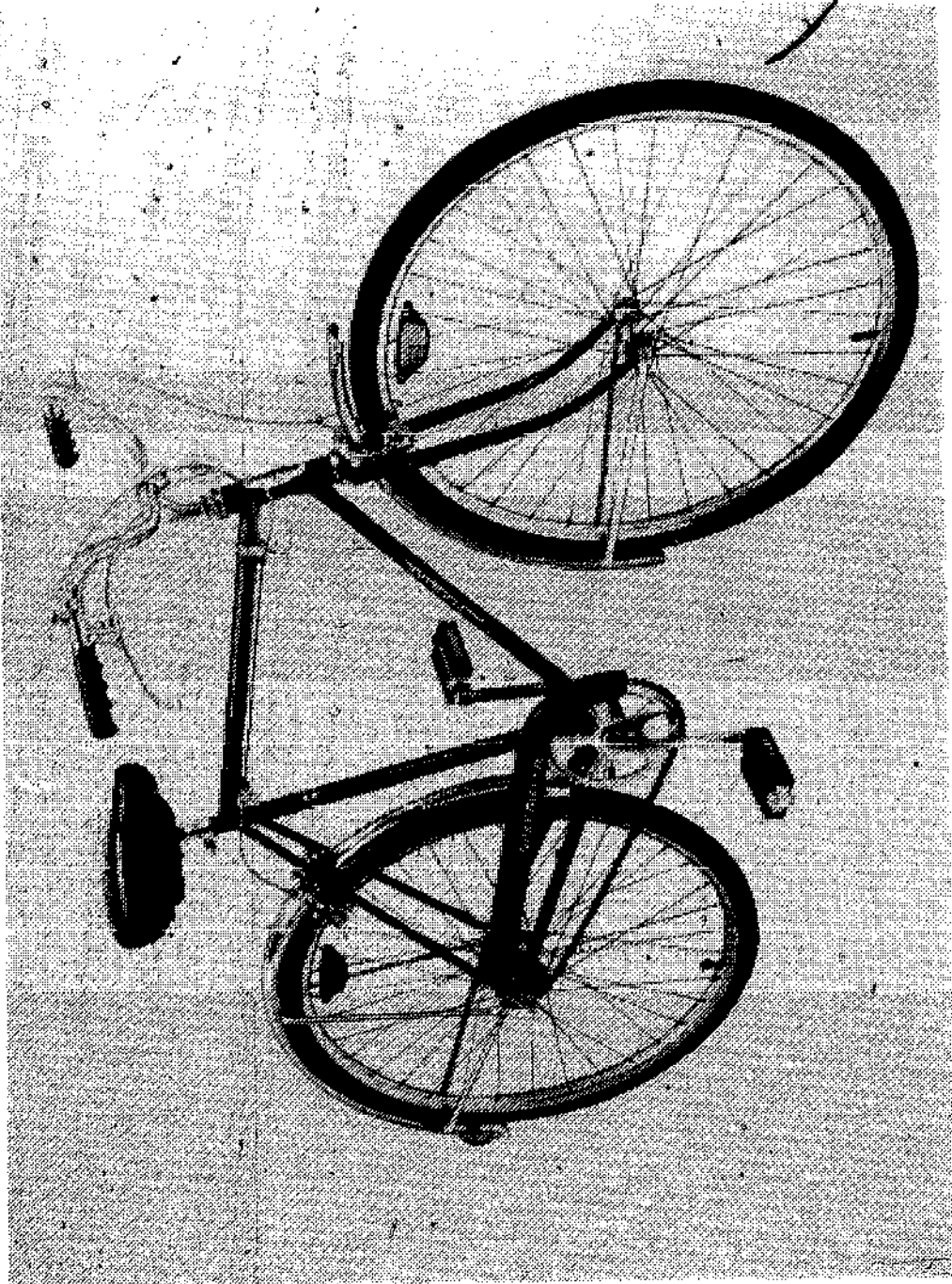
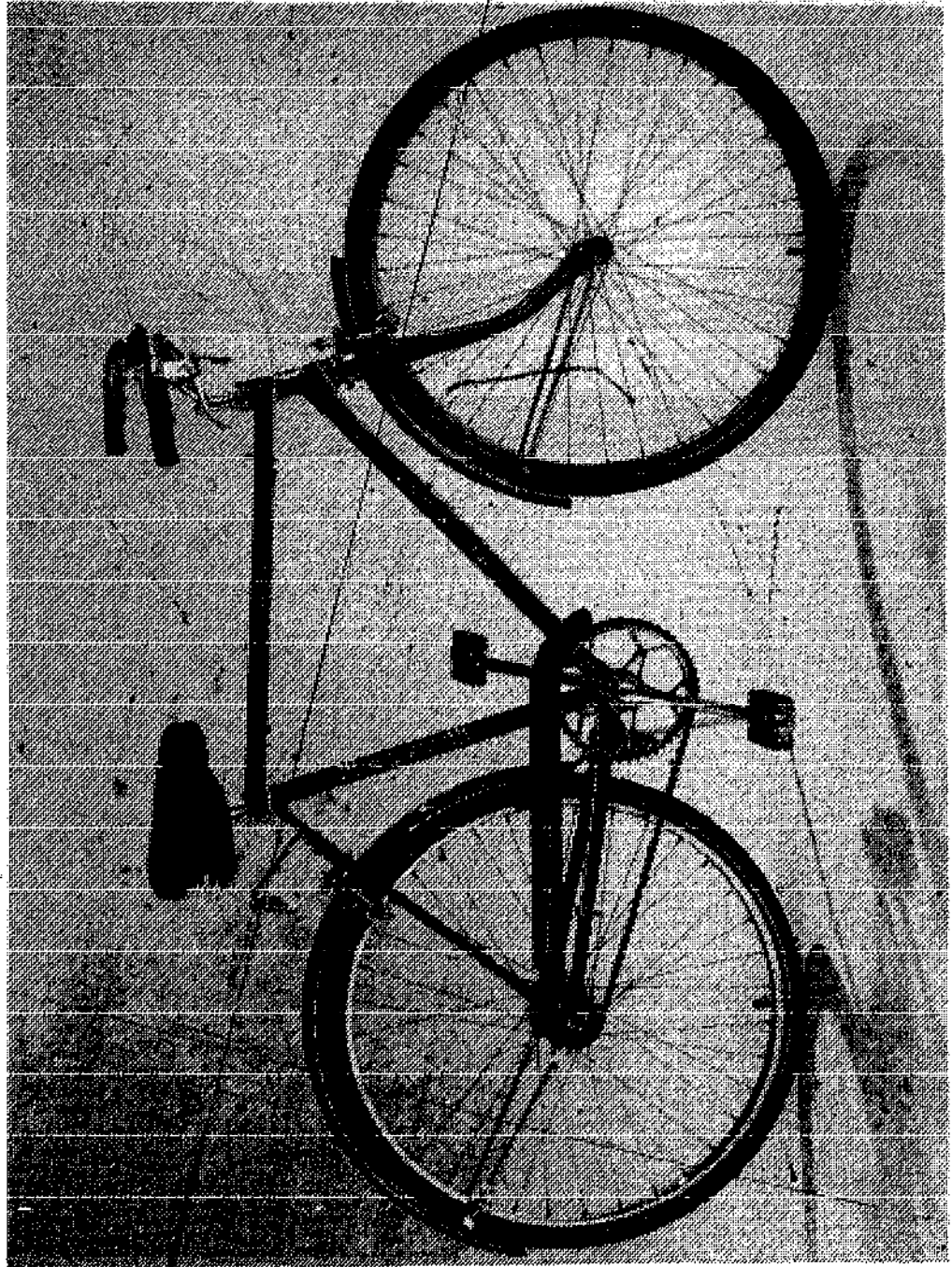

Fig. 2-6. Ross Eurotour 3-speed  
bicycle with internal hub gears



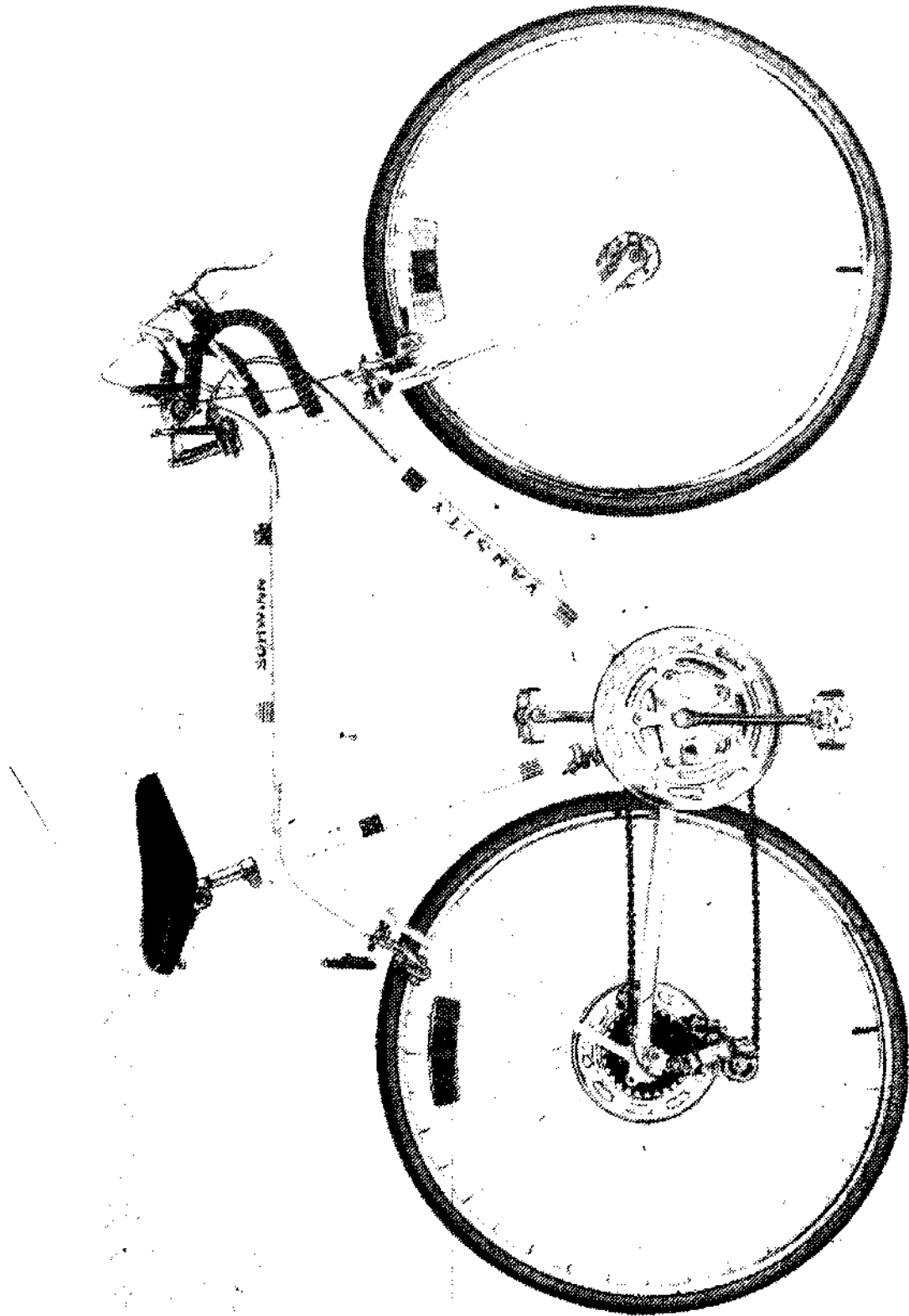
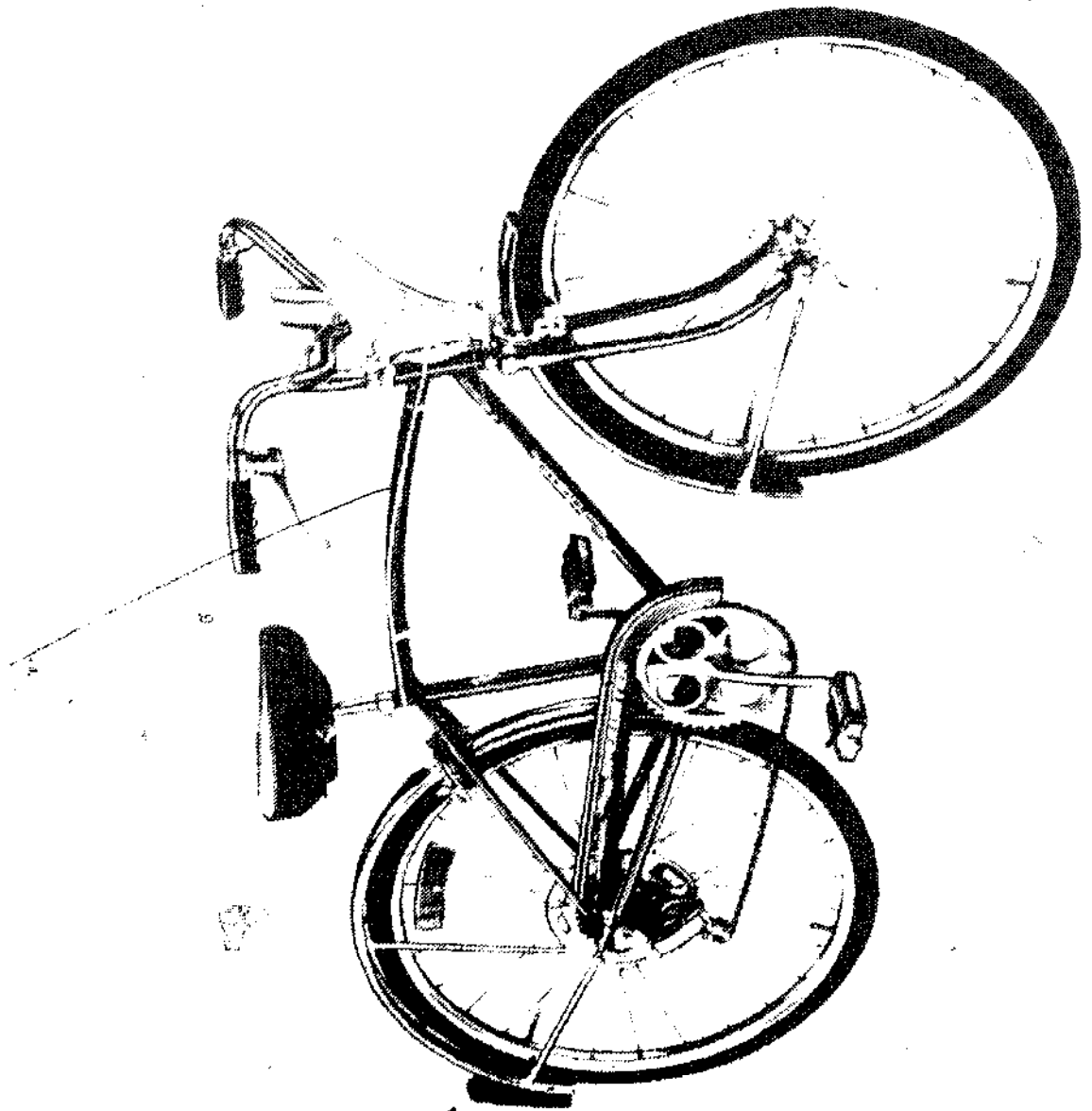

Fig 2-7 Schwinn Varsity Sport 10-speed bicycle

Fig 2-8 Schwinn Spread Springs  
for with 24 inch wheels



and 15—are also used, the 10-speed has become the general standard. The rear derailleur—as the shift mechanism at the rear sprockets are called—generally has five sprockets. The front derailleur has two, which results in a total of 10 possible gear combinations. With a single chainwheel at the crank, the set up, with five sprockets at the rear hub, (insert) it becomes a 15-speed. While the five cluster rear sprocket arrangement is the most common, other numbers are sometimes used.

Derailleur systems are generally both more difficult to operate and keep in adjustment than internal hub gears. However, derailleur systems are often easier to repair than internal hub gears. Many of the newer designs of derailleurs, even ones on inexpensive bikes, have been greatly improved over earlier versions. At least one design, which is detailed later in this chapter, approaches the ease of operation of hub gears.

As a general rule, I recommend the 10-speed for teenagers and adults who are reasonably fit and agile and who intend to ride fairly long distances—especially on an unlevel terrain.

## RIDING POSTURE

In selecting a bicycle, riding posture is an important consideration. “Pure” bicyclists are fond of pointing out that there’s only one type of saddle (narrow) and position (high) that’s proper for bicycling. Perhaps this is true for greatest efficiency, but it’s not necessarily the most comfortable. Many riders have neither the fitness nor desire to ride like this.

Some bicycles are designed to be ridden in a fairly erect position. These generally have wide, fairly low positioned saddles and flat or slightly upturned handlebars. These bicycles are sometimes considered to be beginner’s bikes, but I think they have important uses beyond this. I know a number of older people who do not consider bicycling but do not have the fitness or agility necessary for the so-called “racing” posture.

The second main type of bicycles have narrow touring or racing saddles and dropped (down-turned) handlebars, such as the arrangement shown on the bicycle in Fig. 2-9. This arrangement actually offers a variety of riding positions, from fairly upright to leaning far forward. This saddle and handlebar combination is recommended for those who have the necessary fitness and agility and intend to do considerable bicycling.

Wide saddles are seldom used with dropped handlebars. This arrangement isn’t very practical. However, narrow saddles are

Fig. 2-9. The Ross Gran Eurosport  
10-speed with dropped handlebars.

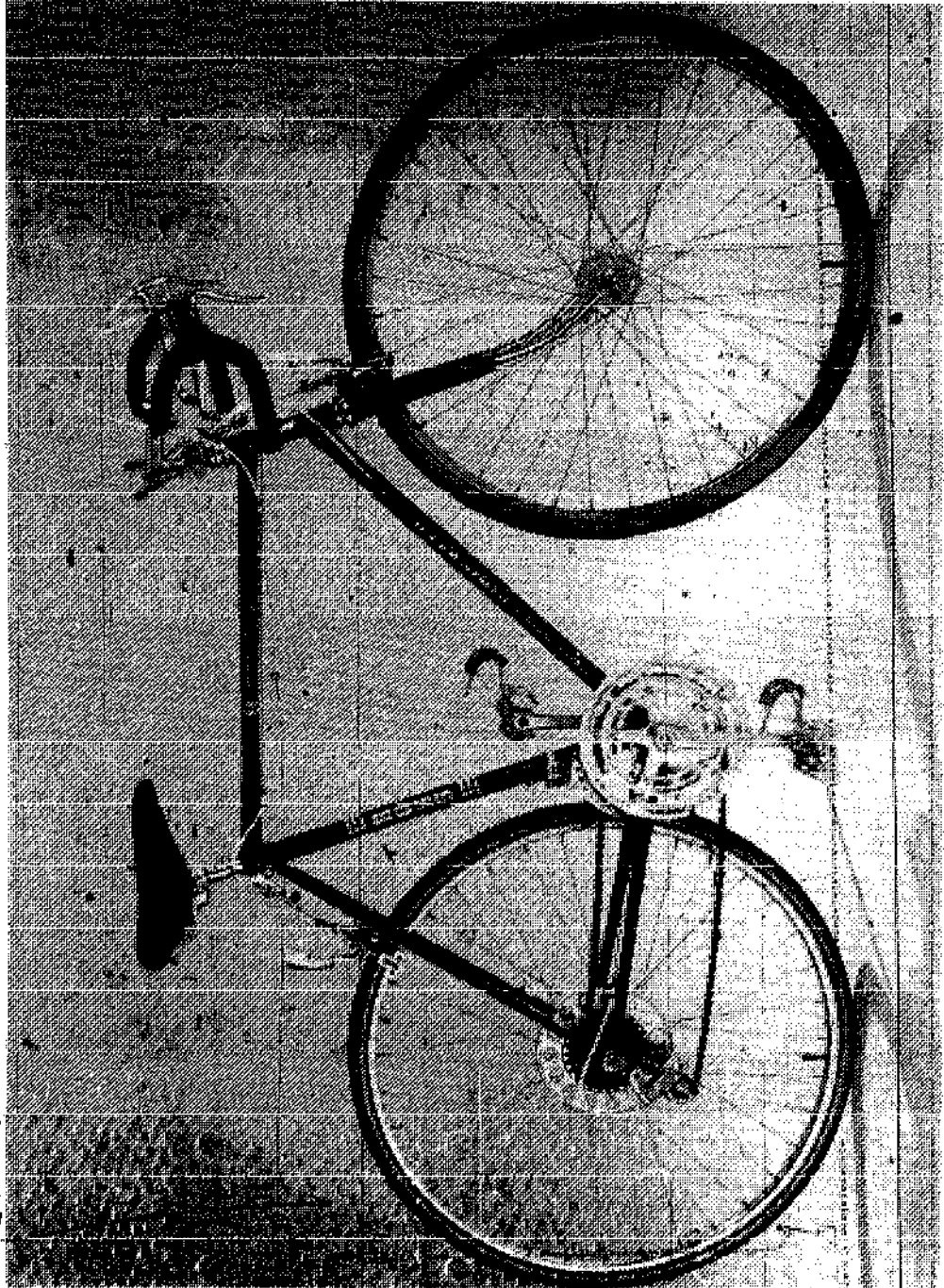

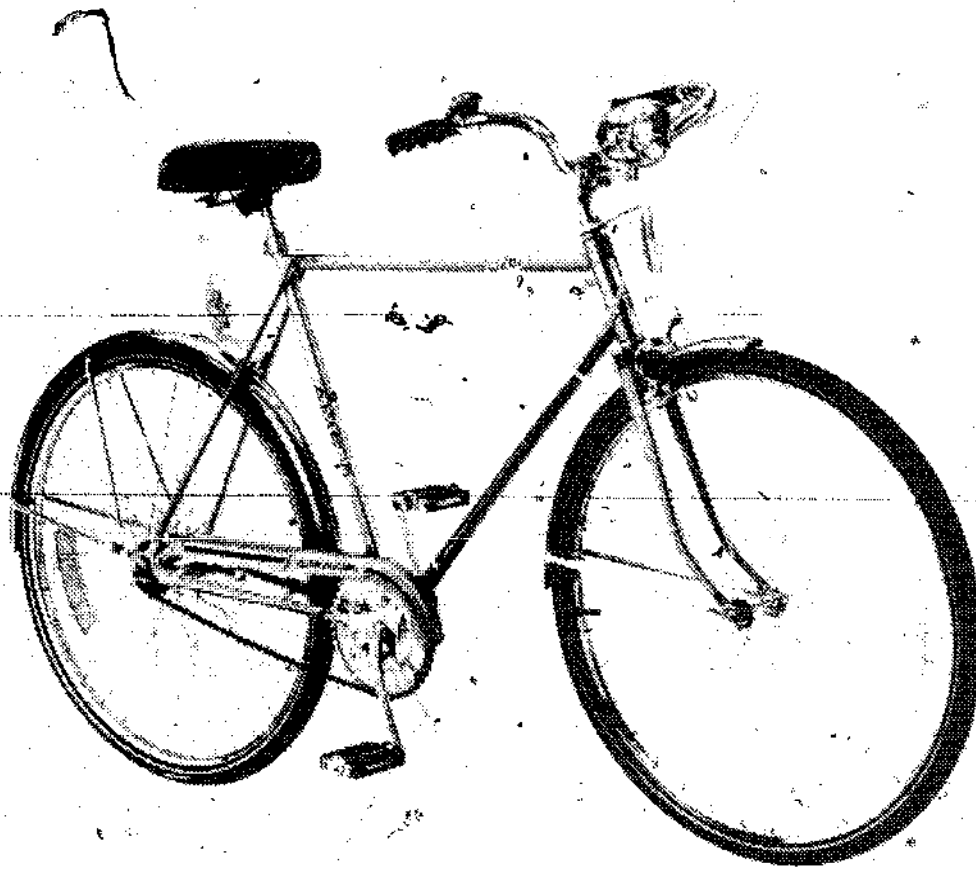

Fig. 2-10. The AMF Caravan 3-speed bicycle is ideal for those who want more than a utility bike but less than a long distance touring bicycle.

sometimes used advantageously with flat or slightly upturned handlebars.

### **INTENDED USE**

Using bicycles is covered in the next chapter. At this point, it's important to realize that bicycles are intended, by their design and construction, for various specific uses. Some bicycles are best suited for short rides and utility use. Others are designed specifically for touring or racing. There are subtle differences in each category. Fig. 2-2 shows a utility design which is ideal for short rides and, with suitable racks or baskets, is capable of carrying fairly heavy loads—such as for shopping or delivering newspapers. A bicycle that fills the gap between a utility bicycle and a long distance touring model is shown in Fig. 2-10. A touring bicycle is shown in Fig. 2-11. A quality road racing bicycle (Fig. 2-12) resembles a touring bike, but actually has many subtle differences. The *Track bicycle* (Fig. 2-13) is a very specialized machine. It is described in the next chapter.

### **PRICE AND QUALITY**

In general, a higher priced bicycle means higher quality. But there are many exceptions to this, especially in the case of lower



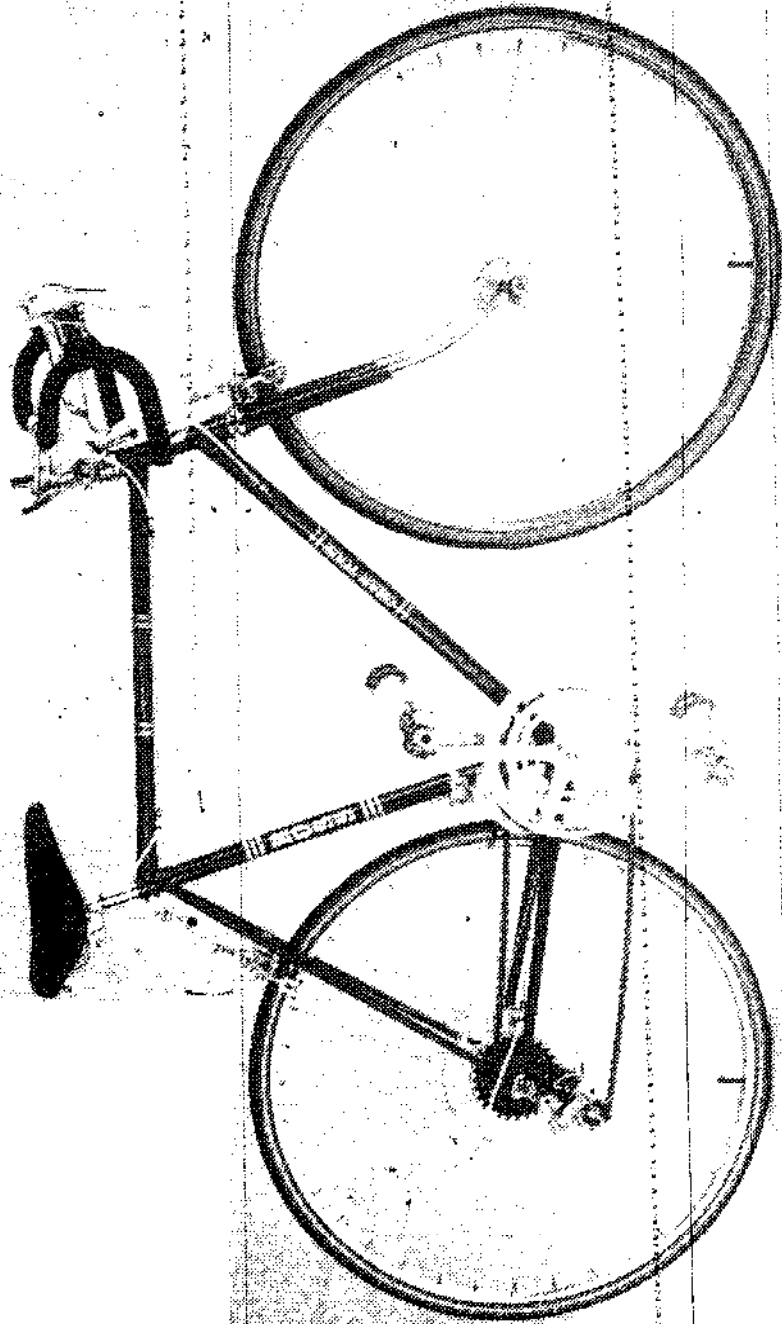

Fig 2-11. This 10-speed touring bicycle weighs 28 pounds.

priced models. While it's quite arbitrary, it may be helpful to consider bicycles that cost under \$150 as being low-priced, \$150 to \$230 as being medium-priced, and over \$230 as being high-priced. These price ranges roughly parallel distinct quality categories of bicycles.

## **COMPARISON OF BICYCLES**

To this point, my aim has been to get a general idea of differences in bicycles. I suggest that the novice study these points and then apply them when looking at bicycles at bicycle shops and bicycle shows. However, before you actually choose, it's important to go one long step further and be able to judge and compare frames and components that go to make up a specific bicycle.

### **FRAMES**

The frame, which for our purposes will also include the front fork, can be considered as the basic part or foundation of a bicycle. Without a good frame, regardless of the components used to make it a complete bicycle, it will always be less than satisfactory. On the other hand, start with a good frame and improvements are generally relatively easy. Better components can be added right away or at some later time.

The parts of a frame are shown in Fig. 2-1. Frame sizes and shapes vary. Custom frames can be fitted to the rider. Stock manufactured frames come in a number of sizes. Frame size is the distance in inches from the center of the crank hanger to the top of the seat post tube. Many brands have sizes ranging from about 19 inches to 25 inches. Eventually, these sizes will be in centimeters (metric system) in the United States. This is already the case in much of the world.

A range of from 19 inches to 25 inches will suit most teenagers and adults. Methods for fitting a bicycle to the rider are covered later in this chapter. Even when you consider bicycles designed for the same purposes, such as utility or touring, frame sizes and designs vary with the manufacturer. Oddball frame shapes have largely disappeared from the market and the tendency has been for even inexpensive bikes to follow the design shape of expensive models. However, a certain frame size, as defined above, can still vary considerably in other dimensions from a frame by another manufacturer with the same frame size.

One possible variable is to angle the head and seat tubes. These are called frame angles. Generally the angles of both the head and seat tubes on a bicycle frame are the same, that is, they are set

Fig. 2-12. Schwinn Paramount professional, road racing 10-speed bicycle.

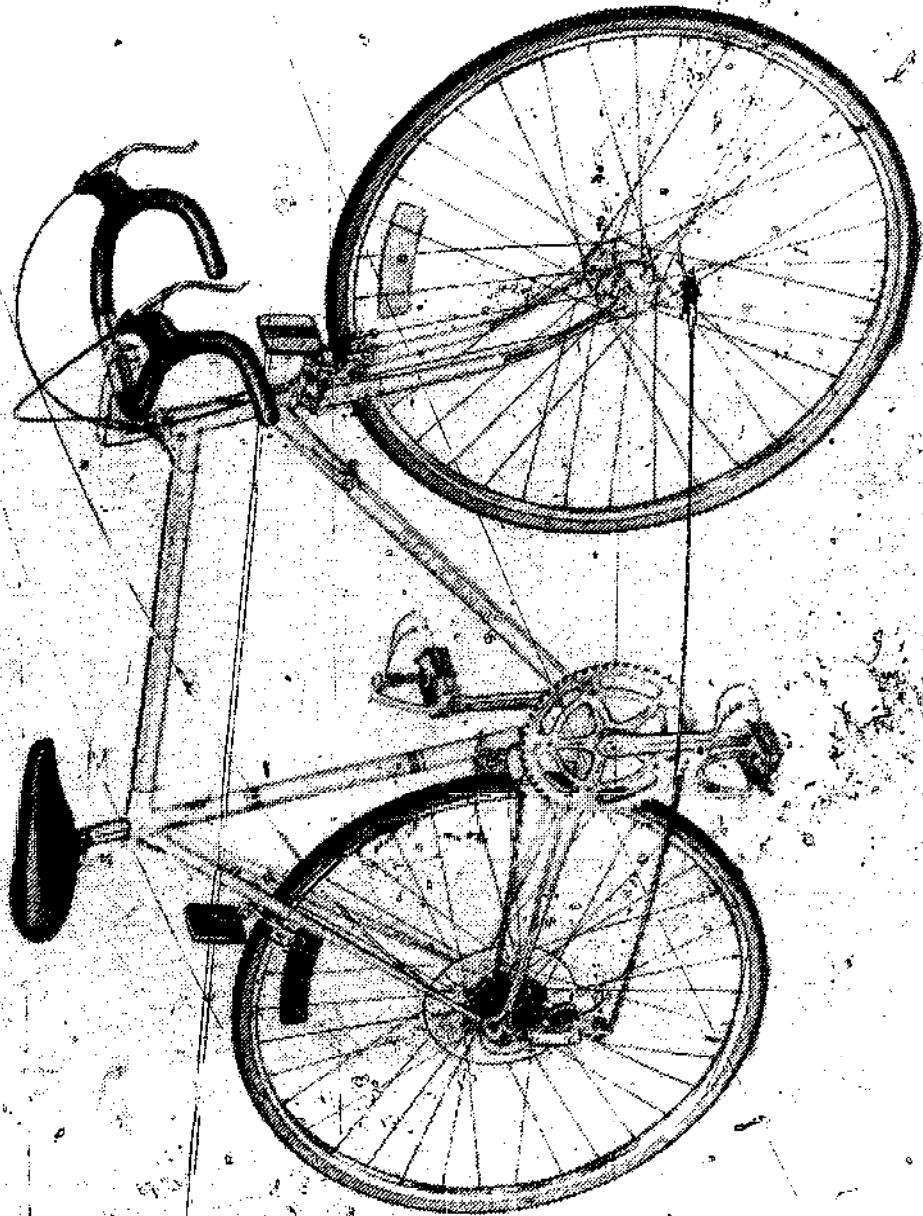

parallel to each other. On general purpose and touring bicycles, the frame angles are generally about 72 degrees. Racing bicycles sometimes have slightly greater angles, such as 73 or 74 degrees.

Another important variable is the reach, which is the distance from saddle to handlebars. Reach can be adjusted somewhat by using different length stems on handlebar posts. But this depends on having approximately the correct length top tube on the bicycle frame.

Still another variable is the size of the rear triangle. For general riding, touring and even more so for most types of racing, it's an advantage to have a short triangle so that the tire will be close to the seat tube. This gives a shorter wheel base and makes the frame more rigid. Many inexpensive bikes have large triangles. The longer chain and seat stays tend to make the frames less rigid and subject to greater whip. This is an undesirable characteristic.

Desirable characteristics for a frame are light weight and a certain amount of rigidity. An extremely flexible frame wastes energy, while an extremely rigid frame is less comfortable. Too much flexibility can also cause whipping. For general riding and touring, a happy medium is recommended. This will give both reasonable riding comfort and control.

Making frames lighter in weight, yet strong and rigid enough, is an extremely complicated design problem. Unlike some things, lighter weight costs more money in bicycle frames than heavier weight.

Bicycle frames are made up of a series of tubes. The tubes used on inexpensive bicycles are commonly of seamed steel tubing and made by wrapping a sheet of low-carbon steel into a tube and then electrically welding it where the edges meet. This forms a straight gauge tubing that is the same thickness the entire length.

Many writers of books on bicycling recommend that you forget about bicycle frames constructed of seamed low-carbon steel tubing. However, I don't go along with this. The low-carbon steel is what makes electric welding possible. The high heat caused by this inexpensive welding method would weaken a higher carbon steel. In turn, this is what makes inexpensive bicycles possible. These frames work well on bicycles used for certain purposes and the heavier weight required to make a strong enough frame can be offset by the lower price.

The next step upward, and certainly much better, is seamless high-carbon tensile steel. Since this tubing is stronger, thinner cross sections can be used to make a lighter frame.

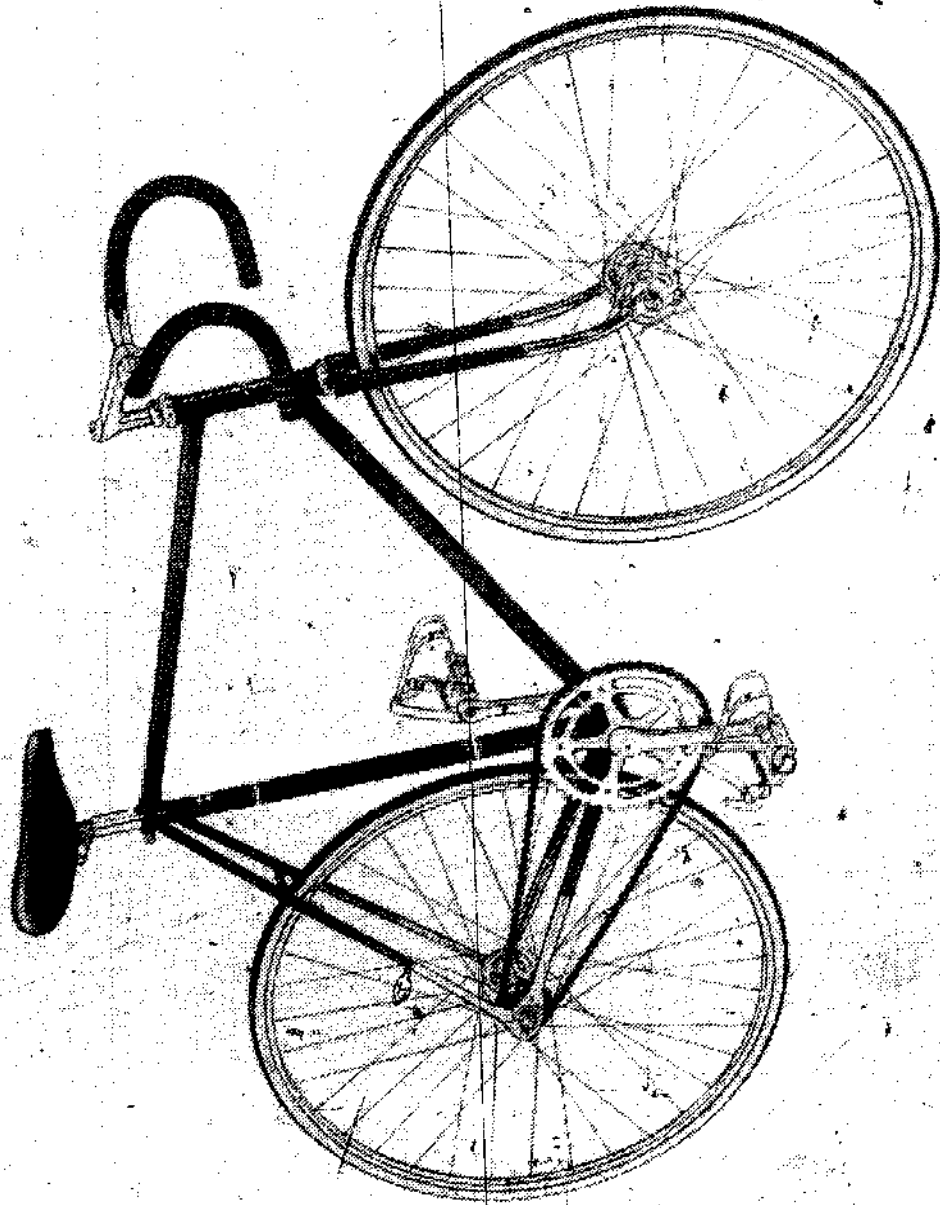

Fig. 2-13. Schwinn Paramount professional track racing bicycle.

The lowest cost frames of this material are straight gauge. A butted tube is more expensive and it is thicker gauge at one end. Double butted is the most expensive and has a thicker gauge at both ends and thinner gauge in the middle.

The butting process is actually quite old. It was invented in 1897 by Alfred Reynolds, an English nailmaker. Over the years, the practicality of the tubing has been well demonstrated. The advantage of using butted tubing for bicycle frames is that they are thicker on the ends where they join other tubes. That is the point where they are subjected to the greatest stress.

When you look at a frame from the outside, you can't see the different gauges of wall thickness. The outside of the tubing is the same diameter throughout. The added thickness goes inward. Actually, it's difficult to observe even if you cut up the frame. The wall thickness of a top tube, for example, might be .022 of an inch in the middle and .032 of an inch at the ends. This is a difference of only about one-hundredth of an inch. Although the difference might appear slight or even unnoticeable to the eye, it makes for a much better frame. How do you know if the tubing is butted? You just have to take the manufacturer's word for it.

The next step upward in frame material is chrome-molybdenum (chrome-moly) or manganese-molybdenum steel. This tubing, like high-carbon steel seamless tubing, is available in straight gauge and single and double butted construction.

*Reynolds 531* tubing is well known, but there are also many other top quality brands, including *Columbus*, *Falk*, *Super Vitus* and *Champion*. These will be indicated by a sticker which is usually placed on the seat tube. It will also tell you if the tubes are butted or double butted.

Sometimes chrome-molybdenum or manganese-molybdenum steel will be used only on the three main tubes and less expensive tubing used for the remainder of the frame. For example, the sticker might read *3 Chrome Molybdenum Main Tubes*, which also indicates, since it's not mentioned, that the tubing is straight gauge.

If a manufacturer goes to the expense and trouble of using these materials, you can be sure that it will be indicated by a sticker on the frame.

The steel tubing described above—seamed low-carbon, seamless high-carbon and chrome-molybdenum or manganese-molybdenum—must be joined together to form a frame. Low-carbon steel permits welding and makes inexpensive bicycles possible. The high-carbon and alloy steels are generally assembled by low-heat brazing, as the high heat of welding would greatly weaken

these types of steel. Not only that, but the weak point would be right at the joints. This is in the least desirable locations. Brazing uses a brass or silver metal alloy filler. It can be done at about 1600 degrees Fahrenheit or even lower. This allows the tubes to be joined without seriously reducing their strength. Even with brazing, there is some drop in tensile strength of the tubing. This is usually well within acceptable limits.

Frames are assembled with and without lugs. Frames without lugs are generally associated with inexpensive bikes, but in fact many top quality frames are also made without lugs. Also, there is a growing tendency for cheap, poorly constructed frames to use lugs in an attempt to look like more expensive units.

The purpose of lugs is to strengthen joints by adding metal and distributing the stress over a larger area. It's important, however, that the ends of the tubes be precision mitered. Lugs can and often are used to hide poorly fitted frame pieces. Lugs also perform a decorative feature of a sort. They often have decorative cutouts and shapes. On the other hand, a frame brazed together without lugs by a skilled craftsman can have an attractive appearance too.

In comparison to welding, brazing is an expensive operation and it is difficult to absorb this cost on inexpensive frames. One method of cutting down the cost is to use inexpensive brazing rod (filler) material. Unfortunately, this results in a poorer bond.

It is difficult for the novice—or for that matter, almost anyone—to accurately judge the quality of brazing on a finished bicycle. This is especially true when lugs are used. In general, the best assurance of a quality job is a reputable manufacturer.

Drop-outs, the plates with notches in them for the rear wheel axle, are another important part of the frame. The cheaper ones are stamped out. The better ones are forged into shape.

On inexpensive bicycles, the drop-outs are often installed by crimping them to the frame and then spot welding them. This is easily recognized by the break in the joints. This method has been widely criticized, but frames constructed in this manner will often pass quite stringent stress tests. In any case, in the lowest price range, there is little else available. More expensive frames generally have forged drop-outs (Fig. 2-14) that are brazed in place.

Forks are generally, though perhaps not technically, considered to be part of the frame. The stem is the part that passes through the head tube on the frames. The blades are the parts where the wheel attaches. The blades normally curve forward about two inches from a straight line. This is called *rake*. Rake helps

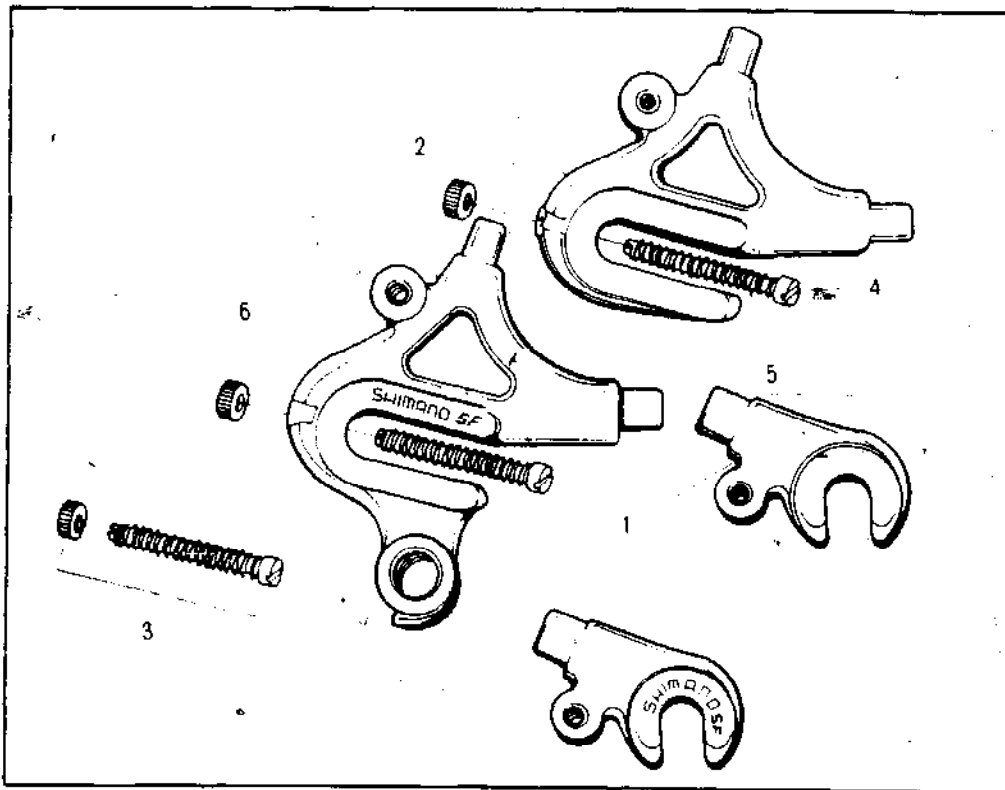

Fig. 2-14 Shimano Dura-Ace Model NB-100 drop-outs: (1) front fork end set, (2) rear fork end set with adjusting set, (3) adjusting bolt, nut and spring, (4) adjusting bolt, (5) adjusting spring and (6) adjusting nut.

the bicycle to track in a straight line and absorbs road shock. Less rake results in quicker turning but poorer tracking.

The least expensive forks have flattened ends with notches for the axle. Better forks have drop-outs or fork-ends brazed or welded to the fork blades. The cheapest of these are stamped. The best are forged into shape.

The drop-outs, or lack of them in the case of flattened and notched fork blades, can give a good indication of both the price and quality of a bicycle. However, all can be satisfactory. Also, after about the low end of the medium price range and up, almost all bicycles will have forged drop-outs brazed or welded in place.

What about bicycle frames designed for girls and women? The closed triangle shape is traditionally considered to be for the boys and men. This design makes for a stronger, more rigid bicycle. My first suggestion is that women use the men's style bicycle. The original reason for the design of women's bicycle frames without the top tube was for wearing skirts. Since many girls and women now prefer to wear other clothing for bicycling, this reason is no longer valid.

For girls and women who still prefer a bicycle without the top tube, these will be satisfactory up to a high level of performance.



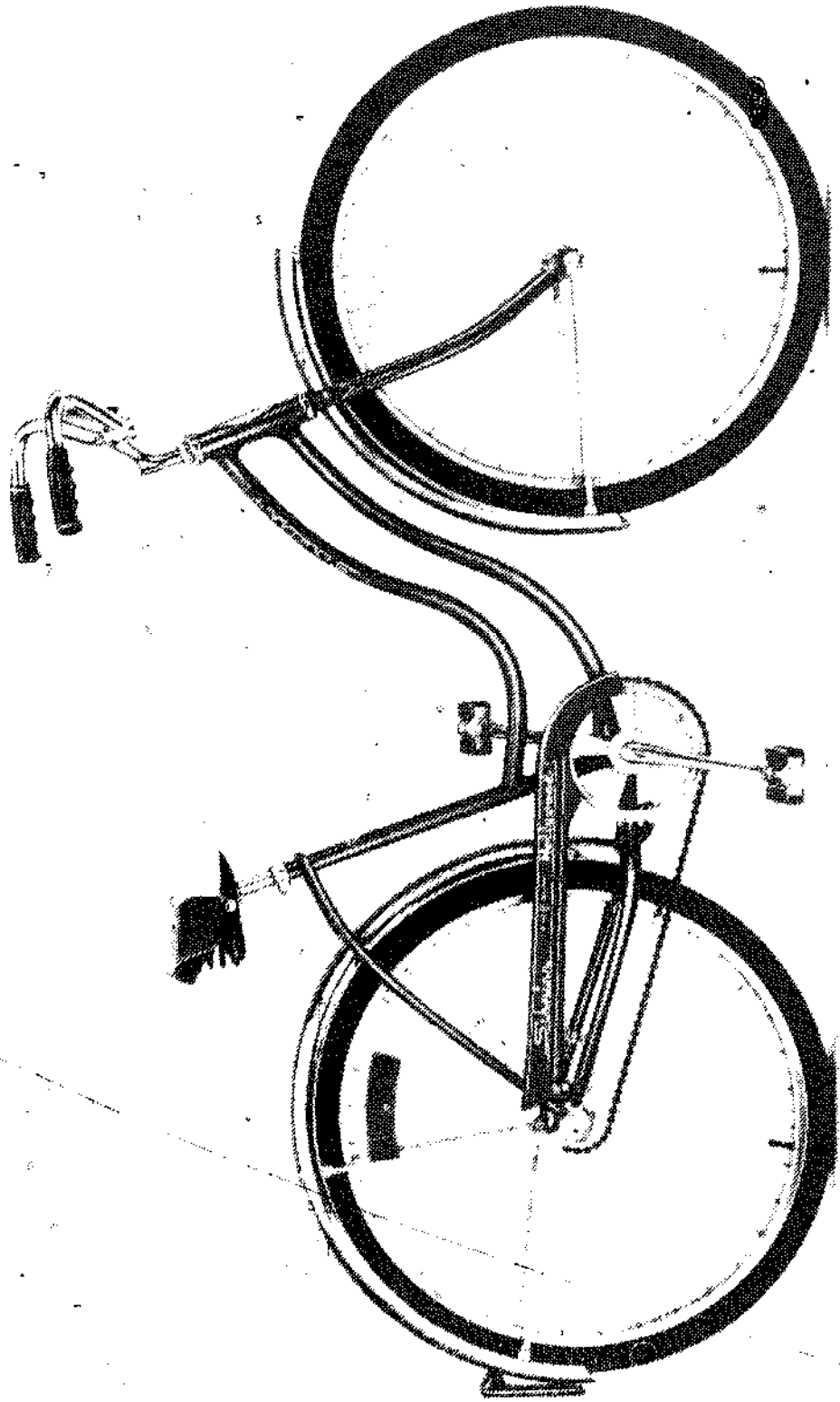

Fig. 2-15 This bicycle has a traditional women's style frame.

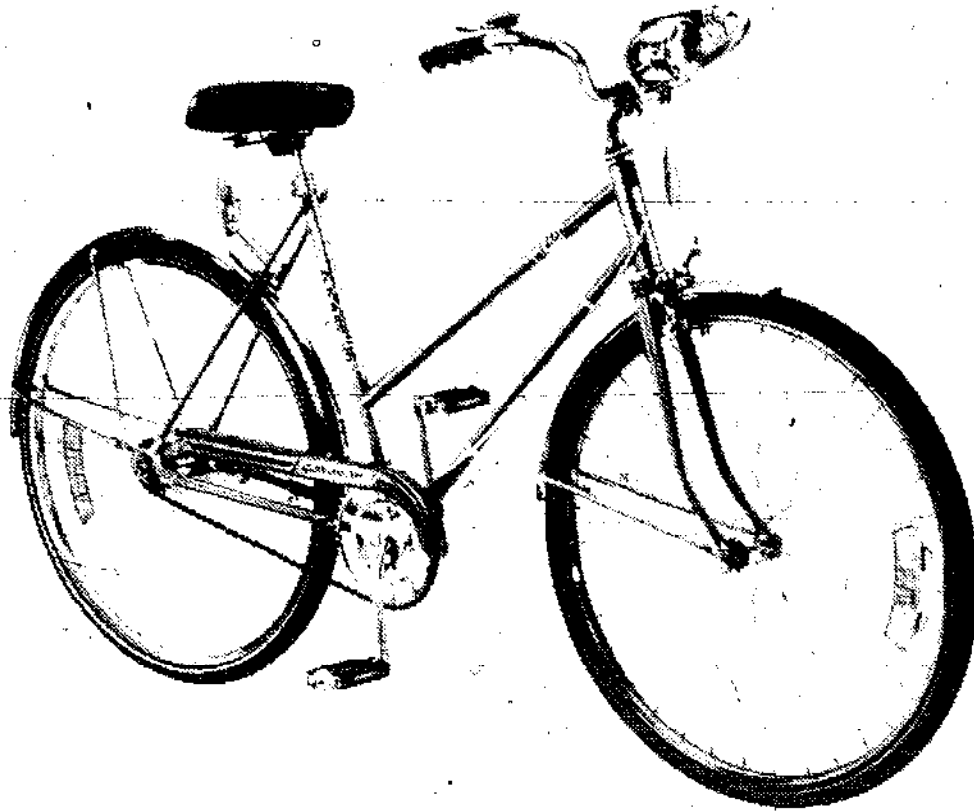

Fig 2-16 This three-speed bicycle with women's style frame down tubes widens between head and seat tubes.

Fig. 2-15 shows the traditional design with the two down tubes running parallel. For lighter weight bikes, a somewhat better arrangement is with the upper tube joining the seat tube at a higher position (Fig. 2-16). An even better arrangement is called the *mixte*. The bottom tube is the same as on a man's bike and two smaller tubes run in tandem from the top of the head to the drop-outs in the rear. While the latter will still tend to have more undesirable whip than a similar man's frame, this seems to be the best compromise.

**Stainless Steel Frame.** The Japanese firm, *Bridgestone Cycle Industry Co., Ltd.*, features one bicycle in their line with a die-cast stainless steel frame. The bicycle, called the *Submariner*, is available with a regular (Fig. 2-17) and ladies' style frame. The bicycles come in several frame sizes with total bicycle weight ranging from 29 to 31 pounds.

-It seems to me that these bicycles would make ideal take-along shore transportation for cruising boaters. This might seem a use that would be so rare that it wouldn't be worth mentioning. But not so. There are hundreds of boaters who take bicycles along on their boats. Having done this myself and seen-first hand what the salt air

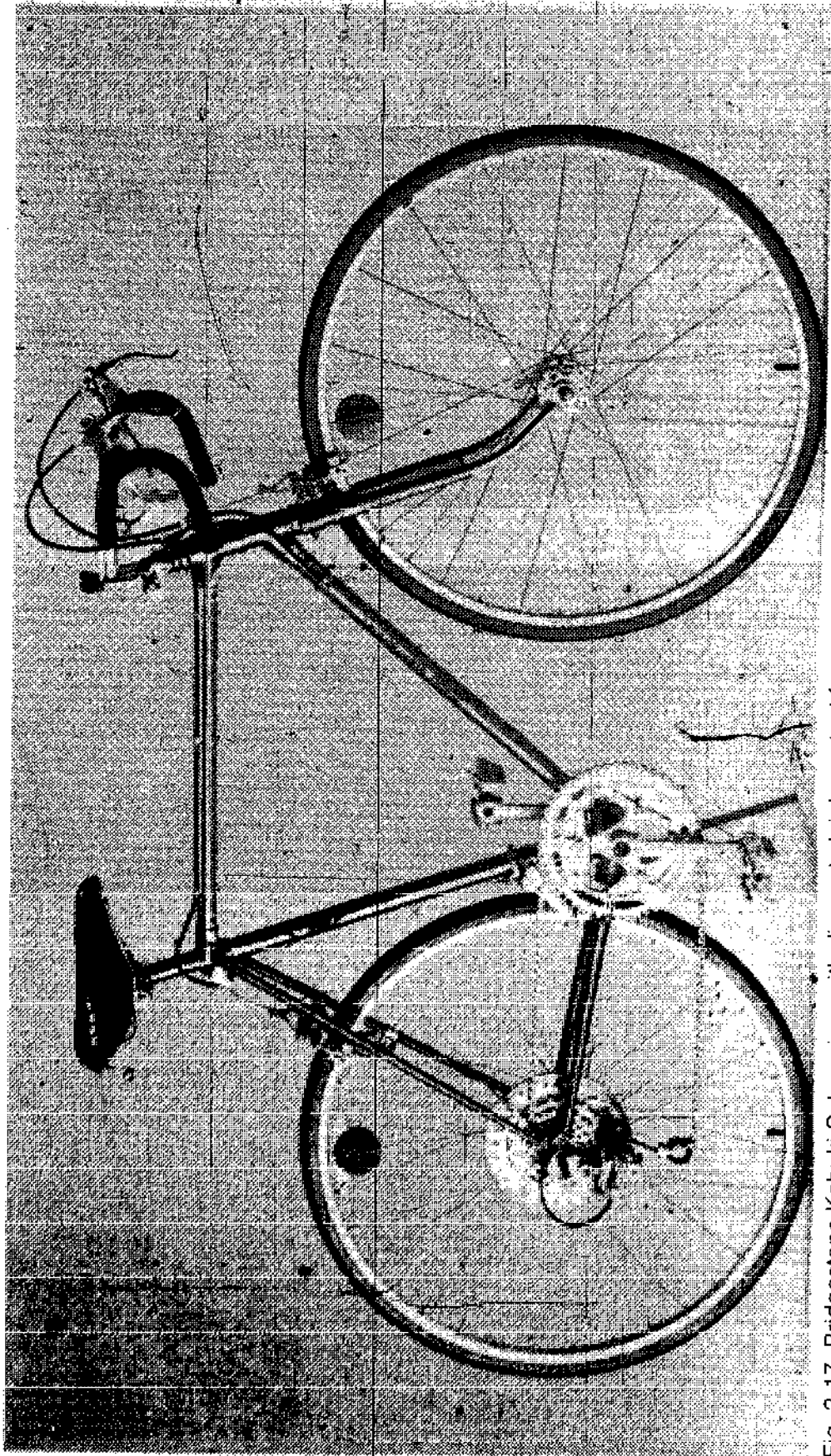

Fig. 2-17. Bridgestone Kabuki Submariner with die-cast stainless steel frame.

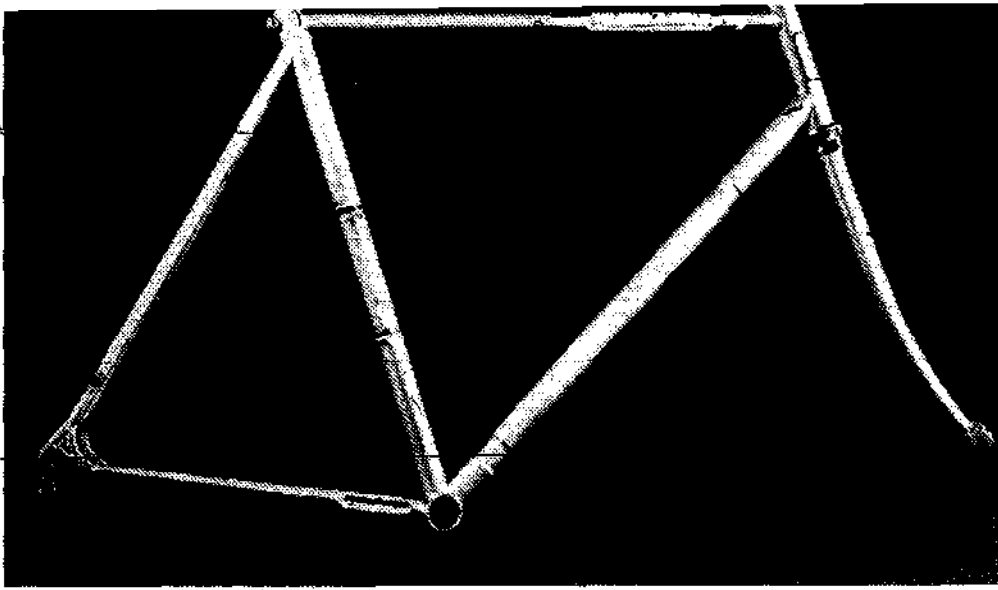

Fig. 2-18. A three and one-half pound Teledyne Titan bicycle frame.

environment will do to a regular steel bicycle, I can see the possibilities of the stainless steel frame. No more rusted wonders.

**Aluminum Frame.** The *Bridgestone Co.* also offers a lightweight aluminum die-cast frame in their line of bicycles. There is both a regular and women's frame style, each with a total bicycle weight of 28 pounds. This is only about average for a general purpose and touring 10-speed in the medium price range. The aluminum alloy used is a fairly heavy one.

Both the aluminum and the stainless steel frames are assembled with pressure-molded joints, a process patented in Japan and Europe. Both of these bicycles are for general purpose riding and touring—not for racing.

For racing, a frame must be very stiff in order to avoid wasting the rider's energy and of very light weight. A racing frame made from *Reynolds 531*, for example, weighs about five pounds or slightly less. This is the weight of the frame without the components that go to make it a complete bicycle.

There are frames made from several other materials that are challenging the chrome and manganese molybdenum steel ones. Aluminum alloy is one of them. Popular models are the Italian *Alan* frame, distributed in the United States by *Mel Pinto Imports, 2860 Annandale, Falls Church, Va 20042* and the *Klein* frame, *Klein Corp., 23 Elm Street, Cambridge, MA 02139*. The *Alan* frame weighs 3.5 pounds and is assembled by epoxy gluing aluminum tubes into oversized lugs. The price for the frame is about \$250. The *Klein* frame weighs 3.28 pounds and is assembled by a special

welding system. Boron fibers are used for reinforcement to increase rigidity. The price for the frame only is about \$360.

**Titanium Frame.** A 3.5 pound titanium frame (Fig. 2-18) is made by *Telodyne Linair, Bicycle Division, 651 W. Knox St., Gardena, CA 90248*. The price for a frame is about \$550. The *Speedwell Gear Case Co. Ltd.*, of England plans to introduce another titanium frame in the United States.

**Graphite Frame.** The *Exxon Co., Composite Materials Division, 242-A St. Nicholas Ave., South Plainfield, N.J. 07080*, makes a 4.4 pound frame of graphite fibers spun around a core of aluminum. The price of the frame alone is about \$825.

**Plastic Bikes.** A couple of years back the idea of 17.5 pound plastic bicycles that would sell for under \$100 made a big splash in magazine and newspaper articles. Well, it sounded like a good idea, but it must have run into problems, because the plastic bikes, as far as I've been able to determine, still aren't on the market. Also, these might not have been suitable for racing for a number of reasons, since light weight is only one of a number of design factors required.

**Frame Variables.** Frame variables include saddle tube length and angle, top tube length, frame height above ground, bracket height and wheel base—which is varied by length of stays and angle and rake of front fork.

## **FINISH**

Frames are usually painted. This is for both protection of the metal and appearance. Chrome plating is used on the ends of the fork blades on some bikes and in a few cases the entire frames are plated.

The quality of finishes varies greatly. When looking for a new bicycle, examine the finish carefully on the particular bicycle to make certain that there are no runs, chips or other indications of careless application of the finish or handling of the bicycle. This type of minor damage often occurs in shipping and assembly of bicycles. Some of this can be tolerated in an inexpensive bicycle, but a medium and high priced model should be closer to perfection.

## **COMPONENTS**

A bicycle is a frame plus its components. In general, better frames have better components—but there are exceptions to this. The brand name of the bicycle is generally supplied by the frame manufacturer, but most often the components for completing the bicycle are from other manufacturers. The components also have brands and these are often helpful in judging quality.

Bicycle components are frequently available in either steel or aluminum alloy. The advantage of aluminum alloy is that it is lighter than steel. The advantage of steel is that it is less expensive. Bicycle components are also being made out of titanium, but these are generally too expensive for ordinary uses.

## Hubs

There are two basic construction methods. Inexpensive hubs are stamped out of steel. More expensive ones are precision machined out of steel or aluminum alloy. In addition to being as light in weight as possible, the hubs should rotate with as little friction as possible. This depends on a number of factors, especially the precision of the bearings and their housings.

The flanges are the parts of the hub that the spokes pass through. Hubs are available with either high or low flanges. Longer spokes are used with low flanges. This gives better shock absorbing qualities than shorter spokes and makes them ideal for general riding and touring. High flanges use shorter spokes. This makes the wheel less springy and ideal for some types of racing.

Two basic methods used for connecting the axles to the bicycle frames are by means of nuts on the ends of the threaded portion of the axle and by quick release devices. On the latter, a quick-release skewer passes through a hollow axle. A lever locks both sides of the axle in the drop-outs.

Quick releases are generally associated with higher priced bicycles. Another method for removing a wheel without tools is to replace the axle nuts with wing nuts. Some manufactured bicycles come with these. The advantages of quick wheel removal without tools is sometimes offset by the fact that it makes stealing wheels easier.

The quick release hubs were originally designed for racing—where quick wheel changing is essential. However these devices are now found on many medium priced and most expensive touring bicycles.

Most hubs, except those with internal gear or coaster brakes, are packed with grease. A few use oil, including some expensive racing hubs. Two basic types of bearings, either caged (in a retainer) or loose are used. There was a time when inexpensive hubs generally had bearings in retainers and more expensive ones were loose. While this is still generally true, there is a trend toward expensive hubs using bearings in retainers too. Needless to say, this greatly simplifies overhauling hubs.

Permanently sealed bearings eliminate not only the need for periodic lubrication, but also the touchy problem of adjusting cones against the bearings. Several brands are now on the market. Once on the bike, they require no maintenance. A drawback is that a set of hubs—front and rear—runs about \$75. Manufacturers include *Phil Wood, PO Box 1729, Los Gatos, CA 95030, Welyess, Suite 3440, 230 Park Ave., New York, N.Y. 10017* and *Hi-E Engineering, 1247 School Lane, Nashville, TN 37217*.

Permanently sealed bearings are also being used on other parts of bicycles. My guess is that they will become less expensive and make the old style bicycle bearings largely obsolete. Even at present prices, I consider them to be well worth the price for use on medium and especially high priced bicycles.

Another variable on hubs is the number of spoke holes. These must match the number on the rim. The most common number of spoke holes is 36. For carrying heavy loads such as panniers with camping gear on a touring bike, a 40-spoke hub and wheel might be a better idea.

## Rims

Clincher tires and tubular tires are the two types of rims. Clincher tires have beads that are held in place on the rim by lips and tubular tires are glued to the rims.

Clincher rims are available in steel and more expensive—but lighter weight—aluminum alloy. Most tubular rims are of aluminum alloy. Some tubular rims are filled with wood or plastic inserts to reinforce the otherwise hollow area.

## Spokes

These are available in straight gauge and butted types. The butted ones are of larger diameter on the ends than in the middle. Unlike butted bicycle frames, you can see this feature on spokes.

Spokes are made from aluminum, steel and stainless steel. For general riding and touring, I prefer stainless steel spokes. They seem to retain a better appearance than the aluminum or regular steel ones.

When a hub is spoked or laced to a rim, various lace patterns can be used. Chapter Eight details how to recognize these patterns and lace wheels. A three cross pattern is typical for touring bicycles. Special spoking patterns that give stiffer wheels are frequently used on some types of racing bicycles.

## Tires

A problem in terminology arises in the case of tires. It is often said that you inflate or patch a tire, when what is usually meant is the inner tube that is inside the tire.

The two main types of tires in use on bicycles—besides the semi-pneumatic ones used on some children's cycles—are clinchers (or wired-ons) like the tires with inner tubes that are used on automobiles and tubulars (or sew-ups). Tubeless tires have been used on bicycles, but they are rarely seen today.

Clincher tires have wire beads at each edge of the casing where it goes over the rim. Tubulars are called sew-ups because the inner tubes are actually sewn inside the tire with a needle and thread. Repair requires considerable skill and patience. Tubulars are glued to the rim or attached with a sticky tape.

Clinchers are generally heavier than tubulars. This heavier weight is a disadvantage since the rolling resistance is greater. However, for utility and even most touring uses, there are a number of advantages. Clinchers are generally more puncture resistant, give better traction in wet conditions, have a longer useful life and allow easier repair of punctures. Clinchers generally have lower maximum inflation pressures than tubulars. Typical clinchers—it's the tire that determines the maximum pressure, not the inner tube—on narrow 26-inch or 27-inch wheels have a maximum pressure of 60 to 75 pounds. Models are now on the market that take up to 90 pounds or more. Higher pressures are an advantage in decreasing rolling resistance, but they make for a bumpy ride on a bicycle with a stiff frame. However, you can use the tires with a lower pressure. While most clincher tires cannot be folded for easy carrying of a spare when touring, the *Corsa Strada*, can be folded. It's made in Italy, and distributed in the United States by *Raleigh* dealers. It weighs about 17 ounces with an inner tube that is fairly lightweight.

Balloon tires, with one and one-half inch cross section or more, have more rolling resistance than a narrower tire such as those used on lightweight bicycles.

Tubulars have a number of advantages over clinchers. They are lighter. Racing models weigh about seven and one-half ounces with inner tubes and touring models about 12 ounces with inner tubes. However, for most touring, a heavier tire would probably be more serviceable. Tubulars generally have higher maximum pressures than clinchers. Some used for track racing use 140 pounds or more. However, 100 pounds is a more typical figure for the touring



type. Tubulars have less tread on the ground than clinchers. They give less rolling resistance, but also less traction.

Disadvantages of tubulars, as compared to clinchers, are that they are more easily worn out and punctured and that they are more time consuming to repair. However, several spares with the inner tubes already sewn in place will fit under the saddle.

In general, tubulars are more expensive than clinchers, although there is some overlapping in prices between the more expensive clinchers and less expensive tubulars.

It should be noted that tubulars usually come with a European-type valve called the *Presta valve*. To inflate with a service station air supply or a common hand pump, a special adapter is required. These are inexpensive and readily available at bike shops. Or you can buy the type of bicycle pump that will fit the *Presta* valve.

Clinchers use a different type of rim than tubulars, so the tires aren't interchangeable. Generally, inexpensive bicycles and medium priced ones up to the high end of the price range will have clinchers. These are probably more suitable for these bicycles anyway. To switch over to tubulars would involve facing a different type rim to the hub. This is a fairly costly and involved operation.

Some bikes in the upper-medium price range have tubulars and they are quite common on expensive bicycles. I feel that it is best for the novice to start out with clinchers. It seems to me that tubulars are only worth the extra trouble if you have a real need for the extra performance while racing and for long distance touring.

Flat tires are probably the biggest single problem faced by bicycle riders. While the particular tire will have varying degrees of puncture resistance, many attempts have been made to go beyond this. One method is to add a liquid sealant to the inside of the inner tube. These are readily available at bicycle shops. One popular brand is *Grand Rally*. It is distributed in the United States by *Paris Sport, Inc., 184 Main St., Ridgefield Park, NJ 07660*.

Another method that has been tried is to fill the inner tubes with materials that trap air into tiny pockets. There has been some success with this, however, present methods add considerable weight to the tires. This is very undesirable from a performance standpoint.

A third method is latex inner tubes. These are so elastic that it is difficult for even a sharp object to penetrate them. Several brands are now on the market and others are almost sure to follow. This method has the advantage that no extra weight is added to the wheel.

In each case it's important to decide if the additional puncture resistance is worth the additional cost for the particular type of bicycling you intend to do.

## **Wheels**

Bicycle wheels are the sum of the hub, spokes, rim, tire, inner tube and rim liners. A lightweight, narrow, high pressure wheel is a tremendous advantage in overcoming rolling resistance. Larger wheels, up to about 27 inches or 28 inches in diameter, are also an advantage. In general, if the size of the rider will permit it, select a bicycle with a 26-inch or 27-inch wheel size. For younger riders too small for bikes with these wheel sizes, select the one with the largest wheels that they can be comfortably ride.

Wheels on new bicycles have varying degrees of trueness. Methods for accurately gauging the trueness of wheels are detailed in a later chapter. For a rough check in a bicycle showroom, spin the wheel and use the caliper brake pads or the eraser end of a pencil as a guide to check trueness. In this manner, any serious deviations can be noted. The dealer should either make the necessary correction or you can reject the bicycle. Spoke plucking, like kicking a tire on a used car, generally has little or no value.

## **Saddles and Saddle Posts**

Type, shape, quality, and price are all considerations here. A comfortable saddle—also call a *seat*—can make a considerable difference in the enjoyment of cycling.

The basic choices are wide, narrow, racing or padded saddles. Padded saddles are sometimes called mattress saddles and some even have coil springs. In actual practice, however, there is more of a continuum from one extreme to the other than distinct types.

The least expensive saddles typically have a metal base, some padding, and a thin plastic cover—or with the padding as part of a molded rubber or plastic cover. A slightly more expensive type is with a contour shaped base of flexible nylon or plastic covered with leather or plastic materials. Depending on design and construction, these are available from fairly inexpensive to very expensive models. These have, to a considerable extent, replaced the old standard leather racing and touring saddles. However, the leather ones, including hand worked ones, are still around. There are a few people around who still think these are the best. Leather saddles generally have to be broken in. This means some uncomfortable riding until either the saddle changes shape or the rider adjusts to the shape of the saddle. My one experience with a leather saddle over a period of

a couple of years of use was that neither of these things ever happened. It still seemed as uncomfortable after two years as it did at the beginning.

A new innovation, simply called *The Seat*, was developed and is manufactured by *The Jacobs Corp.*, 6681 Araphoe Avenue, Boulder, CO 80303. I recently switched to one of these on my bicycle and I think it is the answer.

Bob Shaver, Director of Product Development at the *Jacobs Corp.*, supplied the following information:

"*The Seat* was developed to solve the problem that arises when the body meets a nonconforming material and has to stay in contact with this hard material for a long period of time. The basic idea was arrived at through our experience with the ski boot industry.

With the advent of plastic ski boots utilizing hard shells, a severe problem developed in adapting the bones of the feet to the unchanging material of the shell. During the course of a day's skiing pain and bruises would develop. This problem was solved in the ski industry by using some new foam materials of the slow memory variety. The flow-type materials provide a movable contact between the plastic and the foot.

*The Seat* was developed in the same manner, utilizing the exact materials that revolutionized the ski-boot industry.

At the outset, the assumption was that we knew nothing about prior design of bicycle saddles. This precluded ideas that would hinder development by preventing an open minded approach. In this manner, the shape of the saddle was redone in order to coincide with the pressure areas of the body. These pressure areas are mainly the pelvic bone areas and the perineum, which is between the pelvic bones and the genital area. At first, flow-type materials were used with various types of pad configurations that held the flow material to the molded body of the saddle.

After about 18 months of use, new *slow memory* foams were used in place of the flow material as they provided the same advantages of the flow material with none of the disadvantages. A removable concept was utilized with the frame that also incorporated a tension adjustment on the front of the saddle. This is the first time both these concepts were used in plastic saddles.

A new saddle is being developed that is more adaptable to the female anatomy. To our knowledge, this will be the first high performance, lightweight female saddle available."

*The Seat* is presently available in two models, a road or touring saddle (Fig. 2-19) and a track seat (Fig. 2-20). I feel that *The Seat* is



Fig. 2-19. Road model saddle called "The Seat." It's made by the Jacobs Corporation.

a real boom to bicycling. The one I installed on my bicycle was comfortable right from the start, with no breaking-in period.

It's important that the angle of the saddle be adjustable. This might be part of the saddle post or saddle attachment bracket. Some of the better saddle posts feature continuous micro-adjustment capabilities. Less expensive ones, but still satisfactory for most purposes, can be positioned only in notches and not between. The difference is very subtle. While it might make the fraction of a second difference in winning or losing a race, it probably would not be worth the cost for ordinary riding. More expensive saddles generally have a means of adjusting the tension which will make the saddle stiffer or more flexible.

Consider quality carefully. Some saddles will—especially those with thin covering materials—wear quickly. On some saddles, molded plastic or rubber covers can be replaced when they wear out. Other saddles cannot be covered so easily and will usually have to be replaced completely. Good quality leather saddles are becoming hard to find, but some will last for years. Inexpensive leather saddles generally have short lifespans.

Important factors to keep in mind when selecting a saddle are:

—Suitability for your needs, especially for comfort and riding efficiency.

- Quality especially as it pertains to expected life span.
- Price, which must be weighed carefully against the other factors.

When you are selecting a bicycle, many dealers will make saddle switches in order to make a sale. This can often be used as leverage in getting exactly what you want.

Inexpensive saddle posts are often made of steel. Lighter and more expensive ones are aluminum alloy. Make certain that it is long enough so that several inches will extend down into the seat tube at the highest adjustment that will be used.

## Handlebars

These are available in a variety of configurations. The three basic types are flat, raised and dropped. The flat and raised handlebars allow riding in an upright position. This allows for better vision when riding in traffic. Also, riders with low fitness and agility levels often find that these handlebars are suited to their needs. Within the flat and raised types are many variations. Models that extend upward a considerable distance, called high-rise handlebars, are popular on children's cycles.

To the novice eye, dropped handlebars might all look alike, but there are actually many popular configurations. The choice depends both on individual preference and intended use of the bicycle. Some offer more hand positions than others. Those that allow the most are generally recommended for general riding and most types of touring.

Handlebars are made from both steel and aluminum alloy. Most flat and raised handlebars are steel. The dropped type are available



Fig. 2-20. Track model of The Seat. The road and the track model of The Seat are designed to coincide with the pressure areas of the body.

in both steel and alloy. In the general line of bikes, the alloy is typically found only on the more expensive models. They usually start around the middle of the medium-price range. Steel is stronger and for this reason there are expensive steel ones for track bikes that can take tremendous forces.

### **Handlebar Posts**

These are also called stems and goosenecks. They attach inside the fork tube or stem that passes through the head tube of the bicycle frame—by an expansion device. The cheaper types have one side expansion and a regular protruding bolt head. More expensive ones have double expansion and either a regular protruding bolt head or an *Allen* nut. The *Allen* nut presents a neater appearance. Many bicycle mechanics prefer the bolt head because it is easier to secure.

Handlebar posts are available in steel and aluminum alloy. The latter is lighter but more expensive.

The handlebar post has a bearing on both the height and distance forward of the handlebars. The height can generally be adjusted within a certain range. It is important to have at least one and one-half-inch down inside the fork tube. Forward/backward adjustments usually require switching to another handlebar post with a different length neck. However, there are also a few handlebar posts that allow adjustment of the forward/backward distance.

### **Grips**

Rubber or plastic grips are generally used on flat and raised handlebars. In addition to a better appearance, these provide for a better grip, help absorb road shock and provide protection from injury by covering the ends of the handlebars.

### **Taping**

This is generally used in place of grips on dropped handlebars. With some exceptions, plastic tape is the standard for inexpensive bikes and cloth for medium priced and expensive ones. However, this cannot be used as a guide for judging the quality of bicycles.

Padded tape is also available. This will help to absorb road shock. Cycling gloves can be used. For short trips and utility riding, I recommend the padded tape.

The ends of the bars should always be plugged. This is not only for holding the ends of the tape in place, but also for safety.

### **Head Sets**

The headset is the bearings, cups, cones, and other parts that allow the fork to turn in the head tube of the frame. When inspecting

a bicycle, check to make sure that the fork turns freely and smoothly. Since the parts that count are inside where you can't see them without disassembling the headset, it's usually necessary to assume that they are of a quality that is in keeping with the rest of the bicycle. Headsets are generally a fairly trouble-free part of a bicycle.

## Brakes

Coaster brakes operate by back pedaling. They are commonly used on single-speed bikes and sometimes on hub-gear models. These vary in price and quality, but most will give good service.

Caliper brakes are often used on hub-gear bikes and on the majority of derailleur-gear bicycles. These are operated by hand levers which press rubber pads against the sides of the rim. The two main types in use are side-pull and center-pull. The side-pull type—because poorly designed and constructed models are often used on cheap bicycles—are commonly thought to be inferior. But this is not always true. Some of the finest and most expensive brakes made, such as the *Campagnolo and Zeus* brands, are side-pull (Fig. 2-21). In the case of most caliper brakes used on inexpensive and medium priced bicycles, however, center-pull models generally seem more satisfactory.

Both center-pull and side-pull types have two arms that rotate in opposite direction to form a clamp. This clamp is the rubber pads that fit against the rim. The pivot on side-pulls is at one point at the

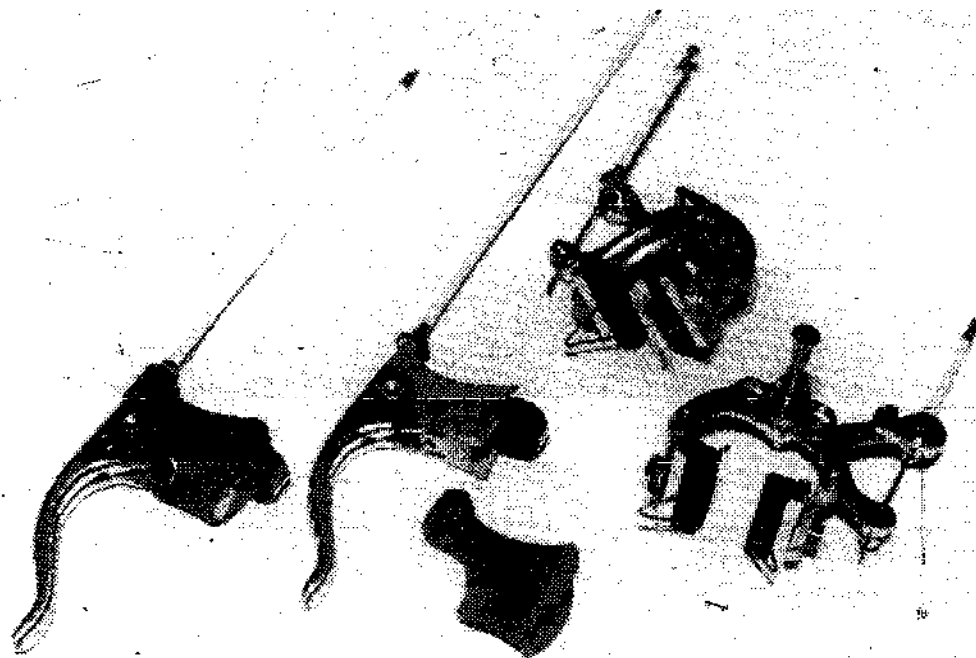

Fig. 2-21. Zeus high quality side-pull caliper brakes.

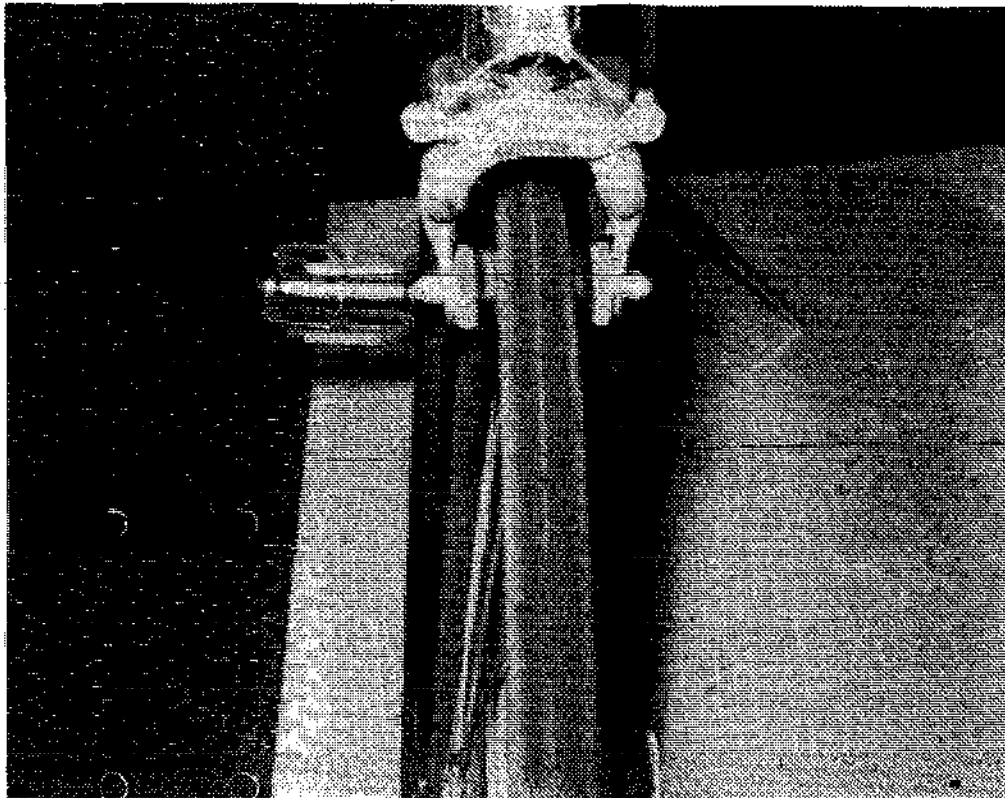

Fig. 2-22. Center-pull caliper brakes.

side. Center-pulls have a separate pivot point for each arm. They have a transverse crossover cable with a sliding device to which a single wire connects and goes to the control levers. This arrangement is shown in Fig. 2-22.

Some caliper brakes have quick release levers that make wheel removal easier. Another feature to look for is a cable adjuster to take up slack in cables.

When checking caliper brakes on a particular bicycle, make sure that they spring back quickly when the hand lever is released. Weak spring action is a common problem with caliper brakes—especially with low cost models.

In practice, caliper brakes tend to work poorly in wet weather and on downhill runs. For this reason and others, disc brakes are growing in popularity. Many stock bicycles now come with these. Some of these are not affected when they get wet and the cooling is better than on brake pads when used on long downhill "brake rides." Disadvantages of disc brakes are they tend to be heavy, somewhat complicated and expensive.

Drum brakes are another possibility. However, while they are available, these do not seem popular on regular bicycles. Their primary use seems to be when extra heavy duty braking is required—such as on tandem bicycles.



## Pedals

The least expensive pedals cannot be dismantled for lubrication or overhaul. These are available with metal bases and rubber foot pads and of all-metal construction. These pedals are generally found only on the least expensive manufactured bicycles. They generally lack precision and are subject to frequent breakdown. The advantage is the low cost.

Pedals with metal bases and rubber foot pads that can be disassembled for repair and lubrication are usually of better quality. They are popular for use on utility bicycles. The rubber foot pads can be an advantage over all metal pedals for riding with thin soled shoes and barefooted. The latter practice places the feet in a position vulnerable to injury and should be discouraged.

Toe clips and straps will not ordinarily attach to the rubber pedals. However, there are a few pedals of this type that come with clips, straps or both. The use, advantages and disadvantages of clips and straps are detailed in the next chapter.

Metal pedals are called *ratttraps* (Fig. 2-23) and can be used with or without toe clips or straps. A few bicycles in the low priced range come with toe clips and straps. Most often these are not seen on bicycles below the medium price range. Provided the pedals are of a suitable type, they are an inexpensive and easy to install accessory. Consider carefully your need for them. They provide greater pedaling efficiency, but tend to mar street shoes. You might feel less confident, especially in heavy traffic, as it is necessary to release the feet in order to put them on the ground. It is a skill that can be done quickly once mastered, but it takes practice to develop.

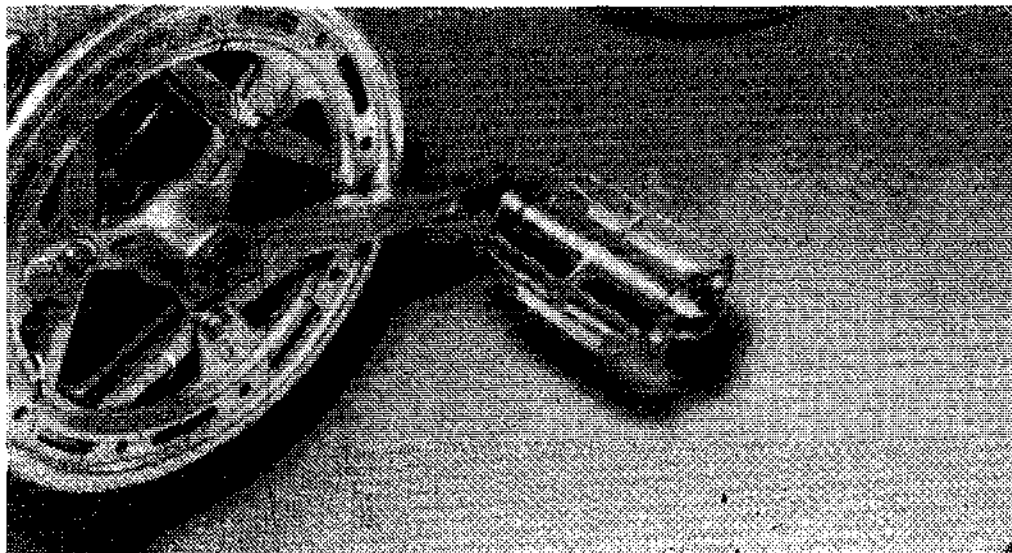

Fig. 2-23. A ratttrap pedal.

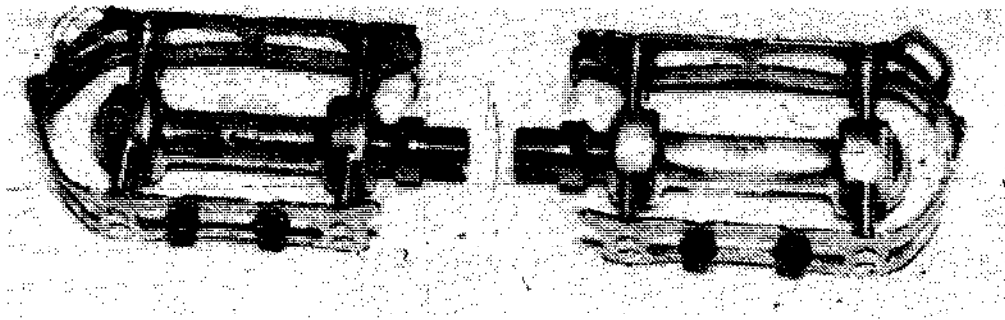

Fig. 2-24. Zeus high quality racing pedals.

Most of the metal pedals have teeth to keep your shoes from slipping. Racing pedals, however, generally have no teeth (see Fig. 2-24). Special shoes with cleats are worn to hold your feet in position on the pedals.

Regardless of the type of pedals, they should spin freely. Most standard pedals are lubricated with grease. A few pedals with permanently sealed bearings are now on the market. Some top quality racing pedals are lubricated with oil. As a general rule, inexpensive pedals are heavy and the expensive ones are light in weight.

### **Crank Sets**

These consist of the bottom bracket bearings and assembly and the cranks. The two basic types of cranks are one-piece and three-piece arrangements that make up the pedal cranks and axle.

The one-piece type is frequently used on inexpensive bicycles and less frequently on medium-priced ones. These are made of steel. The advantages of this type are that they are strong and relatively trouble free. The main disadvantage is extra weight. I especially recommend these for anything beyond normal riding. For younger riders, where curb jumping seems to be the rule rather than the exception, the one-piece type are much more likely to stand up than the three-piece ones.

The three-piece type are made up of an axle and two separate crank arms. There are two basic methods used for attaching the crank arms to the axle. They are cotters, called *cottered cranks* and with bolts that are used to hold crank arms on wedged axle ends. This method is called *cotterless*.

The axles on both types are typically steel. Cottered cranks are generally steel and cotterless are usually aluminum alloy.

As a general rule, one-piece cranks are used on the lowest priced bicycles, the cottered on intermediate priced bikes and the cotterless on expensive models. There is, however, much overlapping.

For the general run of stock bicycles, the length of crank arms is fairly standardized. But there are some variations. Longer arms can give better leverage for increased riding efficiency, but there must be adequate ground clearance for safe cornering for the type of riding intended.

With the chain removed, the crank assembly should spin freely with no noise. Most bicycles have bearings that are in retainers or loose. A number of quality bicycles now feature permanently sealed bearings and other manufacturers are switching to these. The advantage of not having to overhaul (clean and lubricate) the bottom bracket assembly could be well worth the additional cost for many riding purposes.

### **Chains**

These are extremely important. However, it takes a very experienced eye to even begin to judge quality just by looking at a chain. In most cases, you will just have to assume that the chain used on a particular bicycle is of a quality in keeping with the rest of the bike. As a rule, makers of quality bicycles will not skimp on the chains used.

### **Control Cables**

These are used for both caliper and disc brakes and shifters. The main thing to check is that the cable moves freely through the

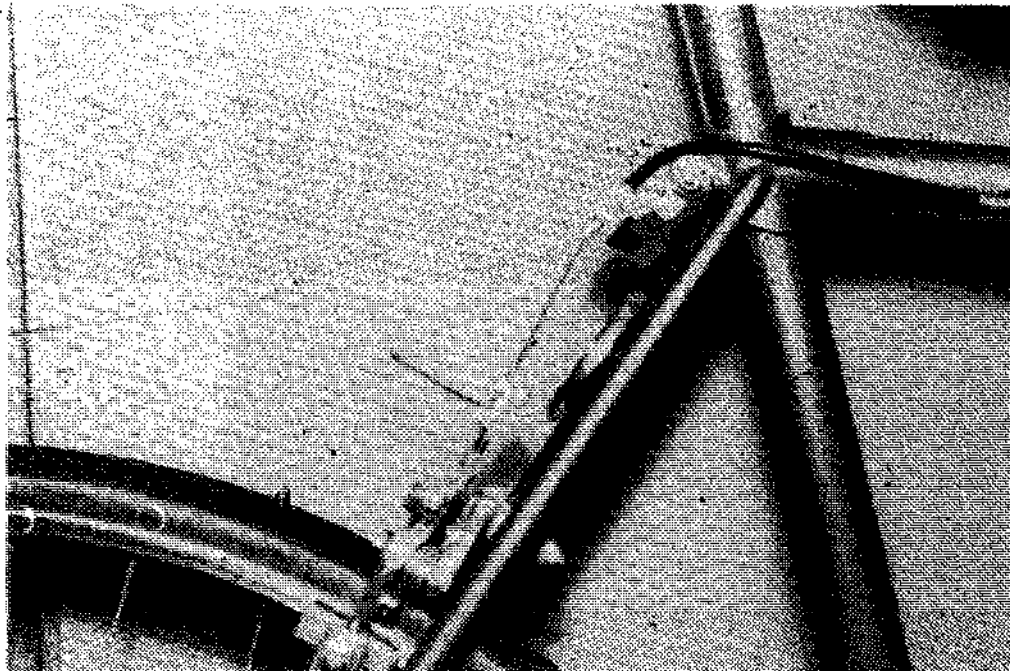

Fig. 2-25. The brake control cable housing fits into the lug which is brazed to the frame.

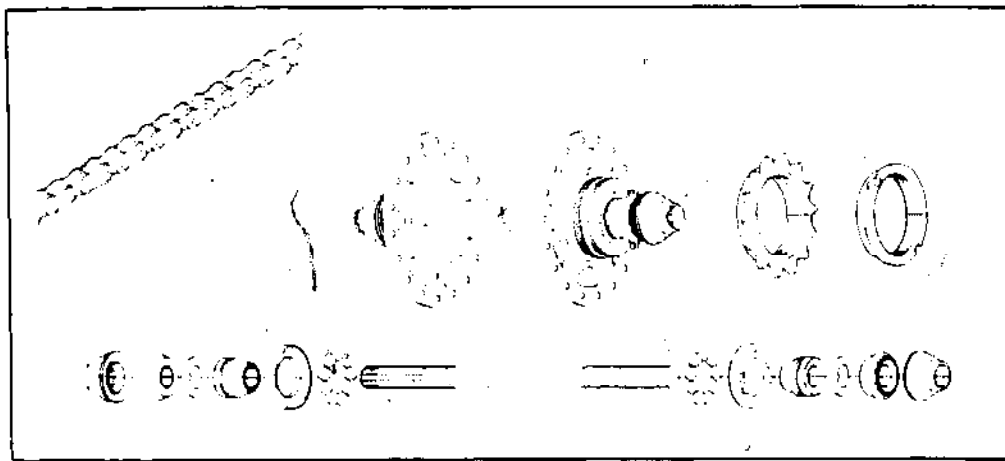

Fig. 2-26 Shimano Dura-Ace 10 chain and track model hub.

housing. Inexpensive bikes usually have the cables inside housings for the entire length. More expensive bicycles often have the sections of the cable that run parallel to frame tubes outside housings. This reduces friction. The cable housings are typically held to the frames of inexpensive bikes by clamps. More expensive bicycles often have lugs brazed to the frame (Fig. 2-25). This is generally a much better arrangement.

### UNDERSTANDING GEARS

The remainder of the components that go to make up complete bicycles—chainwheels, rear sprockets, freewheels, shifters and controls—are, I feel, best covered along with their operation. One of the most confusing things that a newcomer faces in selecting a bicycle is gears. Not only must quality be considered, but also type, number of gears and gear ratios.

#### Fixed-Wheel Track Bicycles

Perhaps the best way to gain an understanding of gearing systems and gear ratios is to start with a fixed-hub track bicycle. The basic drive mechanism is shown in Fig. 2-26. Notice that the small rear sprocket is fixed to the hub. It will not freewheel. When the wheel turns, so does the chainwheel and cranks.

The beauty of this system is the simplicity. If both the rear sprocket and chainwheel are the same size and have the same number of teeth, the gear ratio would be one-to-one (1:1). Some small sprockets have only every other tooth, but in computing gear ratios, the missing teeth are counted as though they were there. One-to-one would be an extremely low gear ratio. The bicycle would be easy to pedal, but you wouldn't go very far with each pedal cycle. A more normal arrangement, with the chainwheel larger than the sprocket, is harder to pedal—but you go further with each pedal

cycle. The formula for determining the gear ratio is:

$$\text{gear ratio} = \frac{\text{number of teeth on chainwheel}}{\text{number of teeth on rear sprocket}}$$

If, for example, there were 45 teeth on a chainwheel and 15 on a rear sprocket, the gear ratio would be three-to-one (3: 1). Since a number divided by one is the number itself, the gear ratio is 3. In Fig. 2-27, the chainwheel has 48 teeth and the rear sprocket in Fig. 2-26 has 14. The gear ratio, rounded off to the nearest tenth, is 3.4.

In actual practice, gear values rather than gear ratios are generally used. This is calculated as follows:

$$\text{gear value} = \text{gear ratio} \times \text{wheel diameter}$$

In the example above where the gear ratio is 3.4, the gear value is  $3.4 \times 27$ , or 91.8. The gear value represents the size the wheel would be on a direct drive (non-freewheeling) cycle with a 1:1 gear ratio. In this example, the wheel would be 91.8 inches in diameter.

Notice that this is not the distance covered. To compute the distance covered, you would need to multiply by 3.14. However, this isn't normally done and the *gear values* are used instead.

Various reasons have been given for not using the track distance. Apparently it's because multiplying by the constant, 3.14 would only serve to increase the size of the numbers. Sometimes the reason stated is that the wheels are not exactly 27 inches (or

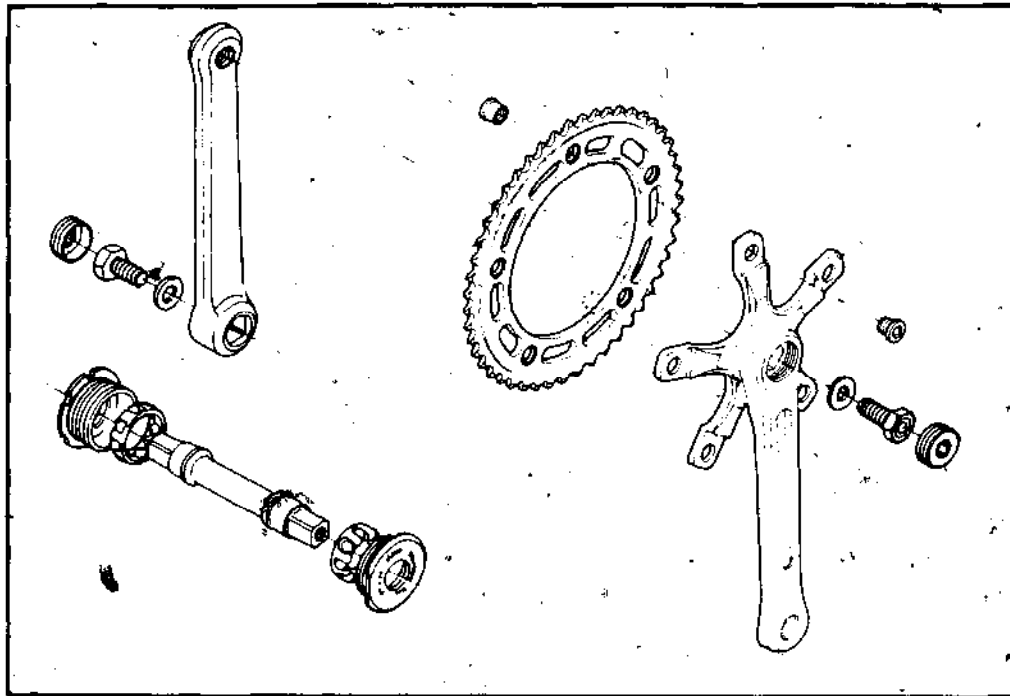

Fig. 2-27. Shimano Dura-Ace 10 crank set and track model front chainwheel.

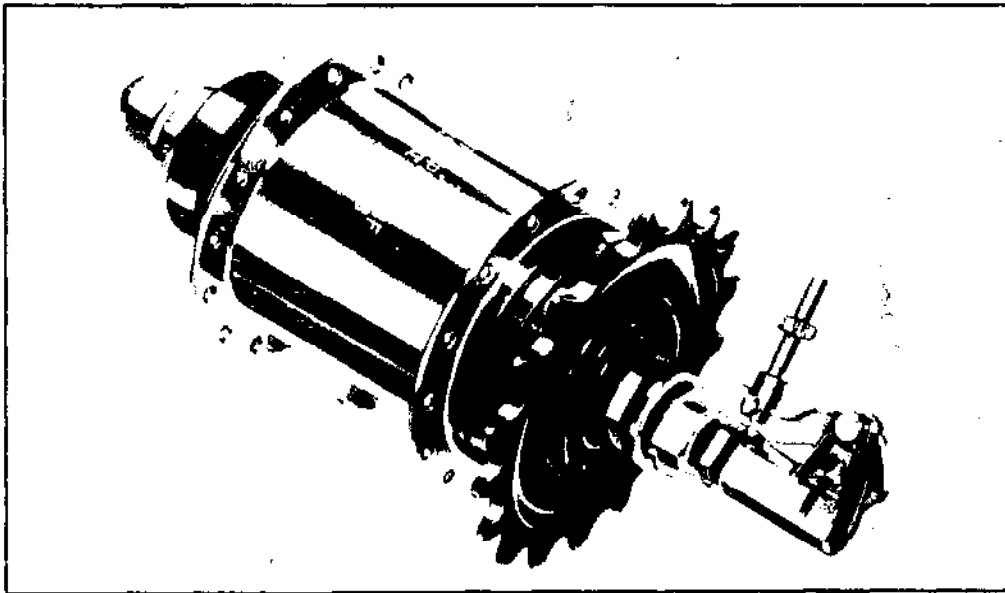

Fig. 2-28. Shimano Model TB-100 three-speed hub without coaster brake.

whatever). This seems invalid, as the same error also would enter into the gear value formula.

### **Single-Speed Bicycles**

The drive assembly of a regular single-speed bicycle—besides the fact that the track bike is an expensive, precision machine—differs from the track bicycle described above in that it will coast or freewheel when the pedals are stationary. This is accomplished by a freewheeling mechanism between the rear sprocket and the rear hub. The rear wheel cannot turn slower than the rear sprocket is turning, but it can rotate faster.

Disregard coasting when you are calculating gear values. This is the same as was done for the fixed-hub track bike in the section above.

Notice that while you only have a single gear value on a single-speed bicycle, you do have a choice of what that value is in the sense that you can change to sprockets with different numbers of teeth to obtain a new gear value. The gear value for the track bicycle in the section above, 91.8, is extremely high. For ordinary riding on a freewheeling single-speed bicycle, a gear value of about 60 to 80 would be more common.

### **Hub-Geared Bicycles**

These allow switching into two or more different gear ratios while riding. On a three-speed—the most common number used on hub-geared bicycles—the gear shifting is commonly done by a lever or twist grip. There is a set position for each gear. These are

typically marked L for low gear, N for neutral or sprocket gear ratios, and H for high gear. The gear value for the N position can be made by counting the teeth on the rear sprocket and chainwheel and then making the calculations as though the bicycle were a single-speed. The other two gear values can be determined only with great difficulty. However, the manufacturer should—and almost always does—have these in the specifications. A sprocket or chainwheel switch to one with a different number of teeth will change all three gear values. For example, on a *Shimano* three-speed hub with a 48 tooth chainwheel and a 14 tooth rear sprocket, the gear values in order of L, N and then H are 68, 88 and 120. This is an extremely high range of values for a three-speed. With a 16 tooth rear sprocket, the same setup would have gear values of 60, 78 and 104. This would be about average for a fairly fit rider. A 19 tooth rear sprocket gives gear values of 49, 66 and 88. This gives a fairly low range of gears, but many riders would find this ideal for around town riding.

A *Shimano* three-speed hub without a coaster brake is shown in Fig. 2-28. One with a coaster brake is shown in Fig. 2-29. These require shifting by the rider. Fig. 2-30 shows a *Shimano* automatic two-speed hub. With this unit, the gear shifts automatically from low to high and vice versa according to the running speed of the bicycle. Since no shifting is required, even a beginner can safely use it.

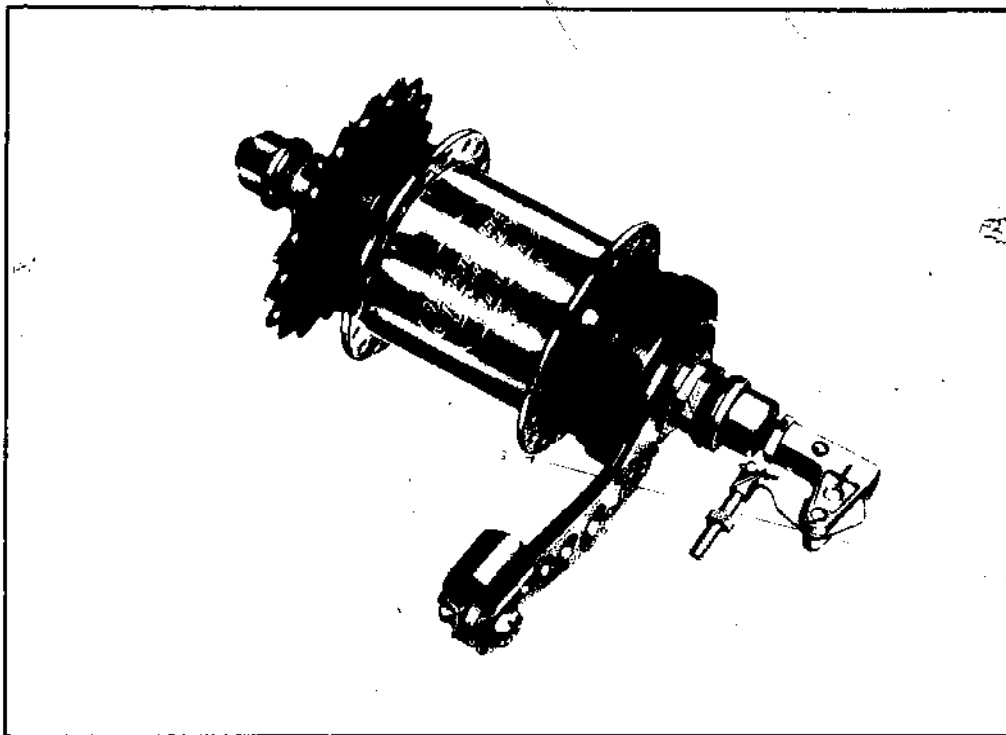

Fig. 2-29. Shimano Model TC-100 three-speed hub with coaster brake.

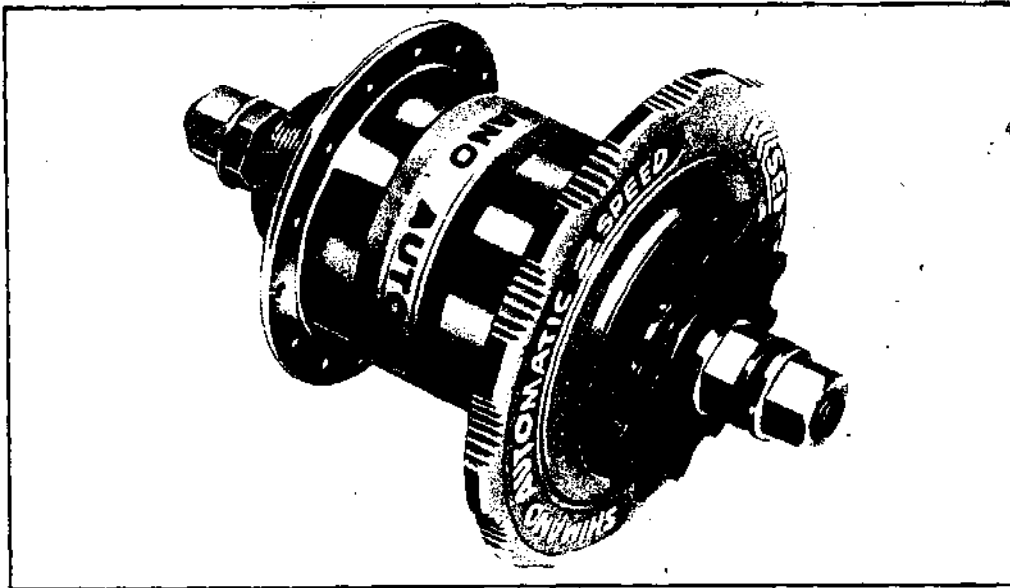

Fig. 2-30. Shimano Model AB-100 automatic two-speed hub.

### Derailleur-Geared Bicycles

The best way to study the operation of derailleur gears is to place a derailleur bicycle in a maintenance rack or upside down so that the pedals can be rotated by hand and the shift levers operated. Counter-top demonstrators that many bicycle shops have to acquaint potential customers with derailleur mechanisms will serve the same purpose.

First, consider a five-speed. This has a cluster of five sprockets at the rear hub—each with a different number of teeth. As was the case with the single-speed, there is a freewheeling mechanism between the sprocket cluster and the hub. There is a single chainwheel at the crank.

The gear values will depend on which of the rear sprockets the chain is on. There will be five different gear values. For example, if the chainwheel has 50 teeth and the rear cluster from the largest inside sprocket outward is 28, 24, 20, 17 and 14, the gear values from the lowest—which would be with the chain on the 28 tooth rear sprocket—to the highest are 48, 56, 68, 80 and 96.

How is the chain moved from one rear sprocket to the next? The chain is actually derailed from one sprocket so that it will move over onto the next one. With a five-speed mounted so that the derailleur can be operated by hand, turn the pedals and then operate the shift lever. If a 10-speed bicycle is used for the demonstration, simply leave the front derailleur in either position and work only the control lever for the rear derailleur. On the five-speed, there is only one derailleur control lever.



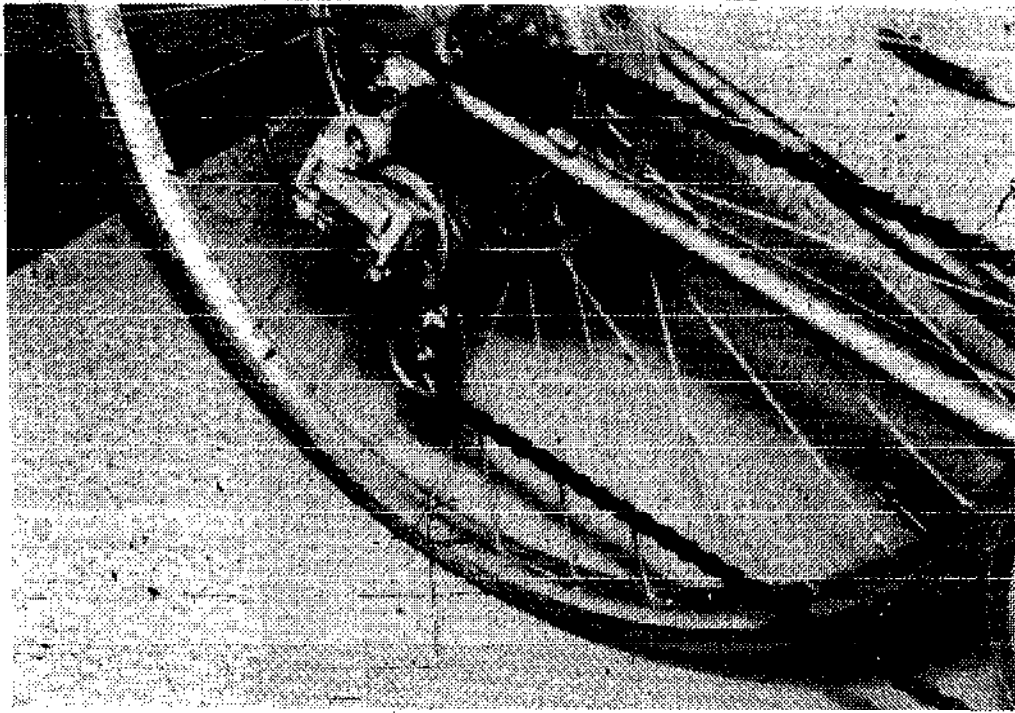

Fig. 2-31. Sun Tour V-GT rear dérailleur.

Notice that the rear dérailleur mechanism (Fig. 2-31 and Fig. 2-32) performs two basic functions. It moves the chain from sprocket to sprocket and it takes up the slack in the chain. The latter is required. Without this, the chain tension would be different on the smallest rear sprocket than on one of the larger ones. On a single-



Fig. 2-32. Another view of a rear dérailleur.

speed bicycle, a single chain length suffices. On the derailleur system, many lengths are needed.

The rear derailleur mechanism has two small pulleys with cages around them that move inward and outward by means of transversing arms that are shaped in a parallelogram that is under spring tension. The cage remains parallel to the sprockets. There are a few new designs that vary slightly from this. The inward travel is by means of an operating shift lever and outward is by action of a spring mechanism when the tension on the control lever is released. The chain is ~~derailed only~~ from one sprocket to the next. Skipping sprockets when you shift is poor technique and tends to damage chain and sprockets. The chain must be moving, that is, the bicycle pedaled, for shifting to take place.

The pulley cage is also under spring tension toward the rear of the bicycle. It is this that keeps the spring in tension regardless of the sprockets (front and rear) that the chain is on.

The shift operating mechanism on most derailleur systems is continuous action. There are no set stops for each gear. The cable pulls the parallelogram open. This shifts the derailleur mechanism toward the high side (largest sprocket but lowest gear). Release the tension on the cable and a spring returns the mechanism to the low side (smallest sprocket but highest gear). Only the limits are adjustable. There are two adjustment screws. One limits the pulley travel on the high side and the other limits the pulley on the low side. These are typically marked by the adjusting screws with an H for high side and an L for low side.

The pulley that derails the chain is called the *jockey wheel* or roller. The lower roller, which maintains the chain tension, is called the *tension wheel* or roller. The rear sprocket cluster is often called the *freewheel*. The hub of the sprocket contains the freewheeling mechanism.

Five sprocket rear clusters have become the standard number. Other numbers, especially three and six, are sometimes used.

The five-speed derailleur system described above is made into a 10-speed by means of a double chainwheel at the crank (or 15-speeds with a triple chainwheel) and a separate front derailleur system for this with its own control lever.

The front derailleur mechanism (Fig. 2-33) derails the chain, causing it to move from one sprocket to the next in a manner similar to the rear derailleur. However, the front mechanism does not have a device for maintaining chain tension. This is taken care of by the rear tension device.

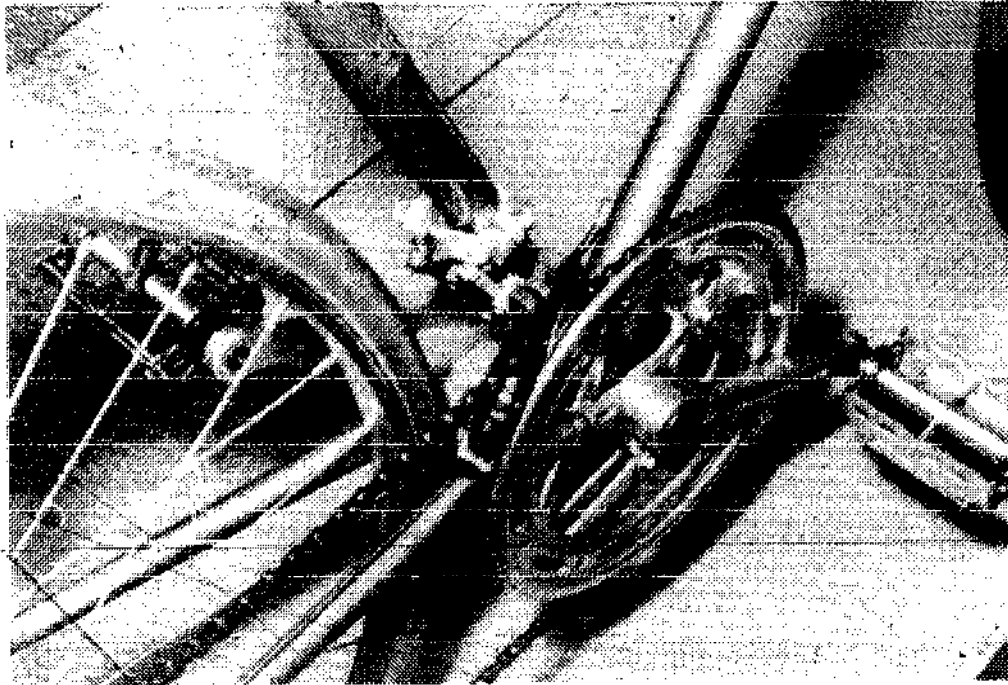

Fig. 2-33. Sun Tour front derailleur.

Like the rear derailleur, the front derailleur is cable operated and has two limit-stop adjusting screws. The small (inside) chainwheel gives the lower gear, the large (outside) one gives the higher gear. This is exactly the opposite of the rear sprockets.

On most front derailleurs, the lever pull deforms the parallelogram of the pantograph outward—moving the chain from the smaller to larger chainwheels. The spring action when the tension on the lever is released pulls the parallelogram inward. A problem with this is that pulling the rear control lever toward you gives a lower gear, but pulling the front control lever toward you gives a higher gear. This arrangement takes considerable practice to get used to.

The *Sun Tour* front derailleurs work the opposite of this. The spring moves the cage outward and the lever pulls it inward. This simplifies operation in that pulling either control lever toward you will always result in a lower gear. Pushing either control lever away will result in a higher gear—until the limits are reached.

One problem that has long been associated with derailleur systems is the amount of skill required to operate them. On most derailleurs, the shifting must be done by feel, as there are no set positions for centering the chain over individual sprockets.

In an attempt to get around this problem, the *Shimano Industrial Co. Ltd.* developed the *Positron* rear derailleur (Fig. 2-34). The features are:

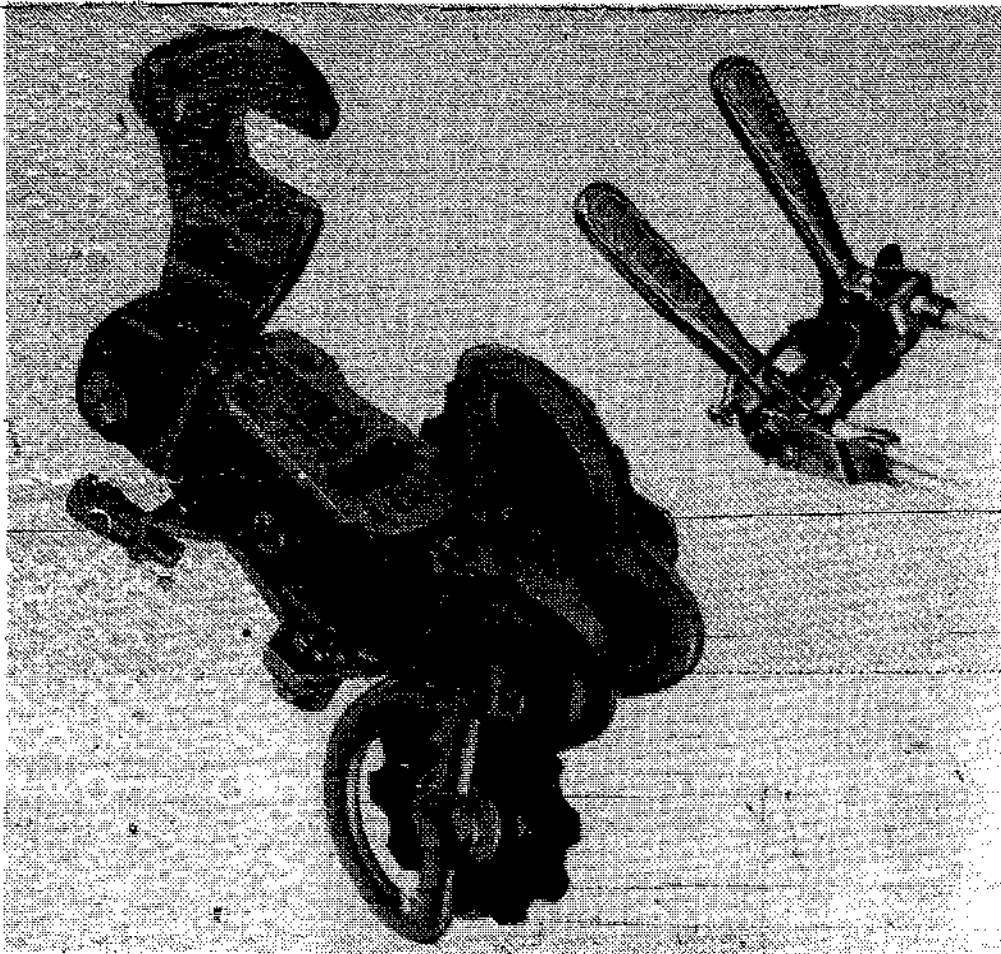

Fig. 2-34. An enlarged view of a rear derailleur.

- A positive indexing mechanism is built into the derailleur to give carefree shifting. It's a click mechanism with recessed cups into which a steel ball drops.
- In each gear position the chain is centered on the sprocket. This eliminates sloppy shifts and irritating noise.
- It works independently from the front derailleur. Therefore, it can be used on five or 10 speed bicycles without any problems.
- While most derailleur systems use a pull-release system with a single cable, the *Positron* uses a two cable pull-pull system. This results in light and accurate shifting.

The *Shimano Co* has also developed a derailleur system that can be shifted even when the rider is not pedaling. It's called the *FF System Front Freewheeling System*. It utilizes a freewheeling mechanism which is attached to the front chainwheel (Figs. 2-35 and 2-36.) This allows the chain to continue to revolve even after pedaling has stopped. The advantages of this feature are:

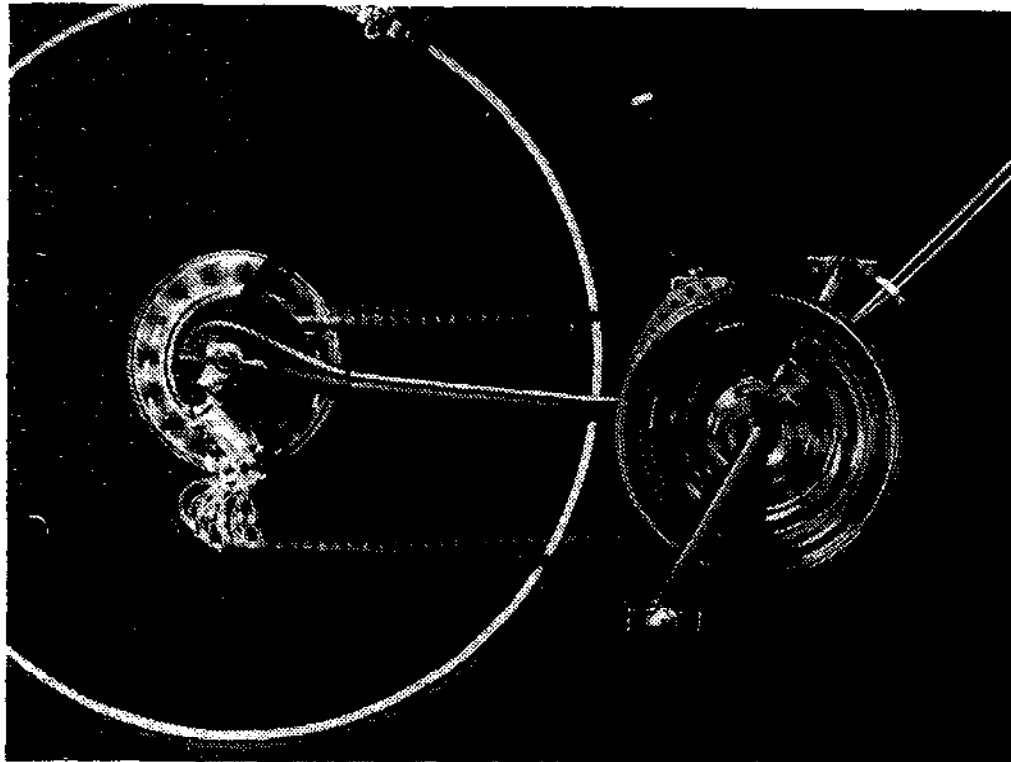

Fig. 2-35. Shimano Front Freewheeling (FF) System.

- A particular gear can be preselected before riding by shifting the lever and pushing the bicycle forward. This allows the rider to shift from high to low gear before mounting the bike.

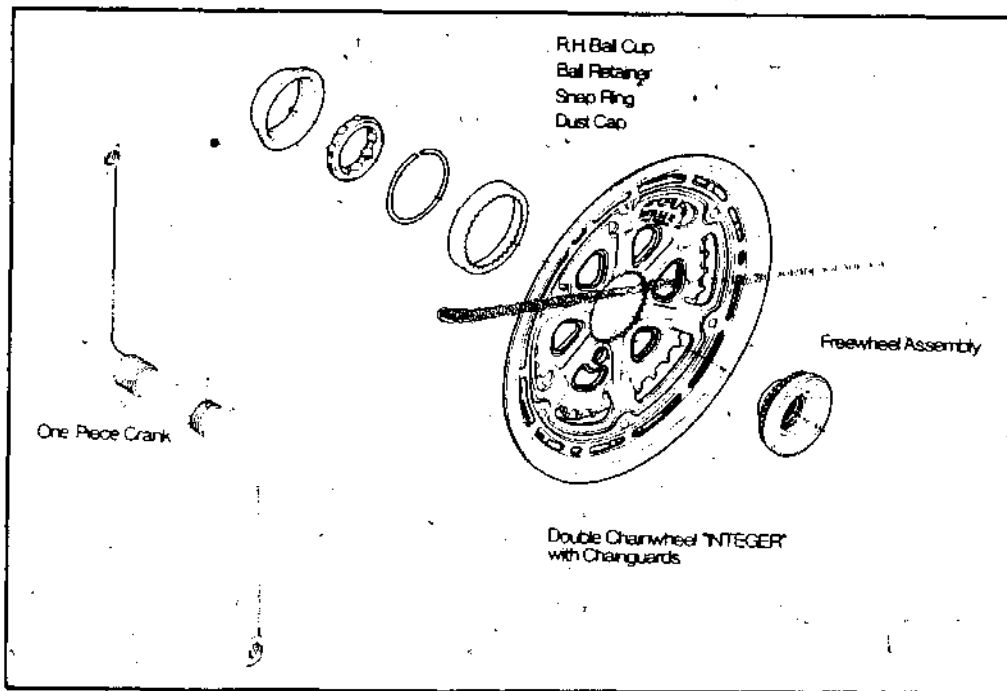

Fig. 2-36. A front freewheeling chainwheel.

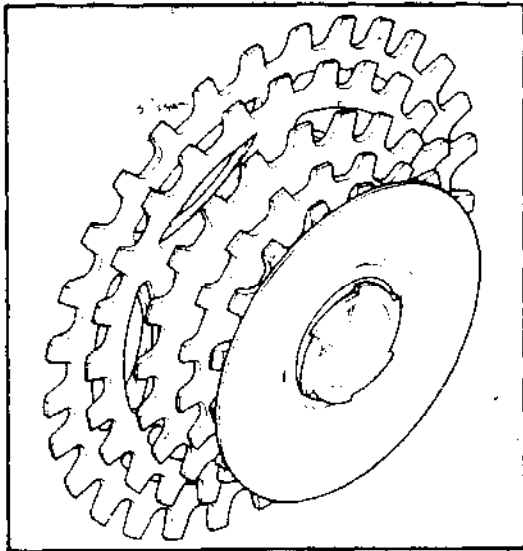

Fig. 2-37. A rear frictional freewheel assembly.

- You can continue to shift the gears even while slowing down to a stop and be in the proper gear when you start again.
- Because shifting can be done without putting pressure on the pedals, the shift itself will be easier and more precise. The tension on the chain becomes uniform while coasting. This results in unprecedented smoothness in shifting.
- Backlash due to shifting while pedaling backwards is totally eliminated. Proper shifting can be accomplished even while the rider is pedaling backwards.
- Both derailleurs can be shifted at the same time to give more precise control over gear selection.
- The front crank is freewheeling. If an object such as a pants cuff gets caught in the chain, the rear freewheel (see Fig. 2-37) will engage and override the front freewheel and stop the chain. This is an important safety feature.
- Many riders find it difficult to properly coordinate their shifting while pedaling up a hill. With the *FF System*, a rider can shift into a lower gear without pedaling.
- There is a mechanism that limits the movement of the chain in both high and low gears. Even if the derailleurs are out of adjustment, the chain will not fall off the sprockets.

The *FF System* will adapt to most bicycle frames without any alteration being required on the bottom bracket. The *Shimano FF System* is also used on a bicycle marketed by the *Panasonic Co.*, One Panasonic Way, Secaucus, NJ 07094.

Regardless of whether you decide on a five, 10, or 15-speed derailleur system, you will want to consider carefully what the gear values will be. Most new bicycles will have a gear chart showing the gear values for the particular rear sprockets and chainwheels used. If not, you can count the sprocket teeth and calculate them. A typical chart follows. This one happens to be for my *Azuki 860 Sports Tourer*.

Teeth on Rear Sprockets

		34	28	22	18	14		
Teeth on	46	37	44	57	69	89	Gear	
Chainwheel	52	41	50	64	78	100	Values	

The gear development—gear values from lowest to highest—is: 37, 41, 44, 50, 57, 64, 69, 78, 89 and 100. This wide range of gears is for touring. Not all rear derailleurs will handle a range of from 14 to 34 teeth sprockets. The rear derailleur on my bike is a *Sun Tour VGT* alloy long armed model. The *Grand Touring* indicates that it will handle a wide range of gears.

On road racing bicycles, a narrower range of gears is generally used than for touring. A few points that should be kept in mind when selecting gear values are:

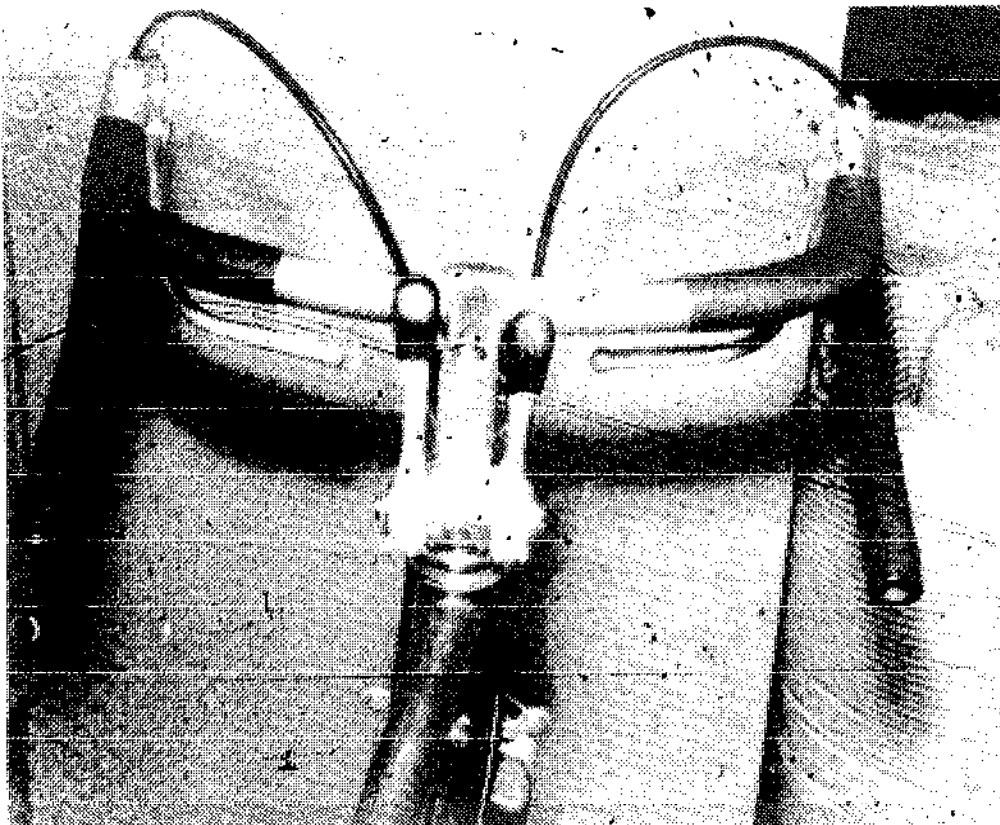

Fig 2-38. Derailleur shift controls located on the handlebar stem.

- The weight of the bicycle is an important consideration. In general, a heavier bicycle should have a lower range of gear values than a lighter weight bike.
- Keep in mind the intended use. If you will be riding in mountain areas where there are a lot of steep hills, a lower range of gear values would be called for than if most of your riding is to be on level roads.
- Gear values of over a hundred generally are not needed. The only way most riders can handle these is by pedaling slowly. This is generally much less efficient than a lower gear value that can be handled at a higher cadence.
- Try to get the gear values you will be using most in the middle of the gear range.

3 If you find the bicycle you want—but with the wrong gear values for you—in many cases a bicycle dealer will make sprocket switches and therefore change gear values.

Location of shift levers is another consideration. Until recently, almost all derailleur shift levers were on the bottom tube. This is still the arrangement used on most racing bicycles. For touring, two other positions are popular. They are on the handlebar stem (Fig. 2-39) and on the handlebar tips. Each location has its advantages and disadvantages and the choice is an individual matter.

The levers, including *stick* shifts, are sometimes located on the top tube. For obvious reasons, this presents a safety hazard and I recommend that you avoid these.

### **THE TOTAL BICYCLE AND WEIGHT**

It is one thing to consider the components that make up a bicycle, but quite another to make a selection when they are assembled together to form an actual bicycle. You might have some choices in switching some components, but this is generally a limited possibility—especially in the case of lower priced models.

If each component on one bicycle weighs just a little more than those on another bicycle, the total weight can be considerably more. That is why so much emphasis is placed by manufacturers on shaving off ounces on various components—especially in the case of medium priced and expensive models.

As has been pointed out, light weight is not the only factor to consider. A bicycle must also be strong enough and have the desired rigidity.

The frame is usually less than half the total weight of a complete bicycle, so heavy components can easily offset gains made by using a lighter weight frame. Most manufacturers match the quality



of frames with the quality of components. In general, lightweight frames get lightweight components.

### THE RIDER AND THE BICYCLE

While elaborate charts have been devised for determining the proper bicycle size from body measurements, I feel that two simple measurements are a much more practical method. The first is to take off your shoes and straddle over the frame bar with both feet flat on the floor. There should be at least a one-half inch clearance

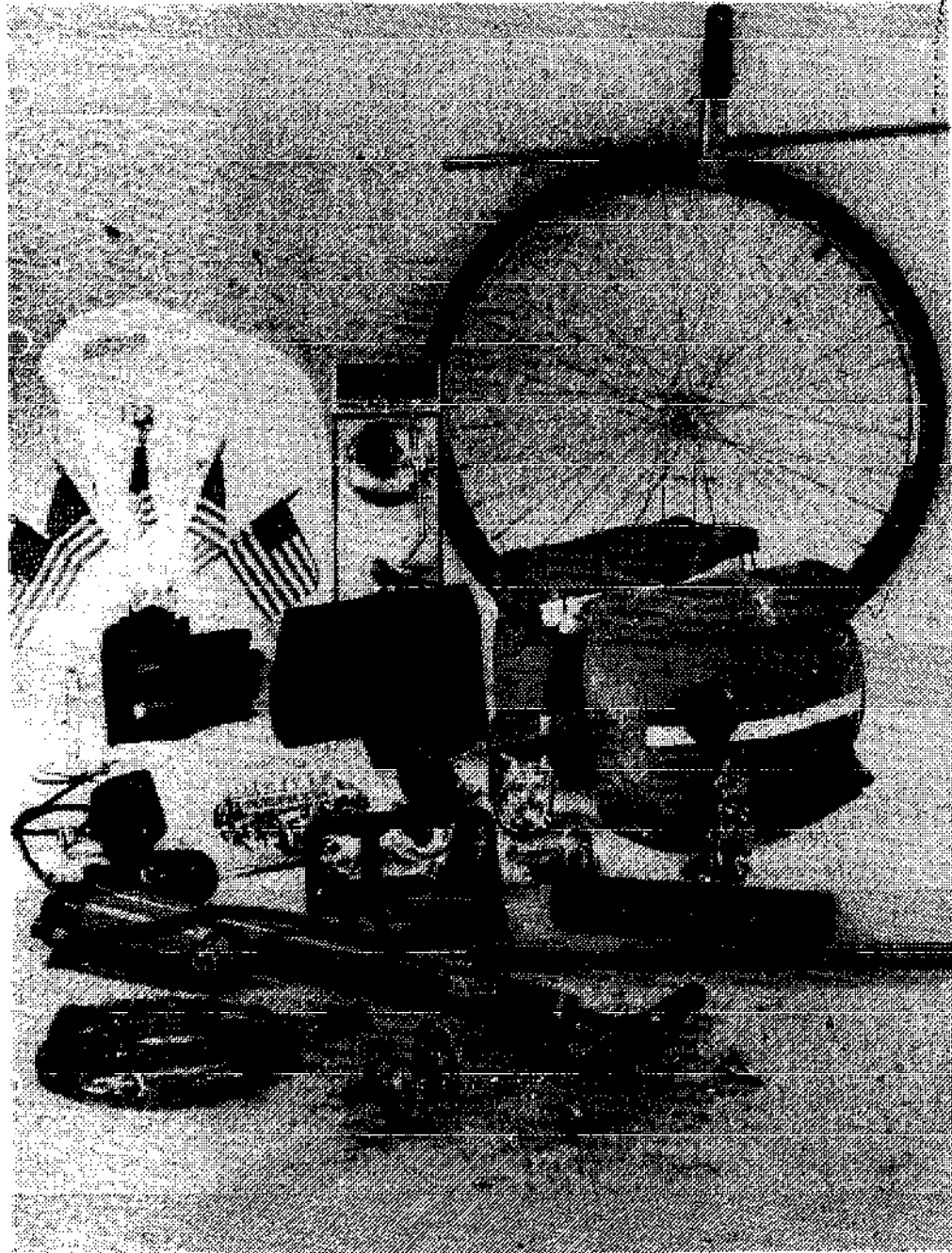

Fig. 2-39. Some of the bicycle accessories offered by AMF.

between crotch and top frame tube. If there is more than one inch clearance, try the next larger frame size.

The second measurement is reach. This is the distance from the saddle to the handlebars. With your bent elbow placed against the forward end of the saddle, the extended fingers should reach to the center of the handlebar clamp. If this distance is off, minor corrections can be made by switching to a handlebar post with a different length neck. Also, adjustment can be made in the forward/backward adjustment of the saddle. For proper balance, the forward tip of the saddle should generally be about two inches behind the crank axle center.

### **ACCESSORIES**

You will need to consider extra equipment in terms of what you need and what is included with the bicycle you choose. Since accessories add to the cost, they should be chosen carefully.

It's not economical to purchase a bicycle with accessories that you do not want. Sometimes a dealer will take these off and reduce the price accordingly or exchange them for spare parts such as spare tires and tubes that you will need in the future.

Accessories include fenders, kick stands, chain guards, carrying racks, lights, reflectors, tire pumps, water bottles and tool kits.

I feel that it is most economical to keep the accessories at approximately the same general quality as the bicycle. Choose inexpensive accessories for inexpensive bikes and so on up the price and quality scale.

Accessories add weight to the bicycle, so keep this in mind when making selections. Always ask yourself if the compromise of weight versus usefulness is worth it.

### **PRICE, DESIGN, QUALITY AND WEIGHT**

These are all factors that must be taken into consideration when selecting a bicycle. In the low price range under \$150, most adult-size bicycles will weigh 35 pounds or more. Many will scale in at over 40 pounds. Only in a very few cases is the extra weight used to make a stronger bicycle than a typical lighter model in the next higher price range. Most of the extra weight is from using less expensive materials and construction methods.

In the medium-price range of \$150 to \$230, most adult bicycles weigh from about 27 to 38 pounds. The lighter weights are at the high end of the price range. In this price range, some of the heavier bicycles do use the added weight to good advantage. I have seen young riders use some of these bicycles for curb jumping without

apparent damage. I doubt if most lighter weight bikes could withstand this type of use.

The point is, when comparing a heavier bicycle with a lighter weight one, see how the extra weight has been used. Then decide if this makes the bike more suitable for the intended use.

There is no getting around the point that weight does affect performance. Eight pounds difference in weight of two bicycles that were equal in all other respects would be immediately apparent to almost any rider.

In the higher price range over \$300, you can expect light weight. The weight is almost always under 30 pounds and frequently under 25. While a few road and track racing bicycles are available in the medium-price range, most are in the high price bracket.

## Using Bicycles

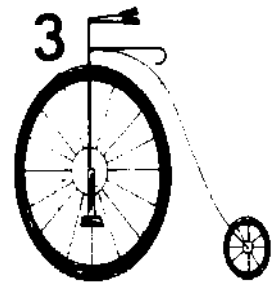

In order to get the most use and enjoyment from your bicycle, you will need to consider riding, safety, legal requirements, care and protection of bicycles and ways of using bikes (Fig. 3-1).

### RIDING

You can, of course, learn to ride a bicycle without understanding the forces that are at work to keep you balanced in an upright position, just as you learned to walk without first learning the biomechanics involved.

With this in mind, it is often said that two forces—gyroscopic and centrifugal—enable balance on a moving bicycle.

Like a toy gyroscope, a spinning bicycle wheel holds its position in space until upset by an outside force. This is one force that tends to keep a bicycle in balance when in motion. However, some experts consider it to be only a minor factor.

Centrifugal force is the effect of pushing away from the center of a rotating body. This force is experienced when you make a sharp curve in a motor vehicle. In bicycle riding, a fall to one side is corrected by turning the bicycle slightly in that direction so that centrifugal force will push you back upright again. Bicycling is basically a series of such corrections. They become so automatic with practice that you do not even have to think about them.

A typical bicycle will, for a short distance, maintain balance coasting down a hill without a rider. It is possible to ride bicycles that will not keep balance when coasting without a rider. And one

specially designed bicycle that had the rider in a prone position was able to reach controlled speeds of 60 miles an hour with the rider coasting down a hill. With pedaling, control was extremely difficult at 40 miles an hour.

The cranks give leverage in pedaling. In turn, there is a gear ratio which most often allows more than one wheel revolution for each pedal revolution.

A major breakthrough in bicycling came with the development of freewheeling. Until this time, bicycles were fixed or direct drive units. One turn of the pedals gave a fixed distance—depending on the gear ratio to the wheel—with no freewheeling. This principle is still used for some types of racing and artistic bicycling.

Freewheeling gave a tremendous boon to most types of bicycling. It also created a new problem—braking. With the fixed drive, braking is accomplished by slowing the pedal action.

Through the years various types of braking systems have been developed. On early chain-driven bicycles, various gear ratios other than one-to-one were used. Systems for changing the gear ratios while riding soon developed. It is interesting that new systems are still being invented and tried. In the future, the derailleur system which is the most popular today might well become obsolete.

While such things as braking and gearing systems have improved the efficiency of bicycling, they also tended to increase the skill required to operate a bicycle.

Much of the early development of the bicycle seems to have come about by trial and error and the efforts of individual inventors. Only recently have computer models for bicycles been developed. The results of this research might lead to further improvements and a better understanding of the bicycle.

### **Learning to Ride**

The proper bicycle for learning to ride is not necessarily the right size after the fundamentals have been learned. The saddle should be adjustable and adjusted to the point where the learner can straddle the saddle and easily put both feet flat on the ground outside the pedals. A single-speed bicycle with a coaster brake is generally best. If a geared bicycle is used, place it in one fairly low gear and leave it there. Hand operated brakes tend to make learning more difficult.

Forget about training wheels. It has been my experience that these only hinder learning, even for small children, but probably more so for older ages. Never add blocks to pedals in an attempt to make a large bicycle fit a small rider. About the only exception to

this that I can think of is to adapt a bicycle for a rider with a handicap such as is sometimes done with the controls on automobiles.

Always wear shoes when you are riding a bicycle. The bicycle should have a chainguard. A beginner could be seriously injured by catching clothing between the sprocket and chain. Learn in a large open area with a level surface that is hard, smooth and free of motor vehicle traffic.

Begin by straddling the saddle. Place your feet on the ground outside the pedals. With the bicycle in a stationary position, practice lifting your feet off the ground. Then place them down again.

Next, learn to move forward by walking your feet along the ground outside the pedals. This is the way *hobby horses* were ridden. As you increase speed, but not too much, try picking your feet up off the ground and coasting for a short distance before you put your feet down. Gradually increase the coasting distance with your feet off the ground.

Next position one pedal forward—usually the right one—but use the left if it feels more natural. Straddle over the saddle. Grip the handlebars, lean forward slightly and with one foot on the forward pedal, push down on the pedal. Coast forward. Then place both feet on the ground.

The next step is to start as above, only this time also bring the second foot up to the other pedal. Coast. Return your feet to the ground.

Continue to practice and add additional pedal revolutions as you gain confidence. To stop, back pedal slowly. When the bicycle is nearly at a standstill, take one foot—usually the left—off pedal and place it on the ground.

To turn, simply point the front wheel in the direction you wish to go.

After you have mastered the basics, the saddle can be raised for more efficient riding.

### **Riding Tips**

An accomplished bicycle rider does many things differently than a beginner. In other words, there are skills and techniques to learn. With practice, these can become automatic and you will no longer have to think about them. However, it's important that you don't allow incorrect techniques to become habits.

Riding is a combination of things such as posture, balance, pedaling techniques, gear shifting, braking and even breathing.

**Posture.** The most comfortable posture does not always offer the least wind resistance. You might have to sacrifice some comfort if you want maximum efficiency. Dropped handlebars offer a choice of riding positions. With your hands on the lower handlebars, lean your body well forward. This offers less wind resistance than when you are sitting upright. The leaning forward position might take some getting used to. Sore back and neck muscles might result at first. Alternating leaning forward with a more upright posture is often helpful. Flat handlebars are often preferred by those who lack the fitness or desire to assume an extreme leaning position.

The type and height of saddle will also have a bearing on your posture. Perhaps the most comfortable—although this point is often debated—is a very low positioned, padded mattress-type saddle with the rider sitting nearly upright. However, this is not the most efficient riding position as far as either wind resistance or pedaling is concerned. Your leg muscles exert the most power when they can be fully extended.

A wide saddle interferes with leg motion especially when the saddle is positioned up high. A narrow saddle allows your thighs to be fairly close together. The saddle can be placed high so that the legs will be almost fully extended when they are on the pedals in the lowest position of a pedal cycle.

On long rides, the question of posture becomes confusing. A more relaxing posture increases wind resistance and takes more effort to pedal the bike. However, you can make use of the wind. With a tailwind, ride upright so that your body acts like a sail. With headwinds ride leaning well forward to reduce the resistance as much as possible.

**Balance.** Many balance factors are more complicated to describe than to execute. Up to a point, balance becomes easier as the speed increases. Using low gears for starting out will make balance easier while getting up speed.

Beginning riders frequently exhibit considerable side-to-side motion, but experienced riders generally do not have much of this. The difference seems to be just a matter of practice.

**Pedalling Techniques.** First, there is the use of ankle and foot actions to add additional muscle groups into the pedaling. This can be done to a certain extent without toe clips and straps, but the clips and straps greatly increase effectiveness. They also allow lifting upward on the pedals as well as pushing downward.

Another important factor is the pedaling rate or cadence. This is part of the reason why bicycle gears are frequently called *speeds*. In general, bicycles are most efficiently ridden at a constant pedaling rate. Most riders have an optimal rate of pedaling. This rate usually somewhere between 60 and 85 pedal revolutions per minute. At this constant cadence each different gear ratio will give a different speed. Therefore, instead of saying a ten-gear bike, the term *ten-speed bike* is used.

There will, of course, be gear ratios or riding conditions that will not allow the rider to maintain the optimum cadence.

Beginners typically use gear ratios that are so high that they cannot possibly keep up their optimal pedaling rate. Stop and start pedaling, in spite of what it might appear, is inefficient. Accelerations require much more effort than maintaining a constant speed.

Experienced riders tend to spend much more time pedaling at their optimum cadence than beginners. It's extremely difficult to convince a beginner that there is something better than to pedal hard for a short time, coast and rest, and then pedal again.

**Breathing.** Closely related to pedaling cadence is breathing. Like endurance runners, bicyclists develop rhythmical breathing patterns that coordinate with their leg action. Except for short sprints, where your breath can generally be held, breathing should be regular. Otherwise, make certain that you do not hold your breath.

## GEAR SHIFTING

Gear shifting is extremely important to riding efficiency. The human body operates most efficiently over a narrow range of power output and the gears allow most effective use of this power. This is the reason why large numbers of gears are frequently used on bicycles. The typical automobile engine can operate effectively over a fairly wide range of power outputs with only three or four gear ratios. A bicycle rider can use 10 or even 15 to advantage.

To correctly shift most internal hub gears, stop pedaling, shift into another gear while the bicycle is coasting and then resume pedaling. The actual shifting is done when the chain is *not* moving. Shifting can also be done when at a standstill.

With practice, shifting can be done smoothly and quickly with only a brief pause in the pedaling. Since each gear is in a definite click position, there is no problem in finding the gear.

Derailleur gears generally require much more skill to operate correctly. The gears are usually shifted by continuous motion of the changer-lever without having notches or other set locations for the



individual gears. This means that shifting is largely a matter of feel and it can take considerable practice to learn this.

The limits can be in a set position as far as the control levers will go either forward or backward. But even here fine adjustment is usually required to eliminate noises from the derailleur mechanisms.

To shift, ease up on the pedaling. But do not stop pedaling completely. Then shift by slowly moving the control lever. You should only shift from one sprocket to the next at a time. Avoid skipping sprockets. After shifting, resume normal pedal cadence again. Practice shifting until it can be done smoothly and efficiently.

On five-speed bikes, there is generally only one control lever. This makes everything easier. There is only one basic pattern to learn. Pull the lever toward you for lower gears and push the lever away—releasing tension on control cable—for higher gears.

On 10-speed and 15-speed bikes, the operation is complicated somewhat by having two control levers. The rear control levers are generally located on the right side of the bicycle—regardless of the lever locations. Generally, they are on the bottom tube, handlebar stem or the tips of handlebars. The front derailleur control is on the left side.

On most bicycles, the front derailleur works in the opposite direction of the rear one. Pulling the front derailleur lever toward you shifts into higher gears.

*Sun Tour* front derailleurs work just the opposite. Pulling toward you shifts into lower gears, just like the rear derailleur. After having used both types, I believe the *Sun Tour* is a real improvement for easy riding.

Do not shift both the front and rear derailleurs at the same time. The key technique to master is a feel for when to shift in order to maintain cadence. In traffic, try to down shift while you are slowing down so that you will be in a low gear when you start out again.

Shifting on hills generally places the greatest stresses on the derailleur mechanisms and chain. To minimize this, downshift early, before you are struggling to maintain cadence and *lugging* with slow, heavy pedaling.

Ten-speed and 15-speed bicycles might not actually have 10 or 15 effective gear ratios. Some of the ratios are typically so close together—or possibly the same—as to render them ineffective. It is best to avoid the extreme chain angles—especially from smallest inside chainwheel to smallest outside rear sprocket and largest



Fig. 3-1. Recreational riding

outside chainwheel to largest inside rear sprocket. In general, try to do most of your riding in gears where the chainwheel and rear sprockets are most nearly lined up. Of course, this will automatically be the case if the gear ratios are properly selected in the first place (see Chapter 2).

Most sprocket arrangements require alternate shifting of the front and rear derailleurs in order to use the full range of gears progressively.

After shifting to a new gear, fine adjustments to eliminate noises can be made after pedaling is at normal cadence. This is a very sensitive adjustment. Move the control lever slightly in one direction until the noise has been eliminated. If it gets worse, move the control lever in the other direction until the noise stops.

Since shifting is largely by feel, you have to get used to each particular bicycle. A switch to another bicycle requires learning another particular bicycle. The adjustment can be even more difficult if the gear ratios are different, the bicycle is lighter or heavier or the shift control is located in a different place. With enough riding, a particular bicycle becomes like a part of you and the gear shifting becomes so natural that you don't have to consciously think about it.

### **BRAKING**

Perhaps the easiest system to operate is the coaster brake. All that is required is simple backpedaling. There is some skill in applying the required amount of pressure for the particular stopping conditions. Generally, the braking should be done smoothly when space and conditions permit—but quickly in certain emergencies.

Bicycles with a single, hand-operated brake to the rear wheel such as a disc brake, operate similarly to coaster brakes, except

that the braking control is by hand. The pedaling, of course, should stop when the braking begins.

Some bicycles have a rear coaster brake and a hand-operated—usually a caliper type—front-wheel brake. In this case, apply the coaster brake first, followed by the hand brake. Never apply the hand brake alone when riding at high speeds. This can cause the rear of the bicycle to come off the ground and spill the rider forward. This is often stressed as a safety rule. I violated the rule just to see how great the chances were of a spill actually happening. I'm convinced that you would have to lean over well forward or go at a pretty good speed to actually take a spill. Of course, I didn't carry my experimenting to the point of an actual spill—so I don't know what the exact danger point is. I wasn't able to get the rear wheel to even come off the ground. On the other hand, I am convinced that jamming the front brake at high speed could do it.

The principles are the same with front and rear hand brakes except that everything is done by hand. The control handle for the rear brake is generally located on the handlebar on the right side of the bike. The one for the front brake is on the left. Notice that this same pattern is followed for derailleur gearshift controls.

When you are first learning, start to apply the rear brake followed by the front brake. Experienced riders generally apply both brakes at the same time and about equally. But this requires practice.

When coasting downhill, apply brakes periodically rather than continuously. Don't wait too long before starting the braking. Always keep the speed down to the point where you are well within the capabilities of your braking system.

For riding in traffic, brake safety levers (Fig. 3-2) allow braking while gripping the upper portion of the handlebars. One complaint I've heard and seen written frequently is that these levers are actually dangerous because they will hit the handlebars before effective braking can take place. I've looked over the design and arrangement of the setup on my bicycle and I don't see any way that this could happen. Regardless of brake adjustment or amount of wear on brake pads, it seems to me that if the regular brake handles will stop the bike so will the safety levers. Also, the leverage seems to be even better on the safety levers. Perhaps there are some that are not so well designed? I think part of the objection to safety levers is tradition. Of course, if maximum performance is required, the added weight of the safety levers would be a disadvantage. It takes practice to learn to apply brakes effectively for particular conditions and to get used to different types of brakes.

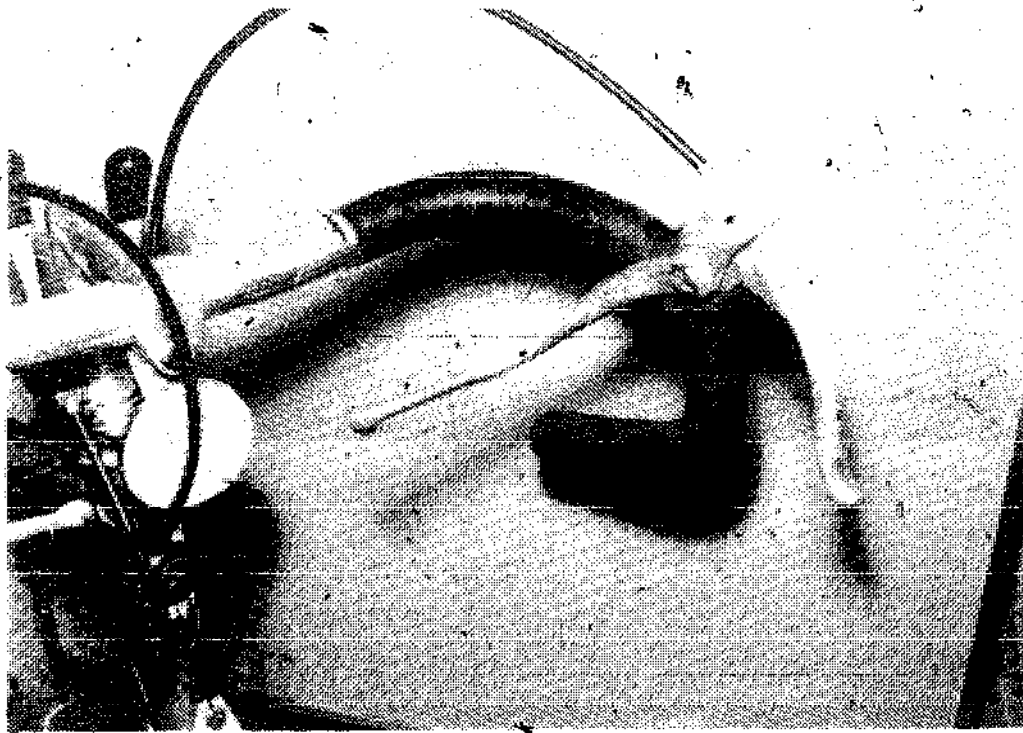

Fig. 3-2. Brake safety levers.

### **CORNERING**

Try to come into turns at a slow enough speed so that the brakes will not have to be applied during the turn.

If the bicycle has a low bottom bracket in relation to road level or long cranks, the pedal on the turning side should not be in the down position when making a sharp or high speed turn.

Avoid high speed cornering on road surfaces covered with dirt, sand or gravel. These conditions can cause sudden side-slippage of one or both wheels.

### **SAFETY**

The main cause of bicycle-motor vehicle accidents, according to one popular source, is the bicyclist violating traffic rules. If this is true, I think it is a secondary cause. The real cause, in my opinion, is that there are too many motor vehicles in the United States and in many other parts of the world and too much catering to them. However, the automobile mentality—the automobile industry creates meaningful jobs, etc.—seems to rule. All indications are that it's going to get worse with more cars, more roads, more parking lots and more pavement before it gets better—if such a day ever does arrive.

Realistically, bicycles have not been given enough consideration in the United States. Bike lanes, paths and trails have hardly made a dent. In short, bicycle riding, at least in the area where I live

and in all of the other areas where I have previously lived is truly dangerous. I wish it were otherwise and I hope that someday the situation will change and that perhaps even I can do something to help end the automobile mentality. But the simple fact is that the bicycle is no match for the automobile (Fig. 3-3).

Bicycling, as I see it, can be safe only in areas that are completely separated from automobile traffic. Taking your place on a bicycle in automobile traffic lanes is, at best, defensive bicycling.

**First Rule.** Obey traffic rules and signs. But keep in mind that most traffic rules and signs are for motor vehicles.

**Second Rule.** Keep your bicycle in good condition. The appearance of the bicycle is secondary to mechanical condition when it comes to safety. Faulty brakes are a common cause of accidents.

**Third Rule.** Use safety equipment such as reflectors and lights for night riding. These safety accessories might be required by law in the area where you are bicycling. Even if they are not, you should have equipment that will add to the safety of the kind of riding you do.

**Fourth Rule:** Whenever possible, use bikeways and bicycle paths and trails. There are a growing network of these in the United States, but some areas have none. Not only is it safer, but also a much more pleasurable experience to be able to ride completely free of worry about automobile traffic.

**Fifth Rule.** Teach your children how to bicycle safely. Make bicycling safer for them by creating riding areas and lanes that are completely separated from automobile traffic.

**Sixth Rule.** Develop safe and sensible habits. For example, watch the road for potholes, cracks, drain covers and rail tracks. Be especially careful in wet conditions. If caliper brakes become wet, dry them out by riding with light applications of the brakes so that they will be ready when you need them. Certain weather and traffic conditions make it unsafe to bicycle—especially at night.

**Seventh Rule.** Always be alert. For example, watch for opening car doors and cars parking or pulling out.



Fig. 3-3. Whenever possible, ride in areas that are free of automobile traffic.



Fig. 3-4. A Bell bicycle helmet.

**Eighth Rule.** Yield the right-of-way and show respect for pedestrians. Do this even though motorists might not give you the same courtesy.

### HELMETS AND HEAD GEAR

Figure 3-4 shows a *Bell* bicycle helmet, manufactured by *Bell Helmets, Inc.*, 2850 East 29th St., Long Beach, CA 90806. It's light, yet provides outstanding shock absorption. The outer shell is high impact *Lexan*, which was chosen for its high strength to weight characteristic. Beaded polystyrene forms the shock absorbing inner liner. Helmets and protective head gear are used not only for competitive racing, but also for safer recreational cycling.

### LEGAL REQUIREMENTS

These vary greatly across the country. Find out what they are for the area where you will be using your bicycle. City, county or state registration might be required and certain safety equipment might be necessary. Most bicycle dealers can give accurate information about the legal requirements for a particular area.

Be sure to record the serial number of your bicycle. If it is required, be sure to register your bike.

Since bicycle thefts are common, it's important to securely lock your bike. Locking bicycles is a lot of bother, but in most areas a necessity if you want to leave your bike in a public area and expect it to be there when you return.

There are two basic locking methods. The first is symbolic. Inexpensive chains or cables and locks can be used. This might discourage amateur thieves and joy riders, but will scarcely slow down a professional.

The second type of locking is more secure. Perhaps the best method is with U-shaped locks such as the *Citadel* Fig. 3-5 and *Kryptonite* brands. These locks will withstand almost anything, including boltcutters, which are used in a high percentage of bike thefts. One problem with the U-shaped locks is that you must find a suitable object to secure the bicycle to. There have been instances where bikes were stolen by cutting the objects to which they were

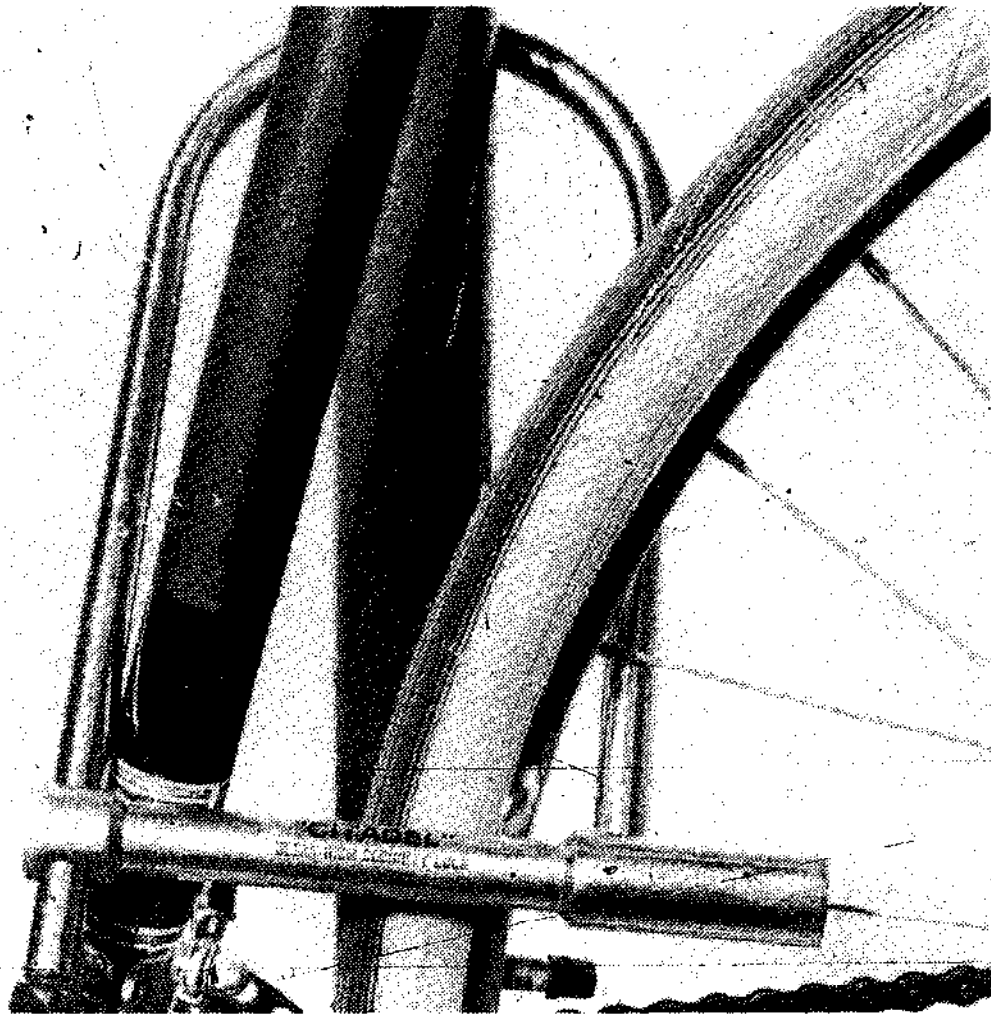

Fig. 3-5. A Citadel ultra-high lock.



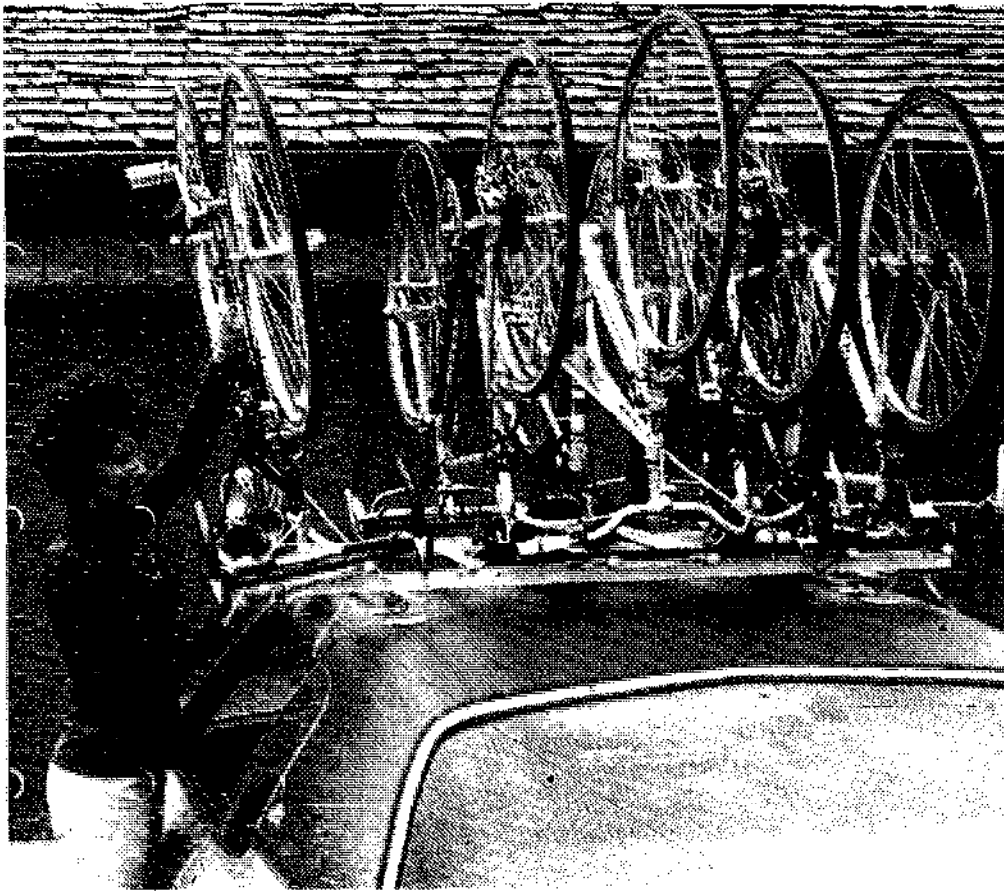

Fig. 3-6. Placing bicycles on a roof-top rack.

locked. I wonder if, in their leisure, the thieves were able to remove the locks.

The typical locking method is to remove the front wheel and then lock the front wheel, rear wheel and frame to a solid fixed object. Some lock manufacturers will pay up to a certain amount, if a bike is stolen as a result of failure of their locks to prevent theft.

When purchasing a locking system, consider how you are going to carry the lock system. Some can be attached to the underside of the saddles. Or you might want to use a small bag that attaches to the rear of the saddle.

Another method of protecting your bicycle is with bicycle insurance. Bicycles are often covered by homeowner's insurance, but these policies usually have a \$50 or \$100 deductible. Some cover the property only when it is at home.

A number of bicycle insurance policies are available. Bicycle shops generally have information about these. Rates vary, but about \$15 per year for the first \$100 coverage and \$8 for each hundred thereafter seems to be about average. These policies typically do not have a deductible. They usually cover theft, damage from accidents and some medical expenses if you are injured. The

policies have some limitations, such as the area the bicycle coverage applies to (the continental United States) and that the bicycle must be locked, registered and have annual safety inspections.

I've heard that most of the companies will immediately cancel after an insurance payoff is made. The policies that I have seen have clauses in them to this effect.

### **TRANSPORTING BICYCLES**

A number of racks (Fig. 3-6 to 3-10) for transporting bicycles on automobiles are available. The three basic types are rear bumper racks, roof racks, and rear deck racks.

These racks are useful in a number of ways. Bicycles can be transported to the starting point of a scenic ride or tour or taken along on vacations.

Features to look for in racks are the number of bicycles that can be transported, ease of getting bicycles on and off the racks, secure methods of attaching racks to vehicles and bikes to the racks and

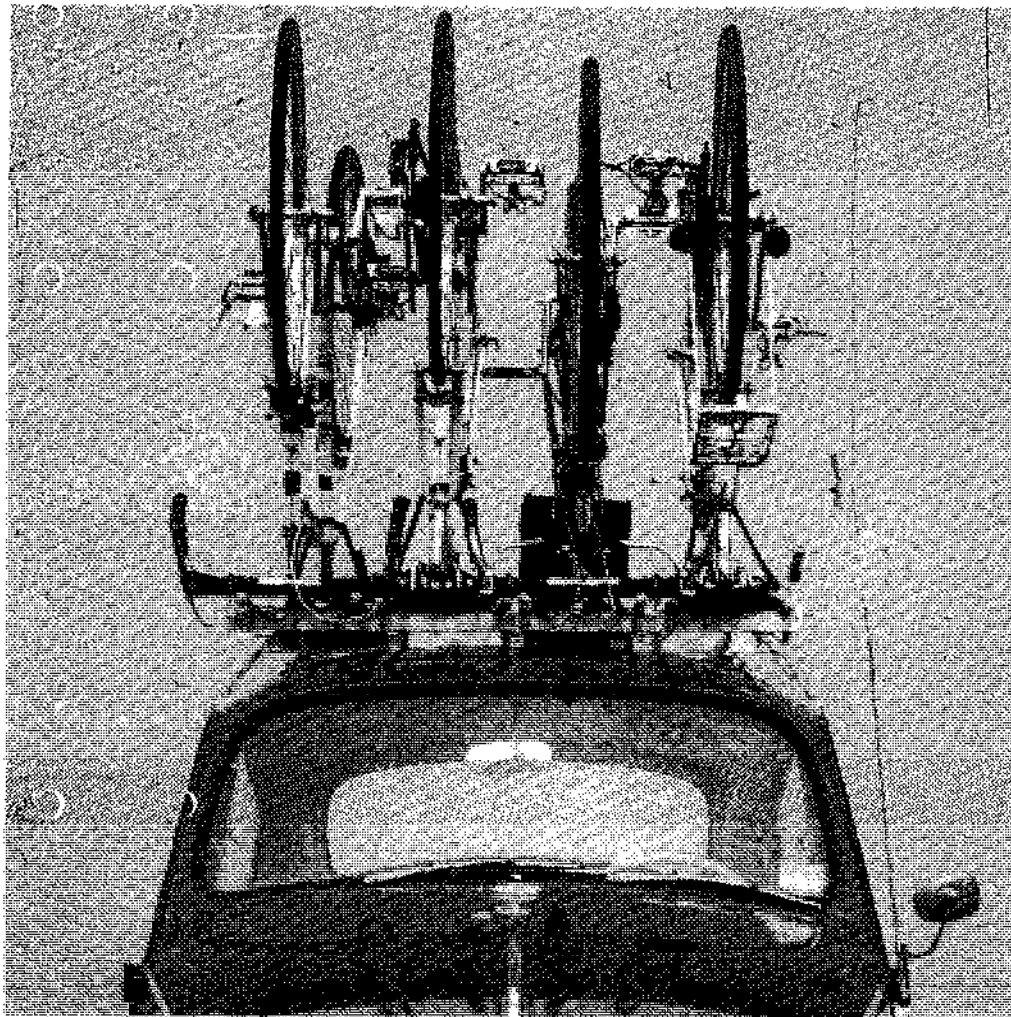

Fig. 3-7. Four bikes fit easily onto this Volkswagen.

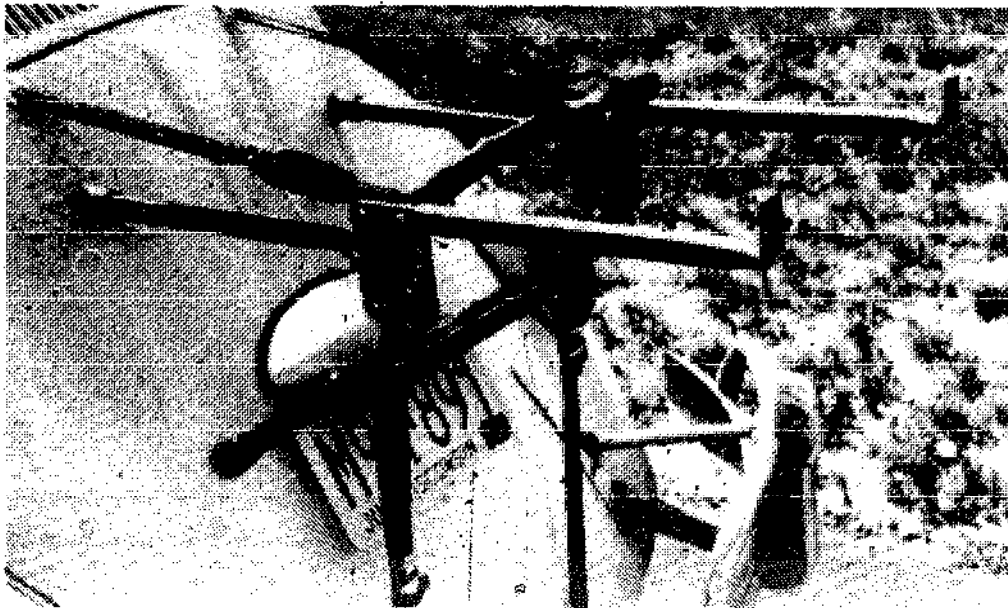

Fig. 3-8. Adjust-A-Porter shown on a Volkswagen.

protection of vehicles and bicycles from damage. Fig. 3-11 shows how easy bicycles can be placed on a well designed rear deck rack. In some cases, special protective padding (Fig. 3-12) is used.

### **BICYCLE PARKING AND RACKS**

The large increase in the number of bicycles in recent years has resulted in a shortage of good places for parking them. Well designed bicycle racks (Fig. 3-13 and 3-14) provide not only a place for each bicycle, but also something to lock them to.



Fig. 3-9. Four bicycles on a Bike-Porter.

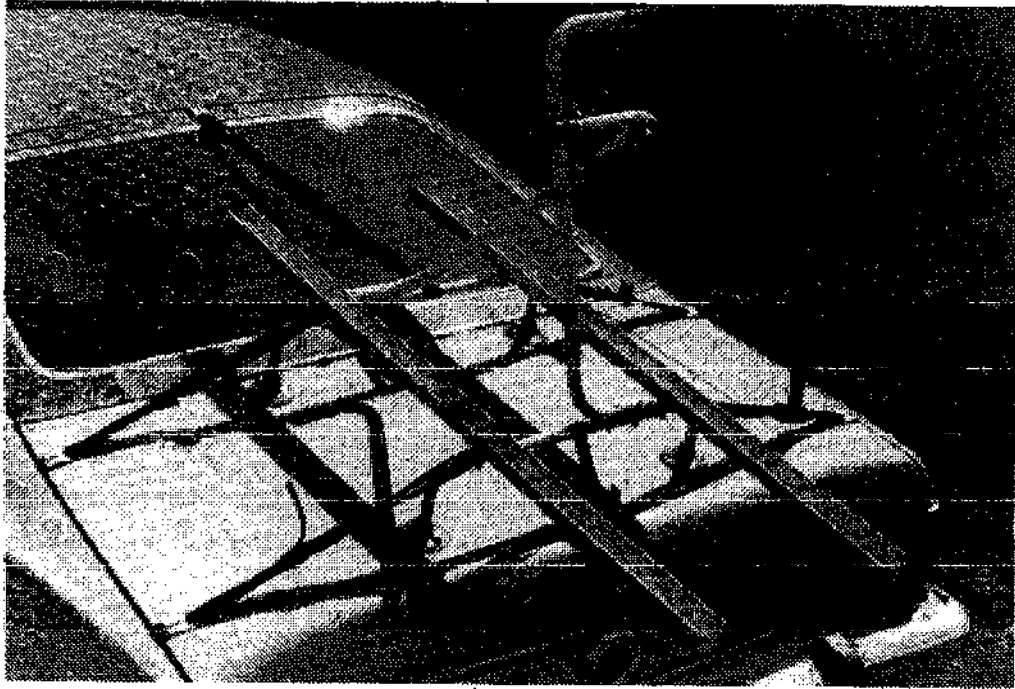

Fig. 3-10. A two-bike model Bike-Porter.

In some areas, secure bicycle parking is available for a fee. This is ideal if you commute by bicycle to your place of employment.

Coin operated bicycle parking devices with locking systems—similar in concept to coin-operated lockers—are available in some areas and are becoming increasingly popular.

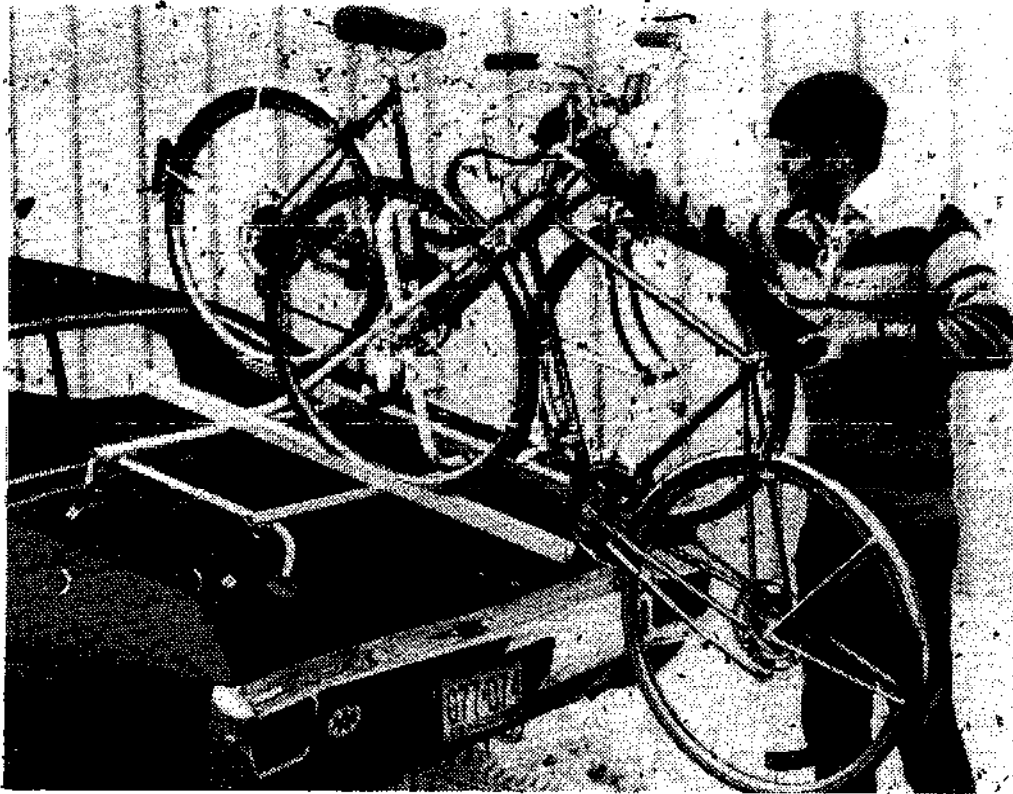

Fig. 3-11. Placing bicycles on a rear-deck rack.

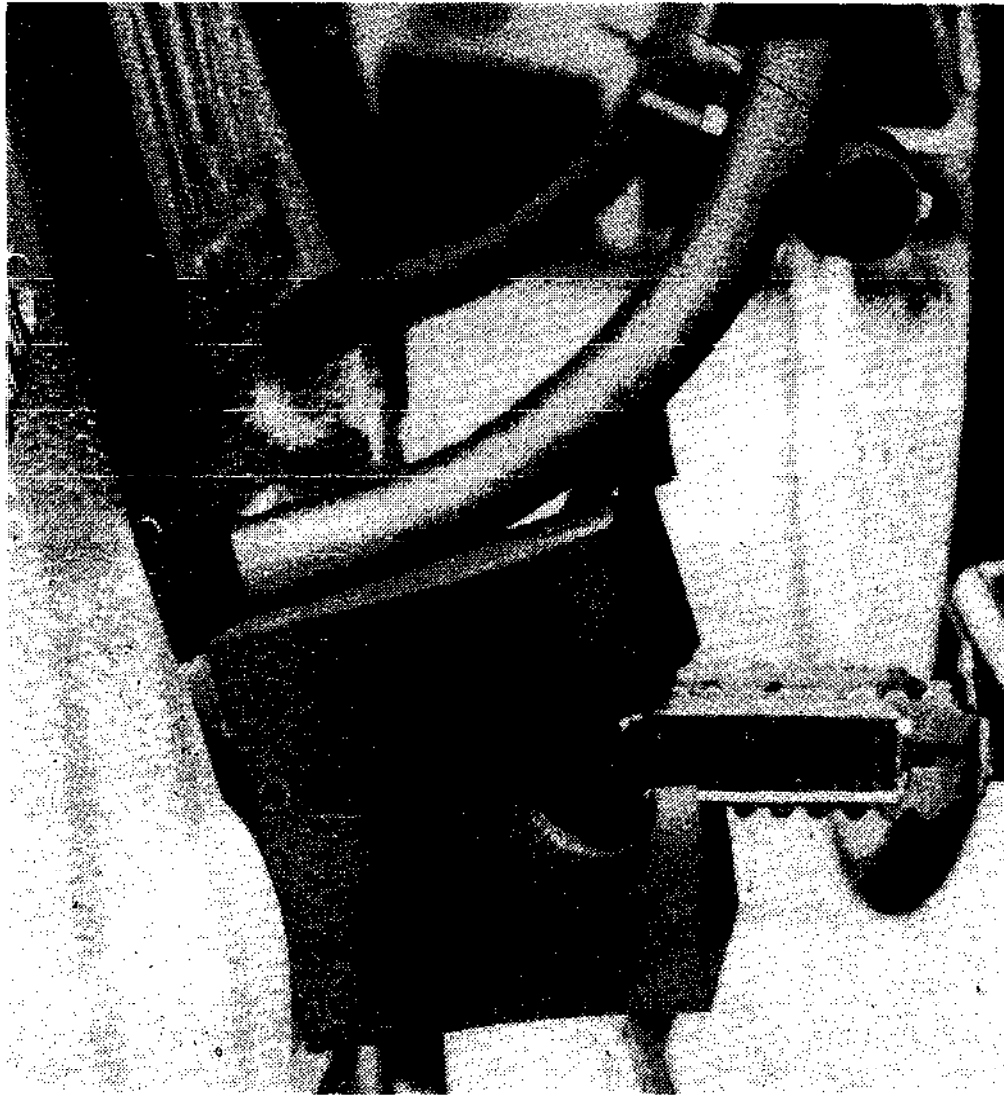

Fig. 3-12. A Protect-O-Pad can be snapped on bicycle pedals, to protect a car.

The use of the vast majority of bicycles in the United States probably falls into the utility category. This includes riding reasonably short distances for fun, recreation, fitness, shopping, transportation and even to earn money, such as is frequently done by youngsters who use bicycles for newspaper routes.

One of the most practical ways to put cycling into your life is to use a bicycle for transportation. This can reduce or even eliminate the need for motor vehicles. If conditions permit, use a bicycle as a means of getting to and from work. This allows you to exercise and save money. Also, if you live in an area that hasn't yet been ruined by the automobile, the enjoyment of fresh air and scenery is a bonus.

Bicycling is a way to go shopping too. The practicality of this varies widely from area to area. Bicycle racks and baskets, which come in a variety of shapes and sizes, will allow carrying reasonable

Fig. 3-13. Park-A-Bike rack.

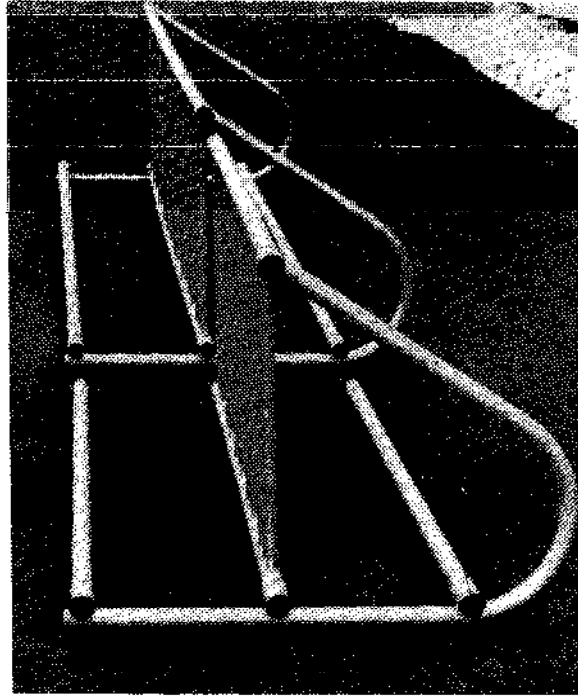

loads. And even larger loads can be carried by lightweight, two-wheel bicycle trailers. A popular one is the *Bugger*. It's made by the *Cannondale Corp.*, 35 Pulaski St., Stamford, CT 06902, and available at many bicycles shops. It can carry up to 80 pounds and it attaches to the seat post.

Bicycling is a good way for children to get to school and get exercise at the same time. Provided bicycling is safe in your area.

Cycling is an ideal family activity. There are many times when bicycles are used individually, but there are other times when the whole family can enjoy this activity together. Sunday drives in automobiles can be replaced with bicycle outings. A park, especially if it has bikeways or paths, is an ideal place (Fig. 3-15).

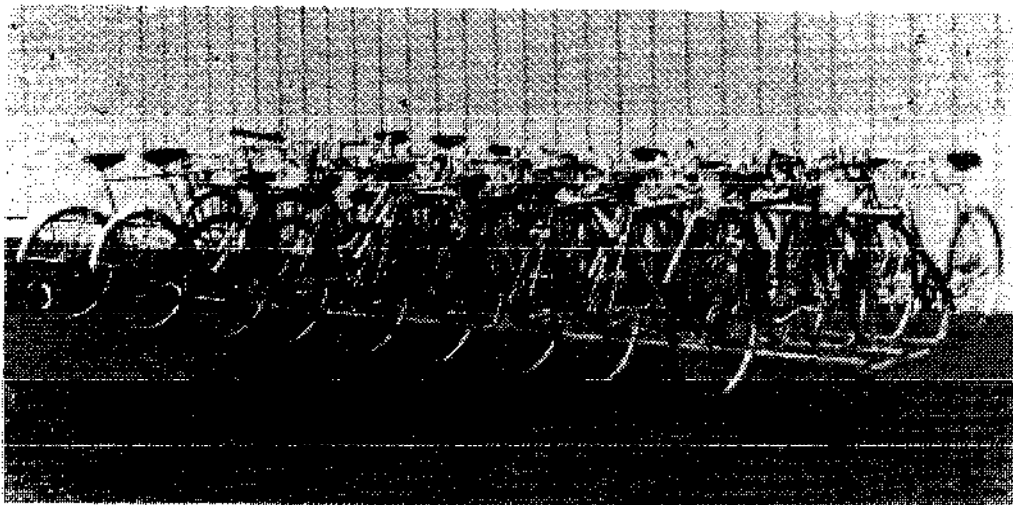

Fig. 3-14. Park-A-Bike rack allows orderly parking of bicycles on both sides.

## TOURING

This can be done alone or with other people. The trips can be as short or as long as you care to make them. Bikeways and bicycle trails and paths are ideal. So are roads with little or no automobile traffic—if such a thing exists.

- When first taking up touring, start with a trip that is well within your capabilities. Then gradually work up to more ambitious undertakings. A starting point might be a ride that can be completed comfortably in an hour. In any case, most people start with rides that take one day or less and are usually completed in the daylight hours.

A few health precautions are in order. If you are in any doubt about your health, check with your doctor before taking up cycling. And especially before touring cycling. In most cases, the risks of cycling to your health are far less than the potential benefits.

In general, start out with short, easy rides. Gradually work up to longer and more strenuous ones over long periods of time. I suggest that at first the cycling cadence be at about the same energy level as walking. Then cadence should be such that you can keep it up long periods of time, rather than bursts of intense pedaling, then coasting to rest. However, if you feel that a rest is needed, do not hesitate to stop bicycling and take one.

Wear suitable clothing. Make sure that you will be warm enough, but avoid clothing that will impede circulation such as rubber sweat suits. Jogging uniforms are ideal for cycling. They allow freedom of movement and permit good air circulation.

Avoid overexposure to sun and heat. Wear a suitable hat. Take rests in the shade and take a water bottle along. The type that fit in clamps attached to the bicycle frame are convenient and readily available at bicycle shops.

For short touring where help is readily available, repair equipment isn't essential. For longer trips, it's a good idea to have at least a simple tool kit, tire pump and tire patching kit. Advanced touring cyclists also frequently carry selected spare parts.

Some people would consider the type of riding described above as recreational riding rather than touring. For these people, touring means more than one day.

There are several basic methods. The most convenient, but more expensive, is to stay at hotels and motels each night and do all of your eating at restaurants along the way. This way, only a minimum load of spare clothing, etc. need be carried.

Similar, but less expensive, is hosteling or touring with

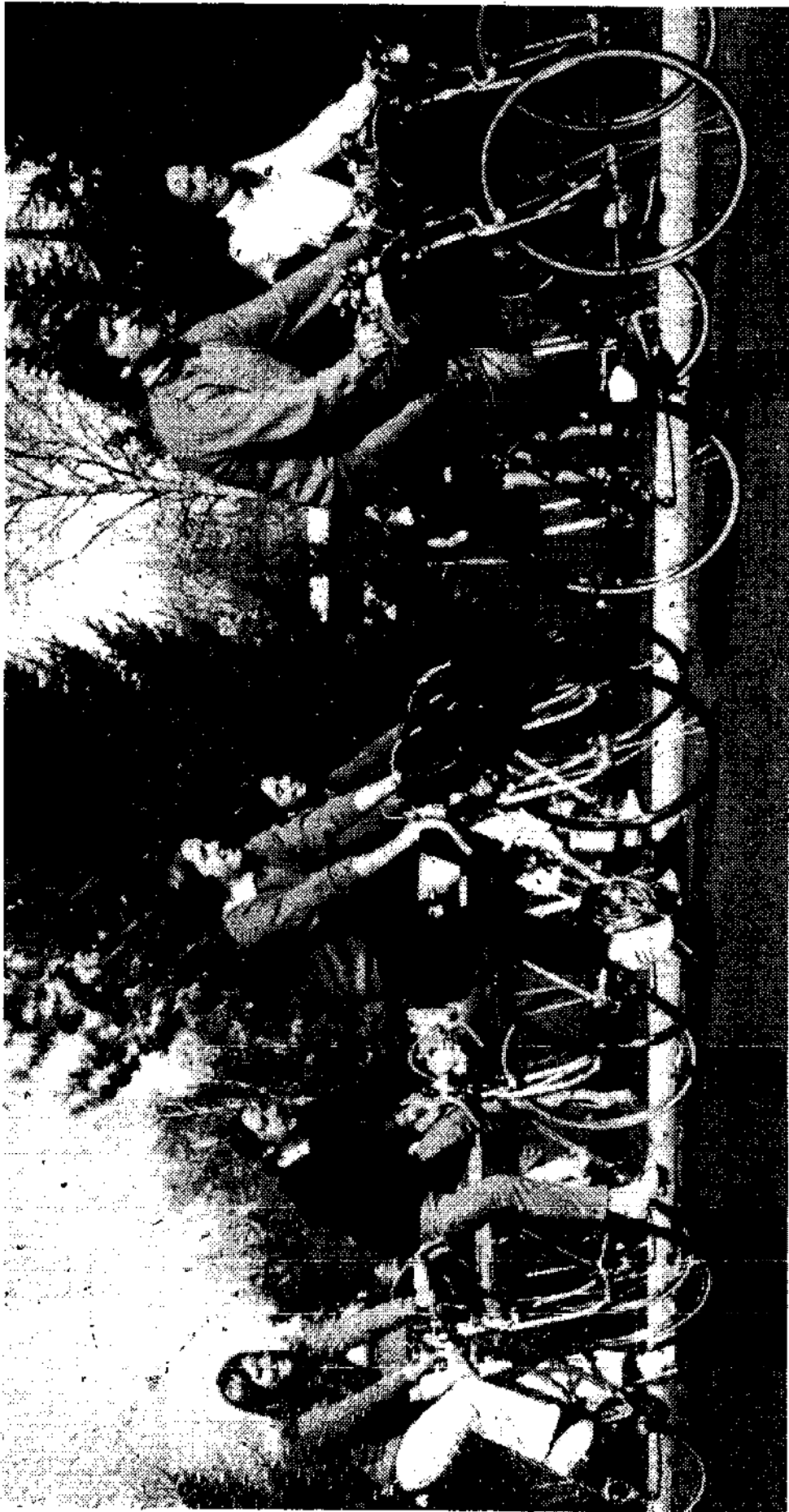

Fig. 3-15. Group riding is fun.



stopovers at hostels. These are for all ages, not just for teen-agers and young adults as the word "youth" in the organization behind the movement might imply. For information, write to: *American Youth Hostels, 20 W. 17th St., New York, NY 10011*. Their programs make individual and group bicycle travel possible at greatly reduced rates.

Another method is camping—either with a tent and sleeping bag or just a sleeping bag. Meals can be at restaurants or necessary equipment can be carried along for cooking meals.

This involves carrying along considerable equipment such as a lightweight sleeping bag, tent and cooking gear. About 40 pounds is the maximum practical total load for each bicycle. As touring bicycle campers gain experience, they tend to lighten the loads, not increase them.

As a general rule, don't carry anything on your back. Don't, for example, buy a pack for hiking and expect it to work for bicycling. Instead, use *panniers*. These are readily available in a variety of types and qualities. They can be used on a rear carrier rack, behind the saddle, forward on the handlebars and for use on a forward carrier rack.

In general, balance the load so that most of the weight is over the rear wheel. Make sure that everything is secure. It takes experience to know where to locate individual items so that what you need won't always be at the bottom of a pannier.

One good way to get started in touring is to join a club. Most areas of the United States now have these. They range from informal to highly organized. The informal are for people who prefer impromptu rides without formal meetings, dues or scheduled activities. The highly organized have many activities, including meetings, newsletters, scheduled rides (sometimes overnight or longer), bike rallies, and even extended vacation tours and trips—sometimes to foreign countries.

One large organization is the *International Bicycle Touring Society, 846 Prospect St., La Jolla, CA 92037*. They provide touring information and organize domestic and international tours for adults (no children).

Touring cyclists, both individuals and clubs, are frequently members of the *League of American Wheelmen, 19 South Bohicell, Palatine, IL 60067*. This is the oldest and largest bicycle organization in the United States. They publish a newsletter. Membership is inexpensive and open to anyone.

## **BICYCLING FOR PHYSICAL FITNESS**

Bicycling provides physical fitness activity regardless of whether or not it is done only for this purpose. There is a trend today to take up activities mainly for the purpose of physical fitness. Some people are most motivated to keep up physical fitness activity if they do something that they enjoy for itself, not because it's something they have to do to get fit. For these people, I suggest a lot of long recreational rides and touring.

For those who want an extensive fitness program, I suggest Dr. Kenneth Cooper's Aerobic Program. His books are readily available in libraries and bookstores. Prescribed programs with point systems are included for a number of activities, including cycling.

While opinions vary greatly over what type and how much exercise is best for physical fitness, the general trend of expert opinion seems to be that endurance type of fitness is most important from a health point of view. This is best developed by a moderate level of exercise that can be sustained over a long period of time. This is sometimes described as continuous rhythmical exercise.

Some bicyclists go to the extreme and use training programs that more closely resemble racing training than recreational or touring riding.

## **DOING YOUR THING ON A BICYCLE**

Many people have taken around-the-world bicycle trips or trips from Alaska to Ushuaia, Argentina—at the tip of South America.

While it's becoming increasingly difficult to think of something that hasn't been done before, there's no reason why your trip has to be something new. There's also the possibility of using novelty and specialty cycles. Some of the possibilities are covered in later chapters.

## **RACING**

The first six-day bicycle race was held in New York's Madison Square Garden in 1891. The winner was Bill Martin. He pedaled 1,466 miles in the six-day event.

This was not, however, the first bicycle race. Hardly had the bicycle been invented before the racing started. The bicycle had to prove itself in races against horses.

Today, bicycle racing is a well developed sport and extremely popular in many parts of the world. But not the United States. However, it's becoming more popular here too. There are now some world class competitors in this country and more and more

youngsters are taking up the sport. This seems to be a necessity if there is to be any hope of Americans ever excelling on the international level.

There are two main types of races and racing bicycles—road and track. Fig. 2-12 shows a road racing bicycle. Notice that it is a 10-speed. Fig. 2-13 shows a track racing bike. This has a single-speed fixed, non-freewheeling drive. Within each basic type there are many variations that depend on, among other things, the particular racing event and the preference of the rider.

Racing is a vast subject. A large book could barely begin to do justice to a single specialized type of racing. The attempt here is to present a brief general introduction and suggest ways you might get started if you think you are interested in becoming a racing bicyclist, a coach or even a spectator or fan.

Road races are done on roads from point A to B or on laps around a course. Some of the races are quite short and others are quite long—up to 150 miles or so. Some, like the *Tour de France*, are done in stages. About 100 miles are covered each day. There's even *cyclo-cross* which is done over varied terrain. This combines cycling with cross-country running. The cyclists frequently pick up their bicycles and run with them. A massed start is used when the racers compete against each other. The first to cross the finish line is the winner.

Another type of racing is called time trials. Here, the competitors race against the clock. The best time wins. There are also team events where team members pace each other to faster times by trading off the lead position.

While road racing is typically done outdoors, track racing is done both indoors and outdoors on a special track that is shaped like an oblong bowl.

There are many different events. Some are time trials, some are regular races with two riders competing against each other and still others are pursuit races. In pursuit races, individual riders or teams of riders start on opposite sides of the track and try to catch the other rider or team of riders over a prescribed distance. Usually, this doesn't happen and it's the rider or team of riders who have the fastest time who win. Many distances and variations are used.

One factor that has limited track racing in the United States is that there aren't many tracks. They are expensive to build.

So how can you get started in racing? I think the best way is to join a bicycle racing club. These are in most areas of the United States. One way to find out about them is to go to a bicycle dealer

who handles racing bicycles. Another way is to write to the *Amateur Bicycle League of America, PO Box 669, Wall Street Station, New York, NY 100051* and request information about racing clubs in your area.

I suggest that you join a club before you purchase a racing bicycle. There are many different types of racing bicycles and usually the clubs can offer good advice on this.

Most racers train for a specific type of racing. Such as speed events or endurance. Strategies must also be learned.

Be forewarned, however, that racing differs considerably from touring. Racing is to win and you will soon find out what that takes.

## Basic Bicycle Mechanics

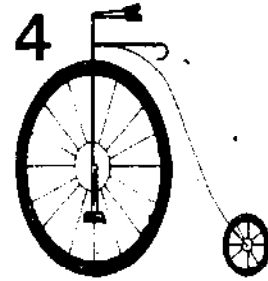

This chapter is intended as a general introduction to bicycle mechanics with emphasis on tools, shop equipment, work areas, parts and supplies. These procedures are mainly related to regular bicycles but they apply to novelty and specialty cycles as well. Exceptions and additional mechanics are covered in the chapters on novelty and specialty cycles.

### TOOLS

You might already have many of the tools you will need for building, maintaining, and repairing bicycles. In addition to regular tools, such as those normally found around the home and for automobile repair, some special bicycle tools will also be needed.

Money can generally be saved in the long run by purchasing top quality tools made of heat treated alloy steel.

For best results, keep tools clean and organized. After using a tool, wipe off dirt and grease with a cloth. Keep tools together in a toolbox or on a peg board rack. Keep sets of wrenches, such as sockets, Allens and so on, together. Avoid using tools for purposes other than those for which they were designed. Time spent keeping tools clean and in order will actually save time in making repairs.

For most routine servicing and maintenance of bicycles, only a few tools are essential. However, these will need to be selected carefully. Not having the right tool for the particular job is one of the greatest pitfalls in mechanics. Pliers, for example, make very poor substitutes for wrenches and almost the right size wrench is not the same thing as having the right size. It can be a most frustrating

experience to start on a job, get part way through it and then find that you don't have an essential tool.

- While regular mechanics tools will suffice for many jobs, you will probably want to have at least a few tools designed specifically for bicycle use. Some of these look much like regular tools, but have features that make them more convenient. For example, it might have all sizes needed for a certain job on a single tool or be shaped to fit in areas where an ordinary wrench won't.

For touring, you will probably want to have a lightweight, portable tool kit such as one in a small case that straps to the saddle. *Mafac* is one good brand. Make sure that everything you need for your bicycle is included. Before buying, try the wrenches on your bicycle to see that they fit. The kit should also have the materials and tools for patching tubes and some spare parts such as repair link for the chain, extra pads for caliper brakes and spare control cable wire. It is also a good idea to have a tire pump, preferably with a built-in pressure gauge. Make sure that it will fit the valve stem arrangement on your bicycle and that spare tubes, if carried, have the same arrangement.

For at home use, you will probably want additional tools. The advantage is that weight and size do not have to be so carefully considered as is the case with the tools you take along.

For shop tools designed especially for bicycles, I highly recommend those made by the *Park Tool Company*, 2250 White Bear Ave., St. Paul, MIN 55109.

**Crescent Wrenches.** The crescent wrench is often thought of as a tool that will replace dozens of wrenches. However, I believe that it is a poor substitute. However, it is much better than pliers for use as a wrench. Crescent wrenches vary greatly in quality and the low quality ones—especially those with play in the parallel flats or fingers—should be avoided. They can loosen or slip and this can damage the nut or bolt. Generally, crescent wrenches should be used only when a more suitable wrench is not available. However, if you have only a limited tool kit, they can be extremely valuable for fitting odd sizes.

Overall length of typical crescent wrenches vary from about four to 18 inches. A six or eight inch length will generally have the most utility as a bicycle wrench, but when possible, have several sizes on hand. Each has a maximum expansion and some might be too wide to fit certain work spaces.

**Pliers.** Pliers do have their uses in spite of the fact that they, along with the hammer, are probably most often used for the wrong jobs—especially by amateur mechanics. Pliers should not, except in

an emergency, be used as wrenches. They will quickly damage the corners on nuts and bolts.

The proper uses of pliers include bending, crimping and cutting. There are many types of pliers. The most useful of which are gas pliers (commonly referred to as just "pliers"), vise grips, channel locks and needle-nose pliers. There will be times when all of these will be useful for bicycle work, so have as many different types as possible.

**Open-end and Box Wrenches.** These are available separately or in sets. The sets usually offer a savings over purchasing the same wrenches separately. The sizes, measured as the distance between the parallel flats or fingers that fit on a nut or bolt, are commonly stamped on the ends of the wrenches.

Japanese, European and some American bicycles require metric wrenches. Usually a range of from 8mm to 20mm will be adequate. Some American bicycles, especially inexpensive models, still use fractional or inch sizes.

Wrenches from five-sixteenth of an inch to three-quarters of an inch will handle most non-metric jobs.

Box wrenches generally provide a more secure grip than open-end wrenches. Box wrenches with six-point and twelve-point openings are available. The six-point provides superior gripping, while the twelve-point provides a shorter swing. This is an advantage when working in tight places.

Since open-end wrenches contact the nut or bolt only on two flat sides, they must fit well or they might slip and round off the points on the nut or bolt. Provided that you have good wrenches of the proper size and the nuts and bolts have not been previously damaged, open-end wrenches are usually quite satisfactory. There are places where they can be used when box-wrenches cannot.

**Socket Wrenches.** These are ideal, but expensive. They are convenient to use and with a ratchet handle they are fast. For doing work on your own bicycle, the cost of purchasing these tools must be carefully weighed against their usefulness to you. In most cases, open-end and box wrenches are first priority. After you have these, a socket wrench set should be available. They are available in both metric and inch sizes.

**Allen Wrenches.** Many bicycles have Allen head bolts, with 5mm and 6mm (distance across hex-shaped holes) being the most common sizes. Allen-head bolts are most common on more expensive bicycles. On many inexpensive bicycles there are not any of these. Some bicycles with Allen-head fastenings use a single size such as 7mm, throughout.

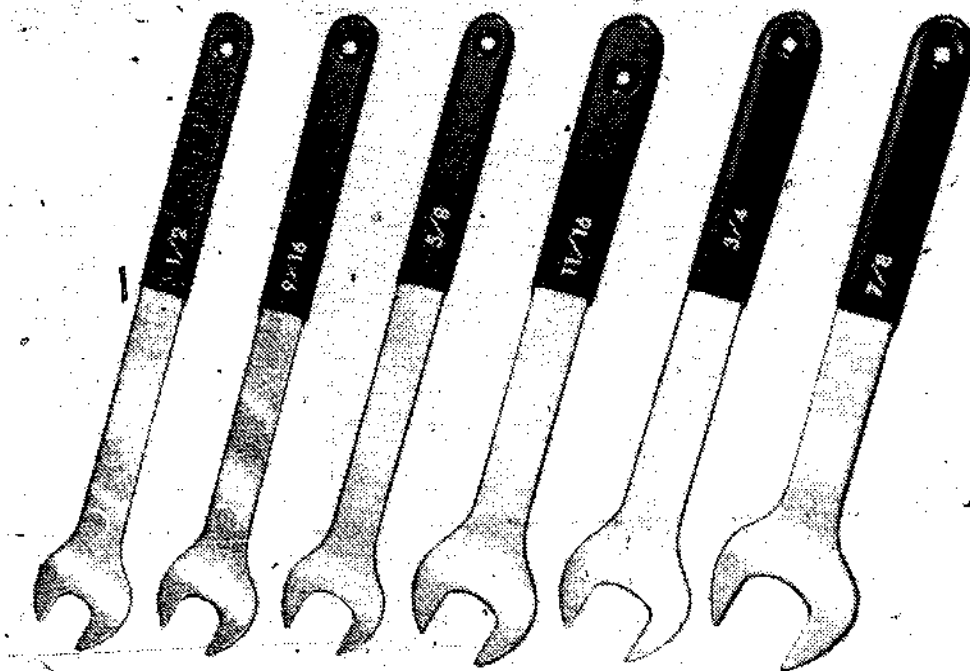

Fig. 4-1. Fractional-size cone wrenches for use on hub cones and lock nuts.

**Bicycle Wrenches.** Special flat bicycle wrenches, commonly called *cone wrenches*, are essentially extra thin open-end wrenches. As the name implies, they are designed especially for use on hub cones and lock nuts. Fig. 4-1 shows a set of fractional cone wrenches. Figure 4-2 shows a metric set.

There are also special wrenches for caliper hand brakes, derailleurs and so on. These are more suited to the needs of professional bike mechanics than for working on your own bicycle. Special bicycle wrenches with a number of open-end and box openings in the same tool are inexpensive and will generally serve the same purpose as the more expensive wrenches. A typical wrench would fit the pedals, cones, locknuts, saddle and handlebar clamps and brake-shoe pad nuts. These wrenches are also commonly included in bicycle repair kits.

**Spoke Wrenches.** These are used for tightening and loosening spokes. They can be purchased at bicycle shops and are often included in tool kits. While it's often possible to get along without these, they will be needed if you want to true a wheel or replace a broken spoke. There are several sizes so make sure you get the size that fits the spokes on your bike.

**Screwdrivers.** Two basic types used are the common screwdriver and the Phillips screwdriver. Both types come in various sizes. The correct size to fit the slots in the screws must be used or damage will occur to the screw head or screwdriver blade.



Both types of screwdrivers can be purchased in sets. Always use the correct size for the screw and hold the screwdriver in line with the screw. Avoid using screwdrivers as prying and scraping tools or as chisels or punches.

**Cable Cutters.** These are useful for cutting brake and derailleur control cables. Select the type with V-shaped jaws that will shear the cable evenly. Wire cutters that flatten the cable make it difficult or impossible to thread cable into the housings.

**Tire Levers.** You will need several of these of the small sizes especially designed for bicycles. The kind with notches that fit over spokes, holding the tire bead off the rim, are generally most convenient to use.

**Chain Tools.** These are special tools for removing rivets from chains. They are inexpensive and almost a necessity for derailleur chains. This is another tool that is frequently included in portable tool kits.

**Other Special Tools.** One solution is to invest several hundred dollars for a professional *Campagnolo* tool set and be done with it. However, unless you are really going to be a professional mechanic, the cost makes this impractical. In fact, whenever money is a consideration, the cost must be weighed against the usefulness.

There are a number of other special tools that are either essential for doing certain tasks or else make the jobs easier or

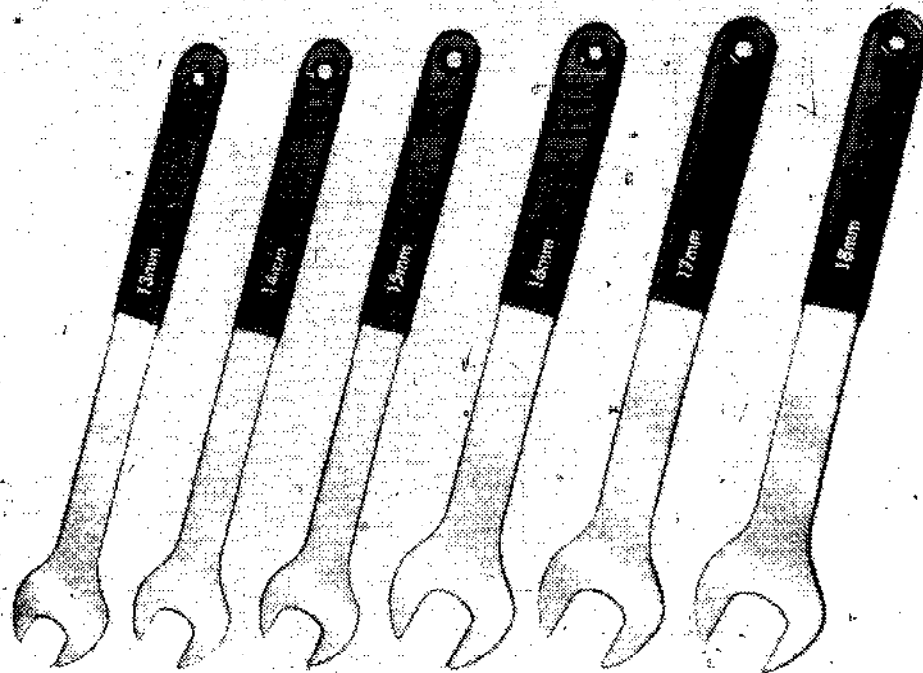

Fig. 4-2. A metric set of cone wrenches.

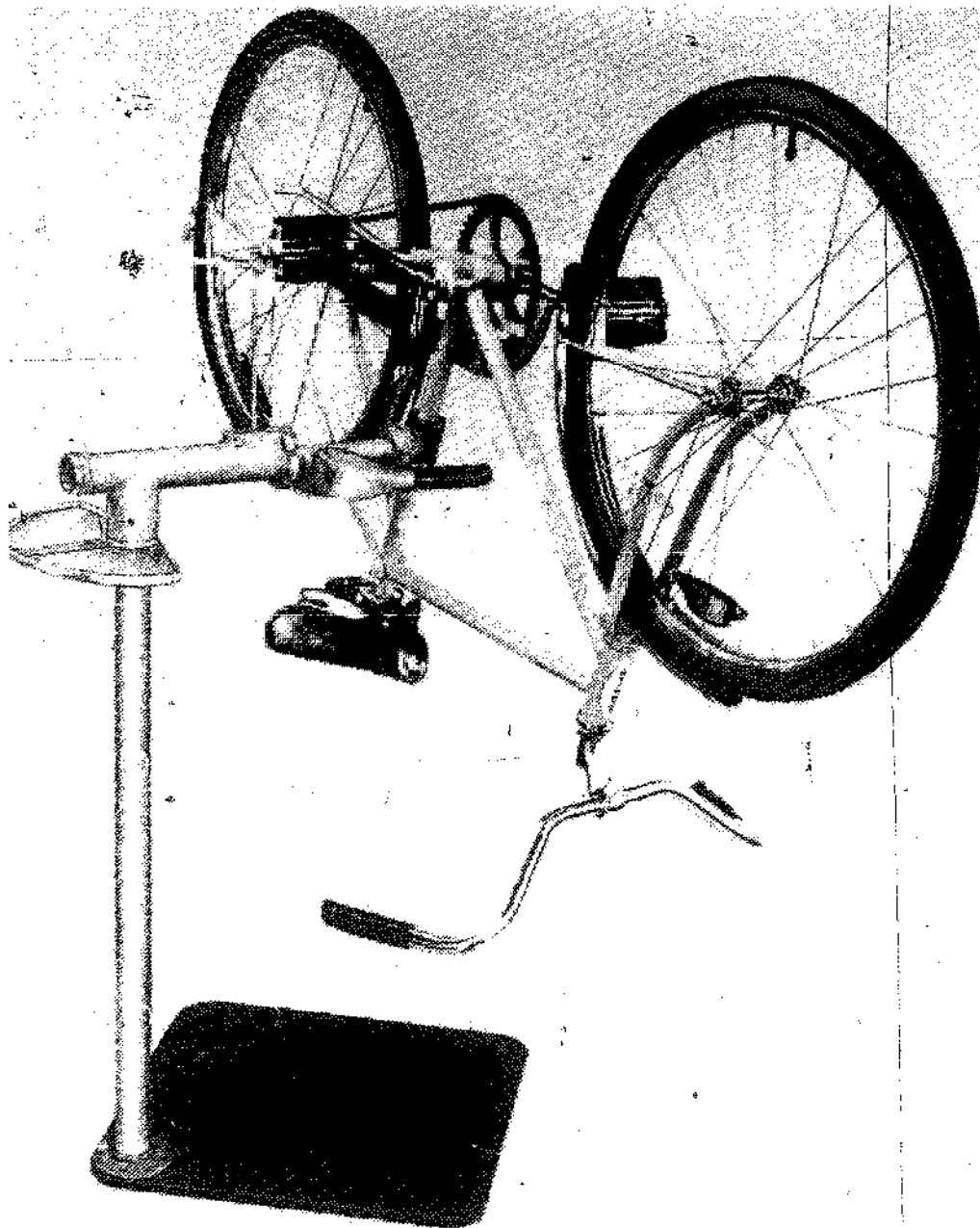

Fig. 4-3. This cycle stand holds one bicycle.

faster. Among these are tools for removing freewheels from the hubs, brake arm clamping tools often called "third-hands") and tools for removing cotters from pedal arms. These, as well as other special tools are described along with their uses in later chapters.

Some of the more expensive tools are sometimes purchased by bicycle clubs for use by the members. For something like a wheel alignment machine this is an ideal way to spread out the cost.

While it might sound like there are an endless number of bicycle tools, only a few tools are required to disassemble and assemble everything on a particular bicycle. Of course, they must be the right tools and sizes.

Other useful tools include hammers, files, hacksaws, drills, screw extractors, center punches, dies and taps. These tools will not ordinarily be required for simple disassembly and assembly for lubrication and parts replacement. They are only for more advanced mechanics.

Here are a couple of examples of how these tools can be used. Dies and taps are handy for cleaning up damaged threads on bolts

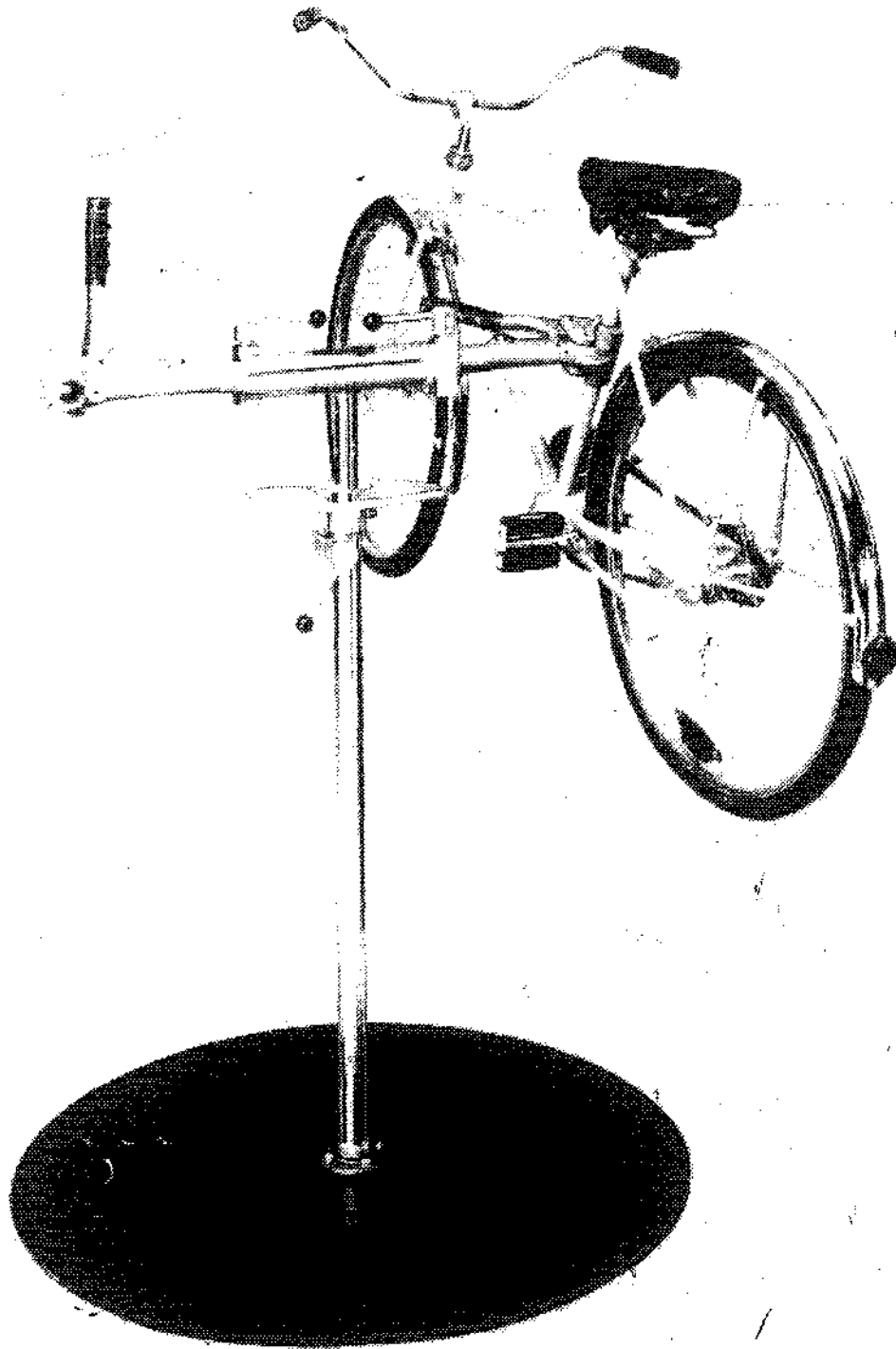

Fig 4-4. This cycle stand holds two bikes

and nuts. A drill and tap extractor can be used for removing broken bolts. Use a center punch first, then drill a small hole in the center of the broken bolt. Tap the extractor into the hole with a hammer. Use a wrench on the extractor to turn it to remove the broken bolt. A good solid work bench with a heavy-duty vise is extremely helpful.

## MAINTENANCE STANDS

These go by a variety of names such as repair racks, tune up stands, and so on. Their purpose is to hold bicycles firmly off the ground so that repairs and adjustments can be made. They allow working the pedals by hand and operating the shift and brake controls. Many of these racks allow positioning the bicycle almost any way you want it for a particular job—such as right side up, upside down or at a certain angle. The racks hold the bicycle so that your hands are free to do other things.

One way to get along without a rack is to simply turn the bicycle upside down and balance it on the saddle and handlebars. However, bicycles placed in this manner tend to fall down. The bicycle is too low for convenient work and this can be damaging to caliper brake control cables.

A maintenance rack is almost essential for the serious bicycle builder and mechanic and also a good bet for even the one-bike owner. Of course, the price and quality of the rack can vary accordingly. A self-supporting professional type stand for one bike at a time is shown in Fig. 4-3. A two-bike model is shown in Fig. 4-4. Figure 4-5 shows a stand with another type base.

Where conditions permit, a floor mounting plate (Fig. 4-6) attached to the floor eliminates the need for a large heavy base. The one shown is for a *Park Cycle Stand*.

The stand is made by *State Aluminum Foundry, 15532 Illinois Ave., PO Box 987, Paramount, CA 90723*. It can be quickly and easily disassembled for storage. This makes it ideal for home use.

A stand that's designed especially for home use is shown in Fig. 4-7. It is made by *Willmarths, 1011 Avenue B, Redondo Beach, CA 90277*. The rack folds flat for easy storage as shown in Fig. 4-8.

If you have a suitable place for attachment, the wall attachment and cycle clamp will save you the cost of the floor stand. You can also improvise a base for this clamp by mounting a wood or metal post in concrete set inside an automobile tire.

Another possibility is to improvise your own stand, including the clamping device. The jaws should be padded to prevent marring the bicycle finish.

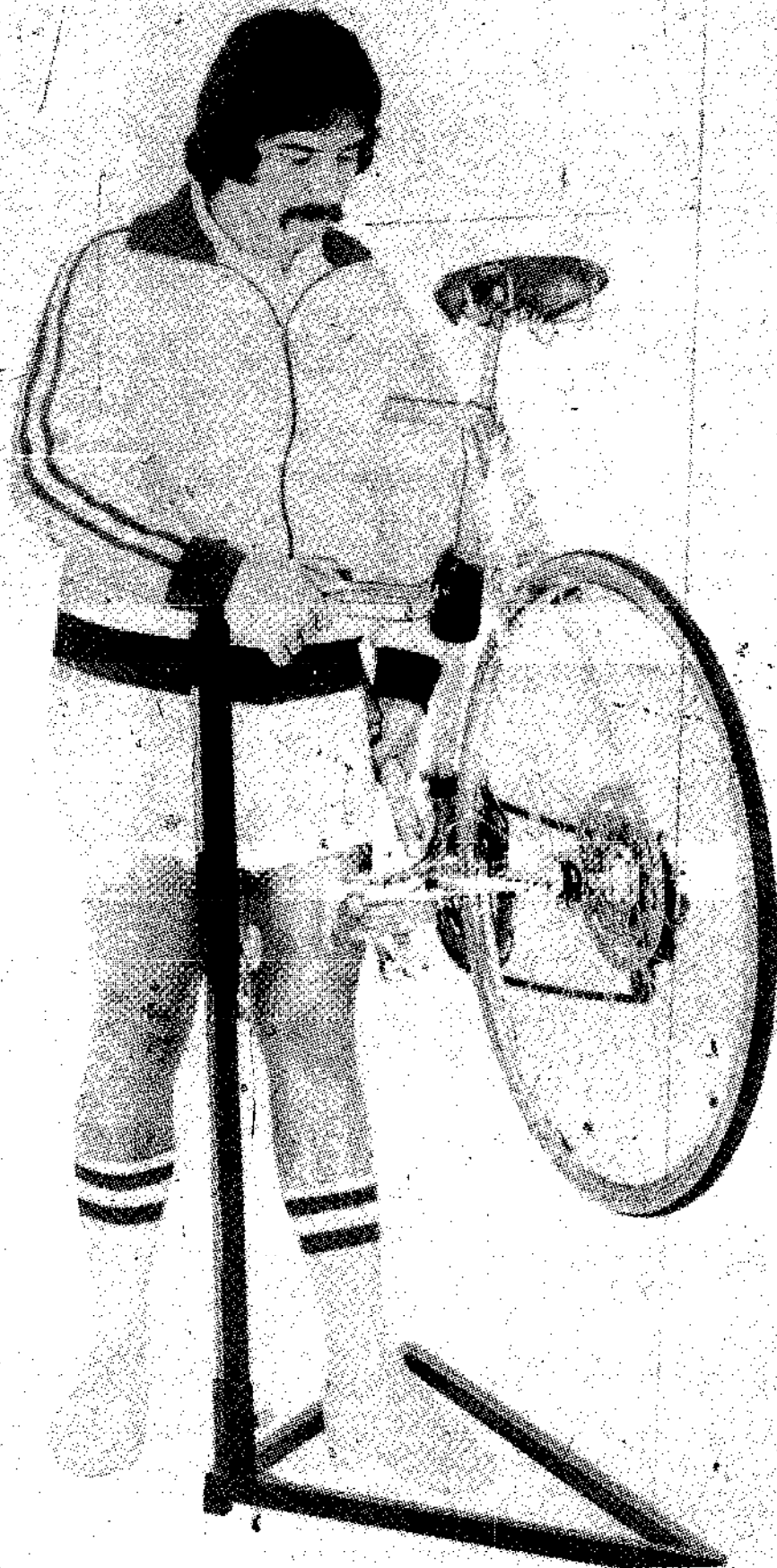

Fig. 4-5. Clamping a bike on a stand.

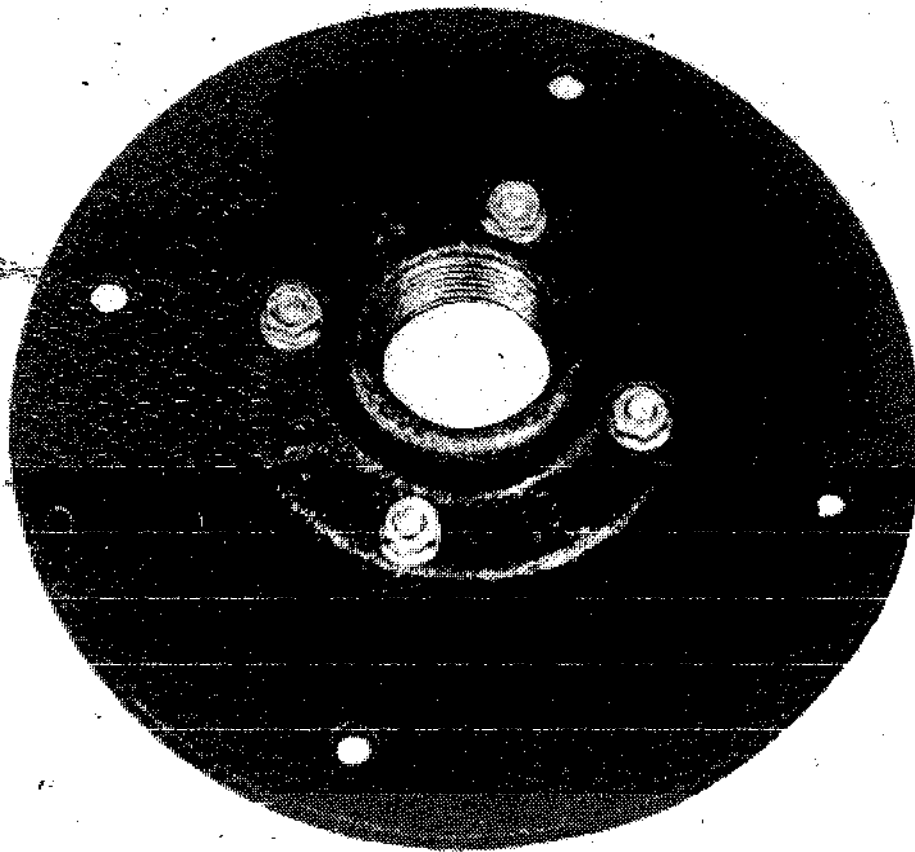

Fig. 4-6. Floor mounting plate for a cycle stand.

### **CLEANING PANS AND SOLVENTS**

Cleaning pans can be purchased at automotive supply stores. Of course, any suitable sized containers that will withstand the use of solvents will do.

Kerosene seems to work well as a cleaning solvent. Special solvents that work similarly are also on the market. These can be purchased at automotive supply stores and sometimes at bicycle shops. Service stations frequently carry kerosene or other solvents.

However, **never** use gasoline. If you do, you might never have to worry about cleaning a bicycle again.

### **SUPPLIES**

You will need a supply of rags, cleaner, polish and wax suitable to the finishes on your bicycle. You will also need grease and oil lubricants. The types needed for a particular bike vary and recommendations are made in the following chapters.

### **PARTS**

It is generally easiest to make replacements with the same brands and models of parts that were used previously. If these are not available, it is sometimes possible to substitute other brands.

If one part of a component is damaged, it might be best to replace the entire unit—especially on inexpensive items. On more expensive components, it is often worth the trouble to replace only the part that is causing the difficulty.

A number of what are called universal replacement parts, such as caliper brakes and shift changers can be useful. *Universal* in this context means that they will fit several or even most brands of bicycles that use similar components, rather than all bicycles.

In the ordinary course of maintaining most bicycles, you will probably want to stick to new parts for replacements, but there might be times when used parts will serve your purposes just as well and save you money.

Many bicycle dealers have large stocks of bicycle parts. Another possibility is to order by mail. Here are a few well known firms, along with the approximate prices of their catalogs. Some of these refund the price of the catalog on the first order.

—*Big-Wheel Ltd.*, 340 Holly St., Denver, CO 80221 (\$2.10).

—*Cycl-Ology, Wheel Goods Corp.*, Dept. D, 14524 21st Avenue North, Minneapolis, MIN. 55441 (\$2.00).



Fig. 4-7. This stand, made by State Aluminum Foundry, is easily disassembled for storage



Fig. 4-8 A Willmarth bike stand for easy use at home.

—*Cyclo-Pedia*, Dept. B, 311 N. Mitchell, Cadillac, MI 49601  
(\$3.00).

### SOME BASICS

Before going into the basic routine maintenance of bicycles, a few basics are in order:

Some lubricating tasks require that you disassemble parts, clean them, apply lubrication and then reassemble them. This is commonly called an *overhaul*. The first time you do this it will probably be the most difficult. Usually after that it will be quite routine.

Some bicycles come with maintenance manuals complete with schematics. These can be a big help. If you don't have a manual for your particular bike, try to get one from the manufacturer.

To learn the workings of a particular bicycle, study the bicycle as you read about it. It helps to have the bicycle in a maintenance rack. You'll probably be interested mainly in your particular bike, so when reading through the maintenance portion of this book, you might want to skip over the sections that don't apply. For example, the section on derailleur gears if you have a single-speed. Or you might want to read everything to compare other bicycles to your own.

Before starting any job, make certain you have all the tools and supplies that you will need and that spare parts are available.

The components of a bicycle are connected by various types of fasteners. Many of these are especially designed for specific bicycle uses.

The most common types of fasteners used are nuts and machine screws. They include what are commonly called bolts. In order to join a nut and bolt, both the diameters and thread pattern must match. When the threads are in good condition, the match up can be tested by turning the nut on the bolt by hand. If this cannot be done and the threads are not damaged, you probably do not have a matched set.



Machine screws have various head types that include hex, flat, oval and round. Openings for turning tools include slotted, Phillips and Allen.

Several types of nuts are used on bicycles. The most common are ordinary nuts, self-locking nuts and wing nuts. Two types of washers—flat and lock—are frequently used on bicycles.

When making replacements in fastenings, it's a good idea to take the damaged or broken ones with you to the hardware store or bicycle shop so that you can get exact matchups. While substitutes can sometimes be used, it's generally best to stick with the same size and type used previously.

Bicycles also have a number of fasteners that are of special design to serve more than one purpose. For example, they can form a bearing cage in addition to holding an axle in place.

## Bicycle Maintenance

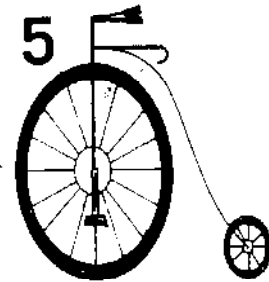

I'm going to say something different than most books on bicycling. Unless you really want to do more, do only the minimum amount of caring for and maintenance necessary to keep your bicycle in safe operating condition. This might sound odd from someone who enjoys working on and building cycles, but I really feel that this is good advice.

For most people, it's the use of the bicycle not the satisfaction—or lack of satisfaction—of working on a bike that counts.

A bicycle is a very forgiving machine. Considering the relatively low cost of the investment, why make yourself a slave to something if you don't enjoy it? For ordinary riding, the differences between a long, time consuming maintenance program and a minimal one is likely to be slight—at least from a practical point of view. Of course, if you enjoy working on your bicycle and keeping it shiny and new looking, then by all means do so. Regardless, do at least enough maintenance—or have it done for you—to keep the bicycle in safe operating condition.

Keeping the bicycle stored out of the weather, dry, waxed and properly lubricated is only common sense. But to what extent you do this is a highly individual matter. There are many happy riders of rusty wonders. A shiny new-looking bicycle is not essential to everyone.

Another kind of care is how the bicycles are ridden and used. A fine lightweight bike generally will not survive curb jumping. How-

ever, for the young this is part of living. You can get a bicycle that is designed and constructed to take this sort of thing. As a minimum, I recommend that bicycles be kept in safe operating condition.

A primary concern is lubrication. How often, what kind and how much lubricant to use are frequently debated subjects. The three basic lubricants I recommend are a light bicycle oil, a bicycle chain oil and a multi-purpose bicycle grease. In describing each lubricant I have used the word bicycle. By this I mean that you buy them at bicycle shops and that they will have the word *bicycle* on the containers. You might be able to buy the same thing somewhere without the word bicycle for less money.

Ideally, a number of tasks should be done monthly and more often if the bicycle is ridden extensively—less often if the bicycle is used infrequently.

First, clean the bicycle. It is especially important to wipe dirt and excess lubricants off with a cloth. This takes such a short time and is so important to the on-going maintenance of a bicycle that many bicyclists do this every time they finish a ride.

Oil everything that requires oil that can be done externally without disassembling the bicycle. This includes hubs with oil fittings.

Wax the bicycle.

Those three steps take care of the monthly tasks. Except that a number of components, especially brakes and derailleurs, should be adjusted whenever they are not functioning properly. In addition, a number of assemblies need to be taken apart, cleaned, greased and reassembled at six months and one year intervals. The tasks for six months are the front hub, head set and pedals. Once a year, do the rear hub and crank set. In addition, the freewheel should be removed from the bicycle, cleaned and oiled every six months. The above maintenance schedule is intended only as a rough guide. If you don't do these things, probably nothing serious will happen. If you do them, your bicycle will probably last longer, perform better and look better. Is the difference worth it? Each individual must answer that question.

### **MONTHLY OIL MAINTENANCE .**

While most bicycles probably receive too little or no oil, a few receive too much. Too much oil can be as bad as not having enough. In other words, apply oil sparingly. Then wipe off excess with a cloth. Extra oil will not be where it can do any good and will only serve to pick up dirt and grit.

An oil can with a small nozzle will make application convenient. I recommend a light bicycle oil and a bicycle chain oil. Always follow the specific instructions that come with the particular bicycle.

**Front Hubs With Oil Fittings.** Squirt in about one-half teaspoonful of light bicycle oil. Most front hubs are lubricated with grease. Do not apply oil to these. This will only tend to wash away grease.

**Coaster-Brake Rear Hubs.** There are many variations here. Follow the manufacturer's specific instructions. For example, here's the manufacturer's recommendations for the *Bendix Model 70* coaster brakes:

Bendix brakes are fully tested and lubricated before leaving the factory and, with average use, will not require any oil or other lubrication for one to two years or longer, depending on amount of use. If it appears that lubrication is needed, *only a few drops* of medium oil should be applied at each end of the hub and on the adjusting cone. *This oil will work into the brake and provide lubrication where needed.*

Complete relubrication requires disassembly. Both grease and oil are used for this.

On hubs with oil fittings, squirt in about one-half teaspoonful of bicycle oil. A medium oil (SAE 30) is often recommended for this, as a light oil will tend to wash away the grease in the bearings. Most coaster brake hubs are lubricated with both grease and oil.

**Multi-speed Hubs.** These generally have oil fittings for lubrication. Oil is added as described above for coaster brake hubs, except that more oil might be required. Follow manufacturer's recommendations.

**Freewheel.** Add a few drops of light oil to the freewheel mechanism. This is done externally. At six-month intervals, the freewheel should be removed from the bicycle (but not disassembled), cleaned and oiled.

**Derailleur Mechanisms.** Add light oil to pivot points on front and rear derailleur mechanisms and to the jockey and tension wheels on the rear derailleur. Apply oil sparingly to control levers and avoid getting oil on the friction surfaces that keep the controls from slipping positions.

**Chains.** Ideally, the chain should be removed monthly, cleaned in kerosene or other suitable solvent, lubricated with bicycle chain oil and reinstalled. If this schedule is too severe, simply wipe the chain with a cloth, add bicycle chain oil sparingly and wipe excess oil away. The removal, cleaning and relubricating can be done every six months. Chain maintenance is especially important on derailleur bicycles. Shifting and chain angles place considerable stress on the chain.

**Pedals.** Conventional pedals often have a small hole for adding oil. Add a few drops of bicycle oil. Some conventional pedals and most rattraps are overhauled with grease every six months. Do not add oil to these.

**Control Cables.** Add a few drops of bicycle oil to brake and gear change cables where they enter housings.

**Brake Calipers.** Add bicycle oil to pivot points of brake calipers. Avoid getting oil on rubber brake pads.

## **ADJUSTMENTS**

Multi-speed hubs, derailleurs and caliper brakes should be adjusted whenever they are not working properly. Inspections should be made at monthly intervals.

## **CLEANING, POLISHING AND WAXING**

Frequent wiping of dust, dirt and road soil from the bicycle frame and components will help to keep the bicycle in top condition. Some people wash bicycles with soap and water, but I do not recommend this. Water is likely to enter the internal workings and wash away lubricants. If you do use this method, dry the bicycle off as thoroughly as possible afterwards.

Cleaning compounds, polishes and waxes can be used on painted, plated and metal surfaces. But take special care here, as many products on the market can be more harmful than beneficial. Avoid especially harsh and abrasive compounds. Waxes especially compounded for bicycles are available at bicycle shops. Some of these are in spray cans. Because of the high risk of breathing harmful chemicals, I suggest that you do not use these. Instead, buy the less expensive products in liquid or paste form and apply with a cloth.

## **SIX-MONTH AND YEARLY OVERHAULS**

In addition to the above, front hubs, head sets and pedals should be taken apart, cleaned, lubricated and reassembled every six months. Rear hubs and crank sets should be overhauled every year.

The basic procedure is to mount the bicycle in a maintenance rack and service one assembly at a time. For example, you might want to start with the front hub. Remove the front wheel. Disassemble the hub. Clean all parts in kerosene or other suitable solvent. A pan or bowl partly filled with cleaning fluid can be positioned under the part to be cleaned. For parts that cannot be submerged in

the cleaning fluid, a brush can be used for applying the fluid. An example of this is cleaning the hub center of a spoked wheel. Even if you have a big enough pan and enough cleaning fluid, don't submerge the tire and tube.

After thorough cleaning by soaking and brushing, allow the fluid to completely dry or evaporate. Wipe with a cloth to make certain that no cleaning fluid remains. Check the condition of all components and make replacements as required.

Add lubrication to bearings. In the case of loose bearings not held in a ring retainer, the individual balls are held in position with grease while assembly is being made. Reassemble the hub and install the wheel back on the bicycle. Then go on to another component.

Unless you have fairly advanced mechanical skills, I do not recommend taking coaster brake and internal gear hubs apart. These are fairly complicated as bicycle assemblies go and have a long life generally without overhaul. If internal repairs are required, I recommend that you take the hub to a bicycle shop for repair. There are several reasons for this:

— There are such a multitude of different hubs in use that the availability of required replacement parts is questionable.

— It is difficult for the amateur to determine the specific problem.

— The hub might not be worth repairing because the damage could be so great that replacement of entire hub is more economical.

— The time required for the amateur to do the job can be considerable and possibly not worth the trouble.

— Special tools might be required.

For routine servicing, the advantages gained by overhaul when no repairs are needed are probably not worth the risks. If you do want to tackle these jobs, try to get the assembly drawings for the particular hub from the manufacturer if it is not one included in this book. If you can't get the drawings, take special care to note the order that the pieces come apart so that you will be able to reassemble them again. It might be helpful to make diagrams. In addition to the above, you should routinely check to make certain that all nuts and bolts are properly tightened.

## **THE OVERALL MAINTENANCE PICTURE**

The above maintenance schedule is generally recommended for the average bicycle used for utility and recreational cycling. However, many people successfully get by with much less. I would venture a guess that in actual practice only a very small percentage

of the bicycles in use today receive anywhere near the maintenance schedule described above.

For the more dedicated bicyclists, an even more demanding maintenance schedule can be followed. This is especially true when the bicycle is ridden long distances or under conditions calling for top performance. Touring cyclists generally adopt a maintenance schedule that can be carried out on the road. Bearings are serviced, for example, whenever dirt and grit are picked up or the bicycle has been ridden in wet weather conditions. To test on the road, pick the bicycle up and have someone spin wheels and turn cranks. Listen for sound of dirt and grit in bearings. If present, disassemble components, clean, lubricate and reassemble. Experienced touring cyclists carry everything they need for this in compact and lightweight form. In some cases, this is only adequate for emergency repairs to get them to a place where the parts and equipment for proper repairs are available.

## **TIRES AND TUBES**

Tires and tubes are a vulnerable part of a bicycle. Even if precautions are taken to prevent punctures or other damage while riding, the tires will sooner or later wear out. The quality and type of tires selected plays an important part in the useful life you can expect from a tire. The two main types of tires, clinchers, and tubulars, are discussed in Chapter 2, as are methods for achieving puncture resistance.

Keeping a tire inflated at proper pressure is important and should become a part of the routine maintenance and servicing of the bicycle. Under or over inflation can make riding more difficult and less comfortable. Both of these conditions can lead to tire and tube damage.

Changing tires or tubes and patching tubes are relatively simple repair tasks in the range of most bicycle users. The jobs are fairly time consuming and costly when you have them done for you at a bicycle shop.

### **Tire Inflation**

The tubes used with clincher tires generally have *Schraeder* type valves. Tubular tubes generally have the *Presta* type. Each requires a different air hose attachment to fit them. However, there is an inexpensive adapter that allows *Presta* valves to be filled with the *Schraeder* air hose fittings.

The *Schraeder* valves can be inflated with the conventional pumps found at gas stations. Hand pumps are available for either type of tube valves.

It can be risky to inflate tires at filling stations. The air pressure available is much greater than needed and this makes blowouts possible. A hand bicycle pump with a built-in gauge is a much better method. Make certain the pump you select is easy to work and efficient. Inflating a tire is almost impossible with some of the cheaper ones that are on the market. If the pump does not have a built-in gauge, use a high-pressure tire gauge. These can be purchased at bicycle shops and automotive stores.

Due to the porosity of materials, it's normal for tubes to lose air over a period of time. The proper tire pressure—usually given as a range of pressures—is shown on the side of the tire.

If the valve stem is not straight on an inflated tube, remove some of the air by depressing or loosening the valve in the stem. Rotate the tube inside the tire until the valve is straight in the rim. Then reinflate.

A common problem when inflating a tire is improper seating of the tire on the rim. To avoid this, partially inflate the tire. Check seating and alignment. Make necessary corrections with your hands. Then inflate to desired pressure. If seating or alignment is still incorrect, partially deflate and try again.

### Changing and Repairs

You will need a tube repair kit for clinches. These can be purchased at bicycle shops. Make sure it's the right kit for clinchers because the patching material is thicker than that used for tubulars.

To make changes or repairs, first remove the wheel from the bicycle. With a tire lever—the type with a notch to hook over the spoke is recommended—lift one bead of tire over edge of rim. Take care not to pinch the tube or stretch the wire bead any more than is absolutely necessary. Hook the tire lever to a spoke. If you have the type of tire lever without a spoke notch, hold it back by hand. The difficulty is having enough hands. This is the reason for the spoke notches.

With a second tire lever about four inches from the first one, lift bead over rim and lock lever to a spoke. If necessary, use a third tire lever about four inches from one of the others. Free the tire bead on one side of the tire from the rim all the way around. On tubes with a nut holding valve to rim, remove the nut. Remove the tube.

Thoroughly check the tire both inside and out to make certain that whatever caused the puncture is not still present.

Inflate the tube. If it is important to make repairs quickly, try to locate punctures by inspection. If holes cannot be located in this



manner, place the inflated tube in a basin or pan of water and watch for air bubbles. Mark holes with chalk. If the water test was used, a tube must be allowed to dry thoroughly before patching.

Patch a tube as follows:

Clean and roughen area where a patch is to be applied. Roughen around the hole with sandpaper or rasp-holes usually found on the lid of a patching kit container. Do this carefully. When poorly done, this is a frequent cause of leaking around the patch. Spread an even layer of patching adhesive over the roughened area. Allow adhesive to dry. While waiting, trim corners of a patch if they are not rounded. Sharp corners tend to work loose. The adhesive should be dry before backing is removed from a patch. When removing backing, take care not to touch the surface of the patch. Apply the patch, working it in place and stretching it to the tube. If the tube is to be replaced right away, sprinkle talcum powder around the area of patch to help prevent sticking.

If a hole in the tube is on the rim side, examine the inside of the rim. One common problem is for a spoke that has been tightened to protrude past the nipple. It will punch through the rim liner and puncture the tube.

Deflate the tube. Insert the valve stem in the hole—rim first. Work the tube inside the tire all the way around. Smooth the tube so that there are no twists. Push the tire bead back over the rim with your thumbs. Inflate the tire to proper pressure. Make sure that the tire is properly seated and the valve stem is straight. If not, deflate, make adjustments and reinflate. If there is a valve stem nut, thread in place and tighten down. Always use a valve-cap to keep dirt out of the valve.

The procedure for replacing a tire is the same except that the second bead is also removed from the rim on the same side of the rim as the first bead was removed. Do this by hand.

Clencher tube repairs can often be made in less than 10 minutes by experienced touring cyclists.

### **Sew Ups**

Tubular repairs usually take longer than clencher repairs. To avoid delays, touring cyclists who use these often carry extra tires with tubes already sewn in place. They fold up and are easy to carry. When on the road, a flat tire is removed and replaced with one of these spares.

However, it is possible to make repairs on the road. The following items are needed:

- Patches that are usually thinner than those used for clinchers and adhesive.
- Curved needle.
- Linen thread.
- Rim cement.
- Roughening lid that is often found on patching kit containers or sandpaper.
- Razor blade or stitch cutters.
- Talcum powder.
- Chalk.

To remove a tire, the first step is to break loose the cement holding the tire to the rim. No tire irons are required. Start near the valve stem. Using both thumbs, roll the tire off the rim. Work progressively around the rim.

Try to locate the leak before removing the tube from the tire. This will make it possible to repair the hole while removing a minimum of stitching. Restitching is a time consuming job so it's important to keep it to a minimum. Sometimes the leak can be located by finding the object that caused it. If you can't find the hole in this manner, pump some air into the tube and listen for the leak. If you still can't locate it, submerge both the tire and tube together.

After the leak has been located, mark with chalk. Strip back the tape that covers the stitches in that area. A couple of inches of working space is usually ample. Using a razor blade or stitch cutting tool, remove about one and a half-inch of the stitches.

Remove a section of the tube through the opening in the tire and locate holes in the tube. Follow procedures given above for patching clincher tubes but use a special, thinner patch designed for sew-ups.

Work the tube back inside the tire. Use needle and thread to re sew the tire. Space stitches about three-eighth of an inch apart. Cement tape back over stitches with rim cement.

Apply rim cement to the rim—not the tire. Old cement need not be removed. Wait until cement becomes tacky. This usually only takes two or three minutes. Then mount the tire. Start with the valve stem and work the tire on around the rim in both directions from the valve stem. When the tire is on the rim all the way around, rotate the tire until it is centered. This must be done quickly while the cement is still tacky. An even amount of sidewall should show all the way around on both sides of the tire.

Inflate the tire. Allow time for the cement to set before riding. If you must ride immediately, ride slowly and avoid turns that could work the tire off the rim.

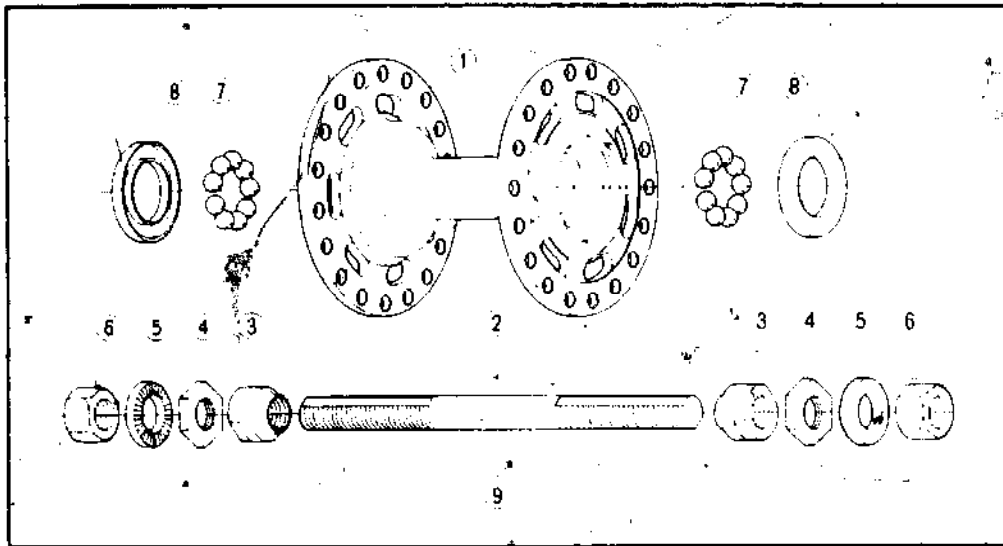

Fig 5-1 Shimano Model HC-400 front hub. Parts are: (1) hub shell, (2) axle, (3) cone, (4) lock nut, (5) washer, (6) axle nut, (7) steel ball, (8) dust cap, and (9) axle set

## HUBS AND FREEWHEELS

A typical hub and bearing arrangement with axle nuts for securing the wheel to bicycle frame is shown in Fig. 5-1. Figure 5-2 shows a quick release hub. Notice that it uses the same basic bearing and cone arrangement as shown in Fig. 5-1. This arrangement is used on almost all front and rear hubs including those with internal gears and coaster brakes. In essence, the only link between the hub shell and the axle are the bearings.

A new design trend is to use permanently sealed bearings. These can go for long periods of time without maintenance. When the bearings finally do wear out, the sealed bearings are usually replaced with new ones.

## ADJUSTING CONES

A frequent cause of excessive wheel play between axle and hub is loose cones. In turn, wheels that will not spin freely frequently have cones that are too tight. Simple adjustments will correct these problems. Of course, it might be something more serious such as lack of lubrication or worn parts. But always check the cone adjustment first.

## Cones Without Lock Nuts

These are similar to the hub shown in Fig. 5-1 except that they have no lock nut. The cone is locked in place by the axle nut when installed on a bicycle frame. This is a poor arrangement and is used

only on inexpensive hubs. It is difficult to remove the wheel without losing the cone adjustment. A simple improvement is to add thin lock nuts. Usually there is ample space to fit these in.

To adjust, loosen one of the axle mounting nuts. It isn't necessary to remove the wheel from the bicycle. Using a wrench that fits the cone, loosen the cone. Then tighten until bearings are seated firmly. This pulls the two cones closer together so both bearings are effected equally. Do not over tighten since this can cause damage. Next, loosen the cone approximately one-half turn. Hold the cone in this position with a wrench and tighten the axle nut with another wrench.

This should allow the wheel to turn freely without excessive play. If not, try making further fine adjustments. Loosen the cone another quarter turn if the wheel does not turn freely. Tighten a quarter turn if there is excess play. If several such adjustments do not correct the problem, it probably means lack of lubrication or worn or damaged parts inside the hub. You will need to disassemble the hub to find and correct the problem—as detailed later in this chapter.

### Cones with Lock Nuts

Loosen one of the axle mounting nuts. It isn't necessary to remove the wheel from the bicycle. You will need one thin wrench

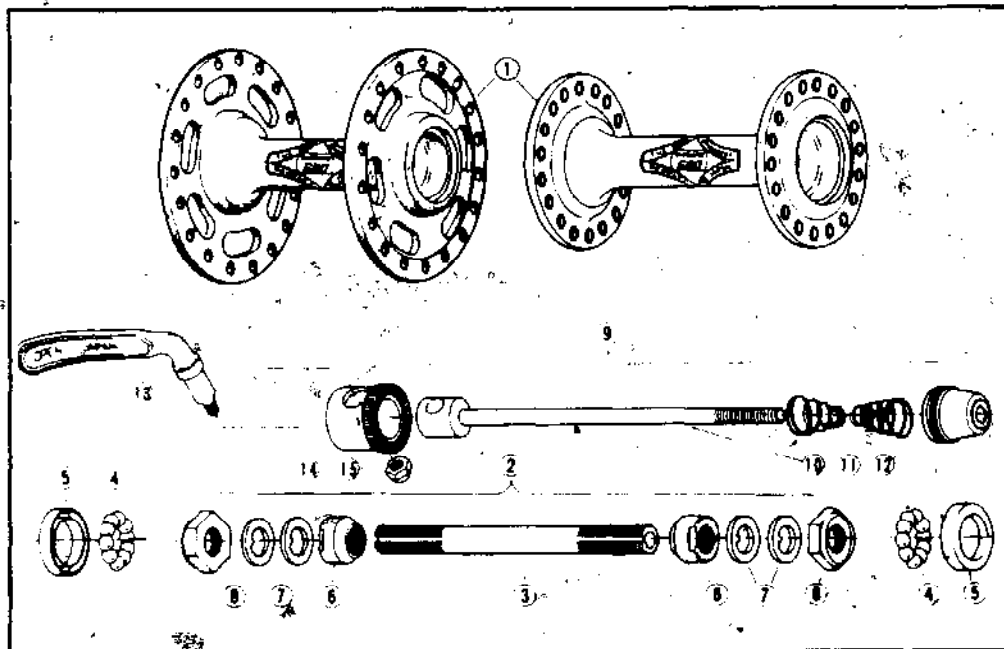

Fig. 5-2. Shimano 600 front hub with quick release. Parts are: (1) hub shell—large and small flange models shown, (2) complete axle set, (3) axle, (4) bearings, (5) dust cap, (6) cone, (7) key washer, (8) lock nut, (9) complete quick release unit, (10) skewer, (11) volute spring, (12) nut for skewer, (13) cam lever, (14) body cam lever, and (15) cap nut.

to fit the cone and another to fit the lock nut. Hold the cone with one wrench and loosen the lock nut with other wrench. Then tighten the cone until the bearings are firmly seated. Take care not to over-tighten. Loosen the cone one-half turn. Hold the cone in this position with one wrench and tighten the lock nut against the cone with the second wrench. Retighten the axle nut.

The wheel should now turn freely without excessive play. If not, make fine adjustments as described above for cones without lock nuts. If this does not cure the problem, you will need to overhaul the hub as detailed in this chapter.

### **Hubs with Quick Releases**

Open the quick release lever and remove the wheel from the bicycle. Adjust one cone as described above for cones with lock nuts. Reinstall the wheel on bicycle.

### **OVERHAULING HUBS**

Overhauling steps include removing the wheel from the bicycle, disassembling the hub center, cleaning, inspecting, replacing parts as required, lubricating, reassembling and reinstalling wheel.

When you are touring, some of these steps can sometimes be omitted until a better work area is possible. For example, cleaning might be limited to what can be done with a cloth.

A complete overhaul is best done with the bicycle in a repair stand. The following basic steps, with noted differences, apply to most standard front hubs and rear hubs without internal gears or brakes. This includes those with fixed and freewheel sprockets.

Remove the wheel from the bicycle. If you are going to overhaul both front and rear hubs, it is generally best to do one at a time. Finish that wheel and install it back on the bicycle before starting the second wheel.

Assemblies for the six basic hub types to which these instructions apply are the front hub with axle nuts (Fig. 5-1), front hub with quick release (Fig. 5-2), rear hub for freewheel with axle nuts (Fig. 5-3), rear hub for freewheel with quick release (Fig. 5-4), rear track hub with fixed sprocket (Fig. 5-5) and a rear hub for freewheel and disc brake (Fig. 5-6).

Begin disassembly by removing axle mounting nuts or quick release assembly. The latter by holding cam lever and unscrewing the nut for skewer, removing tension or volute spring and sliding skewer out of axle center. The remainder of the quick release need not be disassembled unless parts such as the cam lever are to be replaced.

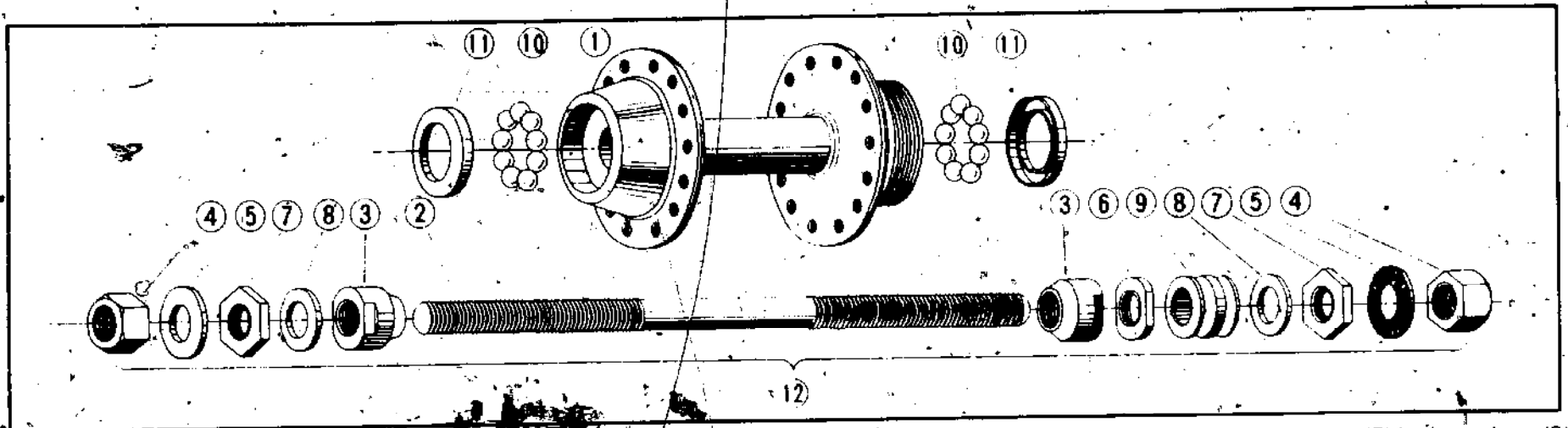

Fig. 5-3. Shimano Model HD-100 rear hub for freewheel with axle nuts. Parts are: (1) hub shell, (2) axle, (3) cone, (4) axle nut, (5) lock washer, (6) lock nut, (7) lock nut, (8) spacer, (9) spacer, (10) steel ball, (11) dust cap, and (12) axle set.

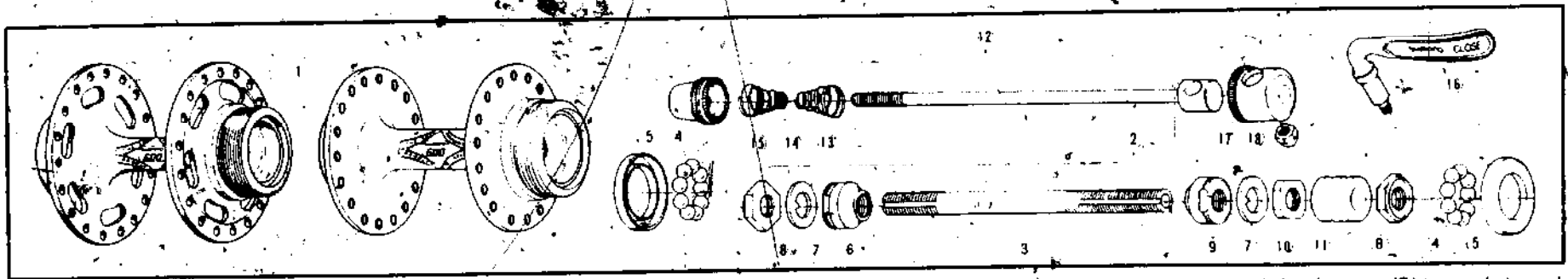

Fig. 5-4. Shimano 600 rear hub for freewheel with quick release. Parts are: (1) hub shell—large and small flange models shown, (2) complete axle set, (3) axle, (4) steel ball, (5) dust cap, (6) cone, (7) key washer, (8) lock nut, (9) cone, (10) lock nut, (11) spacer, (12) complete quick release unit, (13) skewer, (14) volute spring, (15) nut for skewer, (16) cam lever, (17) body cam lever and (18) cap nut.

For hubs with freewheels, the next step is to remove the freewheel. You will need a special tool for removing the freewheel. There are two basic types of removal tools. They are for free wheels with splines and for freewheels with lugs. Make sure that you get the right one for your brand of freewheel. These tools cost approximately \$3. You will also need a vise with copper jaws or a special axle vise such as the one shown in Fig. 5-7. This is used in a regular vise as shown.

Mount the axle in the jaws of the vice or a special axle vise as shown in Fig. 5-7. The tool will be a complete wheel with freewheel and spacer mounted on the axle. Using an appropriate wrench, remove the spacer nut from the axle. Some hubs have a lock nut and a spacer. In this case, the lock nut must be removed first—then the spacer.

Next, remove the axle and wheel from the vise. Clamp the freewheel removal tool in the vise with splines or lugs, depending on type of tool for particular freewheel, facing upward. With sprockets downward, slip the freewheel over the removal tool. With the tool seated and aligned, rotate the wheel counterclockwise until the hub comes off the freewheel. In some cases, especially with lug type freewheels, it might be necessary to hold a tool in position by using an axle nut or reinstalling the quick release assembly. This is only necessary to free the thread hold initially. Once the freewheel center is started, remove the nut or quick release assembly and turn the freewheel.

For a regular hub overhaul it isn't necessary to remove the spoke protector. For some jobs, such as wheel spoking, it will be necessary to remove it. For some hubs also have a spacer washer between spoke protector and hub. The next step is to clamp the lock nut on one end of the axle in a vise, or hold the lock nut with a wrench on the downward side of hub. If the hub has no lock nut, form one by tightening an axle nut against the cone. With an appropriate wrench, loosen and remove the lock nut on the upward end of the axle, if present. Then remove the cone. Slide the axle out of the hub.

There are two types of bearing arrangements. With one type the bearings are caged in a retainer and with the other type they are loose. Those in retainers can be removed as a unit. The loose kind are covered by dust caps. They can be removed by prying them out. Take out the individual bearings. Tweezers can be used for picking out the bearings. It's a good idea to count them so that you will know how many go back.

Turn hub over and remove bearings from the other end of the hub.

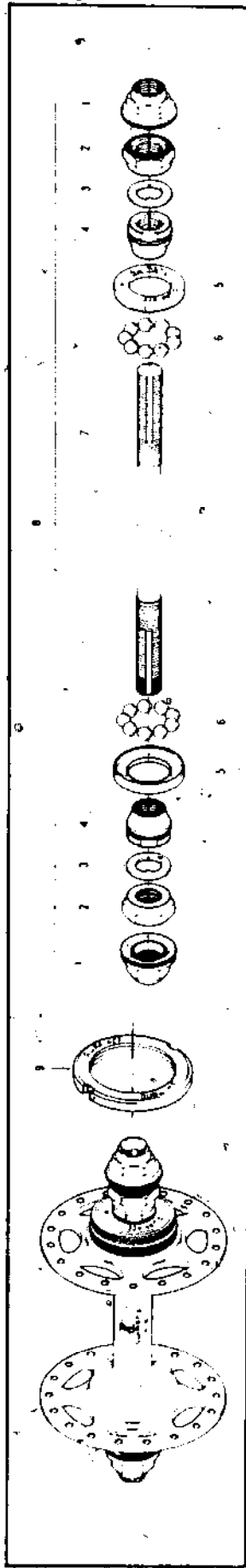

Fig. 5-5 Shimano Model HA-300, rear track hub. Parts are: (1) track nut, (2) lock nut, (3) non-turn washer, (4) cone, (5) dust cap, (6) steel ball, (7) axle, (8) complete axle set and (9) lock ring.

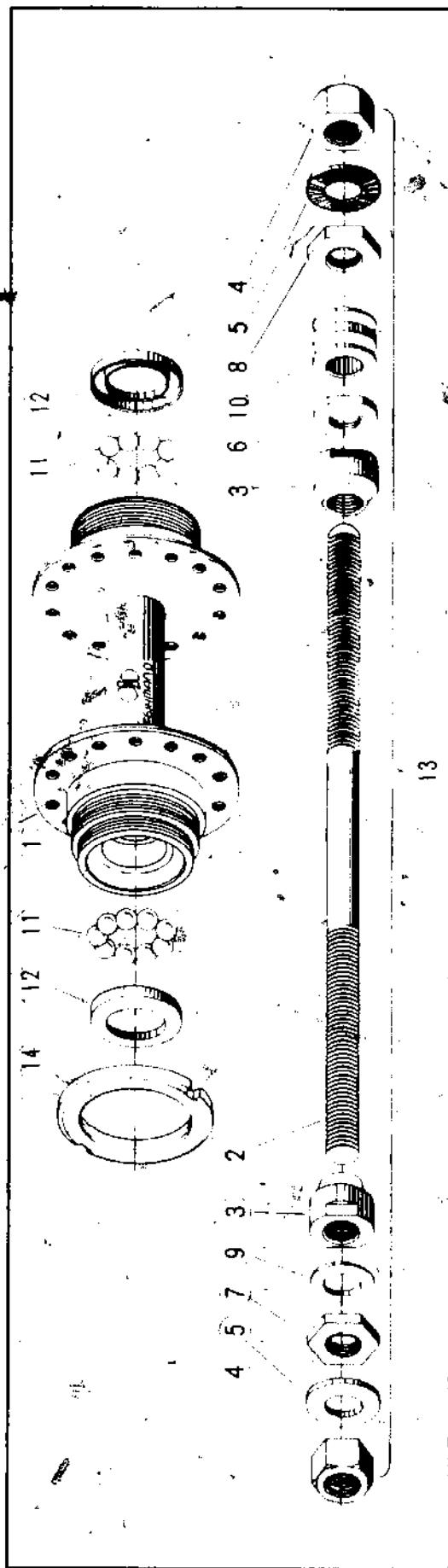

Fig. 5-6 Shimano Model HD-200 rear hub for freewheel and disc brake. Parts are: (1) hub shell, (2) axle, (3) cone, (4) axle nut, (5) hub washer, (6) lock nut A, (7) lock nut B, (8) lock nut C, (9) lock washer, (10) spacer, (11) steel ball, (12) dust cap, (13) axle set and (14) lock ring.



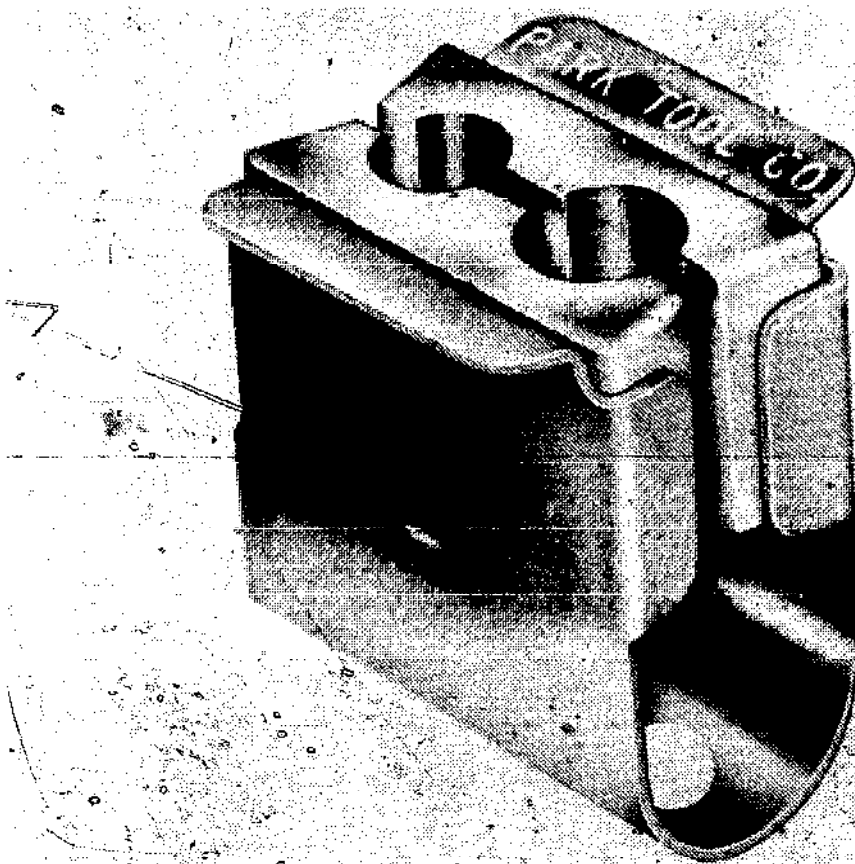

Fig 5-7 Park axle vise

The remaining cone on the axle need not be removed unless required for inspection or replacement of parts. Before removing this cone, measure the distance of the cone from the end of the axle so that you will know where to position it later when you reassemble it.

Clean all parts in solvent. Check all parts and make replacements as necessary. If any of the bearings are worn or pitted, it's generally best to replace the complete set. Check axle, nuts and cones for thread damage. Make certain that the axle is not bent.

Assembly follows reverse order of disassembly, except that bearings are packed in bicycle grease. The grease will also serve to hold individual loose bearings in position until assembly is completed.

After assembly, adjust cones as described above in this chapter. ~~Hold~~ Hold cone in position and tighten the lock nut.

On hubs where a freewheel was removed, reinstall the freewheel. On quick release hubs, install assemblies through axle centers. Install the wheel back on the bicycle.

This sounds like a long involved job. But after you do it a few times, it becomes routine and can be done fairly quickly.

## Coaster Brake Hubs

Coaster brakes will usually give long service without overhaul. Ideally, they should be dismantled, cleaned and lubricated about once a year under normal use. If the hub has a grease fitting or oil cap, you can probably get by for a period of several years by just adding lubrication periodically.

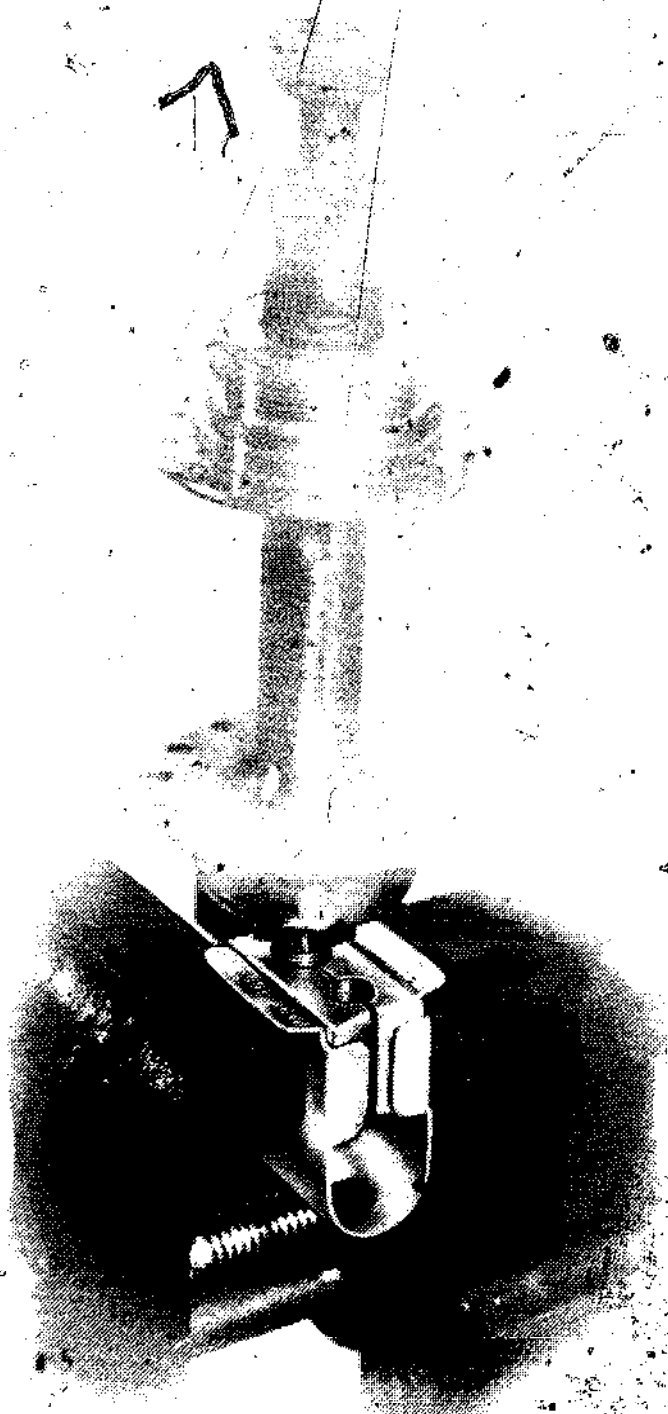

Fig 5-8 Use of Park Axle vise

The following description of the operation of a coaster brake applies to the *Bendix Model 70* shown in Fig. 5-9, but most operate in essentially the same way. When the pedal direction is reversed for braking (back pedaling), the drive screw (BB-502) is turned. Screw action causes the retarder sub assembly (BB-159), which consists of driving clutch, drive and expander and retarder spring, to move toward the expander (BB-533). The cammed surfaces on the ends of BB-533 and BB-159 facing each other spread the brake shoes (BB-22) so that they create friction or a locking action against the inside of the hub shell. This causes friction between the expander (BB-533), which is connected by the brake arm (BB-510) directly to the bicycle frame, and the wheel to form effective braking action. In other words, the hub is joined to the bicycle frame by friction or a locking action. If the bicycle wheel is turning when this happens, braking results.

There are many brands and types of coaster brakes in use today. Since coaster brakes are fairly complicated, I suggest that inexperienced bike mechanics have overhauls and repairs done at a bicycle shop.

The overhaul instructions for the Bendix Model 70 coaster brake, as shown in Fig. 5-9, are included here as an example.

To remove the rear wheel from a bicycle, place the bicycle upside down—preferably in a maintenance rack. Remove both axle nuts, unfasten the brake arm from the arm clip—leaving the arm clip on the frame—and remove the chain first from front and then rear sprockets. After removing mudguard braces, from the axle, pull the rear wheel from the frame.

To disassemble, the arm end of axle should be clamped in a vise with copper jaws to prevent damaging threads. The axle locknut, BB-15, at the adjusting cone end should then be removed, as well as the BB-7 adjusting cone. The BB-502 driving screw, BB-20 cone bearing and BB-516 bearing should be removed. The driving screw can be removed by unscrewing counter clockwise. The wheel should then be carefully lifted off the internals while you hold shoes together with your fingers. Internals can then be easily disassembled.

Clean all parts in solvent. Inspect parts and make replacements as required.

To reassemble, the anchor end bearing BB-516 should be assembled on the anchor expander BB-533 with balls toward the tapered surface. This bearing can be assembled easily if the following procedure is used. Assemble a BB-533 anchor expander to the

axle. Allow the axle to project approximately one and one-eighth inch beyond the arm square. The bearing should then be greased and placed in a BB-532 dust cap—with balls outward.

Using the long portion of the axle as a handle, the expander-axle sub-assembly, parts BB-533 and BB-4, should be pushed through the bearing until the bearing seats in the race as shown in Fig. 5-10.

The BB-510 brake arm should then be assembled and parts locked in place with a BB-15 axle locknut. This assembly should then be fastened in a copper-jawed vise—with the arm down. The drive end expander, retarder and driving clutch sub-assembly (BB-159) should then be placed on the axle.

A light coating of grease should be applied to both expander surfaces. Shoes should be lightly coated with grease and placed on expander surfaces. The inside diameter of the hub should have a light coating of grease. Holding the shoes together with your fingers, place the hub over the entire assembly.

Care must be taken to have the hub bearings properly seated. The sprocket end bearing (BB-516) should be installed with balls toward the hub as shown in Fig. 5-11.

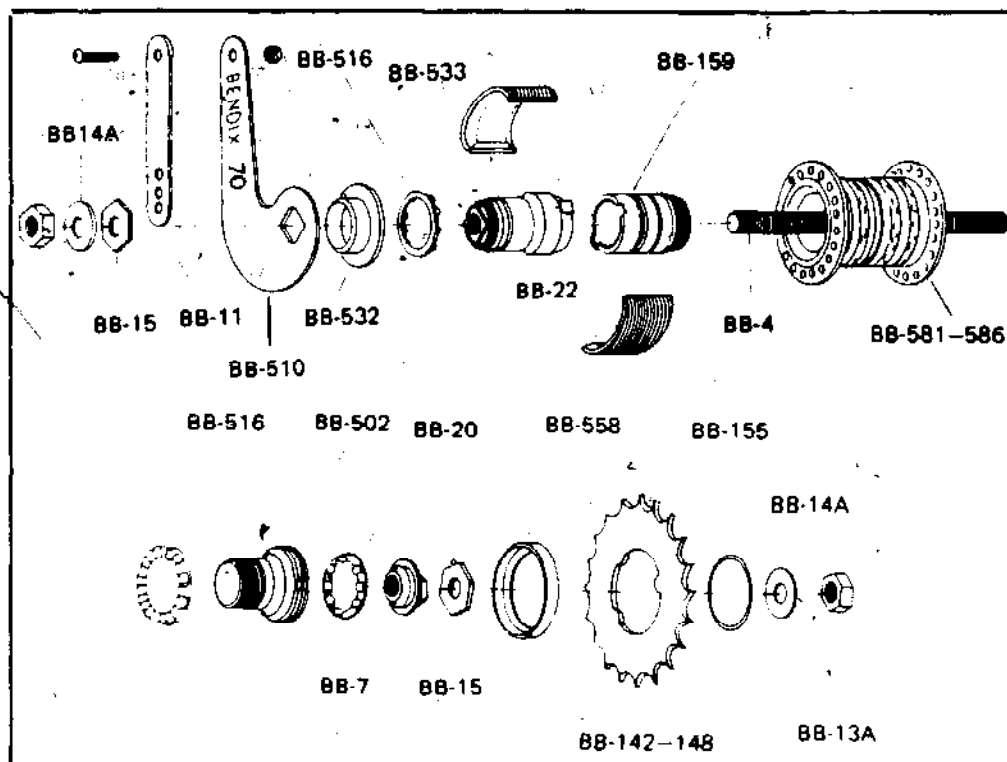

Fig. 5-9. Bendix Model 70 coaster brake. Parts are: (BB-4) axle, (BB-7) adjusting cone, (BB-11) arm clip assembly, (BB-13A) axle nut, (BB-14A) axle washer, (BB-15) lock nut, (BB-20) retainer, (BB-22) sub assembly, (BB-502) drive screw, (BB-510) brake arm, (BB-516) retainer, (BB-532) dust cap, (BB-533) expander, (BB-558) dust cap and (BB-581-586) hub shell.

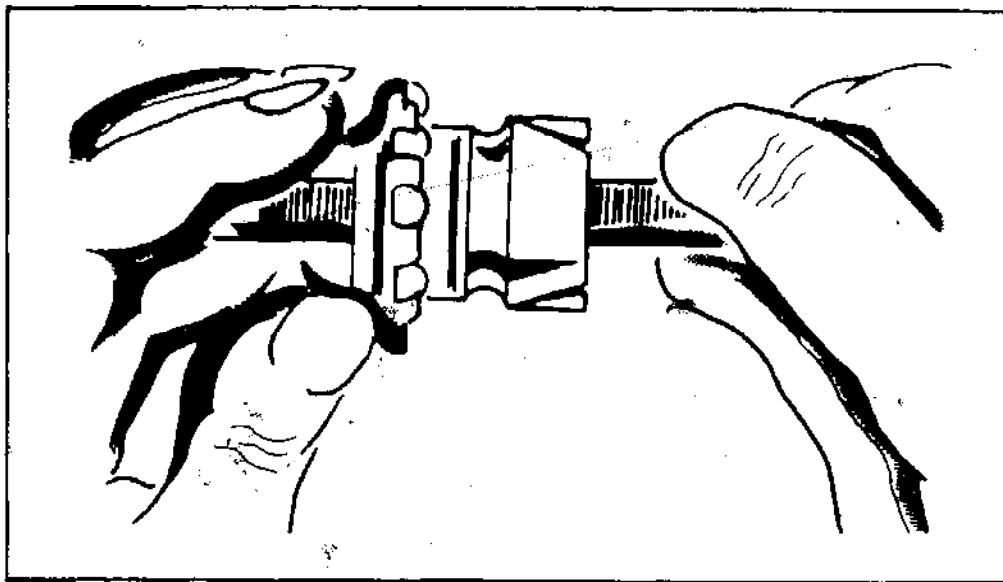

Fig. 5-10. Installing expander-axle sub-assembly.

The BB-502 driving screw should then be screwed into place. Place the adjusting cone bearing (BB-20) in the driving screw with balls toward the hub. The BB-7 adjusting cone should be run down on the axle. Finger tighten the cone against the ball bearing. Do not use a wrench at this point.

Unscrew the cone a quarter turn. Hold the cone in that position with a thin wrench and tighten the locknut with a second wrench. There should be a slight amount of side play at the wheel rim.

Place a BB-558 dust cap over a BB-502 drive screw.

Attach a sprocket on BB-502 so that the three lugs match lug slots provided.

Install a BB-155 retaining ring in the groove next to sprocket.

Reinstall the wheel on the bicycle. Form an arm clip (BB-11) snugly around the frame at a point where the bolt hole in the brake arm clip lines up with the bolt hole in the brake arm. Select the hole in the arm the clip that holds the brake arm closest to frame. Install an arm clip screw and nut but do not tighten yet.

Install BB-14A axle washers and BB-13A axle nuts loosely. Pull the wheel back to the tighten chain. Center the wheel so that it does not rub on either fork end. Tighten the axle nuts securely.

Tighten the arm clip nut securely while the bicycle is still upside down.

It is important to test the bike for driving, coasting, and braking. If a wheel does not rotate freely, the cone adjustment is undoubtedly too tight and must be readjusted.

Fig. 5-12 shows *Bendix Model 76* coaster brakes. Overhauling these is very similar to the *Model 70* described above. The main

difference is that Model 70 has two brake shoes and Model 76 has four brake shoes.

The parts and assembly of a *Shimano B-Type* coaster brake are shown in Fig. 5-13.

### Multi-Speed Hubs

Figure 5-14 shows a *Shimano FA-type* three-speed hub and Fig. 5-15 shows a three speed hub with coaster brake. Unless you are an experienced bicycle mechanic, I recommend that you leave all internal repairs to a bicycle shop. Fortunately, these hubs usually will stand up for years with only periodic lubrication added to a fitting on the hub shell.

The most frequent problems are external and making corrections such as cable adjustments are usually fairly easy. The cable can be either too loose or too tight. Other problems include broken cables and cables not sliding freely in housings and over pulleys. To check for broken cable, work the control lever or handle and see if the cable moves at hub end. If not, replace the cable.

With cable intact, check to see the cable slides through housing and pulleys freely. If not, remove wire and lubricate. If rusted, replace wire.

Cable adjustment varies with the make of the hub. For example, the *Sturmey Archer* is adjusted as follows. For three and five speed hubs, place the right control lever in the center position. Adjust the cable until the end of the rod where it joins the small chain at the hub end of the control cable is even with the end of the axle. This can be seen through the hole. Adjustments are made by turning the threaded end on the control cable. Tighten the locknut with your fingers.

For five-speeds, a second adjustment on the left control cable is required. The control lever is placed in a position that gives most

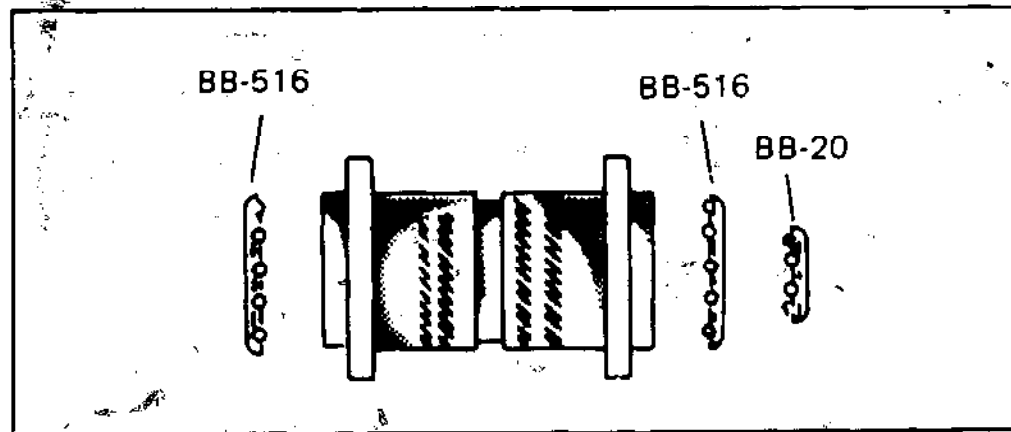

Fig. 5-11. Bearings are installed with balls toward the hub.

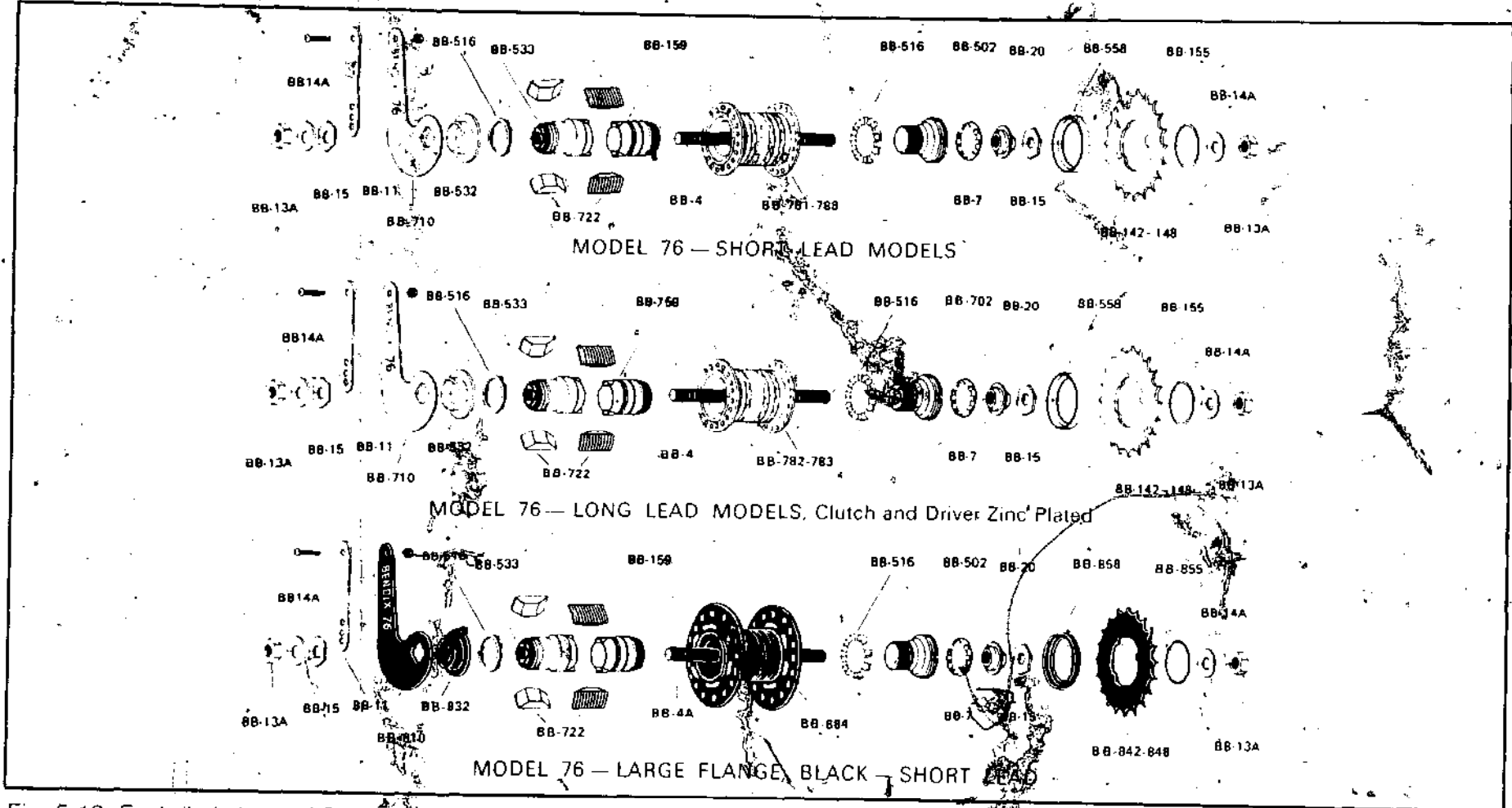

Fig. 5-12. Exploded views of Bendix Model 76 coaster brakes.

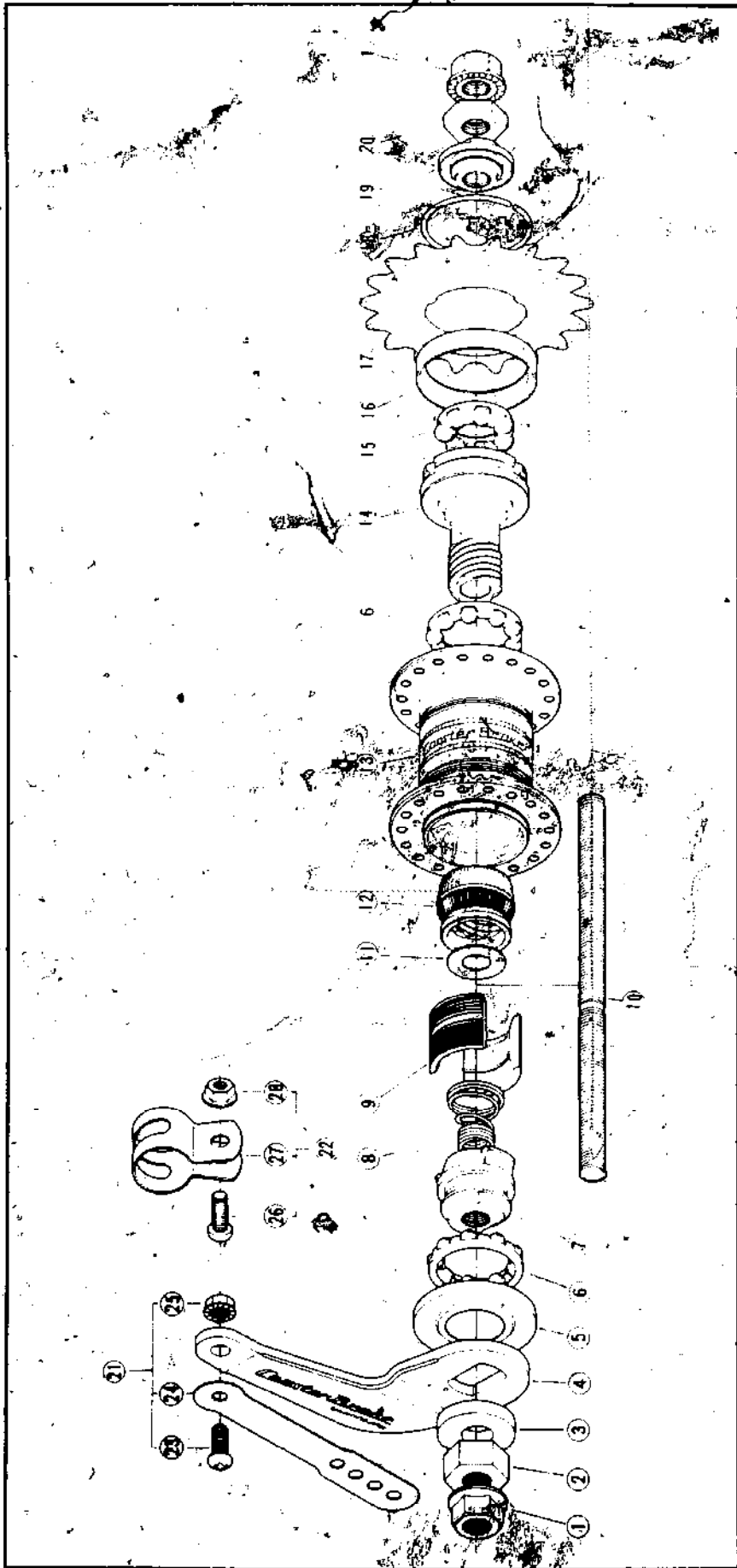

Fig. 5-13. Shimano B-Type coaster brake. Parts are: (1) axle nut, (2) axle nut, (3) arm washer, (4) brake arm, (5) dust cap, (6) ball retainer C, (7) brake cone, (8) clutch spring, (9) brake shoe, (10) axle, (11) clutch washer, (12) clutch cone, (13) hub shell, (14) driver, (15) ball retainer A, (16) dust cap, (17) sprocket, (18) snap ring, (19) cone with dust cap, (20) lock nut, (21) brake arm clip set—flat type, (22) brake arm clip set—band type, (23) clip bolt, (24) brake arm clip—flat type, (25) clip nut, (26) clip bolt, (27) brake arm clip—band type and (28) clip nut.



slack in the cable. Then adjust all slack out of the cable. The knurled nut is locked after adjustments have been made.

Adjustments on *Shimano* three-speed hubs are made differently. With the control lever in the center position, the pointer on the small arm should point to N as shown in Fig. 5-16. If the arm does not point to N, loosen the lock nut on the cable and turn the threaded metal arm as required so that the small arm does point to N. Retighten the lock nut.

Difficult shifting that is not due to control levers or cables might be caused by the chain being too tight, the axle not centered in frame or a bent axle. Check for these conditions and make adjustments accordingly.

If gears will still not operate properly by operating control levers, loosen the cable until it is completely slack. Place the bicycle upside down or in a maintenance rack. Crank pedals by hand and pull the shift cable by hand. If the gears function, the problem is most likely in the cable or control lever. If the gears do not work, the problem is likely to be inside the hub. The most likely internal problem is lack of lubrication. Add lubrication through the hub shell fitting. Also check to make certain that cones are properly adjusted and control rods at the ends of the cable are tight.

### **Freewheels**

Instructions for removing freewheels from hubs are given in the section on overhauling hubs. I suggest that you do not try to disassemble the freewheel unit itself. Also, special tools (Fig. 5-17) are required for removing sprockets from the freewheels. If you need to remove these to make a switch or replacement, I suggest you take the unit to a bicycle shop and have the job done for you. Fig. 5-18 shows the assembly of sprockets on a freewheel.

For cleaning, I suggest that you soak freewheel and sprockets as a unit in solvent. Drain, allow to dry and wipe unit off with a cloth. A brush can be used with the solvent for cleaning between the sprockets.

When the unit is completely clean and dry, oil the freewheel with light bicycle oil. The unit is then ready for reassembly to the hub.

### **WHEEL TRUING**

To form a wheel, the rim is connected to the hub flanges by adjustable spokes. The two basic types of rims are the clincher type with a deep U-shaped channel for clincher tires and the tubular type



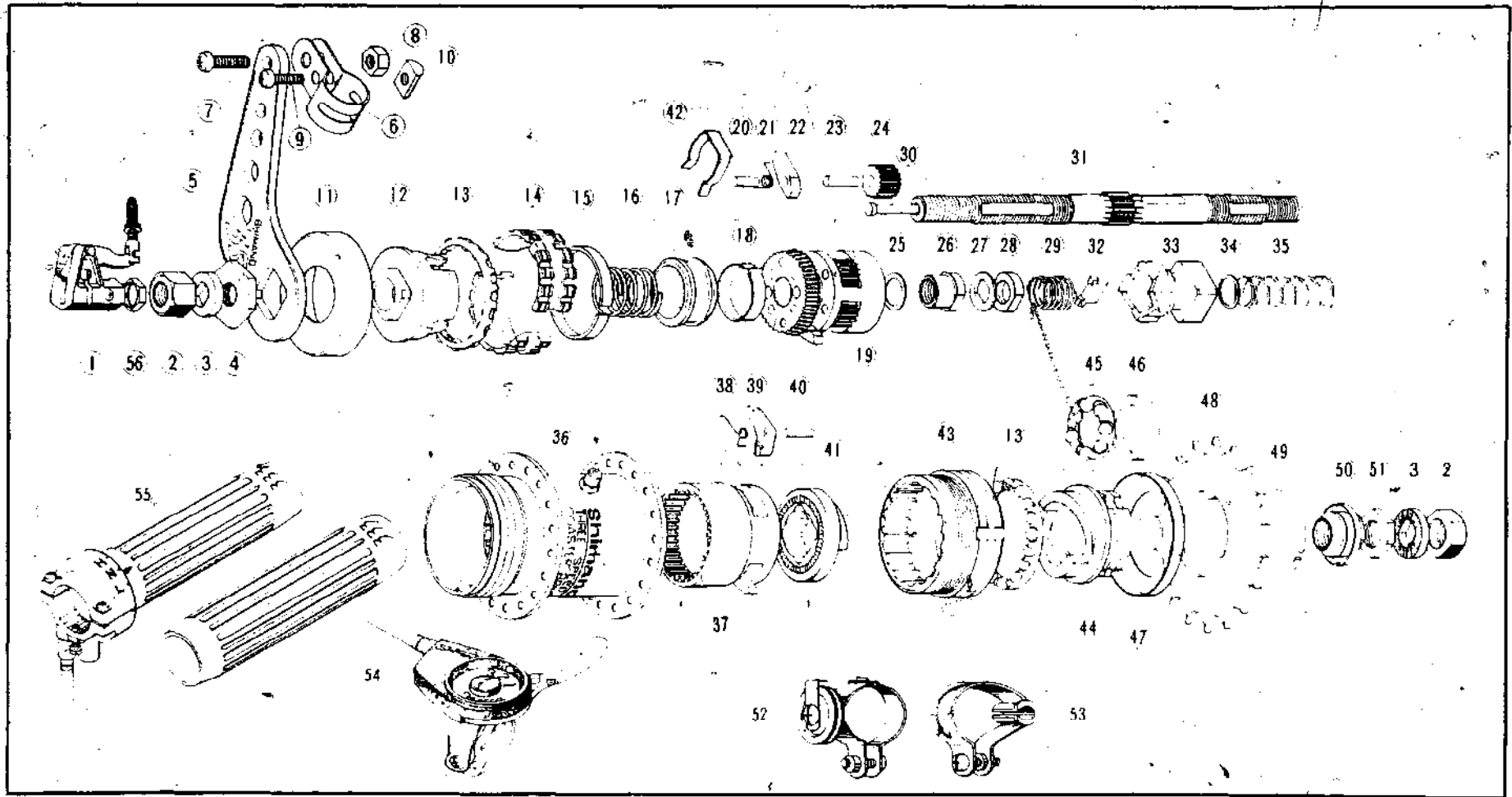

Fig. 5-15. Exploded view of Shimano three-speed hub with coaster brake.

Table 5-1 Parts List for Fig. 5-15.

ITEM NO.	PART NO.	DESCRIPTION	ITEM NO.	PART NO.	DESCRIPTION
1	333 9001	Bell Crank Complete	16	333 1900	Return Spring
2	333 4100	Axle Nut (3/8")	17	333 2100	Spring Guide
3	333 4200	Lock Washer	18	333 2000	Slide Spring
4	333 0301	L.H. Lock Nut	19	333 2500	Carrier
5	333 0500-1	Brake Arm	20	333 2600	Pawl Pin C
6	333 0601	Arm Clip (5/8")	21	333 2700	Pawl Spring C
	333 0602	Arm Clip (11/16")	22	333 2500	Pawl D
	333 0603	Arm Clip (3/4")	23	333 2300	Pinion Pin
7	333 0700	Arm Bolt (M6x15)	*24	321 5500	Planet Pinion
8	333 0800	Arm Nut	25	333 2400	Thrust Washer
9	333 0900	Arm Clip Bolt (ISO thread)	26	333 0400-1	Stop Nut
10	333 1000	Arm Clip Nut (ISO thread)	27	333 3900-1	Non-turn Washer
11	333 1100-1	Dust Cap E	28	333 4000-1	Lock Nut B
12	333 1200-1	Brake Cone	29	333 3200	Clutch Spring B
*13	321 9023	Ball Retainer B	*30	321 7100	Push Rod (4-8/12")
14	333 1300	Brake Shoe	31	333 1800	Axle (6-5/8")
15	333 1400	Brake Shoe Spring	*32	333 1300	Axle Key

\* All parts asterisked are interchangeable in SHIMANO 3-speed hub.

ITEM NO.	PART NO.	DESCRIPTION	ITEM NO.	PART NO.	DESCRIPTION
33	333 3100	Sliding Clutch	*48	321 0340	Sprocket Wheel 18T
34	333 3400	Clutch Washer		321 0350	Sprocket Wheel 19T
35	333 3500	Clutch Spring A		321 0360	Sprocket Wheel 20T
36	333 9007	Hub Shell 28H	*49	321 2000	Snap Ring C
	333 9014	Hub Shell 36H	*50	321 9024	R.H. Cone
37	333 2800	Ring Gear	*51	321 3800	R.H. Lock Nut
38	333 3000	Pawl Spring E	52	611 9002	Guide Roller Assem. 1"
39	333 2900	Pawl E		611 9001	Guide Roller Assem. 1-1/8"
*40	321 1000	Pawl Pin C	53	611 9006	Stopper Band Assem. 1"
41	333 3600	Cam		611 9005	Stopper Band Assem. 1-1/8"
42	333 4800	Stop Ring		643 9044	Stopper Band Assem. 3/8"
43	333 1800	R.H. Ball Cup		643 9045	Stopper Band Assem. 1/2"
44	333 3700	Driver	54		Trigger Lever Assembly
*45	321 9022	Ball Retainer A	55		Grip Control Assembly
*46	321 2700	Dust Cap A	*56	321 8100	Bell Crank Lock Nut
*47	321 2900	Dust Cap			
*48	321 0325	Sprocket Wheel 16T			

with a slight depression for cementing on sew-up tires. When spokes are properly adjusted the wheel will be true. That is, it will turn smoothly without wobble or up and down motion.

Minor adjustments can often be made without removing the wheel from the bicycle and with the tire and tube left in place. There

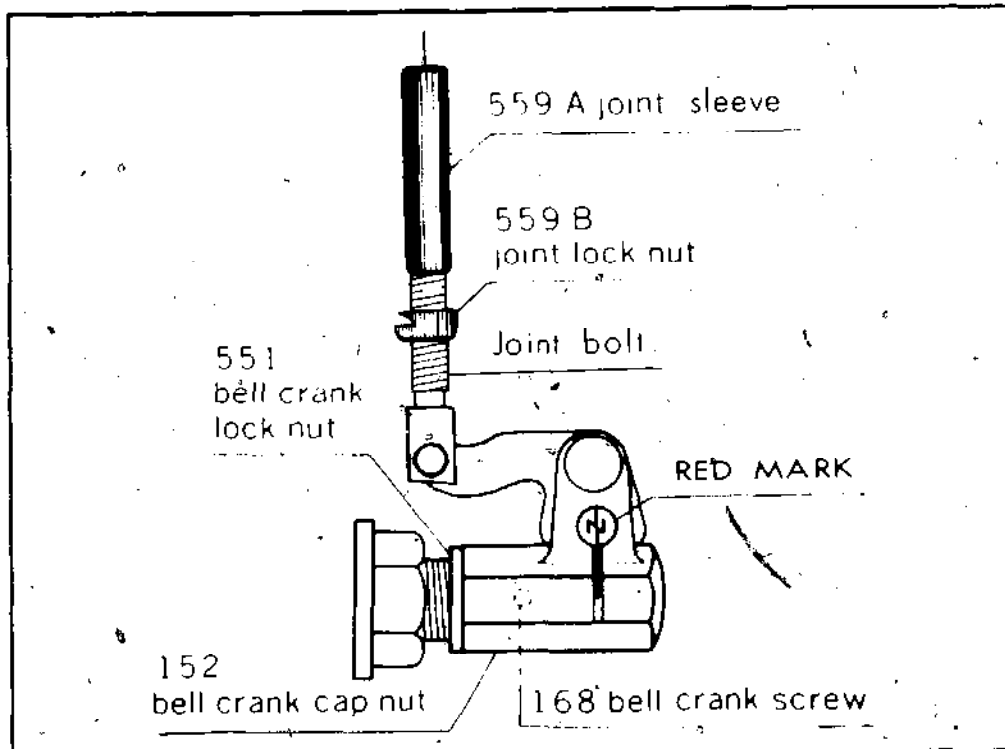

Fig. 5-16. Adjustment indicator on Shimano three-speed hub.

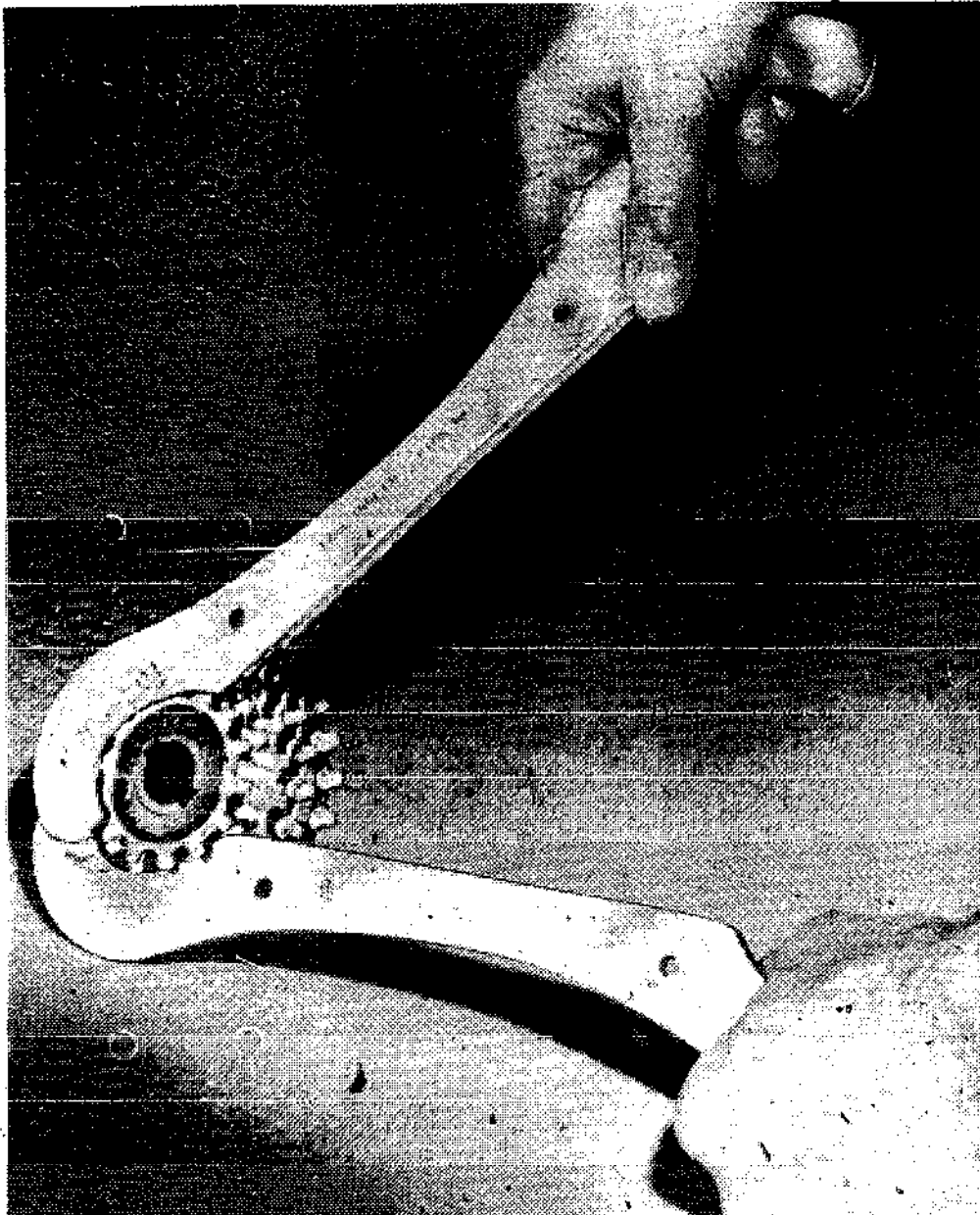

Fig. 5-17. This Park sprocket tool is used to remove sprockets from flywheels.

is some risk of puncturing the tube by tightening a spoke nipple to the point where the end of the spoke will extend through the nipple and puncture the tube. A spoke nipple is the piece with internal threads that passes through the rim and holds the spoke in place. However, since most spoked wheels only have the nipple threaded part way over the threaded end of the spoke, this is usually worth the risk. Otherwise the wheel would have to be removed from the bicycle, the tire and tube removed and then the alignment made. All to prevent something that probably wouldn't have happened anyway.

Turn the bicycle upside down or mount it in a maintenance rack so that the wheels can be turned. Using brake pads or the eraser

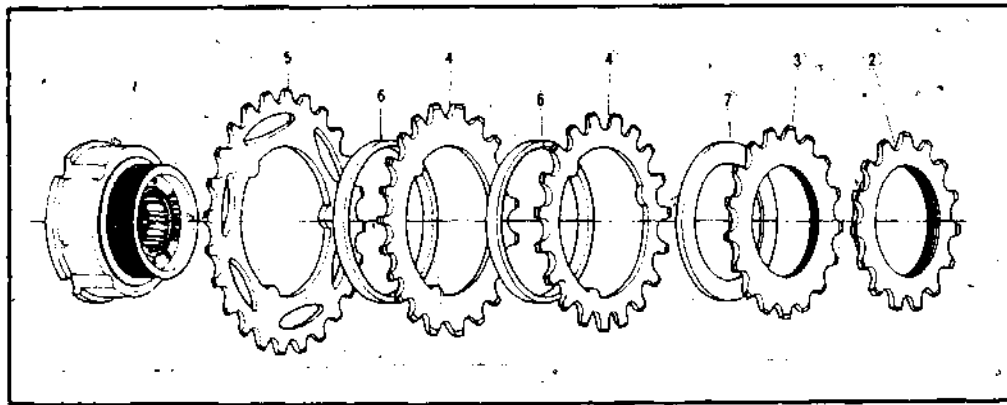

Fig. 5-18. Shimano Model FC-300 multiple freewheel. Parts are: (1) freewheel body. (two through five sprockets), (6) spacer A and (7) spacer B.

end of a pencil as a guide, figure out where the wheel is out of alignment. Determine which spokes need to be adjusted to bring it into alignment. Use a spoke wrench (Fig. 5-19) to make the necessary adjustments.

In most cases, small adjustments to the spokes will be all that is required. If the rim is off to one side and too close to the wheel center in the same area, the required correction would be to loosen the spoke that is pulling the rim to that side and toward the axle. Try a quarter turn of the spoke. Then spin the wheel again and check for trueness. Repeat this method until the rim is true.

One or two broken spokes can sometimes be replaced without removing the wheel from the bicycle or the tire and tube from the wheel. The wheel will have to be in near alignment and the spoke or



Fig. 5-19. Spoke wrenches.

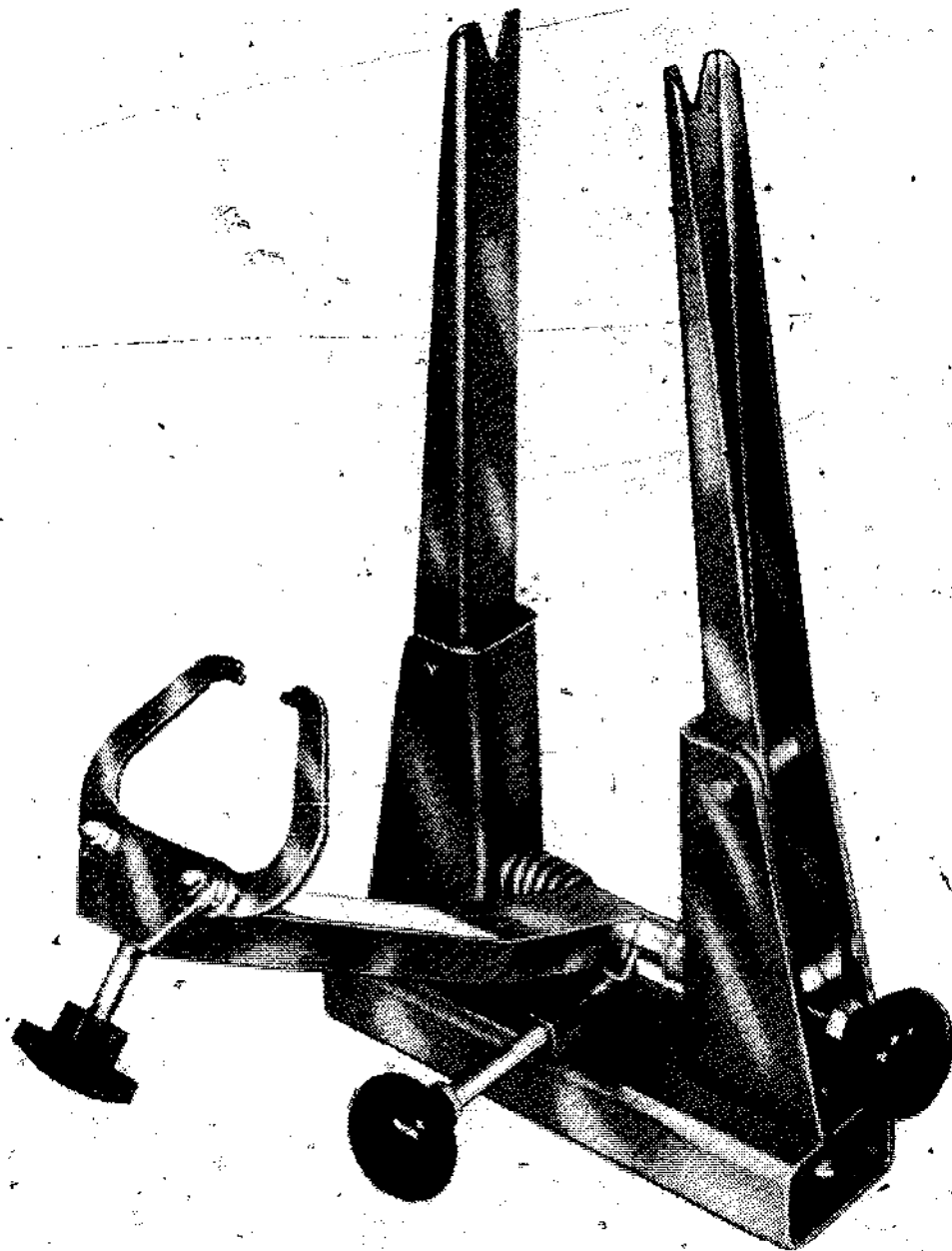

Fig. 5-20. Park wheel truing stand.

spokes broken in such a way that you can unthread the broken spoke out of the nipple.

If not, you still might be able to get by without removing the wheel from the bicycle. Let the air out of the tire and work the tire and tube to one side in the area where the nipple is to be replaced. Lift back the rim liner. Remove the nipple. It is best to use exact replacements for both nipple and spoke. Take the broken pieces to a bike shop to use as a guide. In some cases the sprocket placement will not allow inserting a spoke in the normal manner. In this case, an extra long spoke can be bent to the correct length. Cut off about three-eighth of an inch past the bend and insert and loop in the hub spoke hole.

With a new spoke in place, tighten the nipple until it is approximately the same tightness as neighboring spokes. Final adjustments can be made after the tire has been inflated.

If the wheel is too far out of alignment or has too many broken spokes for the above correction procedure, major wheel truing will be required. Since this job requires considerable skill, you might want to take the wheel to a bicycle shop and have it done. If so, it will be less costly if you remove the wheel from the bicycle and remove the tire, tube and rim liner from the wheel.

Or you might want to tackle the job yourself. For high performance bicycling, a wheel truing stand such as the one shown in Fig. 5-20 will be almost essential. For less critical work on a utility cycle, you can improvise a stand that will probably allow you to do an adequate job.

A bicycle fork turned upside down and mounted in a vise by the stem will serve as a stand. (Fig. 5-21). For rear wheels, the axle notches in the fork blades or dropouts will probably have to be widened to take the larger axle. The wheel with tire, tube and rim liner removed is mounted so that it can be rotated freely. Fasten a cardboard or tape guide across the fork blades just below the rim. Make these marks with one in the exact center between the fork blades—make certain that the axle is perpendicular in the mountings—and one on each side of the first half the width of the rim away from it.

It should be noted at this point that front hubs and some non-derailleur rear hubs have the hub centered with the rim. The

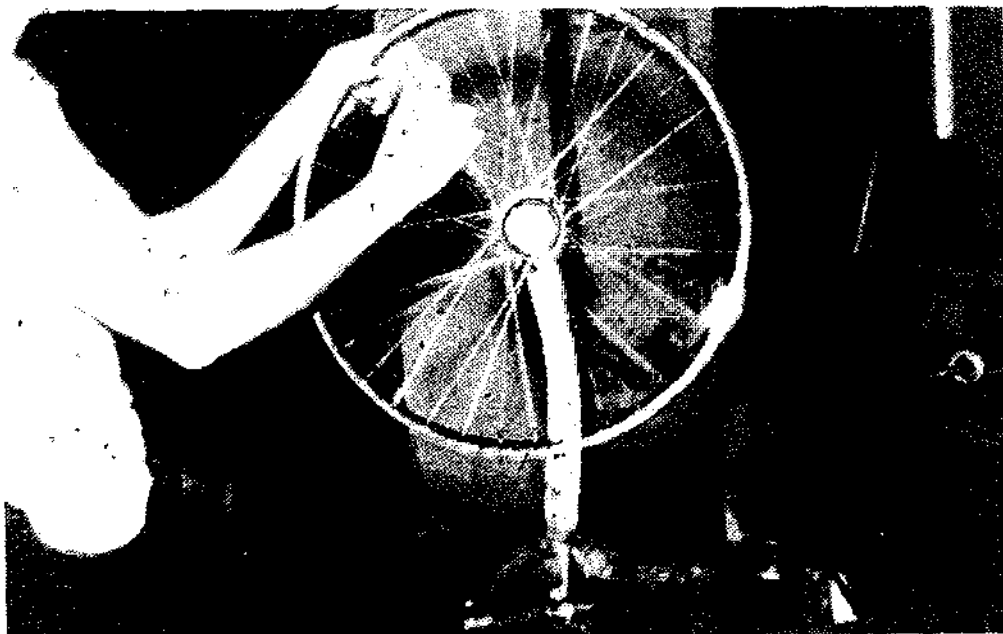

Fig. 5-21. Bicycle fork in vise used as wheel truing stand.



hubs used with rear derailleurs are set off to one side of the rim to make room for the wide cluster of sprockets. The rim must be centered between the dropouts so that it will line up exactly with the front wheel. To achieve this effect, different lengths of spokes are used on opposite sides of the hub flange. Observe this pattern on a derailleur bike. It's called *dishing*.

The improvised truing stand will allow centering the rim to a fair degree of accuracy. If greater accuracy is required, a truing gauge (Fig. 5-22) or professional type truing stand with precision centering gauge is needed.

A truing stand, in addition to centering the rim, is used to determine the degree to which the wheel is round and its side-to-side trueness. Deviations can be located and corrections made by tightening and loosening spokes.

Before starting the alignment of a previously used wheel, replace all broken or damaged spokes. Tighten them approximately the same amount as neighboring spokes. The instructions that follow also apply to a newly laced wheel. Techniques for lacing wheels are given later in this chapter.

First, consider a wheel with a flattened spot in one area and a bulge in another. The procedure is to loosen the spokes in the flattened area and to tighten those in the bulged area. The problem areas can be determined by spinning the wheel and watching the guide. Flattened spots will show as the rim moves away from the guide. Bulges will show when the rim moves toward the guide. When the wheel is concentric, the rim will remain an equal distance from the guide.

Adjustments in lateral trueness are done last. These generally have little or no effect on roundness. For example, on a 27-inch wheel, tightening a spoke one turn and loosening the next spoke on the rim one turn will shift the rim about one-eighth inch to the side where the spoke was tightened. This will have very little effect on concentricity.

Keep in mind, however, that there is no point in loosening a spoke that is already very loose. A wheel laced by the procedure given later in this chapter should result in approximately the right spoke tension or tightness. This can vary for a number of reasons. If you feel that the spokes are too loose, go around the wheel and tighten each one an additional quarter turn. If they are too tight, loosen each a quarter turn. Both too much and too little tension can lead to broken spokes.

Continue making adjustments until you are satisfied with the

lateral trueness of the wheel. Correct the major deviations first then take care of the minor ones. Make a final check of the concentricity. If this still looks okay, the truing is completed.

Although a truing stand is a fairly accurate gauge for centering a wheel, it's still a good idea to check this with wheel aligning gauge as shown in Fig. 5-23. This is especially important on rear derailleur rims. Place the tool flat against the rim on one side. Set the gauge to

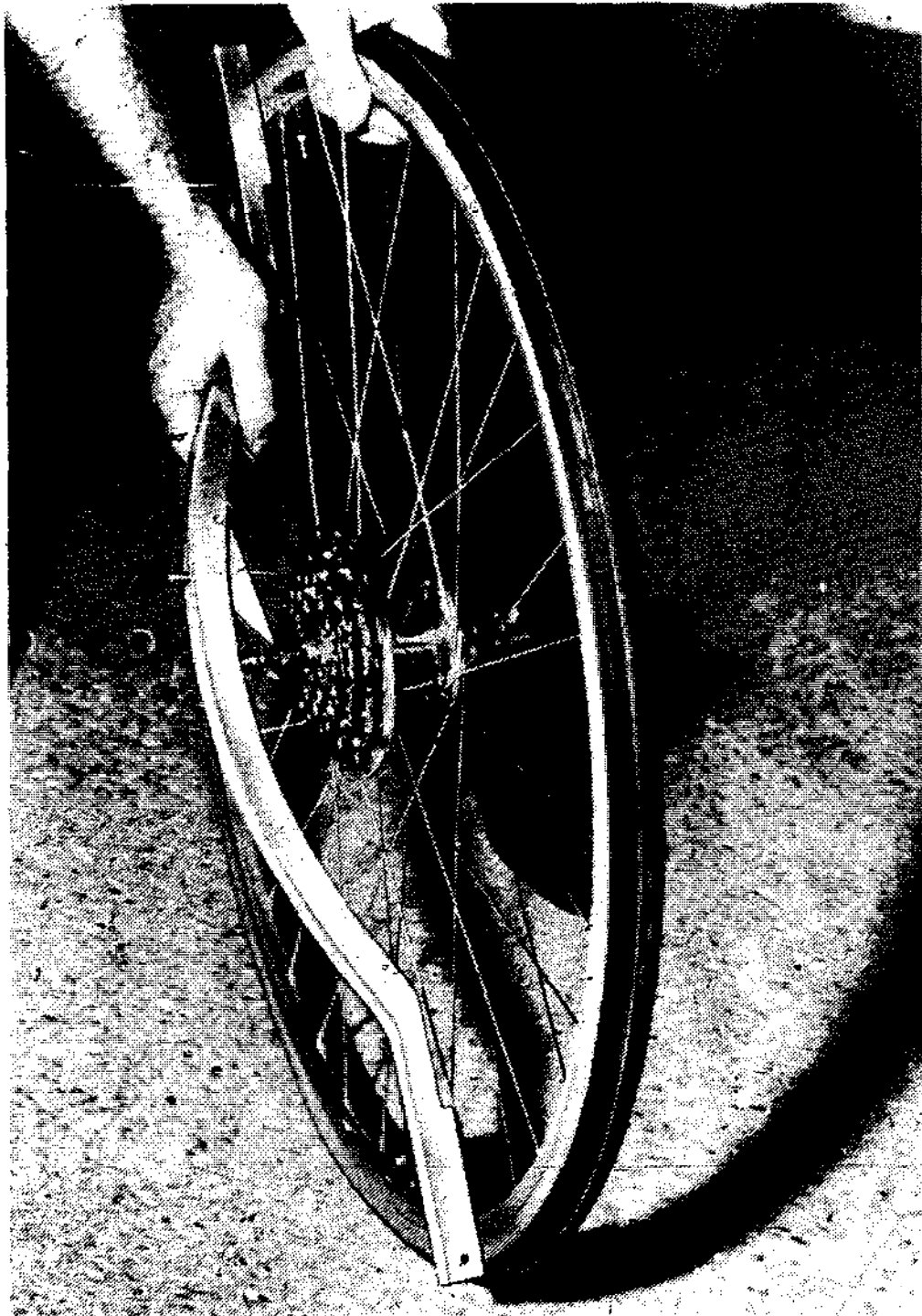

Fig. 5-22. Wheel centering gauge

mark the inside area where the axle joins the frame. Move the tool to the other side of the wheel. The measurement should match. If not, it will be necessary to loosen all spokes from one side of the hub and tighten all of those on the other until the rim is centered. Then check wheel trueness again in a truing stand.

### STRAIGHTENING RIMS

In most cases, only minor corrections can be made. If there are any sharp bends in the rim you will probably have to replace the rim. Steel rims are generally easier to straighten than alloy rims. But this depends on the extent and area of damage.

### PROTRUDING SPOKES

Before putting a rim liner over a clincher rim or cementing on a sew-up tire to a tubular rim, check to make certain that no spokes extend beyond the nipples on the tire side of the rim. If any do, file them off until they are flush with the nipple and smooth. Also check to make certain that all nipples are seated properly.

### WHEEL LACING

There are situations where it is necessary to spoke a rim to a hub. Wheel lacing is actually quite easy once you get the knack of it. But it does take considerable practice before this point is reached. Unless you plan to do a number of wheels, you might want to leave this work to a bicycle shop.

A good way to learn wheel lacing is to get an old spoked wheel and use it like a puzzle. Take it apart and put it back together again. Use *liquid wrench* to free the nipples from the spoke threads the first time you take the wheel apart. The wheel can also be used to practice truing.

For an actual lacing job, you will need the correct length and size of spokes. If the rim and hub were previously spoked together, use an old spoke as a pattern. Take it to the bicycle shop with you when buying new spokes. Most shops have charts that give spoke lengths and cross patterns. This is the specific number of head-down spokes each head-up crosses over. The most common crosses are three or four.

On some wheels, especially those used on derailleur bikes, the spokes will be interlaced. This means that the head up spoke crosses *over* all but the last of the spokes in the crosses and crosses *under* the last one. It should be noted that the lacing arrangement

will have considerable effect on the strength and stiffness of the wheel.

The hub will generally have the same number of spoke holes as the rim. Usually from about 18 on some very small wheels to 40 holes on some 27-inch wheels. For some special projects described in this book, other combinations can sometimes be used. For example, it is possible to spoke a small 18-hole rim to a 36-hole hub by skipping every other hole in the hub. This will work as long as the pattern is symmetrical. You can get the correct length of spokes

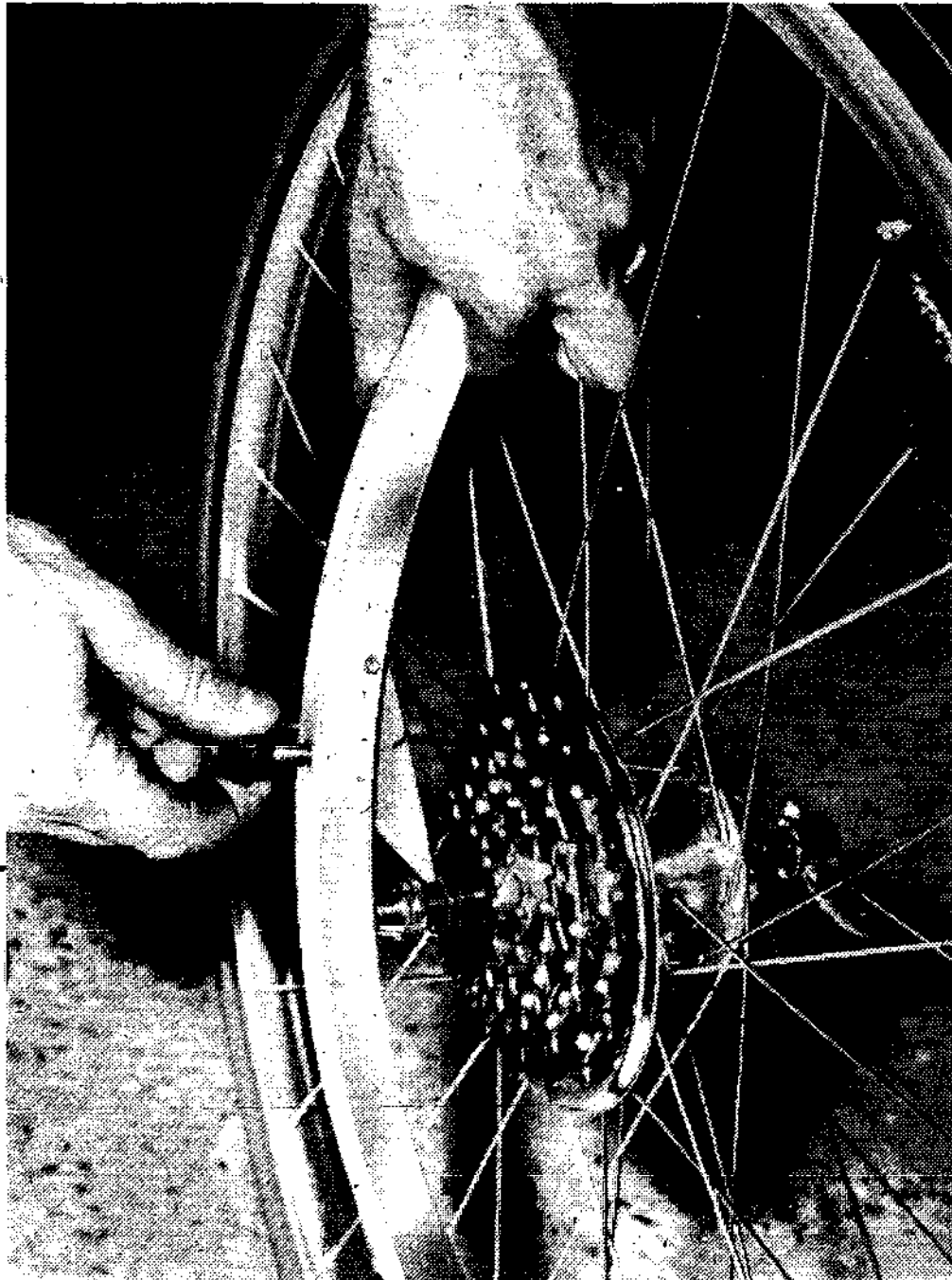

Fig. 5-23. Using a truing gauge to check lateral centering of wheel.

and the spoked wheel will be sturdy enough for the intended use. If for any reason you cannot get the correct length of spokes, a workable substitute can sometimes be made by cutting off and bending to form a zig zag or loop at the hub flange hole.

Generally, high quality spokes are the most economical in the long run. I suggest that you do not mix brands in the same wheel. Not all nipples fit all spokes. Make certain you have ones that match.

When you are ready to lace a wheel—and have the hub, rim, nipples and correct length of spokes—the first thing to note is that the holes in the rim are drilled off-center. Every other hole is off to one side of the rim. The holes on opposite flanges of the hub are not directly across from each other. They are half way between. A hole on the flange on one side will line up exactly midway between two holes on the opposite flange.

Some hubs have countersunk holes. These are not to set the spoke heads flush, as might be imagined, but to reduce stress from a sharp bend in the spoke. The spoke head will be on the flat side and not the countersunk side.

I find it convenient to drill a hole in a workbench so that the axle, if in the hub, can extend down into the hole to hold the hub upright.

Begin by inserting spokes through the upward hub flange. Pass every other one through in the opposite direction. If the hub has countersunk holes they will determine the direction the spokes will pass through. The spoke will be inserted on the flat, non-countersunk side. If there are no countersunk holes, the choice is up to you. Just make sure that every other spoke passes through in the opposite direction. An easy way to do this is to insert every other spoke and pass them through in the same direction. Next, insert the remaining spokes on that end of the hub. They will all pass through in the opposite direction.

On most rear hubs the sprockets will have to be removed in order for the spokes to be passed through the hub. With clusters of sprockets on freewheels, it's generally easiest to remove the freewheel with the sprockets.

When all the spokes on one end of the hub are in place, bundle and hold spokes so they don't fall out and turn the hub over. Position the spokes through the holes on the other flange. Use the same placement procedure previously described.

With the hub positioned with one end in the hole in the workbench, position the rim for lacing. Start on the upper hub flange with any spoke that has the end of the spoke facing upward. Group all

other spokes in a bundle to the opposite side of the rim. Turn the rim so that it is positioned with the valve stem hole by the single spoke you have selected for starting. Insert the threaded portion of the spoke into a spoke nipple that is inserted in the upper—closest to the top of rim as positioned—rim spoke hole adjacent to the valve hole. Depending on the particular rim, this might be either to the right or left of the valve hole. Thread the nipple onto the spoke four full turns. Do this for all spokes. This assumes that you are spoking a hub that will be centered. There will be variations when spoking a derailleur hub that is off center. The differences will be covered later in this chapter. For now, assume that you are spoking a centered hub and use four turns on each nipple as you install the spokes.

Select the next head-up spoke on either side of the first spoke installed. This will be the second one away, as the next one on each side is head-down. This spoke will go to the rim in the fourth (skip three) rim hole from the one where the first spoke was installed.

Continue this pattern until all of the spokes on the top hub flange with the heads upward are in position and each are threaded four turns onto the nipple. If, for example, the wheel has a total of 36 spokes, nine should now be in place. There should be three vacant rim holes between each spoke.

Twist the hub so that the installed spokes are tight. This should be done in the direction that leaves no spoke crossing over the valve stem hole. The spoke adjacent to it should angle away. Check this carefully. This is a common mistake, which, if made, will lead to a spoke being in the way of the valve for inflating the tire.

Take any spoke in the top flange with the head downward. Going in the opposite direction of the spokes already in place, cross over the number of spokes corresponding to the crosses in the spoking pattern being used. This is generally either three or four. Skip one additional hole in the rim and thread the spoke into the nipple of the following rim hole. This should be a top rim hole.

This is the regular spoking pattern. If an *interlaced* pattern is desired, the spoke goes under—rather than over—the last spoke of the crosses.

Regardless of which pattern is used, continue with the same plan until all of the spokes with downward-facing heads in the top hub flange have been installed with the nipples tightened four turns. The rim should be half laced at this point with a spoke in every other rim hole. The pattern should be consistent. Check these points carefully. Do not continue until any errors have been corrected.

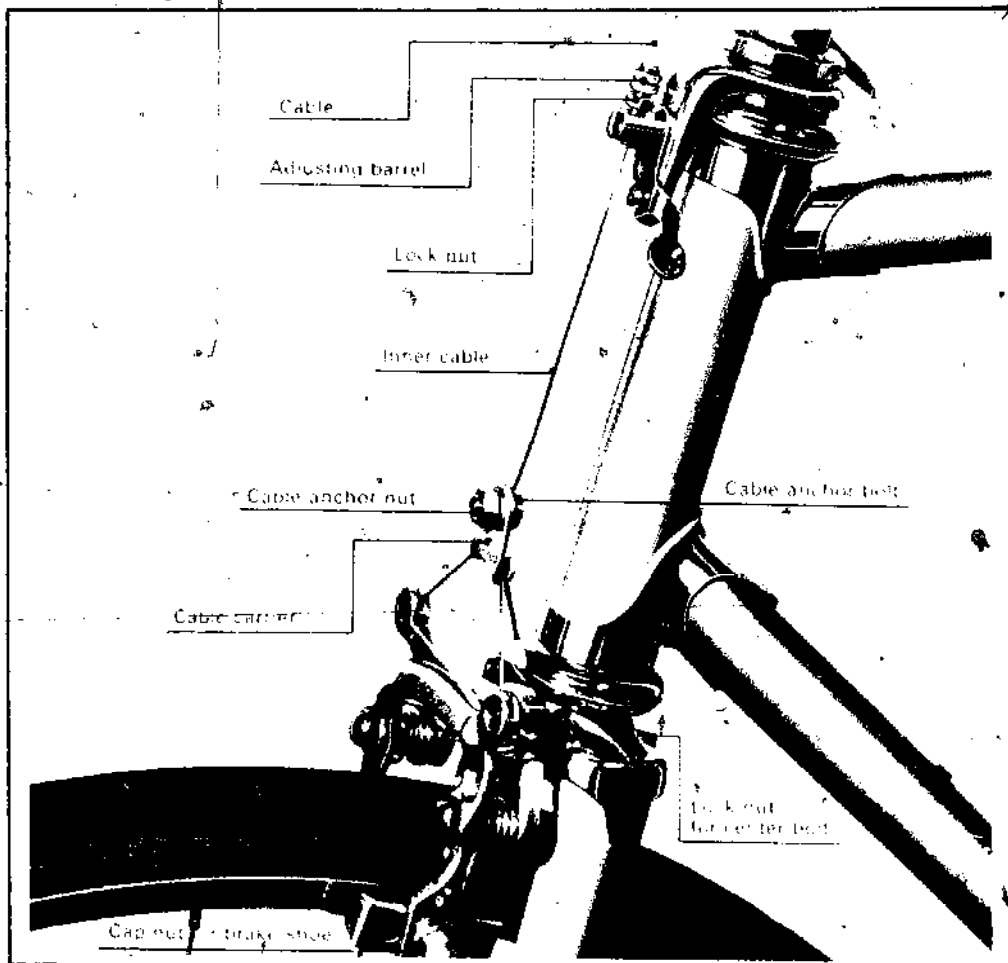

Fig. 5-24. Shimano Tourney center-pull type caliper brake.

Turn the wheel over. All unlaced spokes should now be on the top hub flange. Take any head-up spoke on the top hub flange. Locate the spoke that is head-up just to the left of this spoke on the bottom flange. Run the top spoke parallel to the bottom one and place it in the hole to the left of the bottom one. Thread it four turns into a nipple. Notice that the upper and lower spokes with the heads-up follow a consistent pattern. The distance from the hub flange by nature of the offset is the same for each spoke.

Using this pattern, lace all of the head-upward spokes in the top flange to the rim. If this has been done correctly, the pattern around the rim will be consistent with every fourth rim hole empty.

Take the remaining spokes in the top flange. They should all have heads downward. Lace them to the rim with the same cross pattern that was used previously. If an *interlaced* pattern is being used, don't forget to go *under* the last spoke in the crosses. The spokes should fit the only vacant rim holes that are in the right positions for the length of the spokes.

If everything has been done correctly, the spokes should be in a consistent pattern. All of them should have four turns onto the

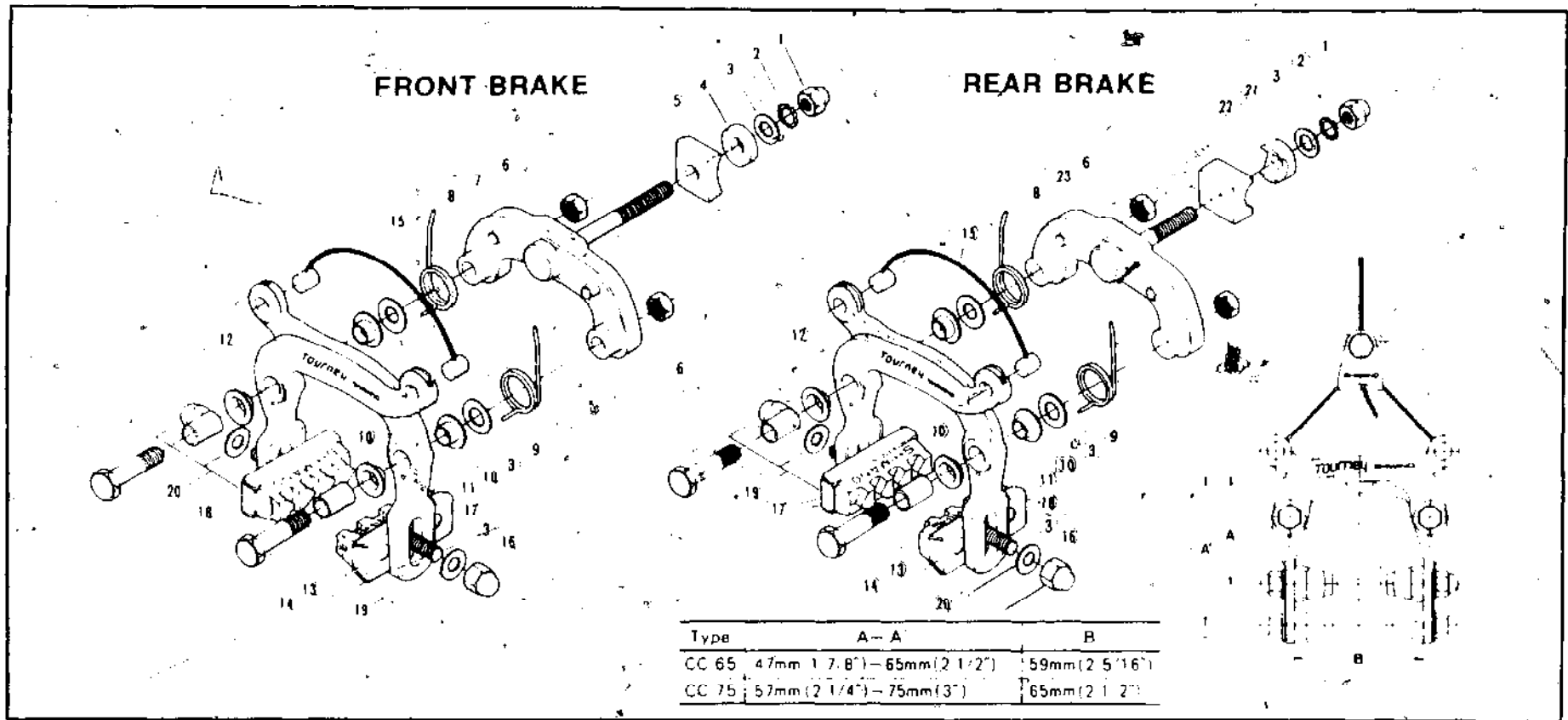

Fig. 5-25. Exploded views of Shimano Tourney center-pull caliper brakes. Parts are: (1) lock nut for center bolt, (2) toothed lock washer, (3) washer, (4) radius bushing—front, (5) square seating pad—front, (6) lock nut for pivot bolt, (7) arm bridge with center bolt, (8) L.H. arm return spring, (9) R.H. arm return spring, (10) flanged thrust washer, (11) inner brake arm, (12) outer brake arm, (13) bushing, (14) pivot bolt, (15) center cable, (16) cap nut for brake shoe, (17) brake shoe—left, (18) brake shoe—right, (19) brake shoe complete—left, (20) brake shoe complete—right, (21) radius bushing—rear, (22) square seating pad—rear, and (23) arm bridge with center bolt.



nipples and approximately equal tightness. If this is not the case, the problem is one of three things:

- You have made a mistake in the spoking pattern.
- You have used the wrong cross pattern.
- The spokes were the wrong length.

If you spoke a rear hub that has a dishing effect, the initial lacing is the same except that different length spokes are used for each hub flange with the shortest length on the sprocket side. A less desirable but still satisfactory method is to use one length of spokes and take care of the dishing by spoke adjustment. Lace the wheel first with four turns on each nipple the same as is done for a centered hub.

For all wheels, the next step is to tighten all nipples. For a front or centered rear hub and for dished rear hubs where two different lengths of spokes are used, tighten all nipples until the threads on the spokes are just covered. For dished wheels where one length of spokes are used, screw all spokes on the sprocket side down until the threads are just covered. Then tighten all spokes on the other side until about four threads are still visible. The dishing effect is achieved by having the spokes on the sprocket side tighter. The total effect is to have the rim centered when mounted in the bicycle frame.

The wheel is now ready for truing, as detailed previously in this chapter. It should be apparent that wheel lacing and truing is both an art and science. It's something that you have to develop a feel for. For high level racing, even experts spend hours truing a single wheel.

## **CALIPER BRAKES**

The two basic types of caliper brakes are center-pull (Fig. 5-24 and Fig. 5-25) and side-pull (Fig. 5-26). The center-pull brakes consist of a hand lever, cable housing, cable hanger, cable, cable carrier, transverse wire, brake caliper and brake shoes. The side-pull brakes consist of a hand lever, cable housing, cable, brake caliper and brake shoes.

Unless otherwise noted, the following material applies to both types.

### **Hand levers**

Fig. 5-27 shows one type of hand lever and Fig. 5-28 is another type. Most levers are similar to one of these two types.

Some hand levers have a quick release device that allows opening the lever wider than normal. This opens the brake-pad calipers further than usual and makes wheel removal easier.

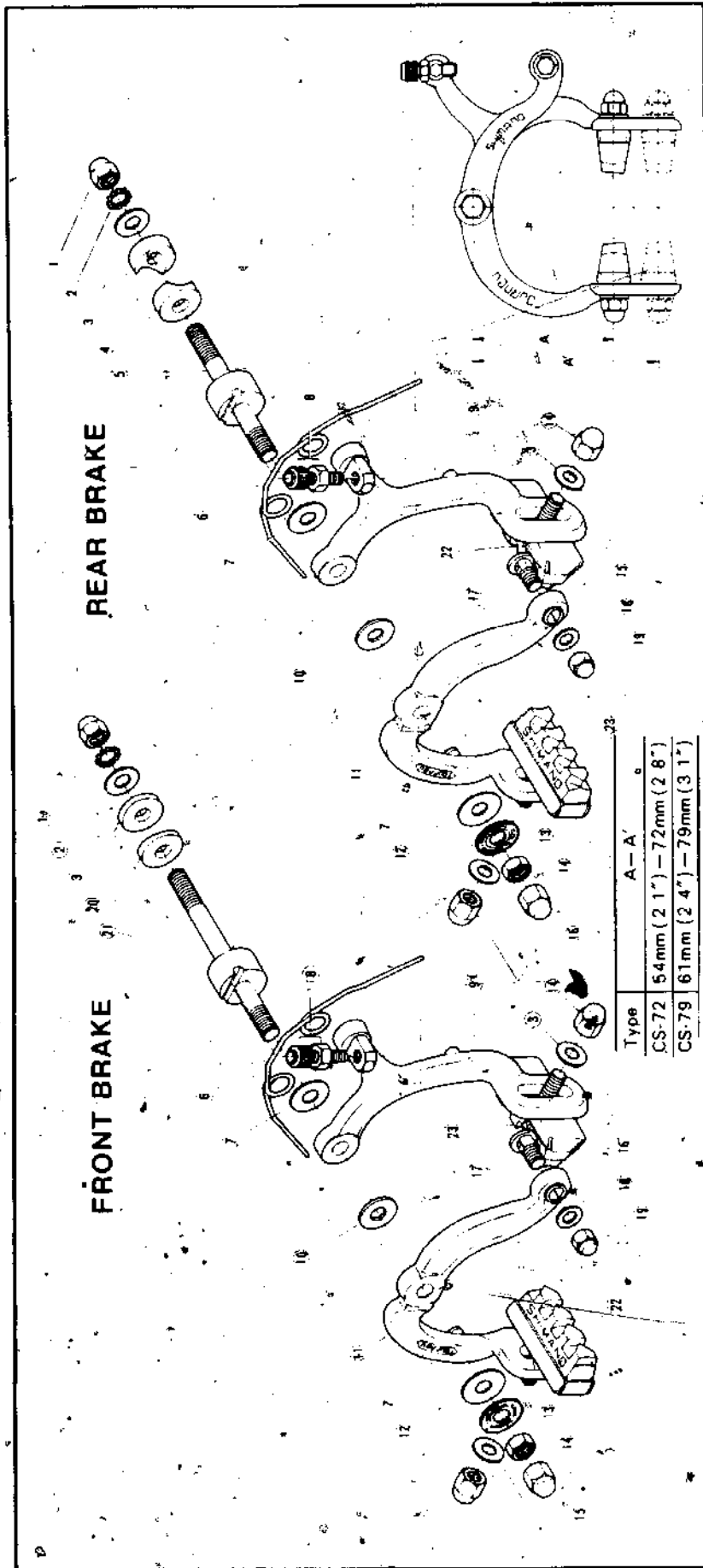

Fig. 5-26. Exploded views of Shimano Tourney side-pull caliper brakes. Parts are: (1) lock nut for pivot bolt, (2) toothed lock washer, (3) washer A, (4) radius bushing—front, (5) pivot bolt—front, (6) arm return spring, (7) arm washer, (8) cable adjusting barrel and nut (9) brake arm Y shape, (10) arm spacer, (11) brake arm C shape, (12) washer C, (13) lock nut, (14) cap nut, (15) brake shoe complete—right, (16) brake shoe complete—left, (17) cable anchor bolt, (18) washer B, (19) cap nut, (20) radius bushing—rear, (21) pivot bolt—rear, (22) brake shoe—right and (23) brake shoe—left.

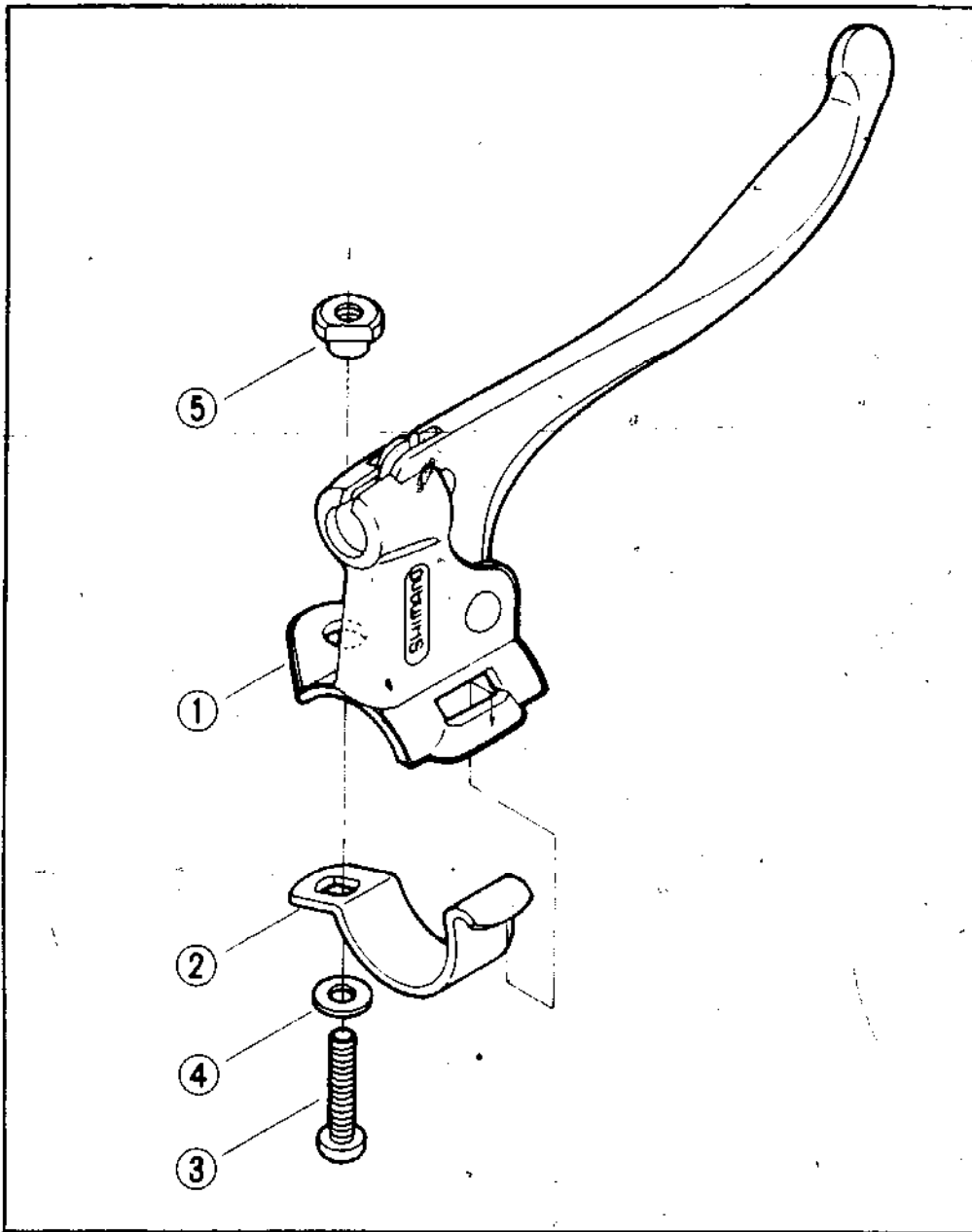

Fig. 5-27. Shimano Model MD-100 brake lever. Parts are: (1) lever bracket complete, (2) clamp, (3) lever fixing bolt, (4) lever fixing washer and (5) lever fixing nut.

To remove a hand lever, first clamp brake shoes tight against the rim. Fig. 5-29 shows a special tool, called a *third hand*, that is ideal for this. The holes fit over the nuts on the brake pads.

Some caliper brakes have a quick release for slackening brake cable. Some center-pull models have a means of disconnecting one end of the transverse cable. If not, loosen the cable at the anchor bolt and pull out enough cable so that hand lever moves freely. Try not to pull the cable completely out of anchor bolt. It might be difficult to thread back in. If you are going to remove the cable from the housing anyway, don't worry about this.

Loosen the hand lever clamp. A screwdriver can be used for either type. A special brake lever screwdriver (Fig. 5-30) is handy for the ring type. Remove the hand lever from the handlebars.

### Cable Replacement

Loosen the anchor bolt on the brake caliper and disconnect the cable. The cable is pulled out from the hand lever end. On slotted levers, the cable is disconnected from lever before removal.

A replacement cable should be at least as long as the old one and have the same shaped lead end. When purchasing a new one, take the old one along to the bike shop to make certain you get the right replacement.

Check the cable housing and if necessary, replace it.

Lightly grease the cable. Thread the cable through the housing. Connect the cable to the hand lever. Thread the other end of

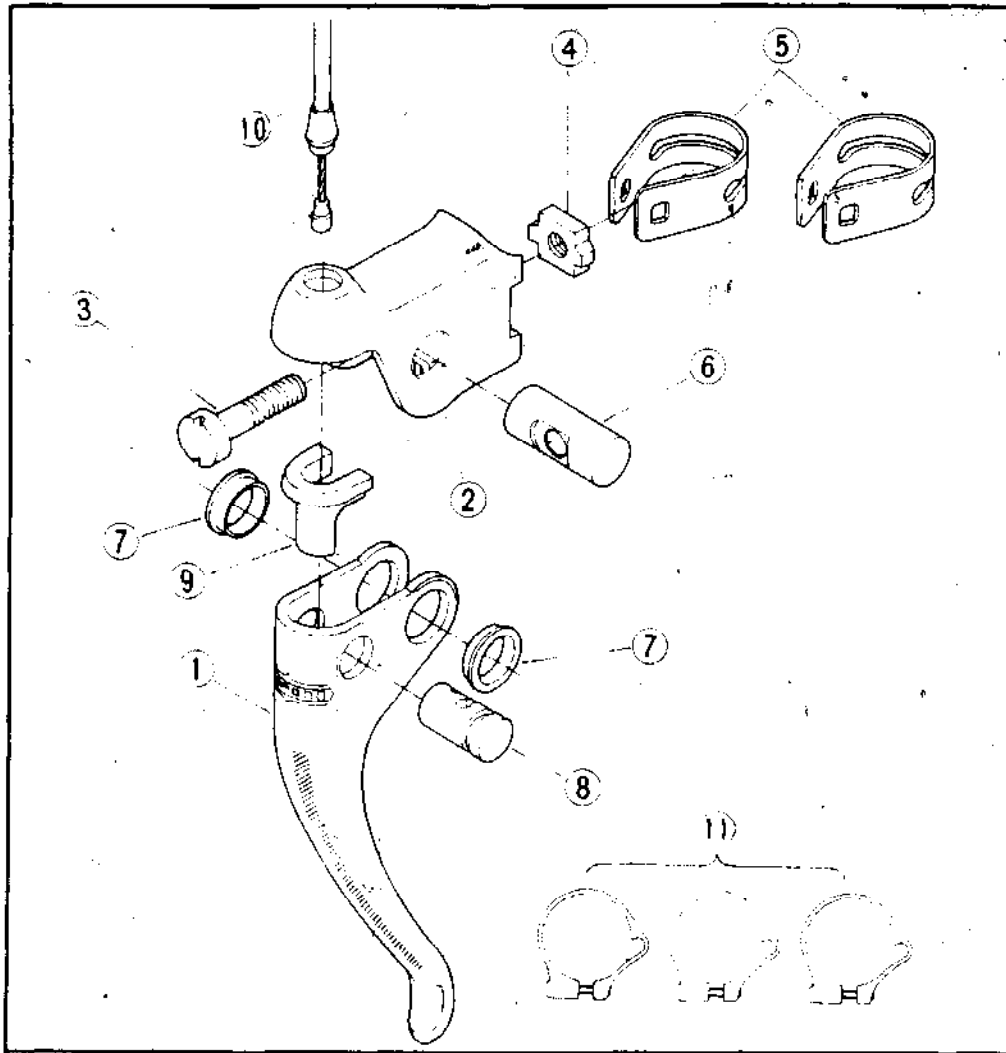

Fig. 5-28. Shimano Model MB-100 brake lever. Parts are: (1) lever, (2) lever bracket, (3) pull up bolt, (4) pull up nut, (5) clamp, (6) pull up stud, (7) flanged thrust washer, (8) cable anchor stud, (9) lever adapter, (10) cable set and (11) outer band for one-inch tube.

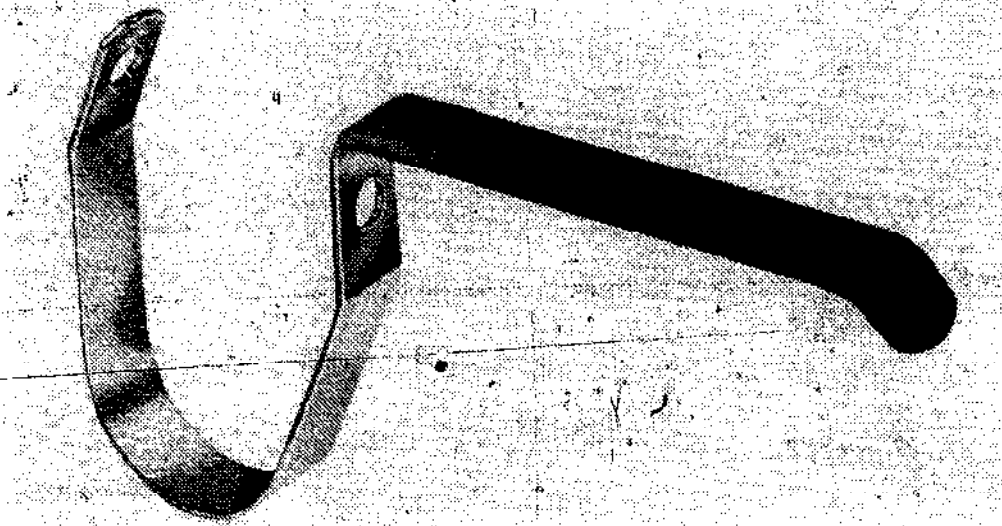

Fig. 5-29. Park "third hand" tool.

cable through the anchor bolt. Do not cut off excess cable until after the brakes have been fully adjusted.

### Adjusting

First check brake pads. These wear out from use or harden from age. Generally, all four brake pads are replaced at the same time.

You can purchase either the rubber pads separately or you can buy the entire brake shoes. The latter are slightly more expensive, but generally worth the difference if the old brake shoes are even slightly damaged—especially the threads.

Two methods of attachment are in common use. One has a threaded stud on the brake shoe. This is secured to the brake arm by a lock washer and nut—usually an acorn nut. The other method of attachment is with an unthreaded stud on the brake shoe that fits into an eye bolt on the caliper arm. It firmly holds the brake shoe in place and permits greater shoe adjustments than the first method. The latter, however, is generally used only on center-pull designs.

In making replacements, remove old brake shoes. If replacing pads only, slide out old pads and replace them with new ones.

Install brake shoes on brake arms. The closed end of the metal holders, if on one end only, should face forward on the bicycle so that friction against the rim when braking will not force the pads out of the holders.

Regardless of whether you are using brake pads that are worn or have installed new ones, the first step in making adjustments is to check the alignment of the brake shoes. These should be in line with

the edge of the rim. If not, loosen the brake shoe mounting, align the shoe with the rim and retighten. If no adjustment is required, you should still make certain that the brake shoe mountings are tight.

Both brake pads on a caliper should be the same distance from the rim. If not, loosen the caliper mounting nut and turn calipers until shoes are both the same distance from rim. Retighten the caliper mounting nut.

Properly adjusted, the brake pads should be one-eighth inch from the rims when hand lever is released. In most cases, some adjustment is possible by turning the adjusting barrel. Try this first. If the required adjustment cannot be made in this manner, loosen

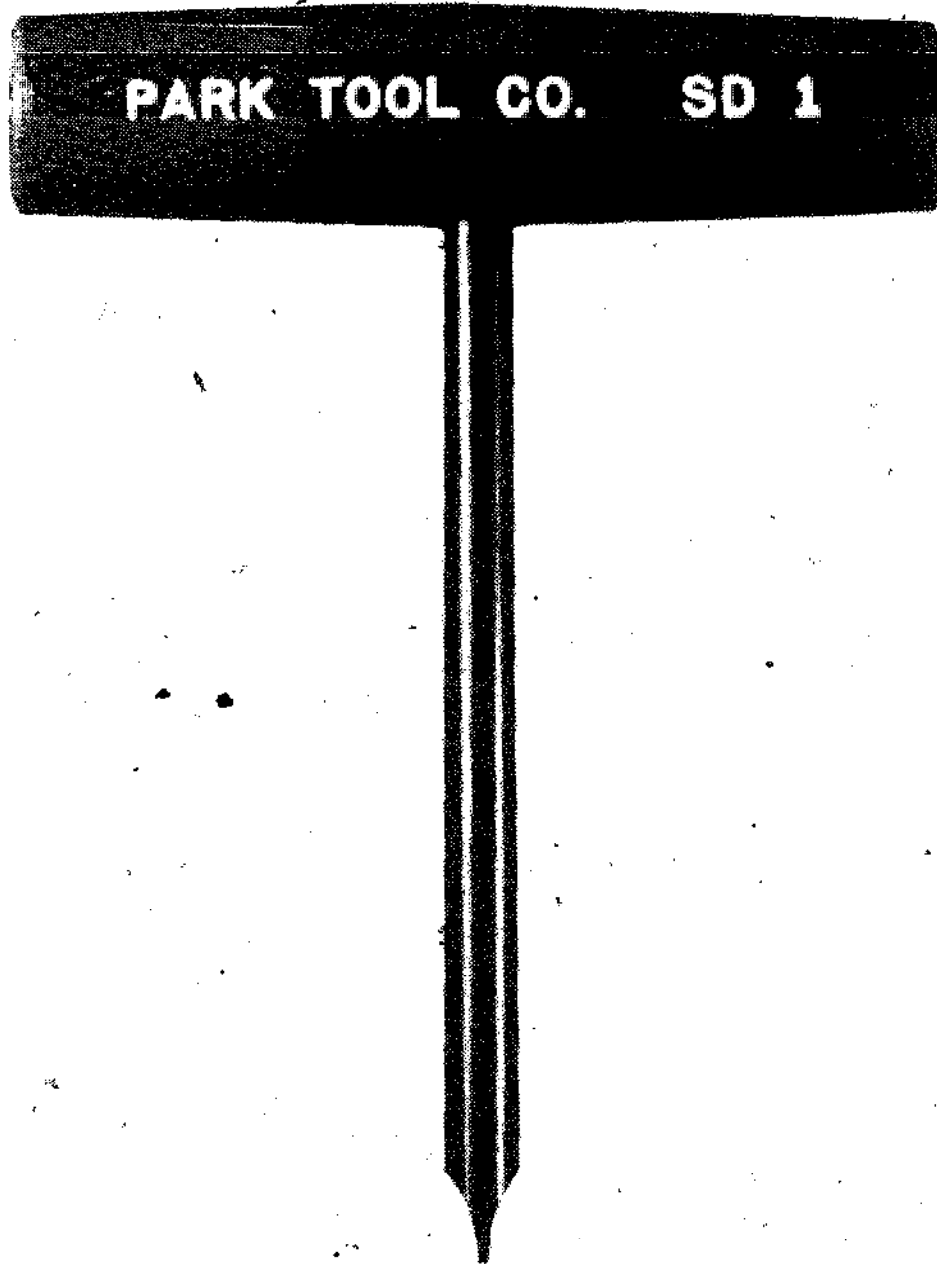

Fig. 5-30. Park brake lever tool.

the anchor, cable bolt or cable lock lever. Hold shoes one-eighth inch from the rim, pull slack out of the cable by pulling it past the anchor bolt or lever clamp and tighten the anchor bolt or lock lever.

### **Center-Pull Calipers**

Cleaning and lubricating can ordinarily be done without removing the calipers from the bicycle. A second method is to remove the calipers from the bicycle, then clean and lubricate them without disassembling them. Another method is to disassemble, clean, assemble and lubricate.

On inexpensive calipers, replacement parts are often difficult to find. You might have to replace the entire unit. Replacement parts are usually available for popular, expensive units.

To remove the caliper from a bicycle, loosen the cable anchor bolt and slide the cable free. Unfasten both ends of the transverse cable. Remove the mounting nut and washers and slide the caliper free. If the caliper is to be replaced, always try to get the same brand and model.

If you need to take the caliper apart, begin by removing brake shoes. If you do not have assembly drawings, make a sketch so that you can get the caliper back together again. Pry loose the ends of the springs on the stops on the brake arms. Remove pivot bolts and separate brake arms. Remove springs. They are not interchangeable. Mark left and right side springs.

Clean all parts in solvent except the brake pads. Inspect for wear and damage and make replacements as required.

Reassemble in reverse order. Lightly oil pivot bolts and holes before installing fasteners. Avoid getting oil on brake pads. Be careful when installing springs. They can injure fingers if they slip.

Adjust brakes as detailed in the section above.

### **Side-Pull Calipers**

There are many brands of side-pull calipers in use and most are similar. Before disassembling calipers to replace broken or damaged parts, find out if replacement parts are available. If not, you might have to replace the entire caliper—especially inexpensive ones.

To remove a caliper from the bicycle, loosen the cable anchor bolt and slide the cable free. Remove the mounting nut and washers and slide the caliper free. If you replace a caliper, use an exact replacement that is the same brand and model if possible.

If you need to disassemble a caliper, begin by removing brake shoes. If you do not have assembly drawings, make a sketch so that you can assemble them again.

Remove spring ends from stops on brake arms. Remove pivot fasteners. Separate brake caliper arms.

Clean all parts except brake pads in solvent. Inspect for wear and damage and make replacements as required.

Reassemble in reverse order, lightly oil the pivot bolts and holes before installing fasteners.

Adjust brakes.

### Trouble shooting

Most common caliper brake problems are:

- Sticking brakes. Usually caused by a bent caliper part or hand lever or a cable sticking in the housing because of damaged housing. After the problem area is located, corrections can often be made by bending parts slightly and applying lubrication.

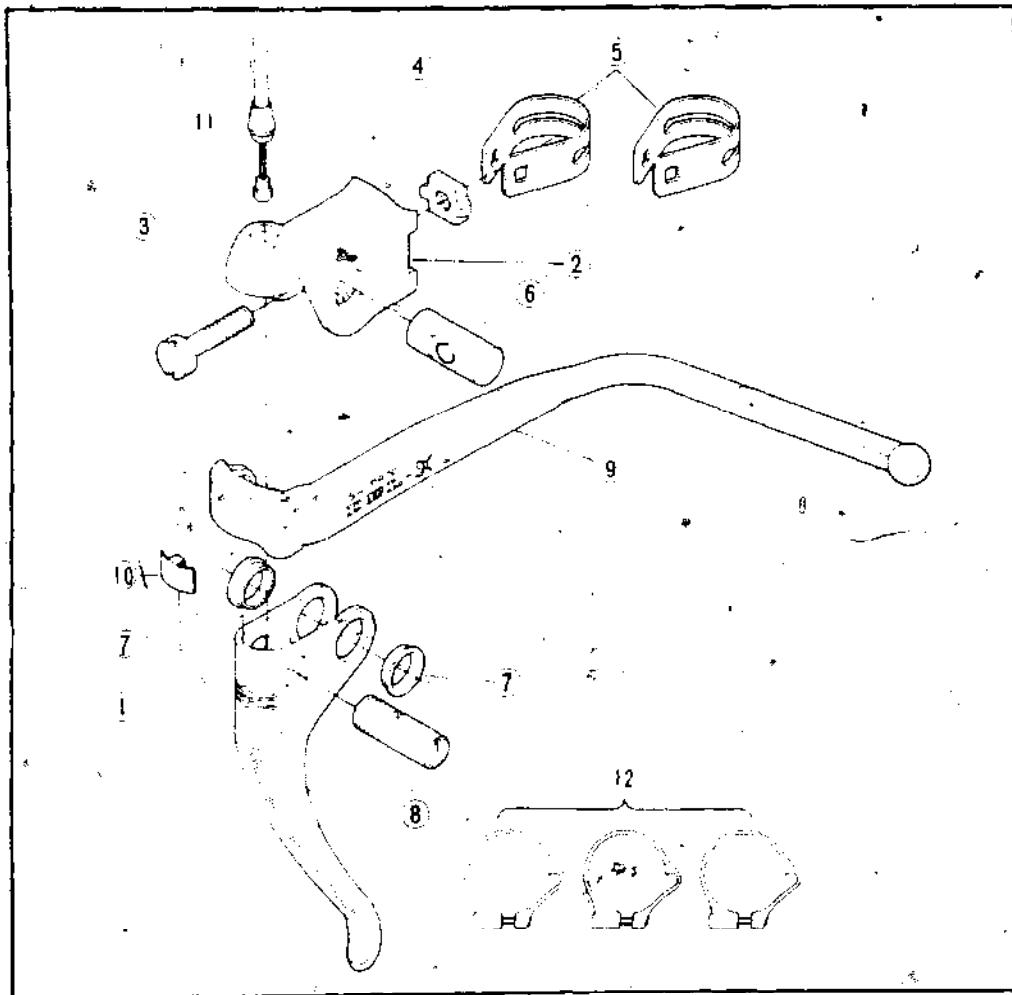

Fig. 5-31. Shimano Model MB-110 brake lever with extension lever. Parts are: (1) lever, (2) lever bracket, (3) pull up bolt, (4) pull up-nut, (5) clamp, (6) pull up stud, (7) flanged thrust washer, (8) cable anchor stud, (9) extension lever, (10) extension lever spring, (11) cable set and (12) outer band for one-inch tube.



- Dragging brake pad. Check shoe adjustments. The caliper should be centered when released. A problem also might be a loose mounting nut or sticking pivots. Avoid getting oil on brake pads. Sometimes the problem is wheel alignment.
- Cable frequently breaks. Usually some part of the cable housing is causing chafing. Check for burrs, bends and kinks in cable housing. The usual correction is to replace the housing.

### **Safety Levers**

Fig. 5-31 shows a safety or extension lever. A frequent modification is to add extension levers. Safety extension levers are available to fit most standard brake levers.

### **Hydraulic Caliper Brakes**

Mention of these should be made, as a few are now on the market and others are likely to follow. These use fluid and you bleed them to get the air out of the system.

### **DISC BRAKES**

Disc brakes are becoming increasingly popular. They offer all-weather performance, smooth braking action and allow continuous brake application on long downhill slopes (Fig. 5-32).

Figure 5-32 shows the assembly and parts of a cable operated unit. Hydraulic models are also available.

Disc brakes can also be added to many bicycles, but a special rear hub (Fig. 5-33) is required. The disc plate is attached to the left side of the hub in a manner similar to a fixed sprocket on a track bicycle.

### **PEDALS**

The three basic types of pedals are those that cannot be taken apart for overhaul or lubrication, the type with two rubber pads attached to a metal base by bolts—these can be disassembled for overhaul—and rattraps which are all metal.

#### **Pedals That Cannot Be Disassembled**

These pedals are the least expensive. They are available with both one-half inch and nine-sixteenth inch thread diameters. Make certain you get the right ones for your bicycle when selecting replacements.

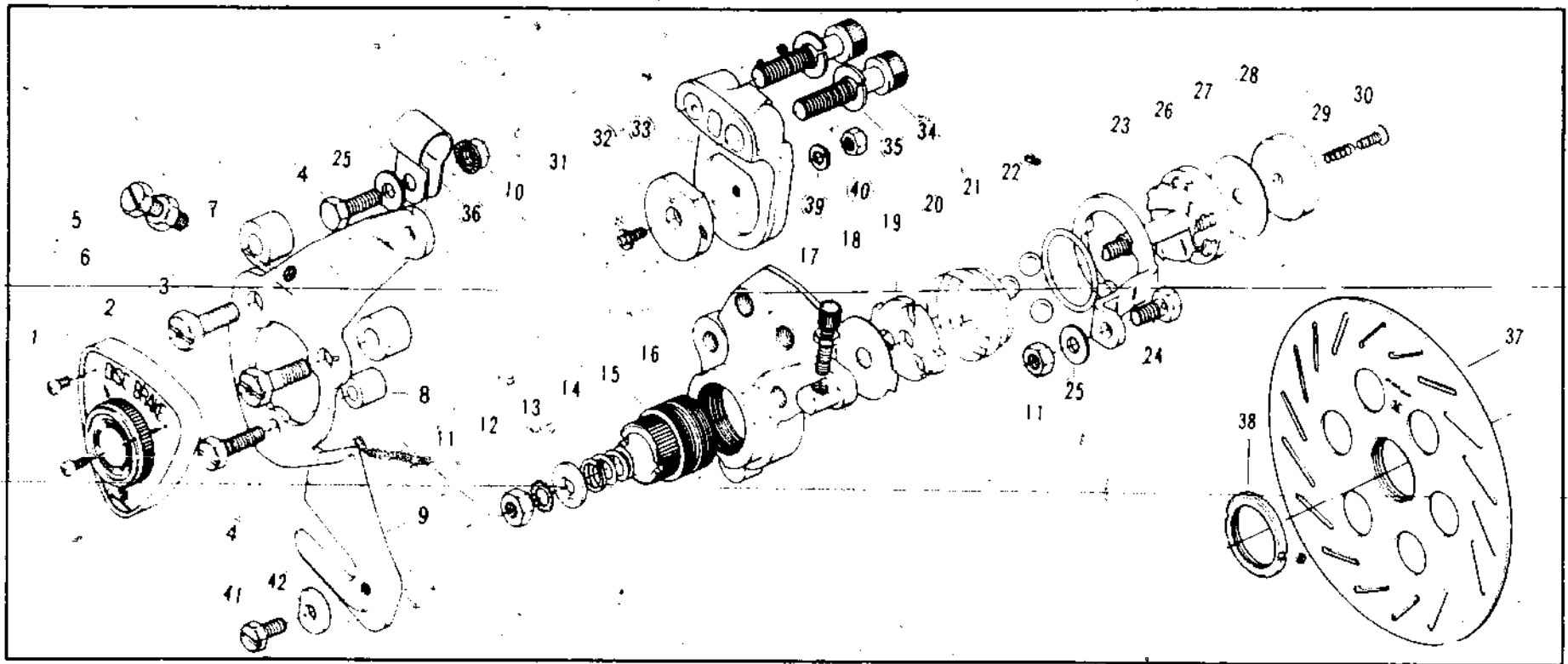

Fig. 5-32 Exploded view of Shimano Model BC-100 disc brake. Parts are: (1) cover fixing bolt, (2) bracket cover, (3) adjusting bolt A, (4) adjusting bolt B, (5) setting bolt, (6) setting nut, (7) adjusting rubber A, (8) adjusting rubber B, (9) bracket, (10) flange nut, (11) nut, (12) toothed lock washer, (13) non-turning washer, (14) return spring, (15) adjuster, (16) holder A, (17) cable adjusting bolt and nut, (18) ball plate, (19) ball retaining plate, (20) dust cover, (21) steel ball, (22) stop ring, (23) brake arm, (24) cable fixing bolt, (25) cable fixing washer, (26) cam plate with center pin, (27) thrust washer, (28) pad B, (29) non-turn spring, (30) countersunk screw A, (31) countersunk screw B, (32) pad A, (33) holder B, (34) through bolt, (35) spring washer, (36) clip band, (37) disc plate, (38) lock ring, (39) spring washer, (40) pad lock nut, (41) bracket fixing bolt and (42) bracket fixing washer

This type pedal is lubricated externally by squirting oil on the bearings. If they break down, they are usually discarded and replaced with new ones. For sidewalk bikes, this might be more practical than it seems at first thought. They usually give adequate service and are inexpensive to replace.

Left side pedals have left hand spindle threads. Turn clockwise to remove them. These are generally marked L on the threaded end of the spindle. Right side pedals have conventional right hand spindle threads and are marked R. Turn counterclockwise to remove them.

The pedals are not interchangeable and trying to thread them on the wrong side will damage the threads.

### **Rubber-Pad Pedals That Can Be Disassembled**

While these pedals can be disassembled for overhaul and repair, the vast majority that are in use probably have never been taken apart. These will generally give long service with no added lubrication or you can squirt oil on the bearings periodically.

To disassemble, remove the pedal from the bicycle. Remove nuts from long bolts that extend through rubber pedal pads. Slip pedal pads, bolts and dust cap off as a unit. This assembly only needs to be taken apart if replacement of any parts is necessary. The most typical replacements are the rubber pads.

Clamp the pedal spindle in a vise. Remove the lock nut, key washer and bearing cone. The two types of bearings are loose ball bearings and bearings in retainers. Remove the bearings, bearing cup, spindle housing, inner bearing cup and inner bearings.

Clean all parts except rubber pedal pads in solvent. Replace parts as required. With many inexpensive pedals, a bent spindle or other major damage might make it preferable to buy a new pedal rather than attempt to buy replacement parts. Replacement parts to fit most pedals, including spindles, are readily available.

When reassembling, add bicycle grease to the bearings. Hand tighten the bearing cone against bearings. Then back off a quarter turn. Keeping the cone in this position, slip on the key washer and then thread on the lock nut and tighten.

### **Ratrap Pedals**

To disassemble, remove the pedal from the bicycle. Remove the pedal spindle cap. This might be threaded on or held in place with small bolts. Remove the locknut. Slip off the keyed lockwasher. Thread off the cone and collect loose bearings or

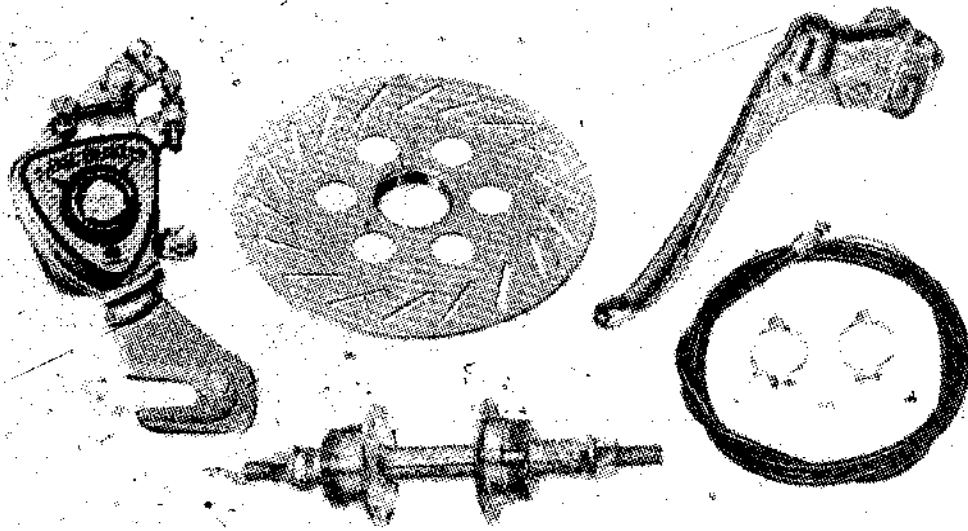

Fig. 5-33. Shimano disc brake set.

remove the caged bearing assembly. Slide off the pedal body. Collect loose inner bearings or remove the caged bearing assembly.

Clean all parts in solvent. Inspect for wear and damage and replace parts as required. When assembling, hold loose bearings in cups in pedal body with grease. The pedal body should be positioned with the inner cup upright. Slip the spindle in place. Hold it firmly against the bearings and turn the pedal over. Install bearings in grease in the outer cup. Install the cone. Assembly is greatly simplified when bearings are in retainers.

Finger tighten the cone. Then back off about a quarter turn. Install the keyed lock washer and locknut. Install the pedal spindle cap after checking to make certain that the pedal turns freely without end play. If not, make necessary cone adjustments.

While most rattrap pedals are lubricated with grease, some expensive racing pedals use oil. These require more frequent servicing, but have the advantage of minimum friction.

### **Toe Clips, Straps and Cleats**

Toe clips and straps are seldom used on pedals with rubber pads. Rattrap pedals with saw-tooth notches to prevent shoes from slipping can be used with or without toe clips and straps. Racing pedals generally do not have the saw-tooth notches. Shoes with a special cleat that fits the pedal are used with these. Cleats are not used for most other types of cycling.

Pedals with clips and straps already attached can be purchased or you can purchase clips and straps that will fit most rattrap pedals. The toe clips are generally bolted to the pedal and the straps pass through notches that are in most rattrap pedals.

Straps are available with buckles and quick release attachments. Toe clips are sometimes used alone. But most often the clips and straps are used together.

Straps might require replacement from time to time. The clips generally have a long life span before replacement becomes necessary.

While most cleats are used with toe clips and straps, a few cleats clamp directly to a special plate and are used without toe clips and straps.

## CHAINS

Chains used on single-speed and multi-speed hub geared bikes are usually classified as wide. Those on derailleur and single-speed track bikes are classified as narrow.

The wide chain is one-eighth inch wide,—the width of the rollers—usually with a one-half inch pitch which is the distance between the centers of the rivets. These chains have a master link for joining the ends together.

Narrow chains also generally have a one-half inch (12.7 mm) pitch, but have three-thirty-second inch (2.38mm) width. These are connected at all links by rivets. Master links cannot be used on chains for derailleur bikes. This extra width will not pass through the derailleur mechanisms or fit between the sprockets of the cluster.

The *Shimano Industrial Co* has recently introduced a 10 millimeter pitch chain and matching components called the *Dura Ace 10 System* (Fig. 5-34). The 10 millimeter pitch system reduces the overall weight and size of the components and offers the following outstanding features.

- The miniaturization of the components. The components are smaller in scale and lighter. By changing the chain pitch from 12.7mm to 10mm, the front chainwheel and rear sprocket wheel diameter have also been reduced by a corresponding factor of 10/12.7. The weight has been reduced by a factor of  $(10/12.7)^2$ . In terms of percentage, the front chainwheel can be made 21 percent smaller and, amazingly, almost 38 percent lighter.
- Increased efficiency. When the rotating parts are made lighter the accelerating efficiency is increased. The energy of the rider is transmitted to the bicycle faster and with less power loss due to components mass and friction. This means that hills can be climbed faster and pedaling on the straights is also easier.

Fig. 5-34. Shimano Dura Ace 10 (for 10mm pitch chain) series is marked with white squares. Other components are Dura Ace for standard 12.7mm pitch chain.

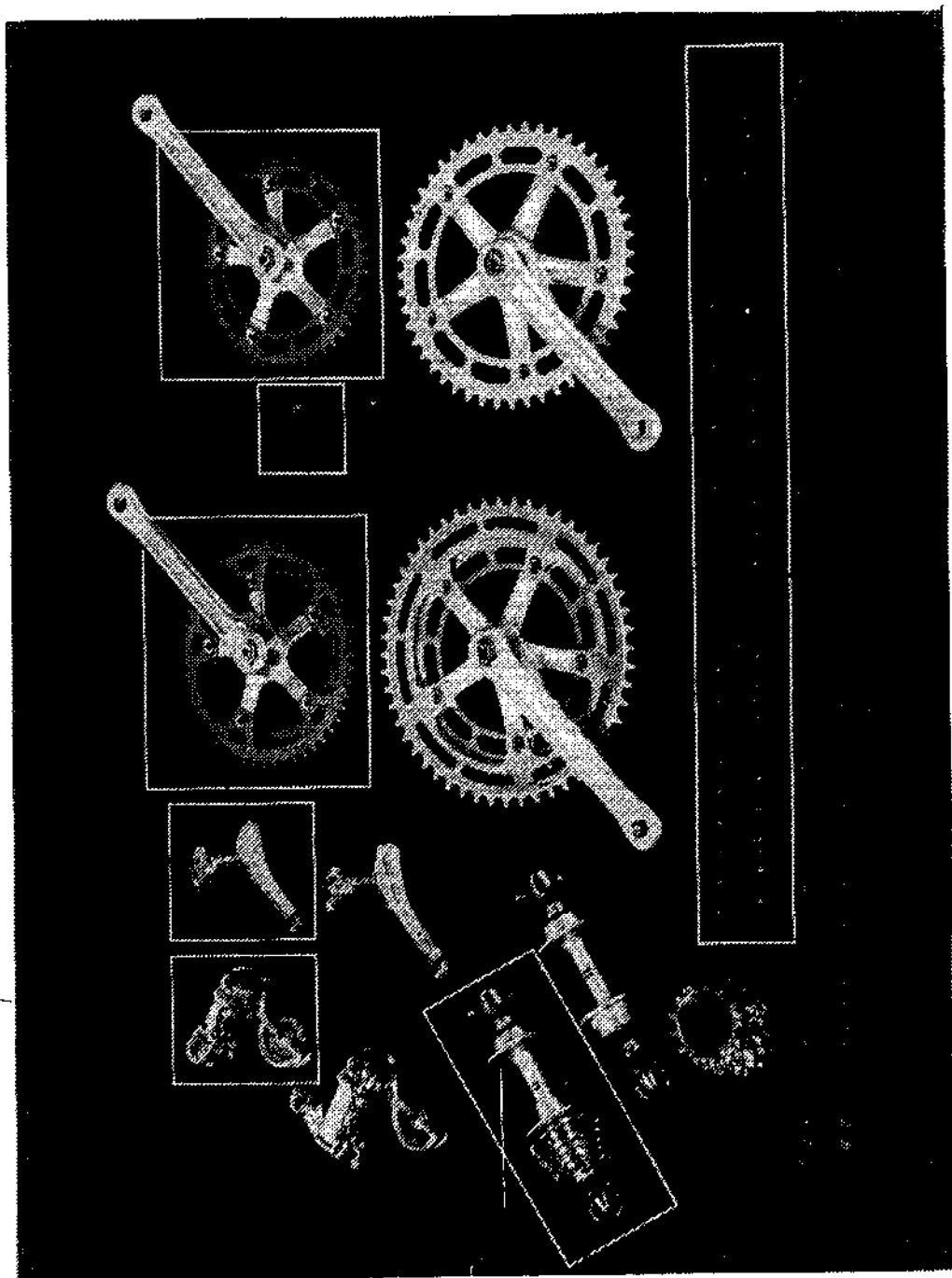

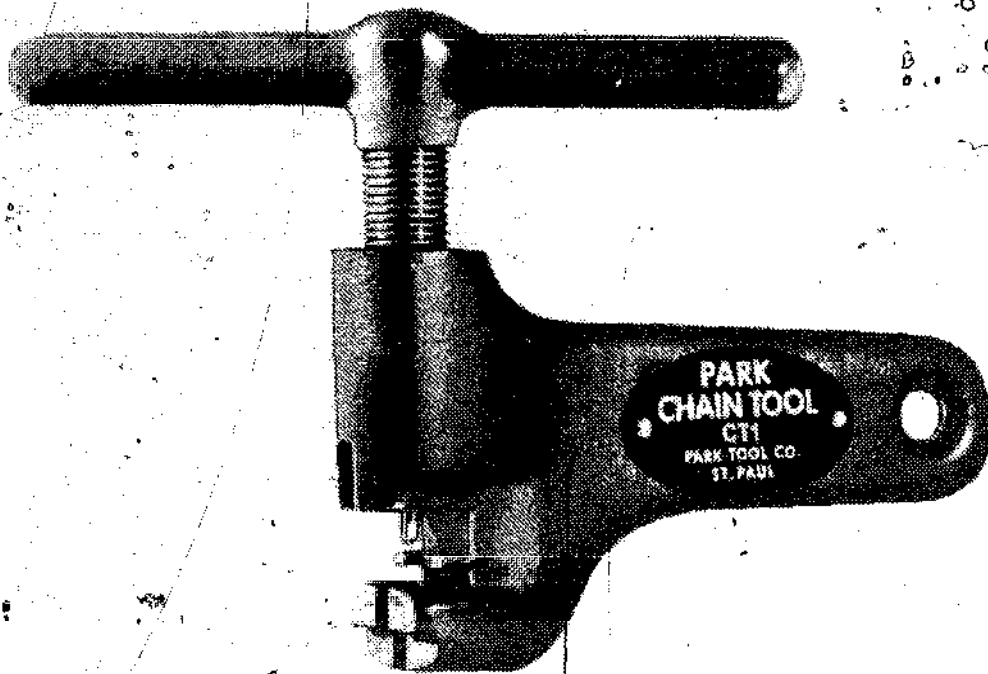

Fig. 5-35. A screw-type chain tool.

- Smaller components withstand deflection better. Since the front chainwheel diameter is smaller, bending or warping due to deflection is kept at a minimum. This results in less wasted effort and also contributes to increased speed.
- Gear shifting is easier. Because the teeth of the rear sprocket wheel are shorter, the derailleur need not raise the chain so high in the shifting process. Therefore, the shifts are faster and smoother with less power loss.

### Chain Removal

If you have a wide chain, loosen the rear hub axle nuts and slide the hub forward to slacken the chain. Locate the master link which is wider than a normal link. Flex the chain and pry the master link off with a screwdriver. Remove the link posts and backing plate. These slide out as a unit.

If you have a narrow chain, a rivet extractor tool is required. The two basic kinds of extractors are the screw type (Fig. 5-35) and plier type (Fig. 5-36). Open the extractor tool and slip it over the chain. Line it up with a rivet and then close the extractor until the rivet is free of all but the last plate. Do not drive the rivet all the way out. Figure 5-37 and Fig. 5-38 show the use of extractor tools.

Remove the extractor tool. The chain can now be separated. After removal, clean the chain by soaking it in solvent. A stiff brush can also be used. Allow the chain to dry.

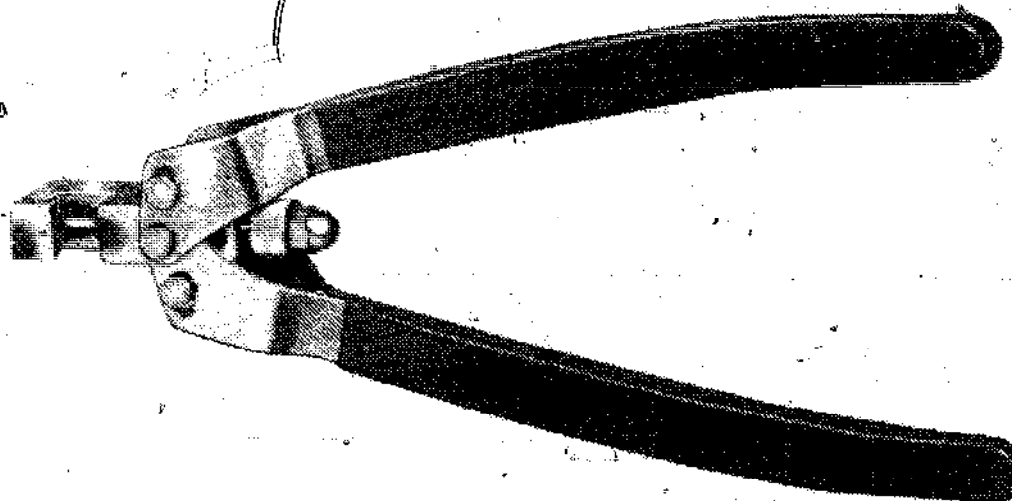

Fig. 5-36. A plier-type chain tool.

### **Lubricating**

Soak the chain in pan of bicycle chain oil. Then hang chain up, preferably overnight and allow it to drip dry. Use a collection pan. Obviously, this is not a job to do in your living room. After the chain has dripped dry, use a cloth to remove any remaining excess oil. The chain is then ready to be reinstalled on the bicycle.

### **Chain Installation**

With a wide chain, place the chain over the front and rear sprocket teeth. Insert the backing plate with two posts in holes in

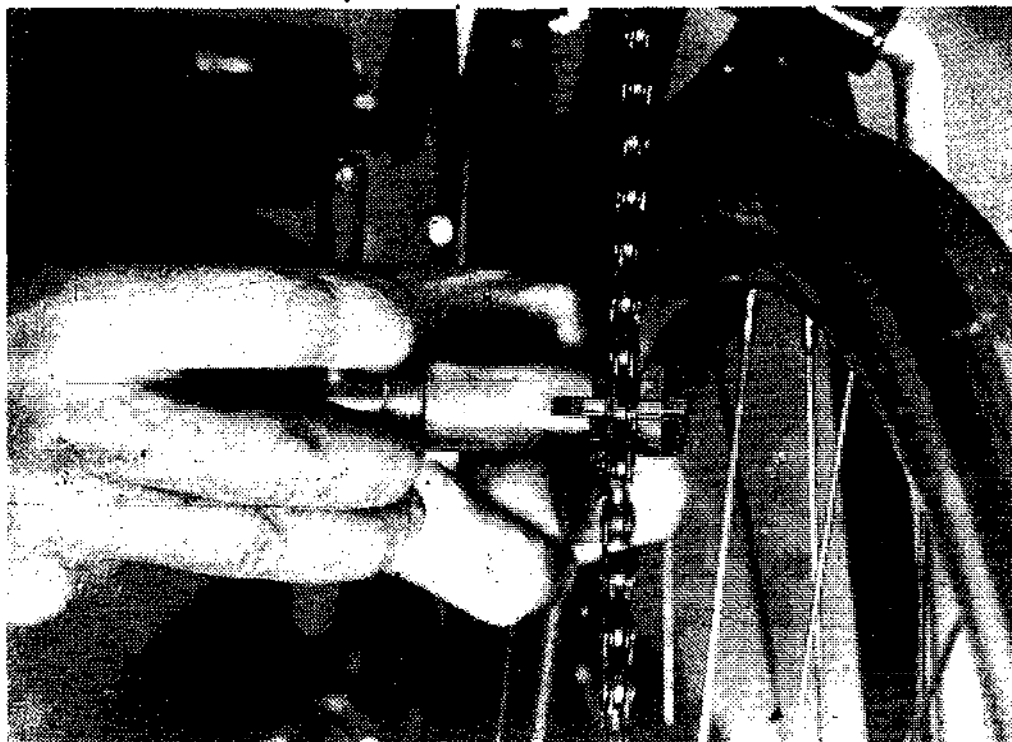

Fig. 5-37. Using a screw-type chain tool.



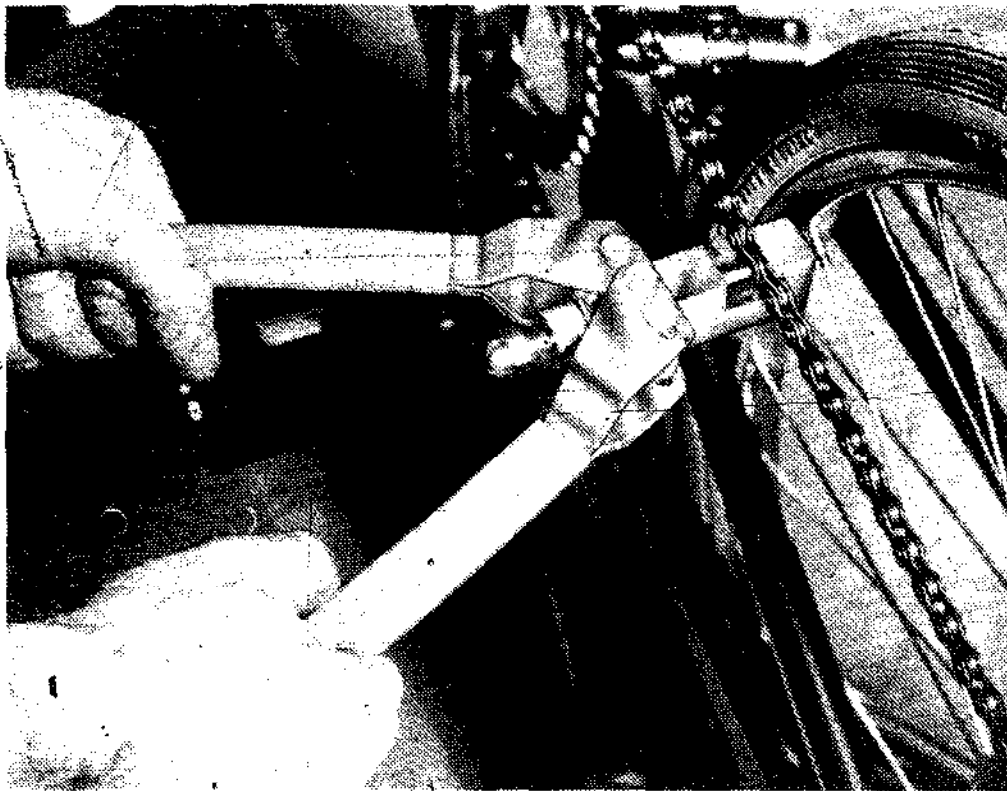

Fig. 5-38. Using a plier-type chain tool.

the chain to join ends. Position the master link and bend the chain towards you. Snap the link into place.

Reposition the rear hub and tighten axle nuts. The chain should have approximately one-half inch of slack in it. If not, loosen axle nuts and readjust. Make certain the wheel is centered between frame drop-outs.

With a narrow chain, the extended rivet should face away from the bicycle. Feed this end of the chain around the smallest chain-wheel. The other end is fed around the smallest rear sprocket and through jockey and idler pulleys. Bring the two ends together and use the chain tool for driving the rivet back into position.

### **Replacing Links**

A broken or defective link can be replaced by driving out rivets with a chain tool. Replace links and, if necessary, rivets. Use the same tool to drive them back in. Rivets can be started into a side plate by holding them in position with needle-nosed pliers and tapping them in place.

On a wide chain, a defective link can also be replaced with a master link. Use an extractor tool to remove a defective link.

In a similar manner, adjustments can be made in chain length. When selecting a new chain, use the same length as the old chain.

## Tight Links

This is a frequent problem when chains are not oiled periodically. If bicycle chain oil will not cure the problem, use a rivet extractor tool to move the rivets of sticking links slightly to one side and then back into position. A freeing oil can also be used to advantage here. Apply oil, use the tool to move a rivet to one side and then back.

If side plates are bent or if the above steps will not cure sticking, install new links to replace sticking ones. If there are many sticking links, it's generally best to get a new chain.

## CRANK SETS

For our purposes, a crank set consists of an axle, crank or pedal arms, a chain wheel—plus the necessary bearings, cups, washers and locking devices to hold everything in place in the bottom bracket of the bicycle frame.

### Types of Crank Sets

Three basic types of crank-axle assemblies are used on modern bicycles:

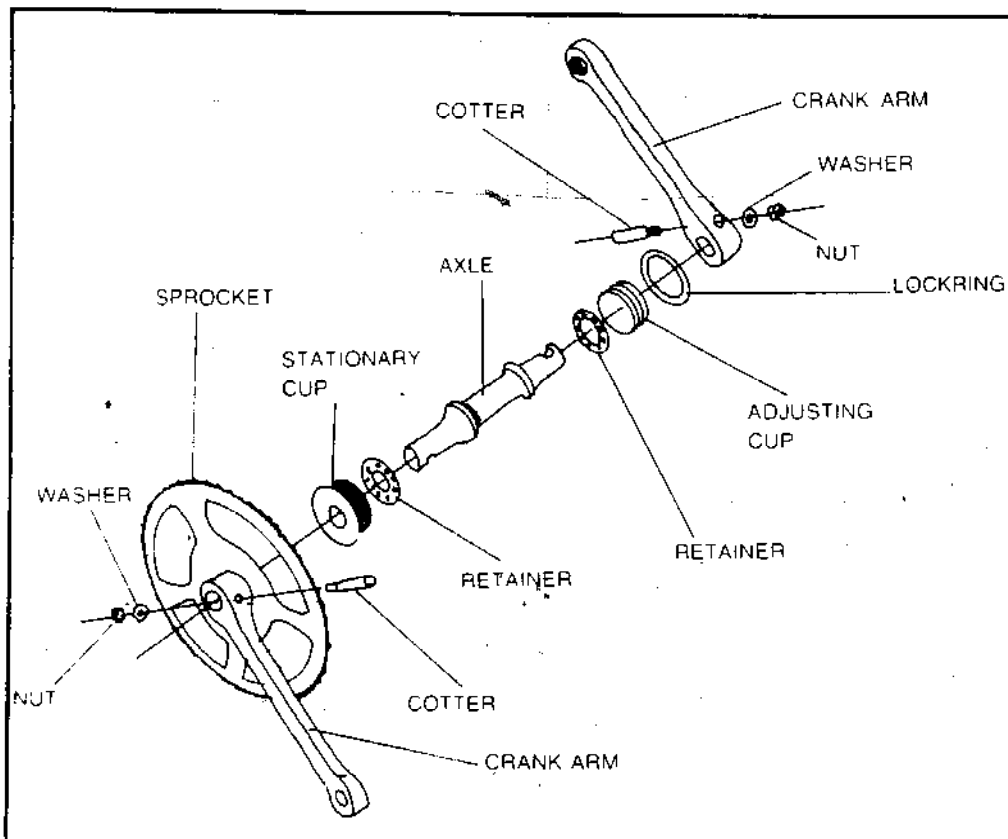

Fig. 5-39. A cottered crank assembly.

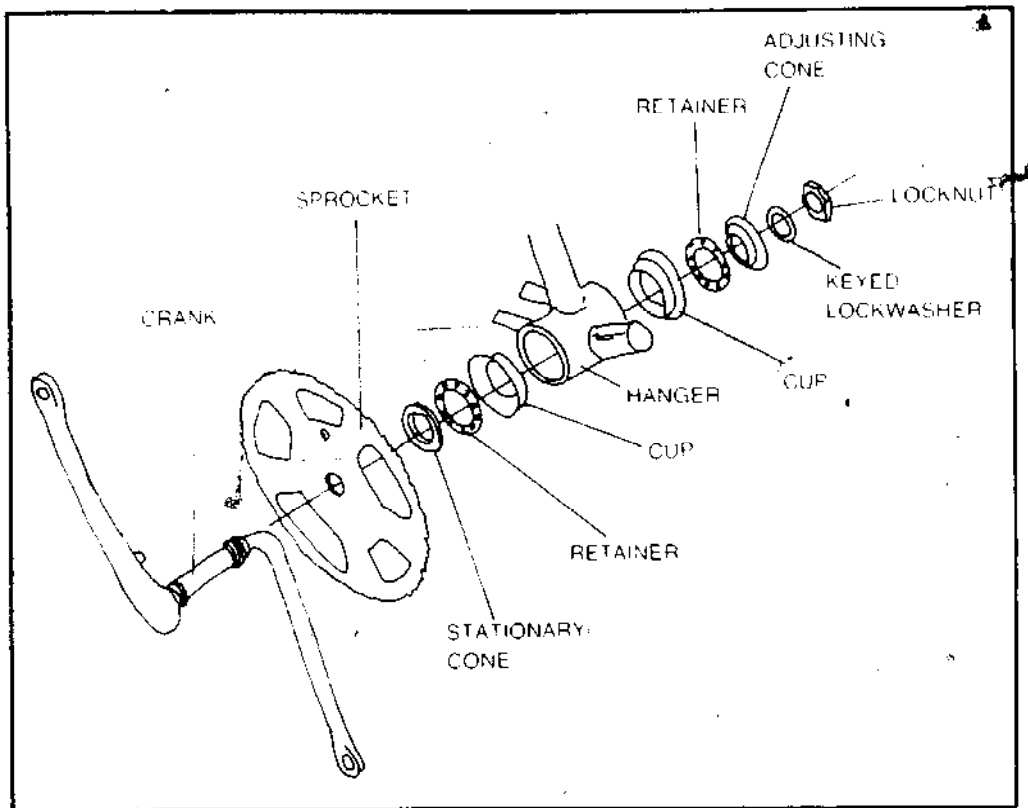

Fig. 5-40. A one-piece crank and hanger assembly.

—One-piece steel forged axle and cranks in a single unit, Fig. 5-39.

—Cottered crank assemblies (Fig. 5-40). Pedal arms are attached to separate axle by means of cotters which are tapered pins with a threaded end for nut tightening.

—Cotterless crank assemblies (Fig. 5-41) with crank arms drawn on to wedged ends of the axle by crank bolts.

The axles for both cottered and cotterless assemblies are almost always steel. The pedal arms for cottered assemblies are generally steel. Those for cotterless are usually lightweight aluminum alloy.

A few years back, bicycles were largely in price ranges by the type of crank assemblies used. The least expensive had the one-piece, the medium priced models had the cottered and the higher priced had the cotterless. There are many exceptions to this today. I've seen cheap versions of cotterless assemblies used on 10-speeds sold at discount stores for about \$100.

### Overhauling

The basic procedure is to disassemble, clean, inspect, replace parts as required, lubricate, and reassemble.

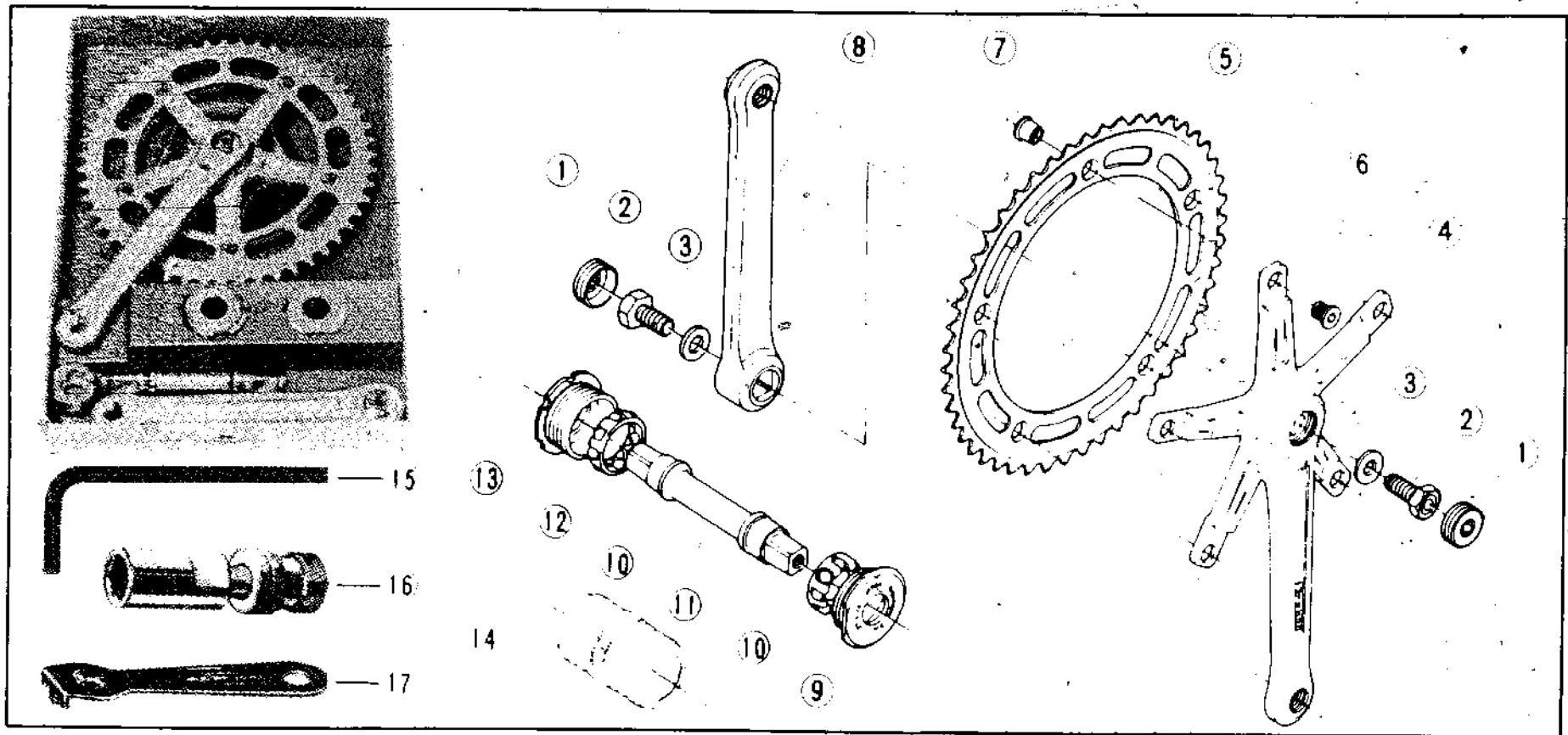

Fig. 5-41. Shimano Dura-Ace Model GA-100 crank set with track-type chainwheel. Parts are: (1) crank arm dust cap, (2) spindle bolt, (3) spindle washer, (4) right crank arm, (5) chainwheel, (6) chainwheel fixing bolt, (7) chainwheel fixing nut, (8) left crank arm, (9) R.H. fixed cup, (10) steel ball retainer for bottom bracket, (11) bottom bracket spindle, (12) L.H. adjustable cup, (13) lock ring, (14) dust seal, (15) hexagon wrench key, (16) cotterless crank extractor and (17) peg spanner

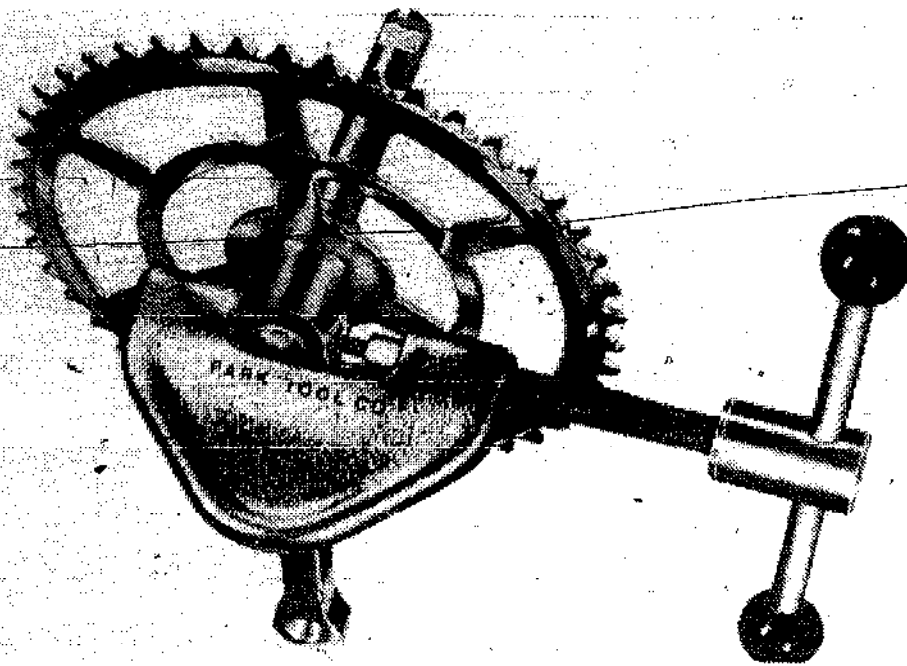

Fig. 5-42. A cotter tool.

Disassemble one-piece cranks as follows:

Remove the chain guard and chain. Remove both pedals. Since the threads are left hand threads on the left pedal, turn the pedal spindle clockwise. The pedal on the chainwheel side is turned counterclockwise for removal.

Remove the lock nut on the left side. This has a left hand thread, so it is turned clockwise for loosening. The required leverage is gained by using a wrench on the lock nut while holding the crank arm with one hand. After the lock nut is clear of threads, slide it off over the pedal arm.

Remove the keyed lockwasher. Remove the adjusting cone by turning it counterclockwise with a screwdriver in one of the slots. When the adjusting cone is clear of the threads, slide it on off over the pedal arm.

Slide out the bearing and retainer assembly. Unless worn or damaged, the hanger cups need not be removed. The crank can now be slipped out on the sprocket side of the frame. Remove the bearing and retainer assembly from the sprocket side.

If it's necessary to remove the chainwheel from crank, remove the stationary cone. The sprocket can then be copy out a wood dowel extending through the bottom bracket hole from the opposite side of the frame and a hammer.

Clean parts in solvent. Inspect all parts for wear and damage. Methods for doing this are given later in this chapter. Replace parts as required.

Reassembly is basically the reverse of disassembly except that bicycle grease is added to the bearings and cups. The adjusting cone is tightened until the cranks still turn freely, but without play. Then install the keyed lock washer and lock nut. They should be tightened firmly. Install chain, chain guard and pedals.

With the bicycle in a maintenance rack or with the back of bicycle held off floor, work the cranks. They should turn freely and have almost no play. If not, remove the lock nut and lock washer and readjust the cone.

The crank set should be serviced in this manner once a year or more often. However, most bicycles with this type of crank sets are not serviced at all. Although there is a loss of precision, most still give long service. At any rate, I feel that this type of crank set is the best bet for utility bicycles that are going to have minimal or no regular maintenance. On the other hand, the overhauling is really quite easy—especially after the first time—and probably well worth the trouble.

For cottered crank assemblies, disassembly begins by removing the cotters (Fig. 5-40). A special tool, shown in Figs. 5-42 and 5-43, is used for removing cotters. First remove the nut and lock washer from cotter. Open the jaws of the cotter removal tool. Position the tool as shown and turn the handle to drive the cotter out. The same tool can also be used to set cotters.

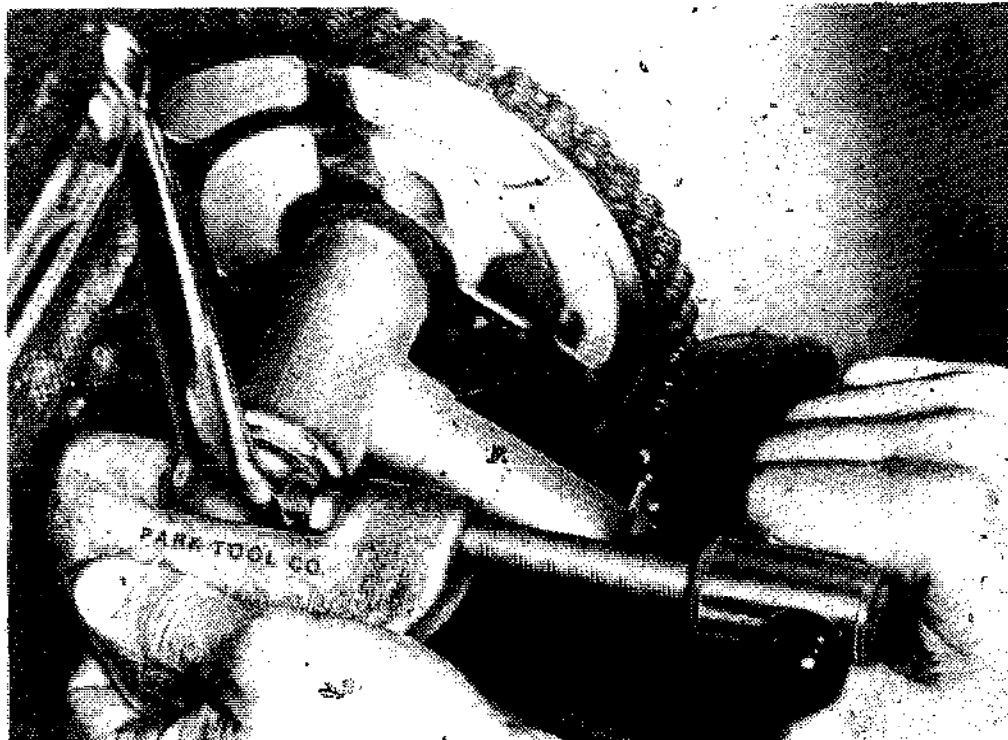

Fig. 5-43. Using a cotter tool.

If the special tool is not available, the cotters can be driven out with a hammer. However, this method leaves much to be desired and damage to cotters frequently results even if care is taken.

To use the hammer method, loosen the nut on cotter until it is flush with the end of the cotter. Place the pedal arm on a bench or block so that tapping out the cotter will not place stress on the bearings or axle. A block of wood can be used between the hammer and the cotter, but a single, sharp tap to the cotter directly with the hammer often works just as well.

After the cotter has been removed, work the crank arm free of the axle. On the chainwheel side, the chainwheel will come off with the crank arm. Some chainwheels are permanently fixed to the pedal crank. Others can be disassembled by removing mounting bolts.

After both crank arms have been removed, unfasten the lock ring from the left side (Fig. 12-1). There is a special hook spanner tool for this. If you don't have one, you can get by with a punch and hammer. Although, again this is poor technique.

Remove the adjusting cup with a wrench by turning counterclockwise. Some models require a peg spanner wrench. Some crank sets have loose bearings and others have bearings in a retainer. If you are uncertain about yours, be prepared to catch loose bearings. Take the adjusting cup all the way off.

If bearings are in a retainer, remove it from the assembly. The axle can now be pulled out the left side. Next, remove the stationary cup on the right hand side. If bearings are not in a retainer, catch the loose bearings. If the bearings are in a retainer, remove this from the housing.

Clean all parts in solvent. Inspect parts for wear and damage. Methods for doing this are given later in this chapter. Replace parts as required.

For reassembly, reverse order of steps for disassembly except that lubrication is applied to bearings. Loose bearings can be held in place by positioning them in grease during the assembly. Tweezers are handy for placing the bearings. The adjusting cup should be tightened until the axle turns freely with only a trace of end play. Install and tighten lock ring.

The best way to seat cotters is with a cotter tool. Position the crank arm on the axle. Position the cotter in the hole. Position the cotter tool and then tighten until the cotter is firmly set.

If you do not have a cotter tool, a substitute method is to position a block of wood so that stress will not be placed on bearings

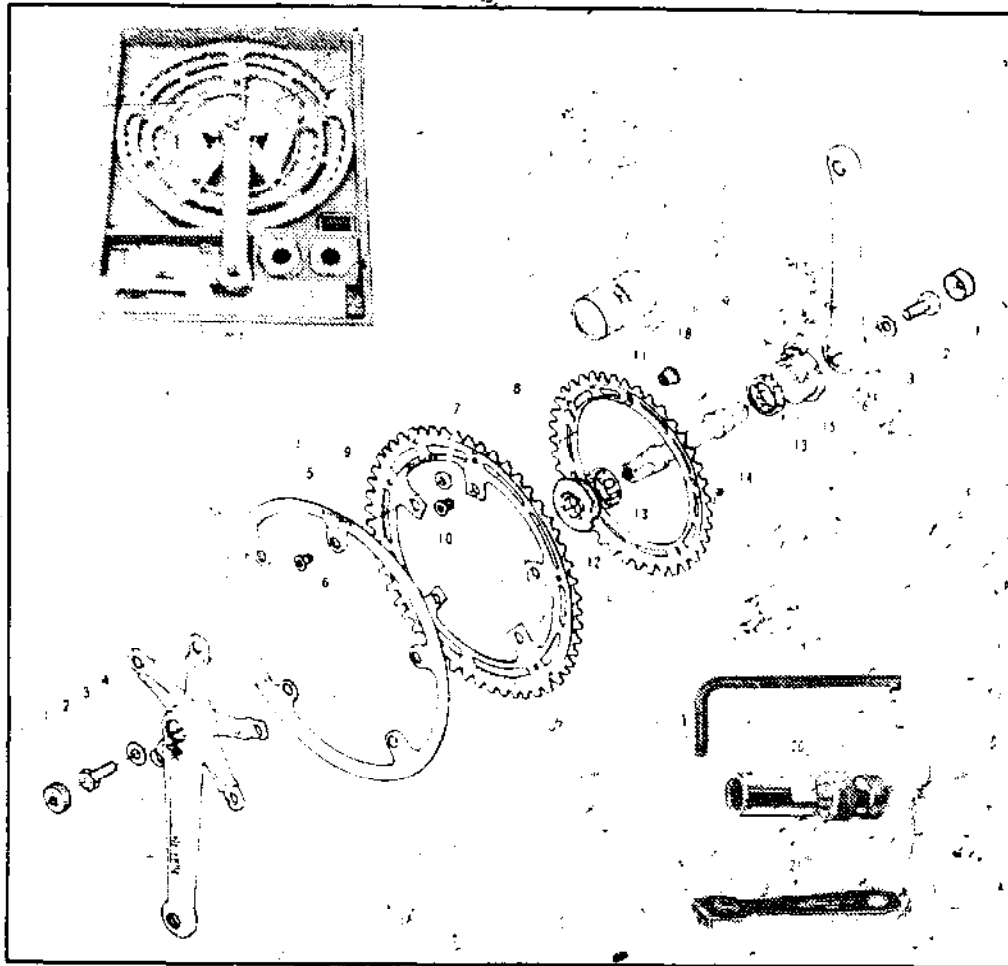

Fig. 5-44. Shimano Duar-Ace Model GA-200 crank set. Parts are: (1) crank arm dust cap, (2) spindle bolt, (3) spindle washer, (4) right crank arm; (5) chain guard, (6) guard fixing bolt, (7) guard fixing spacer, (8 and 9) chainwheel, (10) chainwheel fixing bolt, (11) chainwheel fixing nut, (12) R.H. fixed cup, (13) steel ball retainer for bottom bracket, (14) bottom bracket spindle, (15) L.H. adjustable cup, (16) lock ring, (17) left crank arm, (18) dust seal, (19) hexagon wrench key, (20) cotterless crank extractor and (21) peg spanner.

or axle. Then tap the cotter with a hammer to seat it. Install the lock washer and nut and tighten down.

Make certain that cotters are firmly seated. This is a frequent source of trouble. A slight play between the axle and pedal arm will quickly lead to wear and damage. It's a good idea to check this again after the bicycle has been ridden.

Fig. 5-44 shows a cotterless assembly and the tools needed to overhaul it. Other than the method of attachment and removal of pedal arms from axle, overhaul is basically the same as described above for the cotted crank assemblies.

The procedure for removal of crank arms is the same for both arms. Begin by removing the dust cap. Some models require an Allen wrench and others a wide-blade screwdriver. Next, remove the crank or spindle bolts. A socket wrench or special tool (Fig.



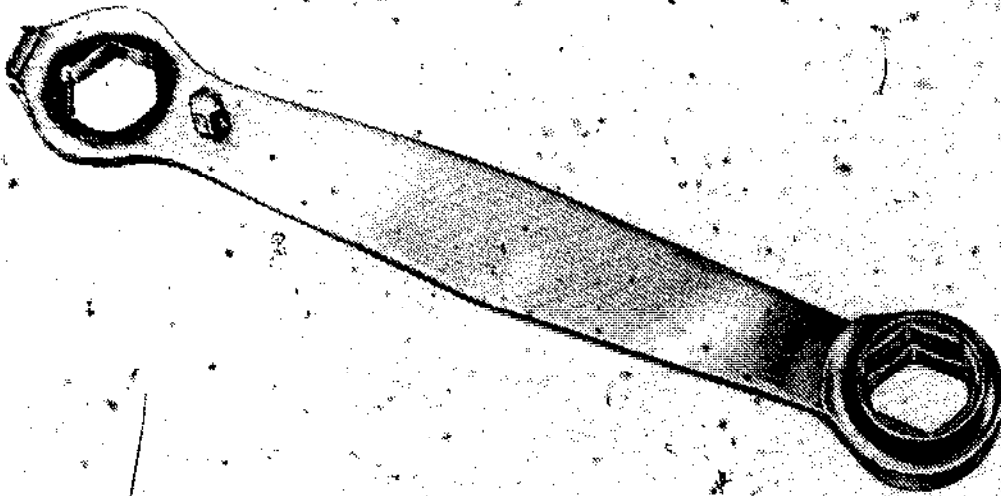

Fig 5-45 A tool for removing cotterless crank bolts.

5-45) can be used. Figure 5-46 shows the method for using the special tool. A socket wrench is used similarly.

A cotterless crank extractor tool (Fig. 5-47) is used as shown in Fig. 5-48. This one has the handle included, but others are available that can be turned with a wrench. The extractor is screwed into the dust cap threads, which applied pressure against the end of the axle, forcing the crank arm off. For the remainder of the disassembly, follow the steps outlined above for cottered crank assemblies.

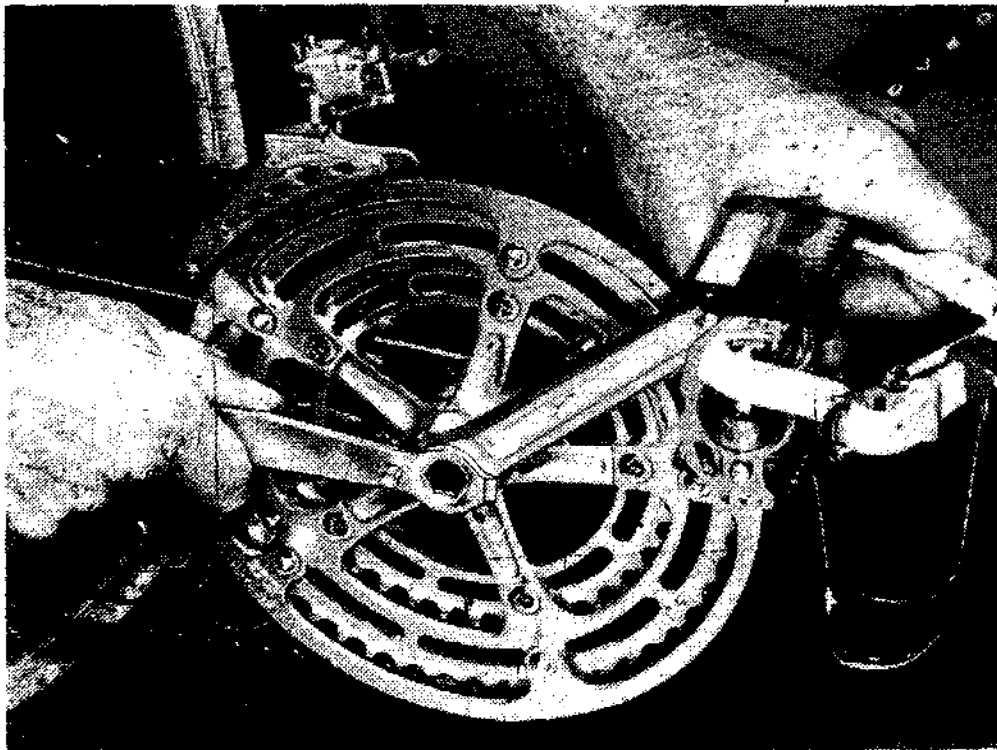

Fig. 5-46. Removing a crank bolt.

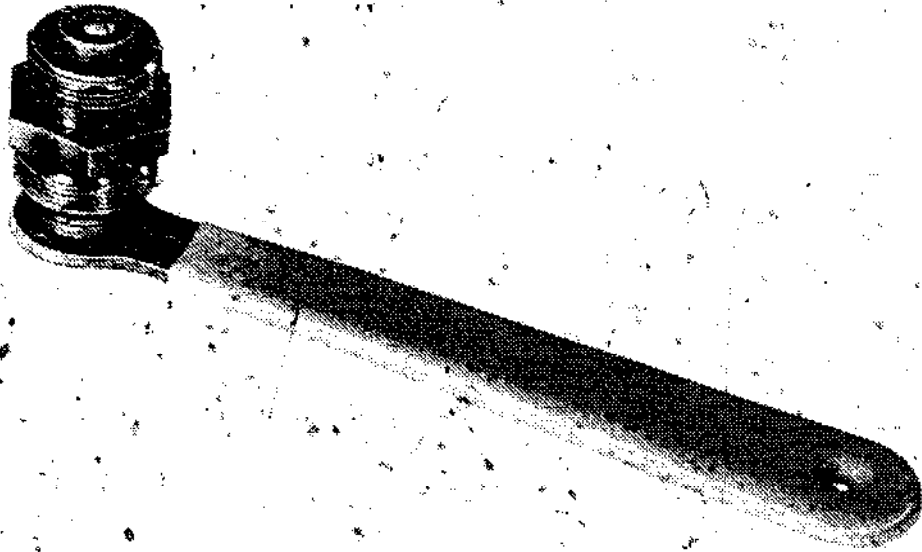

Fig 5-47. A cotterless crank extractor tool.

After cleaning parts, inspect for damage and wear and replace parts as required. Lubrication and axle assembly in the bottom bracket is the same as for cottered crank sets.

The crank arms can be positioned in any of four directions. Just make sure that the two arms face opposite directions. The crank or spindle bolts should be tightened securely and then checked after a short ride. For the first 150 miles of riding, retighten after every 50 miles of riding. If a bicycle is ridden with loose crank bolts or with crank arms that are not firmly seated, damage will quickly result.

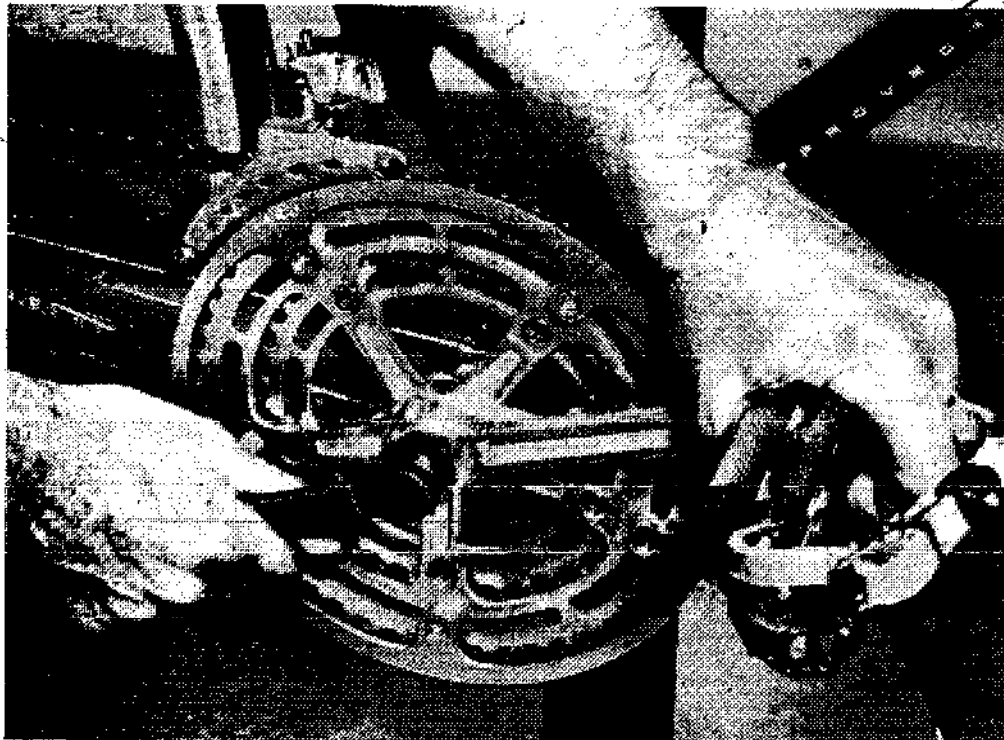

Fig. 5-48. Using a cotterless crank extractor tool.

## Inspection for Wear and Damage

For all types of crank assemblies, look for the following after cleaning parts in solvent:

- Inspect the axle to make certain it is not bent. This is rarely a problem on one-piece cranks.
- Pedal arm straightness is best checked before disassembly with the pedals still in place. Any untrueness will show up in riding the bicycle since the pedal centers will not be parallel to the axle.
- Check all threads. Parts with stripped or damaged threads, unless extremely minor, should be replaced.
- Bearings and cones should be smooth and unpitted. It is generally best to replace all bearings at the same time regardless of whether the bearings are loose or in a retainer.
- Check chainwheels for bent teeth. These can sometimes be straightened. Usually the chainwheels will have to be replaced.
- Check all other parts. Especially important are cotters, axle notches for cotters and cotter holes through the crank arms. Early replacement of parts here often prevents more costly damage.

## DERAILLEURS

The basic principles of derailleur gear systems (Fig. 5-49) are covered in Chapter Two. For adjusting and overhauling derailleurs, place the bicycle in a maintenance rack. Another possibility is to turn the bicycle upside down. Make certain that part of the bicycle such as front brake cables will not be damaged. A wooden frame with notches for the handlebars can be constructed to hold the bicycle upright and protect the brake cables. However, it is generally most convenient to have the bicycle right side up. The important thing is to be able to turn the pedal cranks by hand and work the gear shift controls.

### Adjusting Rear Derailleurs

A common problem is slack in the control cable. The cables tend to stretch with use and the cable no longer pulls the derailleur cage all the way to the largest sprocket. In turn, a cable that is too tight won't allow the cable to release far enough for the derailleur mechanism spring to pull the cage back to the smallest sprocket.

Minor adjustments to the cable can be made by unscrewing the cable if it is too slack or tightening it if the cable is too tight.

Fig. 5-49 Sun Tour V-GT rear derailleur

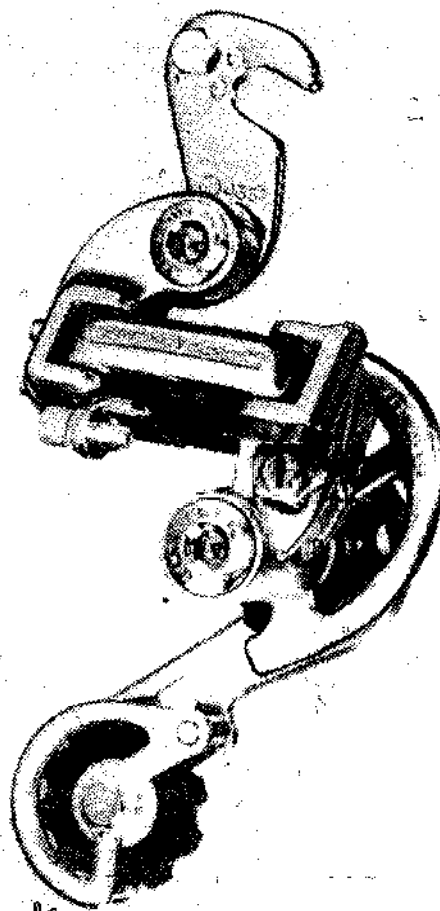

Adjustments are made on the barrel where the control cable joins the derailleur mechanism. If this will not go far enough to make the required correction or your type of derailleur has no adjustment barrel, loosen the cable clamp nut and loosen or tighten the cable as required. Then retighten the cable clamp nut.

If there is enough slack in the cable when the control lever is released—pushed as far forward as it will go—and the derailleur still will not return to the cage so the chain will derail to the smallest sprocket, the problem might be sticking pivots in the derailleur mechanism. Adjust by oiling the pivot points on the derailleur mechanism.

The control cable must slide through the housing freely to allow the derailleur spring to pull the derailleur cage to the smallest sprocket. If the cable does not move freely in the housing, try adding a few drops of light bicycle oil to each end of the cable at the housing.

If this does not cure the problem, remove the cable from the housing. First, disconnect the cable from the derailleur. Then disconnect the cable from the control lever and pull it out of the

housing. If the cable is rusty or appears damaged, replace it with a new one. Otherwise, apply a light coating of bicycle grease to the original wire and reinstall it in the housing. If the cable still will not slide freely, the problem might be in the housing. Replace the housing if necessary.

When selecting housings or cables, take the old ones along with you to the bicycle shop so that you can get exact replacements. New cable should be at least as long as the original and have the same type of end fitting for connection to the control lever.

Apply a light coating of bicycle grease before inserting the cable into the housing. Turn the cable while threading it into the housing. Connect the cable to the control lever. Pass the other end of the cable through the anchor bolt. Adjust the cable length and tighten. Do not cut off any excess cable until all adjustments have been made and everything is working properly. Always leave enough extra cable for future adjustments. It's a good idea to cap the end of the cable so that it will not unravel. Caps are available at bicycle shops.

The above procedure for replacing cable and housing also applies to front derailleurs.

With the control cable working smoothly and adjusted to the correct length and the derailleur mechanism pivot points oiled, the next step is to consider the range adjustments on the rear derailleur. This is accomplished by stop adjusting screws that limit the travel inward and outward of the derailleur cage. If the low gear screw indicated on most derailleurs with an L is too far out, the chain can go past the largest sprocket. If there is no spoke guard, it could damage the spokes. If the low gear adjustment screw is too far in, the derailleur cage cannot guide the chain to the largest sprocket.

If the high gear screw, indicated on most derailleurs with an H is too far out, the chain can pass the lowest gear and go between the smallest sprocket and the bike frame. When the screw is too far in, the chain cannot reach the smallest sprocket.

When you make adjustments the control lever should be in the extreme forward position (slack cable) for making high gear adjustments and in the back (tension) position for making low gear adjustments.

If the derailleur tends to jump out of set gear, the problem is most likely in the pressure plate adjustment of the control lever. Check to make sure that oil has not gotten on the pressure plate. If oil is present, disassemble and clean the pressure plate in solvent. Dry off and reassemble. Adjustment of the pressure plate is made by tightening the screw to increase friction and loosening to de-

crease it. Wing screws are used on many control levers for easy adjustment.

If shifting is difficult even though the control cable is properly adjusted and working freely, the chain cage might be bent out of line. If so, you might be able to straighten it by bending it back in line. Take care not to bend the mounting plate on the bicycle frame. This generally isn't a problem on derailleurs that attach on the axle bolt.

### Adjusting Front Derailleurs

In addition to making adjustments in the limit screws, the derailleur unit can be repositioned up or down and twisted at its mounts.

First check the cable and housing. Follow the same procedure as given above for rear derailleur controls. When the cable is working properly, adjust the cable length. Then make adjustments as required with the two adjustment screws for limits of cage travel. On most front derailleurs, cable tension moves the cage outward to the largest chain chainwheel. Spring action in the derailleur mechanism pulls the cage inward when tension is released. *Sun Tour* front derailleurs (Fig. 5-50) work the opposite of this.

Oil all pivots so that they move freely. This is a frequent source of difficulty.

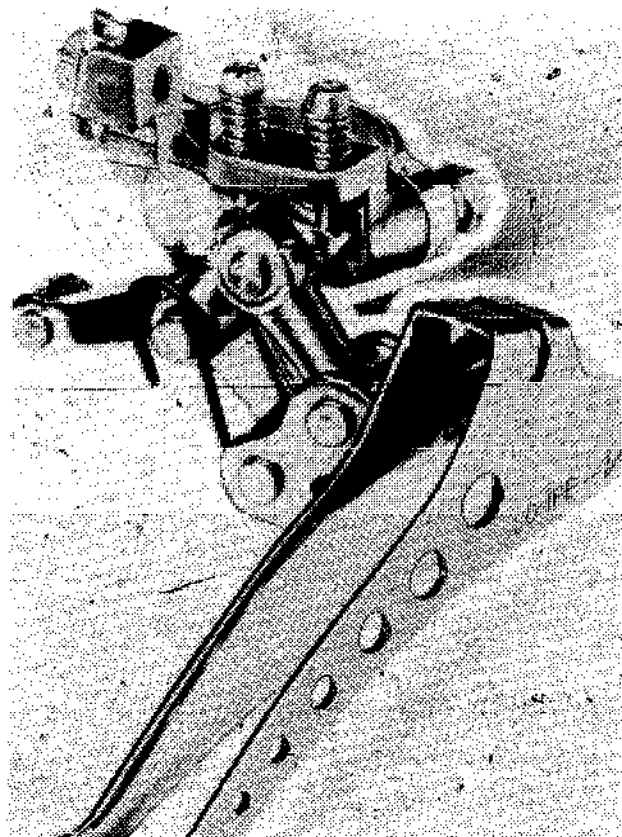

Fig. 5-50. Sun Tour Compe-V front derailleur.

It might be necessary to reposition the front derailleur mechanism on its mounts so that:

- The chain guide is parallel to the chainwheels.
- When the chain is on the largest front chainwheel and largest rear sprocket it does not touch the chain guide.
- When the chain is on the smallest front chainwheel and smallest rear sprocket it does not touch the chain guide.
- The chain guide clears the largest front chainwheel by about one-eighth inch.

### **Chain and Sprocket Problems**

The chain is frequently responsible for derailleur shifting problems. A tight chain link can cause difficulties. Methods of freeing tight chain links are covered previously in this chapter.

Problems can also occur from worn chain and bent or worn sprocket teeth. This might require replacement of the chain or sprockets.

The rear axle might be angled in the frame and cause rear sprockets to be out of alignment. Loosen the rear axle nuts or quick release devices, straighten the wheel in the frame and retighten the axle mounts.

### **Overhauling Rear Derailleurs**

Figure 5-51 shows a derailleur assembly. While most are similar, there are some variations. I suggest you get the assembly drawings for the make of your bike. For routine overhaul, the unit itself need not be disassembled.

To remove a derailleur from the bicycle, first remove chain. Disconnect the shift cable from the rear derailleur. Loosen the mounting bolt or nut and remove the derailleur unit from the bicycle frame.

Clean the derailleur unit in solvent. Inspect the unit for wear and damage. Inexpensive derailleurs are often replaced as a unit when worn or damaged. On more expensive units, the mechanism can be disassembled and defective parts replaced—provided of course that the parts needed are available.

Lubricate pivot points and pulley wheels with bicycle oil. Reinstall the unit on the bicycle and adjust as detailed in this chapter.

### **Overhauling Front Derailleurs**

Figure 5-52 shows a derailleur assembly. While most are similar, there are some variations. It's helpful to get the assembly

Fig. 5-51. Shimano Trilst rear derailleur. Parts are: (1) adapter, (2) adapter screw, (3) adapter nut, (4) adapter mounting bolt, (5) plate mounting bolt, (6) B-tension spring, (7) P-tension spring, (8) mechanism assembly, (9) adjusting plate, (10) cable fixing bolt, (11) cable fixing washer, (12) cable fixing nut, (13) adapter bushing, (14) stop ring, (15) plate bushing, (16) pulley-bolt, (17) inner cage plate, (18) pulley cap, (19) pulley, (20) pulley bushing, (21) outer cage plate, (22) adjusting screw, (23) adapter screw and nut, (24) pulley plate assembly, and (25) cable fixing set.

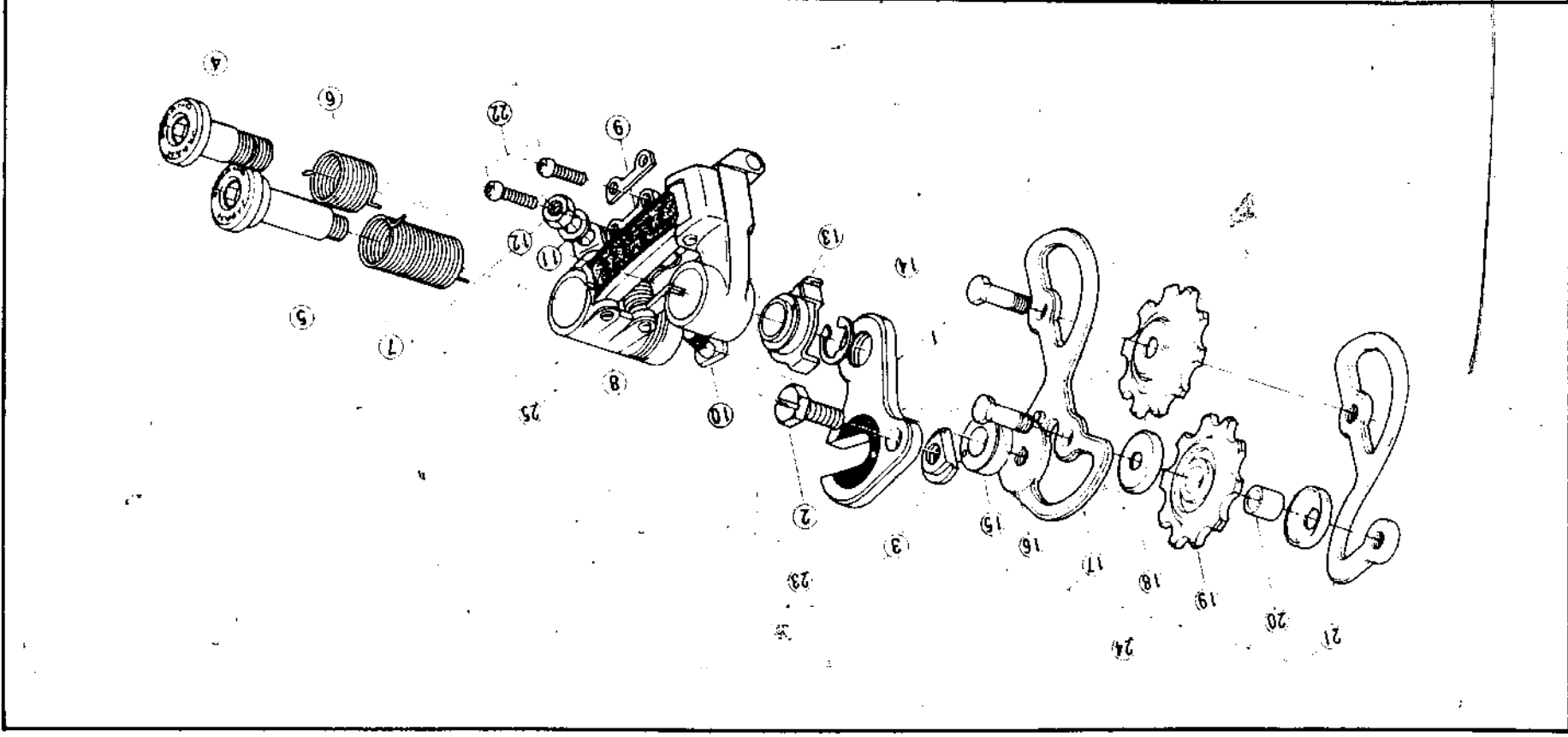



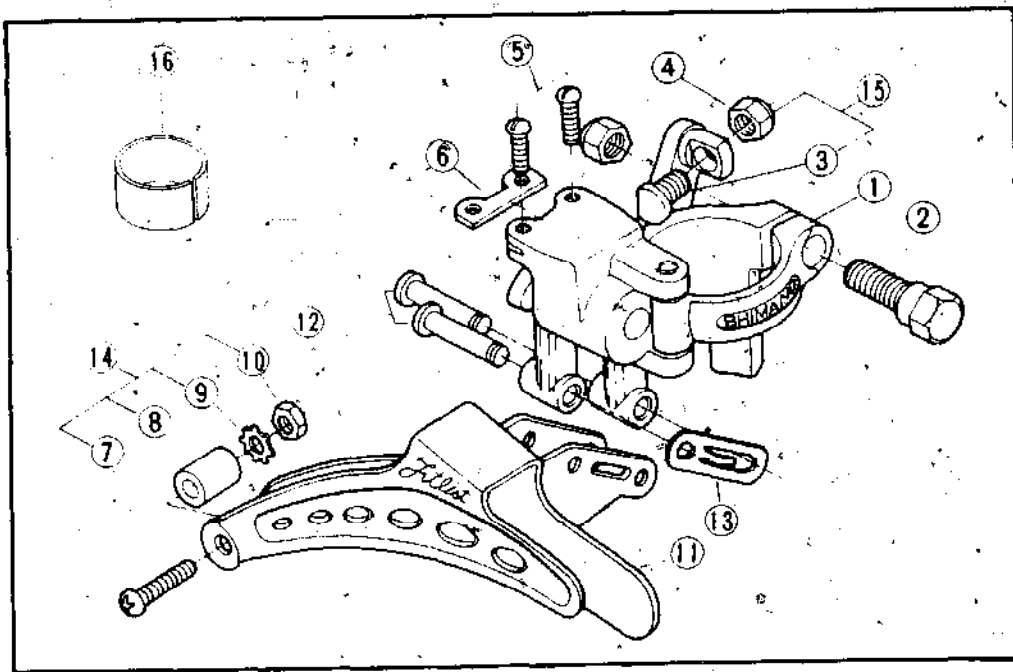

Fig. 5-52. Shimano Tittist front derailleur. Parts are: (1) mechanism unit lower inlet type, (2) clamp bolt, (3) cable fixing bolt, (4) cable fixing nut, (5) adjusting bolt, (6) adjusting plate, (7) chain guide spacer bolt, (8) chain guide spacer, (9) toothed lock washer, (10) nut, (11) chain guide, (12) pin A, (13) clip A, (14) chain guide spacer and bolt set, (15) cable fixing bolt and nut set and (16) 1-inch bushing.

drawings for the one on your bicycle—especially if you intend to disassemble the unit. However, this isn't necessary for a routine overhaul.

With the chain removed, disconnect the shift cable from the front derailleur unit. Unfasten mounting bolts. Remove the derailleur unit from the bicycle frame.

Clean the derailleur in solvent. Inspect for damage and wear. Ordinarily, the unit need not be disassembled unless part replacements are necessary.

Oil the pivot points and reinstall the unit on the bicycle. Adjust as described in this chapter.

### Control Levers

Derailleur control levers are located variously, with down tube (Fig. 5-53), stem (Fig. 5-54) and handlebar end (Fig. 5-55) shifters being most popular. Shifters are also made for the top tube, such the *stick shift*. But this is generally a dangerous place to have them.

Disassembly of shifters is generally simple. Remove the lever fixing bolt. The parts then slide off. Make a drawing of the parts as you take them off if you don't have the assembly drawings so that you can reassemble them.

Clean all parts in solvent and wipe with a clean cloth. Replace bent, broken and worn parts as required. Do not apply lubrication. Friction is necessary to prevent the lever from slipping.

After overhaul and adjustments, make a final check with the bicycle in a maintenance rack. Run through the gear changes a number of times. Gear changes should work smoothly.

### Relocating Shifters

This is a frequent modification. When making changes, I recommend that you stick to shifters made by the manufacturer of your derailleurs. Most offer down tube, stem and handlebar end shifters for their derailleurs. In most cases you will need to replace cables, housings and shifters.

All shifter locations are a compromise. The bottom tube location is still the standard for racing, but the stem and handlebar end locations are frequently preferred for general riding and touring.

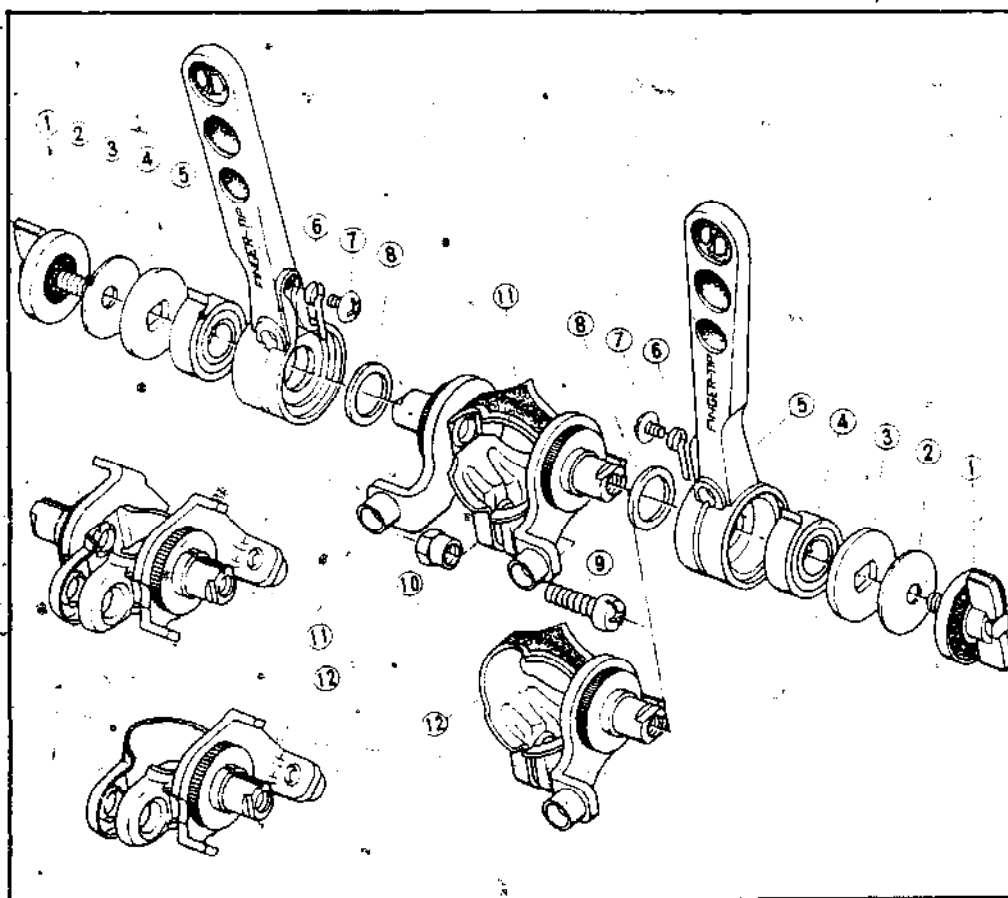

Fig. 5-53. Shimano Model LB-400 shifting lever. Parts are: (1) wing bolt, (2) coned disc spring, (3) non-turn washer, (4) spiral spring, (5) lever, (6) leaf spring, (7) screw, (8) washer, (9) clamp bolt, (10) clamp nut, (11) lever clamp for 10-speed and (12) lever clamp for 5-speed.

## HEAD SETS AND HANDLEBARS

A head set is the device through which the steering mechanism pivots (Fig. 5-56). It is made up of the bearings, cups, cones and necessary fastenings and locking devices for holding the fork head or stem in the frame head tube. When assembled, the only direct connection between the fork and frame are the bearings. This arrangement allows the fork to turn in the head tube. The handlebar post mounts inside the fork head or stem. The handlebar post usually extends upward and then angles forward to the clamp that holds the handlebars.

Ideally, the head set should be disassembled, cleaned, inspected for wear and damage, parts replaced as required, lubricated and reassembled at least once a year.

### Overhauling Head Sets

The two types of handlebar post wedges in common use are external wedge and internal wedge. The external type places all the stress on one side of the fork head. It is less desirable than the internal type which better distributes the stress on the inside of the fork head.

Both types are disassembled from the fork head in the same way. First, loosen the stem bolt a few turns. Do *not* continue turning it until it comes out of the wedge. With a block of wood over bolt head, tap the block with a hammer. Remove the handlebar post from the fork head by twisting slightly back and forth while pulling upward on it. Use liquid wrench to help free it if it is rusted in place.

Use a wrench to remove the lock nut from the head set. On caliper brake bikes, slip off the brake cable collar guide. Remove the lock ring or washer. Use a wrench to remove the adjusting cup. Turning it counterclockwise until it is free of the fork head.

If bearings are loose, remove them from the upper stationary cone. Then, holding the fork in the frame, turn the frame over. Pull the fork from the frame. The crown cone will normally stay on the fork. Remove the loose bearings.

If bearings are in retainers, pull the fork out of the frame and then remove retainers and bearings from the stationary cones.

You will not need to remove stationary cones from the frame head tube unless they require replacement. If you need to remove them, use a wood dowel and carefully drive them out from the inside of the frame head tube. The crown cone can be removed by sliding it off the fork head.

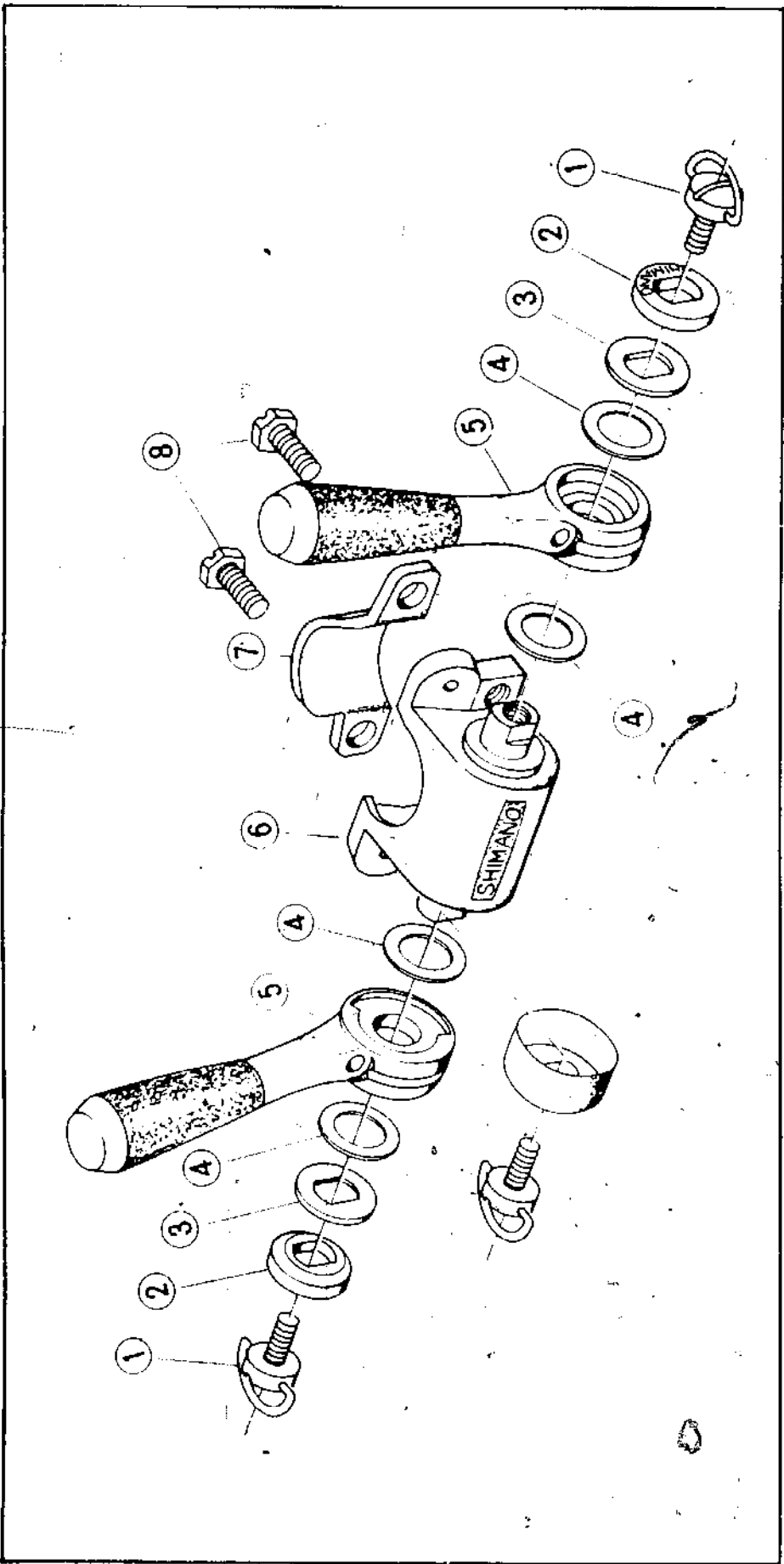

Fig. 5-54. Shimano stem shifter. Parts are: (1) wing screw, (2) non-turn washer, (3) pressure plate, (4) washer, (5) lever, (6) lever frame, (7) clamp plate and (8) clamp bolt.

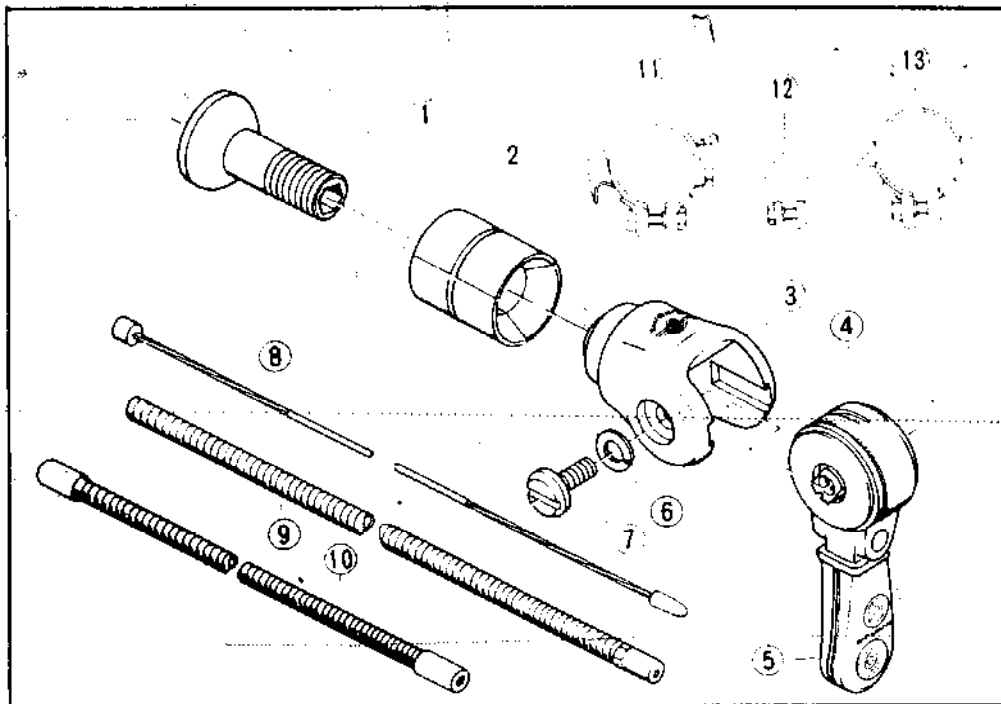

Fig. 5-55. Shimano Model LD-500 bar-end control shifting lever. Parts are: (1) anchor bolt, (2) segment assembly with spring, (3) body, (4) lever assembly with lever cap, (5) lever cap, (6) spring washer, (7) lever fixing bolt, (8) inner cable, (9) lever end outer casing, (10) outer casing, (11) cable guide, (12) outer stopper and (13) outer stopper.

Next, clean all parts in solvent. Inspect for wear and damage and make replacements as required.

Reassembly is essentially the reverse of disassembly except that bicycle grease is added to the bearings. In the case of loose bearings, begin assembly by turning the bicycle frame upside down. Apply grease to the lower stationary cone. Insert the fork head part way in the frame head tube. Place individual bearings in grease. Tweezers are handy for handling the bearings. Slip the fork the rest of the way into the head tube and hold it firmly in position while turning the frame upright. Fill the upper stationary cone with grease and position the individual bearings.

The adjusting cup should be tightened until the fork still rotates freely—but without end play. When this has been achieved install remaining parts of the head set.

Adjust the handlebar post to desired height, but make certain that at least two and one-half inches remain inside the fork head. This is necessary for safety.

### Handlebar Grips

Straight and upright handlebars commonly have rubber or plastic hand grips. These sometimes need to be replaced. If you

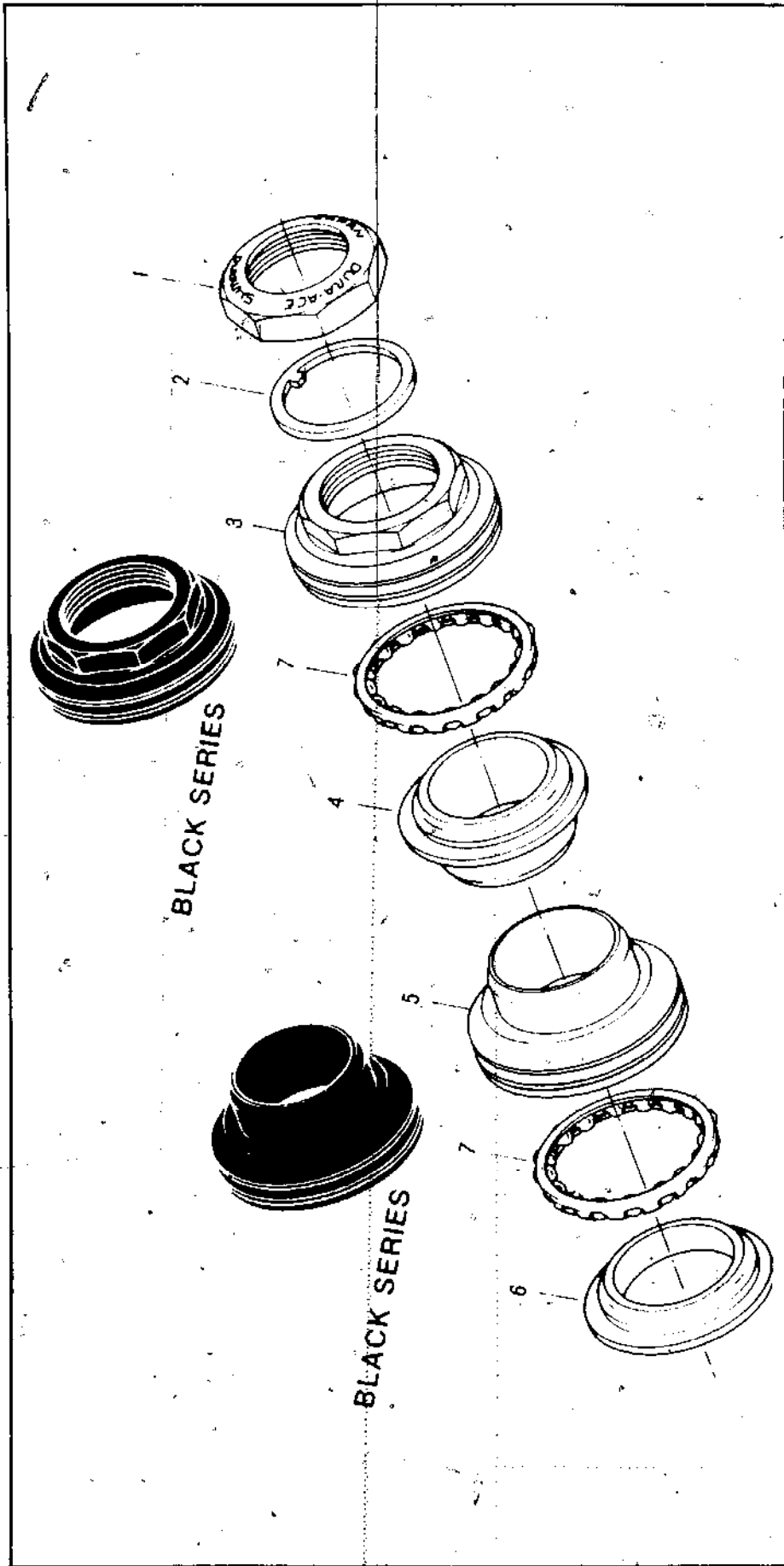

Fig. 5-56. Shimano Dura-Ace Model UB-100 head set. Parts are: (1) lock nut, (2) lock washer, (3) adjusting cup, (4) upper stationary cone, (5) lower stationary cone, (6) crown cone and (7) ball retainer.

cannot twist the old handlebar grips off by hand, cut them off with a sharp knife. Glue the new handlebar grips on with rim or gasket cement. Clean off excess cement with a cloth.

### **Taping Handlebars**

Dropped handlebars are commonly taped. The tape can be cloth, plastic, or rubber. Begin wrapping about three inches from the clamp in the center of the handlebars. Work outward, pulling the tape tight and overlapping about a quarter of an inch. Either skip over or take a wrap around the caliper brake handle mountings. At the end of the handlebar, run the tape off the end, leaving a couple of inches of extra tape on the end and cut it off. Stuff the end of the tape inside the end of the handlebar and install a plug.

The two basic types of plugs are a push into place plug and a type with an expansion bolt for tightening.

### **SADDLES AND SEAT POSTS**

A well designed saddle and seat post assembly is relatively trouble free. The important thing to select a good saddle to start with and then adjust it properly. In this section, I will discuss only the regular, single post saddles.

A regular saddle can normally be adjusted within a limited range for height, angle and forward/backward position. The saddle can also be turned so that it doesn't point straight forward. The normal position is to have it straight forward. In addition, many saddles have a tension adjustment.

#### **Height**

Adjustment is usually made by loosening the seat post clamp at the top of the frame seat tube (Fig. 5-57), adjusting the seat post up or down to the desired height and then retightening the clamp bolt. There are also wedge-type seat posts which are held in place like handlebar posts. To adjust, loosen the bolt on top of the post about four turns. Tap to drive the wedge loose. Adjust height and retighten the bolt. A big problem with this type adjustment is that the saddle often has to be removed to get at the adjustment bolt.

For safety, it's generally recommended that at least two and one-half inches of the seat post be down in the seat tube of the frame. If this does not give you the required height, purchase a longer seat post.

#### **Saddle Clamp**

This generally allows adjustment of both forward/backward position and angle of saddle. Loosen the clamp. You can now slide

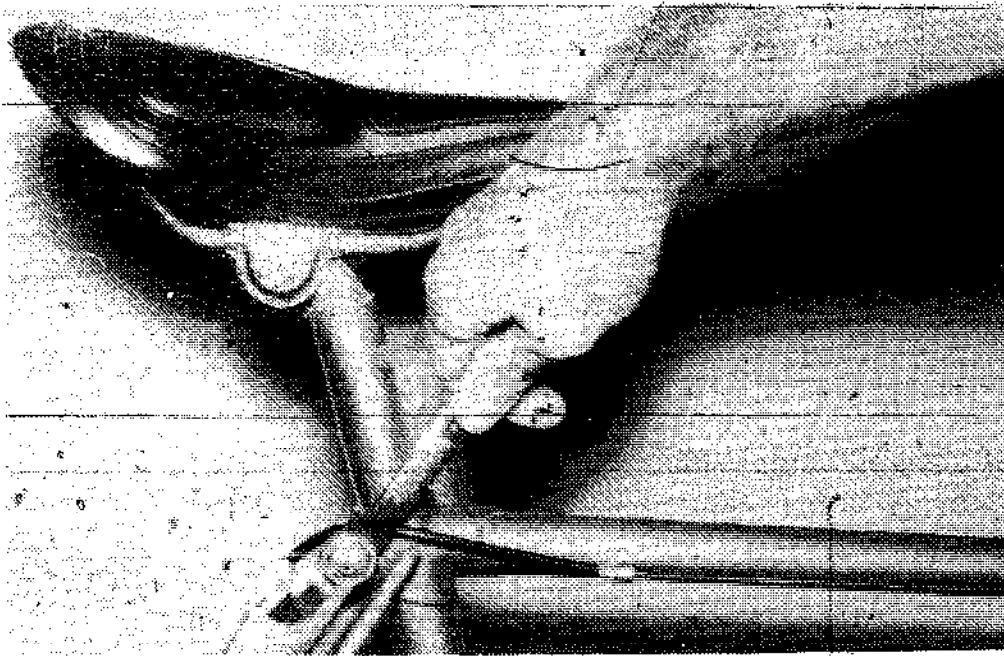

Fig. 5-57. Adjustment of saddle height.

the saddle forward or backward. The normal adjustment is with the front of the saddle about two inches behind the crank center. Normal tilt is within one notch of level position, but some riders prefer a more exaggerated tilt. Retighten the clamp when the saddle is positioned the way you want it. Some of the more expensive alloy posts have a saddle bracket that can be adjusted more precisely.

### **Tension Adjustment**

Some saddles have tension adjustments. This allows you to tighten or slacken the saddle top. The adjustment is usually made by turning a nut under the saddle.

### **Saddle Covers**

Some saddles have plastic or rubber covers or complete tops that can be replaced when they wear out. Other saddles have to be replaced completely, although on more expensive saddles the mounting clamp need not be replaced. Inexpensive saddles generally only come with the clamp included.



# Reconditioning, Modifying and Building Bicycles

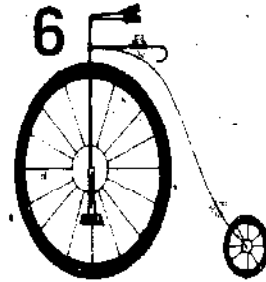

In many cases reconditioning and painting can restore an old bicycle to like-new condition. While the information in this chapter is geared primarily to regular bicycles, it can also be applied, with few modifications, to novelty and specialty cycles.

You might already have an old bicycle that you want to recondition or you can purchase a secondhand bicycle for this purpose. A third possibility is to purchase a frame and components and recondition and assemble them into a bicycle.

Any of these possibilities can be an inexpensive means of improving or obtaining a bicycle. In the process of reconditioning, you can learn a lot about bicycles and have the satisfaction of doing it yourself.

## THE FRAME

You need a sound frame on which to build a good bicycle. Don't worry about the finish since painting will take care of that. The important thing is that the frame is straight, undamaged and of sufficient quality that the finished bicycle will be suitable for your purposes.

In some cases a damaged frame can be repaired, but generally this is only practical if the damage is extremely minor or cosmetic. Check especially the frame joints. A minor fracture in a welded or brazed joint can be repaired by taking the frame to a commercial shop if you don't have the skill or equipment to do this yourself. It's generally safest to use brazing rather than welding. The lower heat

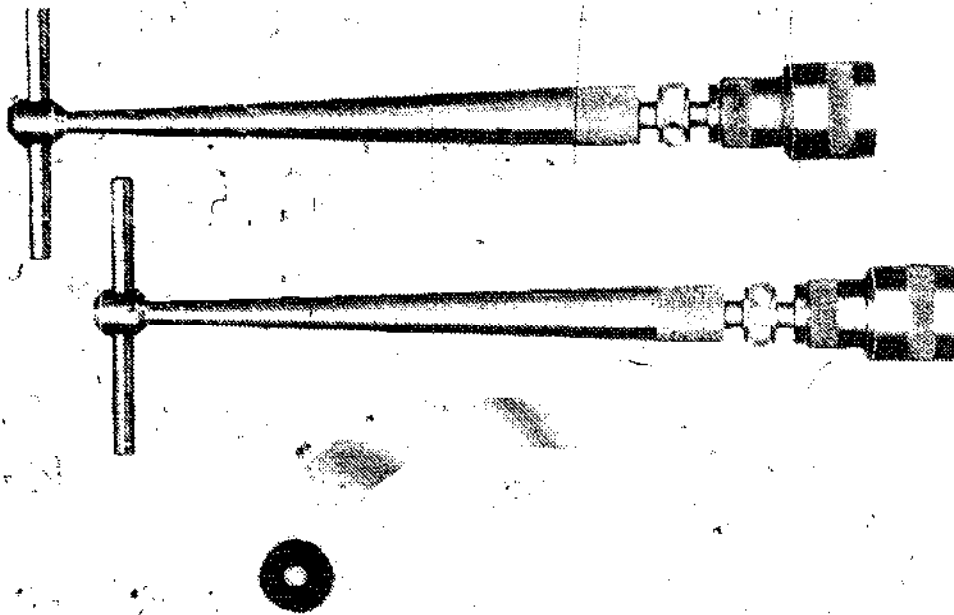

Fig. 6-1. Frame and fork end alignment tool and gauge.

of brazing usually has less adverse effects on the tensile strength of the steel.

A bent frame can be a more serious matter. Even minor damage can be difficult to correct without special tools such as the frame and fork end alignment tool and gauge shown in Fig. 6-1, Fig. 6-2 and Fig. 6-3. These tools are also used to straighten and align the rear drop outs on a bicycle frame. The calipers are used to measure the proper width of the drop outs for the hub that is being used. The tool can also be used on forks.

Well-equipped bicycle shops usually have a number of special tools and devices for straightening and aligning frames. Without these, it is very difficult to make even minor repairs of this nature. If the frame appears to be of high quality to be worth the expense, I suggest that you take the frame to a bicycle shop and have it straightened and aligned for you.

If you do want to attempt frame straightening yourself, I suggest you do it by placement of props and application of hand, foot or steady prying pressure rather than by using a hammer. A badly bent fork can be replaced with a used or new one. However, the replacement should be the same size and shape. Not all forks will fit all frames.

Regardless of whether or not you intend to paint the frame, I suggest that all components be disassembled, cleaned, overhauled

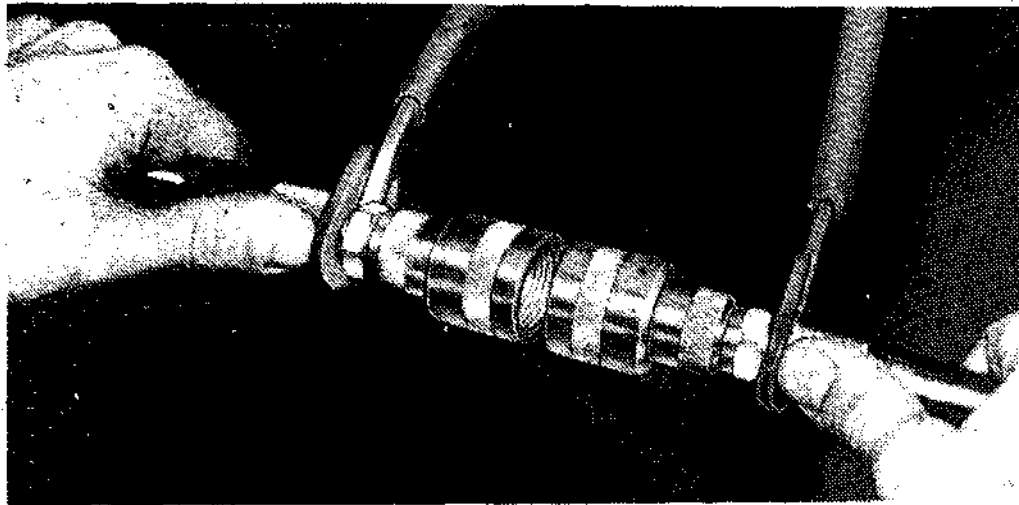

Fig. 6-2. Straightening rear drop-outs.

and replaced back on the frame. Although this can be done one component at a time, the frame should not be painted.

If the frame will be painted, strip all components off of it, including the fork. It is almost impossible to do a good job with the components in place—even with careful masking. If it's just an old, rusted functional bicycle and you don't care about the appearance, a few coats of rust preventative paint can be applied to the assembled bicycle to help slow down further deterioration.

### **PAINTING**

Make no mistake about it, painting is both an art and a skill. Most bike owners who want to paint their own bicycles are further hampered by lack of professional equipment and a dust free painting environment with controlled temperature and humidity and good lighting. However, with care, a reasonably good paint job can be done.

The first step is to disassemble all components from the frame, including bearing cups from the bottom bracket and head tubes. Keep all parts in order and make drawings where necessary so that you will be able to reassemble everything later. While it's possible to do the painting with the fork still mounted in the frame, I suggest that you remove the fork and paint the frame and fork separately. You will probably want to disassemble the head set for overhaul anyway.

You might also want to paint other parts of the bicycle, such as fenders, chain guards and even rims. It's generally best to have each part separate for painting.

Whether or not you need to remove all of the old paint depends on the condition it is in, the type of paint you intend to apply and, to a

certain extent, the color of the old paint and the new paint you intend to use. If the old paint tends to peel away when you try to sand it, then it will probably have to be removed. Since putty is often used to fill nicks and dents in manufactured bikes, I suggest that you remove paint by fine sanding rather than with paint removers. Paint removers tend to remove fillers too. If you do use a paint remover, be prepared to apply new putty.

Most home-done paint jobs are doomed to appear amateurish because of inadequate preparation of the surface. In general, don't expect the paint to fill defects in the surface. Avoid using coarse grades of sandpaper. Start with medium grades and work down to fine.

You will need to decide what type of paint you want to use. This can be lacquer, enamel, acrylic, epoxy or whatever you prefer. Use only paint designed for metal surfaces and make certain that it is compatible with old paint if the frame is not stripped bare. Once you have decided on the type of paint, you will need to get filler and primer, if required, that is compatible with the paint selected.

*Proteus Design Inc., 9225 Baltimore Blvd., College Park, Md. 20740*, offers a paint kit that includes a can of activator for epoxy primer, a can of epoxy primer, a can of activator for top coat, a can of top coat and a can of thinner with enough paint for one bicycle frame. Kits retail for about \$15.50.

Spray painting will generally provide the smoothest finish, but only if you have the necessary equipment and painting know-how.

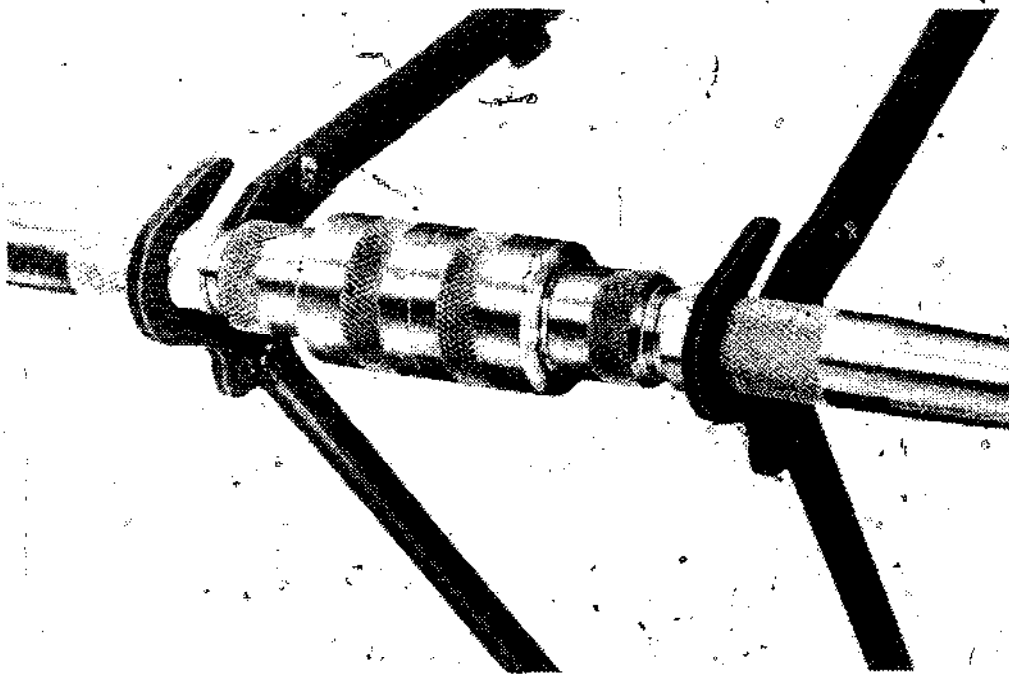

Fig. 6-3. Drop-outs are now in alignment.

Also, without adequate safety precautions, which most home-shops are not equipped to provide, spray painting can be extremely hazardous to your health.

The common alternative, aerosol spray cans, have similar or greater health hazards. My own recommendation is that you avoid these, as it is almost impossible to avoid breathing the fumes—even if you paint outdoors.

The alternative is brush painting. If you get the right kind of paint, a good job can be done in this manner.

After frame and all other components to be painted have been sanded and are ready for painting, find a way to sort them so that you can best apply the paint. Good lighting and a dust free area are important. However, for safety reasons, I suggest that painting be done outdoors. Do the painting on a dry, warm (but not hot) day in a shaded area out of direct sunlight.

If primer is required, apply and allow to dry. Additional light sanding might be required before the application of the finish coat or coats of paint. Follow the paint manufacturer's recommendations regarding drying times between coats. Allow paint to thoroughly dry before reassembling the bicycle.

### **CLEANING PLATED COMPONENTS**

Pits and bubbles of rust can be removed from plated metal surfaces by light rubbing with steel wool, followed by metal cleaner and polish and finally wax. In many cases, parts that look quite bad can be restored to good appearance in this manner.

You can, of course, have parts chrome plated at a commercial shop. I suggest that you paint over plated surfaces only as a last resort. If this is done, the plating should be completely removed so that the paint will bond properly.

### **ASSEMBLY**

Before assembly, clean, inspect and replace parts as detailed in preceding chapters. The wheels will probably require truing. In most cases it's advisable to replace bearings throughout and wires in control cables. Tires might also require replacement.

After assembly, make final adjustments and the bicycle is ready for use.

### **MODIFICATIONS**

While you are reconditioning, you might also want to make some modifications such as changing to different components. A number of kits are on the market for making gear and other conver-

sions. You might also want to add accessories. These can be functional, such as lights, or decorative, such as flags and streamers.

In the remaining chapters of this book, a number of building and modification projects are included. These are planned so that a minimum of skills are required, and wherever possible, easily available bicycle and tricycle components and frames are used.

To build even a simple cycle from raw materials would be an incredibly difficult process and few cycle manufacturers even do this. Most use at least some components or frame tubing manufactured elsewhere. Some of the projects are fairly specific and others less so. In cases where there are many ways to accomplishing about the same thing, suggestions and ideas are given rather than specifics. This will enable you to make use of available materials. Also, and I feel that this is important, considerable allowances are made for you to possibly add your own ideas. In many cases, you will be able to think of a better or less expensive way of accomplishing the same thing. This will often be suggested by the parts and materials that you have available. Creating originals when you get into novelty and specialty cycles can be a lot of fun. There is a lot of room to apply your ideas here.

Before going into actual building methods, take a brief look at custom bicycle frame building.

### **CUSTOM BICYCLE FRAME BUILDING**

With seemingly every type and style of bicycle available in manufactured versions, you might wonder why there is any need for custom frame building. Especially if the result looks pretty much like the manufactured product. Actually, custom frames are rarely used for purposes other than racing and advanced touring. At least where value for money is any real consideration.

Manufactured bicycles come in sizes. To get an exact fit, it might be necessary to go to a custom built product. This is costly and for most uses the manufactured versions will have to do.

Building a custom frame requires considerable skill and experience. If you have had considerable shop and brazing experience and want to get started in frame building, I suggest that you start with a *Proteus Design* frame building kit available from *Proteus Design Inc.*, 9225 Baltimore Blvd., College Park, MD, 20740. The kit includes:

—*Reynolds 531* double butted tubing that has 21/24 gauge English threads and diameters.

- Cinelli* fully sloping crown.
- Campagnolo* road dropouts with eyelets and adjusters.
- Gargatte* bottom bracket shell that is 68mm wide with English threads.
- Seat stay reinforcements.
- Top eyes to make English wraparound.
- Brake bridge reinforcement.
- Five sticks of English brazing rod to be used at 1595 degrees F.
- An instruction book with diagrams and information on assembling the frame.

They also offer a practice kit that includes one lug, one tube, one stay, one dropout and three sticks of brazing rod. The tubing is *Reynolds 531*. They also have a large selection of frame building supplies and materials.

## TOOLS

In addition to the tools described in Chapter 4 for basic bicycle maintenance and repair, some others will be needed for many of the projects described. While you might be able to get by with just hand tools, a few power tools will be extremely helpful. An electric drill and bench grinder are perhaps the most useful.

I also suggest a sturdy workbench and a heavy duty bench-mounted vise. Hacksaws, files and tube cutters are needed for working on frames.

## BRAZING AND WELDING

Many of the projects require brazing, welding or both. However, brazing and welding are specialized subjects and space does not permit coverage of them here. Also, unless you plan many projects, the cost of the equipment and time required to learn the skills will probably make this impractical.

In most cases, low-heat brazing is used—especially for joining frame tubing. However, there are cases where welding can also be used. With certain metals, welding might even be the best method. When in doubt, it's generally best to get advice from a professional welder.

You can generally have the brazing or welding done quite reasonably at a commercial shop, provided you have everything ready—parts shaped, fitted and so on—so that only the welding need be done.

Cycle projects are ideal for classes and courses in metal shop and welding. In many cases they are more meaningful than the typical shop projects. I know one high school student who has

constructed an impressive number of all types of unicycles. He makes many of the components and does much of the brazing and welding in shop classes at the high school he attends.

Many adult education classes in shop and welding are available across the country. In many cases these have low or nonexistent tuition fees. These classes are an excellent place for learning skills and they also provide tools and equipment. It is a good way to get started in a cycle building hobby.

### **PARTS AND MATERIALS**

Used bicycles and parts are ideal for these projects. Damaged bicycles are often an inexpensive source of parts. For example, a bicycle with a frame damaged or bent beyond practical repair might still provide most of the parts for building a unicycle.

The best places that I've found for buying used bicycle frames and parts are city and county dumps that have a sale yard. Of course, this might not be the case everywhere, but in several towns in California I've found these yards to have large selections of junked bicycles and parts that could be purchased cheaply. Many bicycle shops have used bicycles and parts for sale, but my experience has been that you can expect to pay top prices here. Most bicycle dealers know the value of these items and will try to get as much as possible for them. In many cases the best place to select parts for novelty and specialty cycle construction is from discount and auto supply stores that handle bicycle parts. They often have a good selection of parts at low prices. While the quality is often low, it is sufficient for use on many of these projects.

As a general rule, stick to standard steel frames and parts. Aluminum alloy should be avoided when welding or brazing is required. Special equipment and know-how is needed for this, and even then the joints might be inadequate.

For some of the projects, stock materials such as steel tubing and rods are needed. In most cases, used materials will be adequate.

As a general rule, I suggest that you use materials of size and thickness and shape that will be considerably above the minimum strength necessary. Allow plenty of margin, especially where failure of the part or material might present a safety hazard.

### **BASIC TECHNIQUES**

A number of construction techniques are used on two or more projects described in later chapters. A few are covered here and others will be detailed along with specific projects.



Many of the projects require assembling and disassembling bicycles and components. This aspect has been covered in Chapter Five.

**Cutting Frames and Forks.** There are many instances when you will need to cut frames and forks. One way to do this is with a hacksaw. A tube cutter can be used when a perpendicular cut is required on round tubing.

**Flattening Tubing.** One way to do this is in the jaws of a vise as shown in Fig. 6-4.

**Straightening Forks.** The fork blades on most bicycles are curved. A number of projects require straight forks. Sometimes forks can be found that will still be long enough after the curved sections have been cut off. But there are many cases when it will be necessary to straighten them. This can be done by clamping the fork between two blocks of wood in a vise with the curved portion of the fork blades extending outward. A section of pipe that will just fit over a fork blade is then used to straighten the blade. Work carefully toward the end of the blades and readjust the fork between the blocks of wood as necessary. Dents must be avoided since they will greatly weaken hollow tubing.

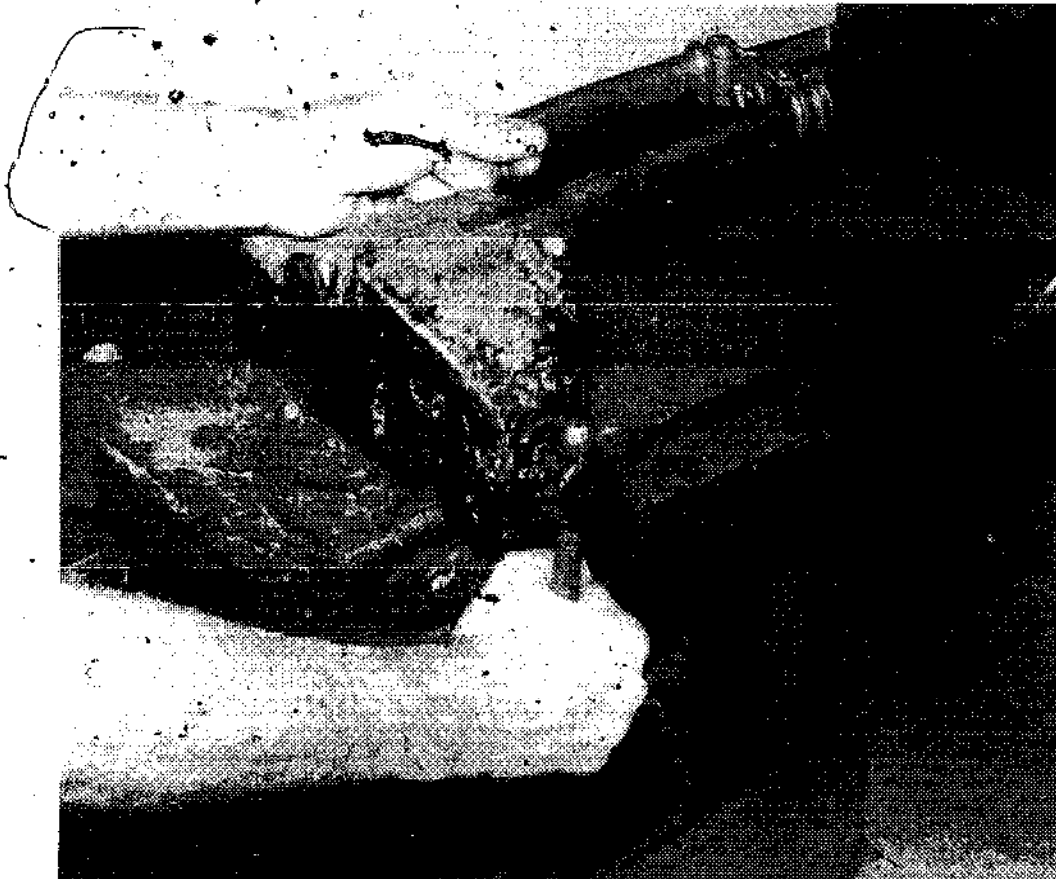

Fig. 6-4. Flattening the fork end in vise.

**Drilling.** Drilling holes in metal is frequently required. While a drill press is helpful, a hand electric drill will suffice for most of the projects in this book.

**Grinding and Filing.** A bench type power grinder is almost essential for a few tasks. Filing is another frequent job. Most of the filing can be done with flat files, but round, rattail files are also useful.

**Installing Small Crank Sprockets.** Several projects require replacing a large chainwheel with a small sprocket. This can be done with either a one-piece crank or the right crank of a cottered assembly. Both methods are satisfactory. The choice seems to be on what components you have available.

In most cases, an exact match of the rear sprocket is used. If a different size and number of teeth is used, it must fit the chain.

On one-piece cranks, the first step is to remove the original chainwheel. Then grind off the chainwheel set lug. Centering and aligning the sprocket is extremely important. A good way to do this is to fit spacers between the small sprocket and the cone threads on the crank and then tighten the stationary cone against the sprocket as shown in Fig. 6-5. Before brazing the sprocket in position, test centering and alignment by installing the crank back in the bottom bracket and spinning it. If centering or alignment is off, it will be apparent. Make the required corrections before brazing the sprocket in place.

If a cottered crank assembly is used, the normal procedure is to replace the chainwheel on the right crank arm with a small sprocket. In some cases an additional matching small sprocket will be mounted on the left crank arm. This arrangement is generally impractical with a one-piece crank. There is no easy means of allowing disassembly for servicing and repairing.

Chainwheels are usually either splined directly to the right crank arm or bolted to mounting arms that are connected to the crank arm. In either case, these must be removed from the crank arm. An easy way to do this is to grind the splined portion of the mounting away.

Next, position the small sprocket. Center and align it and then braze it in place. The same method is used for attaching a small sprocket to a left crank arm except that there is no chainwheel to remove.

**Fixed Rear Sprockets.** A number of projects require a fixed sprocket (non-freewheeling) on the rear hub. Fixed track hubs can

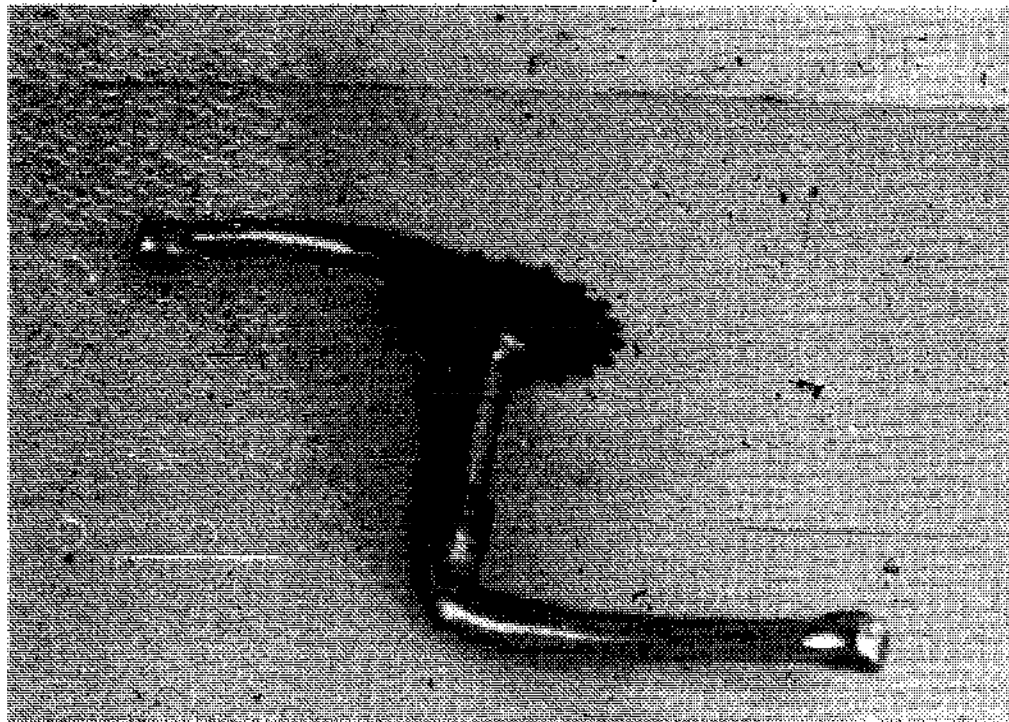

Fig. 6-5. The sprocket is positioned on the crank and ready for brazing.

be used. However, for some projects these might not be completely satisfactory. They tend to slip when the pedaling direction is reversed. This is fine on a track bicycle where all the pedaling is done in one direction, but problems are frequently encountered with these hubs on chain-driven unicycles and artistic bicycles that are pedaled both forward and backward.

One solution is to tack weld the sprocket in place. Some hubs with large spoke flanges can still be spoked after this is done. If not, the tack weld can be done with the hub already spoked to the wheel. If spoke replacements are ever required, these can be made by cutting and bending extra long spokes—as detailed in Chapter 5.

A similar tack welding procedure can be used to make fixed hubs out of single-speed coaster brake hubs. The general method is to remove all coaster brake parts that interfere with the free turning of the hub. The sprocket is then tack welded in place.

Regardless the type of hub used, avoid alloy hubs if welding or brazing is to be done. It is nearly impossible to do a satisfactory job on these.

### GENERAL CONSTRUCTION PLAN

If you plan to have brazing or welding done at a commercial shop, it is generally most economical to have everything cut, fitted and held in place with a jig when you take it in to have the work done.

In most cases, it's best to stick to steel. Brazing or welding two different types of materials together is frequently a problem. It's best to check with a professional welder first to see if what you have in mind will work satisfactorily.

## Portable Bicycles

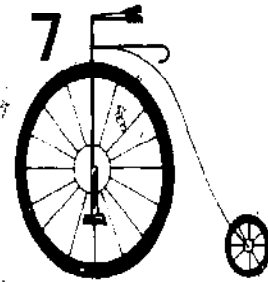

A number of folding and collapsible bicycles are now available. The basic idea is that the bicycle can be transported and stored in less space than is required for a regular bicycle. In exchange for this added convenience, some sacrifice in riding qualities, such as smaller wheels and added weight, generally must be made.

Most regular bicycles are collapsible in the sense that they can be made more portable by partially disassembling them by removing wheels, pedals and handlebars. This is essentially the way many bikes are shipped in cartons from the factory. However, all this takes considerable time. This method of achieving greater portability is not very convenient although it might suffice if you only need to do it once in a while.

First consider if you really need this portability. Perhaps a regular bicycle and car rack, as described in chapter three, will serve your purposes just as well.

If you require a good quality 10-speed that quickly breaks down into a fairly small package, but not as small as folding and take-apart frame bikes, the *Gitane Traveller* might be the answer. Quick release devices allow easy wheel removal, lowering of the saddle and turning the handlebars and fork around so that the fork blades curve toward the frame and the handlebars are just above the top tube. The chain is held taut by special clips. The bicycle can be collapsed in less than one minute with no tools required. It fits in a carrying bag that comes with the bicycle. The bike in the bag weighs 30 pounds and makes a package approximately 36×36×15 inches.

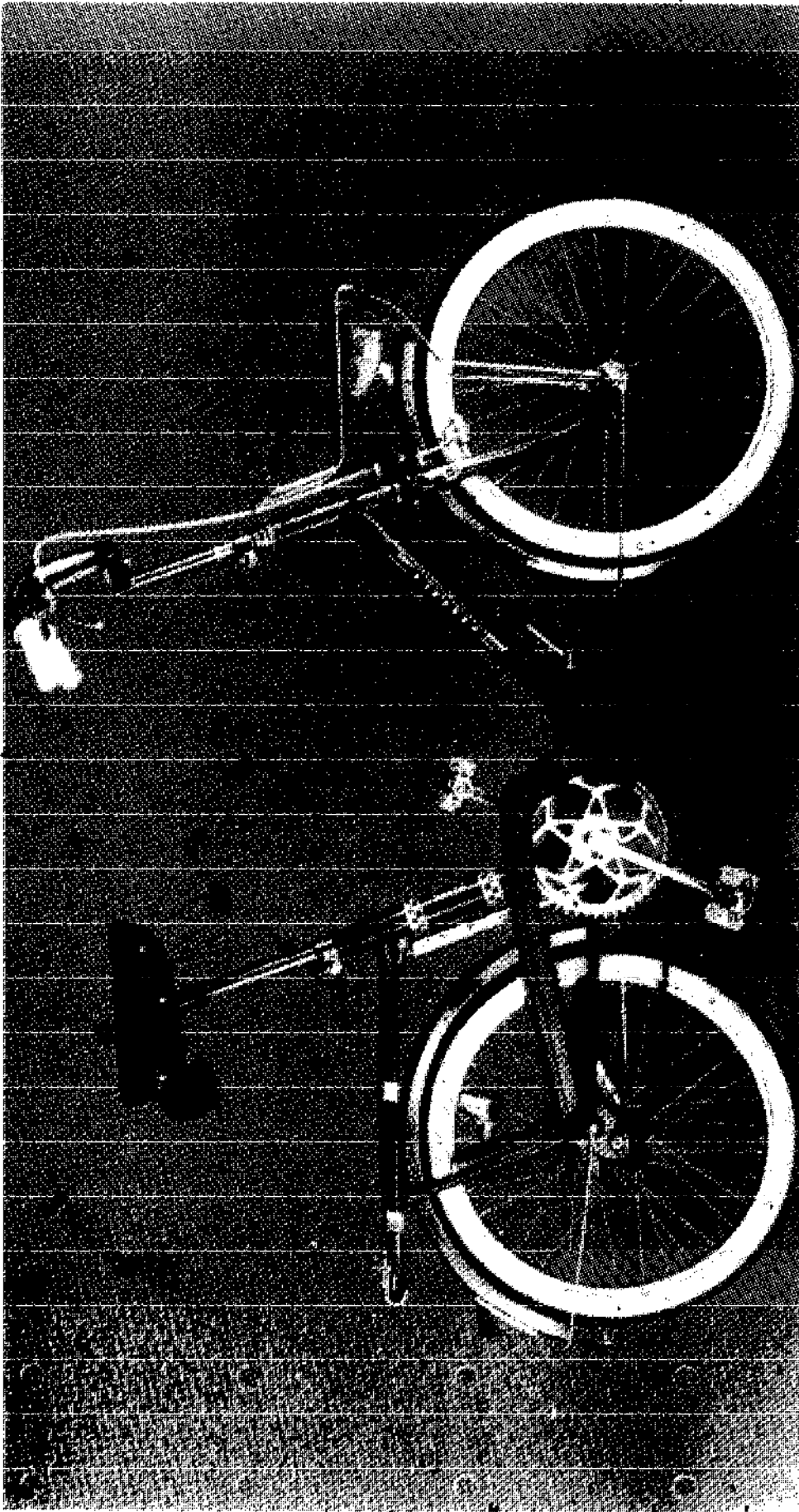

Fig 7-1. Peugeot DA 40 E lake-apart bike with an automatic shift, 2-speed hub with coaster brake.

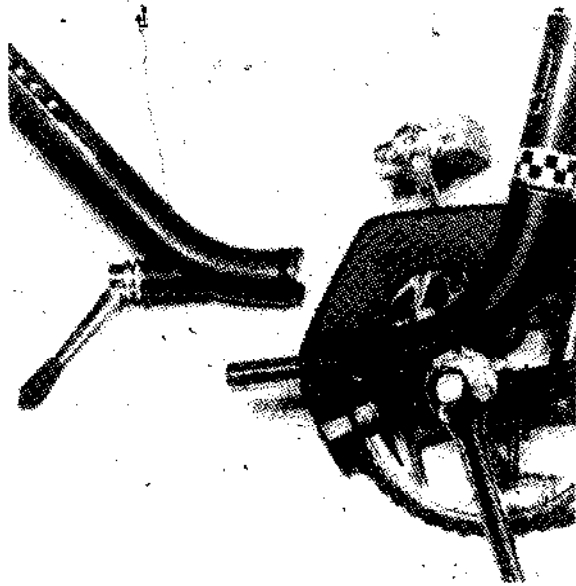

Fig. 7-2. A lever separates the frame.

This is quite good when you consider that the frame itself doesn't fold or come apart and that you have a good 10-speed for riding. The bicycle, imported by *Mel Pinto Imports Inc., 2860 Annandale Road, Falls Church, VA 22042*, is available from *Gitane* bicycle dealers in many parts of the United States.

The idea of making bicycles with frames that would fold is not new. Some bikes like this were around in the early 1900s. Photos of German soldiers in World War I show these bikes strapped to their packs.

### **MANUFACTURED MODELS**

Figure 7-1, Fig. 7-2 and Fig. 7-3 show a *Peugot* take-apart bike with an automatic shift two-speed hub with coaster brakes. The saddle post and handlebar post have quick release clamps so that the saddle and handlebars can be adjusted and lowered for greater compactness.

Most of the manufactured models currently available use 16-inch, 20-inch or 24-inch wheels. Smaller wheels reduce the size of the folded or collapsed bicycle, but generally provide less efficient riding. However, this disadvantage can often be offset by the greater ease of carrying the bicycle along on buses, trains, boats, travel trailers, campers, airplanes, car trunks or storing in small areas where space is at a premium such as in cabinets and small closets. Often two or three collapsed bikes will fit in the same space as one regular bicycle.

Common methods of achieving compactness include hinged or take-apart frames that allow the bicycle to be folded in half or broken down into two sections. In addition, many models have features that

Fig. 7-3. The saddle is quick-release adjustable. The same applies to the handlebars.

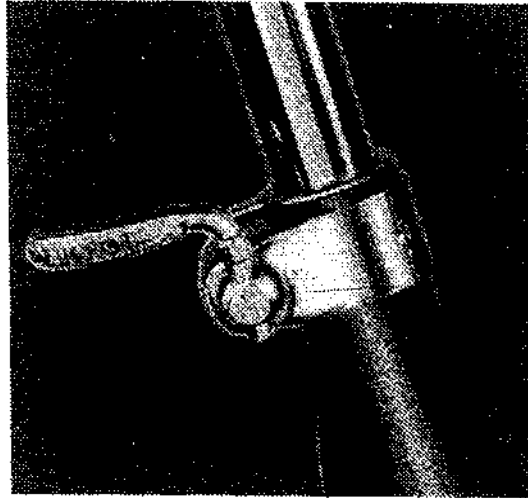

allow lowering saddles and lowering or turning handlebars to further reduce the size of the package. Some even have folding pedals to reduce the width of the collapsed bike. Chris-Craft (of boating fame) offers a portable stainless steel bicycle that is ideal.

Portable bicycles are available in single-speeds and with hub and derailleur gear systems.

While most models have small wheels and frames, they can be adjusted for adult riders. Many come with special features such as carrying racks, lights and kickstands.

## CONVERSIONS

Regular bicycles can be converted to folding or take-apart models by adding couplings, available in a kit, or making up and

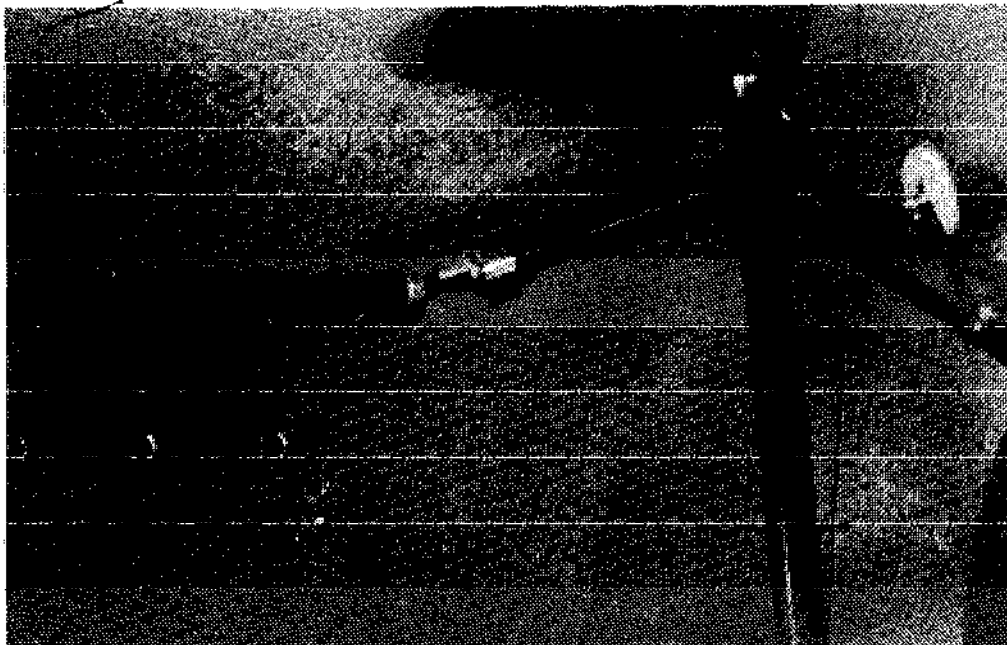

Fig. 7-4. Springs hold sections together when couplings are separated.



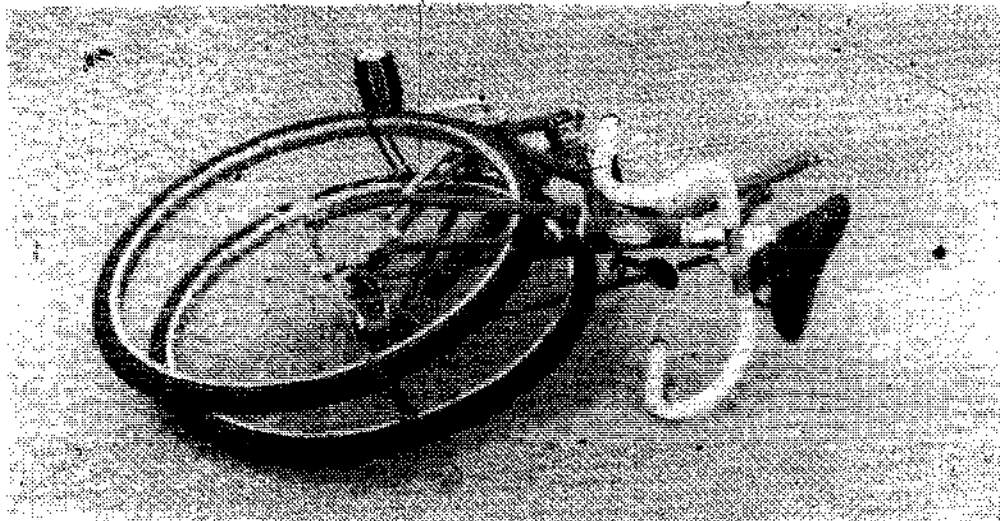

Fig. 7-5. The folded bicycle has wheels held together with shock cord.

adding your own hinging or clamping system. For either method, I suggest that you use only sturdy, heavy and inexpensive frames.

The *Girard Engineering Co.*, 114 Main St., Tekonsha, MI 49092, offers a kit for converting a regular bicycle to a folding or take-apart model (Fig. 7-4 and Fig. 7-5). The frame separates in the center and is held together by springs that allow the frame to be folded in half. Without the springs, the bicycle can be dismantled into two separate sections. The basic procedure is to cut the frame into two sections (Fig. 7-6) and epoxy bond and bolt the couplings to the frame pieces. The kit can be used on two-bar-frames, but I suggest that only the heavier, less expensive type be used.

Instructions come with the kit for determining where and at what angles to make the frame cuts. Often this will be midway and perpendicular to a line drawn between the axle centers of the wheels. With this arrangement, the front and rear wheel centers will meet when the bicycle is folded. You might prefer to remove the front wheel—wing nuts or quick releases can be used—and have the frame cuts positioned so that when folded the fork blades meet the bottom of the rear wheel. On many bicycles this will allow the handlebar to overlap just above the rear wheel. The folding is generally done on the non-sprocket side of the bicycles.

After marking the frame where you want the couplings to be placed, cut the frame into two sections with two cuts—one in each frame bar. While a hacksaw can be used, it is generally easier to get a straight cut with a tube cutter. In either case, if care is taken little or no touch-up on the paint will be needed.

According to the instructions that come with the kit, adding bolts is optional on a frame with standard sized tubing. It is neces-

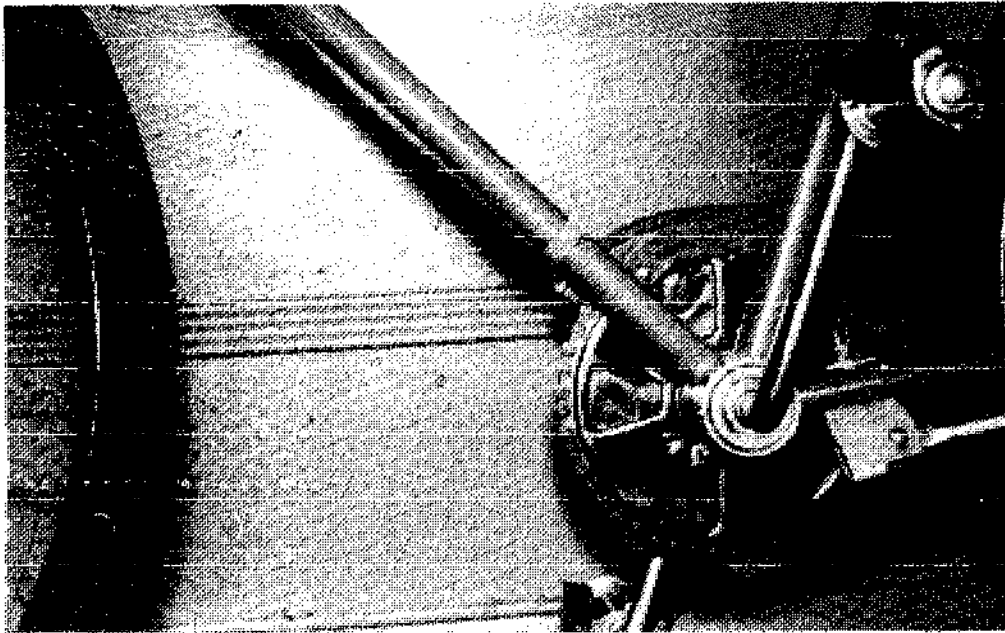

Fig. 7-6. Frame cut is shown.

sary for oversize frame tubing where the adapters, which come with the kit, are used. Drill the holes for the bolts before epoxy bonding. My suggestion is that you use the bolts. Otherwise the entire bond will be with epoxy only. An electric drill can be used for making the holes. Use a center punch and take special care to align the hole. Before drilling, position the couplings in the frame pieces. The holes must also be drilled through the coupling mounts that go inside the frame tubing. An alternate method is to epoxy bond the couplings in

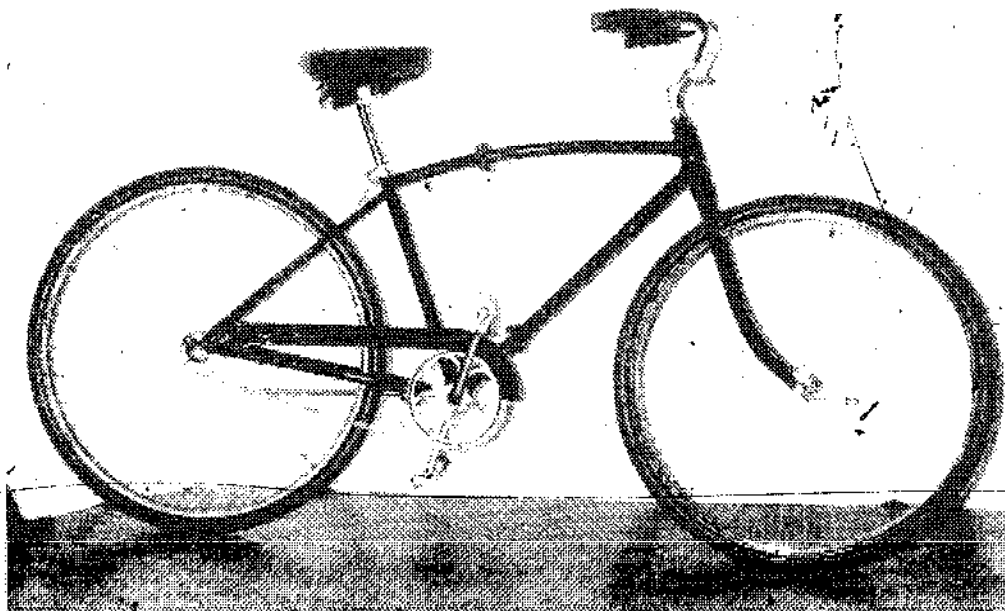

Fig. 7-7. A regular bicycle converted to a folding model by adding heavy duty-hinges purchased at a hardware store.

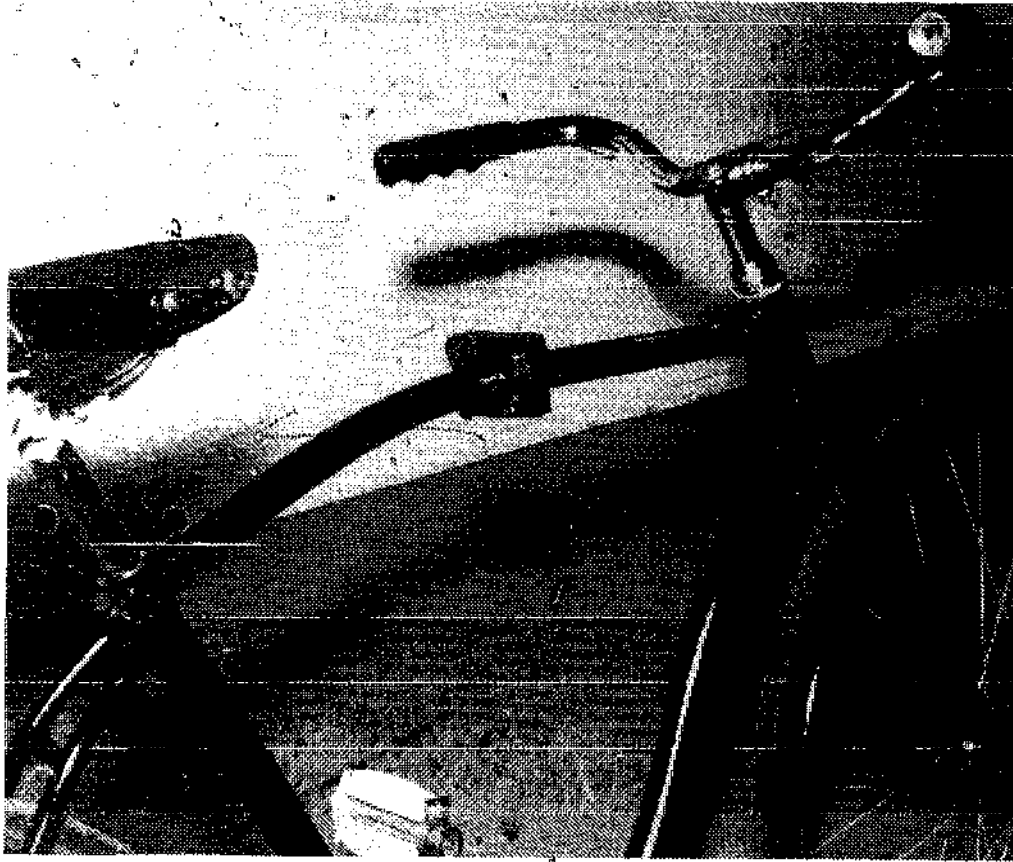

Fig. 7-8. A regular bicycle converted to a folding model by adding hinges made from stock materials.

place and then drill the holes and add the bolts after the epoxy has set.

Before epoxy bonding, take special care in preparing the surface of both the inside of the frame tubes and the couplings in the bonding areas. The surfaces should be clean and roughened. If the bolt holes have already been drilled, the bolts can be used to hold the couplings in position after the epoxy has been applied. If not, devise a system of blocks and clamps to hold the frame in position and alignment.

When everything is ready, mix the epoxy according to the directions provided. Then apply to both the coupling mounts and inside the frame tubes where bonding contact will be made. Install the couplings. Allow the epoxy at least 24 hours to set.

This might sound like a long and involved process, but it's actually much easier than it sounds. Without trying to hurry, I made the installation—not counting waiting for the epoxy to set—in less than two hours.

### **MAKING YOUR OWN**

I've made a couple of folding and take-apart conversions of regular bikes (Figs. 21-8 and 21-9). Both are hinged, but the hinge

Fig. 7-9. Hinges made from stock materials.

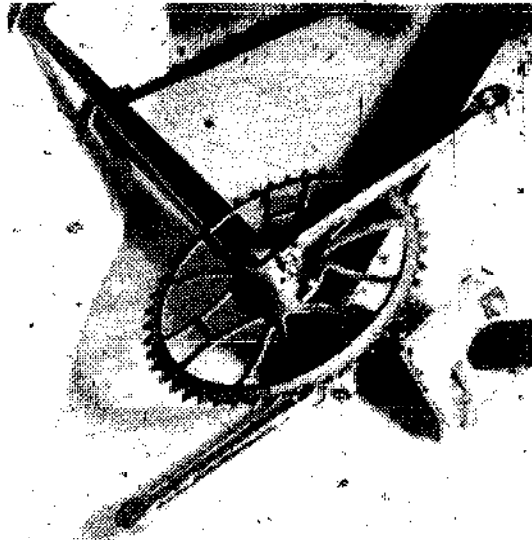

pins can be removed. The one shown in Fig. 7-7 has heavy duty hinges obtained from a hardware store. I made my own hinges for the one shown in Fig. 7-8.

These hinges are 2×2 inch heavy-duty loose-pin hinges. If you cannot find this size, larger ones can be cut down to size.

For the other bike, the hinges are made from steel stock and sections of one-quarter inch inside diameter pipe (Fig. 7-9). The sections of pipe are brazed to grooves made with a grinder on the

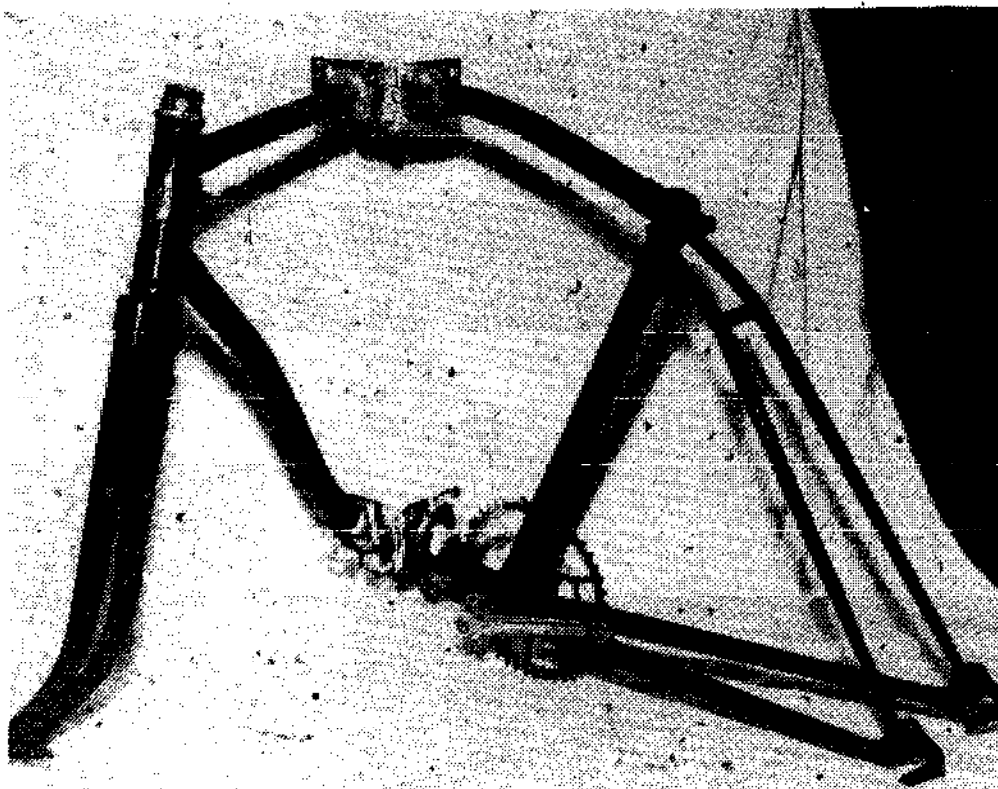

Fig. 7-10. Hinges brazed to frame pieces.



Fig. 7-11. Quick release seat-post clamp.

sides of the plates to form the hinges. One-quarter inch bolts are used for hinge pins.

For both methods, four holes are drilled through each folded hinge for thumb bolts. Nuts for these are brazed in place to the hinge plates.

After the hinges have been made, the next step is to decide where you want to position them in the frame. In order for the bicycle to fold properly, the hinges will need to be in line as though one long hinge pin were used for both hinges. Pins will be on the side of the bike away from chainwheel. Information on placement of hinges is given in the section on installing the kit.

Once you have decided on the position, mark the locations on the frame. The remainder of the installation is best done with the bicycle stripped of wheels.

Cut out a section the thickness of the folded hinge in one of the frame tubes. If the cuts are perpendicular to the bar, a tube cutter can be used. If not, use a hacksaw, but take special care to make the cut straight and at the proper angle.

Next, position one hinge and braze it to the frame tubes (Fig. 7-10). Make certain the hinge pin is on the side away from the chainwheel. If you are having a commercial shop do the brazing, it's generally least expensive if you have everything ready so that only the brazing need be done for you. Any cutting or positioning of hinges that is done for you by the shop will increase the cost.

After the first hinge is in place, clamp it together with the thumb bolts. Make the cutout for the second hinge. This must align with the first hinge as though the hinges were on a door. Position the second hinge. A good way to align them is to remove the hinge pins from both hinges. Leaving the thumb screws in place holding

the hinge plates together, run a single small rod through both hinges. This must be a near exact line up, otherwise the hinges will buckle. Some offset can be taken care of by having the pins (often bolts are used) slightly smaller than the mounting holes.

When everything is set, braze the second hinge in place.

Finish the project by cleaning up the brazing grinding, filing and sanding. Then touch up the frame and paint the hinges. Reassemble the components to the bicycle.

For additional compactness, you might want to add a quick release seat-post clamp (Fig. 7-11) which will allow lowering the saddle all the way down without a wrench. A similar gooseneck arrangement will allow the handlebars to be turned. A quick release front hub or replacement of axle nuts with wing nuts (Fig. 7-12) will allow quick removal of the front wheel. In this way, the handlebars can be turned as shown in Fig. 7-13 so that they do not stick out to the sides of the frame. This is accomplished without the need for a quick release gooseneck. The quick release devices described above are available from bike shops and mail order houses.

Shock cords with hooks on the ends can be used for securing the bolted bicycle. If the front wheel is removed, you can hold everything in a single package—as shown in Fig. 7-13.

A compact bicycle wrench can be used to take the place of quick release devices. This is somewhat less convenient, but it will save having to purchase the quick release devices.

Quick release pedals are also a possibility. Usually, these are used only on the pedal on the chainwheel side. You will only need one per bike. This allows the pedal to be folded so that it will not stick out to the side. However, quick release pedals are fairly

Fig. 7-12. Wing nuts allow quick removal of the front wheel.



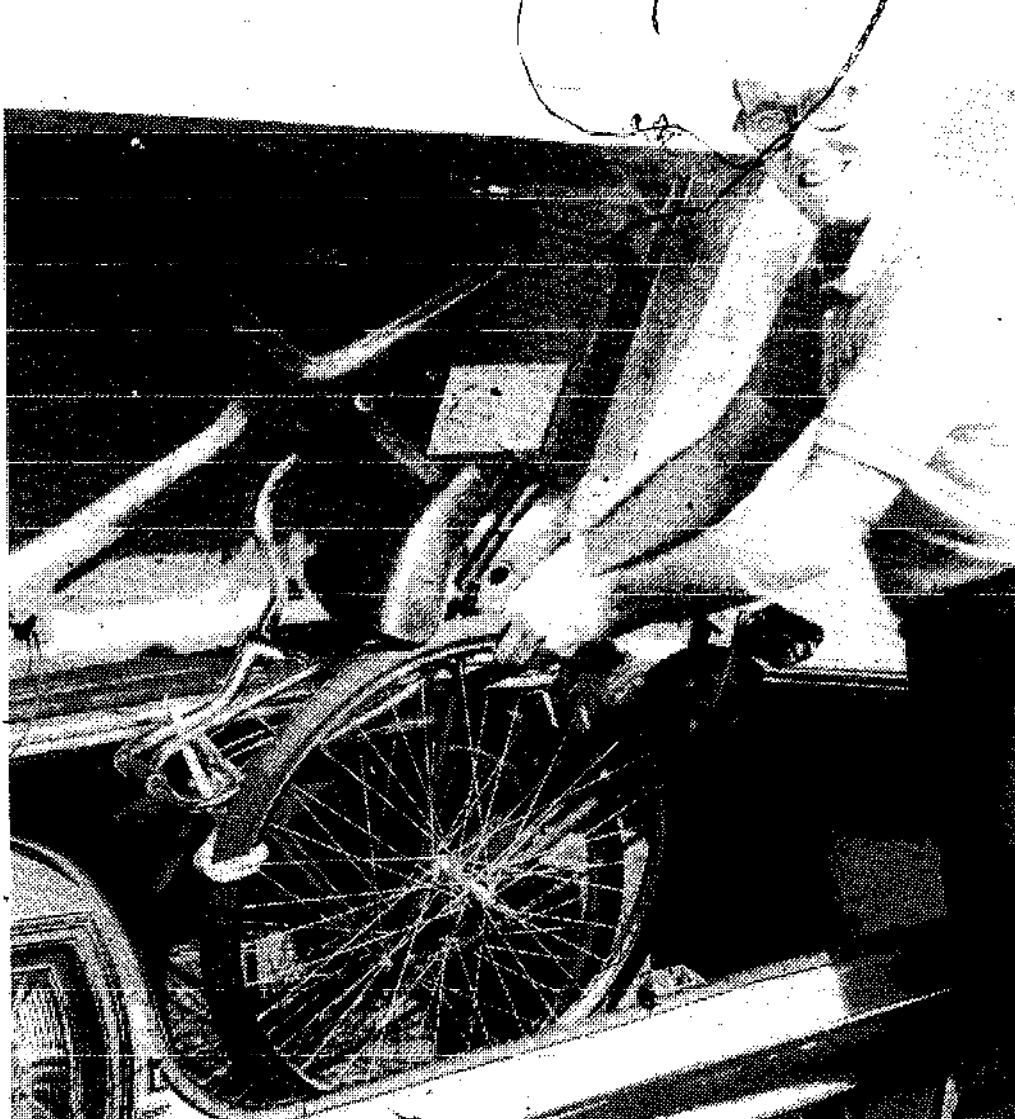

Fig. 7-13. Folded bicycle held as a single package with shock cords.

expensive and sometimes difficult to find. Consider the need for this convenience carefully. A substitute is to use a bicycle wrench to remove the pedal or pedals. They can be threaded into the opposite side of the crank arms when the bicycle is folded (Fig. 7-14).

You might also want to sew a canvas or plastic carrying case. By removing the wheels, saddle, handlebars and pedals from the frame, all of the parts of one of my folding bikes fit in the case shown in Fig. 7-15.

#### **MAINTENANCE AND REPAIR**

This is generally the same as for regular bicycles. The folding and take-apart mechanisms generally require little or no servicing other than perhaps a little bicycle oil now and then.

#### **TIPS ON USING PORTABLE BIKES**

While hinging and clamping methods vary, it's important that the clamps be firmly tightened before the bicycles are ridden. Riding

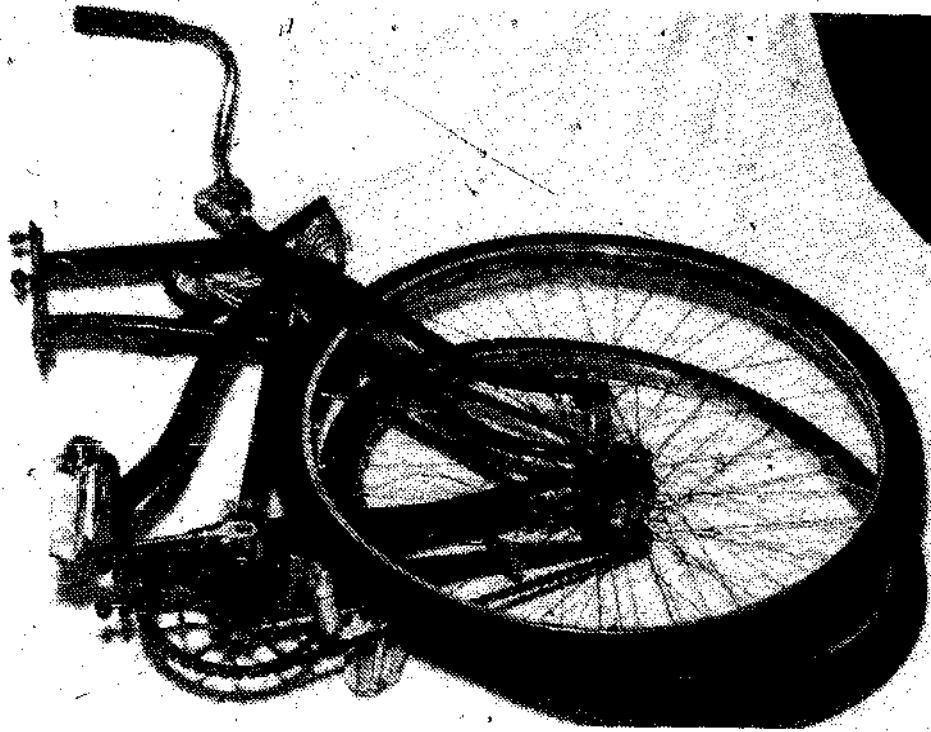

Fig. 7-14. A folded bicycle.

with loose clamps can cause damage. When riding long distances, check the clamps from time to time to make certain they have not worked loose.

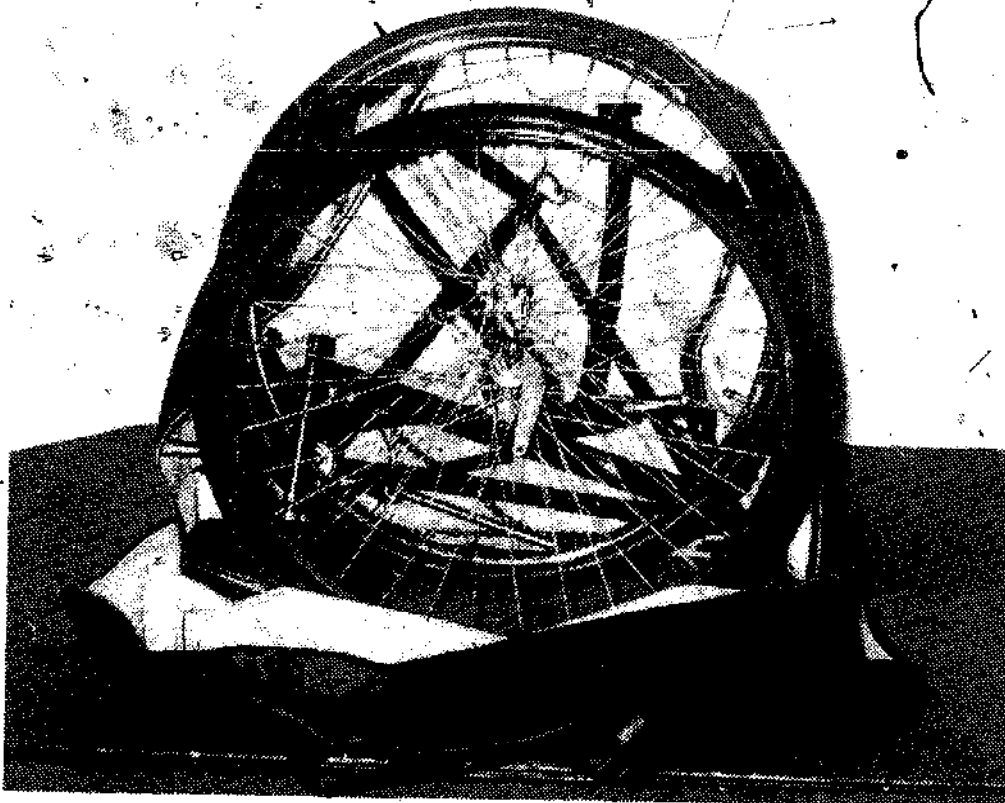

Fig. 7-15. By removing the wheels, saddle, handlebars, and pedals from the frame, all of the parts fit in this case.



When you carry along a portable bicycle in a boat or motor vehicle take special care as to how the bike is packed and stored. When mixed in with other heavy items, such as in the trunk of a car, the bicycle can be damaged by shifting items.

Before taking the bicycle along when you travel by public transportation, carefully consider the weight. I once tried traveling in Europe with a 30-pound portable bicycle that fit in a special carrying case. This, along with a small light suitcase, proved to be an impractical load to carry. After a few cities I gave up on the idea. Imagine, for example, struggling with 40 pounds when trying to make a train that is just pulling away.

However, this idea does have possibilities if the bicycle is checked as baggage. The idea would be to ride to the depot, fold the bicycle and put it in case which was previously carried strapped to rack of bicycle and check case as baggage.

As more and more public transportation systems allow regular bicycles to be transported as baggage, the value of having a portable bike will become less. However, at the present time, many transportation systems require that the bicycle be in a box or crate. If they don't furnish the boxes, as is frequently the case, you're in trouble. This seems to be a special problem in the United States. In Europe bicycles are frequently allowed uncrated.

## Stationary Exercise Cycles and Bicycle Rollers

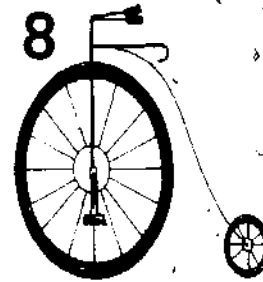

Being able to pedal a cycle in one place, going nowhere, has applications for exercising, training and physical fitness testing.

As a method of exercising, I feel that pedaling in one place is certainly more boring than riding a bicycle outdoors. However, there are people who for one reason or another do not want to be seen in public riding a bicycle, so they use a stationary cycle or bicycle on rollers in their own homes for the privacy. Still others use stationary cycling because they cannot ride a regular bicycle. With a stand mounted stationary cycle, balance generally isn't a problem. Some people, such as cardiac patients who are on prescribed rehabilitation programs, require exercise workloads that are lower or more controlled than is possible on a bicycle. Some people make use of stationary cycling in addition to regular bicycling, by doing the stationary cycling indoors when the weather is bad and using a regular bicycle outdoors in good weather.

While exercise is generally considered to be physical work, training generally implies the long term effect of exercise usually done for physical fitness and to improve performance. It is interesting to note that racing bicyclists often disagree among themselves about the value of cycling in one place. Some make extensive use of this technique and others avoid it completely.

A third use of stationary cycling is for physical fitness and performance testing. It is often advantageous to have the person being tested in one place so that various parameters such as the electrocardiogram or oxygen consumption can be monitored.

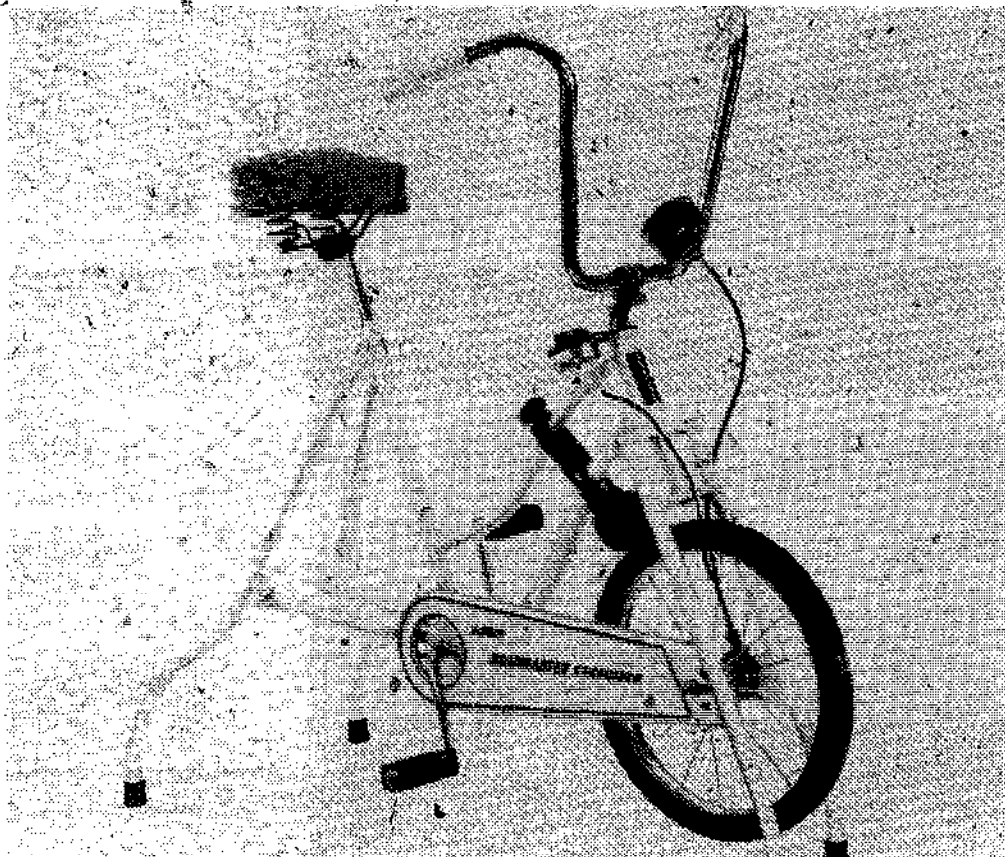

Fig. 8-1. AMF Roadmaster Exerciser.

While these things can sometimes be recorded during typical outdoor riding, it is generally easier and less expensive to do it with stationary cycling.

Stationary cycles allow the workload to be adjusted and controlled to a much greater extent than is generally possible on a regular bicycle. However, these things can generally only be measured and controlled on expensive laboratory stationary cycles. The ones commonly sold for home use—while allowing the resistance to be adjusted—have no method of gauging the workload or amount of work done.

The two main methods of stationary cycling are on a stationary device—usually shaped like the front half of a bicycle and mounted on legs—that allow pedaling against a resistance, and riding a regular bicycle—either free or supported—with the rear wheel only or both wheels on rollers.

There are also various motor-driven pedal exercise devices. It seems to me that these violate a basic principle of exercise for fitness, namely that you must do the work yourself to reap the benefits. Some of these "exercise machines," as they are sometimes called, are sold by high pressure salesmen and cost several hundred dollars. Used ones are frequently advertised in newspaper

classified ads for low prices or "consider any trade." I think the point is obvious.

### EXERCISE CYCLES

There are many stationary exercise cycles on the market. The lowest cost models are built with components similar to those used on children's tricycles and are generally of very little value. Quality models are built similar to bicycles and prices on these generally start around \$50 and run upwards to \$160 or more. As is the case with bicycles, you usually get about what you pay for.

Fig. 8-1 shows an *AMF Roadmaster Exerciser*. It features a sturdy welded frame, tension adjustment control and speedometer and timer (Fig. 8-2). The speedometer measures miles per hour and the odometer shows miles covered.

A *Schwinn Deluxe Exerciser* is shown in Fig. 8-3. It features a convenient control panel with speedometer, mileage indicator, timer and an adjustable pedal resistance control dial. The pedals have foot straps.

Since wind resistance isn't a factor, wide saddles placed fairly low are generally used. When selecting an exercise cycle, make certain that the saddle feels comfortable and is adjustable to the desired height. The cycle should pedal smoothly and the resistance be adjustable through a wide range of workloads.

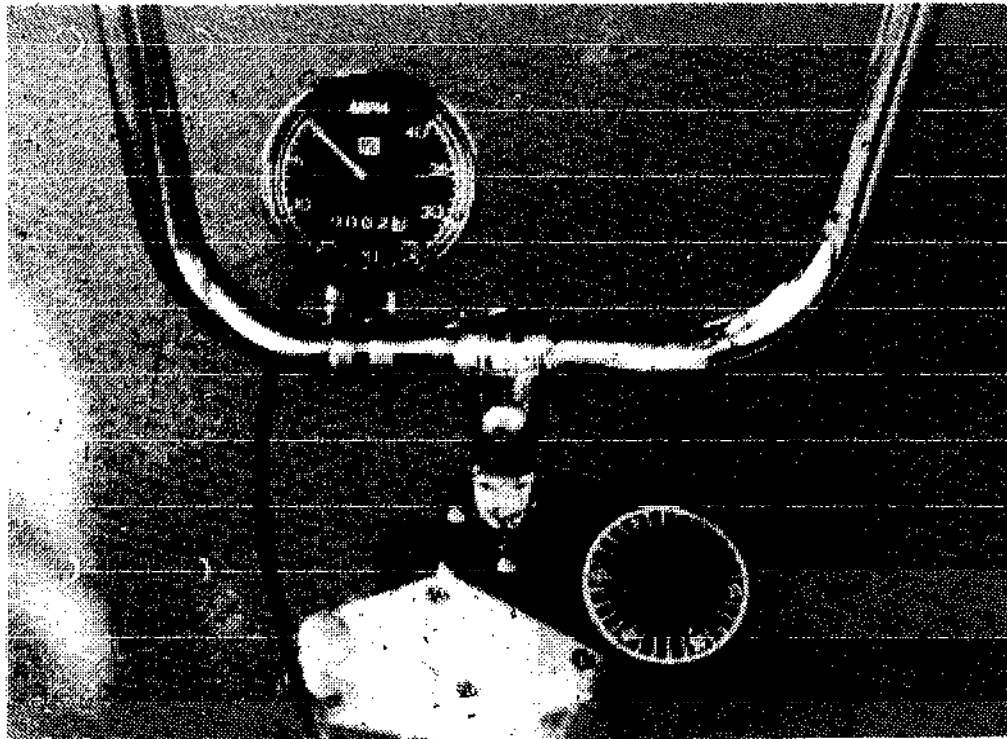

Fig. 8-2. Tension control adjustment, timer and speedometer on an exercise bike.

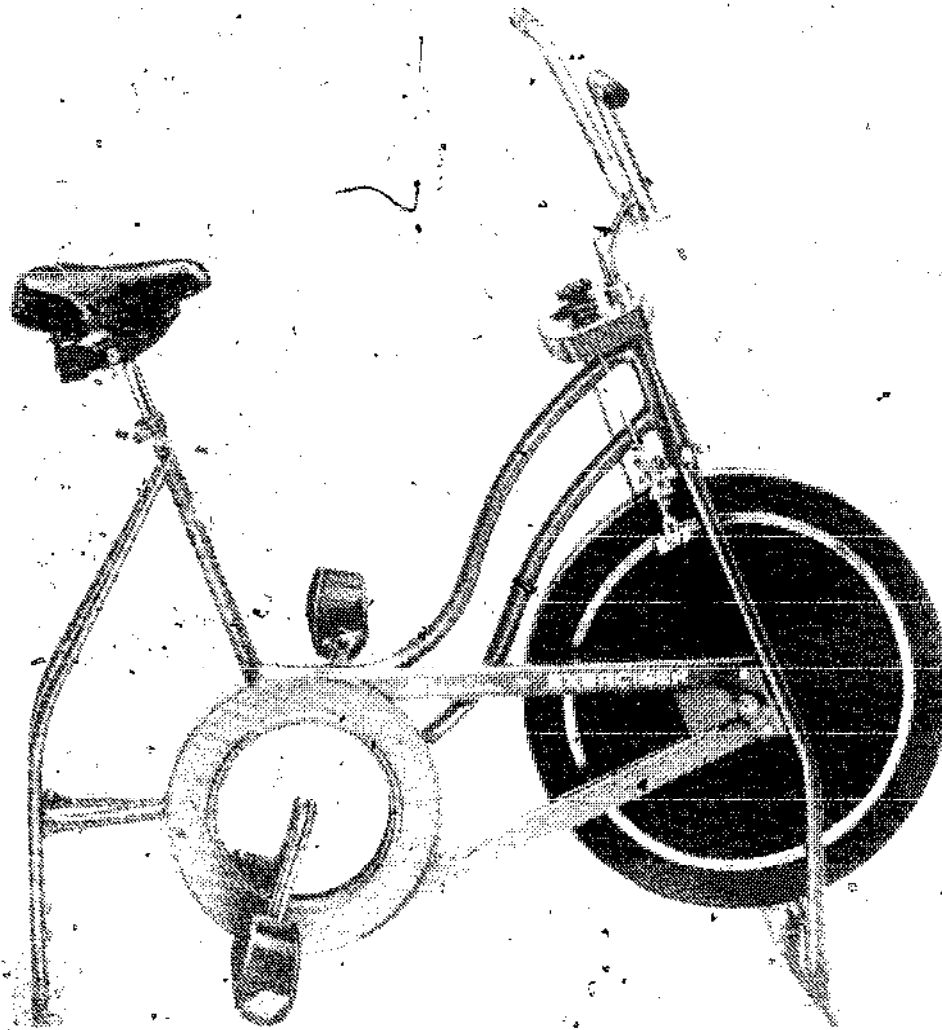

Fig. 8-3. Schwinn Deluxe Exerciser.

Timers, speedometers, mileage indicators and resistance indicators are important features since they permit you to carefully work out an exercise schedule.

### **CONVERTING BICYCLES TO EXERCISE CYCLES**

I built the one shown in Fig. 8-4 from inexpensive used bicycle parts. An old, damaged bicycle provided the bulk of the materials. Construction of the stand can vary considerably, as can the parts used in the construction. I used an inflated tire, but the smoothness of the ride would probably be better with a solid tire. Mine works well as long as the tire is fully inflated. The wheel on mine is freewheeling with a coaster brake, but you might want to use a fixed wheel sprocket like those used on some track bicycles, artistic bicycles and giraffe unicycles. See chapter six for construction methods.

The exact dimensions are not critical. However, the stand should be sturdy. The base must be large enough so that the cycle

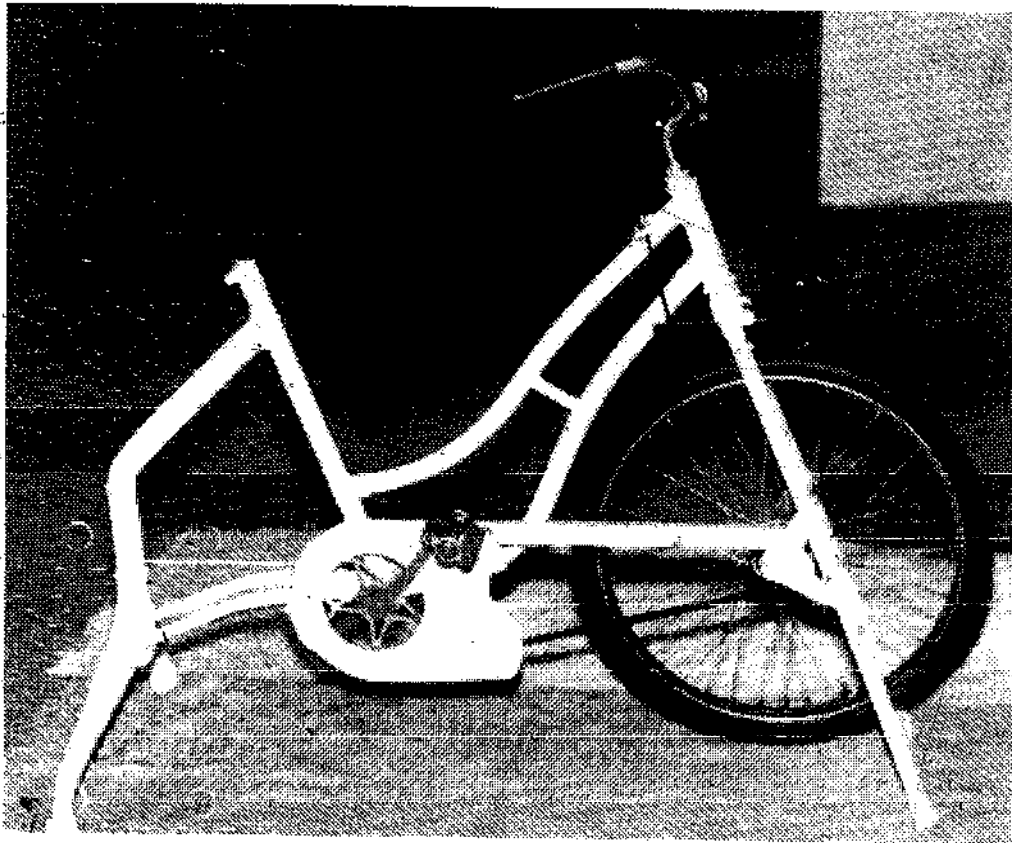

Fig 8-4. A home built exercise cycle.

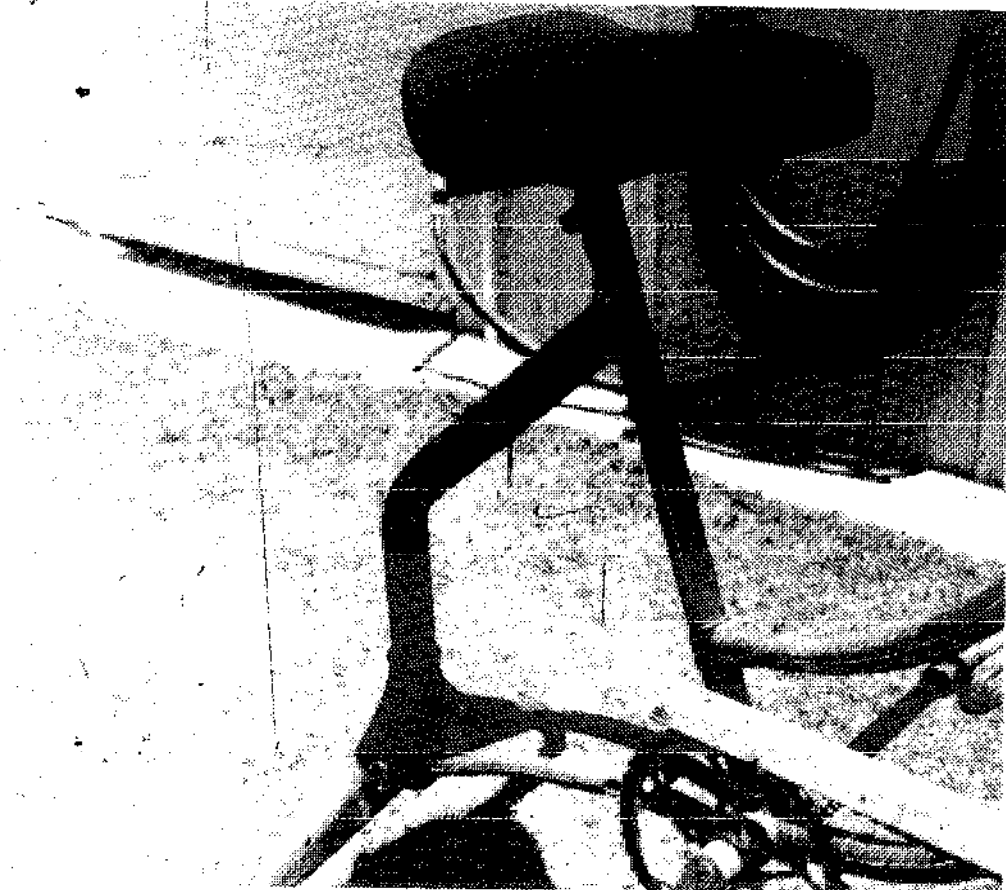

Fig. 8-5. An exercise cycle during construction.

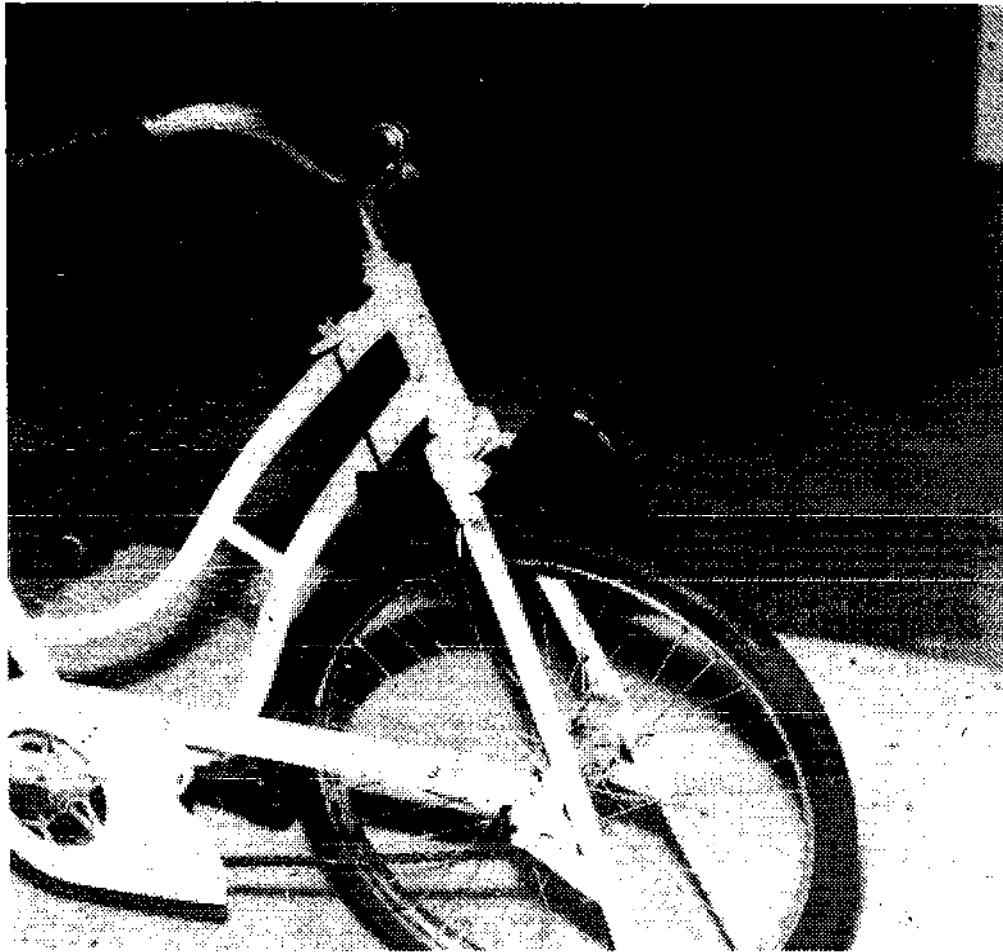

Fig. 8-6. The resistance wheel is pivot mounted. Adjustment of resistance is made by turning a wing nut.

will not tip and high enough to give ample clearance between pedals and ground at low points in pedal cycles (Fig. 8-5).

The rear wheel, which becomes the front wheel on the exercise cycle, is mounted so that the chain tension can be adjusted. Rear dropouts can be used or you can make up mounts from flat steel material.

The resistance wheel is pivot-mounted with an adjusting bolt as shown in Fig. 8-6. The small wheel should be lined up with the cycle wheel. The arrangement shown allows hand adjustment of the resistance while you are exercising.

The cycle should have a chain guard. I made the one shown from a regular chain guard, which was reversed, and then had an angle iron extension welded to it. Any type chain guard that will keep clothing from getting caught between chain and chain wheel will suffice.

If you prefer, a speedometer with mileage indicator can be added. A bell timer is also useful. The household type are inexpensive and will serve the purpose.

## BICYCLE ROLLERS

There are two basic types of bicycle rollers. One has a roller for the rear wheel only and a frame stand to support bike. The other type has two rollers. One is for the rear wheel and one for front wheel. The bicycle is either free or supported.

Figure 8-7 shows a frame stand with a single roller for the rear wheel. Figure 8-8 shows the stand attached to a bicycle and the bicycle in use. This arrangement allows shifting of multi-speed bikes, such as the bicycle shown. The steps in attaching the device to a bicycle are shown in Fig. 8-9 and Fig. 8-10. It's called the *Y-Cycle* and it is manufactured by *Kar Dol Inc., 15245 Hume Drive, Saratoga, CA 95070*. Important features are that no tools are required for attachment to a bicycle and it's not necessary to attach anything to the axle bolts.



Fig 8-7 Kar Dol frame stand.





Fig. 8-8 The stand attached to a bicycle.

A slightly different arrangement that does require attaching a stand on the axle of the bike is also on the market. But the Y-Cycle seems to be a much better idea.

A set of rollers with two rollers for the rear wheel and one for the front wheel is shown in Fig. 8-11. A belt connected to the forward of the two rear rollers turns the forward roller so that the front wheel, of the bicycle will turn and closely simulate riding conditions. They're available from *State Aluminum Foundry, PO Box 987, Paramount, CA 90723*.

Bicycle racers generally ride without any support devices for the bicycle. But this requires considerable skill. The stand and

clamp shown in Fig. 8-12 and used with the rollers enables most anyone to ride on the rollers.

Rollers are used by racers in a number of ways, such as for training during winter and warming up before races. Since there is no wind resistance, speeds of 50 miles an hour and more are possible. The distance covered is determined by the circumference of the rollers and the number of times they turn around. The rollers are a treadmill for a bicycle. By knowing the distance covered and the time taken, the speed can be calculated. In actual practice, this is done automatically on some training roller setups. The speed is shown on a dial that looks like a giant speedometer.

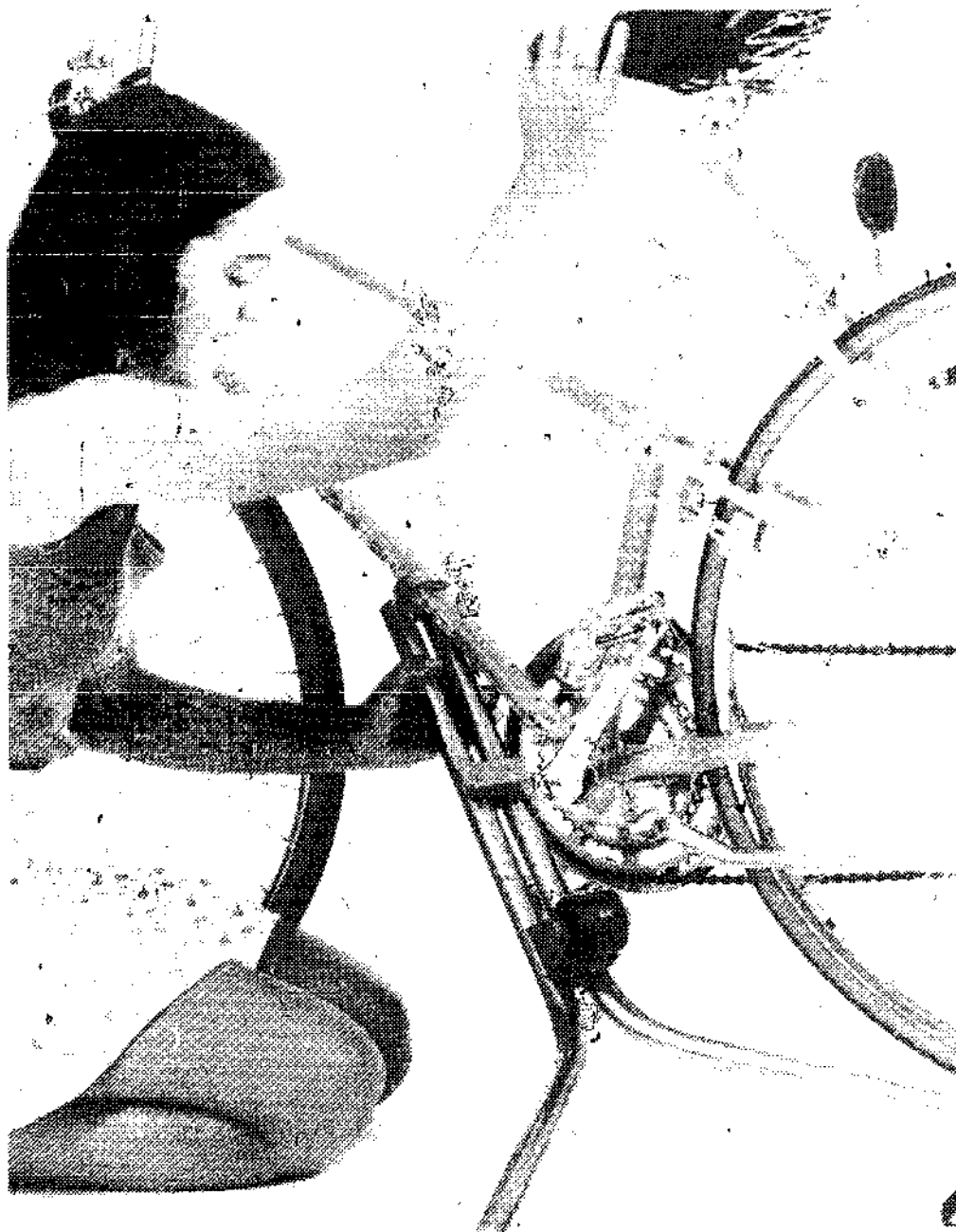

Fig. 8-9. Positioning the Kar Dol Stand.

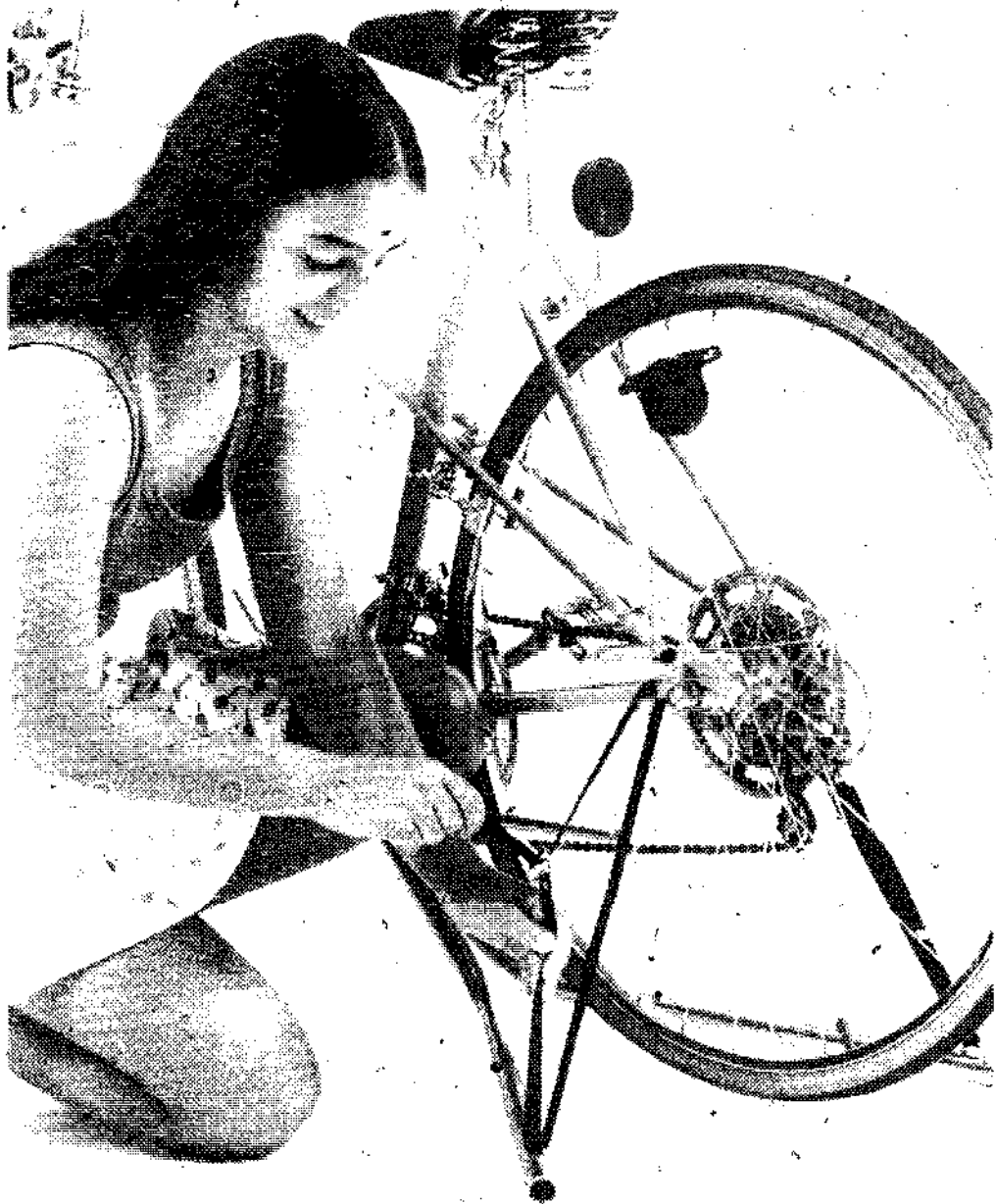

Fig. 8-10 The stand is held in place with straps.

An important advantage bicycle rollers have over stationary exercise cycles is that the rollers allow you to use your own bicycle. This is an important advantage for racing cyclists. While riding on rollers is often boring, it comes much closer to simulating actual riding than using an exercise bike. Riding on the rollers without anything supporting the bike does demand the rider's attention.

### **PHYSICAL FITNESS PROGRAMS**

Many people use stationary exercise cycles and bicycle rollers for physical fitness. It's always a good idea to check with your doctor before you start on a program. A set exercise schedule should be established. It's generally recommended that the workload be easy

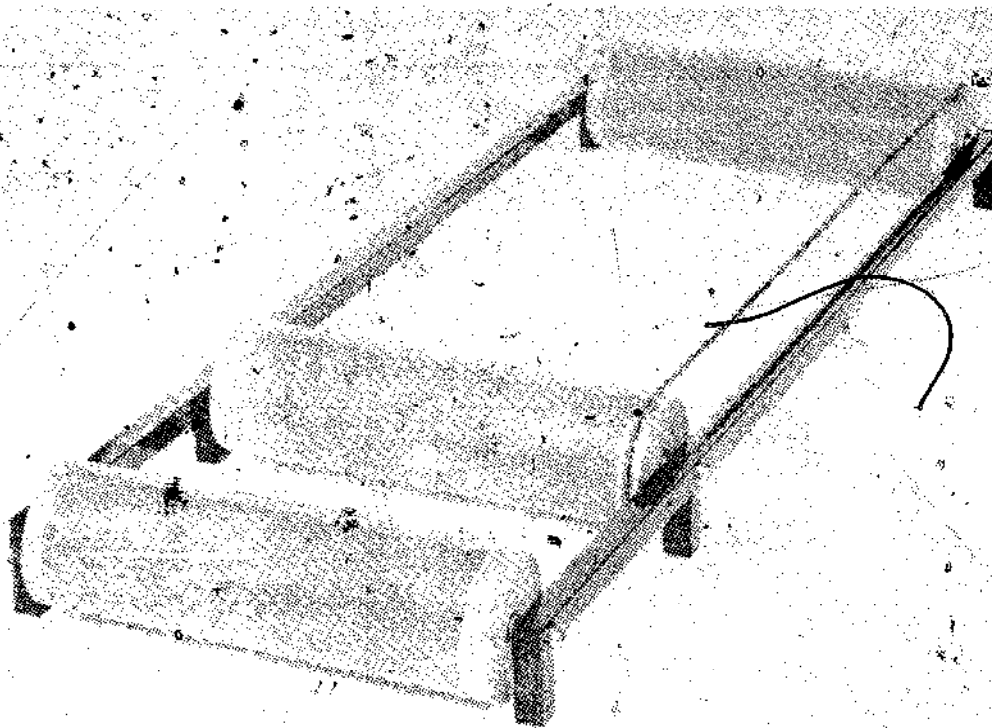

Fig. 8-11. Rollers for simulating riding conditions.

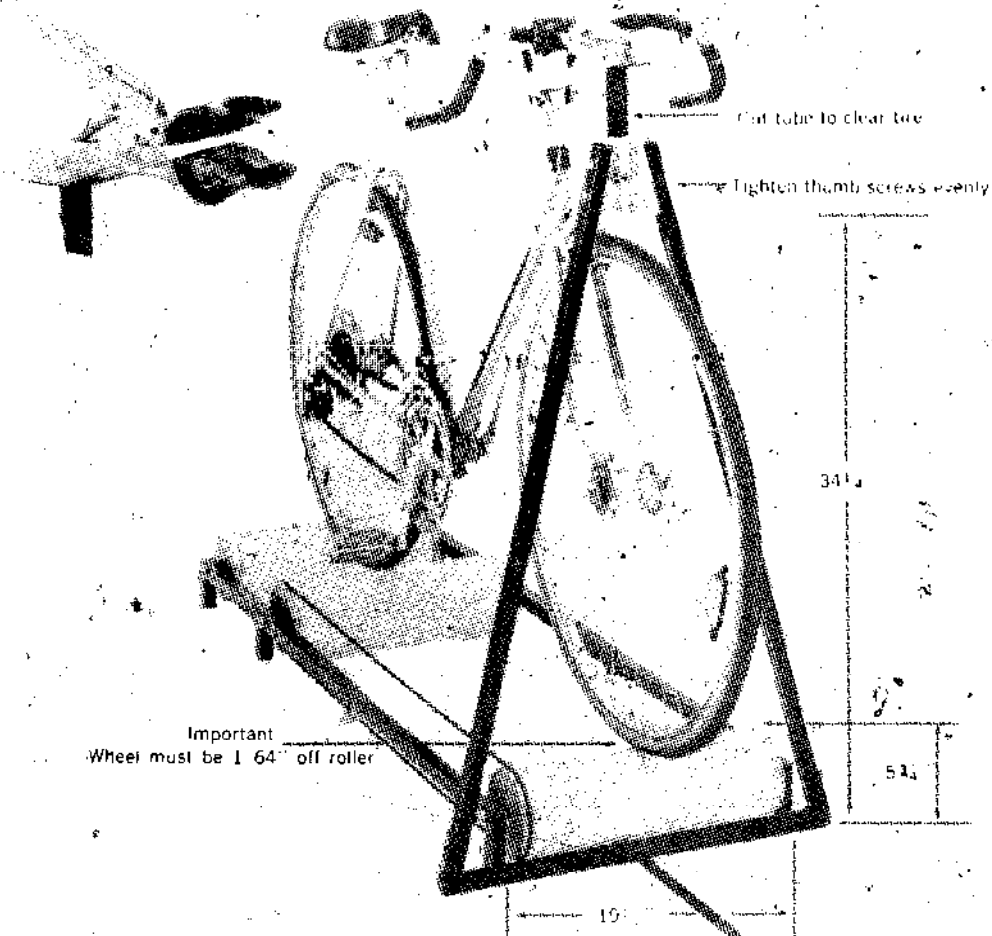
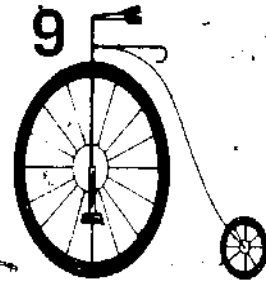

Fig. 8-12. Stand and clamp for use with rollers.

enough so that the exercise can be continued for 20 minutes or more, but opinions do vary on this point.

You can watch television while you are exercising on a stationary cycle or a firmly supported bicycle on one or more rollers. But don't try this while riding free on rollers.

## Motocross Bikes



Bicycle motocross racing—racing around a special course with a variety of jumps, turns and obstacles on special bicycles in time trials—is a popular sport for youngsters. It continues to grow and spread across the country.

Bicycle motocross competition has not yet been standardized to the point where there is a standard motocross bike. For fun without competition, ordinary high rise bicycles are suitable up to a point. However, most manufacturers warn that their standard models are designed for ordinary sidewalk and street riding and not for off-road use.

A number of bicycles designed especially for bicycle motocross use are now on the market. Figure 9-1, Fig. 9-2, and Fig. 9-3 show a sampling of these. They are designed and constructed to take the punishment that is typical of motocross riding, including jumping.

It is interesting to note that *Schwinn*, well known for their outstanding guarantees, will not cover claims on their standard high-rise bikes that are damaged while being used as motocross vehicles. Instead, they have developed the *Schwinn Scramblers* (Figs. 9-4 and 9-5) which are designed for this purpose and fully guaranteed for this use. This illustrates the point that motocross bikes are special bicycles that must be able to withstand stress far beyond that placed on ordinary bicycles for sidewalk and street riding.

While standard high-rise bikes can be modified to a certain extent for motocross use it would be difficult to list all the bicycles

Fig. 9-1. Ross Moto-X-Ross moto-  
cross bicycle.

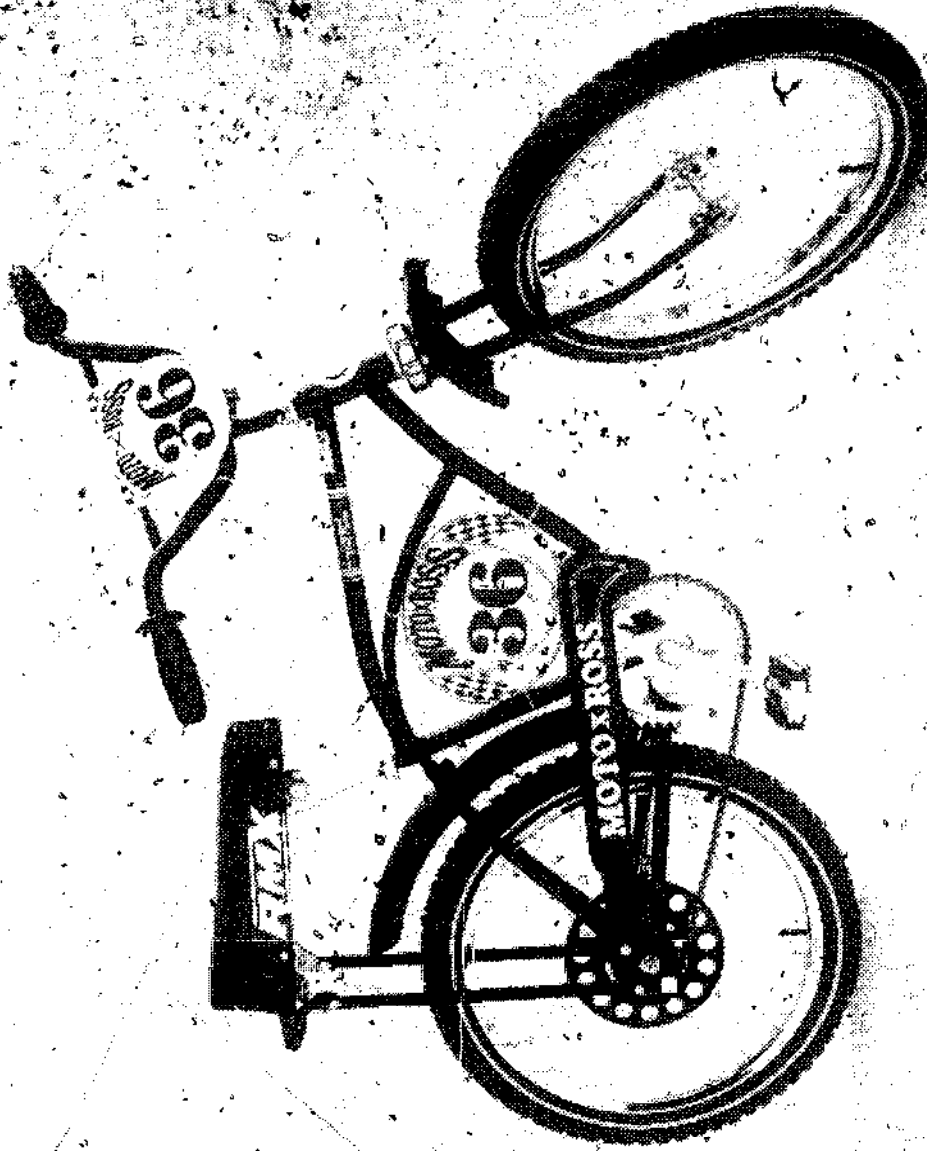
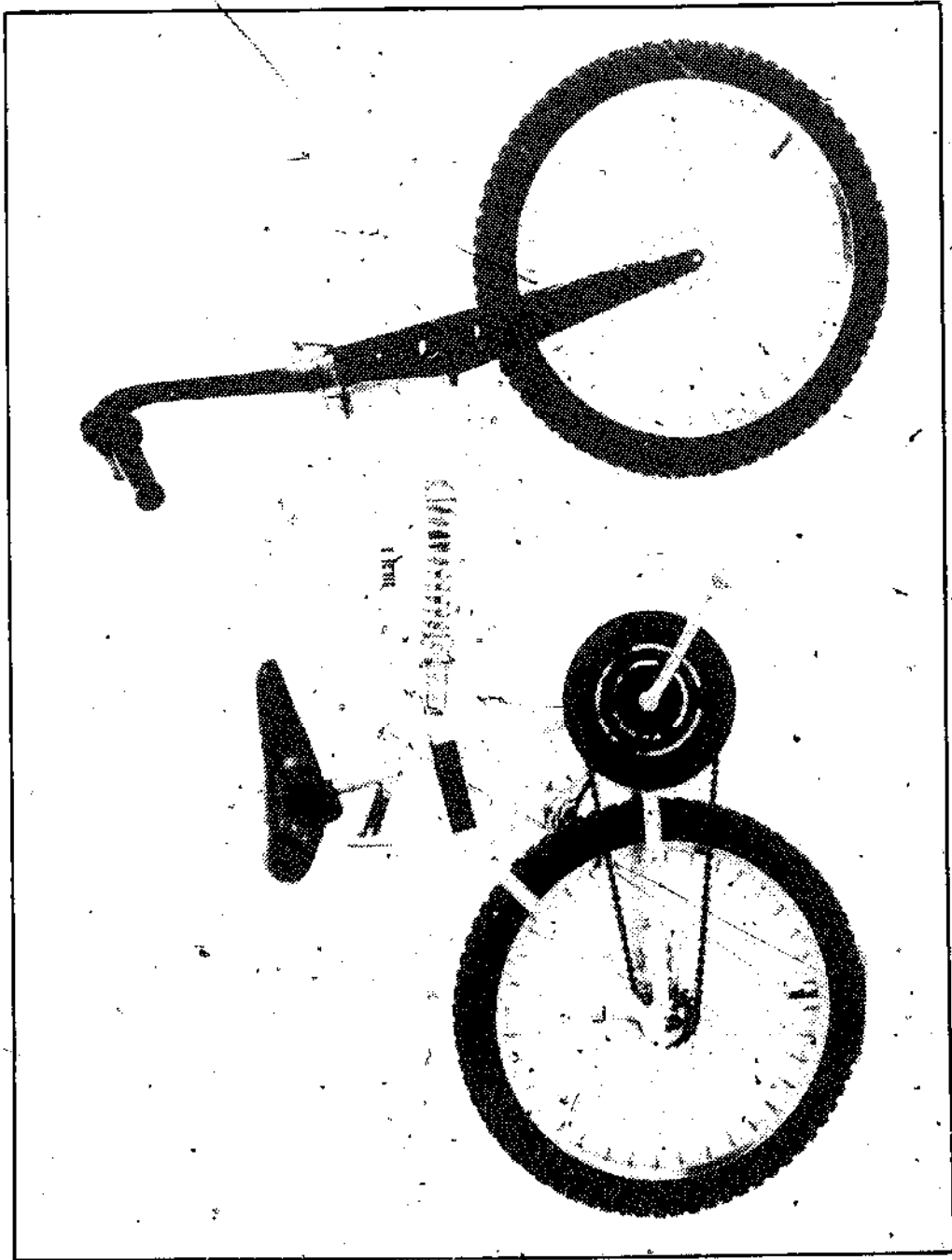

Fig. 9-2. Matthews Mono Moxie with adjustable shock absorber.





that have been specially designed for this purpose. Also, keep in mind that new designs and improvements are still being introduced.

Motocross bikes have been patterned largely after motorcycles. There are world championships in another type of off-road bicycle racing, called *cyclo-cross*, but this seems to have had little to do with motocross in this country. The bicycles used in *cyclo-cross* are typically 5-speed lightweight derailleurs.

Most motocross bicycles have 20-inch wheels, front and rear. There are a few exceptions to this, such as models with a smaller front wheel, but the general trend seems to be toward having the 20-inch wheels as a standard for competition.

Some have rigid or unsprung frames. Others have spring suspension frames (Fig. 9-6 and Fig. 9-7). Various methods of suspension are used. The advantages, need and safety of sprung bikes is still controversial. The basic idea is to give the bicycle rider a softer landing from jumps and a better ride over ruts and bumps. At the same time, it must not hamper the control and safety of the rider. A number of manufacturers offer both rigid and spring suspension models that are similar in other aspects.

Suspension systems generally add weight which might offset any competitive advantages gained. In any case, 40 pounds seems to be about maximum for a bike that is to be competitive.

An important difference between ordinary high-rise bicycles and motocross bikes is the frame. Manufacturers have gone to considerable efforts to design and construct frames that can take the rougher treatment that will be demanded of them.

Motocross style handlebars look like those on a motorcycle. They generally use rubber grips and have the handlebar crossbar and gooseneck padded. These are generally safety requirements for competition.

Heavy-duty wheels are used with thick channel rims, 20 x 2.125 tires and heavy 120 or 105 gauge spokes. Thirty-six to 40 spokes per wheel is the standard on the better manufactured models. The tires are fat and knobby. Heavy-duty hubs are used. The lacing is typically with a four-cross spoke pattern.

Magnesium and aluminum alloy wheels (Fig. 9-8) are sometimes used on motocross bicycles. These are braced without the usual wire spokes. They are light and strong. Whether or not they will increase performance in competition remains controversial.

Steel rattrap pedals of special heavy-duty construction have become the standard type for motocross use. Landings from jumps are typically made with the rider standing on the pedals without

Fig. 9-3. Mathews Moxie III—a truly functional racing rigid motocross machine.

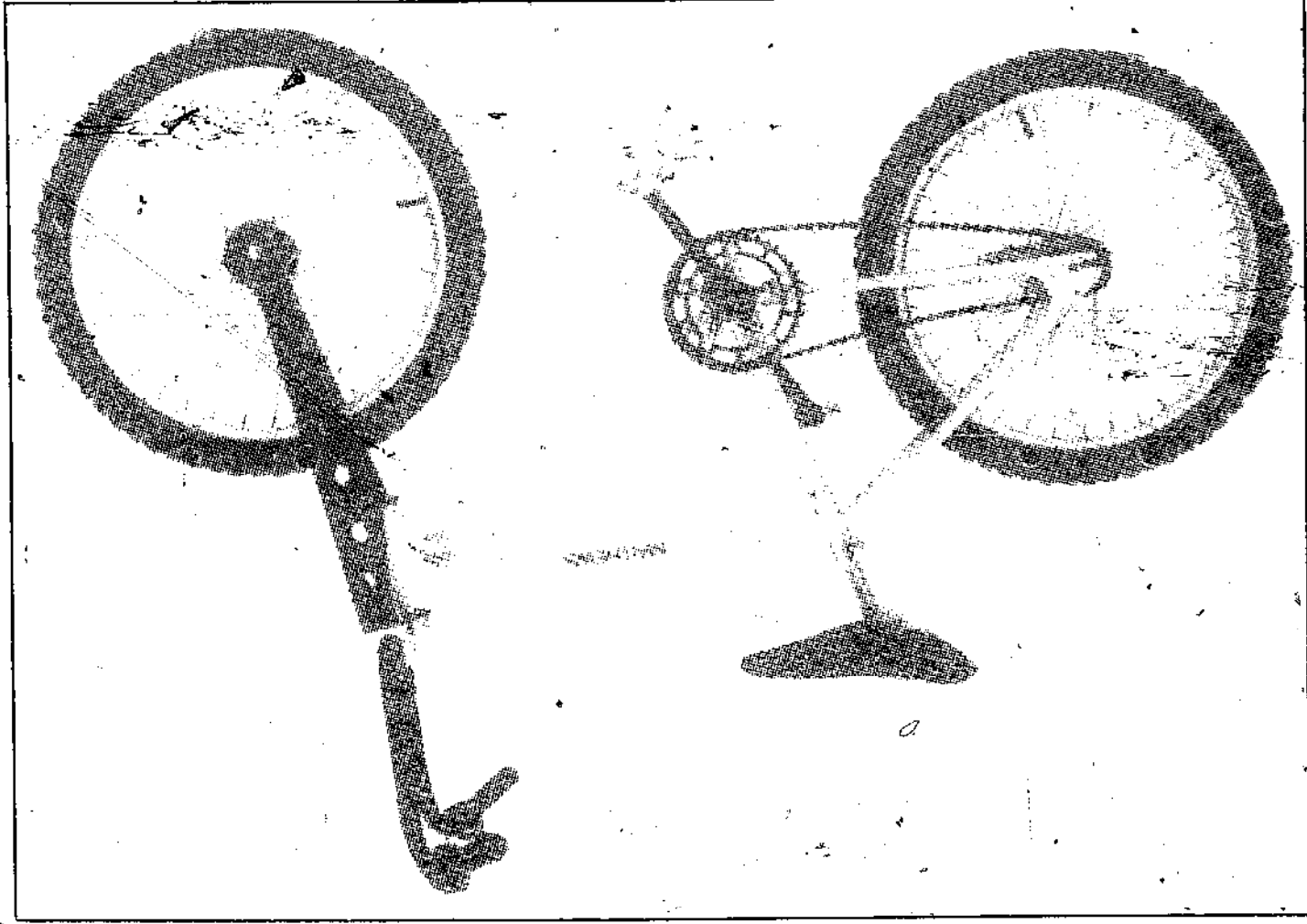

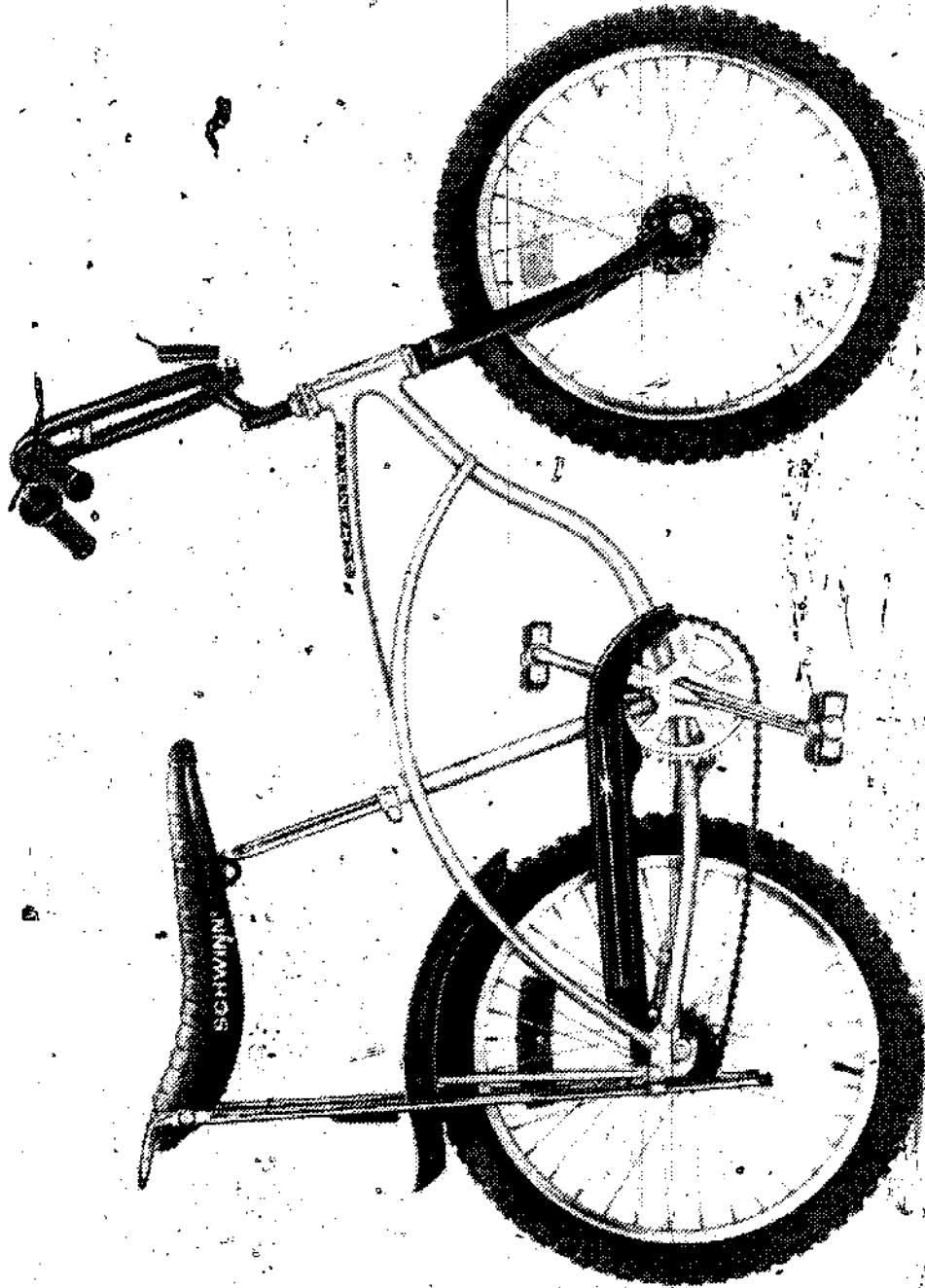

Fig 9-4 Schwinn Scrambler

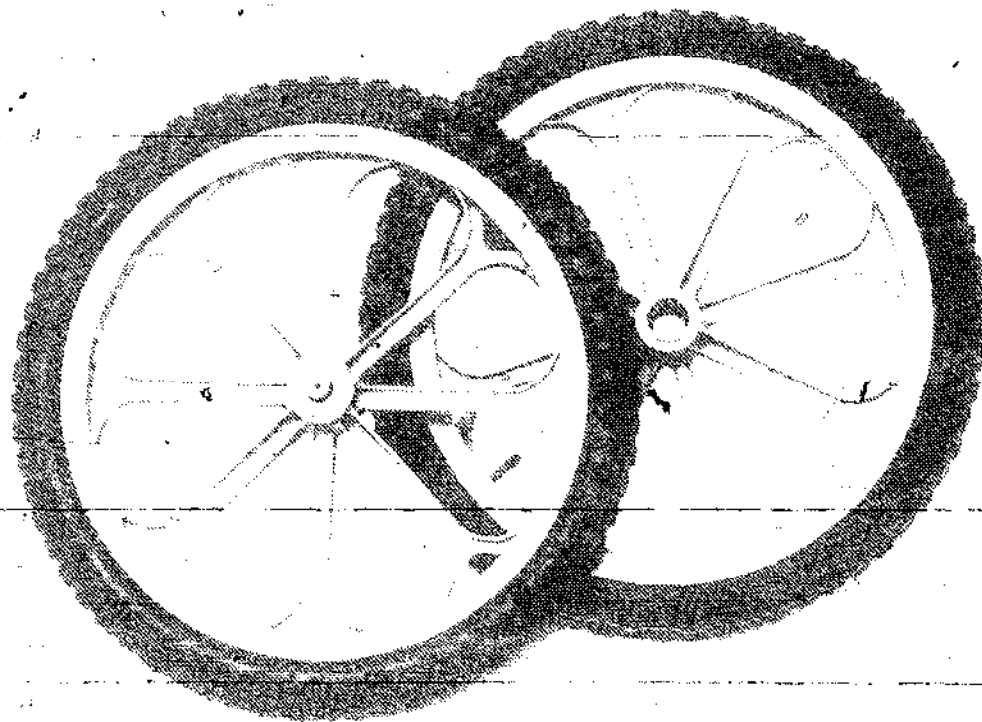

Fig 9-8 Trans-American-West MX-80 aluminum alloy bicycle motocross wheels.

plates are available to complete the conversions. However, the finished bicycle generally falls short of most manufactured BMX bikes—although it can still be satisfactory.

I also looked into the possibility of buying and then finishing a motocross bicycle frame. A number of these are on the market. However, I priced all the individual components and found that everything needed to assemble a complete bike totaled more than a complete bike with the same frame and components. This might be a way to go, however, if you have access to components or if you can make do with used components.

A typical path to a motocross bike is to start out with a regular high-rise bike. Then buy components to convert it to a motocross model. Then when the frame gives way, as frequently happens, to purchase a motocross frame and add the components to it.

### MOTOCROSS COURSES

There is no standard motocross course. A typical layout is a looped track course, which is usually from one-eighth to one-third mile around. Races are usually one or two laps. A sample course is shown in Fig. 9-9. Courses generally include jumps—usually one about three feet high and several smaller ones—mud holes and various types of turns. The courses generally do not have much uphill. The downhill, if present, is generally gradual. Courses vary

Fig. 9-7. Gobby Moto-Cross bicycle  
with suspension frame.

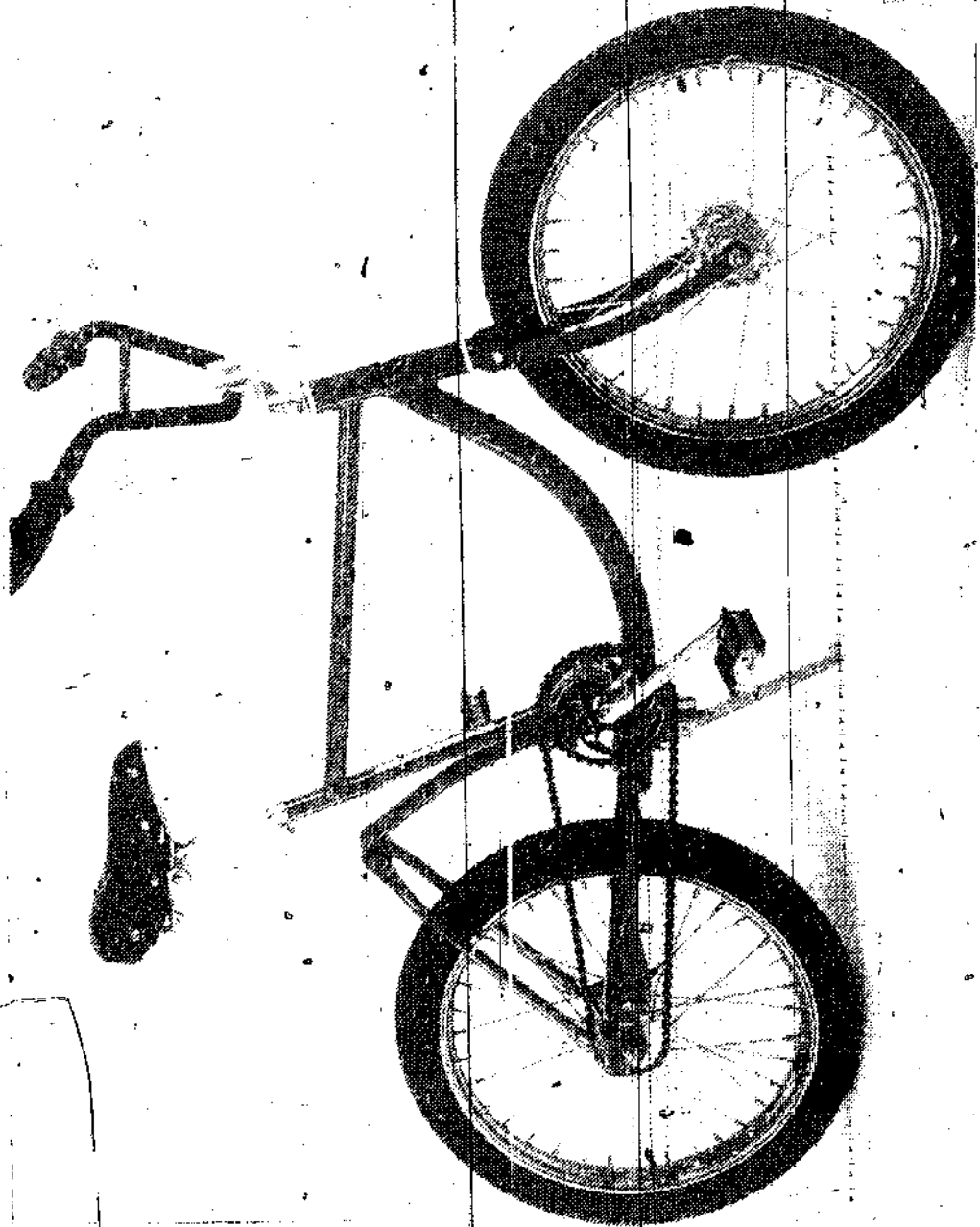

sitting on the saddle. The pedals must be strong to stand up to this treatment.

Another important feature is raised crank hangers that allow the use of longer crank arms. This gives a leverage advantage that is important in trials racing. This type of racing is most popular today.

While rear disc and internal drum brakes with handlebar hand lever controls are sometimes used, coaster brakes remain the general standard.

Single-speeds seem to be best to typical motocross courses, although two-speed automatic shifting hub gears might offer an advantage in some instances and are sometimes used. Lever shifting bikes, while available, do not generally seem to offer a competitive advantage. They are perhaps more of a hinderance than anything.

When motocross first started, banana type saddles were most common. A slightly modified version is still popular, but many bikes now use a single-post saddles. These seem to offer some advantage because of lighter weight and having the rider further forward. Like so many things about motocross, this is a controversial area.

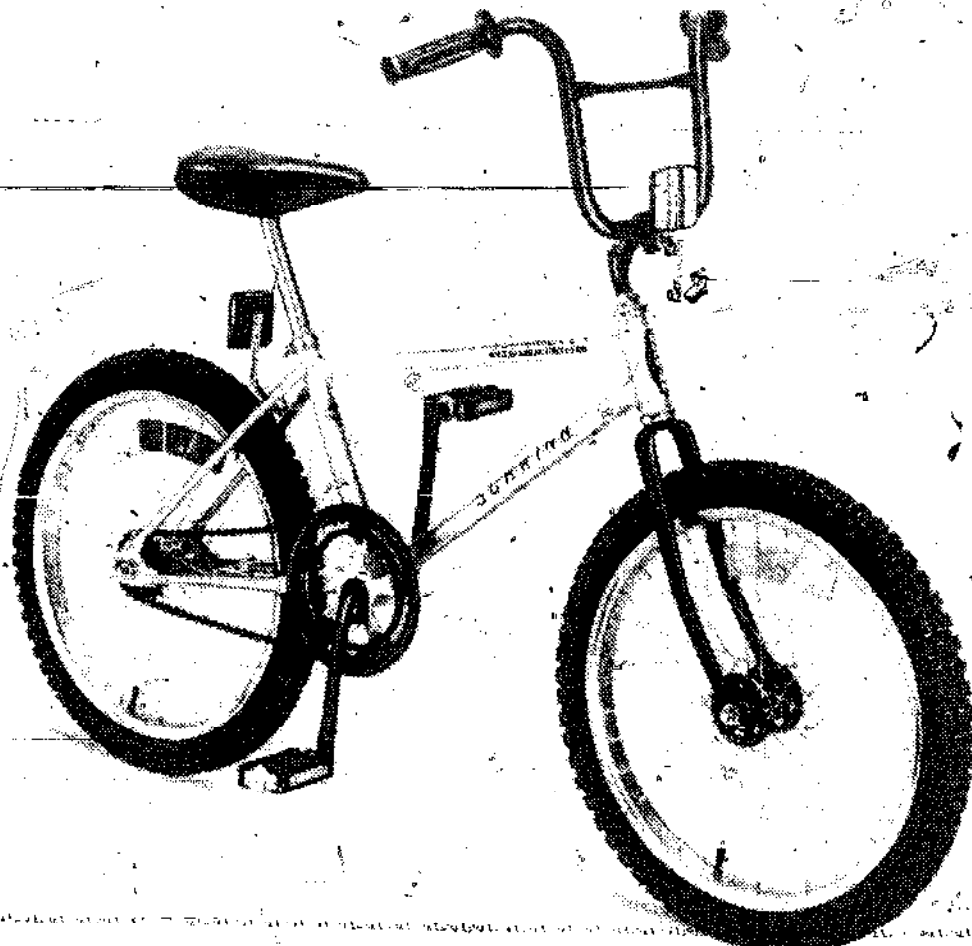

Fig 9-5 Schwinn Scrambler Model BX5-6 competition bike.

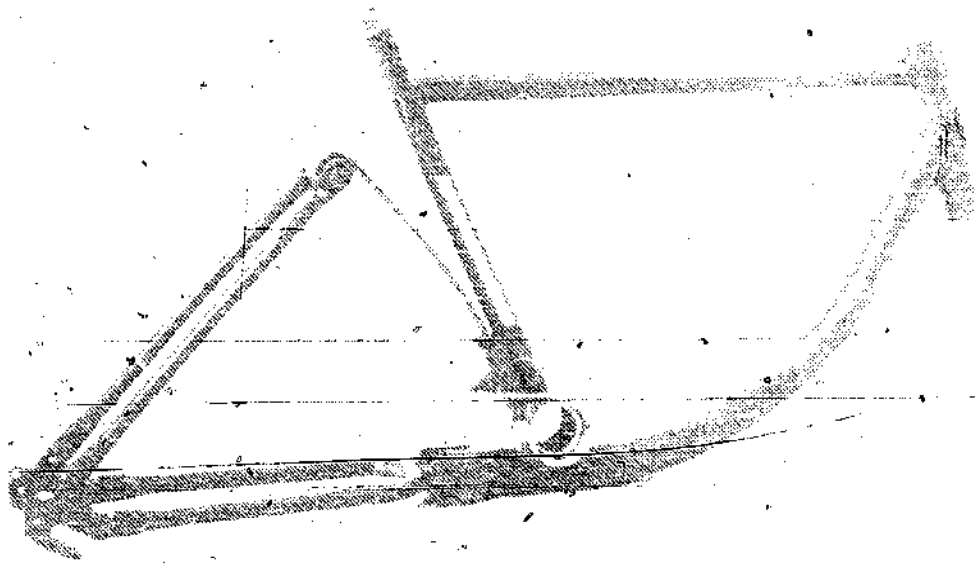

Fig. 9-6. Gobby Moto-Cross spring suspension frame.

Motocross bikes should not be confused with regular bicycles that are decorated with lean-back saddles and tanks to look like motorcycles. Motocross bicycles used for competition are generally stripped of all unnecessary, non-functional equipment—especially if it adds weight to the cycle. I am personally impressed with the rugged simplicity of some of the better built motocross cycles. The cycles that work in practice are copied and further improved.

## CONVERSIONS

Bicycle mechanics who are familiar with motocross cycles frequently point out that you can make an ordinary bicycle look something like a motocross model. But making it so that it will stand up to the rough treatment is another matter. The fact is, almost all components of a quality motocross bike are specially designed—including the frame.

Twenty-inch wheel high-rise bikes are frequently converted to motocross models. The regular frames are braced with gussets of steel plates shaped to fit where the main tubes of the frame join. Generally, these should be brazed rather than welded in place. The lower temperature is generally less damaging to the frame tubing in areas surrounding the weld.

A number of components and kits, including built-up wheels, a special motocross stem, handlebars, grips, bar-guards and number

Fig. 9-9 A typical bicycle motocross race course.

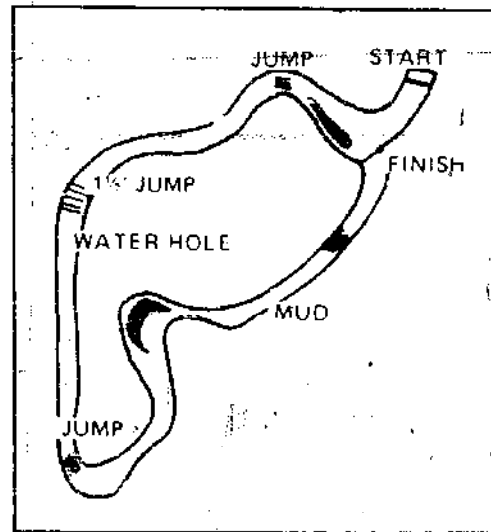

across the country and they are often set up to take advantage of the local terrain.

Safety should be kept in mind when you set up a course. There should not be any off-course solid objects such as a tree or rock at an entrance to a turn. Solid objects around the course should be buffered with old tires or hay bales. The start should be about 30 feet wide. This will give enough room for 10 bikes. Straight-aways and fast turns should be at least 10 feet wide. Slow turns can be a few feet narrower.

Riders generally are required to start races in a stationary position, with one foot on the ground and the other foot on a pedal. The races are generally run in heats with 10 riders in each heat. The riders are timed and it is these times that determine the place winners among the heats. Generally, there are no finals for the winners of the heats.

### TECHNICAL INSPECTION OF BICYCLES

Bicycles generally have to pass a safety inspection on the day of the race. The bicycle must be checked to make sure that it is in safe operating condition, with necessary safety padding, no axle ends protruding more than one-quarter inch and so on. Also check to see that all bikes meet rules. For example, the rear wheel must be no larger than 20 inches.

### SAFETY GEAR

Helmets with chin straps are generally required for all riders. All riders must wear suitable shoes, with no sandals or bare feet, for obvious reasons. Gloves and long sleeve shirts or racing jackets, if not required, are highly recommended for safety.



## RIDING TIPS

The most important thing is a lot of practice over courses and on the road! Don't pedal while you are making a sharp turn. Have the pedal up on the side in the direction you are turning so that you won't snag the pedal on the ground.

Jumps are best made when you have a lot of speed going into them. Pedals should be horizontal during a jump. Pull back on the handlebars and lean forward. If possible, you should land on the rear wheel with the front wheel slightly in the air. This puts less stress on the bike and gives better control.

## MAINTENANCE AND REPAIR

Maintenance and repair is basically the same as for a regular bicycle. Always use components designed for motocross use when you make parts replacements. Children can frequently learn how to service and repair their own bicycles.

## Bronco, High-Rise and Pivot Bicycles

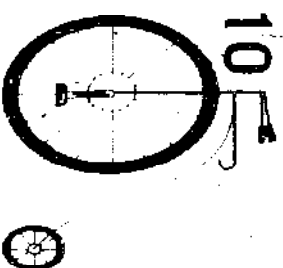

Bronco bicycles are fun novelty cycles and are ideal for riding in parades. A bronco bicycle is a bicycle with off-centered wheels. These cycles are not manufactured, but conversion of a regular bicycle is fairly easy.

### CONSTRUCTION OF BRONCO BIKES

I suggest that only single-speed middleweight bicycles be used for these conversions. A 26-inch or 27-inch wheel frame can be used for 24-inch off-centered wheels, or a 24-inch wheel frame with 20-inch wheels. ~~The~~ ~~crank~~ ~~arms~~ ~~or~~ ~~complete~~ ~~crank~~ ~~in~~ ~~the~~ ~~case~~ ~~of~~ ~~one~~ ~~piece~~ ~~cranks~~ — with shorter ones in order to get sufficient pedal to ground clearance. With the smaller off-centered wheels both at the point where the hub is closest to the ground, there should still be about three inches of pedal-to-ground clearance at low points in the pedal cycle.

The main job is lacing the off-centered wheels. The following information assumes you are familiar with the material on lacing presented in chapter five.

You can use the hubs already on the bicycle that you will be converting. You will need two rims of a smaller wheel size with the same number of spoke holes as the hubs.

With old wheels removed from the bicycle, remove tires, tubes and rim liners. Then remove spokes. You might want to do this one wheel at a time and save the other wheel for use as a model. The first off-centered wheel can serve as a model for doing the second one.

Begin by making a wooden platform to position the hub and rim on its side. The hub is off-centered and the rim is lined up with the center of the hub. The maximum amount of off-set will be determined by how much will still allow the tires to clear the wells on the bicycle frame and fork. Two inches off center is usually ample for a good effect.

The old spokes from the larger rim will suffice if they are in good condition. You might want to purchase new ones that are this length or longer. When you spoke the off-centered wheel, they should be cut off and bent, first 90 degrees, and then on around or back in the original direction after they are passed through the holes in the hub flanges.

While there are a number of possible spoking patterns, I suggest that you copy a spoked wheel that has the same number of spokes as the one you intend to off-center. The same crossover pattern, usually three or four, can be used. See chapter five for a discussion on this. Since you will be cutting and bending the individual spokes to length, most any pattern will work. Some will provide a sturdier wheel than others.

With hub and rim blocked into position, begin with any two spokes that are a half space apart on opposite hub flanges. Pass through the hub the same direction, such as with heads up or heads down, and attach to the rim in holes next to each other. You will be duplicating the lacing arrangement on the wheel you are using as a model. Position it next to the wheel you are lacing.

Begin with the longest spokes. Insert them through the rim holes and thread the nipples on four turns. Mark the length where the bends is to be made. Run the spoke to the point where the hub will be twisted like the one you are using for a model. Bend the spoke—two spokes will be the same length—and then cut it off one-half inch past the bend. This is done on each spoke.

Pass the first two spokes through the hub flange holes in the same directions as the two spokes you are copying on the model wheel. Either loop the cut off end of the spoke on around until it joins the spoke or bend it back in the original direction so that the spoke forms a zig-zag with sharp bends where it passes through the hub flange hole. Do the same for the second spoke. You should now have two spokes installed.

Continue lacing the wheel in this manner. Bend each spoke at the point where it will just pass through the hub hole with the hub twisted to its final position in relation to the rim and spokes. Before measuring and bending each spoke, thread it four turns onto the

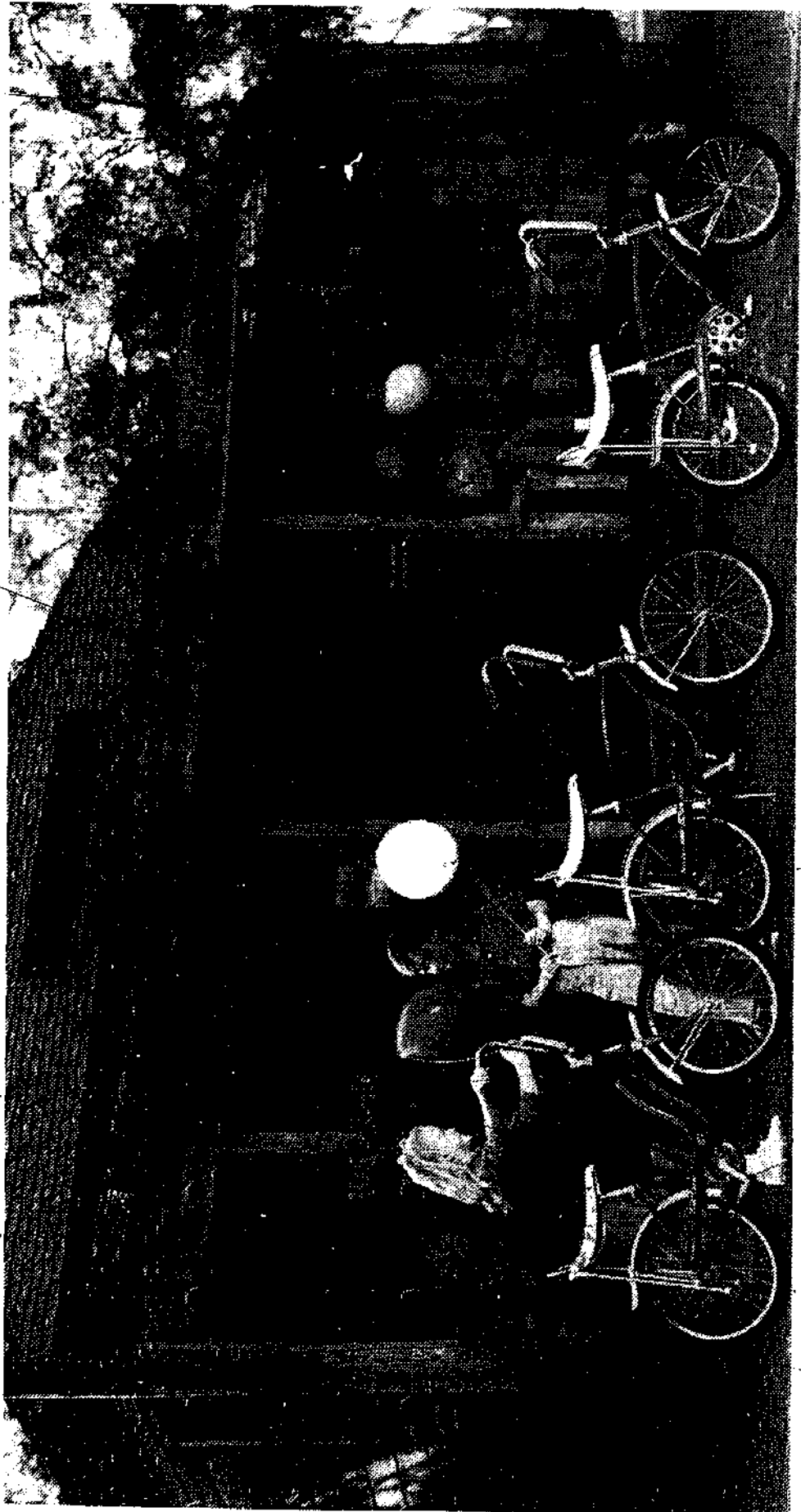

Fig. 10-1. High-rise bikes are popular fun cycles for children

5

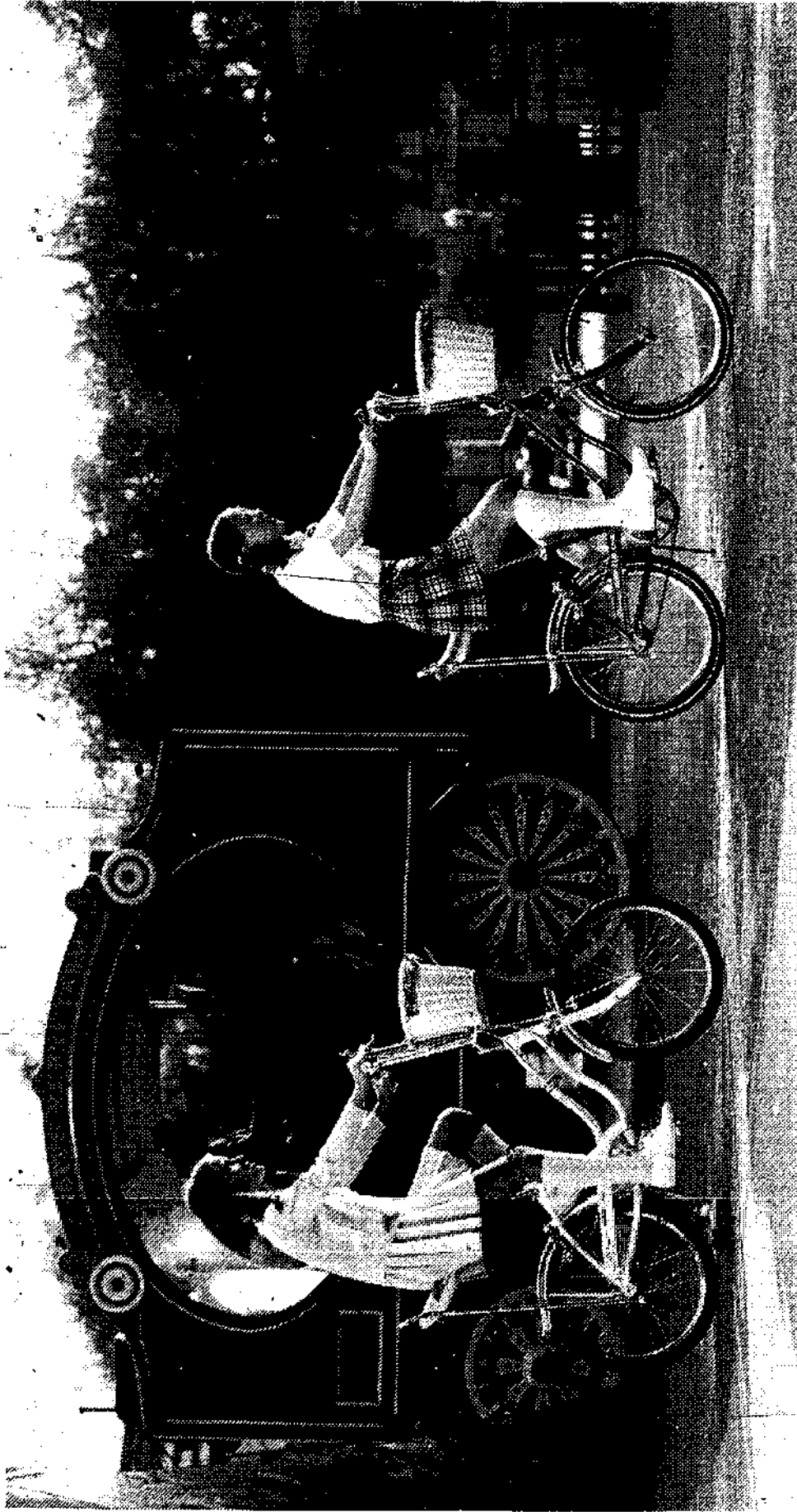

Fig. 10-2. Girls riding high-rise bicycles

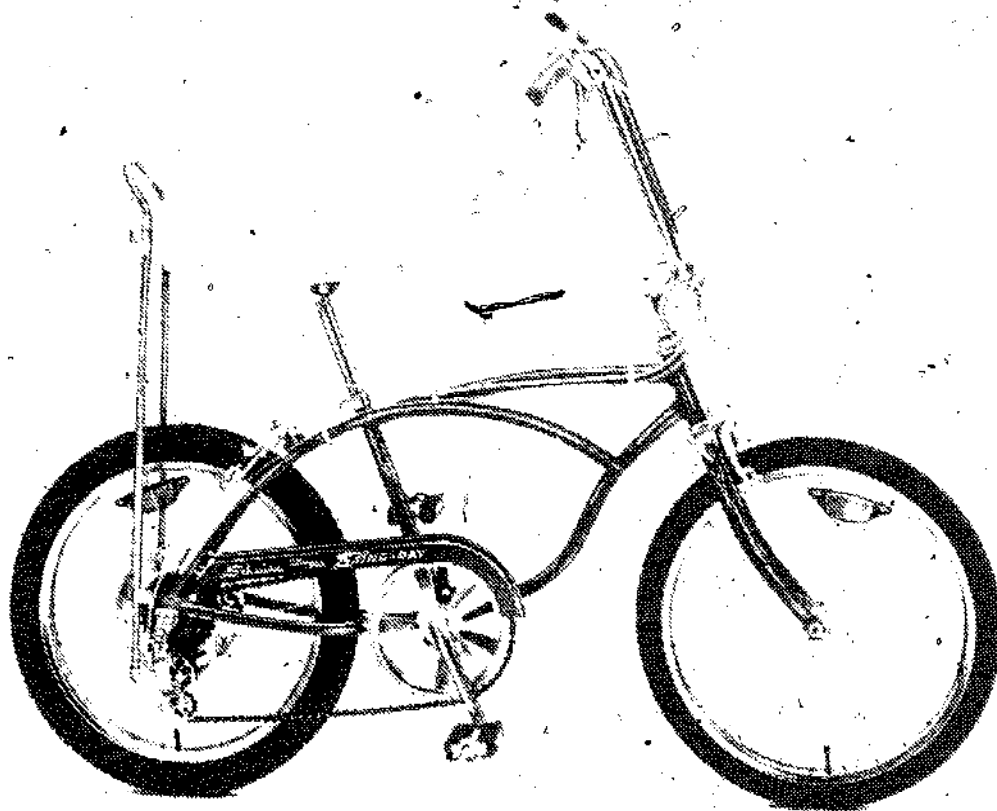

Fig. 10-3 Schwinn Sting-Ray with 5-speed derailleurs gears.

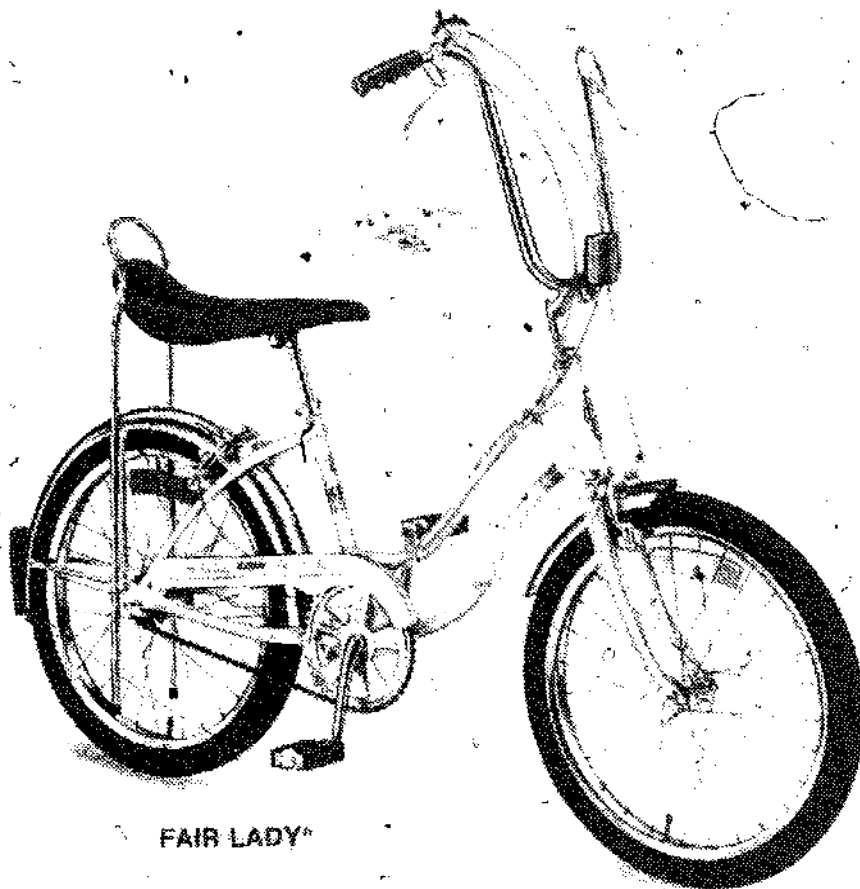

Fig. 10-4. Schwinn Fair Lady 3-speed model

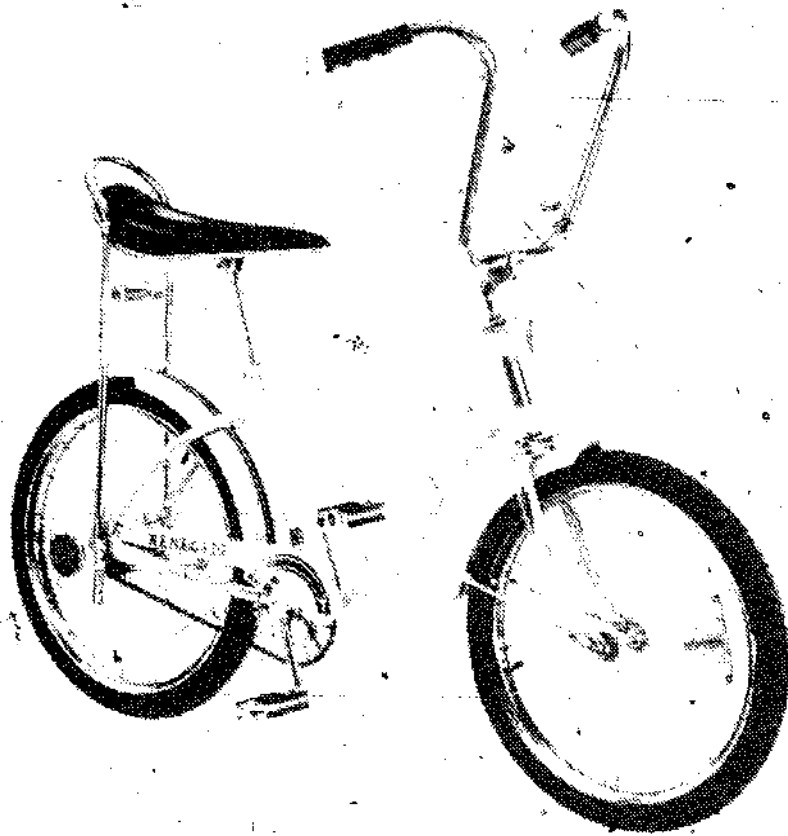

Fig 10-5 AMF Renegade high-rise bicycle.

nipple in the rim hole. Remember that all spokes from the upper hub flange go to holes in the upper half of the rim. Those on the lower flange go to holes in the lower half of the rim.

When all spokes have been installed on the wheel, finger tighten all spokes. A good procedure is to go around the entire wheel and tighten each spoke a quarter turn. Continue going around the wheel to loosen a spoke, readjust the position of the bend and then retighten it.

Mount the laced wheel temporarily back on the bicycle without installing the rim liner, tire or tube for truing. Using a spoke wrench, give the spokes a final tightening. Make adjustments necessary to remove any side-to-side wobble.

If any spoke ends extend past the nipples on the rim side, cut them off and file them down until they are flush with the nipples and smooth.

The first off-centered wheel can be used for a model for lacing the second one.

When both off-centered wheels have been laced and the spokes adjusted, remove them from the bicycle frame and install rim liners, inner tubes and tires. Inflate tires and reassemble bicycle. The bicycle is now ready to use.

Fig. 10-6. Ross 20-inch wheel Bar-  
racuda 3-speed.

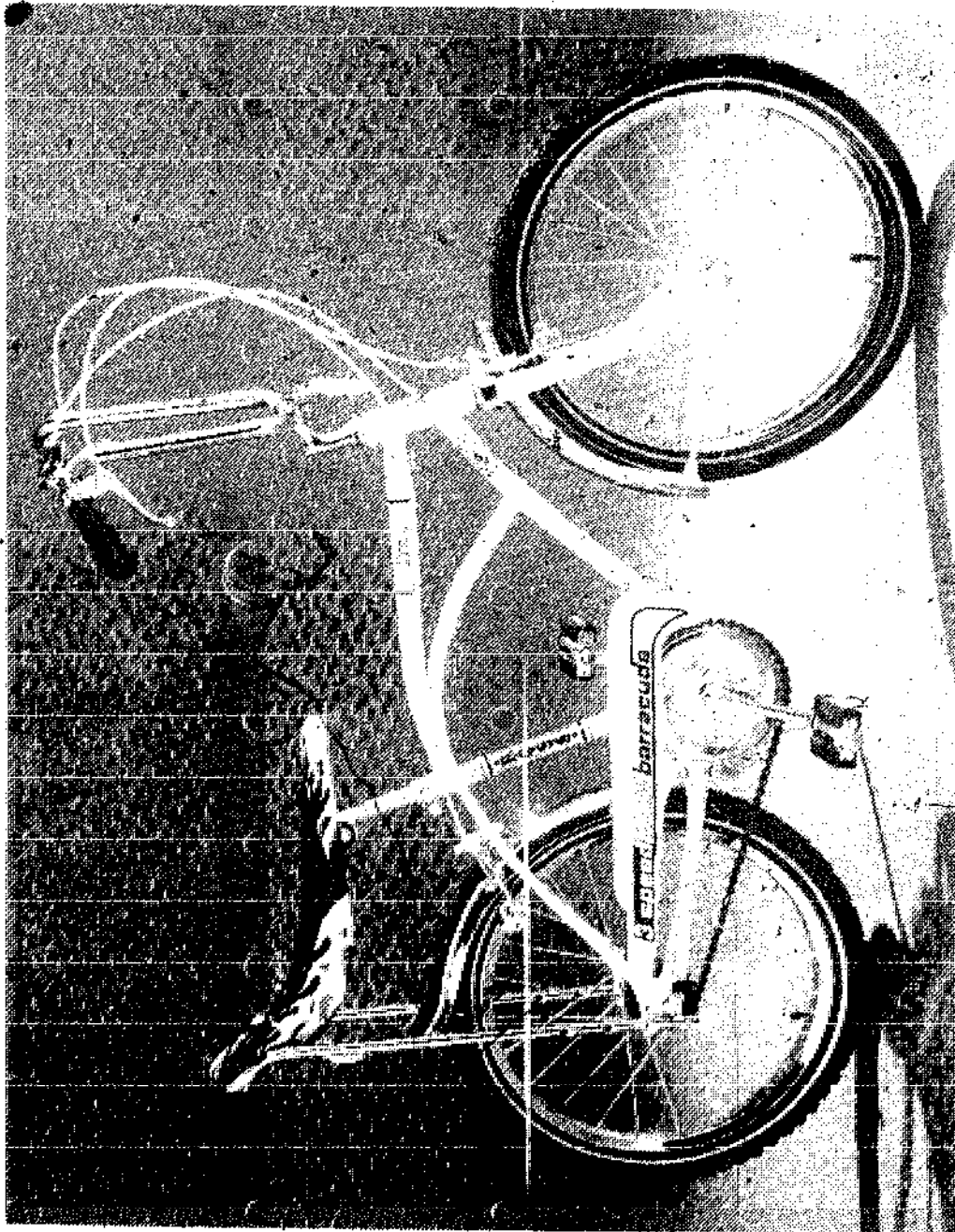



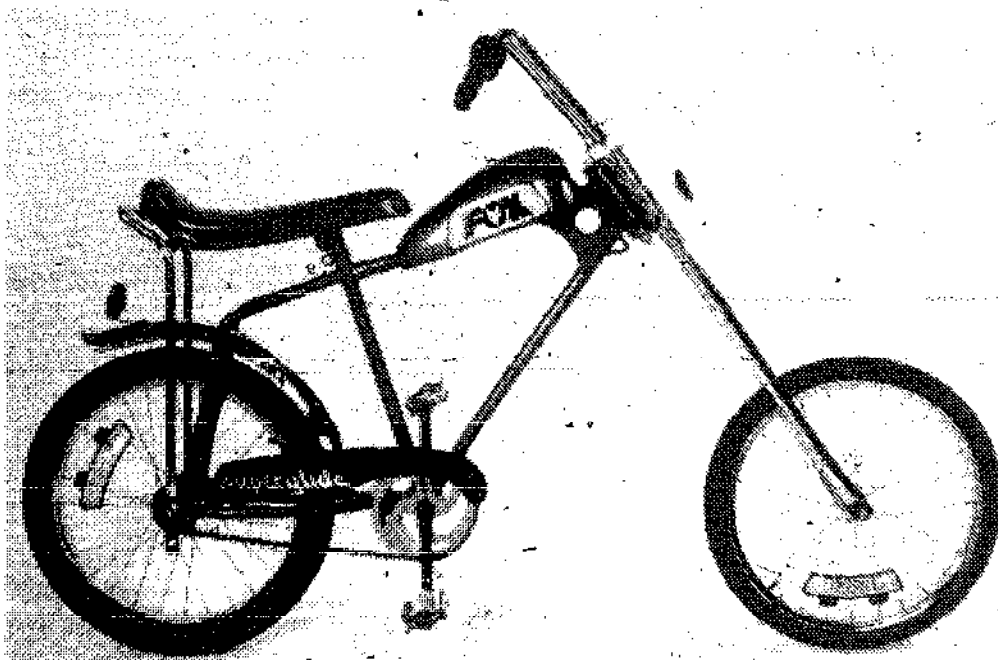

Fig. 10-7. Fox Superglide high-rise bicycle with long fork blades.

### TIPS ON USING BRONCO BIKES

With the wheels out of synchronization—one at high point and the other at low point—the bicycle will give an ocean-wave effect. You can also start with both wheels at the high point. This will give an up and down action without the rocking back and forth. The up and down action can be continued without pedaling by shifting your weight up and down as you ride. Or you can simply pedal along in the usual manner. The hard part is getting over the hump.

If you start with the wheel synchronized, they might become unsynchronized after riding a short distance. The two wheels will probably not be exactly the same circumference but this gives a good effect. All combinations of up and down and tipping backwards and forwards are used. This makes the cycle fun to ride.

Since the bronco bicycle is easy to ride, it provides fun for most everyone. It also makes a good novelty cycle for riding in parades—especially if a clown costume is worn. The cycle can also be decorated with cardboard or plastic wheel discs that are available at bicycle shops. Or you can use crepe paper in the wheel spokes to give a spiral design that goes up and down.

### HIGH-RISE AND PIVOT BICYCLES

High-rise bikes, with banana saddles and high handlebars, have been established as a popular fun cycle for youngsters. A variation of this with a pivot, called the *Swing Bike* is growing in popularity.

Figure 10-1 through Fig. 10-7 show a number of models and makes of high-rise bicycles. The common denominator is the banana saddle and high handlebars.

These bicycles have often been criticized by adult bicyclists as being inefficient because the rider is in an upright position and as being unsafe because the rider's weight is too far back. But the fact is, kids love these bikes. Most of the bikes are rugged and can take hard riding. A popular stunt on these bicycles is to do wheelies. The object is to ride only on the back wheel for as long as possible. Many youngsters can manage a block or more.

The care, maintenance and repair of these bicycles is essentially the same as for regular bicycles. The saddle, in addition to a regular seat post, has two braces that extend down to the rear of the bicycle frame. To make adjustments, loosen both back-stay clamps and both the seat post and saddle clamps. The saddle can now be pushed up or down. The tilt can also be changed. Retighten the clamps when you have the desired position.

Some saddles, instead of back-stay clamps, have bolts that pass through the stays. If so, adjustments are made the same as above except that you remove the bolts and then reposition them into the holes closest to the desired saddle position.



Fig. 10-8. The Swing Bike.



Fig 10-9. Riding the Swing Bike with one wheel on the curb (Courtesy William M. Jenack)



Fig 10-10. Riding the Swing Bike with wheels on opposite sides of an obstacle

## THE SWING BIKE

The Swing Bike, shown in Fig. 10-8 is made by the *Swing Bike Co.*, 412 West 10th N. Logan, UT 84321, and distributed by a network of dealers across the country. The main feature is the pivot point just below the main saddle post. This allows fantastic maneuverability, as the front part of the bike can go one way, the rear another.

It's possible to ride along with the front wheel on a curb and the rear wheel off as shown in Fig. 10-9. Or the front part of the bike can go on one side of an obstacle while the back part goes on the other side as in Fig. 10-10.

The *Swing Bike* can be used for many types of contests such as best time through an obstacle course or follow the leader. These cycles are also ideal for riding in parades.

## Tricycles and Sidewalk Bikes

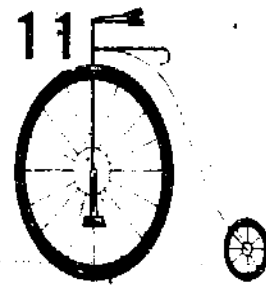

Many styles and sizes of tricycles are on the market. They can be roughly categorized into those made of traditional metal construction and the plastic variety. Both types can be satisfactory. However, the metal ones are generally easier to repair if they are damaged, worn or broken. Repairs on the plastic models are often impractical—if they can be made at all.

Several types and styles of tricycles, including one with a wagon trailer, are shown in Figs. 11-1 through Fig. 11-4. It's important that the child be able to comfortably reach the pedals when the saddle is in the lowest position. It is generally most economical to purchase the largest size that meets this condition so that the cycle will have the maximum adjustment possibilities as the child grows.

### MAINTENANCE AND REPAIR

Most tricycles require very little care. In general, try to keep them out of wet weather. Apply light bicycle oil to the rear wheels and any bearings. However, tricycles usually don't have bearings. Keep all fastenings tight.

Wheels and pedals are often held to axles and spindles by caps. Sometimes these caps have to be removed. Pry them off. It's best to use new caps for replacements. They are inexpensive. Figure 11-5 shows a cap being installed to hold a pedal in place.

The bearings are usually crimped in place in the bearing holders. The bearings sometimes require replacement. To install,

remove the pedal caps, pedal washers and pedals. Unbolt pedal holders from the fork. Bearings can then be slid off over cranks. Carefully unbend tabs that hold bearings in place. Remove old bearings. New bearings must fit holders. Crimp tabs to hold bearings in holders. Reassemble.

Tricycles generally have solid or semi-pneumatic tires that are stretched over the rim. Old, worn or broken tires can be cut off. To install a new one, first soak the tire in hot water. Apply soap to it and then stretch it in place with tire irons.

### TRICYCLES FOR ADULTS

Tricycles built for adults are ideal for people who cannot—or for one reason or another do not think they should—ride a regular bicycle. These tricycles are extremely popular with senior citizens—especially in areas where automobiles are not permitted.

### MANUFACTURED TRICYCLES

These vary in weight from around 90 pounds to lightweight models around 35 pounds. Most are somewhere between these extremes. The *Schwinn Town and Country tri-cheeler* shown in Fig. 11-6, weighs 64 to 65 pounds, depending on equipment. This

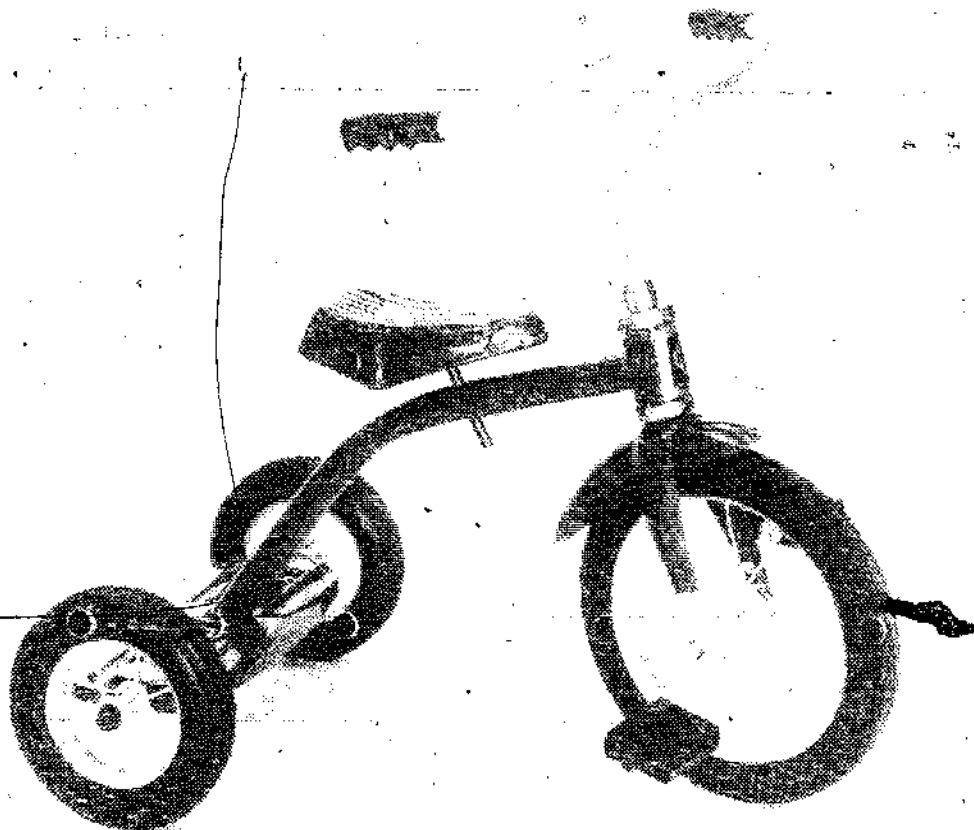

Fig. 11-1. This standard tricycle is constructed of rugged 14 gauge steel tubing.

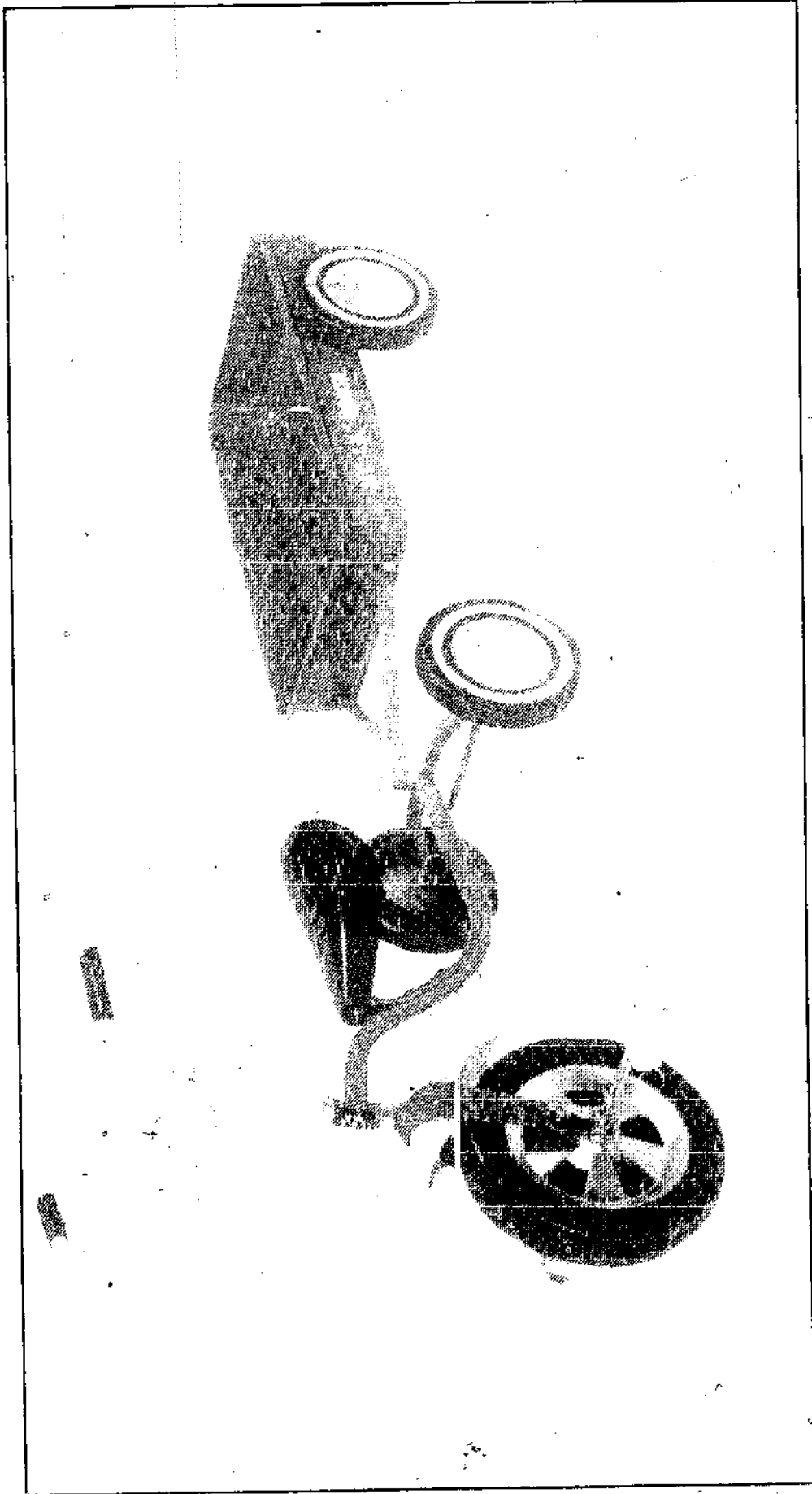

Fig. 11-2. A Garton trike and wagon combination

model is a three-speed, but they also offer a similar one that's a single-speed. Both models have differential-drive transmissions and 24-inch wheels. The carrier basket makes the trike practical for shopping. The basket is removable. The brakes are coaster type rear and caliper side-pull with locking park feature on the front wheel.

Fig. 11-7 shows an *AMF Courier* three-speed adult trike. The dual drive differential (Fig. 11-8) provides equal power to rear wheels in both drive and braking modes. The trike has rear coaster brakes and front caliper. The tires are 24 × 1.75 inch. *AMF* also offers a model with the same features except that it is single-speed.

A *Gobby* adult three-wheeler, made by *Gobby MFG Inc., P.O. Box 274, Glendale, AZ 85301*, is shown in Fig. 11-9. Their dual-drive unit with three-speed hub is shown in Fig. 11-10. The *Gobby Co.* makes a variety of adult tricycles with 20, 24, 26, and 30-inch wheels. Their 20-inch wheel *Mustang* has a frame that can be taken apart for easier transporting.



Fig. 11-3 This Garton motocross-style trike has knobby tires and competition number plate



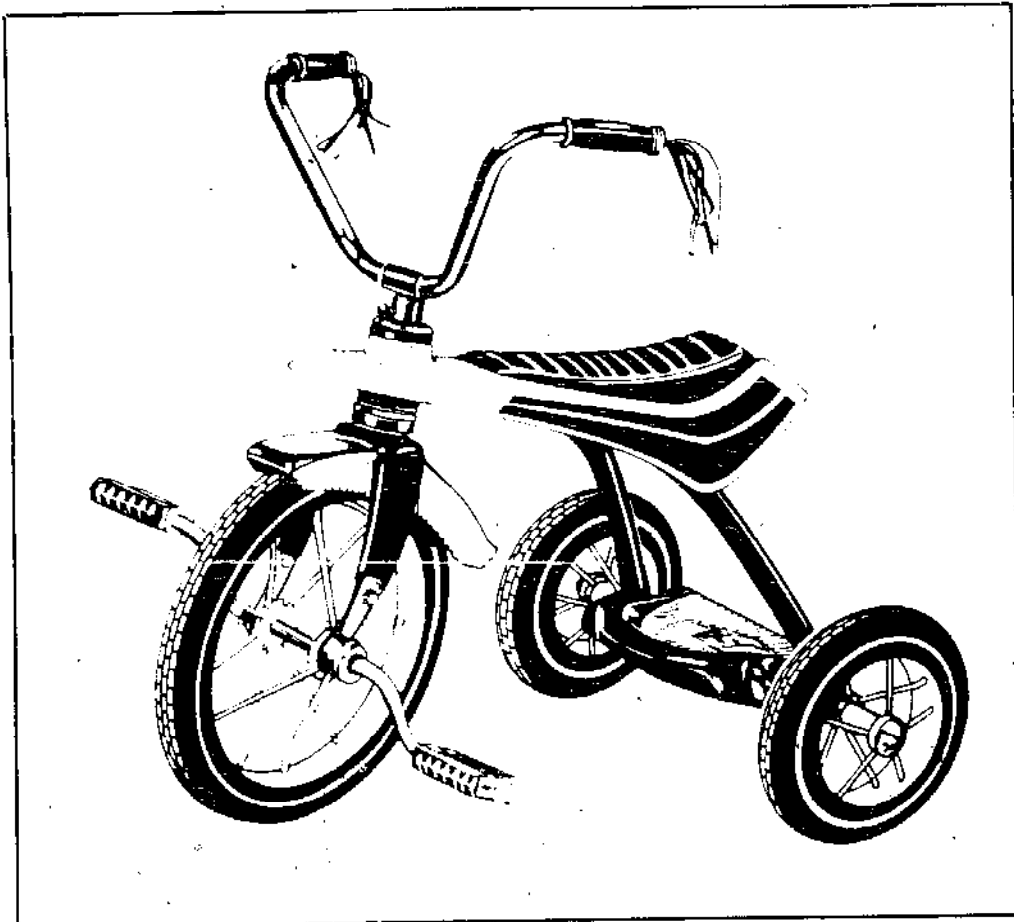

Fig 11-4. A tricycle with extra long motor bike style saddle

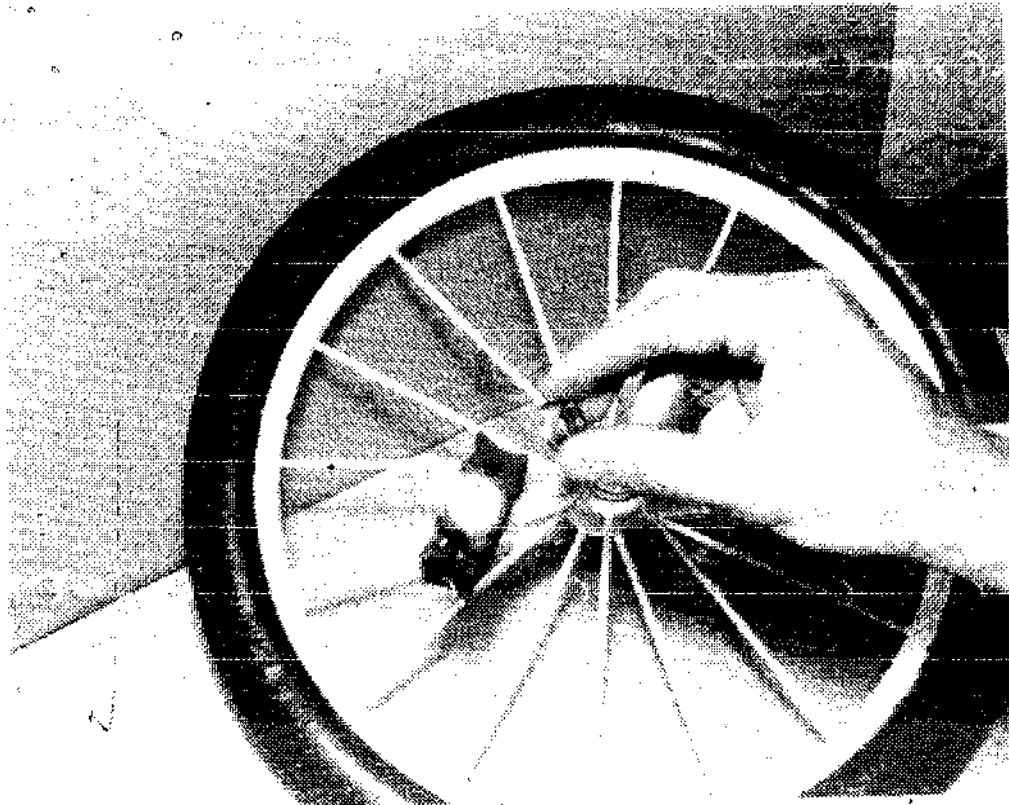

Fig 11-5. A pedal cap is used to hold the pedal in place.

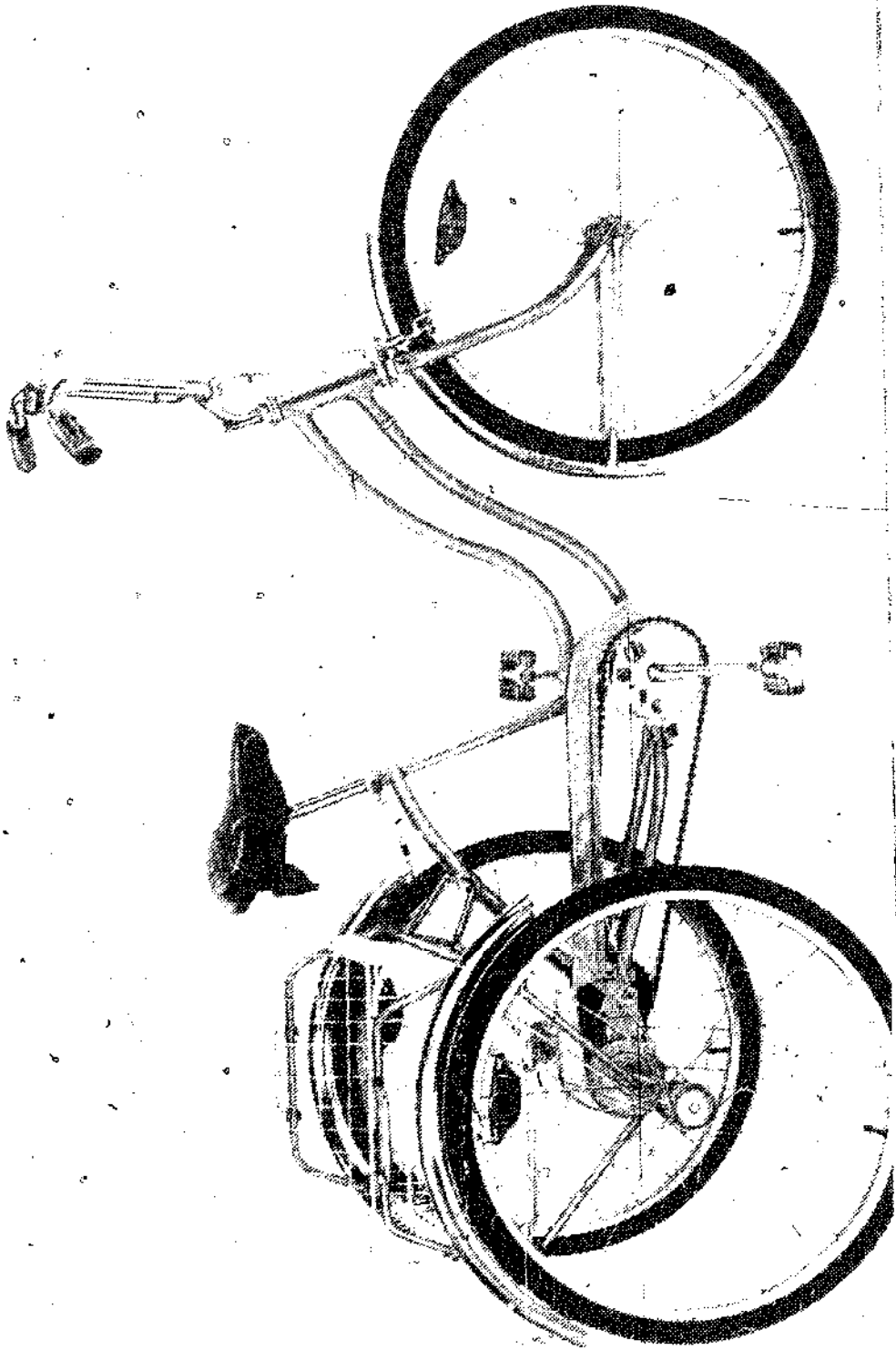

Fig. 11-6. Schwinn Town and Country adult tri-wheeler

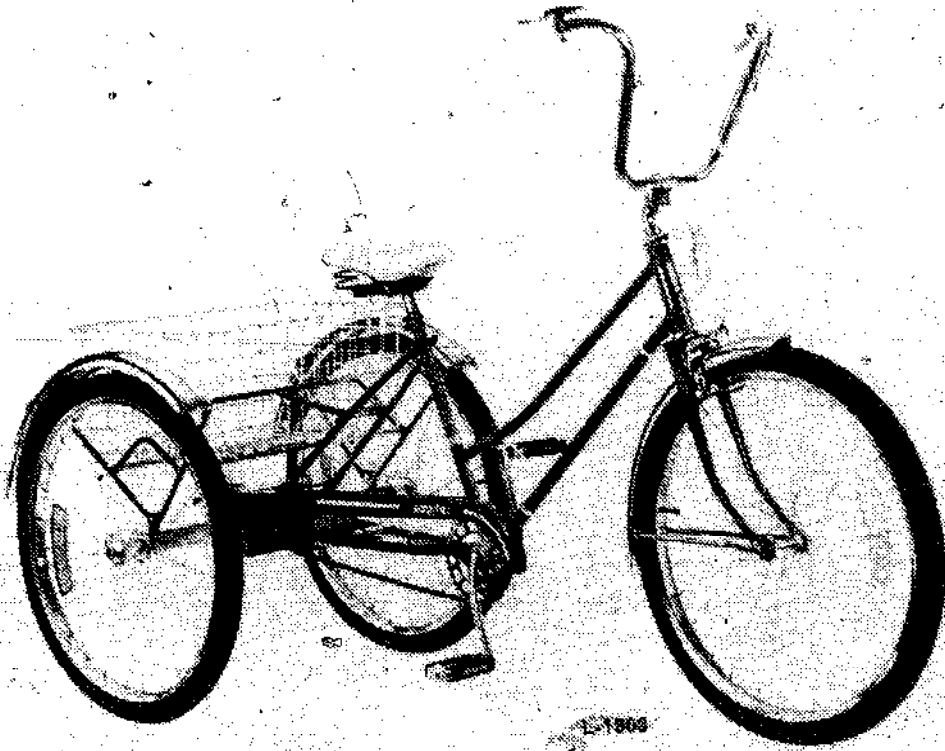

Fig. 11-7. A three-speed adult tricycle.

Fig. 11-11 shows the *Matthews Idlewild* three-wheeler. It's made by *LRV Industries*, 2536 N. Shaman Ave, S. El Monte, CA 91733. It features a unitized frame. The one-piece heliarc-welded unit results in a stable, perfectly straight frame.

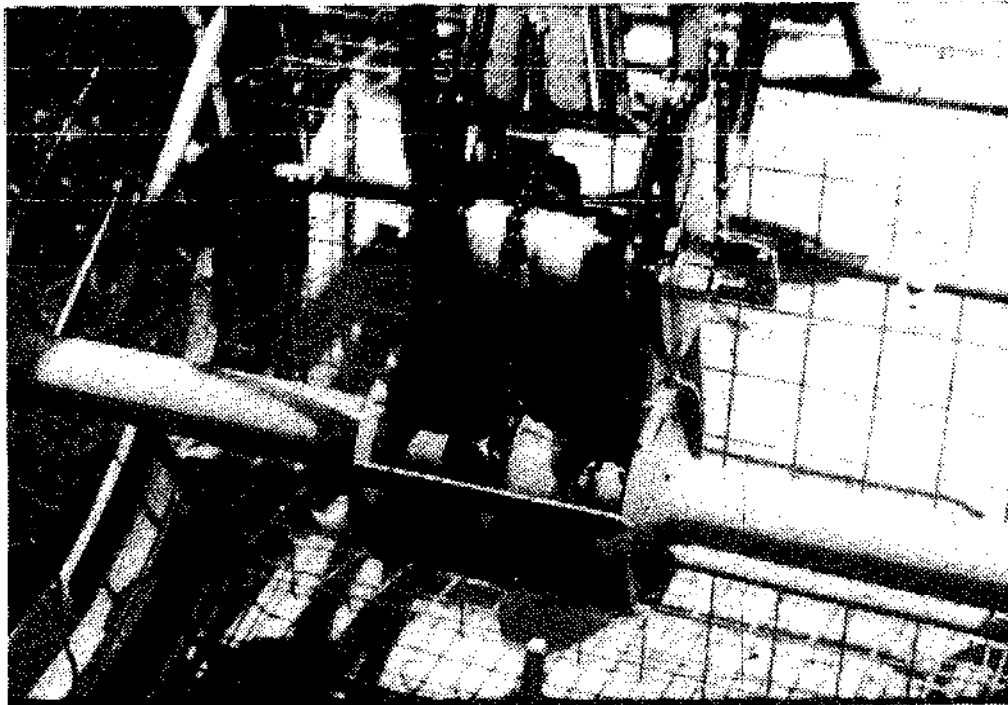
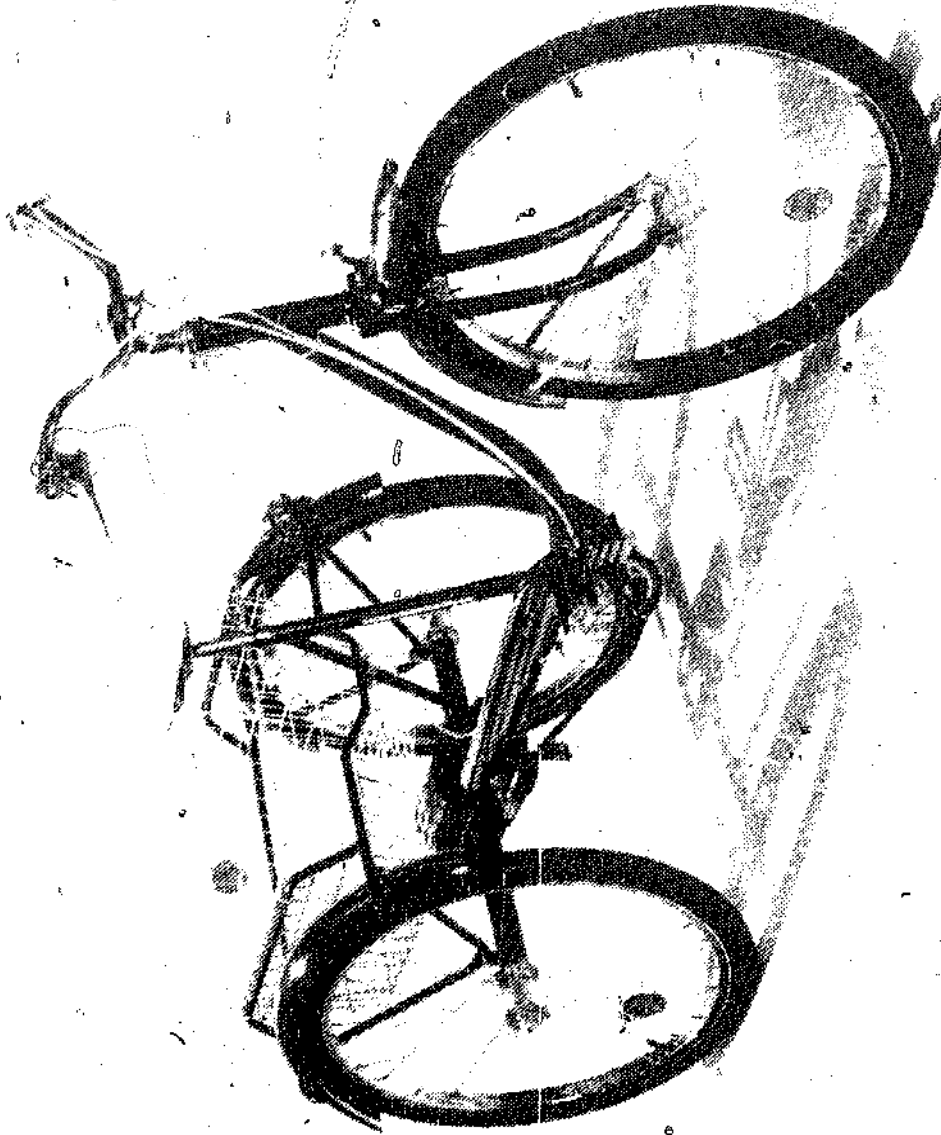

Fig 11-8. AMF dual-drive differential provides equal power to rear wheels in both drive and braking modes.

Fig 11-9 A Gobby adult three-wheeler



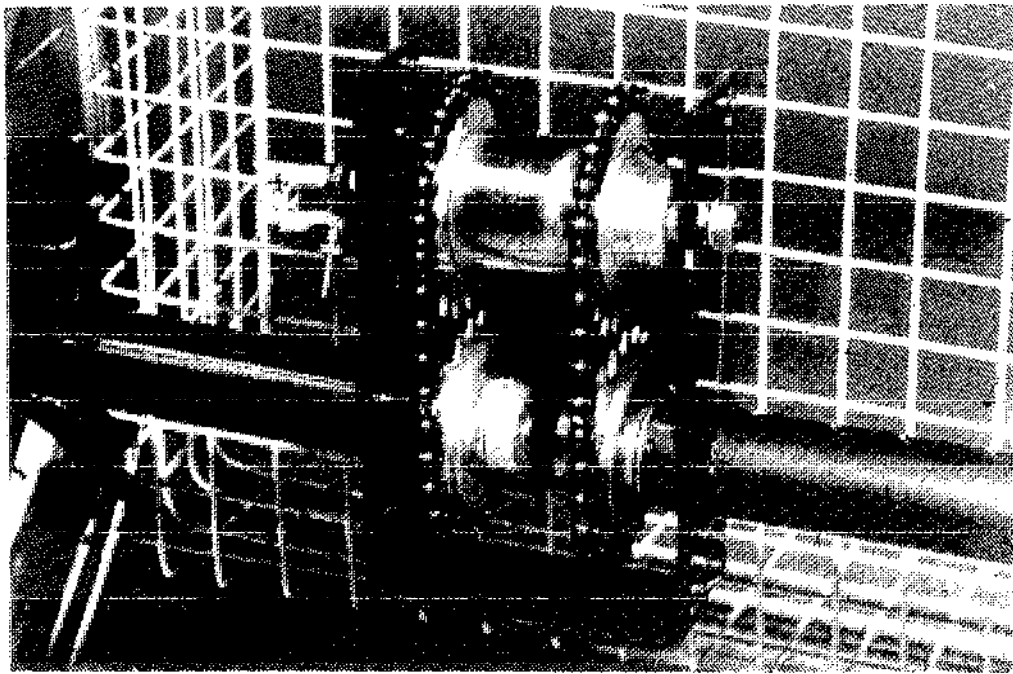

Fig. 11-10. Gobby dual-drive unit with three-speed hub.

The *Bridgestone Kabuki Picnic Wagon*, designed for shopping and fun, is shown in Fig. 11-12. The trike has 16-inch rear wheels and a 20-inch front wheel.

### INDUSTRIAL TRICYCLES

Tricycles are also being used as work vehicles in places such as warehouses, factories and airports. It's a practical, functional, low-cost way of moving equipment and products over short distances—especially inside building.

Two different models of *The Mover*, manufactured by *Industrial Cycles*, 3120 Wilmington Pike, Dayton, OH 45429, are shown in Fig. 11-13 and Fig. 11-14. These are constructed for heavy-duty industrial use, with heavy gauge unit welded frames, high capacity wheels and sturdy rear platforms for carrying fairly heavy loads.

### CONVERSION UNITS

A number of units that attach to regular bicycles and convert them into tricycles are on the market.

*Higgins* of England makes a unit for converting a 10-speed bicycle into a 10-speed tricycle. The conversion unit is available from *W.F. Holdsworth Ltd.*, Lower Richmond Road, Putney, S.W. 15, England. The unit is bolted to the bicycle, making switching back and forth between tricycle and bicycle practical. The unit can also be used with a ten-speed tandem bicycle to form a ten-speed tandem tricycle.

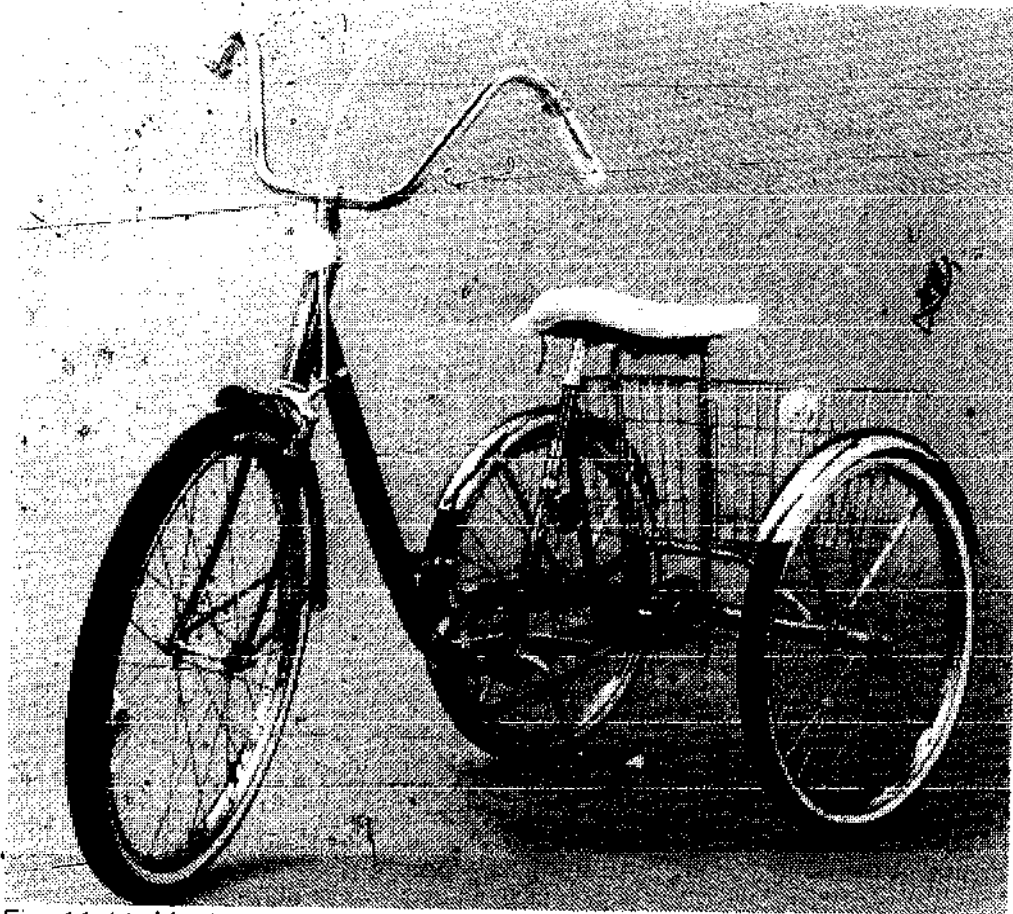

Fig. 11-11. Matthews Idlewild three-wheeler.

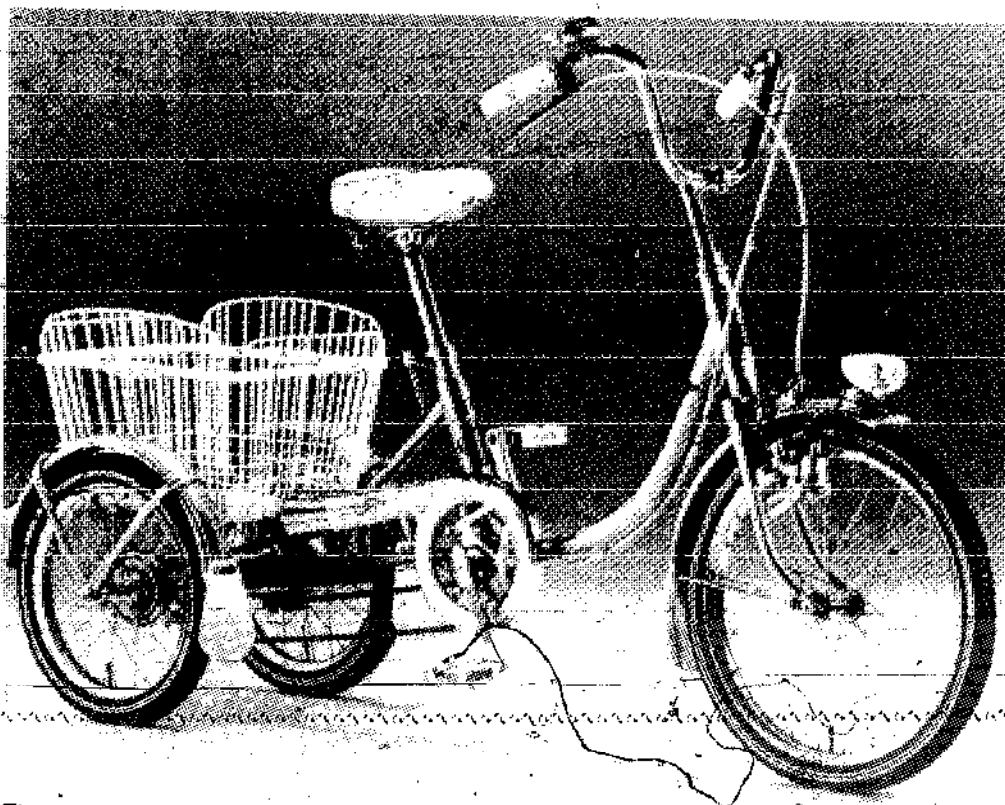
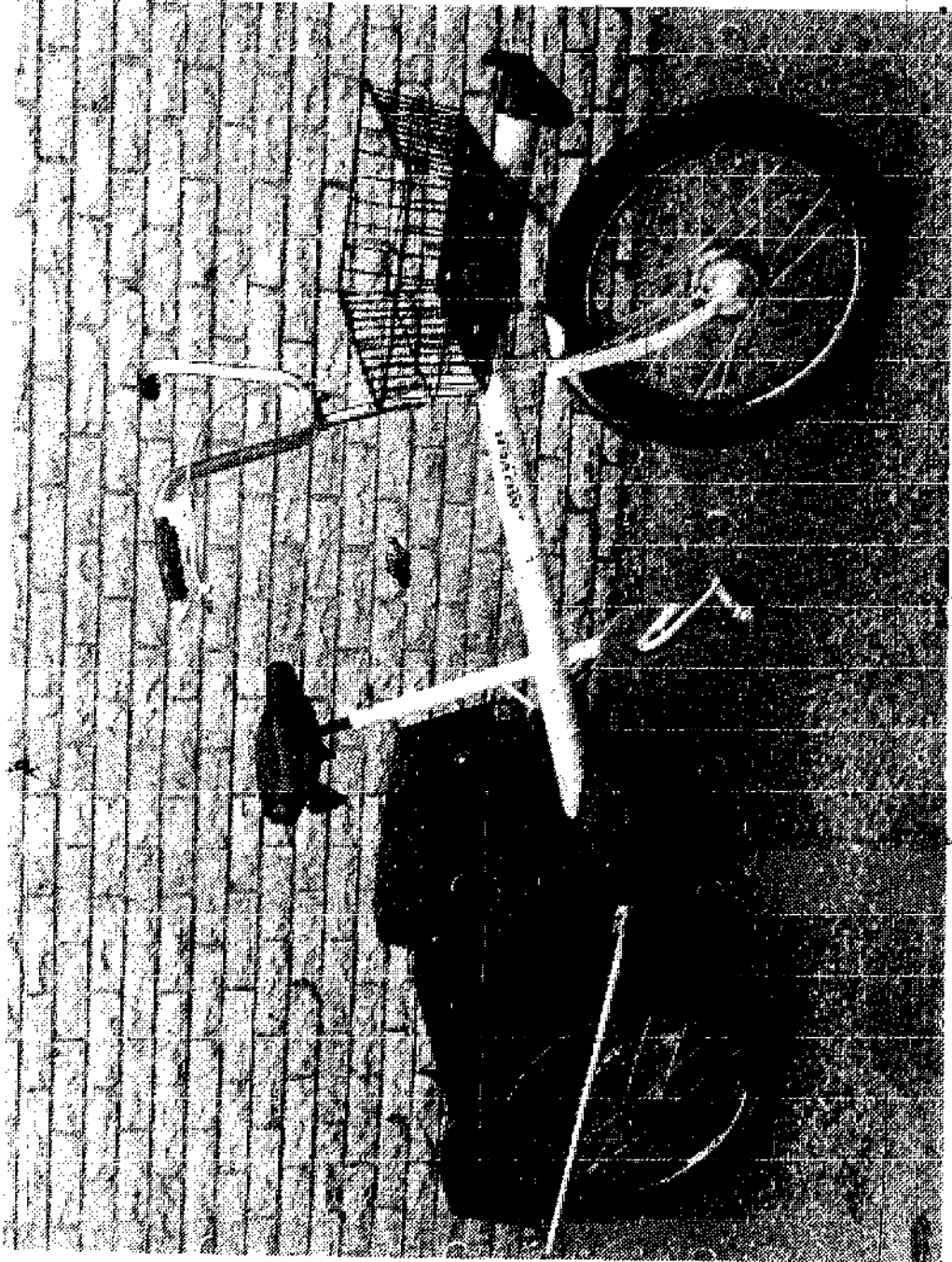

Fig. 11-12. Bridgestone Kabuki Picnica Wagon. It's designed for fun and shopping.

Fig 11-13 The Mover industrial tricycle is designed for heavy industrial use



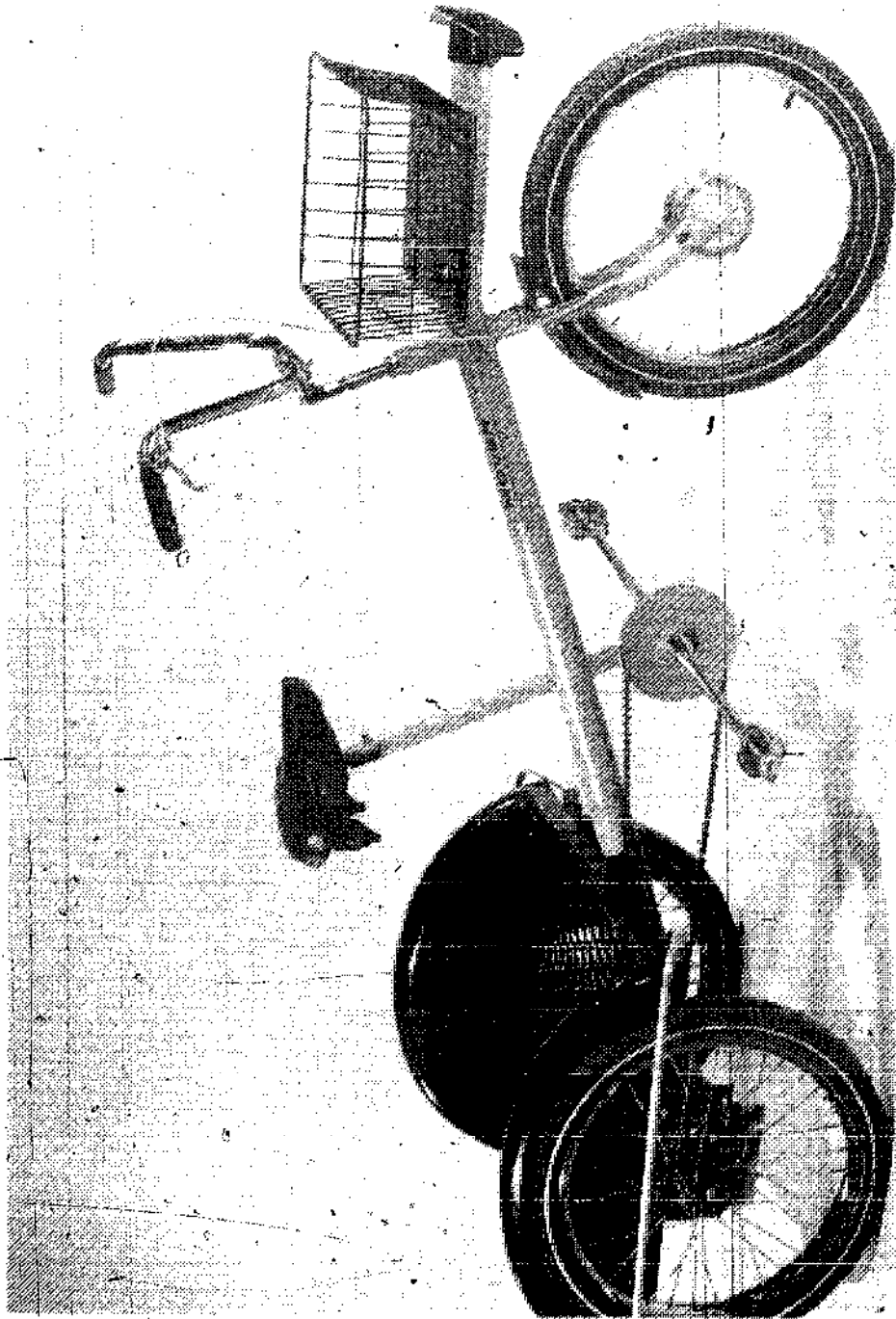

Fig 11-14. The Mover features a sturdy rear platform



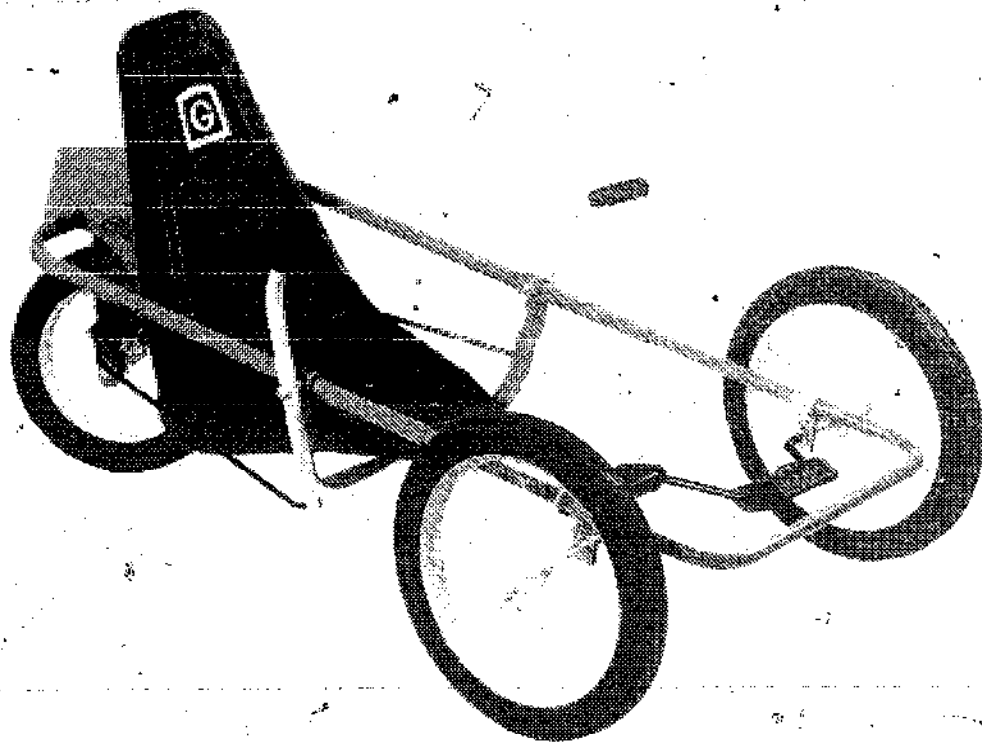

Fig. 11-15 Gartoncycle—a three-wheeled pedal car with low profile.

### **CARE, REPAIR AND MAINTENANCE**

This is generally the same as for a regular bicycle except for the drive unit and rear wheels assembly. These require special lubrication and repair procedures. Follow the manufacturer's instructions in this regard for the particular unit.

### **TIPS ON USING A TRICYCLE**

Perhaps it might be surprising, but experienced bicycle riders often have a great deal of difficulty getting used to an adult tricycle. On the first attempts, I suggest using a large open area and slow speed.

Turning will take some getting used to. Steering requires turning the handlebars instead of leaning. You should sit up straight. Turning should be done at slow speeds.

### **PEDAL CARS**

Pedals cars such as one shown in Fig. 11-15 are popular toys. Like tricycles, they are generally pre-bicycle age toys. Maintenance and repair is similar to that of a tricycle.

### **SIDEWALK BIKES**

Figure 11-16 through Fig. 11-19 show a number of sizes and types of sidewalk bicycles. Consider the size of the child when you

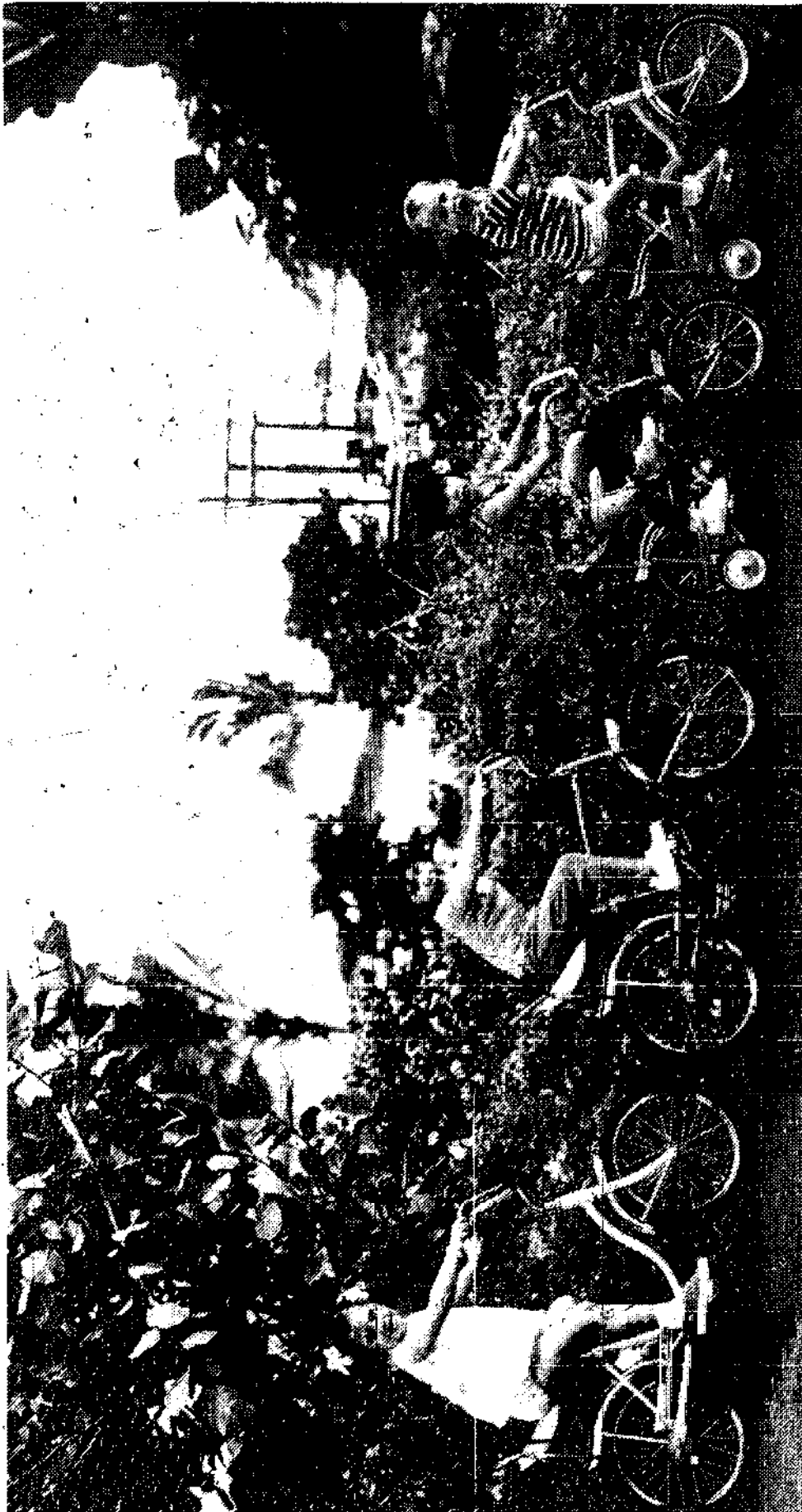

Fig 11-16 A parade of sidewalk bicycles.

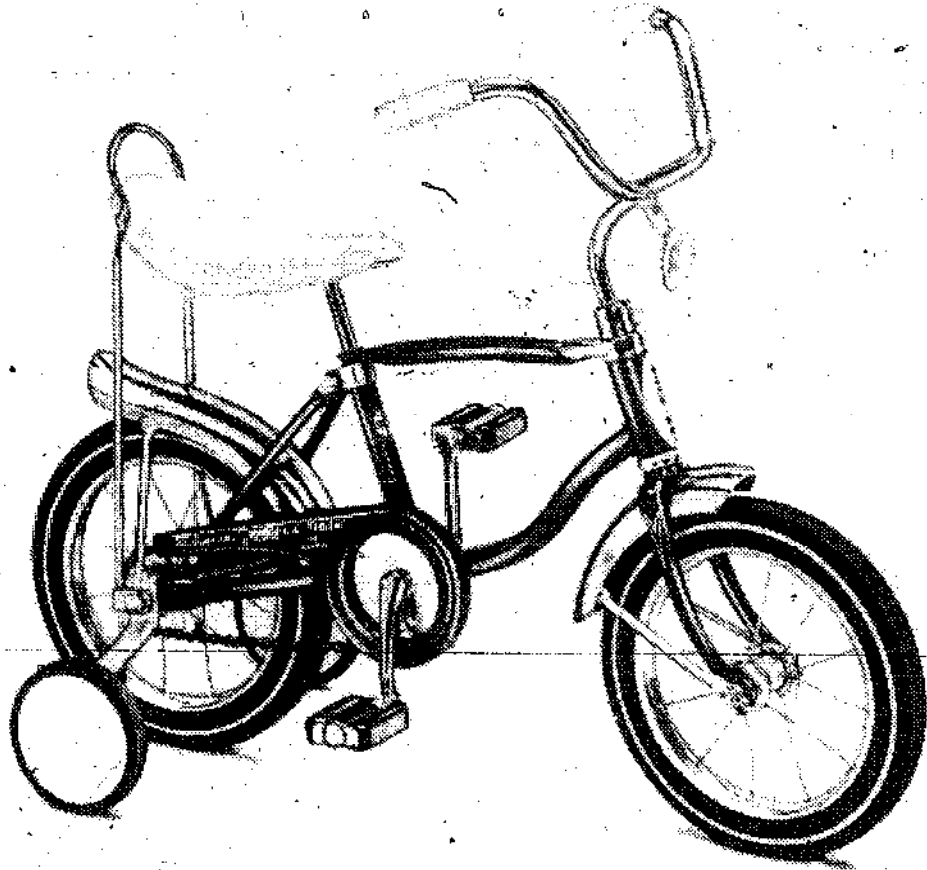

Fig. 11-17. The Schwinn Lil' Tiger has a banana saddle.

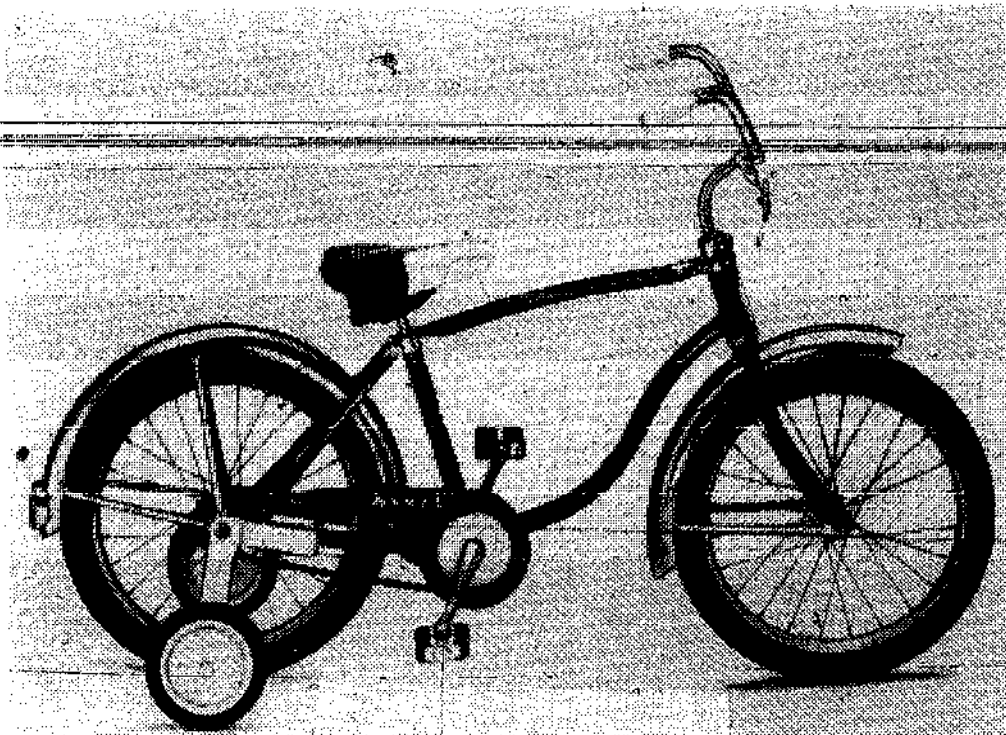

Fig. 11-18. Schwinn Convertible Pixie has a removable top bar for easy conversion from a boy's to a girl's model.

select a bike. The child should be able to comfortably reach both pedals and the ground with his or her feet while sitting on saddle. Avoid using pedal blocks to fit a child to a bike that is otherwise too big unless the cycle will be used *only* with training wheels until the child grows enough to reach pedals without blocks.

Training wheels are controversial. Some people think they aid learning while other people believe that they hinder learning. The training wheels are generally easy to remove. Even very young children can usually learn to ride a two-wheeler without the training wheels if they have a bicycle that's small enough to allow them to walk their feet along the sidewalk when they are mounted on the saddle.

The quality of construction of sidewalk bicycles varies greatly. Some are built on the order of tricycles while others are like regular bicycles reduced in size. Most are some combination of the two extremes.

Since the quality scale basically follows the price scale, it is most economical to select the lowest priced model that will last until the child outgrows it. Determining this point, however, can be difficult. You could go with higher quality and hope to be able to sell it when the child is ready for a bigger bike.

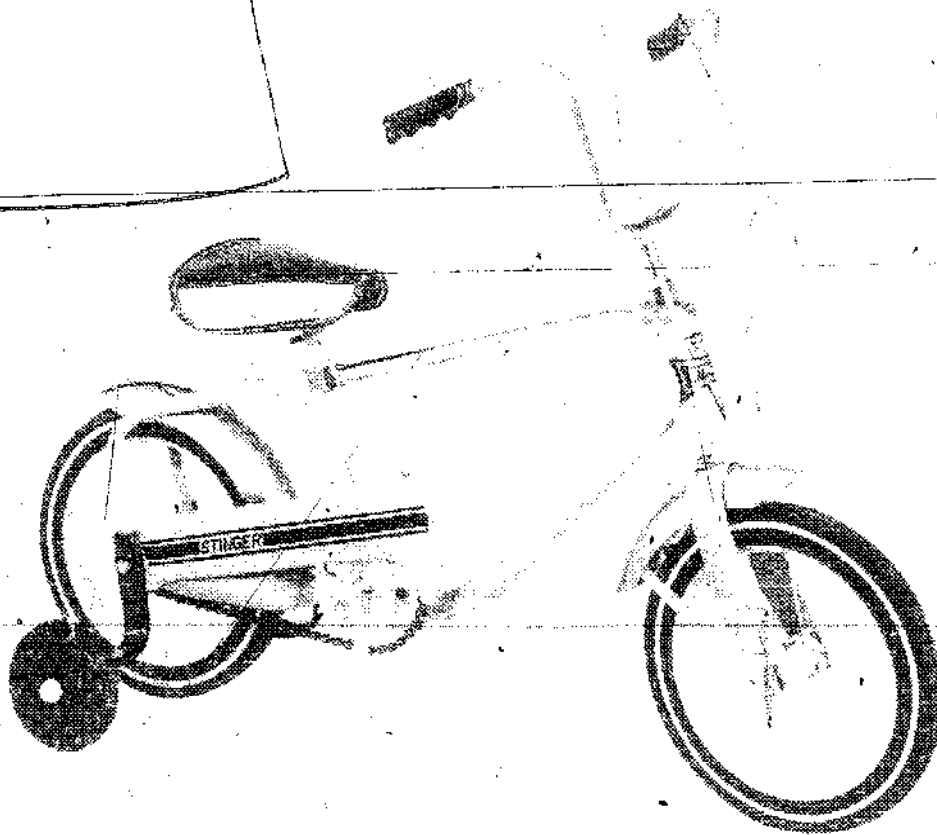

Fig. 11-19. Garton 16-inch wheel convertible chain-drive bike.

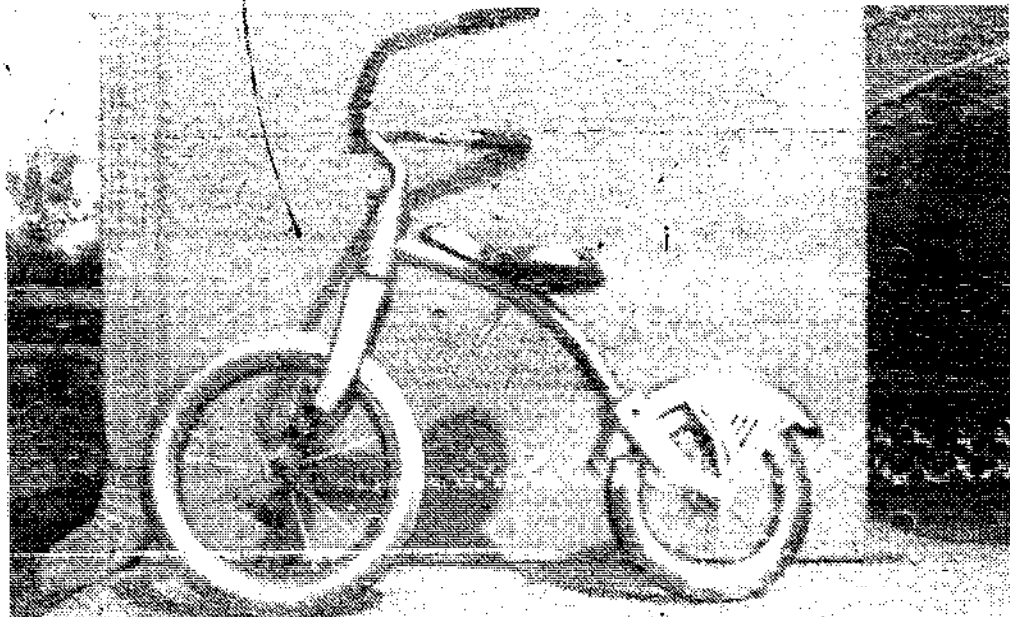

Fig. 11-20. A tricycle converted to two-wheeler.

Depending on the type of construction, the maintenance and repair will either be similar to that of a tricycle or like that of a bicycle.

#### **CONVERSION OF A TRICYCLE TO A TWO-WHEELER**

When a child is at that awkward, in-between age—to big for a tricycle and not quite ready for a regular bicycle—conversion of a tricycle into a two-wheeler could be the answer. It's also a good way to prolong the use a child can get out of a tricycle. A conversion is



Fig. 11-21. Riding a decorated trike-bike

shown in Fig. 11-20 and another one with a child riding is shown in Fig. 11-21.

To make the conversion, cut off the back section from the tricycle. Then add a fork from another tricycle and secure the fork head inside the tricycle tubing with two bolts. If you prefer, have it brazed in place. Use one of the original rear wheels and attach it with a suitable bolt, spacers, washer and nut. The mudguard shown on the cycle in Fig. 18-12 was installed to give the cycle a perky look.

The cycle is actually a pint-sized version of a penny farthing. With the front wheel decorated, as shown in Fig. 18-13, the cycle is ideal for riding in a parade.

By the time many children reach about four years of age, they are ready for something more challenging than a tricycle. This easy-to-build conversion will give them that challenge. At the same time they will be learning to handle a two-wheeler.

## Penny Farthings

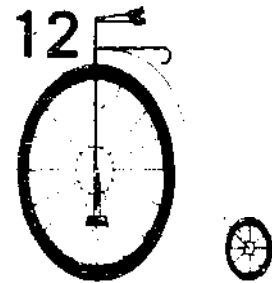

Penny farthings or *high-wheelers* became popular in the 1870s and 1880s, then gradually went out of style when the *safety* bicycle came into being. It is easy to see why this happened. The penny farthing was more dangerous, spills were rather common and the riding was less efficient. In fact, the term *safety* seems to have been applied to the newer design because they offered greater safety.

Penny farthings have the cranks connected directly to an axle that is in turn connected to the hub. There is no freewheeling. Braking is ordinarily accomplished by slowing the pedal action. A hand-operated brake to the rear wheel can partially solve the braking danger. However, this apparently was not used on the early models. Braking too rapidly by slowing or stopping the pedal action often caused the rear wheel to raise off the ground, sending the rider for a spill forward. An added problem was that the rider had to somehow get his legs around the handlebars for any hope of a feet-first landing.

Because the penny farthings were not freewheeling, except when the feet were taken completely off the pedals or the legs completely relaxed on the pedals, they lacked the coasting advantage of freewheeling bicycles. The early *safety* bicycles were not freewheeling either.

So penny farthings are no longer used. Right? Wrong. There are even large clubs of penny farthing enthusiasts. Perhaps it is the nostalgia or the novelty that keeps these bicycles in vogue. What-

Fig. 12-1. The High Step high-wheeler is an exact copy of the 1880s penny-farthing

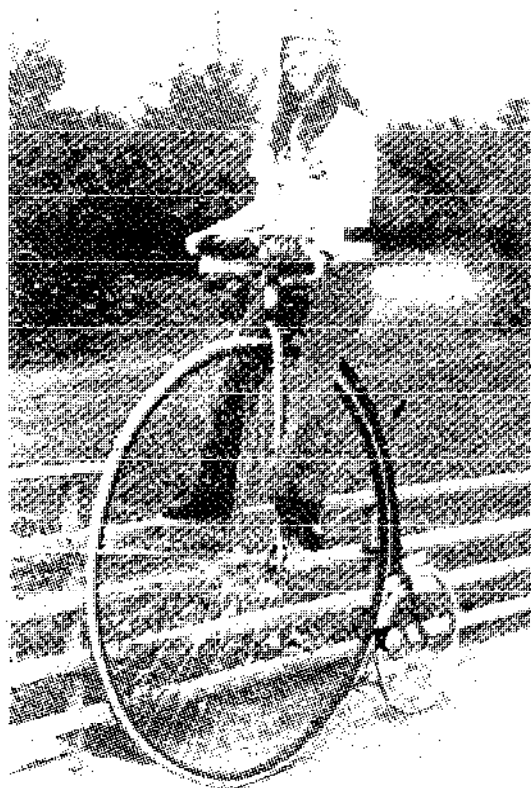

ever the reason, there are a lot of people who own and ride them.

High-wheelers or penny farthings in use today are basically in one of three categories:

- Antiques that have been restored.
- Recently manufactured versions. Many of these are similar to the original early models.
- Home built versions.

### **FINDING ANTIQUE PENNY FARTHING**

At first thought it might seem that buying an antique penny farthing would be the ideal way to go about getting one of these cycles. However, there are two things that usually put a stop to this plan. First, it's difficult to locate old penny farthings that are being offered for sale. Second, they command a premium price, often more than a thousand dollars.

Collectors have rounded up most of these cycles. About the only possibility of getting one cheap is if you happen to run into someone who has one who does not know the true value. I think the chances of this happening are quite slim.

It is interesting to note that at the peak of their popularity, before *the turn* of the century, there were approximately 200 companies making high-wheelers. Today, there are only a few companies who are manufacturing them on a regular basis.



## MODERN MANUFACTURED VERSIONS

In the United States, there are two companies that make replicas of early high-wheelers on a regular basis. The largest of these is the *High Step Bicycle Co., PO Box 847, Milwaukee, WI 53201*. Their most popular model has a 48-inch front wheel and a 20-inch rear wheel. This model is priced at about \$450 plus shipping costs. Fig. 12-1 shows this high-wheeler. They also manufacture replacement spokes for original high-wheelers. These are made of one-eighth inch .125 rustless spoke material, any length, complete with nipples.

The other company that makes penny farthings is *Hi-Rider, PO Box 14366, Columbus, OH 43214*. They offer both kits and completed high-wheelers.

Smaller manufactured versions for youngsters, such as the one shown in Fig. 12-2 have been on the market. But as far as I've been able to determine, none are presently available.

## BUILDING PENNY FARTHINGS

Details for constructing a child's model penny farthing were given in chapter nine. The same concept can be applied with bicycle wheels. For example, everything except the head tube and two parallel bars can be cut from a girl's or woman's bicycle frame. A standard unicycle wheel assembly (see the chapter on unicycles) is attached to the fork. A small fork and wheel are added to the rear of the frame. A short section of seat tube is welded to the frame. Notch the upper end for a seat post clamp. The saddle and post can then be installed. Completed assembly will be like penny farthing shown in Fig. 25-2, except that main frame will be with two parallel bars instead of single tube.

Since versions with large wheels are extremely difficult to construct, details for their assembly are not given here. However, if you have had considerable cycle building experience, you might try purchasing just the big wheel from one of the manufacturers and then constructing your own frame.

## RIDING PENNY FARTHINGS

For safety reasons, the penny farthing should be used only in areas away from automobile traffic. Other than for parades, they are not for street use. The big-wheelers generally have a foot peg on the main frame tube for mounting. With hands on bars, stand behind the penny farthing as shown in Fig. 12-3. Place your right foot on the



Fig. 12-27 A manufactured-version of a penny-farthing for youngsters.

peg. Push the cycle forward scotter fashion with your left foot and pull yourself up. Mount, find pedals and ride. Slow down by slowing pedal action. Dismount by carefully sliding your right foot down to the step. Place your left foot on the ground to slowly stop the high-wheeler. When the cycle is at a complete stop remove your right foot from the foot step.

Care should be taken when you are braking by slowing the pedal action. Otherwise the rear wheel might come off the ground. When coasting downhill, old-time riders reportedly put their legs up over the handlebars with the idea, that in case of a spill forward, there was a possibility of landing feet first. It seems to me, however, that any possibility of slowing the bike would also have been given up.

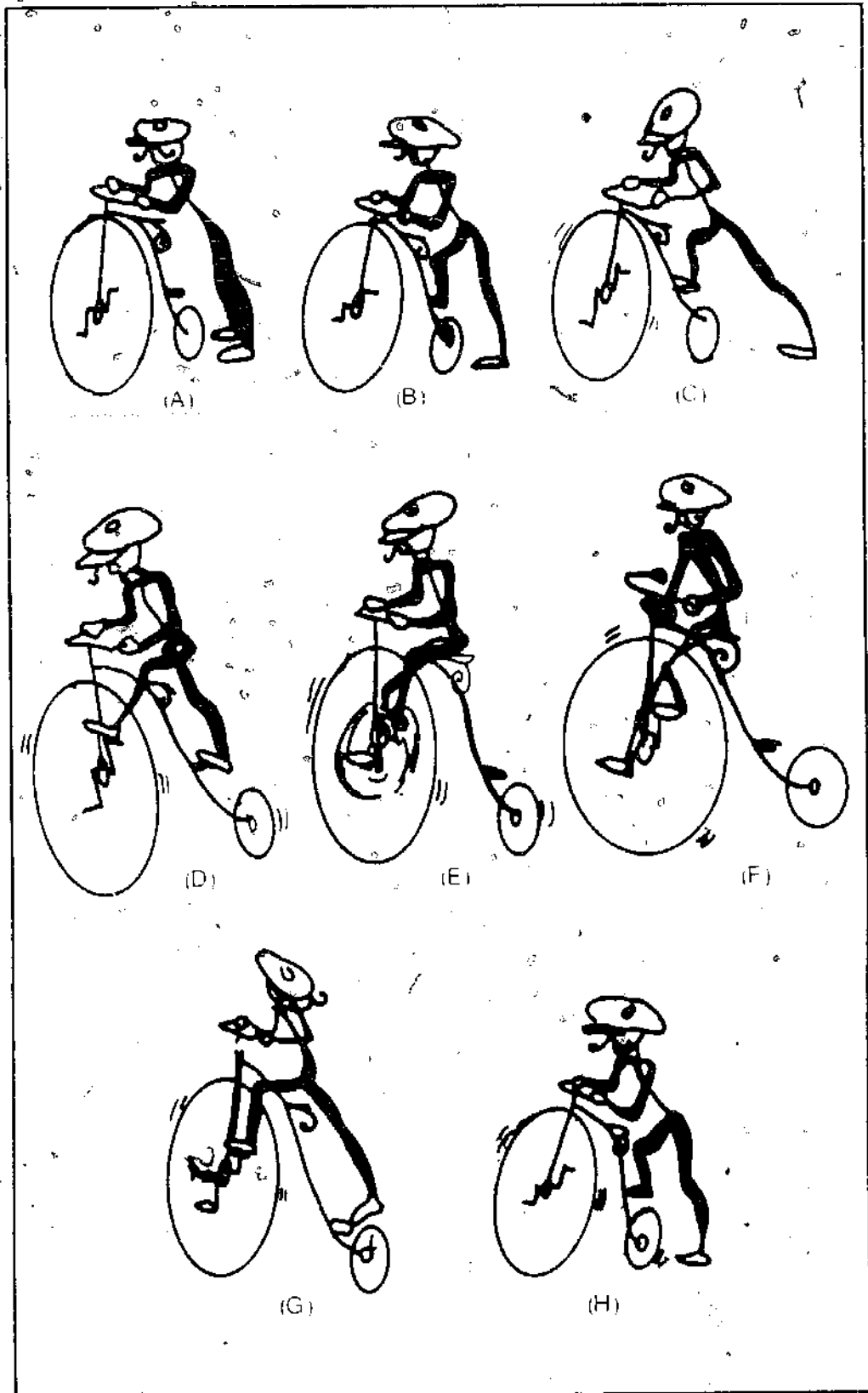

Fig. 12-3. When mounting a penny-farthing, (A) place your hands on the bike with your left foot. (B) Place your right foot on the step. (C) Push the bike with your left foot. (D) Pull yourself up on the seat. (E) Get comfortable—find the pedals and ride the bike. (F) Slow down by using your legs. (G) dismount by sliding your right foot down to the step. Push yourself off carefully. (H) Place your left foot on the ground and begin to stop the bike.

One solution, besides avoiding hills, is to add a brake to the rear wheel with a control lever on the handlebars. This should allow safer braking on hills.

Penny farthings with tricycle or bicycle front wheels can generally be mounted by children by simply straddling over the saddle with feet on the ground. Put one foot on a pedal, then push off with the other foot and bring it up to the pedal. This assumes, of course, that the cycle is small enough for the rider to straddle over the saddle with feet on ground.

Steering is generally no special problem. Just turn the handlebars and lean as you would on a regular bicycle.

Perhaps the thing you will most have to keep reminding yourself is to slow the pedal action gradually, without any abrupt action.

Children and teenagers who ride bicycles usually are quick to pick up the technique of riding penny farthings.

### **A VARIATION**

A variation of the penny farthing, which was actually around before the penny farthing, is to have both wheels the same size. It's like a bicycle with the crank set and chain removed, the rear wheel replaced with a front one and a unicycle or penny farthing wheel, bearing and crank assembly added to the front wheel. In practice, the saddle usually has to be moved forward somewhat so the rider can comfortably reach the pedals. There is usually less danger of the rear wheel coming off the ground than is the case with a high-wheeler.

### **IDEAS FOR PENNY FARTHING**

There are two national organizations that might be of interest. *The Wheelman (High Wheel Riders)*, 32 Dartmouth Circle, Swarthmore, PA 19081, and the *Antique Bicycle Club of America*, 260 West 260th Street, New York, NY.

If you can get enough people interested in penny farthings or various types of novelty and special cycles, you might want to start a local club. A popular activity is to ride in parades and give demonstrations. For penny farthings, costumes of the 1880s will add to the effect.

## Tandem and Double-Decker Bicycles

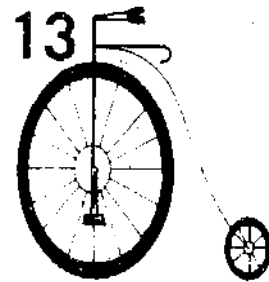

Tandem bicycles include bicycles with two or more riders—one rider behind another in line. The most popular tandem, but certainly not the only one, is for two riders and it is sometimes called “a bicycle built for two.” Tandem bikes for two and three riders are used in racing competitions.

A novelty bike with 32 riders was first demonstrated at Farway, Devon, England, on August 26, 1974. It is 62 feet long. The main topic of this chapter will be tandem bicycles for two riders. On almost all tandems, when one rider pedals both sets of cranks go around. There is no freewheeling between the two crank sets. However, the rear hub is usually freewheeling as on a regular bicycle.

Typical inexpensive tandems are single-speeds. More expensive models are available with internal hub gears and derailleur systems.

Regardless of the type, tandems require a coordinated effort of two or more people, who do not necessarily have to be equal in strength, endurance or cycling experience.

### MANUFACTURED TANDEM

The most readily available tandems are the equivalents of low-priced standard bicycles. These are generally with single-speed, coaster brake hubs. They are what would be considered as middleweight in a regular bicycle. These are designed for utility use. For limited recreational riding, they are generally quite adequate. Rental tandems are usually of this type.

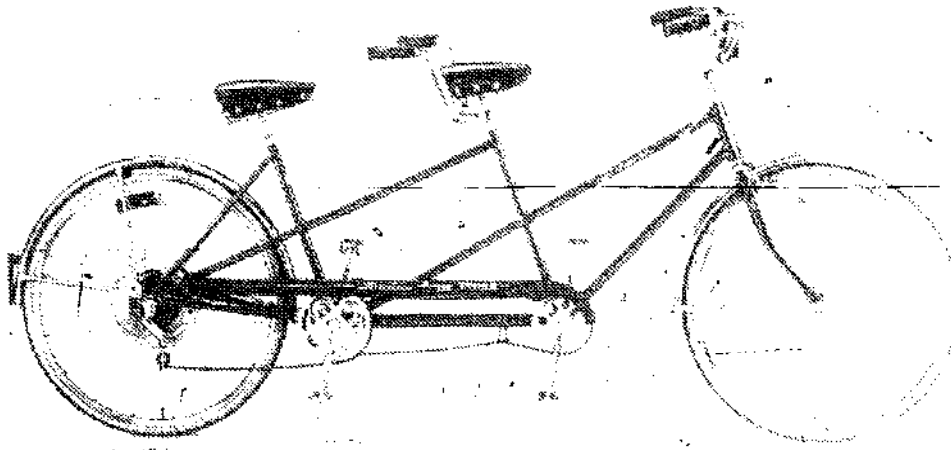

Fig. 13-1. Schwinn Deluxe Twinn tandem has 5-speed derailleur gears and weighs 64 pounds.

For longer rides and touring, a lighter weight model with more precision is called for. These will, of course, be more expensive. Because of the limited demand for these, not many bicycle shops have them in stock. You might be able to get them to special order for you.

Quality tandems are special designs and not just enlarged regular bicycles. The power on the drive system is approximately double that of a regular bicycle and double the weight can be carried. The longer frame length poses additional structural problems. Quality tandems are constructed of lightweight tubing, but of larger diameters than those normally used on regular bicycles of similar quality. Oval tubing is sometimes used to improve rigidity between crank hangers.

The more expensive models typically have derailleur gear systems of five, 10 and 15 speeds (Figs. 13-1 and Fig. 13-2). Other numbers are sometimes used, but they are uncommon.

The two types of drive units between cranks are the crossover, which has the chain and sprockets connecting the two cranks on the left side, and the one-side drive system.

As far as derailleur gears are concerned, the crossover drive has the advantage of allowing a triple chainwheel on the rear crank set for 15 speed gears. Generally, this arrangement places much more stress on the rear crank axle. On the other hand, the one-side drive generally allows a maximum of 10 speeds, with three chain wheels on the right side of the rear crank set. One of these is for the chain connection to the front crank set. The advantage of the one-side arrangement is that it places less stress on the rear crank and axle.

Brakes are an important consideration for a tandem bike. Because of the added rider weight, stopping is more difficult. For this reason, internal expander drum brakes are sometimes used instead of caliper brakes on derailleur models.

Tire wear is much greater than on an ordinary bicycle. While the ordinary one and one-quarter inch tire width can be used on lightweight tandems on smooth roads for limited riding, they often are inadequate for anything beyond this. At best they will be subject to considerable wear and require frequent replacement. For this reason, lightweight tandems frequently use one and three-eighths inch and one and five-eighths inch tire widths. These typically will provide much better service.

### **BUILDING TANDEM**

Two utility-type bicycles will provide most of the parts for a utility-type tandem. A high quality tandem requires advanced frame building skills and is beyond the scope of this book.

Since many tandems built by amateurs are basically the joining of two regular bicycles, they do not turn out very satisfactorily. I suggest that you carefully examine your reasons for wanting to build your own. If it's to save money, I suggest you look over the classified ads in the newspaper to see what is available. Utility tandems frequently are sold as used, but in good condition, for about \$75. Of all the home-built tandems I have seen, and this includes quite a large number, only a few have been equal to or better than a typical used manufactured utility tandem.

If you do want to try to build one, I suggest that you use two men's inexpensive middleweight bikes. If you have had considerable experience building other types of novelty or specialty cycles, then you can probably safely use expensive bikes or frames. A women's bicycle can be joined with a men's, but this might require additional reinforcement if it is to be rigid enough.

A typical joining of bikes is to cut off the head tube from the bicycle that will be used in the back of the combination. Sometimes the head tube is cut in half. When the two frames are joined, the crank hangers should remain the same distance from the ground as they were on the original bicycles.

The rear frame is then brazed to the seat tube of the front bike, which has everything on the frame behind the seat tube and bottom bracket cut off. A section of tubing, usually about two inches in diameter, is brazed in place between the bottom brackets of the two bikes.

Since it is extremely important that everything be lined up exactly, I suggest that you strip all components off the two frames in a temporary wooden jig. The jig can be constructed of scrap materials. Check the alignment carefully before brazing.

The above method will work on joining most bikes. But for some bikes, such as the small ones used for making the tandem shown in Fig. 13-3, certain adjustments might be necessary to fit the frames together. It is important that the original distance of the bottom brackets from ground be maintained, the frames are aligned and that the joined frames be strong and rigid enough.

Assuming that you will be using a single-speed coaster-brake rear hub, you will need a double chainwheel on the rear crank set. Usually the outside one will be used for the chain link to the rear sprocket. These should be lined up. A double chainwheel, such as is used on 10-speed bikes can be used for the rear crank set on the tandem. The inside chainwheel should be the same size as and lined up with the chainwheel on the front crank set. The teeth on all sprockets should be the same size so that one size chain can be used throughout. Usually this will be a one-eighth inch width chain. It is the type commonly used on single-speed utility bikes.

Chainwheel alignment might be somewhat of a problem on some bikes. It might be necessary to saw off a short section of crank housing from one or both frames in order to get the required alignments.

In order to adjust the tension in the chains between crank sets, you will need a way to take up slack in the chain. A small sprocket, called a *chain tensioner*, can be mounted on an adjustable bracket so that it applies tension to the chain. One way of doing this is to buy a chain tensioner at a bicycle shop and rig up a bracket for it.

The rear handlebars are stationary. They are used for gripping but not for steering. One way of attaching the handlebars is to cut off the upper portion of a gooseneck. This is the part that curves forward and the clamp. Braze this to the seat post of the forward riding position. Handlebars are then mounted in this. Another method is to weld a gooseneck to the top tube of the rear frame just behind the forward saddle. Then mount handlebars in the clamp.

After a trial assembly and test ride, the tandem can be disassembled for painting. File and sand smooth any rough areas in the brazing.

After painting, reassemble the tandem. If you prefer, fenders, chainguards and other accessories can be added.



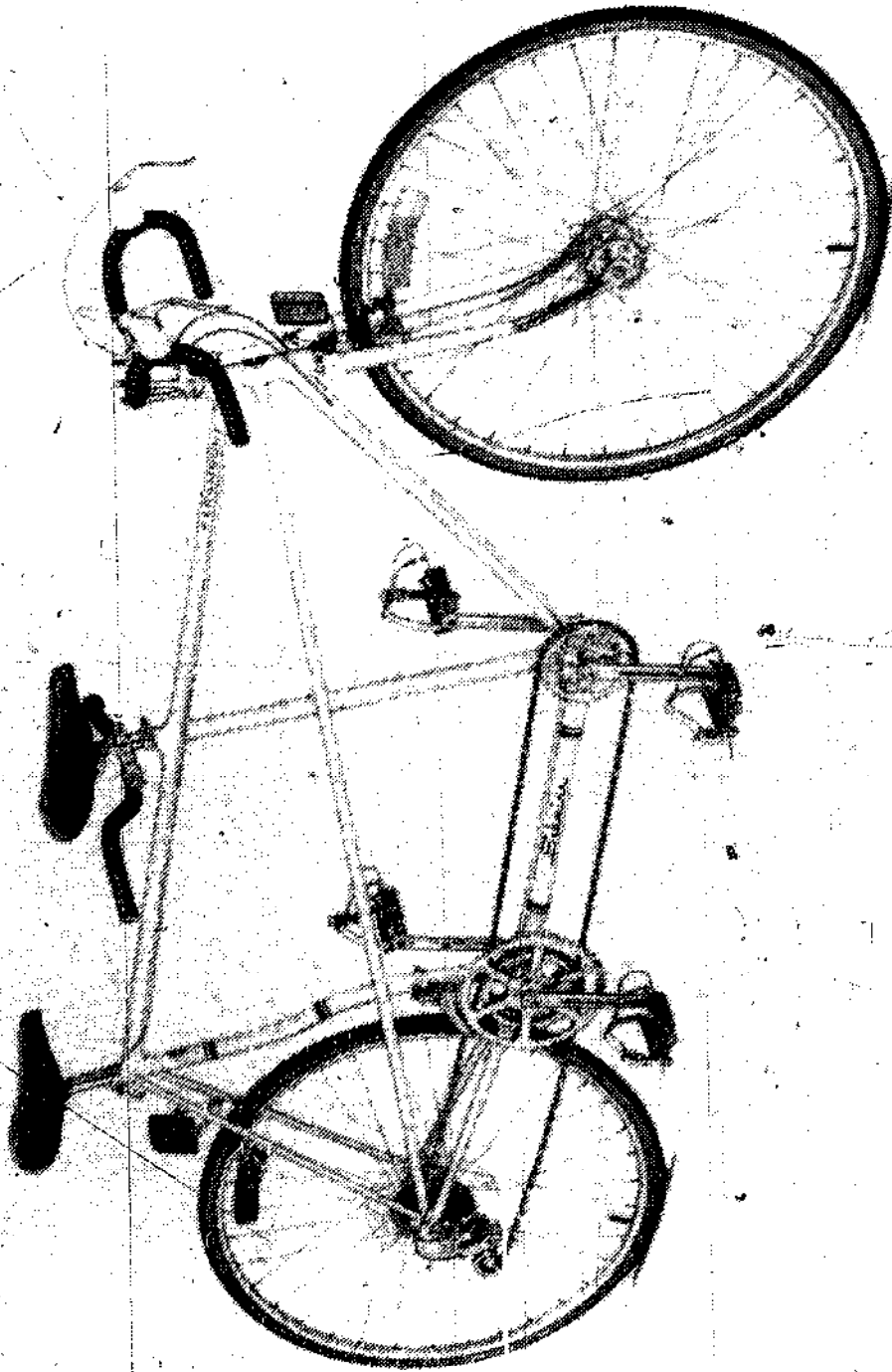

Fig 13-2 Lightweight Schwinn Paramount tandem 10-speed bicycle is hand crafted and features a short coupled rear frame. It weighs about 44 pounds



Fig. 13-3. A tandem built by joining two frames together.

If you prefer, internal gear hubs can be used. If the rear hub has no coaster brake, a caliper brake can be added to the rear wheel. In this case, a second caliper brake should be installed to the front wheel. All controls run to the forward riding position. It is also a good idea to beef up the braking on a tandem with a coaster brake by adding a caliper brake to the front wheel.

### **TIPS ON USING TANDEMMS**

Riding a utility-type tandem at slow to moderate speeds requires little special considerations. These types are frequently rented to inexperienced tandem riders and most make out quite well.

For more serious tandeming, the front rider is the "captain". On most tandems, the cranks are set in phase, with the forward and rear cranks in the same position. Sometimes the cranks are set out of phase in an attempt to get more continuous power flow from the pedaling of the two riders. The possible advantages are debatable and it increases the possibility of hitting a pedal on the ground during a turn. In phase, both riders would have the pedals on the turn side in the up position.

The rear rider should not try to turn. Any leaning in an attempt to control the bicycle can cause a whipping action and possible spill. The two riders should learn to work together.

With derailleur models, there is the additional problem of shifting. Some captains call signals so that the rear rider will know when to relax pressure on the pedals. However, experienced tandem teams often work together by silent signals through the pedals.

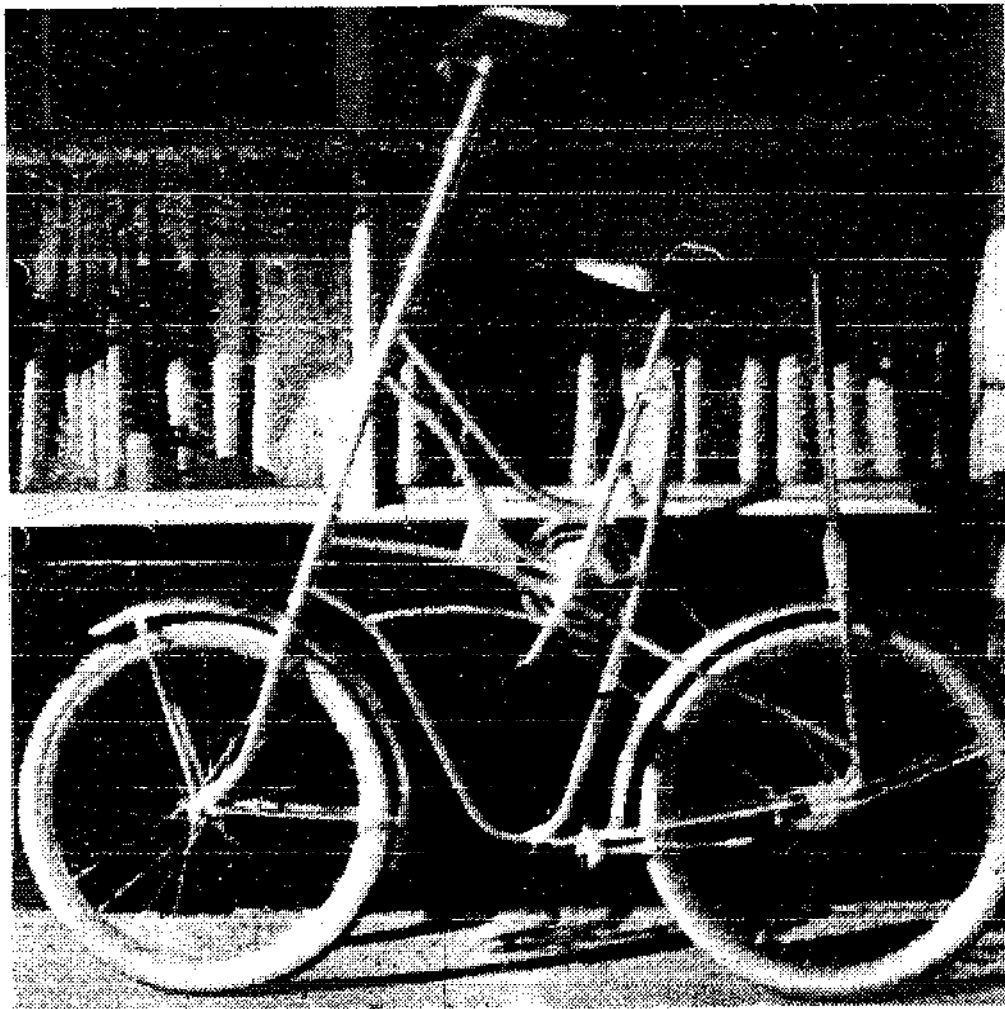

Fig. 13-4 An example of a double-decker.

### **DOUBLE DECKER BIKES**

Double-deckers, also called *high-bikes* and *upside-down bikes*, are fun novelty cycles. Bicycles up to 20-feet tall have been ridden. Only regular double-deckers, approximately twice the height of a regular bicycle, will be covered here. With simple additional modifications, taller bicycles can be constructed.

While double-deckers are frequently ridden on streets with automobile traffic, this is unsafe and in many areas illegal. This is strictly a novelty cycle and should be considered as such.

These cycles are not manufactured, but conversion of regular bicycles is fairly simple. I recommend that only old, inexpensive bicycles be used.

### **CONSTRUCTION OF DOUBLE-DECKER BIKES**

Figure 13-4 shows one method of construction. The frame of one bike is brazed or welded to that of another bicycle. The head tubes of the two bikes are lined up so that the fork of the lower bike can be extended up through the head tube of the upper bike by

adding a tube extension to the lower fork. Handlebars are installed at the top end of the fork extension. A saddle is attached to the upper frame and braced as required. Another method of construction is to turn the frame of a bicycle upside-down, reversing the crank direction in the hanger bracket. The chainwheel will be on the right side of the double-decker like on a regular bicycle. The fork is reversed in the frame. The rear wheel is turned around so that the sprocket is on the chainwheel side. The brake-arm strap is re-mounted to the opposite side of the frame.

Methods for completing these bikes have varied widely. One method is to weld a tube to the crank bracket of the frame for a seat



Fig. 13-5. Riding a double-decker bicycle.



Fig 13-6 A double-decker with decorated wheels.

tube. A notch is made in the upper end for a seat post clamp. This holds the seat post and saddle in place. A banana saddle can be used with extended rear supports.

The type of handlebars used on high-rise bicycles might be long enough for use on a double-decker when attached to a regular or extra long gooseneck or extension tubes can be welded to the ends of the handlebars. In general, the handlebar grips should be at least as high as the saddle. About a foot above is usually even better. Sometimes a single tube fork extension with an automobile steering wheel on top is used in place of handlebars. This is less efficient for riding, but adds a good novelty touch.

There are, of course, many other methods of construction. You will probably want to take advantage of the parts and materials you have available. However, make it sturdy.

### **TIPS ON USING DOUBLE-DECKER BIKES**

Most riders mount by placing the left foot on the left pedal directly from the ground, pushing forward scooter fashion with the right foot, then swinging the right leg up and over the saddle. Another possibility is to add a peg to the frame to use as a foot step.

Dismounting is essentially the reverse of mounting except that you have the added problem of braking. One way of solving this is to brake nearly to a stop, but with the bicycle still moving forward slowly. Then dismount in reverse order of mounting. The bicycle will be moving forward slowly enough that stepping off should not be difficult.

Riding a double-decker bike gives the feeling of being above it all. But other than this sense of being up in the air, it's essentially like riding a regular bicycle (Fig. 13-5).

For riding in parades, wearing a clown costume and decorating the bicycle wheels (Fig. 13-6) will add to the novelty effect.

## Artistic Bicycles

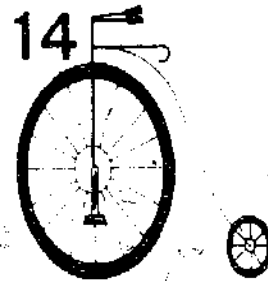

You've probably seen circus performers ride bicycles backwards and on one wheel like a unicycle, either from the saddle (Fig. 14-1) or head tube (Fig. 14-2). You might have wondered why these stunts are not possible on a regular bicycle, except perhaps for wheelies. Wheelies can be continued as long as the pedal rate is maintained to the point where the rear wheel does not freewheel. Force must be constantly applied to the rear wheel. What is basically happening is that the front wheel is in the air, trying to come back down, and the bicycle is being pedaled—under or at the same speed as the front wheel—so it can't come back down.

However, on a regular bicycle, you are extremely limited when it comes to feats such as this. The fact is that artistic or circus bicycles are very special cycles. They usually have fixed rear hubs (no freewheeling) and one-to-one drive ratios, straight (no rake) front fork blades and a deeply curved saddle (Fig. 14-3) that arches up high in the back and is mounted further toward the rear of the cycle than is normal on a regular bicycle. Two other important features are that the cycle is lightweight and the seat tube and crank brackets are close to the rear wheel. This is similar to shortened frame used on sprint racing bicycles. Many artistic bicycles also have axle extensions for use as foot stands that make additional stunts possible (Fig. 14-4).

There are world championships in artistic bicycling with individual, partner (two riders on one bike) and team (group of riders each on separate bikes) riding. The activity has only recently been

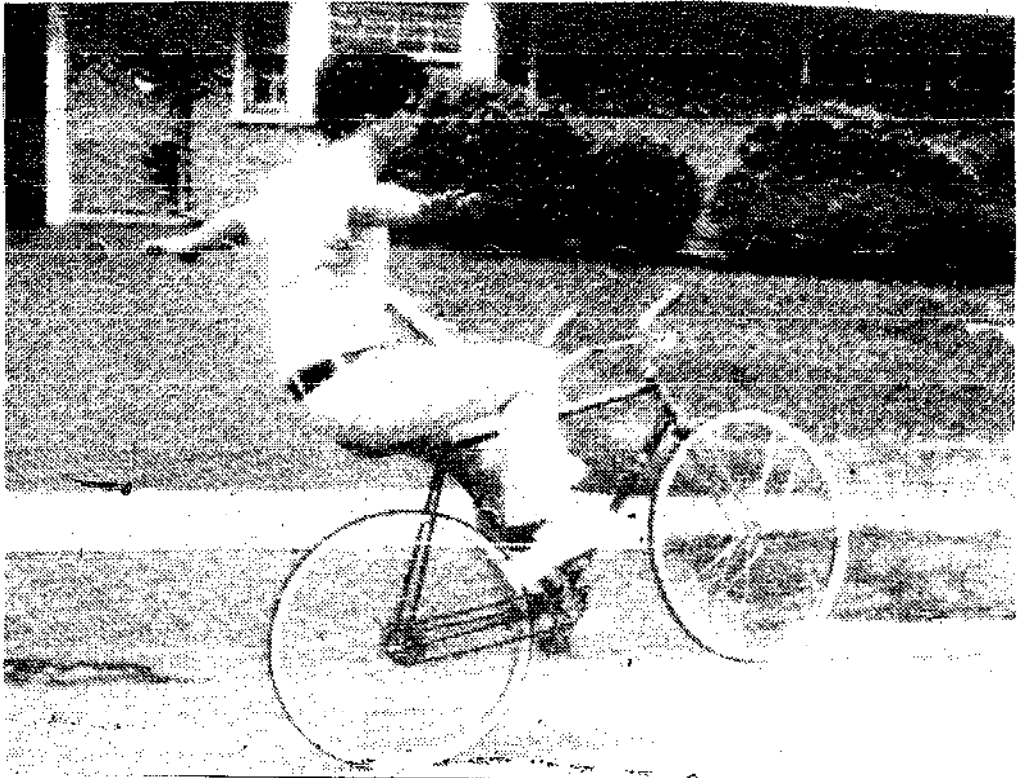

Fig 14-1. John Jenack riding an artistic bicycle on one wheel

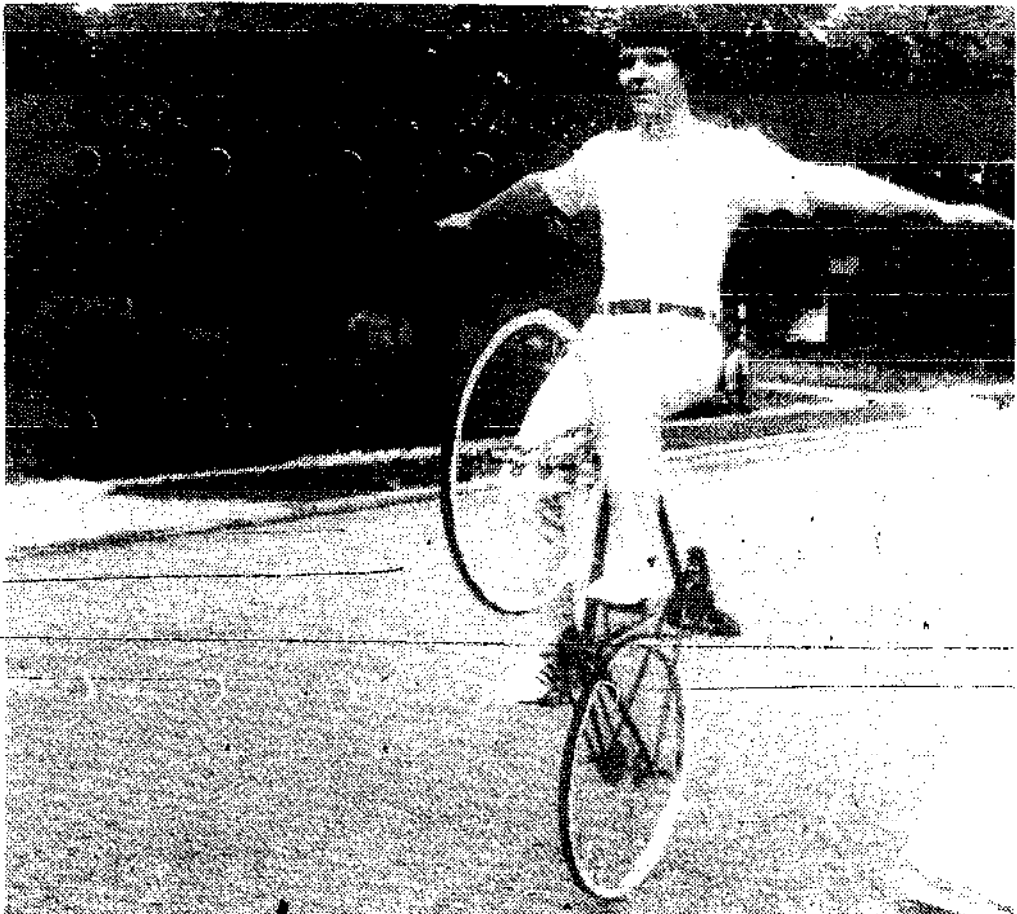

Fig 14-2. Riding an artistic bicycle on one wheel while seated on head tube.



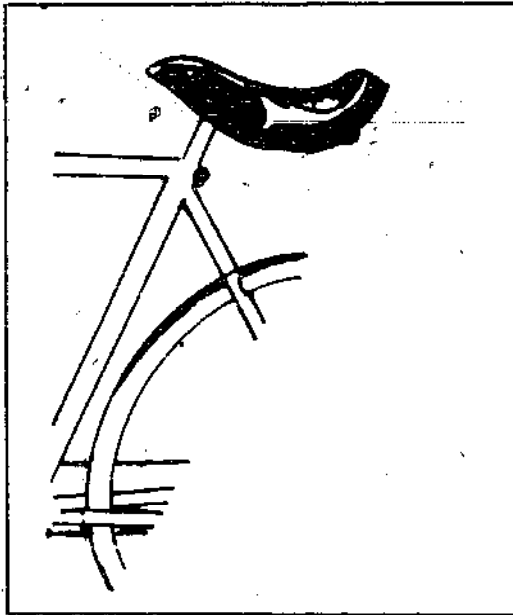

Fig 14-3 An artistic bicycle saddle

introduced on the amateur level in the United States. However, professional stage and circus performers in this country have long used similar bicycles.

The term *artistic bicycles* comes mainly from the competitive sport. Previous to this they were generally called *circus* or *trick* bicycles in this country.

#### MANUFACTURED ARTISTIC BICYCLES

Artistic bicycles are not now being manufactured in the United States, nor are they being imported on a regular basis. Several West German firms manufacture them. Two places where they can be obtained are *Euler & Glöckner, Schauenburgerstr. 31, 3507*

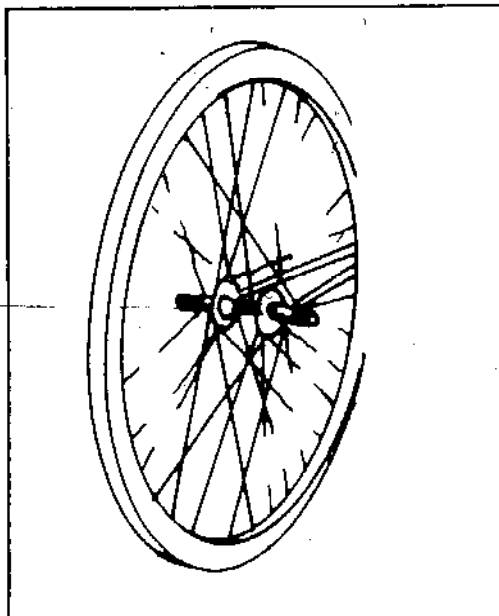

Fig. 14-4. Axle extensions about two to two and one-half inches long, called dorns, are used as foot stands. They make additional stunts possible.

Bainatal 4—BRD (West Germany) or Helmut Walther, Lihlstrasse 6, 7600 Offenburg—BRD (West Germany).

The prices start at about \$350 before shipping and import duties are figured in.

### CONVERSIONS

These can range from simple modifications on *high-riser* bikes, which are often used for doing wheelies anyway, to conversions of track racing bicycles into artistic bicycles similar to the ones used in the world championships.

With a modified *high-riser*, a child could certainly amaze his or her friends. It would be possible to continue wheelie action and ride around on the rear wheel alone while performing all sorts of stunts. The bike could also be ridden backwards. If the front fork is also straightened (no rake), the front wheel can be spun in circles. This type of bicycle, with the banana saddle, the rider's weight well back. No modifications are required here.

Basic modifications include stripping fenders, chainguards, kick stands and other accessories from the stock bike. You should also change the rear sprocket from freewheeling to fixed, replace the chainwheel with a sprocket to match the one on the rear hub for a one-to-one (Fig. 14-5) gear ratio—although other gear ratios will

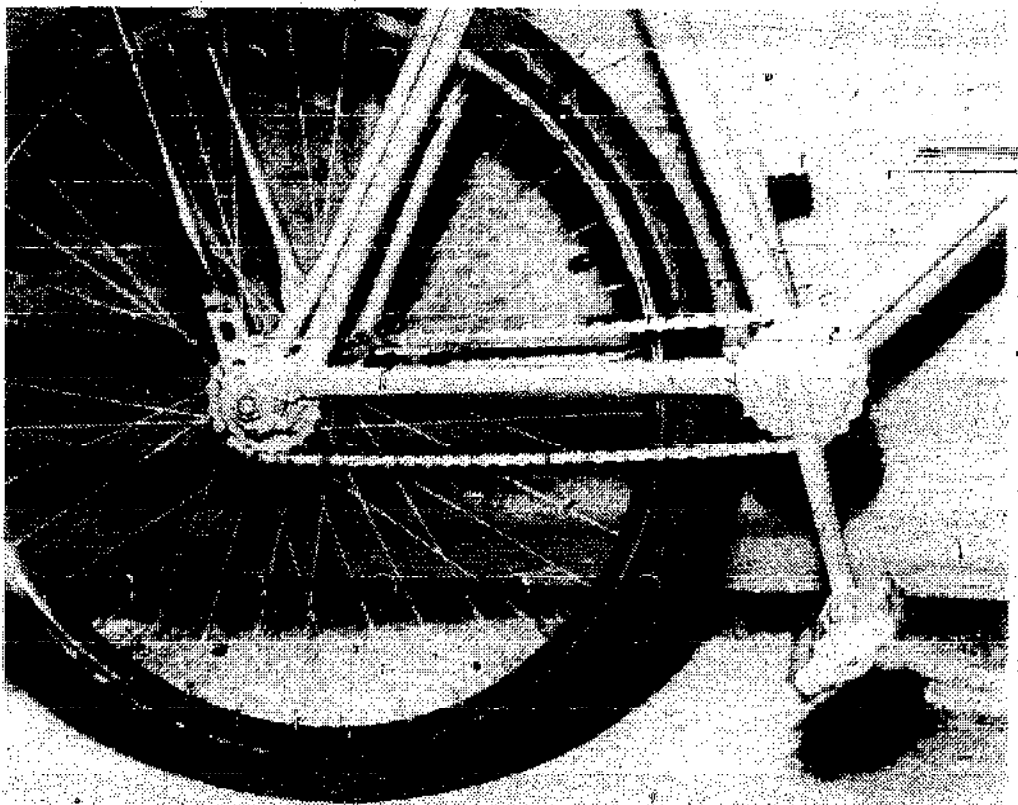

Fig. 14-5. One-to-one direct-drive arrangement for an artistic bicycle.

also work—and straighten (remove rake) the front fork. Methods for making these modifications are detailed in chapter six. The chain will probably have to be shortened. See chapter five for methods of accomplishing this.

For making a much better model, similar to the ones used in artistic bicycling competition, a lightweight bicycle can be modified. While most will work, sprint racing bikes with shortened frames come the closest to the ideal. A short frame with the seat tube and bottom bracket close to the rear wheel is best.

Required modifications include adding a fixed rear hub if the bicycle selected doesn't already have one. Track racing bicycles generally have these. Another required modification is a ratio obtained by replacing the chainwheel with a sprocket that matches the one on the rear. Fairly large sprockets, about 24 to 28 teeth, are generally used. The front fork is also straightened. Techniques for making these modifications are covered in chapter six.

A proper saddle can be a real problem. One possibility is to slacken the tension in a racing saddle and use an L shaped seat post angled backwards and positioned like the saddle on the artistic bicycle shown in Fig. 28-3. The saddle should be positioned well back and should be curved upward at the rear so that rider will not slip off when riding with front wheel in the air.

Dropped handlebars turned over can be used on the artistic bike. Rubber hand grips should be used.

The artistic bicycles used in competition also have axle dorns, Fig. 28-4, which are extensions that thread on to the ends of the axles. If these are to be used, it's a good idea to go to a larger front hub axle that is the same size as used on the rear. Then it will be strong enough to hold the weight of the rider standing on the dorns.

## **CARE, REPAIR AND MAINTENANCE**

Repair and maintenance of artistic bicycles is essentially the same as for regular bicycles. Certain stunts, if done improperly, can be very damaging to the bicycle. Especially avoid coming down hard on the front wheel from riding on one wheel and spinning the front wheel when riding forward or backward with weight on both wheels. When professional performers do what appears to be this wheel spinning stunt, they are actually riding almost entirely on the rear wheel with little or no weight on the front wheel.

## **TIPS ON USING ARTISTIC BIKES**

To learn to ride on one wheel, start by doing wheelies. You should wear a safety helmet whenever you attempt a stunt. Gradu-

ally work up to the point where you can ride long distances with control. If you tip backward, take your feet off the pedals and straddle your legs off backward so that you are standing. With practice it should be possible to make turns and circle patterns while riding on one wheel. Or you can spin the front wheel while on the rear wheel as shown in Fig. 14-6. It is more difficult to ride backward while on one wheel or to rock back and forth in one place with alternate direction half or full pedal cycles.

While it's possible to learn these one-wheel stunts without being able to ride a regular unicycle, learning on the regular unicycle first should certainly make things easier (see Chapter 29). Riding on one wheel while straddled over the head tube, as shown in Fig. 14-7, is similar to riding a chain-driven, giraffe unicycle. Riding on one wheel without holding onto the handlebars (Fig. 14-1 and Fig. 14-6) is much more difficult than with holding handlebars.

In artistic bicycling competition, stunts are done using the dorns, standing on the saddle and handlebars while coasting. Doing a handstand on the handlebars is an extremely advanced stunt.

#### IDEAS FOR ARTISTIC BICYCLING

You might want to form a club. Artistic bicycling goes well with unicycling so you might want to combine these activities.

To my knowledge, there have not been any artistic bicycling competitions held in the United States to date. However, artistic bicycles were demonstrated in the 1976 National Unicycle Meet and



Fig. 14-6. Spinning the front wheel while riding on one wheel.



Fig. 14-7: Riding on one wheel while straddled over the head tube is similar to riding a chain-driven, giraffe unicycle.

this could well lead to their inclusion as a competitive event in future years. Artistic cycling is very popular in Europe, and I feel that it is going to catch on in this country.

Artistic bicycles are ideal for riding in parades. You might want to work up an amateur act either alone or with one or more other performers.

Artistic bicycling seems to have tremendous potential in the United States as a recreational activity, performing art and competitive sport. I think it is only a matter of time until we will have entries in the world championships. Only a few years back, unicycling was a sleeper in this country. Now it has boomed in popularity. I think artistic bicycling will follow in the same path.

The governing body of artistic bicycling on the international level is: *Commission Internationale de Cyclisme en Salle*, 6520

*Worms*—BRD, *Gaustrasse 77* (West Germany). Artistic bicycling is practiced in Switzerland, France, Belgium, Denmark, German Democratic Republic, Austria, Japan, Czechoslovakia, Netherlands, Sweden, West Germany, Italy, Poland, and to a limited extent the United States.

In the United States, the organization that is presently most closely related to artistic bicycling is the *Unicycling Society of America Inc.*, PO Box 40534, Redford, MI 48240. Information about this organization is given in the next chapter.

## Unicycles

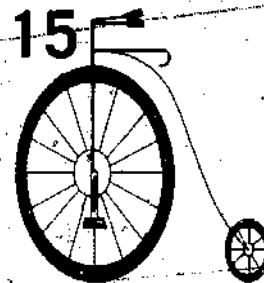

For a long time after its introduction, probably in the 1870s, the unicycle remained almost exclusively in the professional domain. Today, it is fast being discovered by youngsters, teenagers and adults alike as a hobby, recreational activity, competitive sport and performing art. It's estimated that at least 50,000 people in the United States have learned to ride and the number continues to grow (Fig. 15-1).

While unicycling is most popular with children and teenagers, hundreds of adults have also learned to ride. Riding does require a certain level of fitness, but this is generally much less than might be expected. The most important requirement for success seems to be a sincere desire to learn. At least one senior citizen who had never even mastered the bicycle picked up the skill. Several blind people have learned to ride.

Unicycling has much to offer. It's a fun activity with fantastic maneuverability. You can make wide sweeping turns or spin around in one spot. While some people who take up the activity are content just to be able to pedal along on a standard unicycle, many go on to trick riding and chain driven giraffe unicycles. Regardless of the skill level the challenge remains. There's always another stunt that you can learn or one that can be done better. Any unicycling has a large fitness element. Because of the fun and challenge of the activity itself, you might not think of it as physical activity, but the benefit is there all the same—like an unexpected reward.

## BRIEF HISTORY OF UNICYCLES

Monocycles, one-wheeled devices with the rider inside the wheel, were around before the unicycle. The rider was positioned above the wheel and usually mounted on a saddle. However, it seems likely that the unicycle came about independently.

Unicycling was probably discovered in the 1870s by accident while someone was riding a penny farthing. The front wheel of these cycles (see chapter 12) was fixed to the pedal cranks (no freewheeling) like the modern unicycle. To brake on the penny farthing, the pedal action was slowed down. If done too rapidly, the small rear wheel would raise off the ground. Often, a rider found himself traveling along on the front wheel alone, with the rear wheel in the air, before the rear wheel returned to the ground or the cycle flipped forward.

It seems logical that one day someone would get the idea of removing the back half of a penny farthing altogether and riding on the front wheel alone. It is interesting to note that a number of early cyclists made the claim of having done just this. Who was actually first remains controversial. It could well be that this was done by a number of people independently.

Professional performers were quick to capitalize on the idea. For many years the unicycle remained almost exclusively their property. Unicycles were rarely seen outside the professional domain. As penny farthings disappeared from the scene with the advent of the safety bicycle, people were less likely to discover the unicycling technique by accident. This further protected a secret the professional knew only too well; unicycling is much easier than it looks.

As time passed, a few people outside the professional acts—which were usually passed down in a family—tried unicycles. They found, probably to the dismay of the professionals, that unicycles, once the basic technique is mastered, are fairly easy to ride.

The secret was out, but there was still another factor that limited the number of participants. There were no manufactured unicycles.

Even so, the number of unicyclists increased gradually and in the late 1940s and early 1950s a few companies, seeing that there was some demand, started making unicycles. The activity started to take hold.

William Jenack, a computer technician in Long Island who has been riding unicycles since the early 1930s, was one of the first to see the tremendous potential that unicycling had to offer as a



recreational activity and sport. He started corresponding with other unicyclists, not only in this country, but throughout the world. He taught hundreds of others of all ages how to ride and formed a demonstration and parade group called the *Jenack Cyclists*.

By the late 1970s there were hundreds of individual riders and a number of clubs had formed. In 1973, largely through the efforts of Bill Jenack, the *Unicycling Society of America Inc.*, was formed as a nonprofit organization to foster social and athletic interest in, and promote the sport of unicycling among youth and adults of the country by establishing voluntary standards of performance and sponsoring and overseeing local and national meets. The organization also disseminates information on all phases of the sport to interested parties throughout the country via a newsletter and information service.

There are presently over 600 members and the organization is growing rapidly. Membership, which includes a quarterly newsletter, is currently \$6 a year. The mailing address is: *Unicycling Society of America, Inc., PO Box 40534, Redford, MI 48240*. The organization sponsors a national unicycle meet, held annually in different sections of the United States, with competitions in racing, parade and artistic riding.

Today there are dozens of large unicycling clubs and groups, including the *Pontiac Unicyclists* in Pontiac, Michigan; the *Redford Township Unicycle Club* in Redford, Michigan; the *San Diego Unicycle Club* in San Diego, California; the *Concord Unicyclists* in Concord, California; the *Paul Fox Unicycle Club* in Marion, Ohio; the *CHEERIOS* in Longview, Washington; the *University of Pittsburgh Unicycle Club* and the *M.I.T. Unicycle Club*. Many amateur circuses across the country include unicycling acts.

Unlike typical fads, people who take up unicycling often stay with the activity for a period of years and sometimes it becomes a lifetime endeavor.

## INTRODUCTION TO UNICYCLES

For our purposes I will define a one-wheeled pedal cycle with the rider's center of gravity above the center of the wheel as being a unicycle. However, another type of one-wheel cycle with the rider inside the wheel and the center of gravity below the center of the wheel is sometimes also referred to as a unicycle. The trend in terminology, which I will follow here, is to call the cycles with the rider's center of gravity above the wheel *unicycles* and those with the rider's center of gravity below the center of the wheel *monocy-*

cles. In older writings and translated materials, these distinctions often do not apply.

Most unicycles are of one of two basic types. Some have axle and crank arms connected directly to the hub. These are referred to as *standard unicycles*. Others are *giraffe unicycles*, which follow the same basic principle as the standard unicycles, except that there is a chain-drive or other type drive between the hub and the cranks. Artistic bicycles, described in chapter 14, can be ridden on one wheel like a giraffe unicycle.

Within the two basic types of unicycles, hundreds of variations have been built and others are still being invented. At the present time, the only manufactured models readily available are a fairly large selection of standard unicycles and one six-foot high giraffe model. Most others must be special built, either by doing the building your self or having it done for you.

### MANUFACTURED UNICYCLES

The ones available range all the way from tricycle-type construction to the high quality bicycle-type construction of professional models. At first thought, it might seem that the tricycle-type unicycles would be the best buy for children and the professional models for adults. But in practice this logic seldom works out. In



Fig. 15-1. John Held riding a standard unicycle.

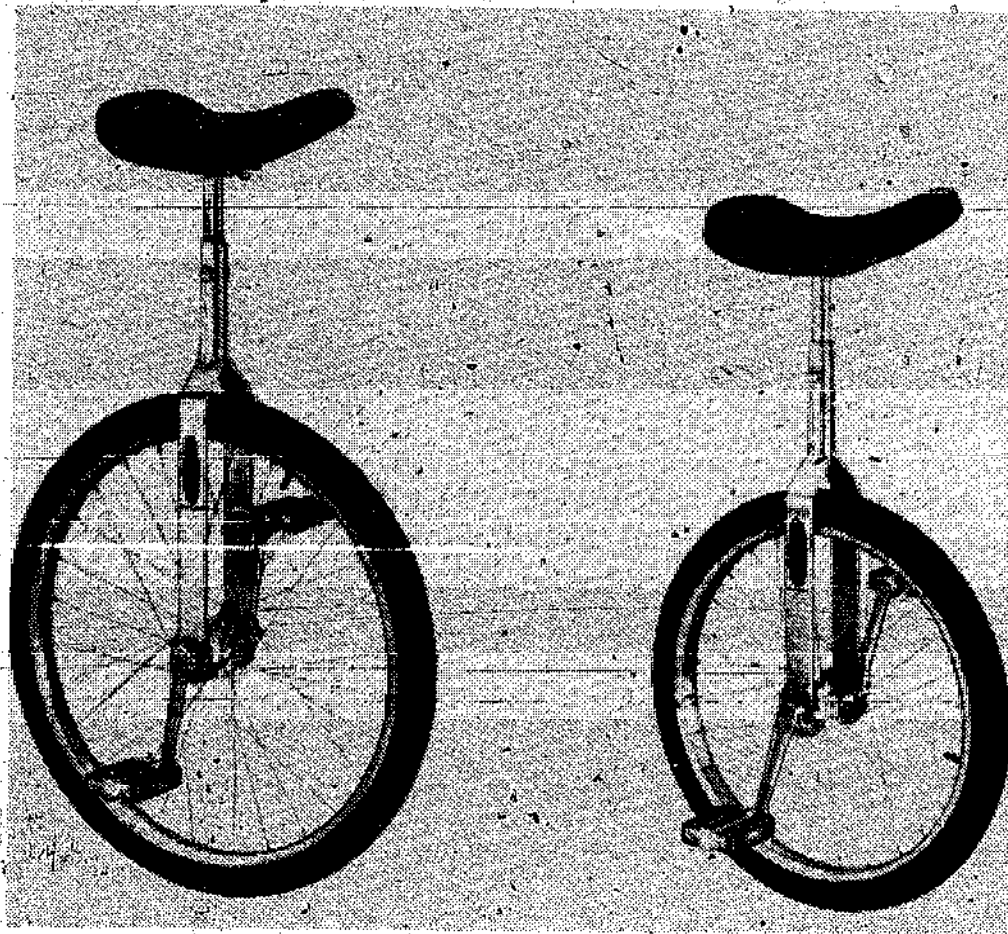

Fig. 15-2. Schwinn 24-inch and 20-inch wheel unicycles.

almost every case, the professional models prove to be the best buy for all ages. Provided, of course, the unicycle can be adjusted to fit the rider. This might be the case for the tricycle type. They could be used by young children who can not fit a professional model unicycle at the lowest saddle adjustments. But the manufactured ones, at least the ones I'm familiar with, seldom adjust any smaller.

Two common failures make the tricycle-type unicycle generally inadequate. They lack precision, making them difficult to ride, and they are subject to frequent breakdowns.

At one time, these unicycles could be identified by their solid or semi-pneumatic tricycle-type tires. However, some of these cycles now have inflated bicycle-type tires so this is no longer a good guide for identifying them. Tricycle-type bearings are perhaps a better identification.

To add to the confusion, there are a number of unicycles in between the tricycle and professional models. Some have a mixture of good and poor features. Check especially the hub and bearing assembly. A frequent source of trouble is play between the wheel and the unicycle frame.

About the only good point I can think of in favor of the tricycle-type unicycles is the price. Some sell for about \$20.

The professional model unicycles presently retail for about \$55 to \$75. There are both domestic and imported models for top quality. Properly cared for, these unicycles can last for many years. The tricycle type often break down almost immediately.

Three top quality unicycles manufactured in the United States and available with both 20-inch and 24-inch wheel sizes are the *Schwinn* (Fig. 15-2), *Matthews* (Fig. 15-3) and *Columbia* brands. Of the imported unicycles that I'm familiar with, I recommend the *Oxford*, *American Eagle* and *Sturdee* brands.

The saddle should be the curved unicycle type. Most all unicycles now come these, but they vary considerably in quality and comfort. Make certain that the saddle can be adjusted so that legs will be nearly extended at the low points of the pedal cycles. If the saddle will not go high enough, sometimes the situation can be remedied by purchasing a longer seat post. Make sure it fits the unicycle.

All of the top quality unicycles that I'm familiar with have three-piece cottered crank assemblies. The only one-piece cranks that I've seen used on unicycles have been tricycle-type units.

The three-piece cranks come with crank arms in various lengths. I prefer the five and one-half to six-inch length for most types of riding, but everyone seems to have his or her own opinion here.

For learning and stunt riding, I recommend the 20-inch wheel for both children and adults. Larger wheel sizes are an advantage for riding long distances and on rough surfaces.

Several companies now offer giraffe unicycles. Included are the *Oxford P21 Hi Boy* (Fig. 15-4) by *Oxford International*, the *Schwinn U-72* by *Schwinn* and the *Penquin*, by the *Penquin Cycle Co.*

I suggest that you try local bicycle shops first. If they don't have what you want in stock, you might be able to get them to order for you. If you can't get what you want this way, you can mail order from *Jenack Cycles, 67 Lion Lane, Westbury, NY 11590.*

## **BUILDING UNICYCLES**

Building unicycles is a fascinating hobby. It's generally possible to save money by building rather than buying, although this depends on how inexpensively you can get the required parts and material and if you have the necessary skills, tools and equipment. Perhaps

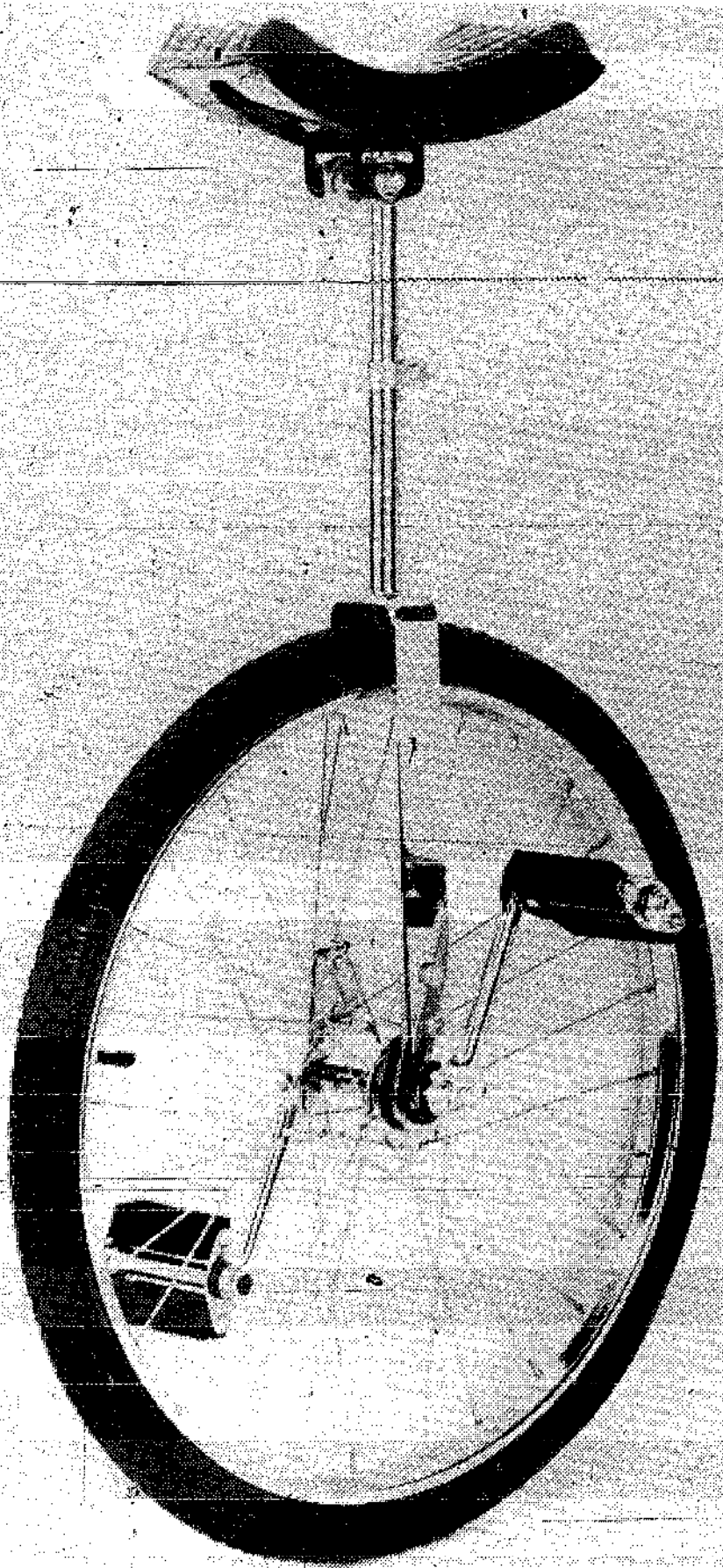

Fig. 15-3. Matthews unicycle.



Fig. 15-4. Oxford P21 Hi-Boy Unicycle.

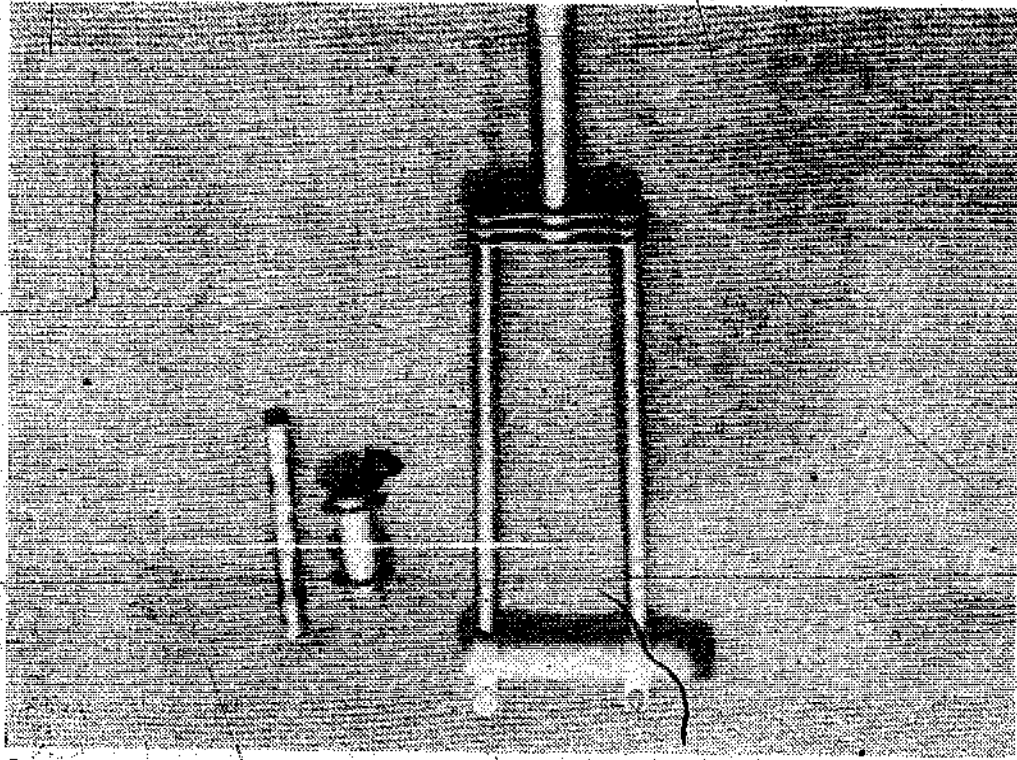

Fig. 15-5. Basic parts for the frame and hub of a standard unicycle.

the most important advantage of building is that you can make types of unicycles that are not manufactured, including original designs.

The basic source of materials is old bicycles and bicycle parts, with perhaps a few items being purchased new.

### **STANDARD UNICYCLES**

Figure 15-5 shows the basic parts for a unicycle that I made. The five-eighths inch axle stock is centered with shims or washers in a rear hub that is symmetrical on both ends. The axle should be long enough for spacers, bearings and crank arms. The spacers are used on both sides of each bearing to give clearance for the bearing holders. Braze the axle to the hub when you have it centered exactly.

The bearings should fit snugly over the axle and be approximately three-quarters of an inch wide or a little less. Figure 15-6 shows a bearing positioned over one end of an axle brazed to a hub.

Flatten areas placed diametrically opposite each other are filed near the ends of the axle for crank cotters. I suggest that you use a cottered axle from a bicycle as a model. This job must be done carefully, as otherwise the cranks might not be held firmly or be exactly opposite each other.

Make a trial assembly of spacers, bearings and cranks on the axle, then disassemble and lace the hub to a rim as detailed in chapter five. Truing can be done after fork assembly is completed

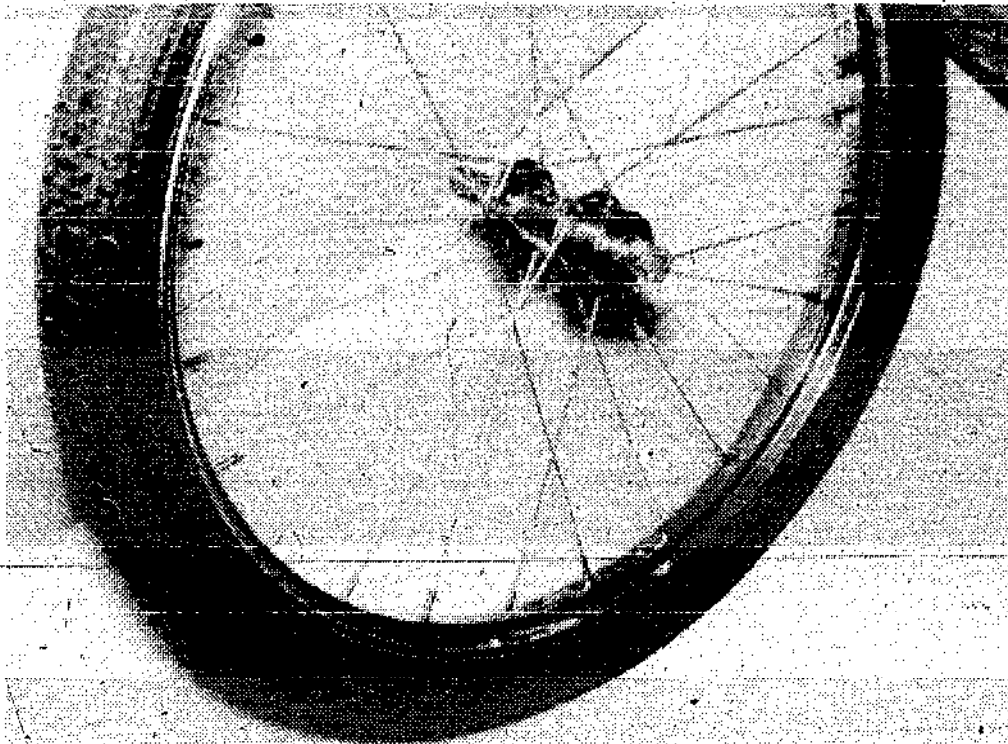

Fig. 15-6. Bearings should fit snugly over the axle.

by mounting the wheel in place and using the unicycle frame as a truing stand. Clamp it upside down between blocks of wood in a vise.

For bearing holders on the unicycle shown in Fig. 15-6, Fig. 15-7 and Fig. 15-8, I used large seat post clamps that, when opened slightly, would just fit over the bearings. A bent bolt is used through the two holes to form a ring around the bearing. With the bolt tightened, the bearing is held firmly in place. Two holders are required for the unicycle. I mounted them in place over a piece of pipe the same diameter as the bearings I used to position the holders for brazing to the fork. This is shown in Fig. 15-8.

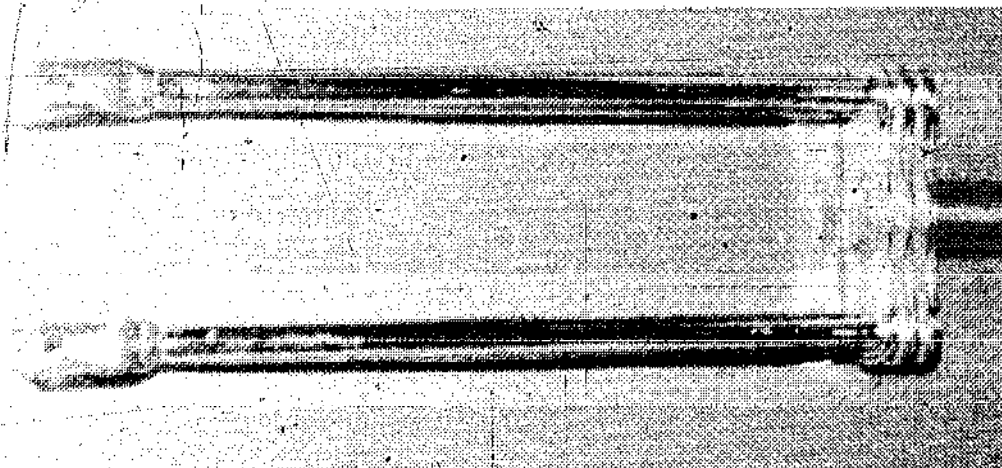

Fig. 15-7. Seat post clamps are used for bearing holders.



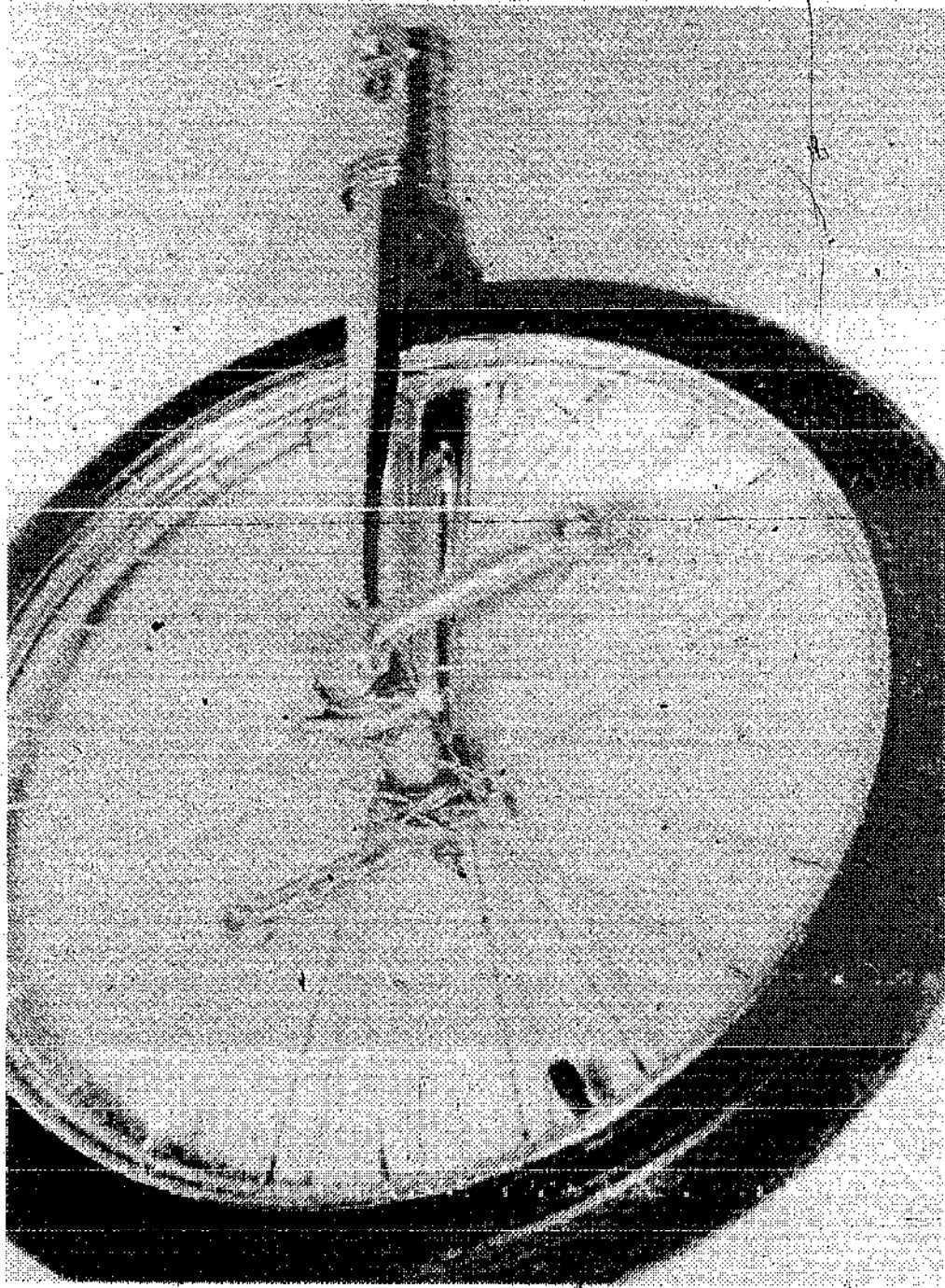

Fig. 15-8. Bent bolts are used to hold bearings in place.

A straight fork is required. See chapter six for how to straighten a fork. Bearing holders are then brazed to fork ends.

A notch is made in the head end of the fork for a seat post clamp (Fig. 15-9). Before making the notch, I cut the threaded portion off of the fork. A standard seat post was used.

For a saddle, I added padding to a standard metal-base saddle and taped the padding in place as shown in Fig. 15-10. A sewn cover was installed over this as shown in Fig. 15-11. Another possibility is to purchase a unicycle saddle at a bicycle shop.

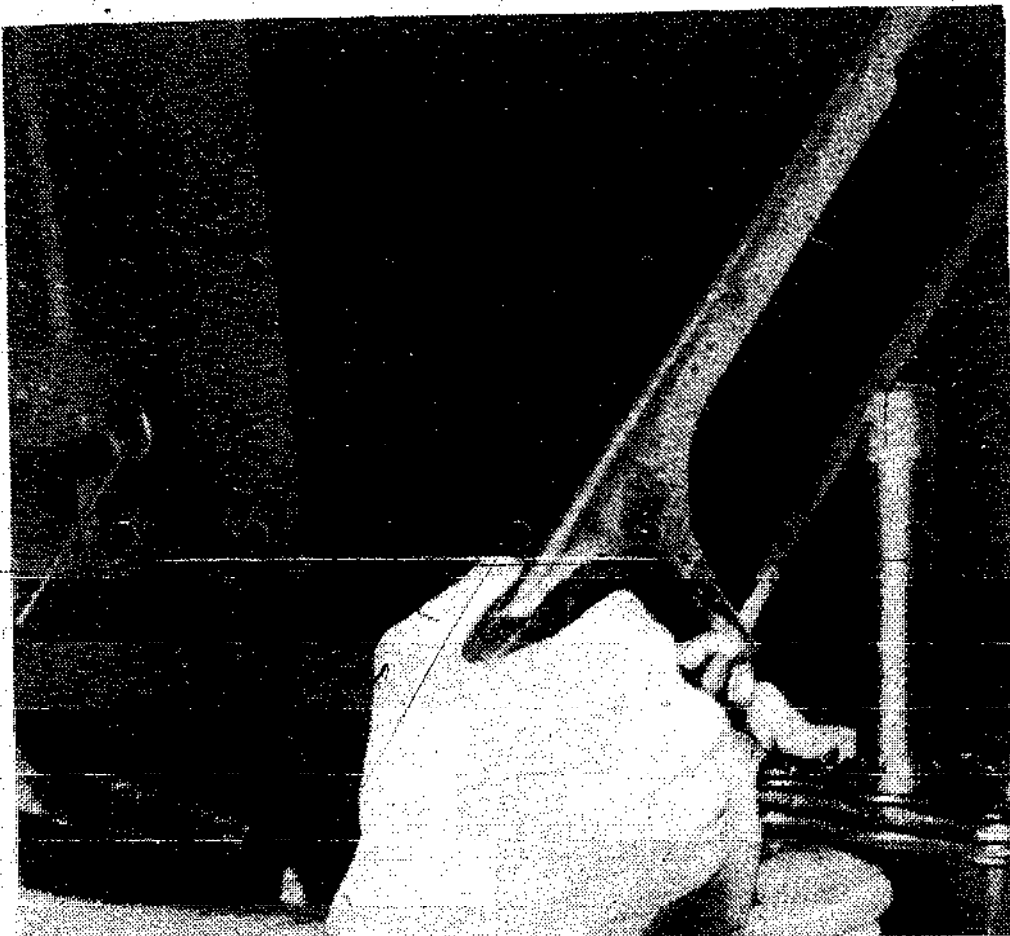

Fig. 15-9. Make a notch in the fork for the seat post clamp.

I had the unicycle frame chrome plated, but if you prefer paint will also serve.

An alternate method of constructing bearing holders is to make up split blocks, but this is much more difficult than the method

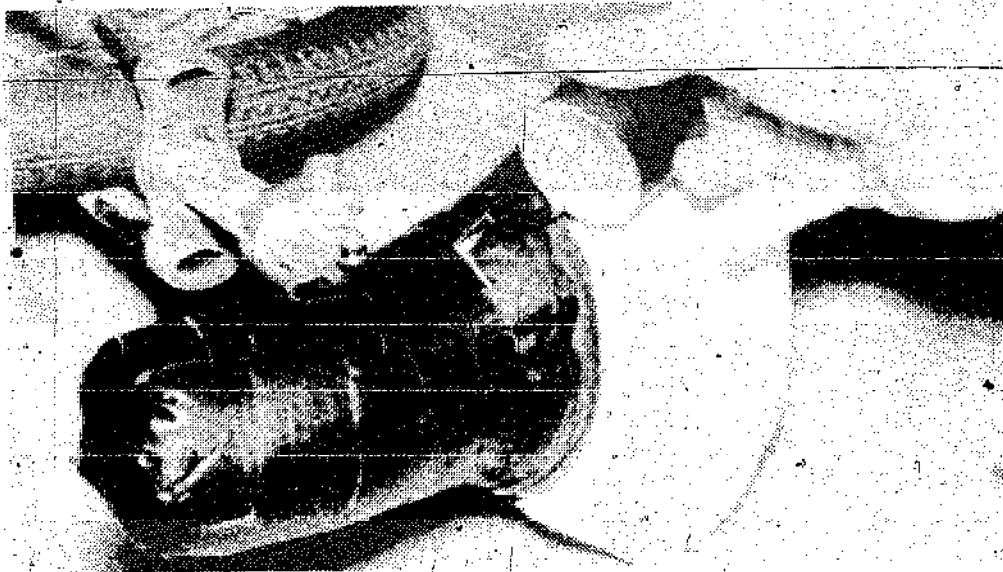

Fig. 15-10. Foam rubber padding is taped to a standard metal-base saddle.

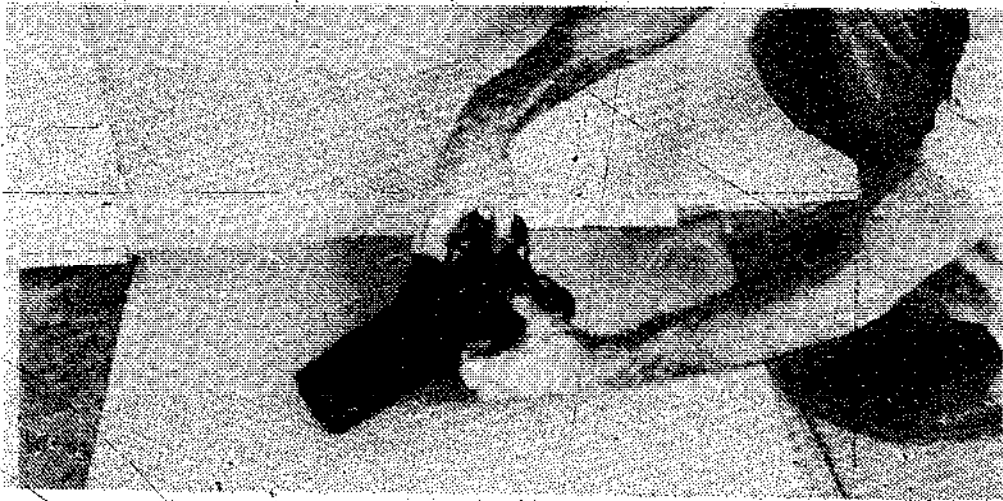

Fig. 15-11. A sewn cover is fitted over the padded saddle.

shown. Split block holders are shown in Fig. 15-12. Still another method is to purchase bearings with holders that bolt to flat plates. These are brazed to the fork as shown in Fig. 15-13.

The remainder of the assembly should be straight forward and not present any special problems. Fig. 15-14 shows the completed

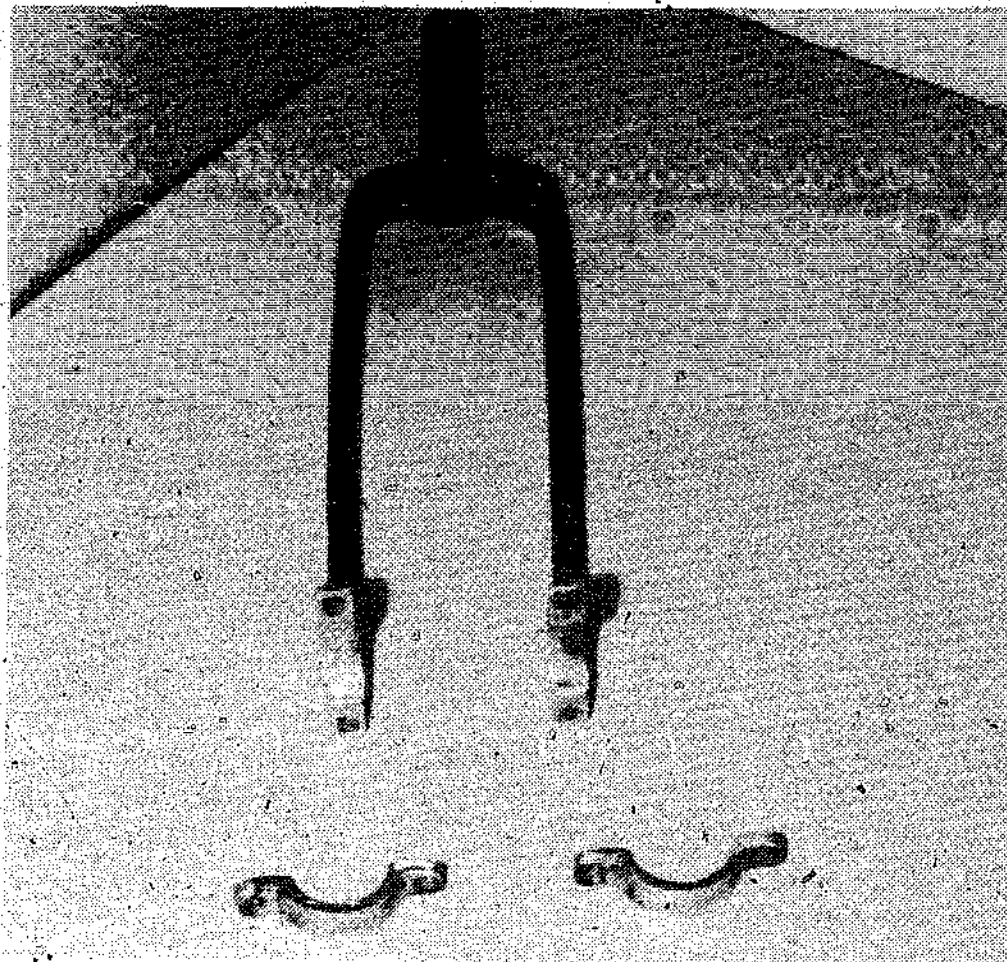

Fig. 15-12. Split-block bearing holders.

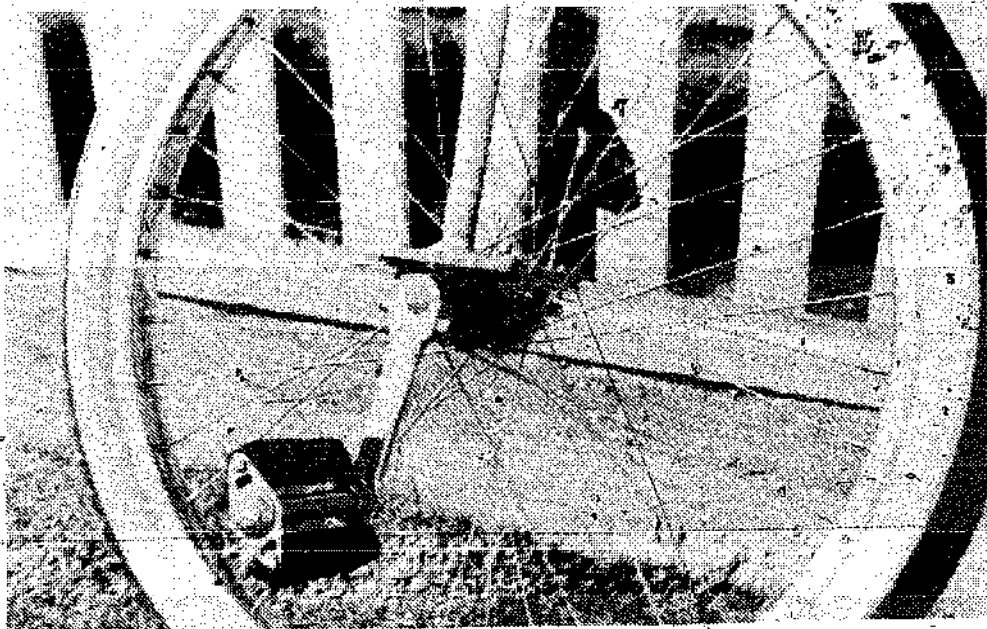

Fig. 15-13. Bearing holders bolted to plates brazed to fork ends.

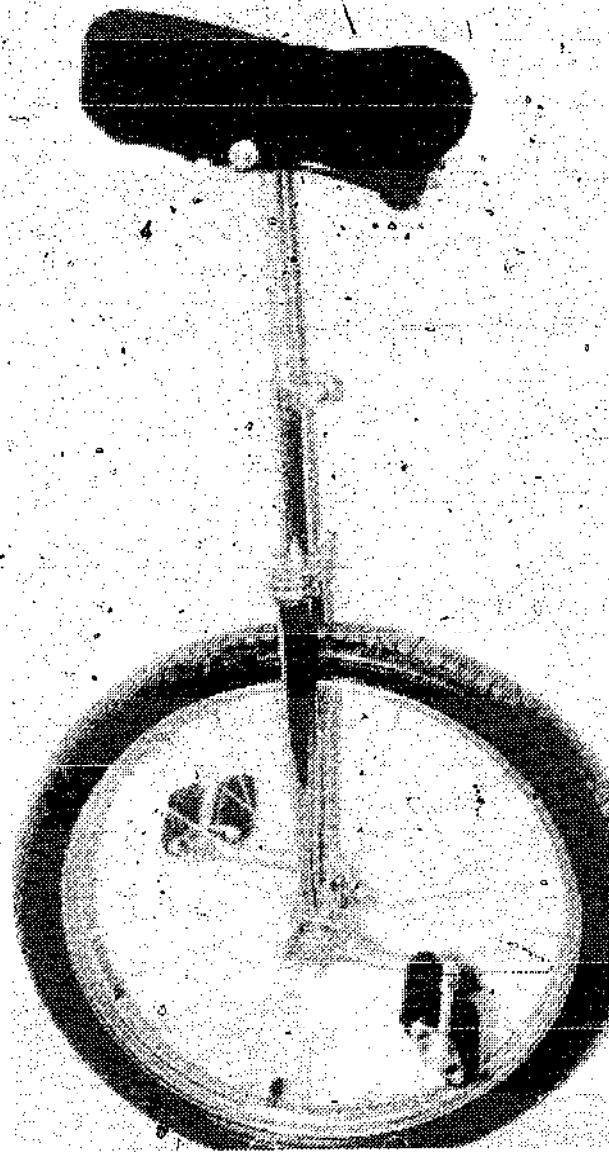

Fig. 15-14. A completed unicycle.

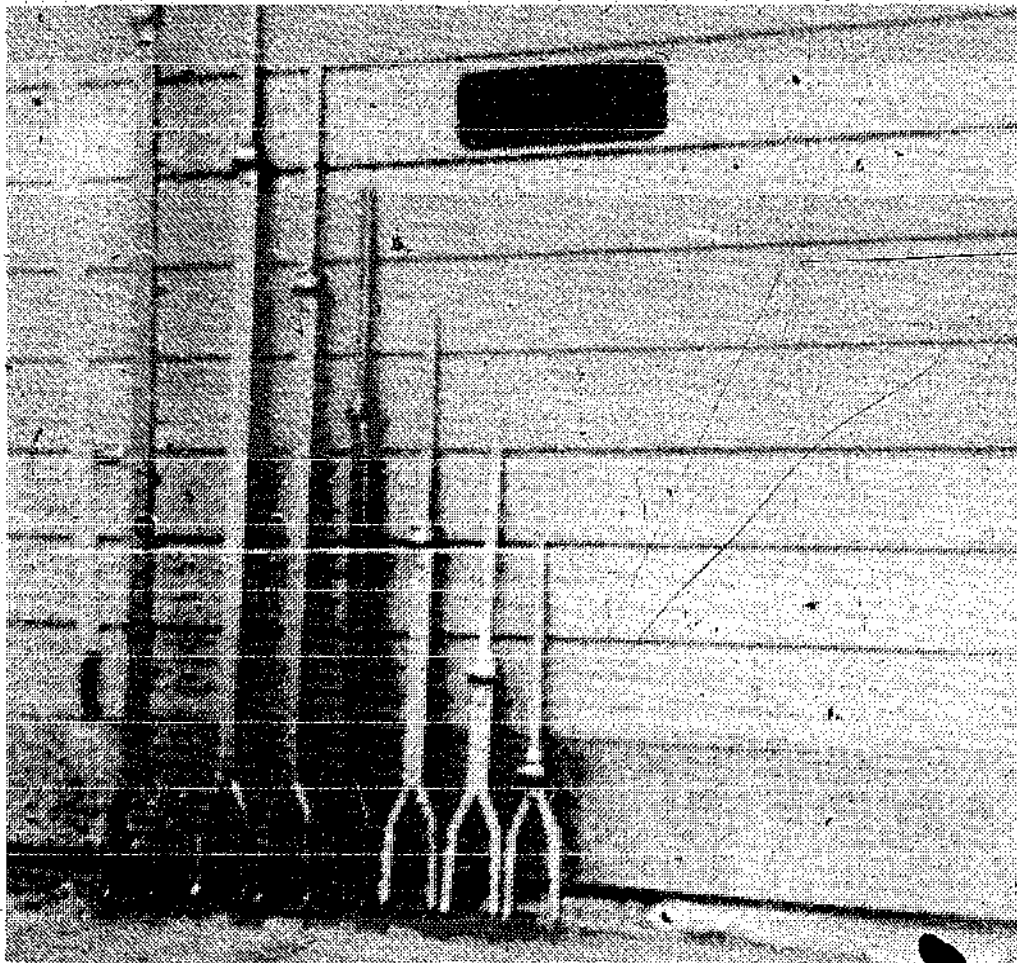

Fig. 15-15. Frames made from one-inch square tubing.

unicycle that I constructed according to the method described above.

The giraffe unicycle wheel has fixed sprocket. This has been described previously. The frame consists of a straight fork, a section of tubing between the fork and the crank hanger which can be cut from an old bicycle frame, and the seat post tube.

A chainwheel is generally replaced with a sprocket to match the one on the wheel for a one-to-one gear ratio, but other sizes will also work. Methods for installing sprockets are given in chapter five.

While most unicycles are constructed of round tubing, Bernard Crandall, Director of the *Pontiac Unicyclist*, uses one-inch square tubing. Two sections from the crank holder down to fork spread out and one piece 20 inches long is above the crank holder for seat tube. Figure 15-15 shows a number of frames of varying sizes constructed in this manner. Figure 15-16 shows completed unicycles, starting with an 18-inch standard unicycle and going up to a 12-footer. All except the smallest are giraffe unicycles.

## CARE MAINTENANCE AND REPAIR OF UNICYCLES

How you ride a unicycle is important. The biggest single factor in unicycling damage, I believe, is dropping them. Learn the technique for catching a unicycle by the saddle when dismounting. Methods for doing this are given later in this chapter.

Curb jumping and other similar stunts will obviously be very hard on unicycles, especially on spokes, pedals, crank arms and axles. I'm not suggesting that you necessarily not do these stunts, only that you realize that they can be hard on the unicycle.

Another important type of unicycle care is when you are not riding. Always dry the unicycle off if it gets damp or wet. Keep the unicycle out of the weather as much as possible. Keep the unicycle clean and waxed.

For maximum tire life, keep the tire inflated to recommended pressure. For stunt riders who tend to do most of their spins with the pedals in a set position, the tire life can be increased by letting the air out of the tire, rotating it to a new position and then inflating it.

Wheel care especially wheel alignment and keeping the spokes tight, is similar to that of a bicycle. Standard unicycles generally have sealed bearings that do not require any additional lubrication. On giraffe unicycles, pedals, wheel hubs, crank sets and chains are maintained in the same way as similar units on bicycles.

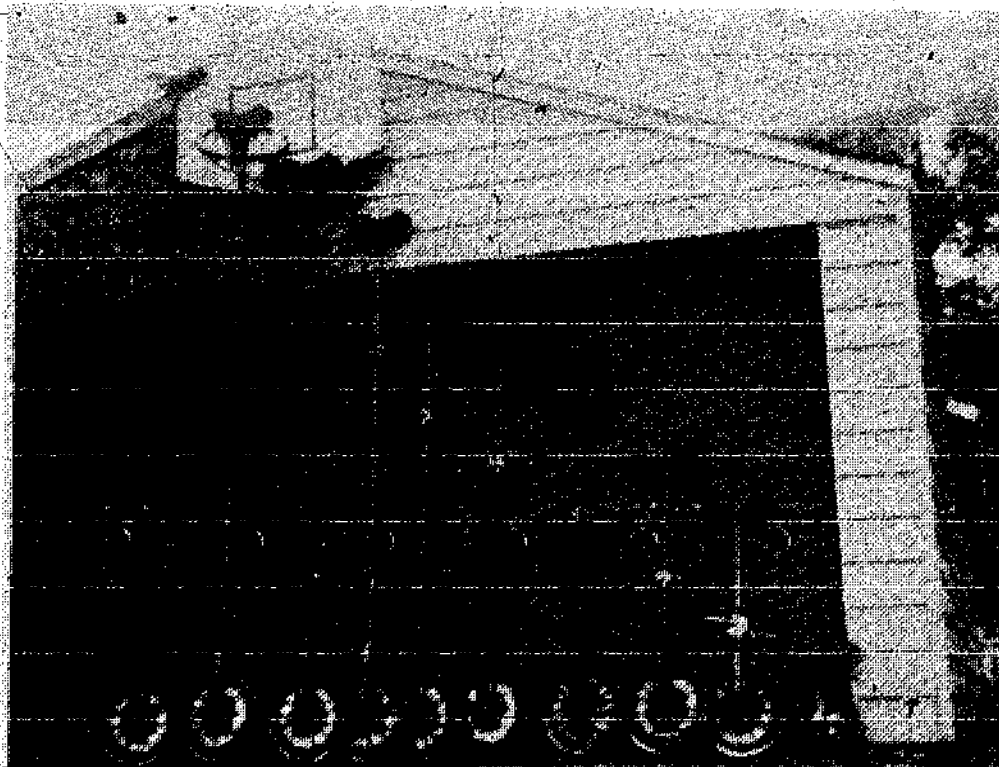

Fig. 15-16. Unicycles built by Bernard Grandall.



Fig. 15-17. Riding an Oxford P21 Hi-Boy Unicycle.

Giraffe unicycles that use fixed-track hubs sometimes have a tendency to slip. One solution is to ride with the sprocket on the left side. This is opposite to that normally used on bicycles. This will cause the greatest pressure, that of mounting, to back thread the sprocket into a tighter hold. Forward riding usually places less tension on the sprocket and the sprocket generally will not slip.

Unicycles are especially vulnerable to theft. Be careful where you leave them and try to store them inside your house or garage whenever possible.

## **LEARNING TO RIDE A UNICYCLE**

I suggest that you learn on a standard unicycle with a 20-inch wheel. Adjust the saddle height so that your legs will be nearly extended at the low points of the pedal cycles. A common mistake is to have the saddle too low. This makes riding much more difficult.

The main skill you will need to learn is forward/backward balance. Once you have mastered this, you will probably automatically be able to keep side-to-side balance and make turns.

The basic idea is to keep the wheel hub under your center of gravity. With good riding posture, this will be approximately above the center of the saddle. When riding forward, both the hub and saddle should move forward at the same speed. If the saddle gets too far forward, adjustment is made by speeding the pedal action. If the saddle falls behind, the correction is to slow or stop the pedal action so the saddle can catch up. Essentially you move the hub by pedaling in the direction the saddle and your center of gravity are falling.

Good posture, with the body held upright and the head and shoulders in line with the unicycle frame, makes riding much easier. Practice this right from the start. Maintain balance by pedal control rather than by moving your upper body or swinging your arms.

To help you learn, I suggest using two helpers. They do not necessarily need to know how to ride. Learn on a hard smooth surface such as concrete, asphalt or wooden floor. On first attempts at mounting, the wheel can be backed against a curb or block of wood. Position the pedals so that stepping on one of them will force the wheel to roll into the curb or block. Stand on the curb or behind the block. Tilt the unicycle back toward you, straddle the saddle and place one foot on the pedal that is back. With your two helpers standing at your sides, hold hands with them and mount the unicycle by stepping the foot from the ground to the free pedal and bringing the saddle up over the wheel.



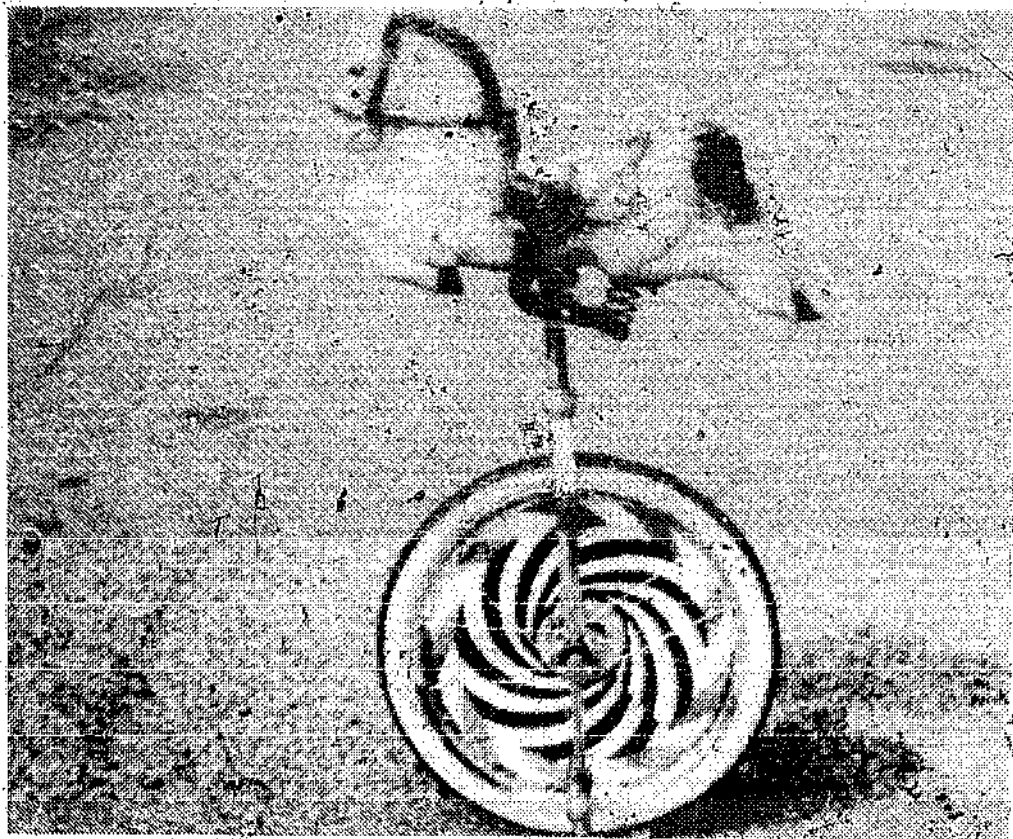

Fig. 15-18. A pony-saddle unicycle.

After mounting, practice riding forward with the two helpers who should remain directly to your sides. They should provide side-to-side support and keep you from twisting and turning so that you can concentrate on the forward/backward balance.

To hasten learning, take a half-pedal revolution at a time and strive to avoid letting the saddle lag behind. At first, it usually works best to freeze the pedals in the horizontal position when you think you have lost balance. If you try to regain your balance by rocking the pedals back and forth it might tend to confuse the helpers.

For dismounting, come to a complete stop with one pedal in the down position. Release one hand from a helper and firmly grasp the saddle in front if you want to come off behind the unicycle and in back if you want to come off forward. Step from the upper-positioned pedal to the ground. Catching the unicycle is extremely important if you are to avoid damaging it.

Continue practicing with the two helpers until the forward/backward balance becomes automatic and only light hand holding with helpers is required. Try to always maintain good posture and use the pedal action for balance correction.

The next step is to ride with only one helper. Gradually use less and less hand pressure until you can solo. How long this will take varies greatly. Some people learn in less than an hour, others

take a week or more of one hour daily practice sessions. The most important thing is that you learn, not how many hours it takes.

After learning basic riding, most people want to go on and learn tricks such as making turns and figure patterns, mounting in the open without help, rocking the unicycle back and forth in one spot, and backwards riding. You might also want to learn to ride giraffe unicycles (Fig. 15-17). For this I suggest that you wait until falling or accidental dismounting no longer happens on a standard unicycle and that you start with a giraffe unicycle that is under six feet tall.



Fig. 15-19. This kangaroo unicycle has adjacent crank arms.



Fig. 15-20. Riding the kangaroo unicycle.

### IDEAS FOR UNICYCLES AND UNICYCLING

In this section, a series of ideas for unicycles and unicycling are presented. These, of course, are only a few of many possibilities and you will probably think of others. The purpose here is to stimulate your thinking.

**Pony-Saddle Unicycle.** The pony-saddle unicycle shown in Fig. 15-18 is part of William M. Jenack's extensive collection of novelty and specialty cycles. Construction is basically the replacement of the saddle on a standard unicycle with a pony, such as the type used on amusement park rides. These can sometimes be purchased at flea markets and junk yards.

**Kangaroo Unicycle.** The crank arms are set adjacent to each other as shown in Fig. 15-19. A standard unicycle can be converted by removing one crank arm, filing a cotterpin notch opposite the original one on the axle and then reinstalling the crank arm in the new position. John Jenack is shown riding a kangaroo unicycle in Fig. 15-20 and Fig. 15-21. The difficult part is getting the pedals over the top part or hump of the pedal cycles.

**Big-Wheel Unicycles.** The big-wheel unicycle shown in Fig. 15-22 was constructed by Bernard Crandell. It has a 44-inch, 46-inch with rubber tire, wooden buggy wheel. The wheel was made of oak by the *Schrock Buggy Works* in Millersburg, Ohio.

Figure 15-23 shows 14-year-old Liz Axenroth riding a unicycle with a 42-inch wheel. This is the unicycle that Wally Watts rode across Canada in 1973. Wally recently rode a similar unicycle with a 43-inch wheel around the world.

**Riding With Feet On Wheel.** John Held adds a new dimension to unicycling by riding with his feet working against the wheel

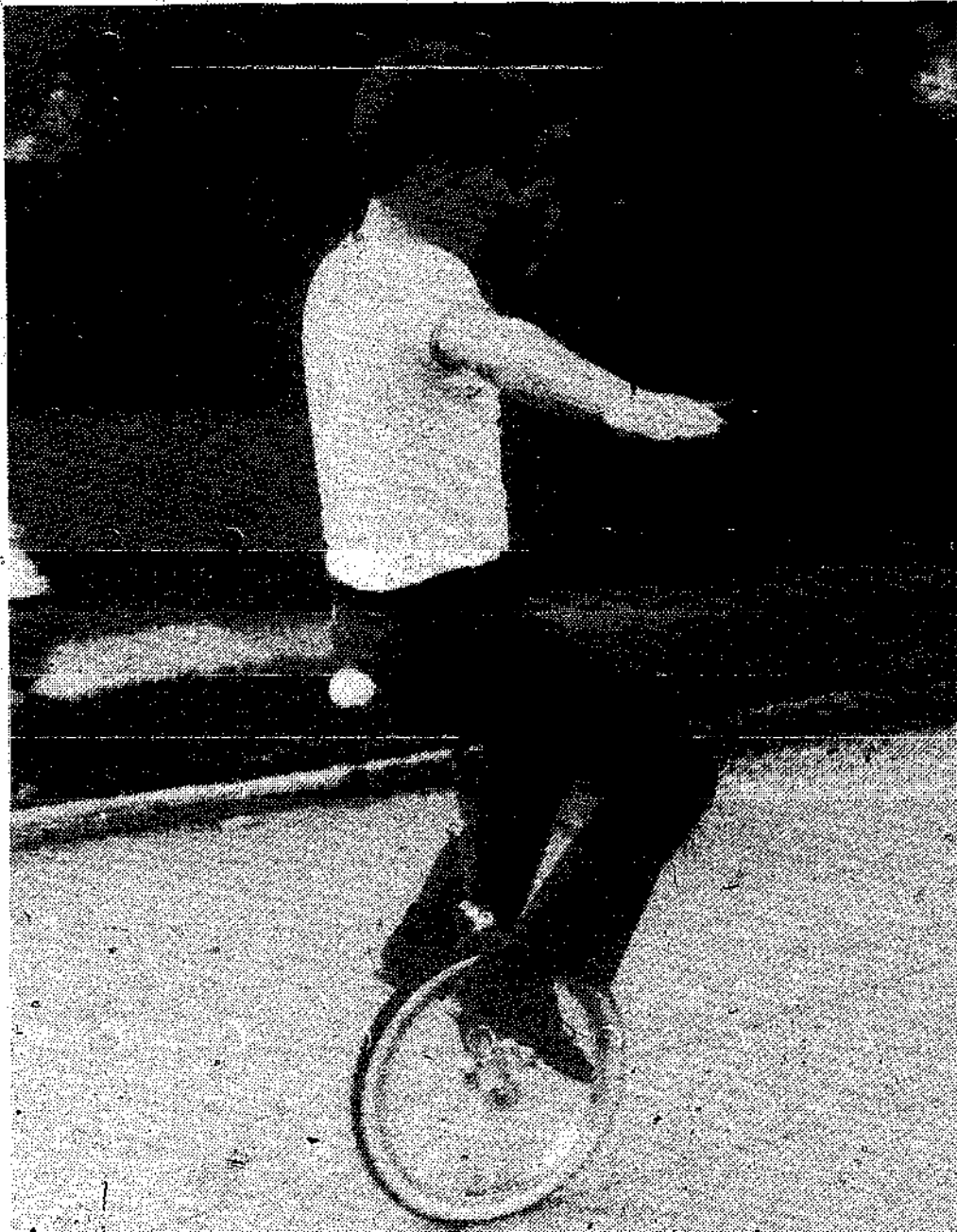

Fig. 15-21. The difficult part is getting pedals over the top of the pedal cycles.

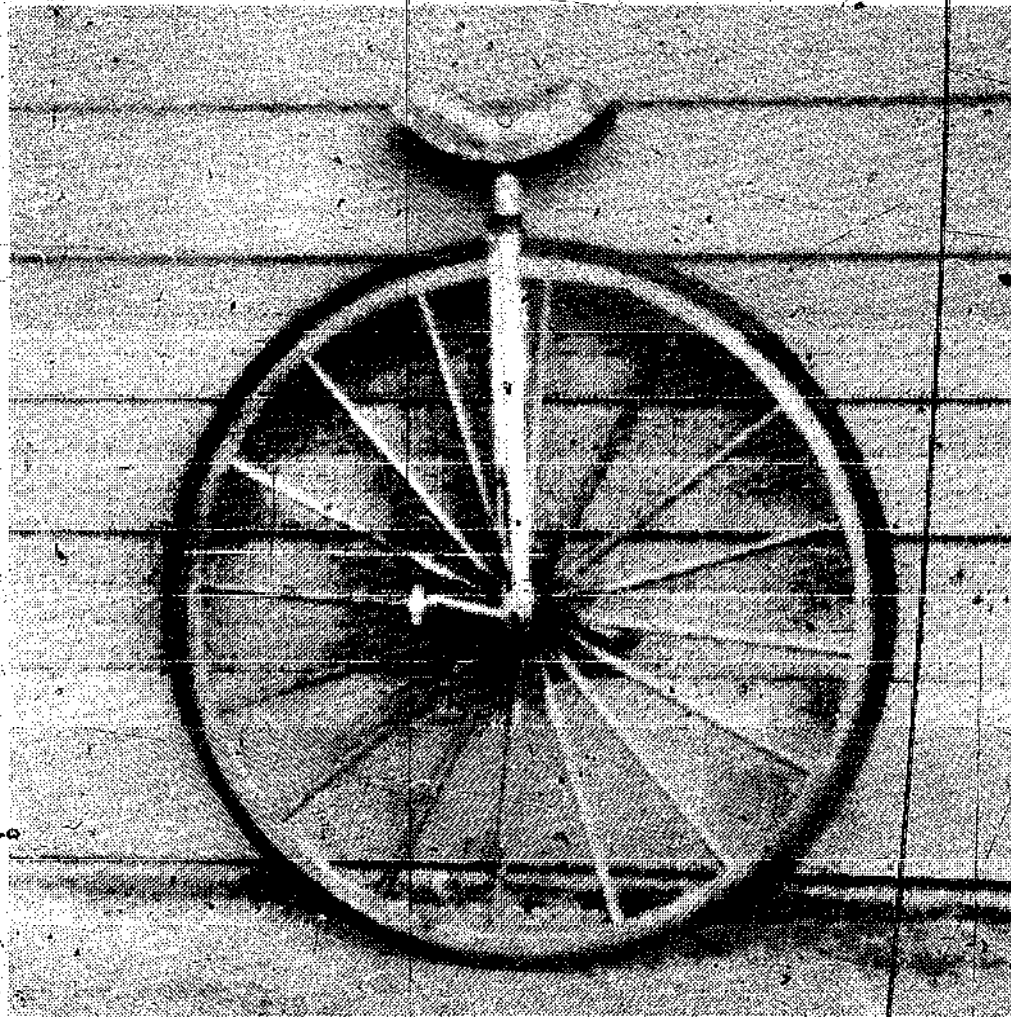

Fig. 15-22. A big-wheel unicycle constructed from a buggy wheel.

without the use of the pedals as shown in Fig. 15-24. He rides long distances both forward and backward in this manner.

**Ultimate Wheels.** A very difficult feat is to ride the wheel from a standard unicycle with crank arms and pedals, but no fork or saddle. Somewhat easier is this double-wheel model (Fig. 15-25) built by William M. Jenack. Figure 15-26 shows the cycle in operation.

**Tandem Unicycle.** This tandem unicycle (Fig. 15-27) is used by the *Great Y Circus* in Redlands, California. It is ridden in a straight line.

**Juggling While Riding a Unicycle.** Juggling while riding a unicycle is fun and challenging. Figure 15-28 shows Brian Martin, age 14, juggling three balls while riding a giraffe unicycle.

**Novelty Giraffe Unicycles.** Figure 15-29 shows a number of novelty giraffe unicycles used by the *Great Y Circus*.

Kit Summers is shown in Fig. 15-30 riding a giraffe unicycle with a small wheel. He constructed the unicycle himself. He has also

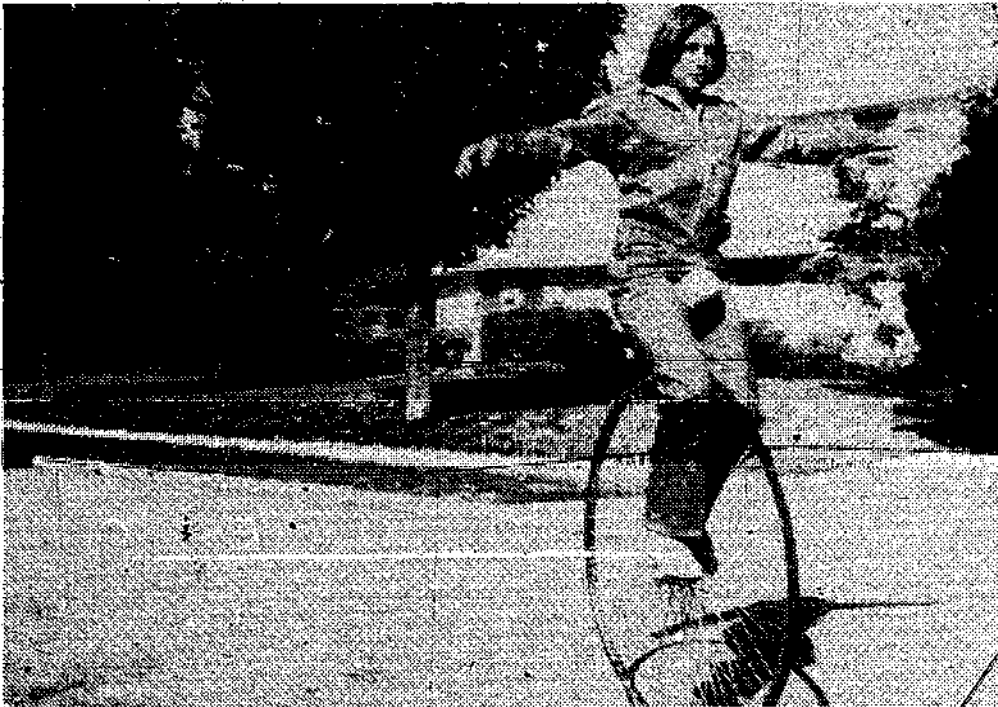

Fig. 15-23. Riding a unicycle with 42-inch wheel.



Fig. 15-24. Riding a unicycle by using feet on the wheel.



Fig. 15-25. Double-wheel ultimate cycle.



Fig. 15-26. Riding a double-wheel ultimate cycle.

built dozens of other specialty and novelty cycles. Figure 15-31 shows Dale Daniels of the *Great Y Circus* riding a mini-wheeled giraffe unicycle.

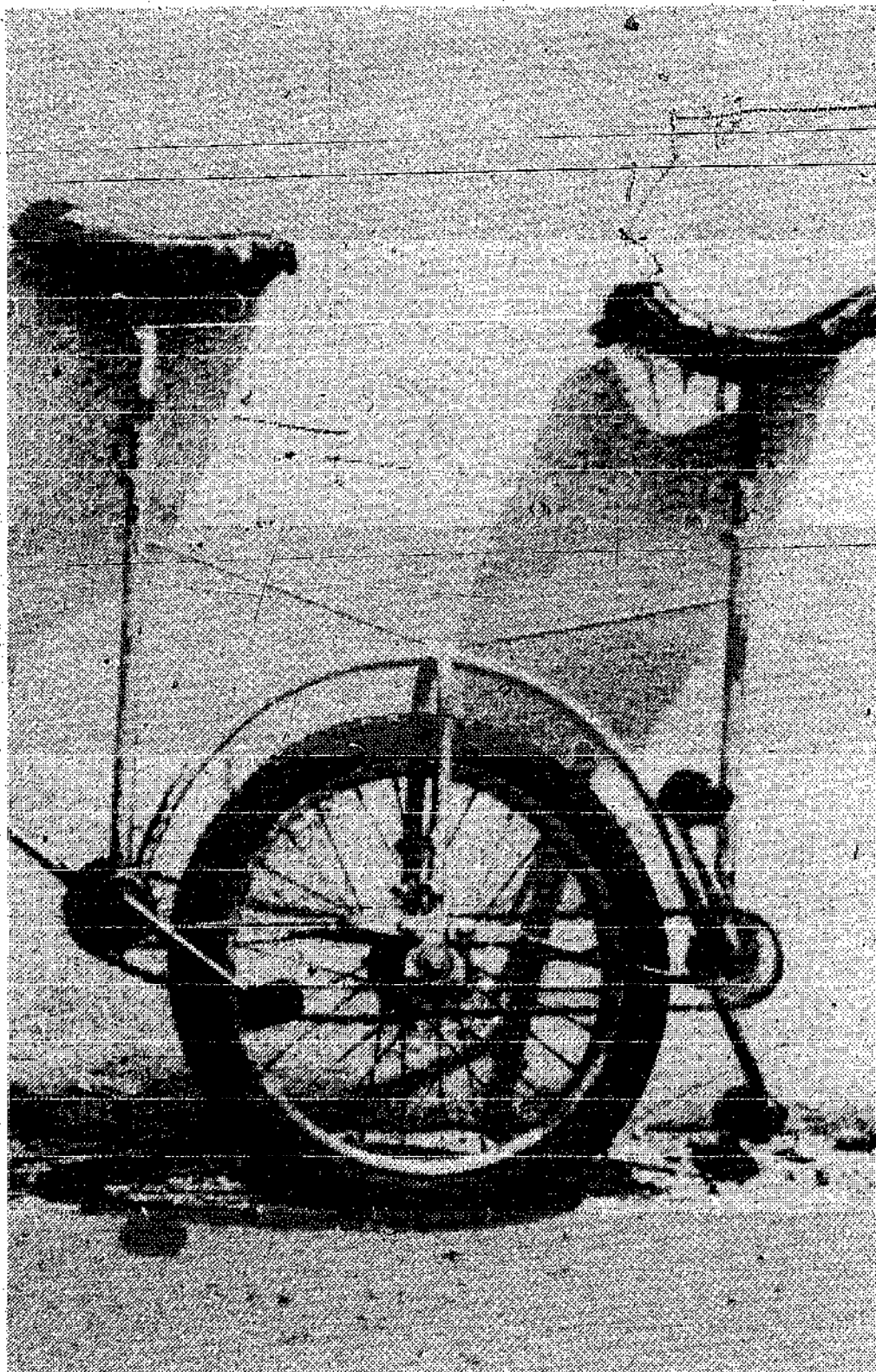

Fig. 15-27. A tandem unicycle.



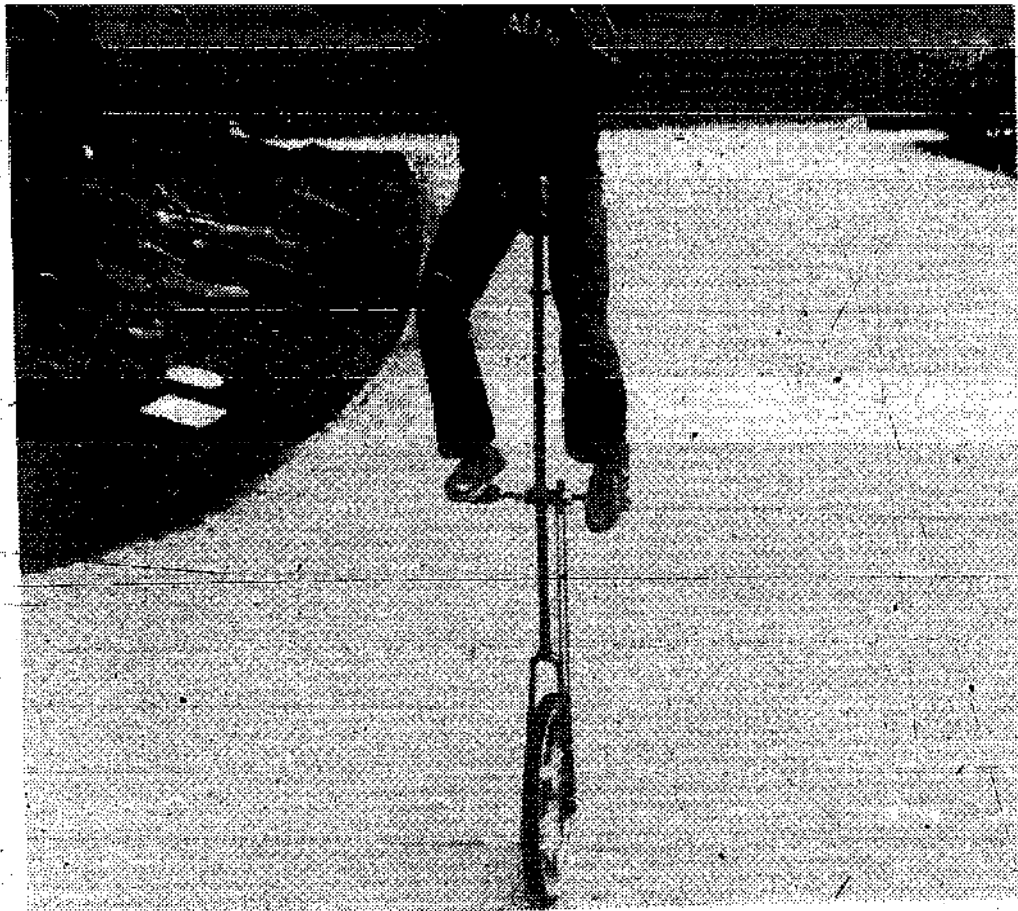

Fig. 15-28. Juggling three balls while riding a giraffe unicycle.

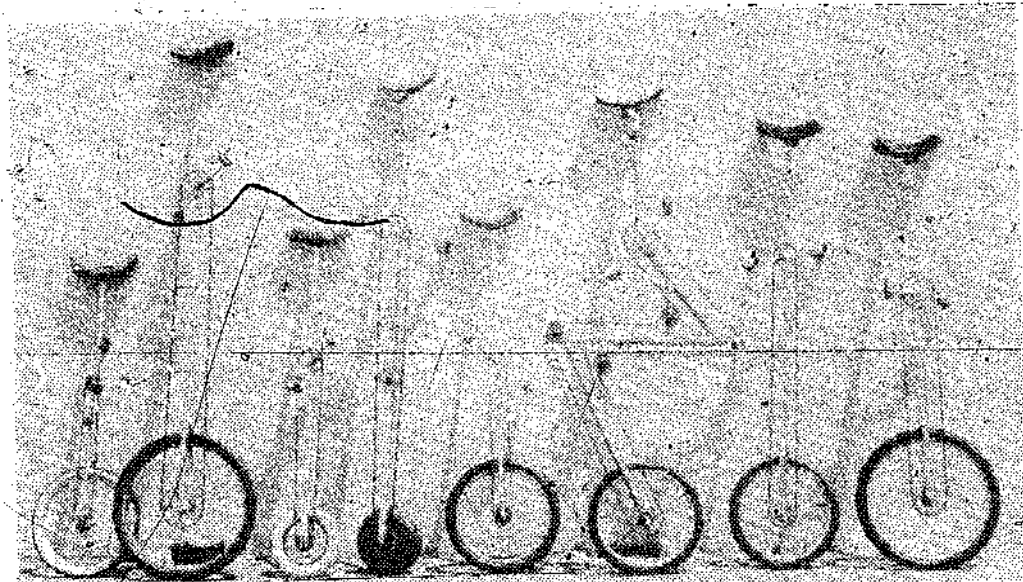

Fig. 15-29. Novelty giraffe unicycles used by Great Y Circus.

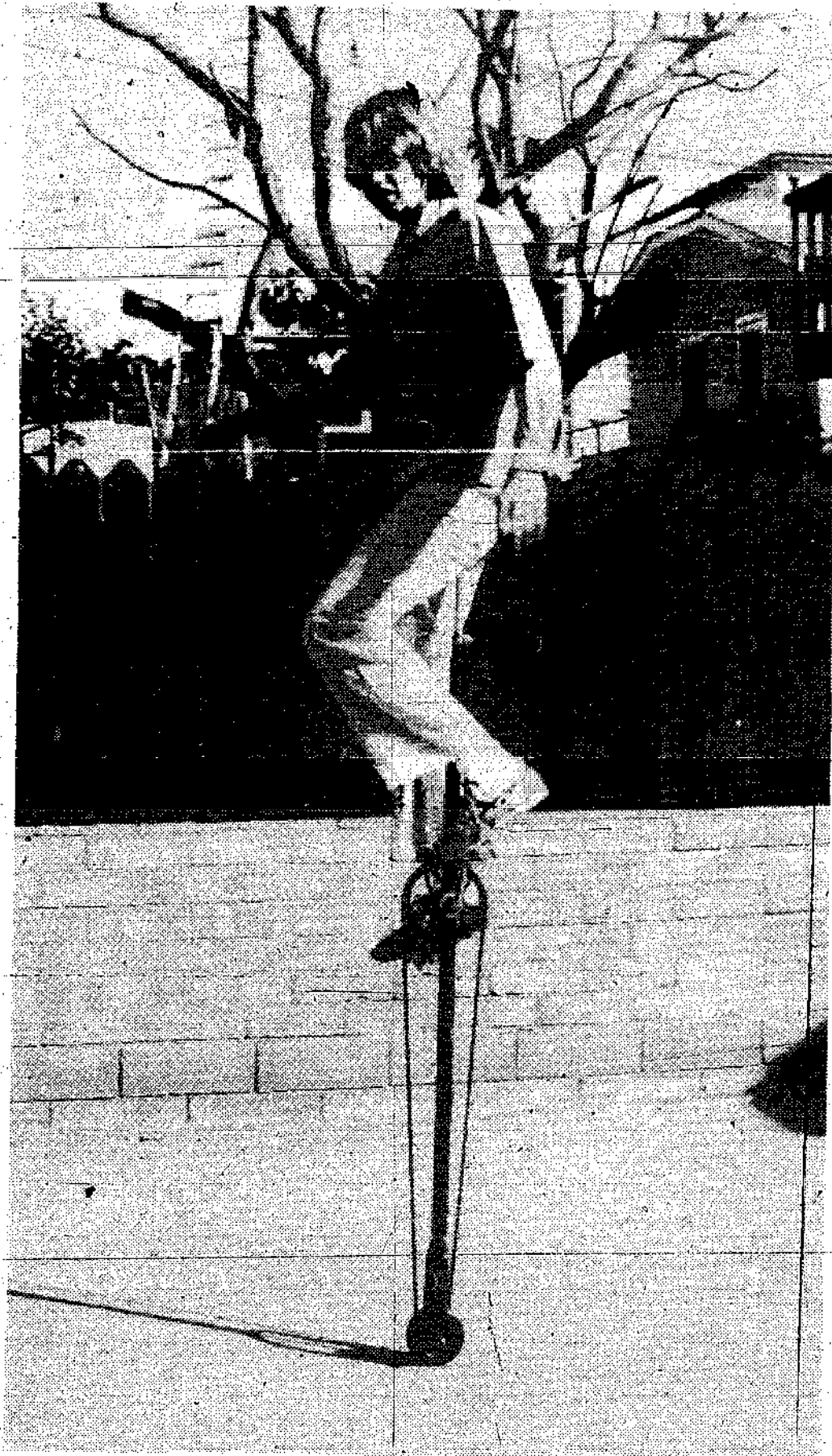

Fig. 15-30. Riding a giraffe unicycle with a small wheel.

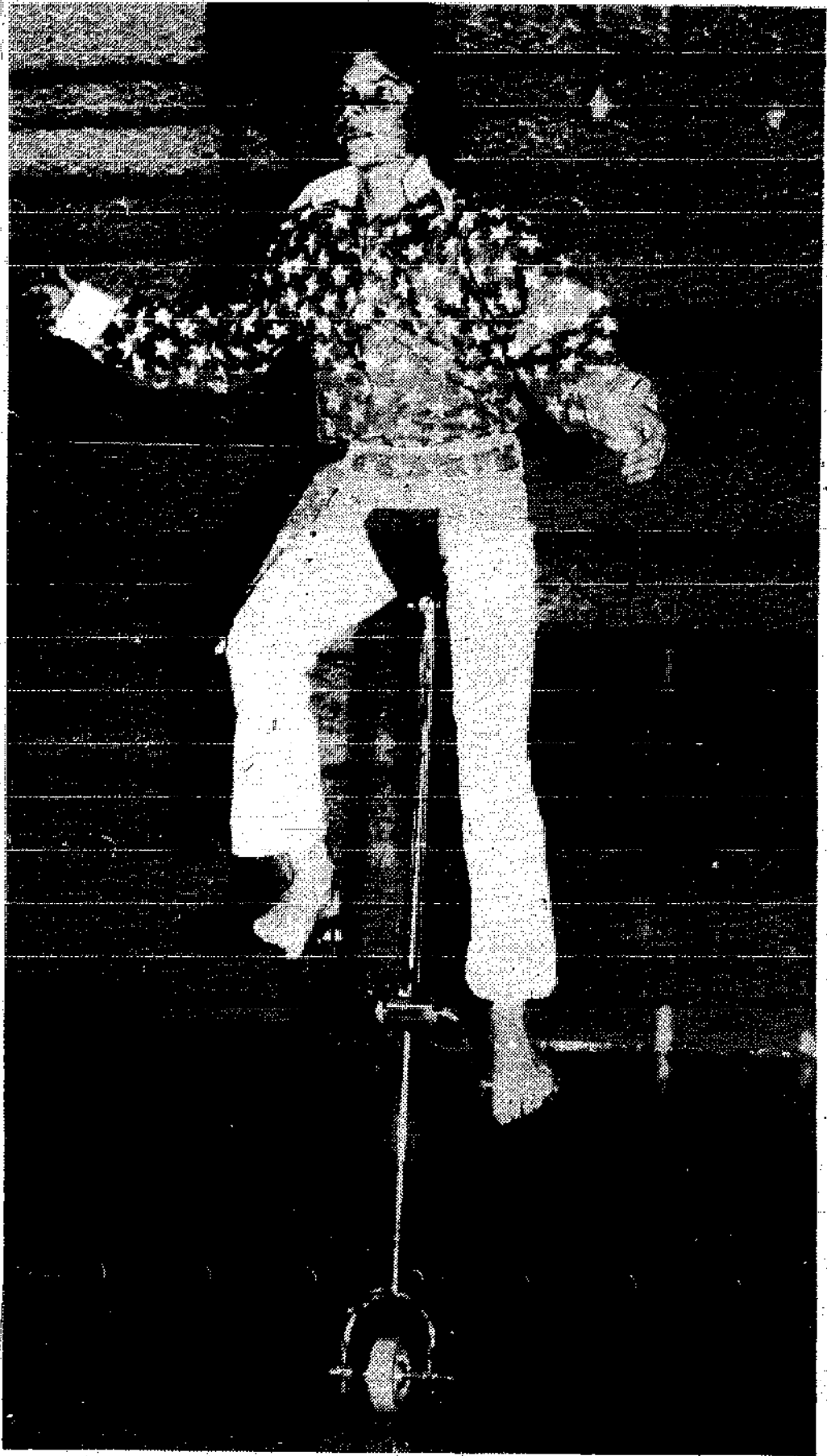

Fig. 15-31. Riding a mini-wheeled giraffe.

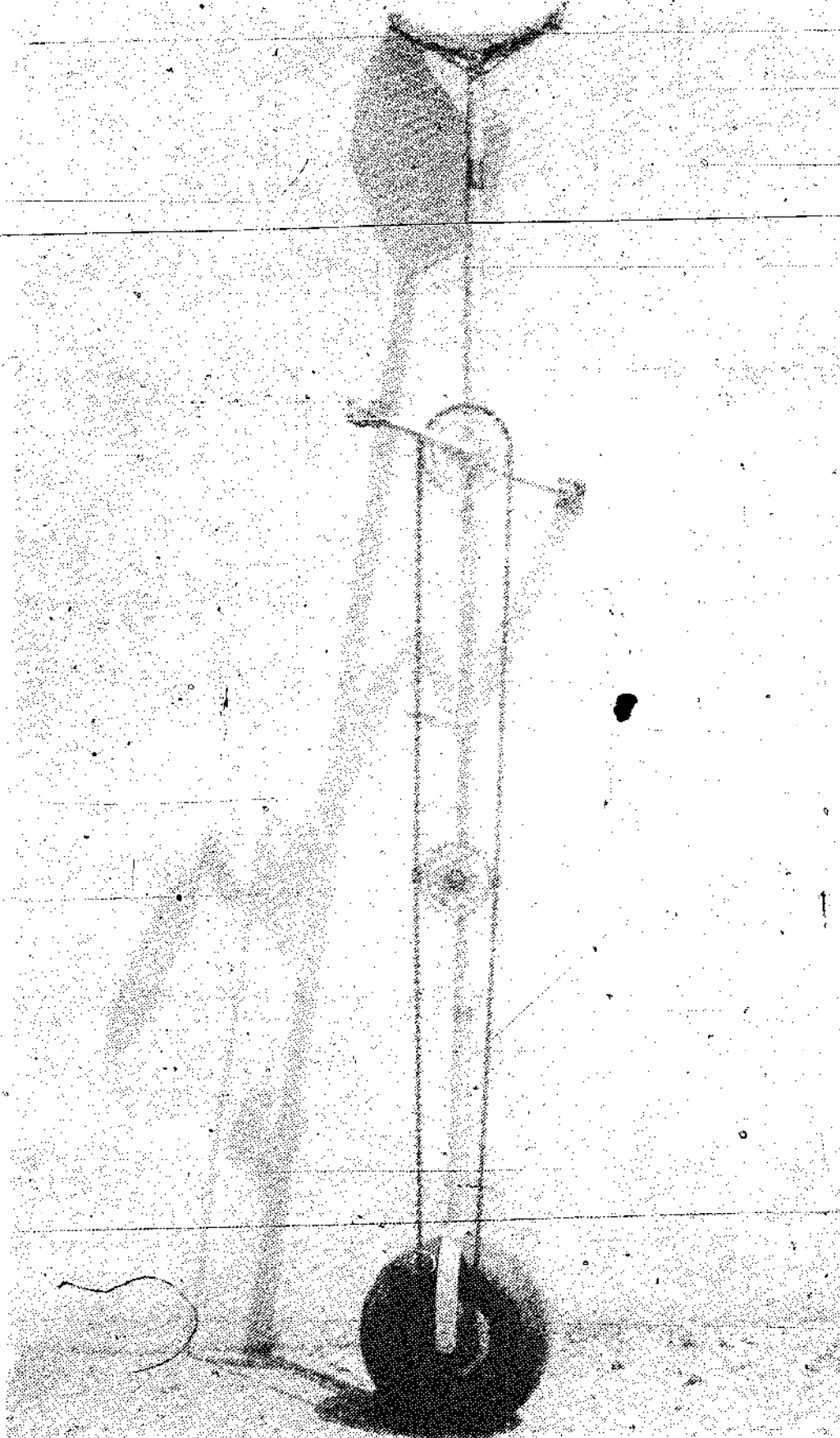

Fig. 15-32. A giraffe unicycle with an airplane wheel.

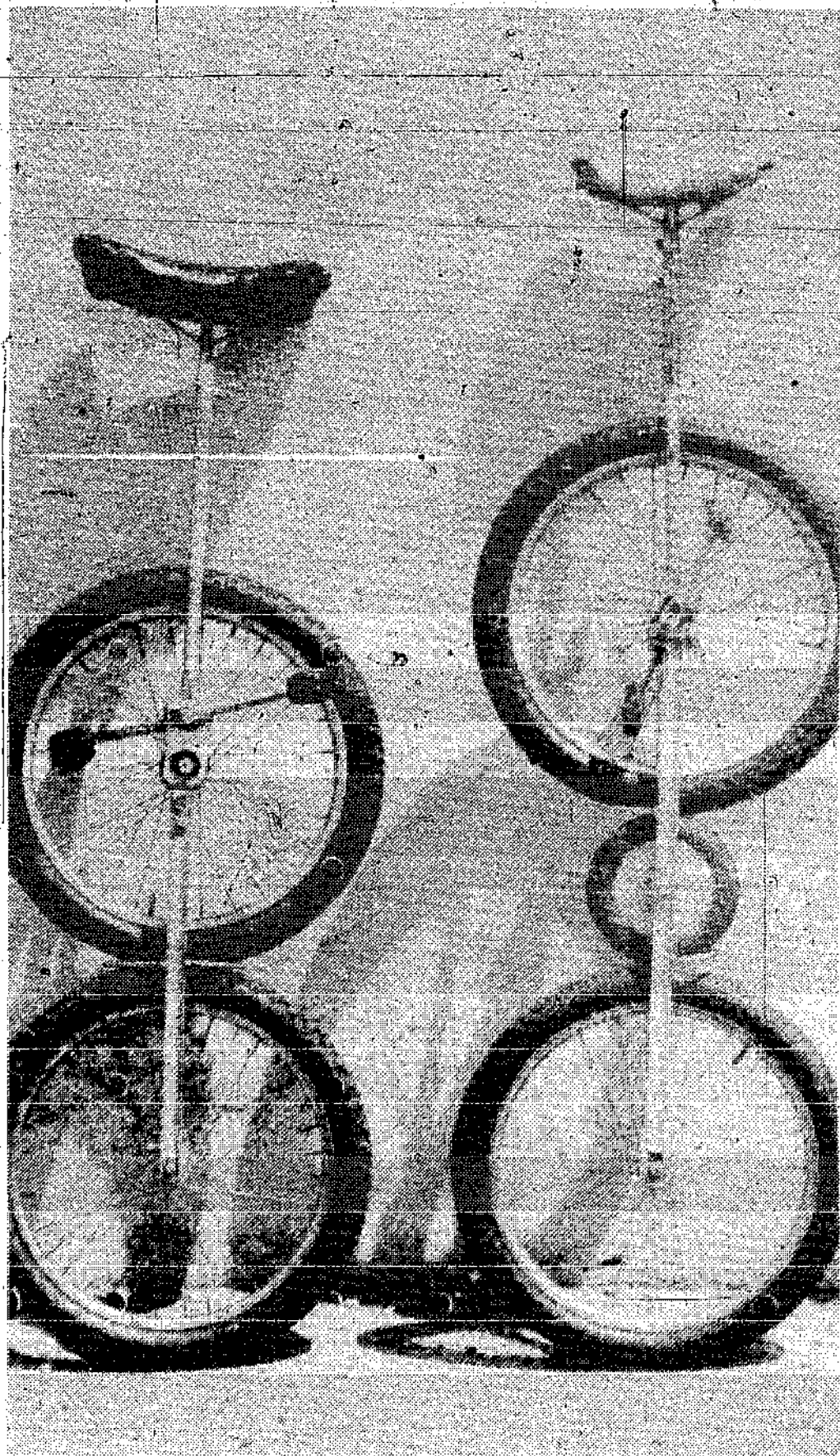

Fig. 15-33. Giraffe unicycles with more than one wheel that work by tire pressure. The one on the left has a reverse gear on top with the cranks.

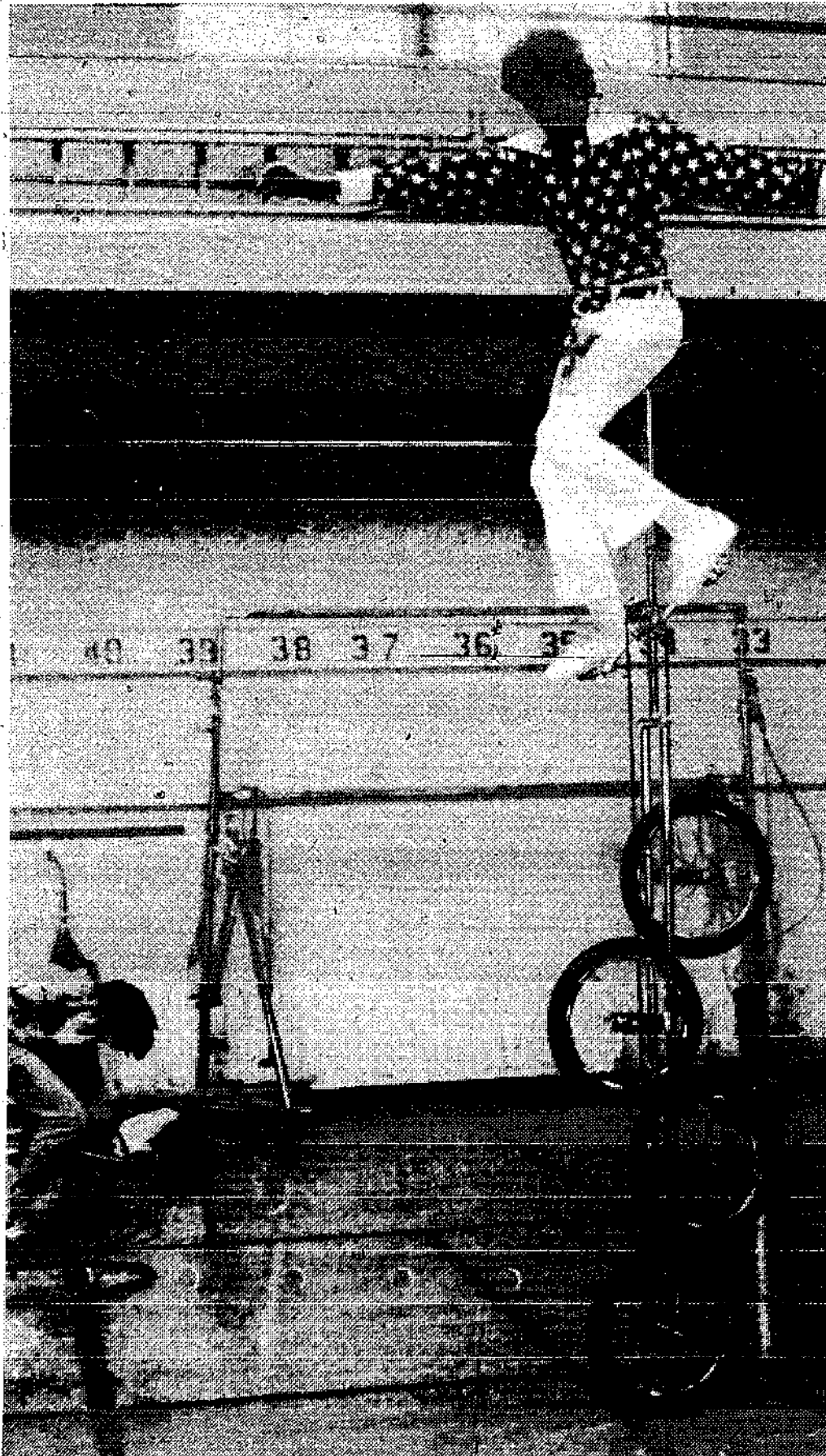

Fig. 15-34. A giraffe unicycle with more than one wheel with chain drive.

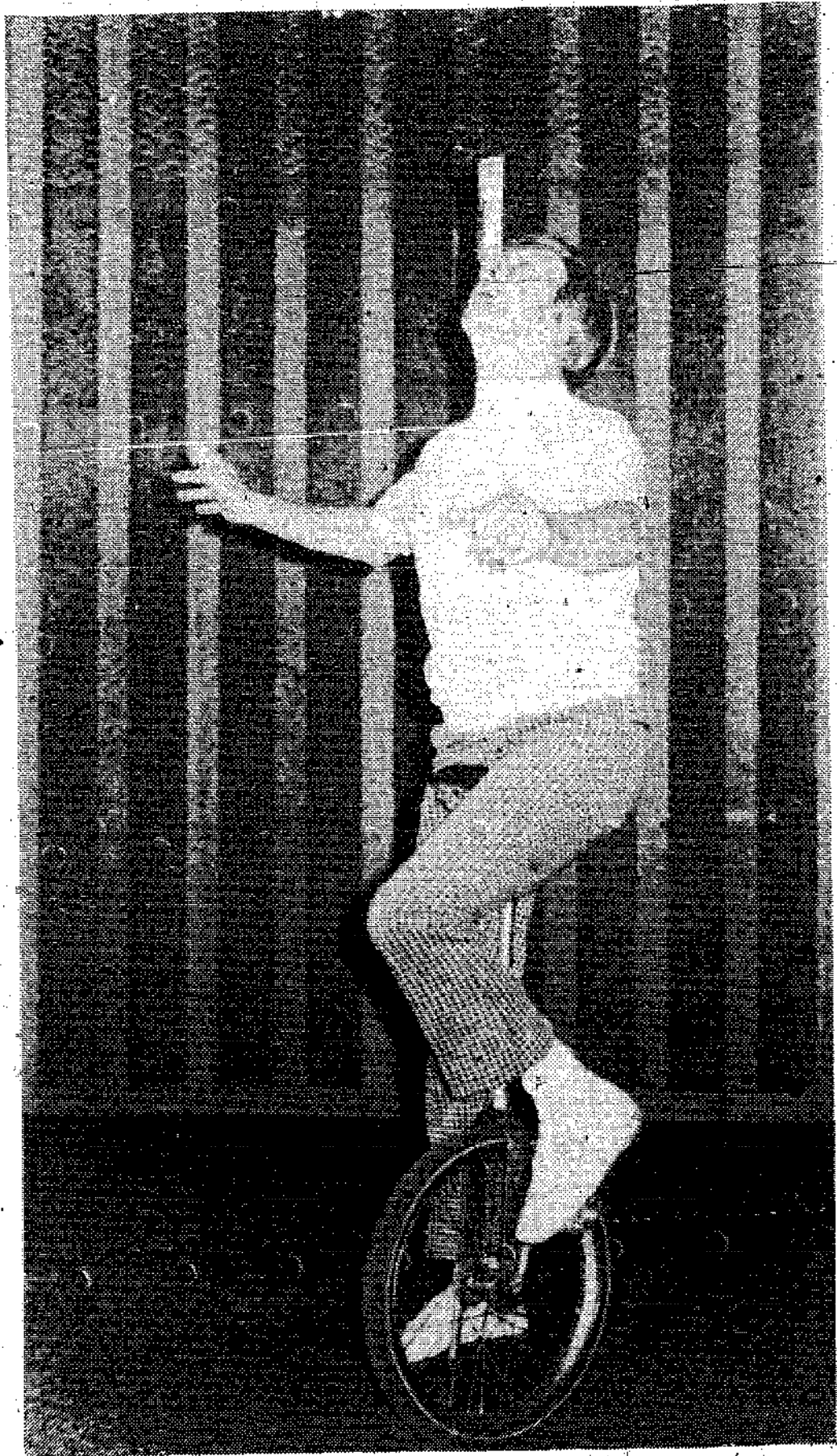

Fig. 15-35. Jim Dandy performing "The Minimum."

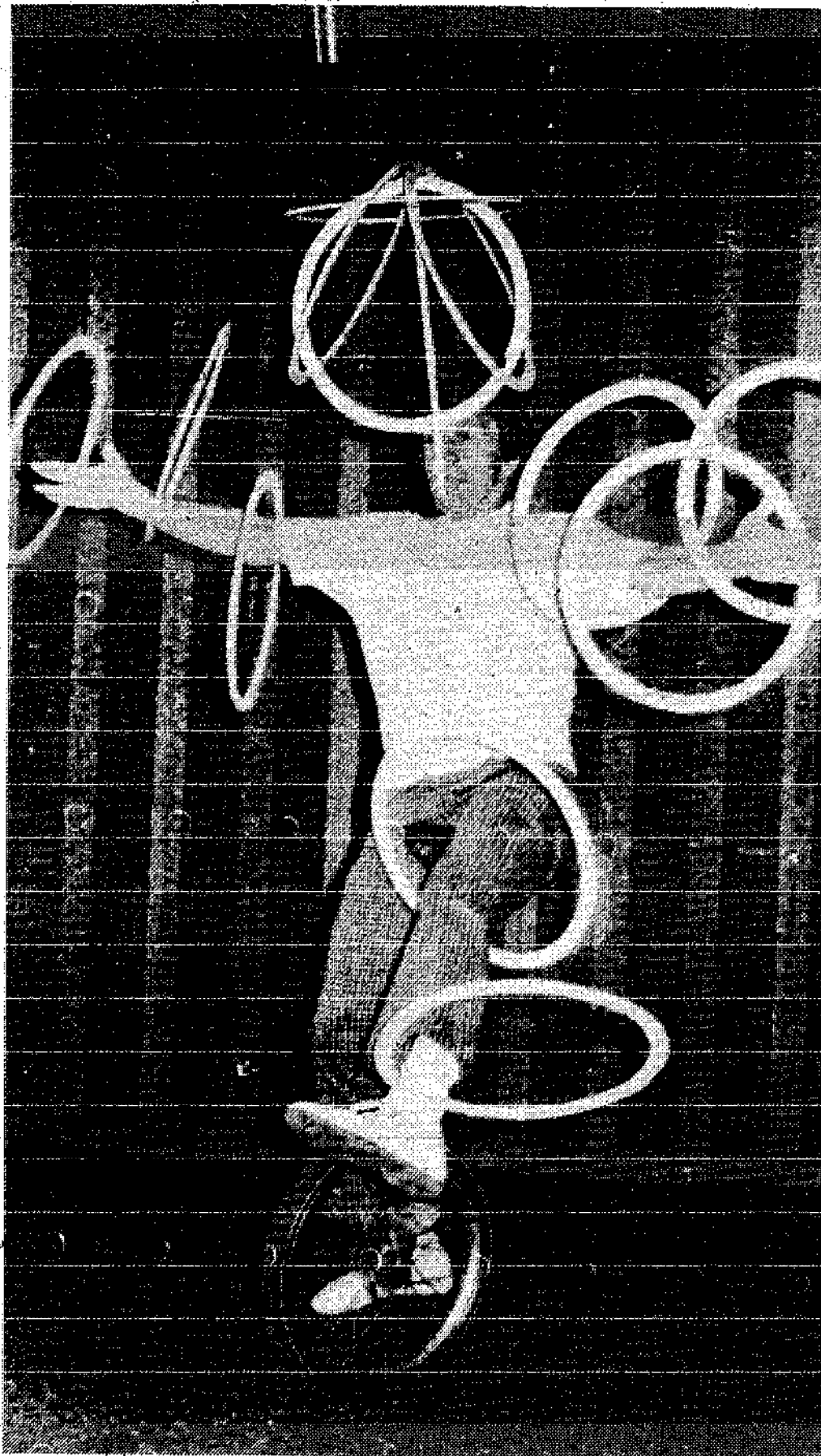

Fig. 15-36. Jim Dandy performing "The Maximum."



A giraffe with an airplane tire is shown in Fig. 15-32. Figure 15-33 and Fig. 15-34 show giraffe unicycles with more than one wheel.

**"The Minimum"** and **"The Maximum."** Jim Dandy, a professional performer, is shown at age 70 performing what he calls *The Minimum* (Fig. 15-35) and *The Maximum* (Fig. 15-36). No gimmicks are used in performing these unbelievable feats.

## Further Ideas for Novelty and Specialty Cycles

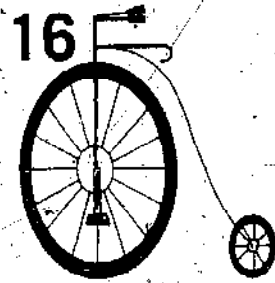

The purpose here is to give ideas for other types of specialty and novelty cycles. These should serve to give you ideas for building similar cycles and even to go on to originals.

### MINIATURE BICYCLES

I have seen a number of professional acts that announce "the smallest bicycle in the world." Obviously, they can't all be riding the smallest bicycle unless there are a lot of them around of identical size.

There are two basic types of miniature bikes. The smallest are ridden standing (in a squat position) on the pedals without the use of a saddle. There are somewhat larger models where the rider uses a saddle such as the one shown in Fig. 16-1.

Building these tiny bicycles requires a thorough knowledge of metals and machining techniques. These bicycles must not only be small, but also sturdy. This is not an easy combination to achieve.

### WALKING MACHINES

A number of pedal-driven walking machines have been designed and built. The idea is that the rider pedals and the machine walks. Figure 16-2 is a sketch made by Chas. R. Siple, of a pedal-driven walking machine constructed by Alvin Drysdale. The cycle is now on display in the private cycle museum of Dave Metz in Freehold, New Jersey.



Fig. 16-1. John Jenack riding miniature bicycle.

### **RECUMBENT CYCLES**

Bicycles for reclined sitting are shown in Fig. 16-3 through Fig. 16-5. Figure 16-6 shows a tricycle machine with a front wheel drive. Recumbent bikes have several advantages over standard bicycles:

- Breathing is easier since the rider is not in a crouched position.
- Sitting on a recumbent bike is easier and more comfortable than sitting on a standard bicycle.

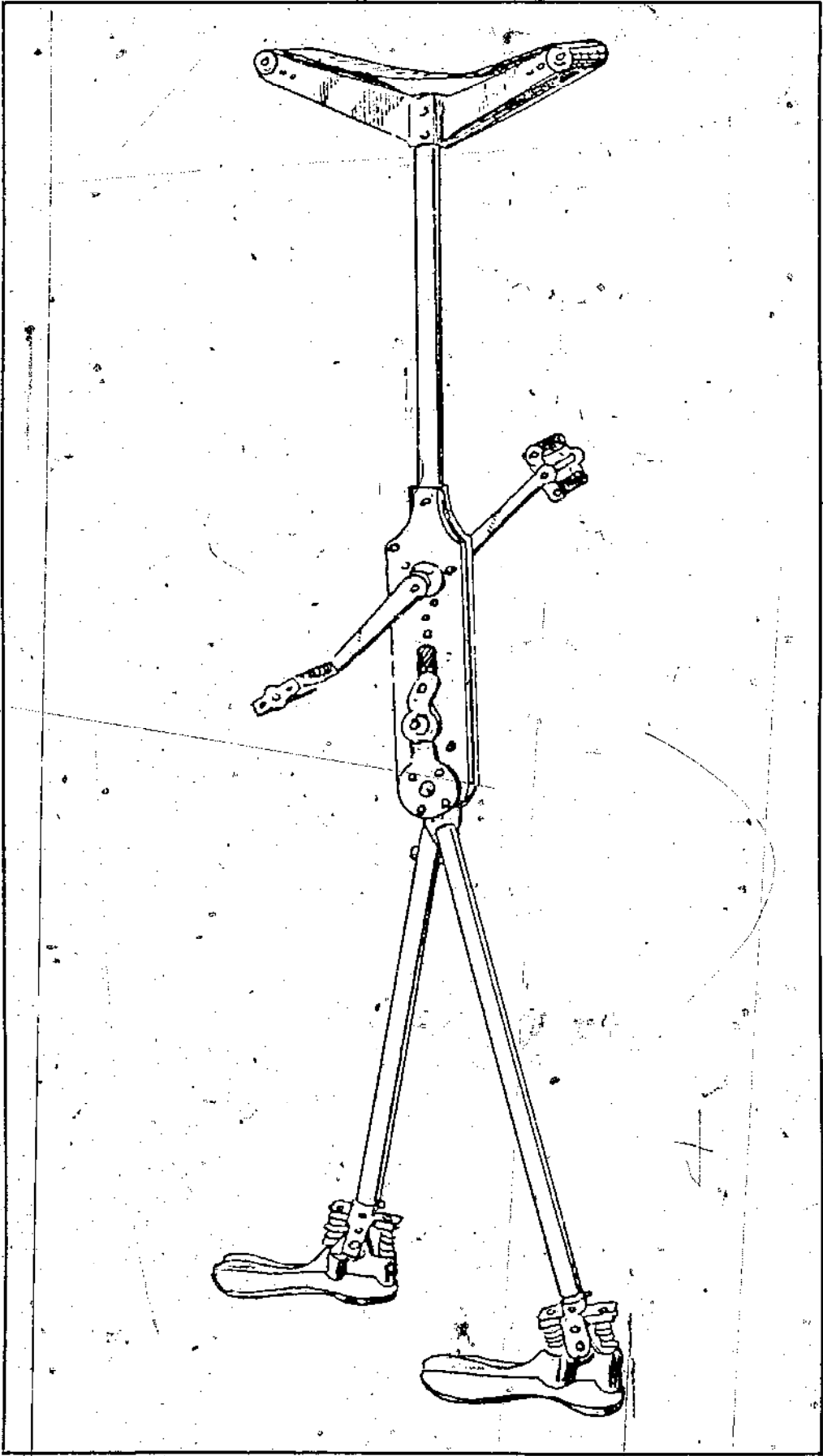

Fig. 16-2. Sketch of a walking machine.

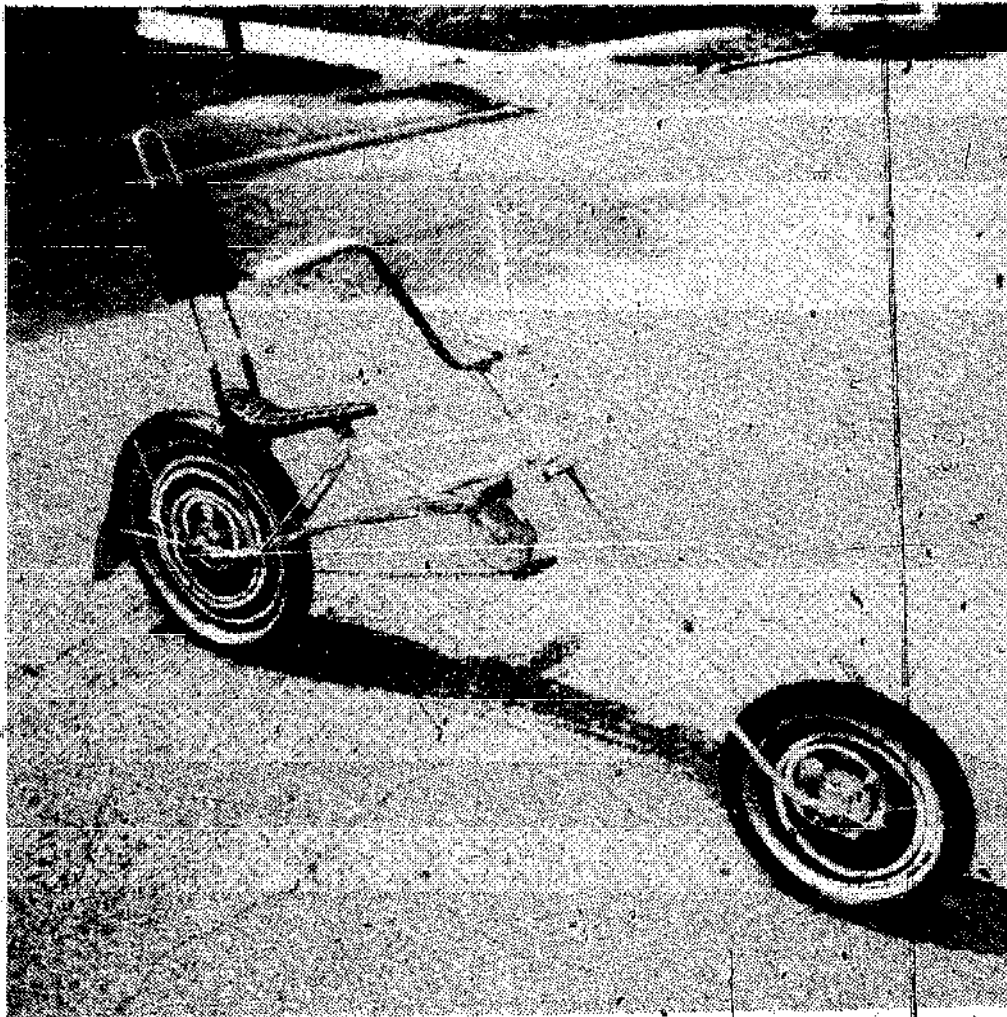

Fig. 16-3. Bicycle for reclined sitting.

—Powering a recumbent bike comes from the rider's hips. Therefore, the rider's arm and back muscles can remain relaxed.

—Catching pedals on the ground or curb when the rider corners is eliminated with a recumbent bike.

—Braking is smoother and the rider will not be dumped over the handlebars if a sudden stop is required.

### **PEDAL CARS**

A number of adult pedal cars have been designed and constructed. These are frequently made for two passengers so that both can pedal at the same time. Some are open, but others have enclosed shells.

### **WATER PEDAL CYCLES**

Various types of boats, especially small pontoon models, have been pedal powered—usually by means of paddle wheels.



Fig. 16-4. Riding a bike in the reclined sitting position.

### **FLYING PEDAL CYCLES**

With the limited amount of horsepower—usually about one and one-half horsepower maximum for brief periods of time, much less sustained over a longer period of time—it is a real challenge to try to

design and build a pedal power flying machine that is heavier than air.

A number of pedal-powered craft have gotten off the ground. The *Gossamer Condor* completed a flight around a special course to win the Kremer Prize of 50,000 pounds sterling for its designer. The *Gossamer Albatross*, made by the same designer, has already completed a flight of 14 miles and also completed a flight across the English Channel to win an even larger prize.

### **RAILROAD BICYCLES**

One way to make use of the thousands of miles of unused railroad tracks in the United States is to adapt a standard bicycle so that it can be run on railroad tracks. Figure 16-7 and Fig. 16-8 illustrate two such designs.

This device should never be used on railroad tracks where safety or legal problems could occur.



Fig. 16-5. Bicycle for reclined sitting with a small front wheel.

Fig. 16-6. This tricycle for reclined sitting has front-wheel chain drive.

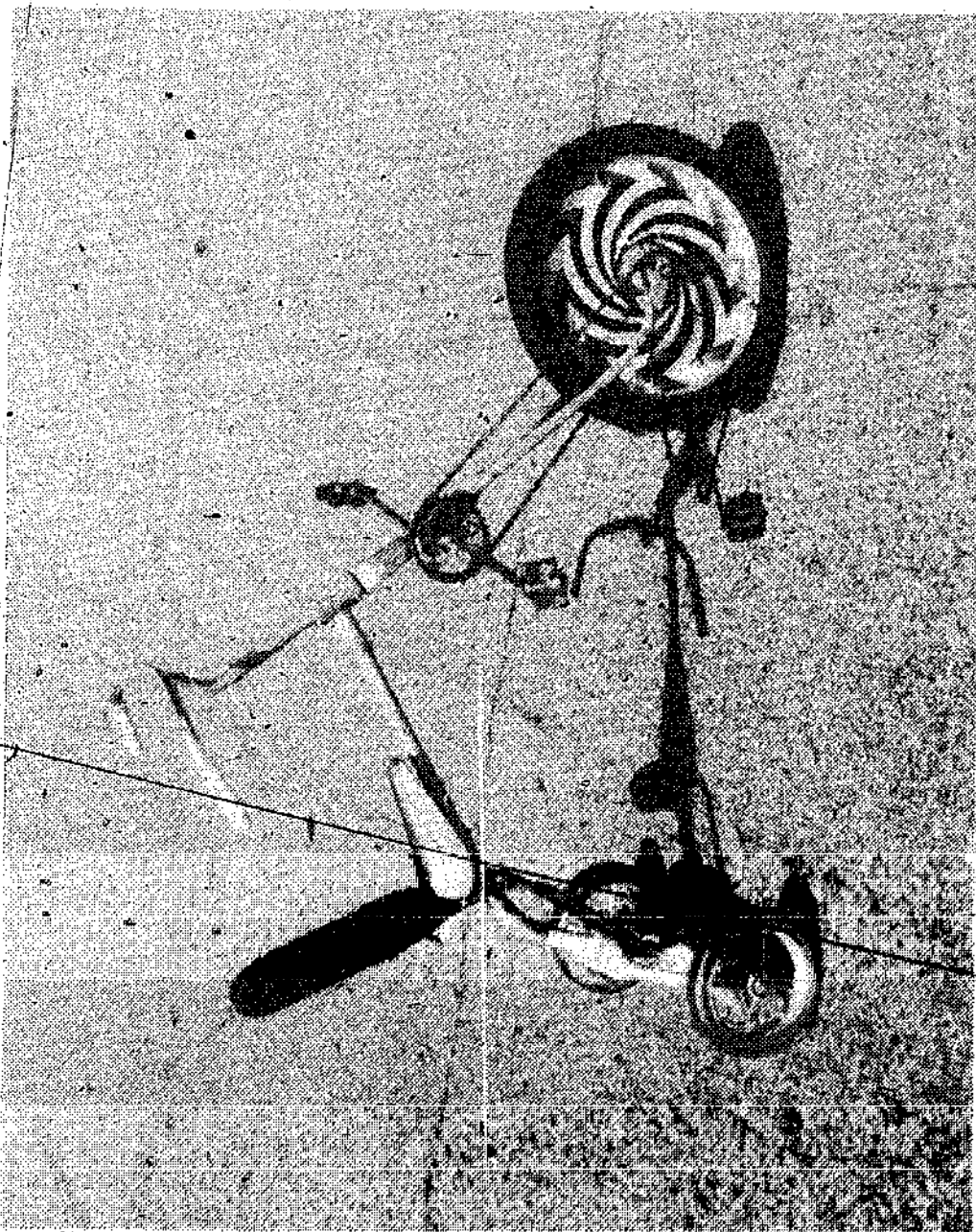



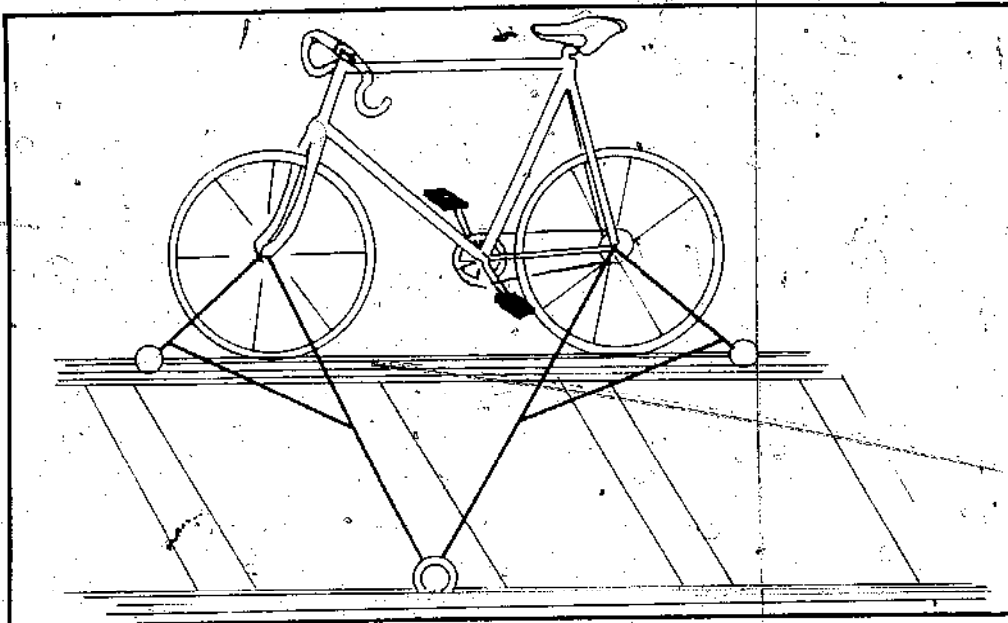

Fig. 16-7. A standard bicycle converted for use on railroad tracks.

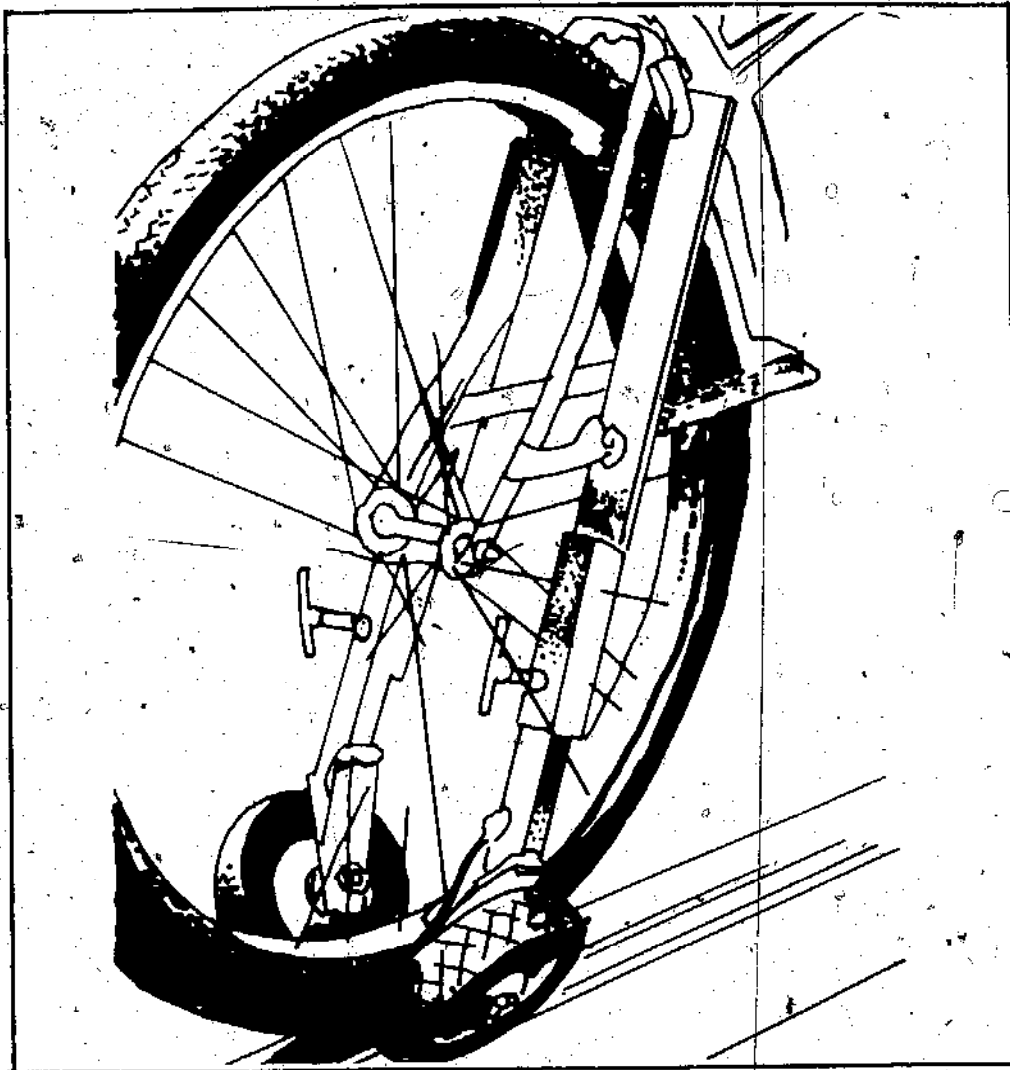
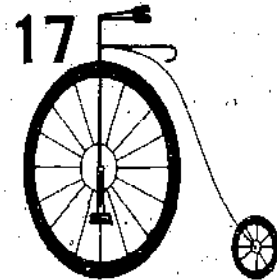

Fig. 16-8. Attaching lawn mower wheels is one way to adapt a bicycle for use on railroad tracks.

In Fig. 16-8, four-inch lawn mover wheels are shown set at 45 degree angles. Attach the wheels to seven-eighth inch square tubing which telescopes into one-inch tubing so that you can raise or lower the wheels. The wheels are held in position with lock nuts. The square tubing is connected with a yoke and held in place with two-inch channel iron.

## Generating Power With Bicycles



The bicycle is one of the most energy efficient machines ever invented. Pedal generated power has influenced labor, transportation and recreation. Pumps, saws, winches, lathes, pedal powered racing boats and even airplanes are examples of how the standard bicycle-driven mechanism can be applied to generate energy.

Not long after the bicycle first became popular, a great quantity of pedal and treadle machines were invented. The invention and mass production of the internal combustion engine did slow the pace of bicycle design and the widespread application of pedal power. However, the high costs of energy and the inefficiency of our transportation systems point out the advantages of bicycle technology that is structurally and mechanically efficient.

The primary reason a bicycle works so well is that it uses the body's strongest muscles at 60 to 80 revolutions per minute and transfers that energy very effectively by utilizing a sprocket and chain device.

Figure 17-1 is a design for a unit built from a standard bicycle frame. It can be used to power a grinder, polisher, pump, potter's wheel, battery charger — or even a television. It is possible to attach the unit to an automobile generator, 12-volt battery and an inverter in order to generate electricity. An inverter can be used to convert the power stored in the car battery into standard 110-volt appliances or you can attach portable appliances to the battery so that they can be run on direct current. You can then recharge the battery as needed.

Study the illustrations in Fig. 17-1 through Fig. 17-6 before and during each step. Gather all the parts you will need before you begin



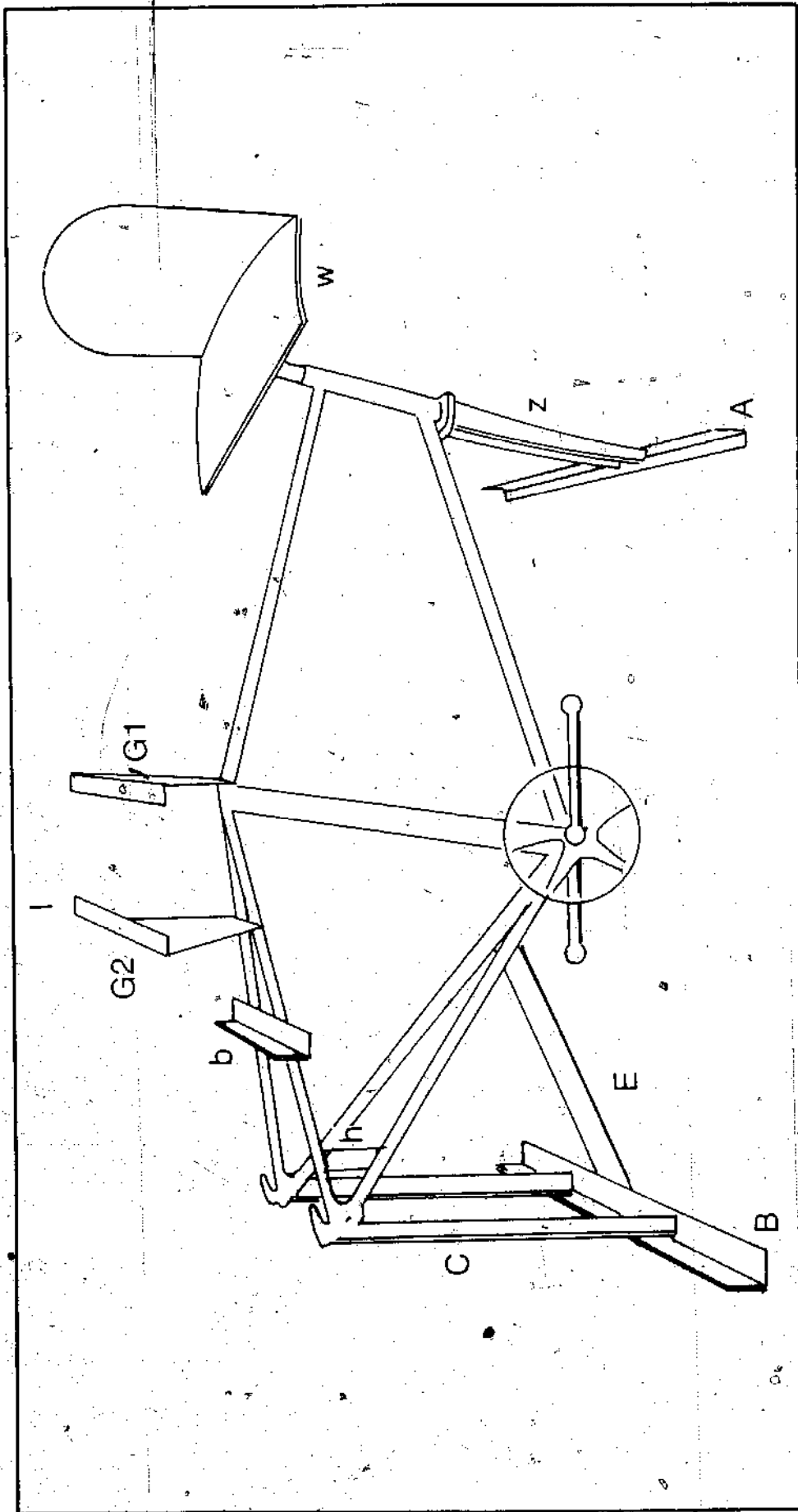

Fig. 17-2. The assembled unit with (A,B,C,E,G1,G2,) angle-iron, (b) gate-hinge, (h) 1D steel tubing, (w) steel shaft and the (z) front fork in place.

assembling this unit. The tools you will need are easily available. They include wrenches, Allen wrenches, clamps, files, pliers, a drill and a hacksaw. You will also need welding equipment to assemble the frame of the unit.

### **MATERIALS**

Five sections of one-inch angle iron—each two feet in length.

A standard bicycle frame including rear and front forks.

Two sections of one-inch angle iron—each 10 inches in length.

Two sections of one-inch angle iron—each 12 inches in length.

Two sections of one-inch angle iron—each six inches in length.

A standard bicycle chain.

Two standard bicycle pedals.

A standard bicycle pedal crank.

### **The Drive Mechanism**

Four self-centering pillow blocks with one-half inch bore.

A one-foot section of steel block that is one-half inch in diameter with a one-half inch, 20 thread right-hand thread.

Four bushings with one-half inch bore.

A one-half inch, 20 thread right-hand threaded nut.

A 20-thread one-half inch Jacob's chuck.

Two step-sheaves with either three or four steps with one-half inch bore.

A 14-inch section of steel stock that is one-half inch in diameter with a one-half inch, 20 thread left-hand thread.

A ten-to 12-tooth bicycle sprocket with a one-half inch bore.

A V-belt.

A one-half inch, 20 thread left-hand threaded nut.

Eight one-quarter inch bolts, washer and nuts for the pillow blocks.

### **The Idle Mechanism**

A gate hinge.

An eight-inch section of steel stock with the same diameter as the bushings.

A grinder shaft mechanism with bushings.

A pulley that is two inches in diameter and fits the shaft.

A spring—size No. 62.

### **The Table**

A three-foot section of steel stock that is three-quarters of an inch thick.

One section of three-quarter inch ID steel tubing—six inches in length.

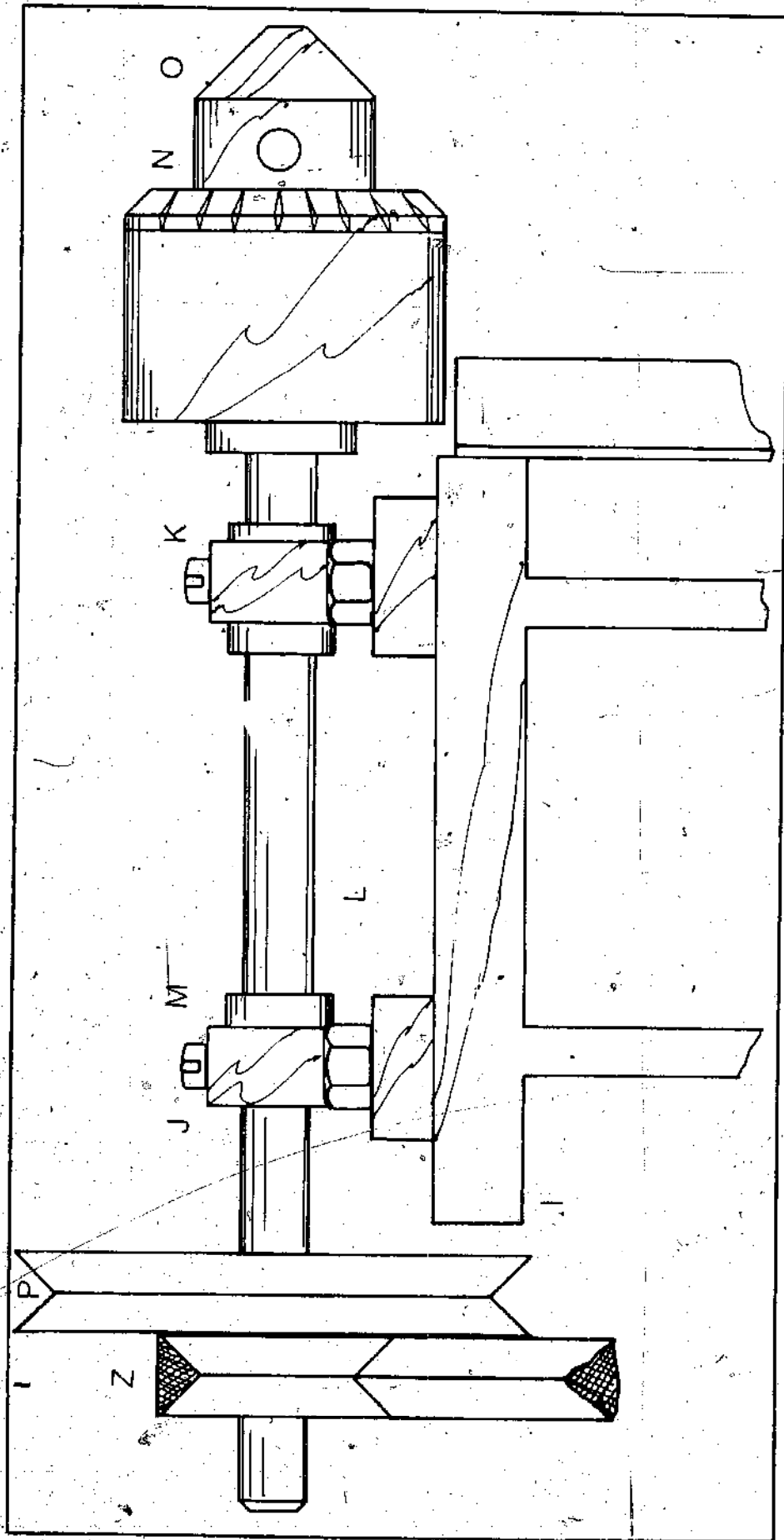

Fig. 17-3. The power support with (I) angle iron, (J,K) self-centering pillow blocks, (L) steel stock, (M) bushings, (N) nut, (O) Jacob's chuck, (P) step-sheave and (Z) V-belt.

Three three-eighths inch nuts.

Three three-eighths inch bolts.

Three sections of one-quarter-inch steel stock—each two and one-half inches in length.

Two sections of three-quarter inch ID steel tubing—each three inches in length.

A hardwood board that is  $16 \times 11 \times \frac{3}{4}$  of an inch.

A section of three-quarter inch steel stock threaded one and one-half inch at one end—six inches in length.

Two three-quarter inch nuts.

Two three-quarter inch washers.

### The Seat

Two sections of one and one-quarter inch square metal tubing—each is one foot in length.

Two pieces of plywood that are  $12 \times 15 \times \frac{1}{4}$  inch.

Two pieces of foam rubber that are  $12 \times 15 \times \frac{1}{4}$  inch.

Two pieces of vinyl cloth that are  $15 \times 18$  inches.

An eight inch section of steel shaft that is seven-eighths of an inch in diameter.

### CONSTRUCTION STEPS

Turn the frame of a standard bicycle so that the back of the bicycle will become the front of the unit you are building.

Cut a two-foot section of angle iron and tack weld it across the bottom of the front fork of the bicycle (Fig. 17-1 A and Z).

Construct a T-frame brace for the front support from a two-foot section of angle iron and two vertical sections (Fig. 17-1 B and C).

When the vertical pieces are welded onto the horizontal brace and back fork (Fig. 17-1 D) they should be positioned so that they are a little more than four inches above the floor.

Weld a piece of angle iron between the front horizontal brace and the frame's crank section (Fig. 17-1 E and F).

To build a power support, cut four sections of angle iron that will reach 38 inches from the floor to the front fork (Fig. 17-1 G1 and G2).

Place a support on both sides of the front fork near where the bicycle's seat connection had been (Fig. 17-1 H).

Position a platform on top of the four columns to hold the two pillow blocks (Fig. 17-2 I). The placement of the second set of supports is determined by the width of the pillow blocks. They will



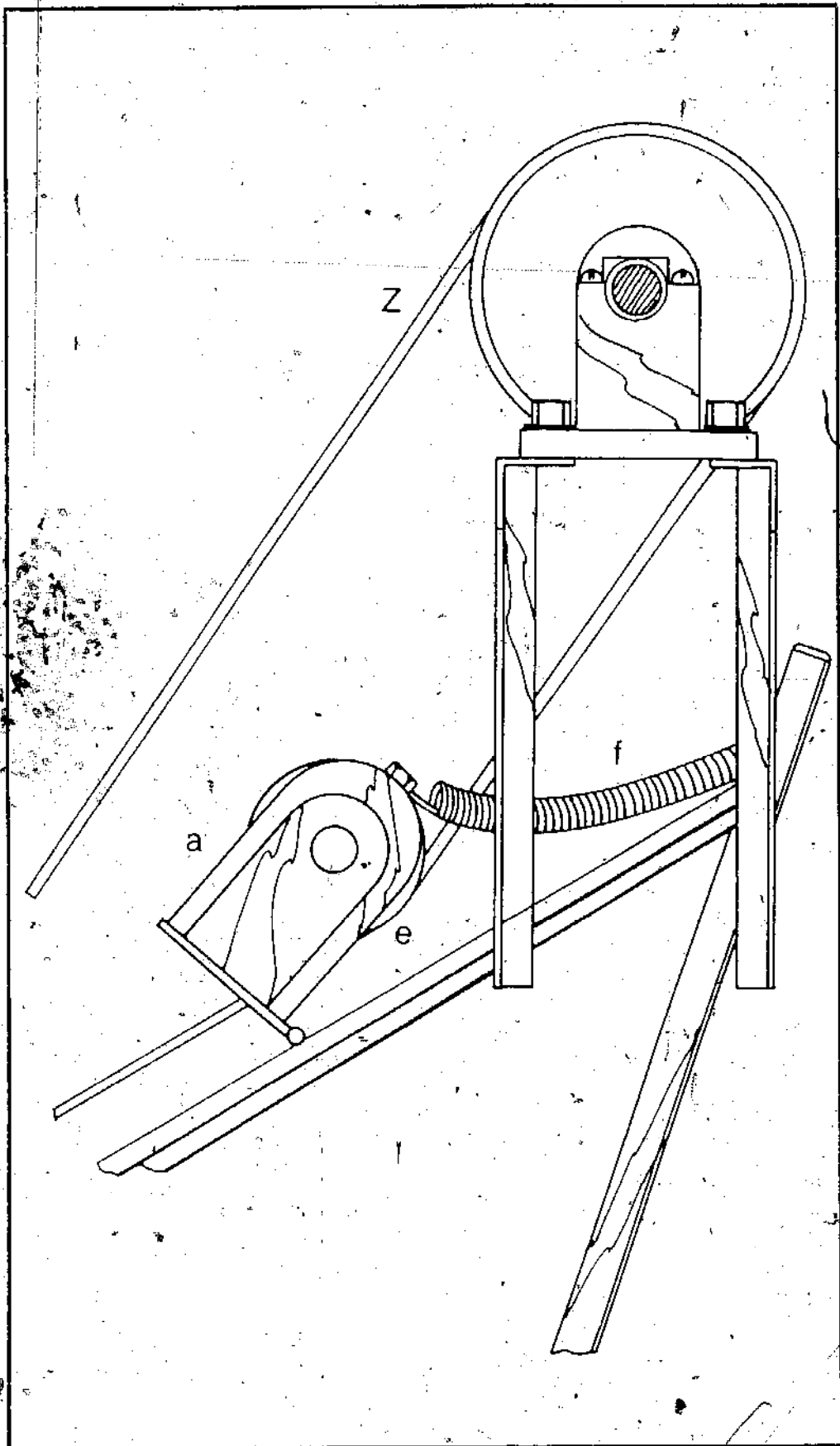

Fig. 17-4. The unit is designed so that slack is removed from the (Z) V-belt. A (a) gate hinge, (e) pulley and (f) spring are part of the design.

be three or four inches forward. Make certain that the four supports are level. Clamp them in place and then weld.

Cut two six-inch sections of angle iron and weld them across the top of each set of braces to form a platform.

Drill holes and then bolt two one-half inch self-centering pillow blocks (Fig. 17-3 J and K). Insert the threaded portion of a one-half inch by one-foot steel shaft in the right pillow block. Put two one-half inch bushings on the shaft and insert the shaft in the other pillow block. Thread one-half inch nut about three-quarters in and then thread the Jacob's chuck onto the shaft against the nut (Fig. 17-3 O).

Position the shaft so that the chuck is as close as possible, but not touching, the left pillow block.

Position a step-sheave on the right edge of the shaft (Fig. 17-3 P).

Drill holes at the top of the T-frame brace for the bolt and two pillow blocks and insert the threaded edge of the 14-inch shaft into the right pillow block.

In the following sequence, position a bushing, sprocket, chain and a second bushing on the shaft and put the shaft into the other pillow block (Fig. 17-1 S, T, U, V and W). A flywheel can be attached to the threaded edge. The right edge is for the other step-sheave. If you mount the top sheave with the pulley on the inside, make certain the large sheave is on the inside of the lower shaft.

If the chain does not fit the sprocket after you have installed it, remove the master link and add or delete links to make the chain fit properly.

When you have the chain in position, move the pedals forward to align the front sprocket. Next, align the bushings and sheaves and file flat areas on the shaft where the allen screws are positioned. Be sure to oil the pillow blocks.

Install a V-belt with enough slack so that changing gears is not difficult (Fig. 17-4 Z).

In order to install an idle device that will remove slack, mount a gate hinge on a grinder shaft mechanism (Fig. 17-1b and a). Weld a gate hinge to the frame a little below the main support. The hinged edge should point toward the front end of the unit and open 180 degrees. Bolt one end of the unit to the flexible portion of the hinge and put an eight-inch shaft through the bushings (Fig. 17-1c and d).

Place a two-inch pulley at the right of the shaft and file the surface of the shaft on one side. Fasten pulley with an allen screw.

Position a No. 62 spring between what was the seat hole of the bicycle to the grinder shaft mechanism.

Support the adjustable table with a three-foot section of steel stock. The section should have a right angle that bends 14 inches. Cut a six-inch section of three-quarter inch steel tubing to brace the strut (Fig. 17-5g). Weld a three-eighths inch nut (Fig. 17-5i) to the side of the tube. Drill and tap threads in the tubing in order to attach a bolt (Fig. 17-5j) that will hold the table support brace.

Form a T-bolt by welding a two and one-half inch section of steel stock across the bolt's head.

The next step is to weld tubing to the frame. Position the tubing forward where it will not interfere with the pedaler's motion. Make sure the tubing is square and aligned properly. File

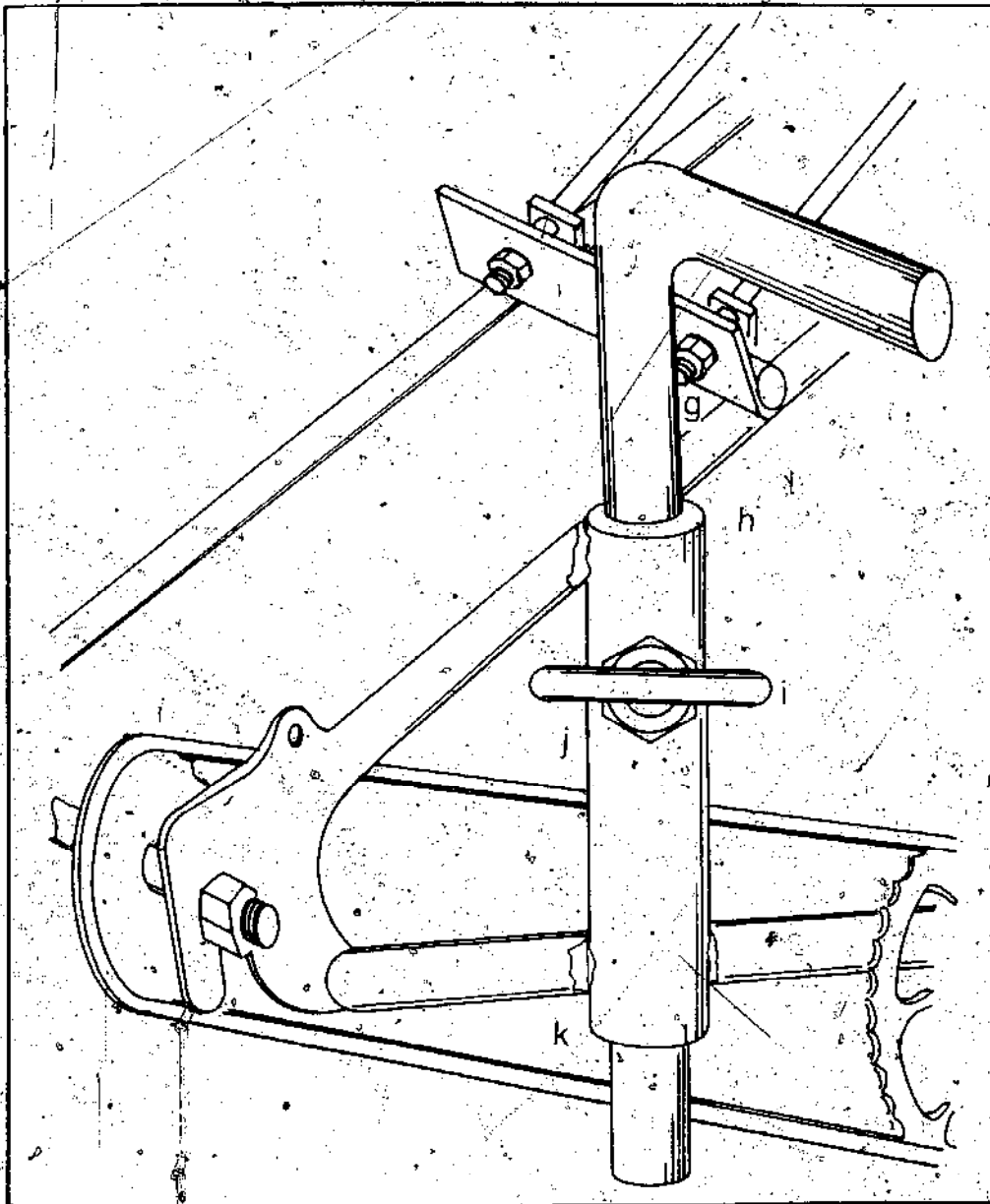
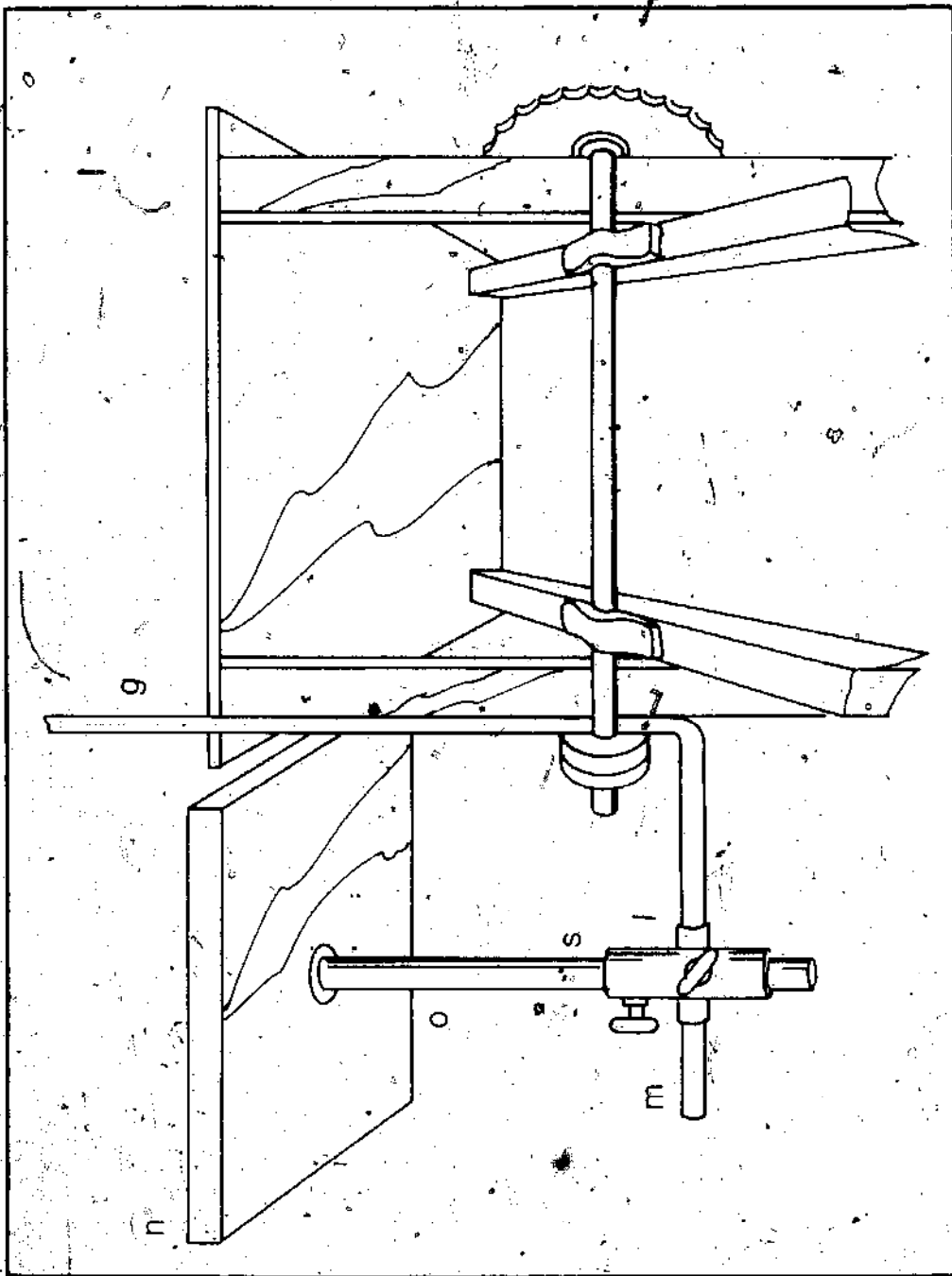

Fig. 17-5. The table is braced by (h) 1/2" steel tubing, (g,k) steel stock and secured by (i) a nut and (j) T-bolt.

Fig. 17-6. The hardwood table (n) is braced with (g,o) steel stock, (l) ID steel tubing, (s) a washer, and a (m) T-bolt.



smooth the inside of the tubing to give the table brace the greatest possible mobility.

Make two additional braces from three-inch sections of steel tubing (Fig. 17-6 l). Weld them at a 90-degree angle and place one onto the table brace. Use the other one to brace the table.

Make T-bolts for the bar braces. (Fig. 17-6m).

Use a 16 × 11-inch cut of three-quarter inch hardwood for the table top (Fig. 17-6n).

Thread one and one-half inches of a six-inch section of a three-quarter inch steel rod.

Place a three-quarter inch nut and a washer on the rod and put the shaft into a drilled hole in the table. Position the shaft into the brace tubing on the table support.

Construct a padded seat with two one-foot sections of one and one-quarter inch square metal tubing. Cut two pieces of one-quarter inch plywood one foot long by 15 inches wide. Pad the seat with foam rubber and overlay it with vinyl fastened to plywood (Fig. 17-1 t-v).

Weld an eight inch section of seven-eighth inch steel shaft to the tubing under the seat and place it in the hole that was used to support the handlebars of the bicycle (Fig. 17-1x).

If the seat is too far from the pedals, cut the shaft to fit. Construct and attach a safety guard to shield the pulley. A flywheel will not be needed for all jobs. Bolt it in place as necessary (Fig. 17-1X and Y).

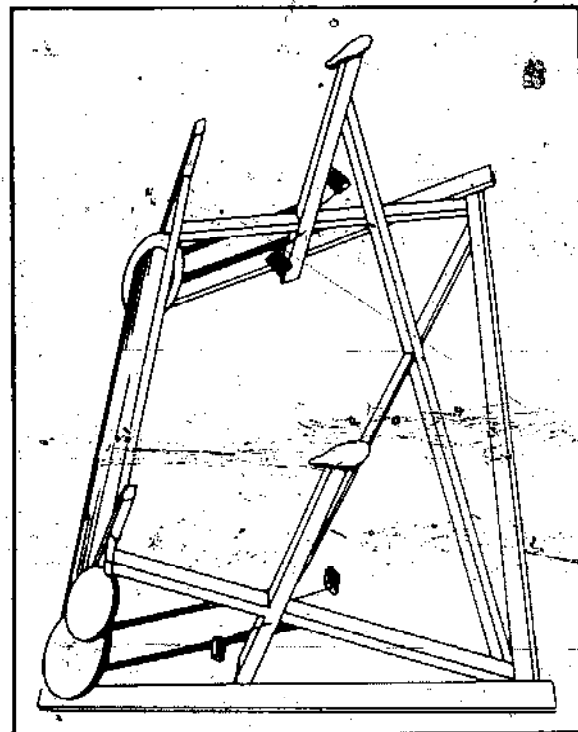

Fig. 17-7. A pedal-driven winch designed to be operated by two people.

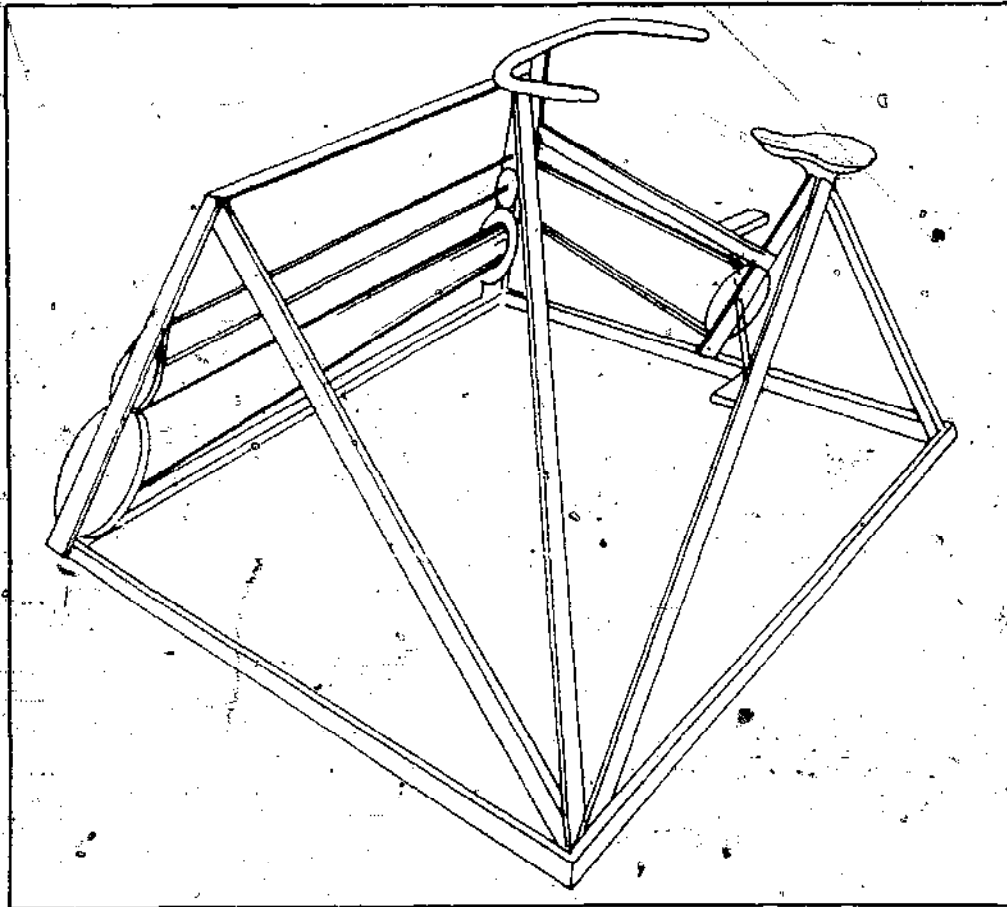

Fig. 17-8: A pedal-driven winch designed for use by one person.

### A PEDAL-DRIVEN WINCH

As a rider increases or decreases speed on a bicycle, the minimum torque is altered. This variation will not effect the operation of a typical utility or touring bicycle. But if you want to power a machine, such as a winch that is in a fixed position, the motion of the mechanism becomes jerky. This erratic motion can be countered with the installation of a flywheel or an elliptical sprocket. An elliptical sprocket will vary the gear ratio twice each time the crank rotates. In order for the chain to take the pull, a fixed strut must be installed between the sprocket that drives the mechanism and the sprocket that is driven by the pedals. The mechanism must also have an adjustable chain.

Two flywheels are used to construct the pedal-driven winch shown in Fig. 17-7. The two-man device can be attached to a pump, grinding mechanism, drilling mechanism or other similar device.

On this unit, the starter gear ring meshes with a starter pinion on a shaft that is located above it. The bottom flywheel is driven by the starter gear ring which also moves the winch drum. The shaft moves two fixed sprockets. The sprockets are connected by chain

to a standard bicycle chainwheel and pedals. The trunks are placed so that two sets of cranks are at right angles. This will insure an even production of power. The second flywheel is rotated with enough speed to counter sudden fluctuations when you are winching a load. The device can be placed on skids to make it easier to transport. This winch can be used for excavations and to lift loads. The unit in Fig. 17-8 is designed to be operated by one person.

### ARCHIMEDES SCREW

Where a requirement exists for bringing water from a river or stream in order to irrigate land, an efficient pedal-driven irrigation pump can be constructed. Ideally, this device should:

- Use low cost materials and regular bicycle parts.
- Use pedal generated power instead of a hand-cranking mechanism.
- Be low cost, sturdy and require little maintenance.
- Be constructed so that it can be easily dismantled, transported or stored.

An Archimedes screw fits all of these requirements (Fig. 17-9). Since the maximum slope of an Archimedes screw is approximately 30 degrees, the length should be 20 feet. This means there will be a distance of about 13 feet between the shaft and the pedals.

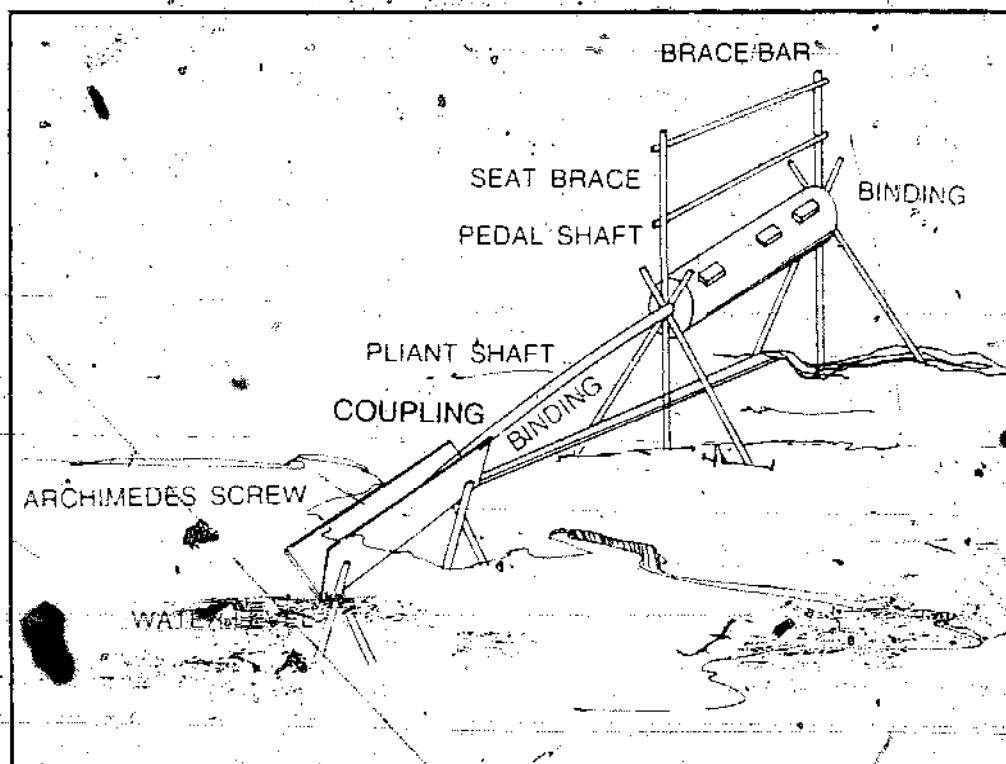

Fig. 17-9 A pedal-driven Archimedes screw that is designed with a slope of 30 degrees and a length of 20 feet.

A flexible steel shaft should be installed that will transfer torque and will be flexible enough to adapt to the 30-degree variation in slope from the pump to the pedal device. The diameter of the shaft should be approximately three-quarters of an inch.

Adjustments to the length of the pedal shaft can easily be made if you construct the unit with a full-length axis hole to hold the rod. You should also make couplings that will tightly clamp the rod with two cycle-type cotter pins. To assemble the unit:

- Insert the rod into the pump coupling.
- Thread the pedal shaft over the higher portion of the rod.
- Place the pedal shaft on its framework.
- Clamp the rod at the higher portion.

The framework can easily be made from two sets of three sturdy poles plus a seat pole and a handlebar pole. Bind the sets of three poles to form tripods. Be sure to overlap the shorter legs of the tripods to form a support for the shaft of the pedal device. A metal ring can be used to secure the bearing to the tripod. The bearing also holds the shaft of the pedal device.

#### **BOREHOLE PUMPS:**

A borehole pump can be used to draw water from depths of 20 to over 300 feet. Figure 17-10 is a design for a pump that uses pedal-generated power. A horizontal axle fits two sets of pedals that are placed at 45 degrees to insure smooth pedaling. Bearings at both ends are supported by poles that are crossed. The poles at both ends cross the second horizontal pole to make a seat for the pedalers. The pedalers can hold onto a third and fourth horizontal pole for support and balance while they pedal.

The main pedal shaft is extended at both ends by a steel shaft that passes through the bearings. A regular bicycle left-hand crank and pedal is placed at one end and a regular chainwheel and crank with 12-inch diameter is placed at the other end. Connect the left-hand pedal to a cable which is drawn over a bicycle wheel rim and used as a pulley.

The wheel is braced by a regular bicycle frame suspended from the two higher horizontal poles. The other cable end is attached to the higher end of the pump rod. Use a strand of leather to align the wheel rim and avoid damaging the rim or cable. The chainwheel at one end drives the flywheel at a higher speed by utilizing a step-up drive.

The flywheel for this device can be constructed by using a regular bicycle wheel. Fill in the area between the hub and the rim with cement or wrap it with heavy-gauge wire. The wheel is braced



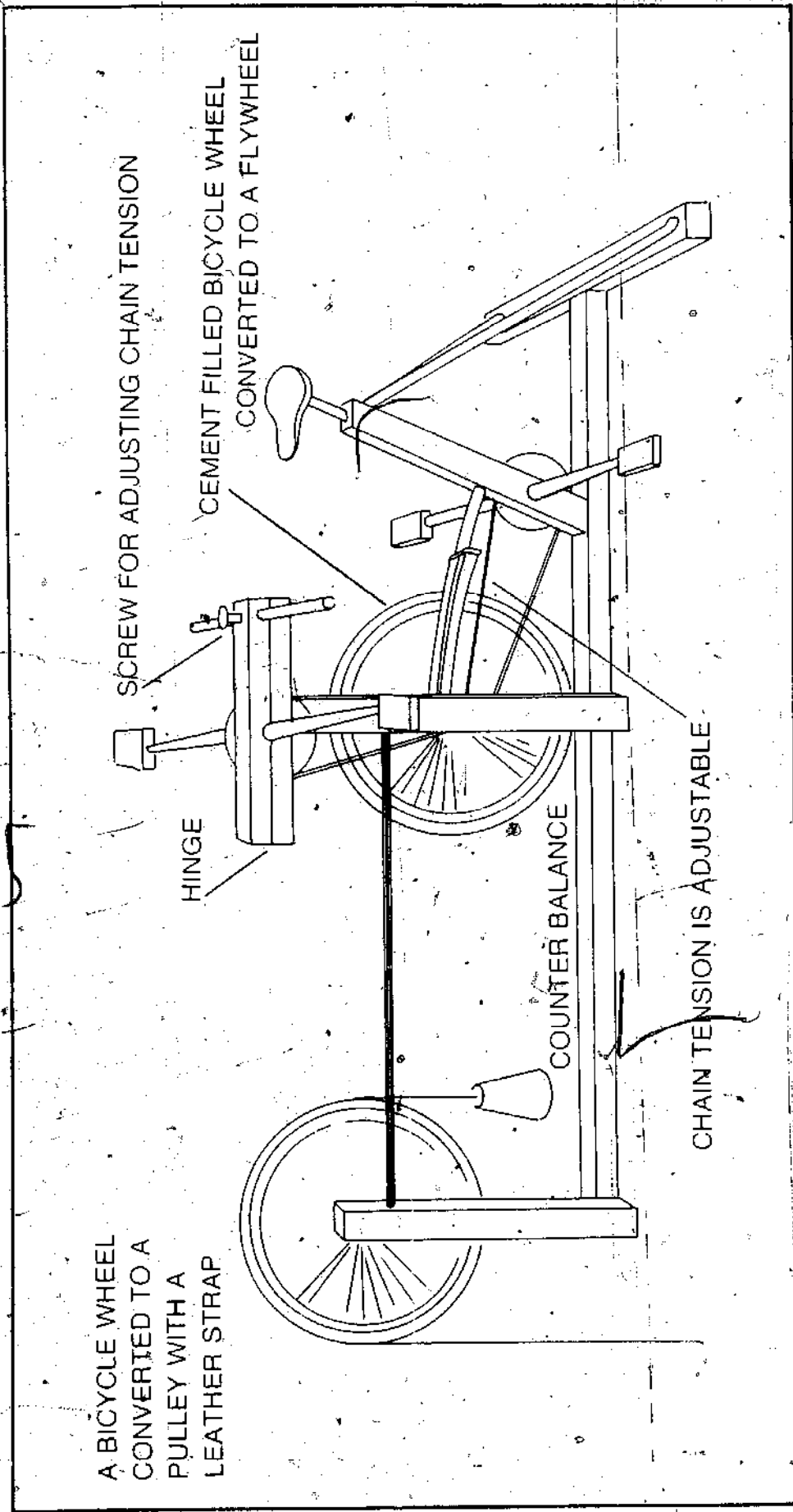

Fig. 17-10. A design for a borehole pump that draws water from shallow to medium depths.

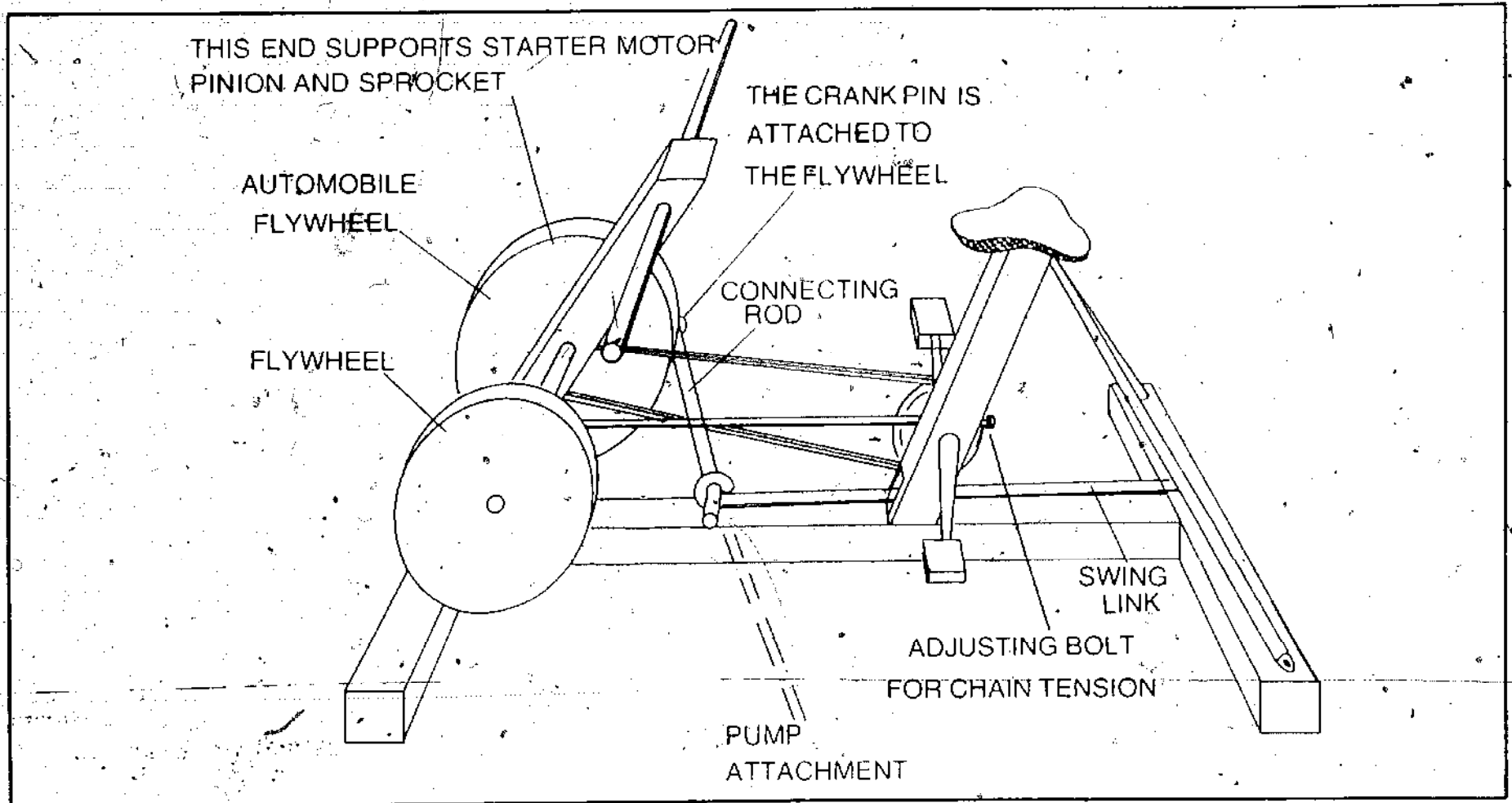

Fig. 17-11. A pedal-driven borehole pump designed to draw water from depths of approximately 300 feet.

from the top poles so that the tension in the chain or belt can be adjusted.

Figure 17-11 is a pedal-driven unit designed for one person to operate. The chainwheel drives a bicycle wheel rim that is filled with cement between the hub and rim. A second chain transfers the drive from the sprocket to a second chainwheel and pedals which are positioned above. A cable is connected to the second chainwheel. It is used as a pulley and attached by strut to the column bracing the flywheel and the second chainwheel. Tension in the first chain can be resisted by using the front fork of a bicycle. Place the threaded portion of the fork through a hole in saddle post. Use a threaded nut to adjust the tension of the chain.

For the second chain, adjust the tension by using a screw which raises one end of the horizontal member that holds the pedal shaft. The front end of the pedal shaft is hinged to a lower member positioned on top of the left-handed brace.

Figure 17-12 is another design for a borehole pump. This pump can be used on deeper boreholes. It is constructed utilizing an

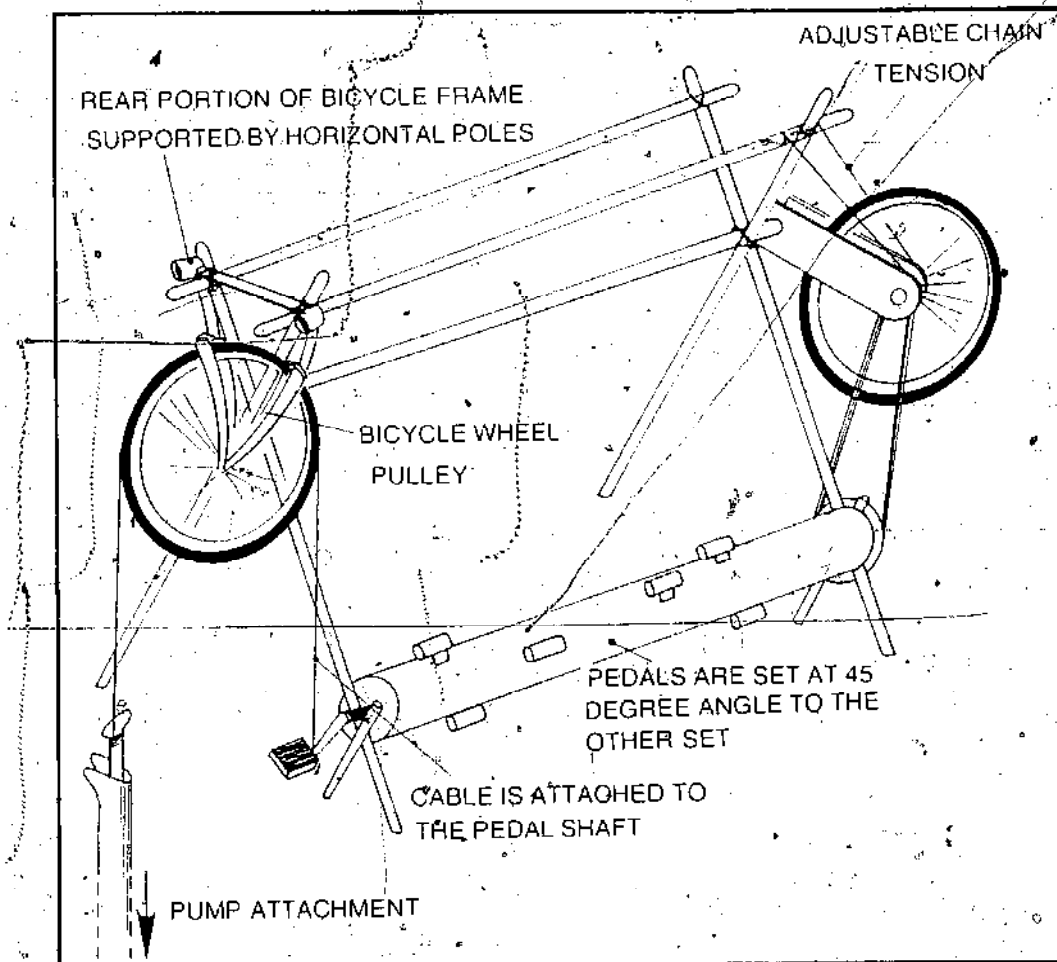

Fig. 17-12. A borehole pump that is designed to be used by two people.

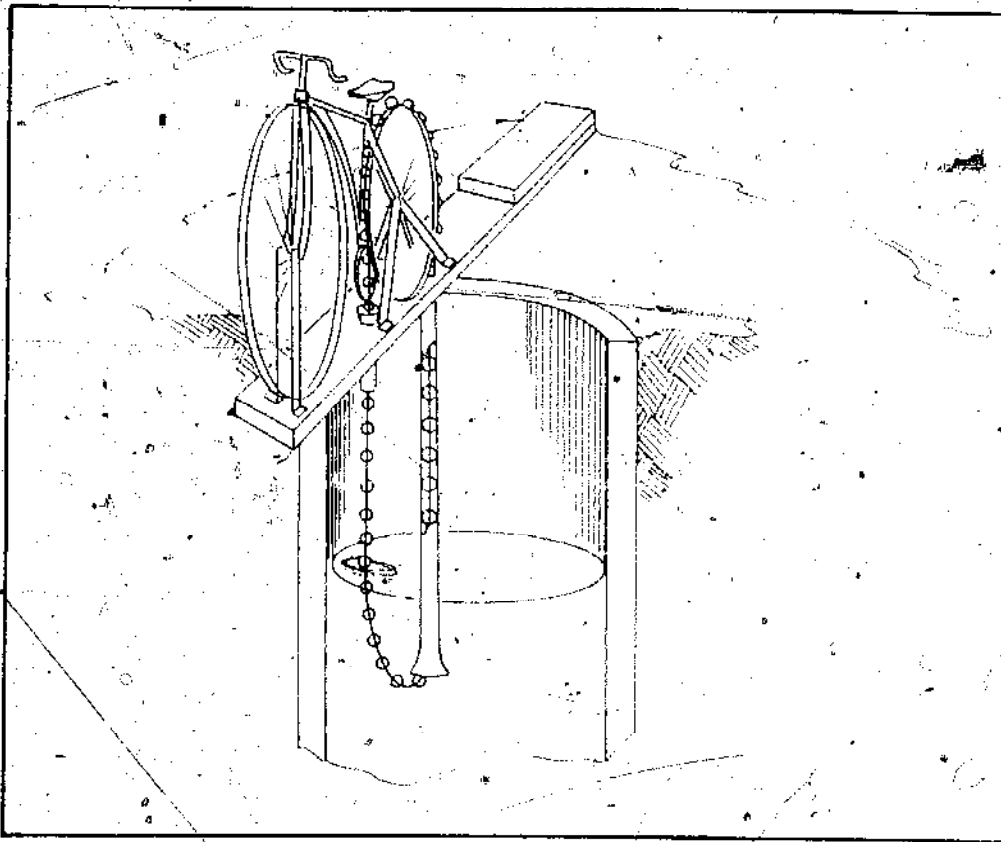

Fig. 17-13: A bicycle-driven pump utilizing a ball and chain with a tireless rear wheel.

automobile flywheel, a sprocket and chain drive, and a chainwheel and pedals.

### **BUILDING A FLYWHEEL**

If a weighted flywheel is required in the design of a unit, you can build a flywheel from a bicycle wheel and cement. The first step is to fill the shaft hole of the bicycle wheel with a thoroughly greased broom handle or other similar solid round object that is the proper diameter of the shaft. The broom handle must be vertical and true when it is placed in the shaft hole.

Lower the bicycle rim into the exact center of a cylindrical container that has been greased. Pour in the cement mix. Make sure the cement is smooth and evenly distributed. Allow enough time for the cement to thoroughly harden before you remove the flywheel from the container.

### **PEDAL-DRIVEN PUMPS**

Figure 17-13 and Fig. 17-14 are examples of pedal-driven pumps that use standard bicycle frames and mechanism to draw water from wells. These designs are more efficient and less tiresome for the worker than the standard hand-pump system since the

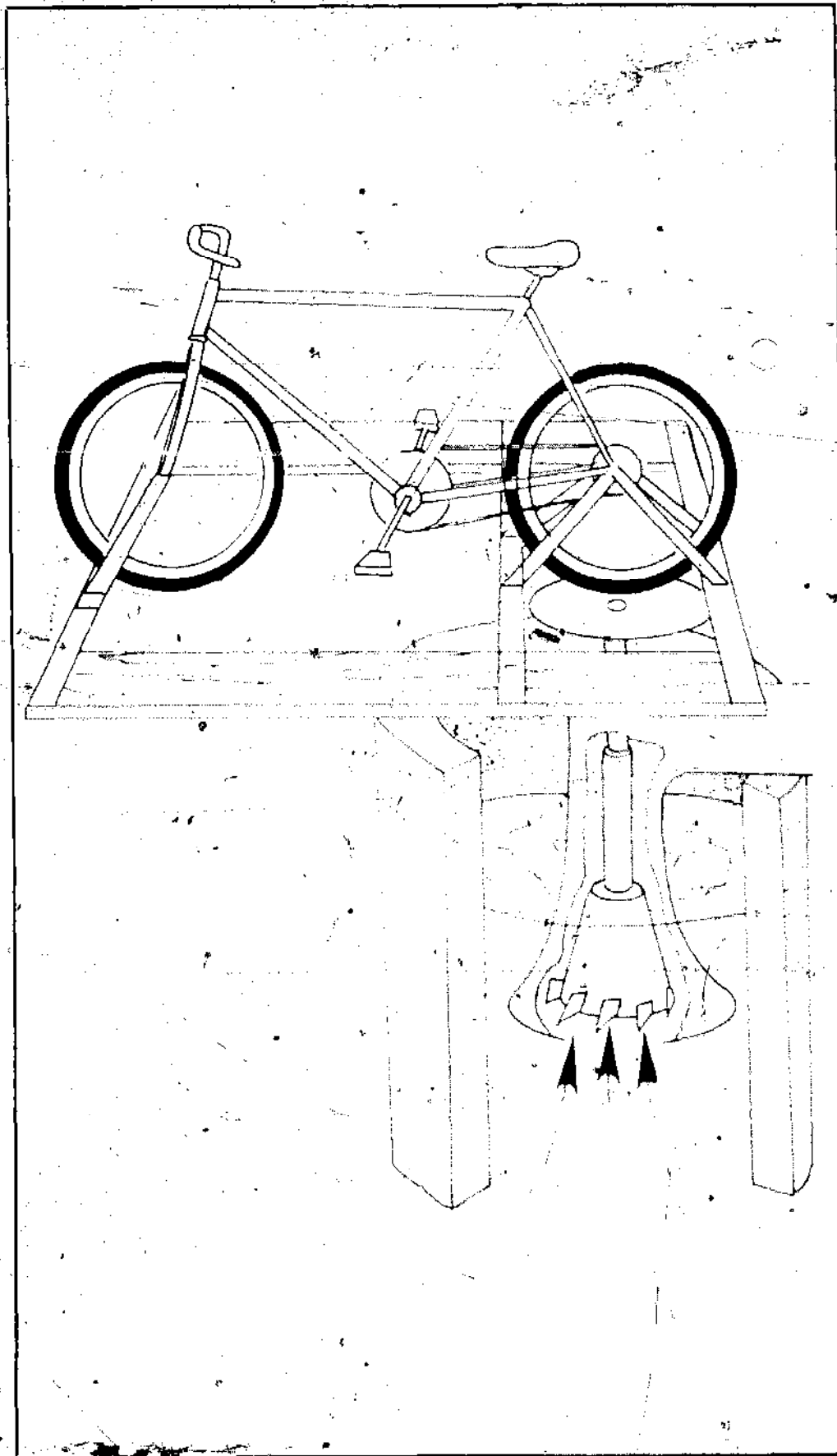

Fig. 17-4. A design for a pedal-driven pump that utilizes a standard bicycle mechanism to draw water.

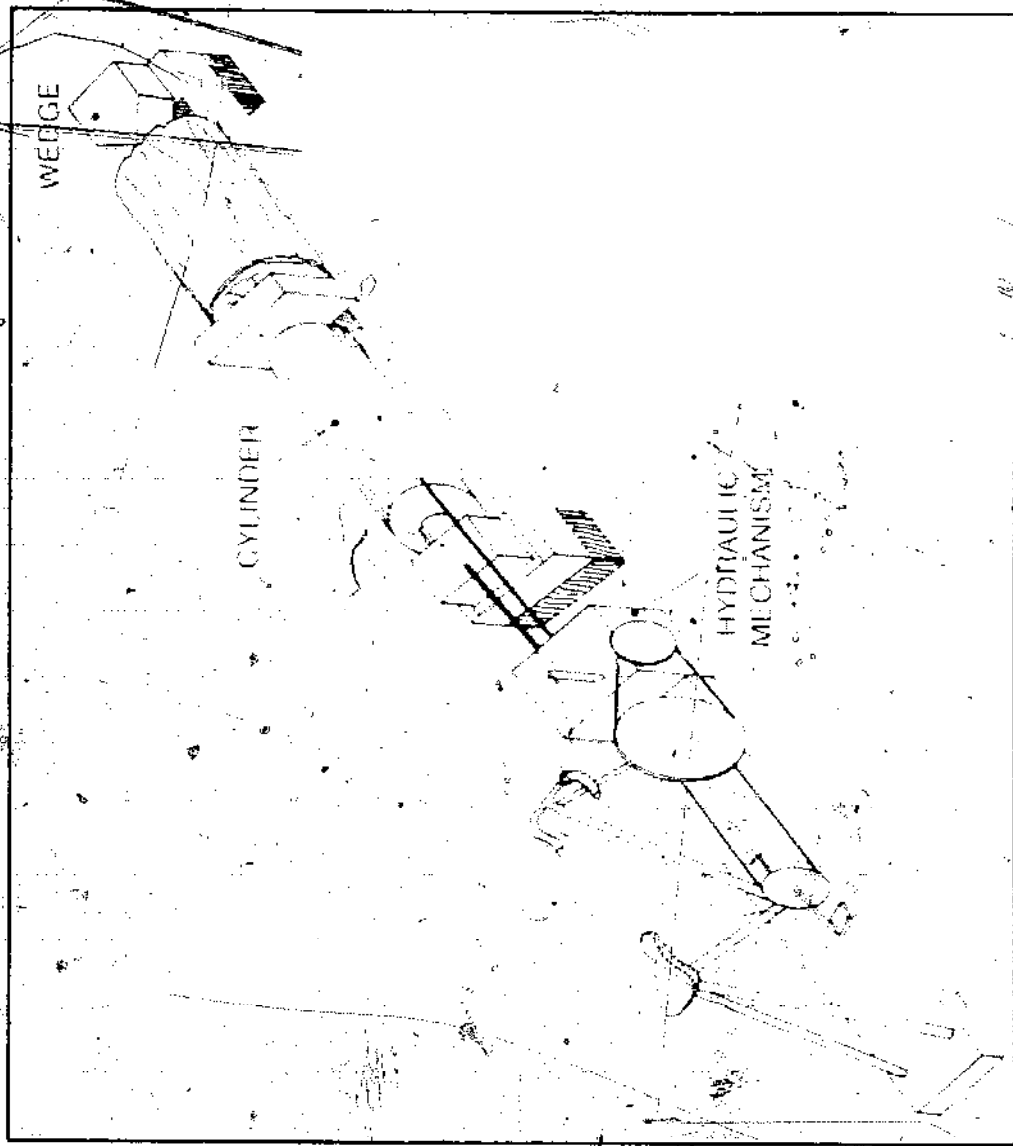

Fig. 17-15 A pedal-powered hydraulic log splitter

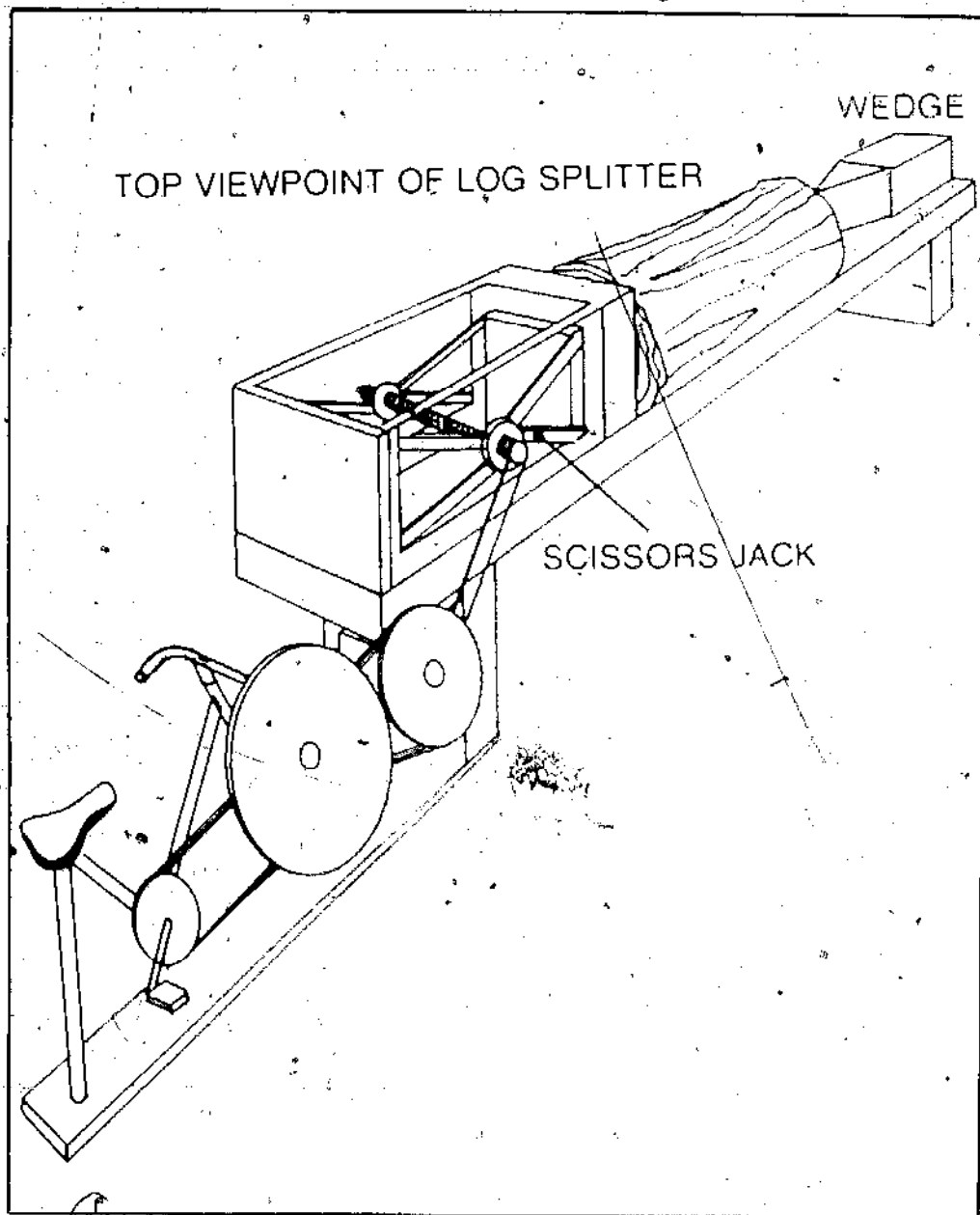

Fig. 17-16. This design makes use of pedal-power and a scissors jack to split logs.

strongest muscles of your body can be put to work pumping the water.

### A PEDAL POWERED LOG SPLITTER

Log splitters are commercially available that are designed to be powered with a five-horsepower gasoline engine. It is possible to convert such a unit and use pedal generated power to run the hydraulic pump (Fig. 17-15). An alternate system (Fig. 17-16) makes use of a standard scissors jack used to change automobile tires. A reduction jackshaft is attached to this design with a belt. A tumbler shaft drives the jack.

# Index

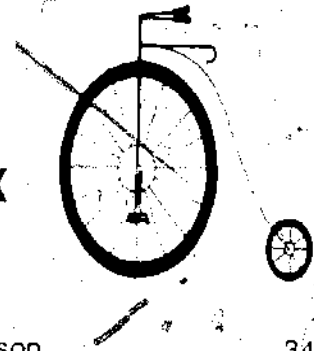

<b>A</b>			
Accessories	74	comparison	34
Adjustments	120	components	45
Adult tricycles	14, 260	conversions	212
Aerosol spray cans	201	customizing	17
Ampagnolo tool set	107	derailleur	24, 64
Archimedes screw	359	double decker	289
Artistic bicycles	14, 295	fixed-wheel track	60
care	297	history	9-12
maintenance	297	how they're ridden	117
manufactured	295	how they're used	117
repair	297	hub-geared	62
tips on using	297	important factors	49
Artistic bicycling, competitions	16	insurance	90
ideas	298	internal hub multi-speed	24
world championships	293	making your own	215
Axles to bicycles, methods	46	miniaturo	337
		modifying	17
<b>B</b>		motocross	238
Balance	80	plastic	45
Balloon tires	22, 48	polo	15
Bearings	46	portable	14, 219
caged	46	racks	92
loose	46	rollers	229
permanently sealed	47	rules	86-88
Bicycles, American	22	safety	12
and the rider	73	serial number	89
& weight, total	72	serious compromise	20
ball	15	sidewalk	271
bronco	247	single-speed	22, 62
building	17	storing	17
building with kits	17	technical inspection	245
building without kits	17	track	32
		transporting	91
		water pedal	340







		proper uses	105
		types	105
Machine screws	114	Polishing	120
Macmillan, Kirkpatrick	1	Polystyrene, beaded	88
Maintenance, some basics	114	Portable bicycles, tips on using	219
stands	110	Posture	79
Manufactured models	211	Powered bicycle, construction of	352
Michaux, Ernest	12	construction materials	350
Mixte	42	Precision	19
Modifying, bicycles	17	Price	32, 74
Monocycles	303	Primer	201
Motocross bicycles	238	Pumps, borehole	360
conversions	242	pedal-driven	364
Motocross bicycling	15	Pursuit races	100
courses	244		
Multi-speed hubs	119		
overhaul	137		
		<b>Q</b>	
		Quality	32, 74
		Quick releases	46
		<b>R</b>	
		Races	100
		road	100
		pursuit	100
		Racing	99
		2 main types	100
		Racing bicycles, 2 main types	100
		Racks	91
		rear bumper	91
		rear deck	91
		roof	91
		Rake	39
		Rattraps	57, 166
		Reach	36, 74
		Rear bumper racks	91
		deck racks	91
		Rear derailleurs	66
		adjusting	182
		overhauling	186
		Rear triangle	36
		Riding	77
		in traffic	84
		learning	79
		posture	30
		tips	79, 246
		Rims	47
		straightening	150
		Road races	100
		Roller	66
		Roof racks	91
		<b>S</b>	
		Saddle	30, 50, 194
		adjusting height	194
		consider quality	52
		covers	195
		important factors	52
<b>M</b>			
Machine screws	114		
Macmillan, Kirkpatrick	1		
Maintenance, some basics	114		
stands	110		
Manufactured models	211		
Michaux, Ernest	12		
Mixte	42		
Modifying, bicycles	17		
Monocycles	303		
Motocross bicycles	238		
conversions	242		
Motocross bicycling	15		
courses	244		
Multi-speed hubs	119		
overhaul	137		
<b>N</b>			
Nuts	114		
self-locking	115		
wing	115		
<b>O</b>			
Oil maintenance, monthly	118		
Ordinary farthing	12		
Ositron rear derailleur, features	67		
Overhaul	114		
maintenance picture	121		
six-month	120		
yearly	120		
<b>P</b>			
Panniers	98		
Parts	112		
Pedal cars	271, 340		
Pedal cycles	12		
today	12		
uses	14		
Pédaling cadence	81		
rate	81		
techniques	80		
Pedals	57, 120		
lubricating	120		
metal	57		
rubber pad	166		
that cannot be disassembled	164		
Penny farthing	12, 277		
building	279		
finding antique	278		
novelty cycle	16		
riding	279		
variation	282		
Performance	19		
Physical fitness	14, 99		
programs	232		
Pliers	104		

leather	50	changing	123
metal base	50	clincher	47, 122
narrow touring	30	fixing flats	49
paddled	50	flat	49
tension adjusting	195	inflation	122
wide	30	levers	107
Saddle posts	50, 194	maintenance	122
inexpensive	53	repairs	123
Safety	85	sew ups	124
gear	245	tubular	47, 122
levers	164	Toe clips	57, 167
Screwdrivers	106	Tools	103, 203
types	106	chain	107
Shifters	188	special	107
disassembly	188	Touring	96
relocating	189	exposure to heat	96
Side-pull calipers, maintenance	162	exposure to sun	96
Single-speed bicycles	22, 62	health precautions	96
advantage	22	portable tool kit	104
disadvantage	22	repair equipment	96
drive assembly	62	suitable clothing	96
Spray painting	200	Transporting	91
Spokes	47	Transporting bicycles, features	
butted types	47	to look for	91
holes	47	Tricycles	14
made from	47	adult	14
protruding	150	conversion units	267
straight gauge	47	converting to two-wheeler	275
Sprockets, fixed rear	207	industrial	267
problems	186	maintenance	259
Starley, James	12	manufactured	260
John K.	12	repair	259 & 271
Steel, chrome-moly	38	tips on using	271
chrome-molybdenum	38	Truing stand	148
low-carbon	36	Tubes	36, 122
manganese-molybdenum	38	changing	123
seamless high-carbon tensile	36	maintenance	122
Stevens, Thomas	12	repairs	124
Stick shift	188	sew ups	125
Straps	57, 167	Tubing, flattening	205
Submafiner	42	Tubular tires	47, 122
Sun Tour	67	advantages	48
Supplies	112	disadvantages	49
Swing Bike	14, 257		
		<b>U</b>	
	<b>T</b>	Unicycles	14, 301
Tandems	14, 283	big-wheel	322
building	285	brief history	302
manufactured	283	building	306
tips on using	288	care	316
Tape, padded	54	giraffe	304
Taping	54	juggling while riding	323
Tension wheel	66	kangaroo	321
The Seat	51	introduction	303
Time trials	100	learning to ride	318
Tires	47, 122	maintenance	316

