

[search](#)[subjects](#)[titles a-z](#)[organization](#)[how to](#)

The biogas/biofertilizer business handbook

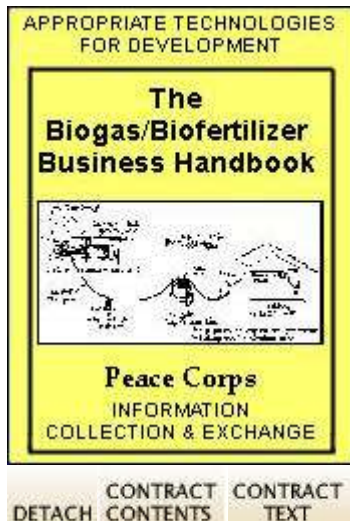

(introductory text)



Information



Main Points of the Handbook



Preface



Chapter one: An introduction



Chapter two: Biogas systems are small factories



Chapter three: The raw materials of biogas digestion



Chapter four: The daily operation of a biogas factory



Chapter five: The once a year cleaning of the digester



Chapter six: Tanks and pipes: Storing and moving biogas



Chapter seven: The factory's products: Biogas



Chapter eight: The factory's products: Biofertilizer



Chapter nine: The ABCs of safety



Chapter ten: Conclusion: Profiting from an appropriate technology



Appendix



New ideas



Composting



Bioinsecticides



Ferrocement



Facts & Figures



Sources & Resources



Feasibility Studies



Problem solving



Vocabulary

The biogas/biofertilizer business handbook

Third Edition

By:

Michael Arnott

Information

Printed By:

PEACE CORPS

Information Collection and Exchange

Reprint R-48

July 1985

INFORMATION COLLECTION & EXCHANGE

Peace Corps' Information Collection & Exchange (ICE) was established so that the strategies and technologies developed by Peace Corps Volunteers, their co-workers and their counterparts could be made available to the wide range of development organizations and individual workers who might find them useful. Training guides, curricula, lesson plans, project reports, manuals and other Peace Corps-generated materials developed in the field are collected and reviewed. Some are reprinted "as is"; others provide a source of field based information for the production of manuals or for research in particular program areas. Materials that you submit to ICE thus become part of the Peace Corps' larger contribution to development.

Information about ICE publications and services is available through:

The Peace Corps Internet Web Site address:

<http://www.peacecorps.gov>

Please note the new Peace Corps Mailing Address from July 1998 on is:

ICE/ Peace Corps

1111 20th Street N.W.

Washington, DC 20526

USA

Add your experience to the ICE Resource Center. Send materials that you have prepared so that we can share them with others working in the development field. Your technical insights serve as the basis for the generation of ICE manuals, reprints, and resource packets, and also ensure that ICE is" providing the most up-to-date, innovative problem solving techniques and information available to you and your fellow development workers.

All Sources that are quoted or adapted in this book are under the protection of their copyrights. This book is not for sale.

I would like to thank the many people whose help, encouragement, and invaluable advice made it possible for me to write this book. Among those to whom I am especially indebted are: Dr. Alfredo S. Mercado; Dra. Lolita L. Mercado; Engineer Patricio M. Bael, Jr.; Paul Taleon; and Erdie Mira. A special thank you to Peace Corps Volunteer John Hopkins who proofread the first edition and Martha W. Arnott who proofread the second edition. They put a lot of hard work into making my writing and editing readable. Many thanks to the United States Peace Corps and to Volunteers in Technical Assistance (VITA) for their support, resources, and encouragement.

This, the third edition of the book, would not have been possible without the invaluable advice and the graphic art and layout skills of graphic artist Sue Niewiarowski. I am also greatly indebted to Shirley Witchley for her perseverance with my notes and her skill with the computer/word processor.

I welcome letters from people working with biogas systems. I would enjoy discussing this book, the ideas in it, and all efforts to develop biogas systems and appropriate technology. I believe biogas systems have an as yet unrealized but very real potential for commercial success and social benefit.

Michael Arnott

Main Points of the Handbook

I. Purpose and Scale

A. The subject of this book is one approach to building and operating biogas systems, not biogas digesters. Biogas systems include raw material preparation, digesters, separate gas storage tanks, use of the gas to run engines, and the use of the sludge as fertilizer.

B. The systems can be profitably operated as cooperatively or privately owned labor-intensive small businesses. They are designed to meet local fertilizer and fuel needs, using local resources and skills.

C. Like rice and corn mills, ice plants and general stores, biogas businesses have supply, production, distribution, and management responsibilities. Operated as businesses, biogas systems have the potential to make a rewarding return on investment and a contribution to the wealth of the community.

II. Raw Materials

A. Animal waste.

1. Manure is the most common raw material.

B. Plant waste.

1. It is useful when shredded, ground or pulped, and partially composted before being put in the digester.

C. Digester slurry.

1. Slurry is raw material mixed with water or the liquid portion of used slurry.

2. Slurry is mostly water; it should be only eight to ten percent solid.

3. Slurry should have a 30 to 1 carbon to nitrogen ratio and a neutral to slightly base (alkaline) pH.

4. No floating matter, dirt, or sand should be in the slurry.

5. A 40 day digester detention time is recommended, with slurry added once or twice a day.

III. The Digester

A. Horizontal, above ground digesters with a two to three percent tilt down from inlet to outlet are recommended in this book.

- B. A digester length-to-diameter ratio of five to one is recommended.
- C. Ferrocement, mild steel, and galvanized iron, are the recommended digester and gas storage tank construction materials.
- D. Separate gas storage tank(s) are recommended in this book.
- E. 10 to 30 cubic meter capacity systems may be practical, but 50 cubic meter capacity and larger systems are practical.
- F. A continuously maintained digester temperature of 35 degrees centigrade (96 fahrenheit) is recommended.
- G. An annual cleaning of the digester to remove scum and dirt is recommended.

IV. Biogas

- A. Biogas can be produced by anaerobic digestion at rates of one to two cubic meters of gas per cubic meter of digester space per day in the digesters described in this book.
- B. Biogas composition is 60 to 70 percent methane which burns, 30 to 40 percent carbon dioxide which does not burn, and a trace of hydrogen sulfide which smells like rotten eggs.
- C. Condensation traps are needed to remove water vapor from Biogas pipes.
- D. Biogas (methane plus carbon dioxide) or methane alone can be used for several purposes.
 1. The gas can be used for cooking, gas lights, and gas refrigerators.
 2. The position taken in this book is that the best use for the gas is as fuel for stationary spark-ignition and dual-fuel diesel engines for mechanical power and with generators for electrical power.
 3. It may be possible to use the gas to heat boilers that power simple "rankine-style" engines for mechanical and electrical power.
- E. The carbon dioxide in biogas may have some uses.
 1. Carbon dioxide should not be removed from biogas unless there is a practical use for it. The process of separation must be simple and low cost.
 2. Carbon dioxide can be used in greenhouse operations to increase crop yields, and it may be practical to freeze the carbon dioxide to make dry ice.
- F. The waste heat from engines fueled by biogas or methane must be used to maintain digester temperature at 35 degrees centigrade.
- G. Only when digester capacity is big enough to make the use of an engine practical is it likely that the system will be profitable.

V. Biofertilizer

- A. Biofertilizer is used digester slurry and is often referred to in this book as sludge.

- B. Only when the sludge is used as a fertilizer can a biogas system be profitable.
- C. After the sludge has been exposed to the air for a couple of weeks, it makes an excellent soil conditioner and organic fertilizer for crops and fish ponds.
- D. The liquid portion of the sludge (90 percent) can be recycled and used in place of water to dilute fresh raw materials.

VI. Secondary Biogas System Projects

- A. Flat-plate solar collector water heaters can be used to heat digesters and in a dual-fuel system with biogas to power rankine-cycle engines.
- B. Composting can be a useful and necessary part of biogas systems.
- C. Bioinsecticides can be a safe, simple method of pest control. When bioinsecticides are used with organic fertilizers, there should be an increase in crop yields and a decrease in crop losses.

Preface

BIOGAS SYSTEMS: AN APPROPRIATE TECHNOLOGY SOLUTION FOR PRODUCING FUEL AND FERTILIZER

If you've heard of biogas, odds are you connect it with one of the following: a technology that could make the world or at least the Third World completely or partly independent of fossil fuels, such as oil and coal; or, a "small is beautiful" idea that flopped.

As a Peace Corps Volunteer (Philippines, 1979-81), I spent much of my time working with biogas systems. Most of my first year back in the United States was devoted to the study of biogas technology. The product of my experiences and studies is The Biogas/Biofertilizer Business Handbook.

The purpose of the book is to answer the question: How can appropriate technology biogas systems contribute to the process of rural community development?

The Larger Issues

Biogas technology has been studied and applied in small, medium, and large scale projects since the 1940's and World War II. However, only since becoming a category of appropriate technology (a community development concept of the 1970's) have biogas systems enjoyed widespread success and failure.

Witold Rybcznski repeatedly cautions: "What if biogas plants benefit the rich and not the poor? What if wind machines are often too expensive? What if the solar heater falls apart after six months? What is no one wants to buy homemade soap? What if [appropriate technology]...cannot deliver the goods?" (Paper Heroes: A Review of Appropriate Technology, 1980).

The Canadian Hunger Foundation expands on these considerations by drawing attention to a full range of development needs in both Third World and industrial nations. "Some [groups] strongly advocated smaller-scale, nonpolluting, locally made technology. Their critics initially viewed them as anti-technology or anti-progress. In the face of formidable resistance, these alternative technologies tended to overpromote their cause. Hand, wind, [biogas], and solar power became panaceas [universal remedies]. In retrospect, those advocates generally agree that their emphasis on small scale

was only part of the solution.

"A network of development issues--land reform, education policies, decentralized decision making, suitable consultants, and agricultural and industrial strategies, among others--must also be addressed...[Appropriate technology should ask] what style of progress or industrialization is wanted, what balance between large- and small-scale production is needed, what choices of technology will promote development, and who will participate in the selection of options" (Experiences in Appropriate Technology, 1980).

The ABC's of Biogas

Biogas technology is based on a simple principle: anaerobic digestion. Anaerobic digestion is the biological breakdown of organic matter by living organisms in the absence of oxygen. A liquid organic fertilizer, carbon dioxide, and flammable methane gas are the primary products of the digestion of organic waste by anaerobic bacteria. A natural place for this bacterial activity would be a swamp.

Composting is also based on a simple principle: aerobic digestion. Aerobic digestion involves the breakdown of organic matter by organisms that live in the same oxygen rich environment as we do. Compost fertilizer and carbon dioxide are the main products of aerobic digestion. Diagram 1 charts these two processes for organic decomposition.

The anaerobic digestion of biogas systems takes place in airless metal, concrete, plastic, or brick tanks which can be built under or aboveground. Any of a number of designs are possible, but not all are practical.

A biogas system may be a two to three cubic meter digester with built-in gas storage tank and simple gas stove burner. A biogas system may be one or more 50 to 80 cubic meter digesters with slurry mixing basin, settling, aging and fish ponds, stationary engine, heat exchanger, electric generator, two or more gas storage tanks, and several other auxiliary pieces of equipment. Diagram 2 depicts the basic determinants for the design and capacity of a system.

Basic Q's and A's for Sizing and Using Systems

Are biogas systems primarily for the production of energy? No. Like composting, the primary product is organic fertilizer. Biogas systems have the advantages of producing:

- a more complete fertilizer;
- a more sanitary fertilizer; and e a fuel gas.

At the same time, biogas systems have certain disadvantages:

- the fertilizer is in liquid form; and
- the systems are much more expensive, complex, and susceptible to biological "breakdown" than compost piles are.

Can biogas be run from the waste of a few animals (fecal waste being the traditional organic matter used to fuel digesters)? Yes and no. A biogas system can produce a little methane and fertilizer from daily manure produced by a few pigs or cattle. But small biogas systems will not produce any profits unless subsidized in some way.

DIAGRAM 1

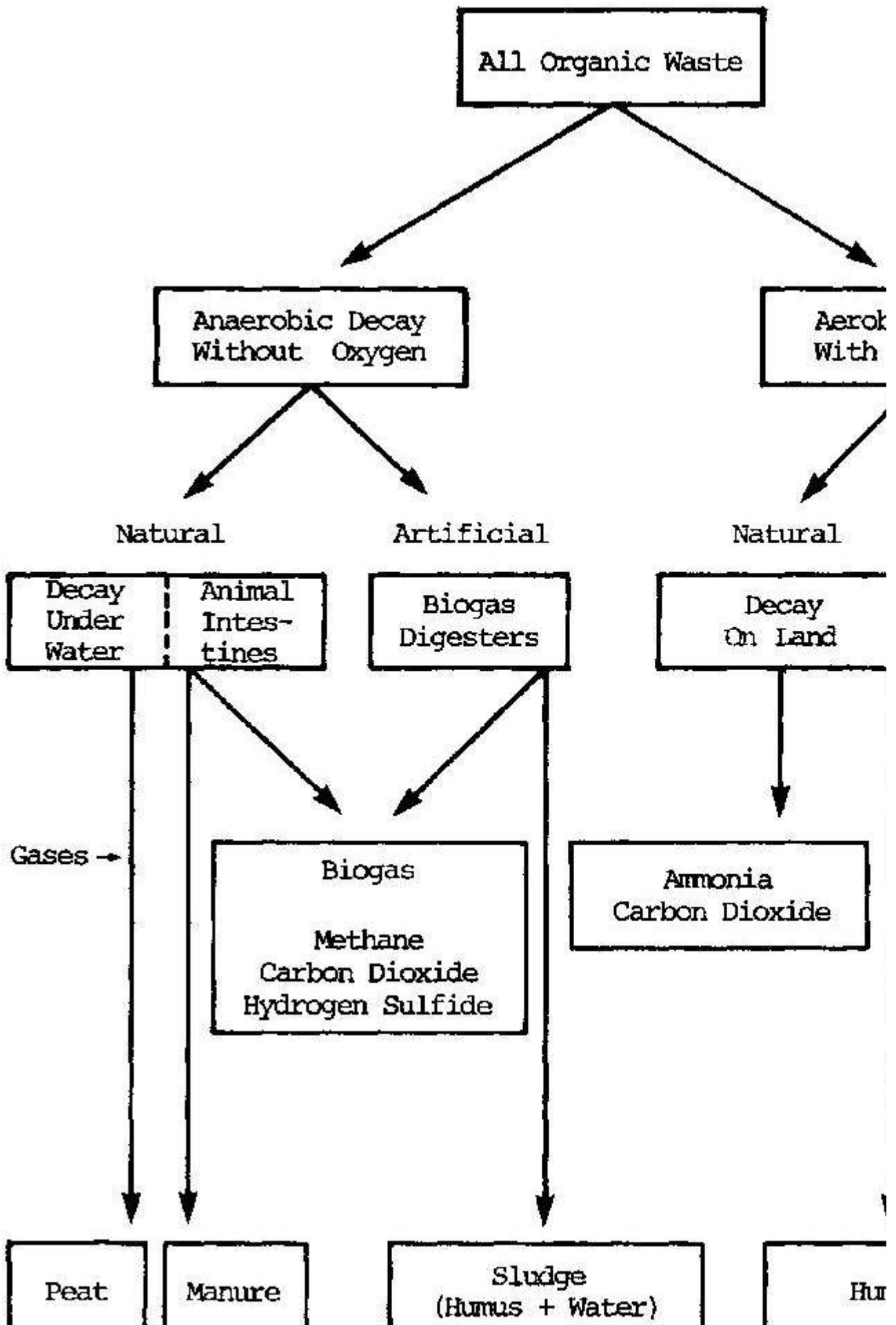
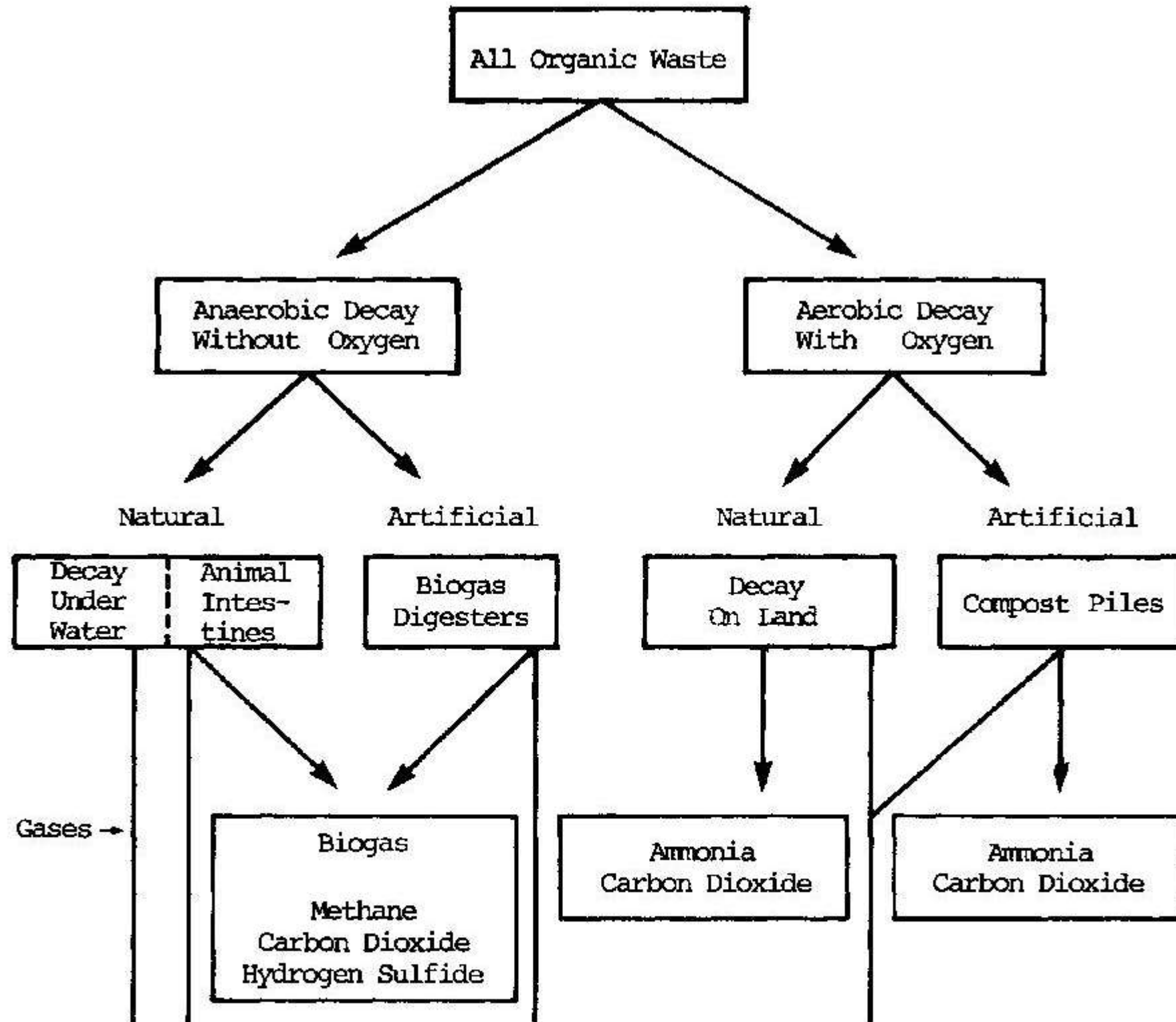
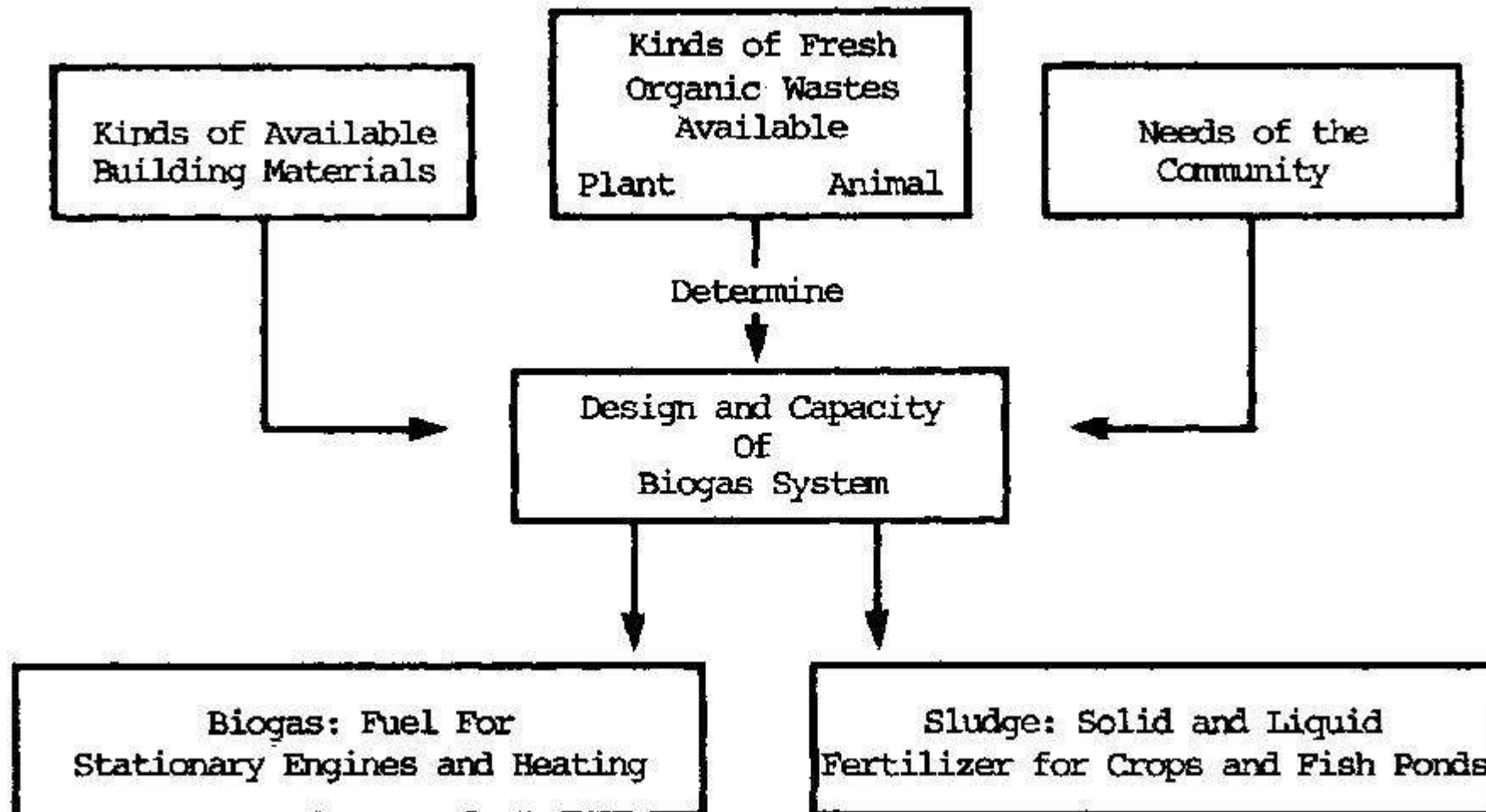

DIAGRAM 1



PROCESSES OF ORGANIC DECAY

DIAGRAM 2



PROCESSES OF ORGANIC DECAY

DIAGRAM 2

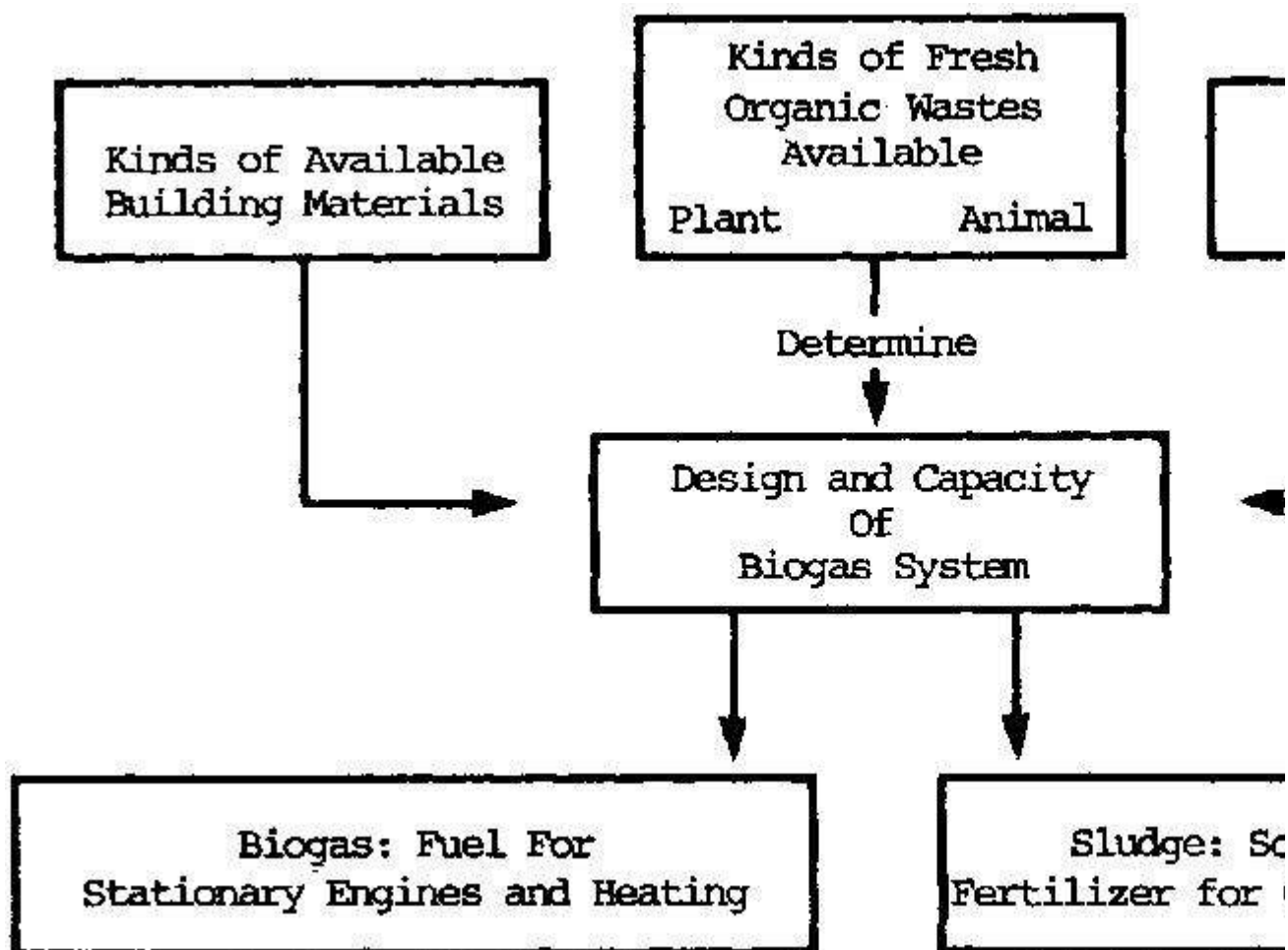

BIOGAS SYSTEMS: INPUTS AND OUTPUTS

What are the primary purposes for building biogas systems?

1) The humus in the organic fertilizer gives nutrients to and conserves the topsoil. Topsoil, the medium in which plants grow, should be seen as a natural resource which is "mined" by farmers. Chemical fertilizers do little in the way of conservation. In fact, chemical fertilizers contribute to the increasing worldwide problem of topsoil erosion. The nutrient value of digester sludge, while harder to quantify than chemical fertilizer, is a high quality fertilizer for crops and fish ponds.

2) Methane (which is 60 to 70 percent of biogas) is the primary ingredient in natural gas, which is a piped gas used to fuel stoves, water heaters, homes, etc. In rural agricultural areas where bottled gas, gasoline, and diesel fuel is expensive, biogas is ideally suited for use in automotive-size stationary engines for the production of mechanical and electrical power.

3) Improved sanitation is a biogas system byproduct. The organic wastes that are processed in the systems would otherwise be breeding grounds for disease-causing bacteria, parasites, and insects.

What is the proper scale and organizational structure of biogas systems? As noted earlier, the scale and structure that is most profitable depends on many factors. One set of technical, political, and

economic conditions can easily generate several different expert opinions.

For the same site, one expert might recommend a high technology biogas business that requires US\$ 30-50,000 in capital; another might suggest many small family systems costing less than US\$ 500 each; and a third expert may prefer a few small businesses or cooperatives needing equipment in the neighborhood of US\$ 3,000 to US\$ 5,000. Naturally, the designers that back a particular scale also champion different viewpoints on technical designs, raw materials, and uses of the products. Defining biogas systems as business enterprises, rather than as modified septic tanks, implies profitably operated systems that require business as well as technical skills.

The viewpoint of The Biogas/Fertilizer Business Handbook is that the small business or cooperative strategy is best. The digester capacities at this scale are 20 to 60 cubic meters, although total system capacities can be several hundred cubic meters. I believe the economies of scale for biogas systems and the technology's potential contribution to community development is optimized at the small business/medium-scale level.

If built as small, backyard operations, biogas systems tend to be too costly. If they are profitable on this level, which is rare, they make an insignificant contribution to the family or community except as status symbols. On the other hand, as divisions of large private businesses, they tend to increase private profits--with few benefits reaching the public.

The scale of Third World small business that best promotes biogas as a tool of community development is the general store and the rice or corn mill. In the United States and other developed countries, the best community development niche for biogas technology is somewhat different. While the most profitable level is still the small business and cooperative, the operation could be spread over a large geographic area. The enterprises could build and operate biogas systems under contract at several sites such as farms, restaurants, and markets.

In urban industrialized communities anaerobic digestion has been used for many decades to produce methane as an energy supplement for waste treatment plants. These systems have their problems: such as dilute slurries (often only 1/5 to 1/10 the concentration of rural biogas systems) and slurries polluted with toxic heavy metals. Many organizations are researching methods that would detoxify and recycle larger quantities of city sewage than is currently practical. Urban sewage based anaerobic systems are relatively complex when compared with the non-sewage applications of anaerobic systems designed for rural agricultural areas.

Biogas and Community Development

Why should biogas systems contribute to the community development process in both the developed and developing worlds? Operated as small businesses or cooperatives, there are several ways biogas technology can benefit a community.

The decentralization of energy and fertilizer production can bring control, profits, and Jobs to the communities that need the energy and fertilizer. Local enterprises are usually locally controlled. Local enterprises tend to buy their supplies and spend their profits in the communities that buy their products. Biogas systems provide a more labor-intensive approach to the production of fuel and fertilizer than fossil fuel and chemical fertilizer technologies.

The raw materials that biogas digesters turn into fuel and fertilizer are organic wastes which, if not processed quickly, can become "hazardous wastes" that host a wide variety of diseases.

Organic fertilizer, the primary product of digesters, is a very important but sometimes unrealized need of agricultural communities. Throughout the world, family farmers are finding themselves increasingly unable to afford the high risks and costs of "modern" farming. This is true in part

because the use of fertilizer is more important to modern farming than it is when traditional methods are used.

A recent U.S. Department of Agriculture study discovered that while organic crop and livestock farmers in the midwest and western cornbelt states often don't get the same high crop yields as their modern neighbors who are dependent on chemical fertilizers, pesticides, and herbicides, the organic farmers have lower costs. This means that net returns per cropland acre of organic farms can be equal to or greater than those of chemical dependent farms (USDA, Report and Recommendations on Organic Farming, Washington, D.C., July, 1980).

The organic farm, which is usually a family farm, is in a mutually supportive relationship with the environment. The success of biogas technology depends on its being understood and applied in that context. The agricultural and AT context of organic farming is part of the social context of community development.

As Michael Todaro notes: "In the absence of appropriate (i.e., more labor-intensive) technologies of small-scale food production, of low-cost housing, of health measures, of small-scale manufacturing [e.g., biogas systems], and of low-cost training and education--attempts to 'get prices right' and even to redistribute assets can be rendered ineffective. The development of an active policy of promoting indigenous local technologies, research and development on relevant problems affecting the levels of living of all people, but especially the poor, may be indispensable to any viable long-run programme of growth without poverty in developing [and developed] countries" (Economics for a Developing World, 1977).

Chapter one: An introduction

This handbook describes biogas system theory, design, construction, and operation principles that are appropriate to the resources and needs of rural communities and small businesses in developing nations. In order to involve and benefit as much of the community as possible, new combinations of proven biogas concepts have been brought together and emphasis has been placed on several aspects of biogas technology that are often overlooked.

A common reason for being interested in biogas is to reduce the cost of fuel used for cooking. Clay stoves cost less, are easier to build, operate, and maintain than biogas systems. When compared with open cooking fires, clay stoves use less of the same fuels, and there is no smoke to get in the cook's eyes.

Profitable biogas systems are small factories that make a fuel that is best used to run stationary engines for mechanical and electrical power, and a fertilizer for fish ponds, gardens, and farm crops. There are many good books on simple wood conserving stoves such as the Lorena clay stove. Volunteers In Technical Assistance (VITA) and Volunteers in Asia have books on how to build and operate these stoves. Their addresses are in the Appendix.

A successful biogas operation, one that makes or saves more money than it costs, is a business operation. The biogas digester is only part of a biogas system: a system that should include a separate gas storage tank, engines to use the gas, ponds, the use of plant as well as animal waste, the production of fertilizer as well as gas, and business as well as technical skills.

What do you want a biogas system for?

- Which biogas purpose is most important to you: gas, fertilizer, or sanitation?
- Will the digester be fed manure, plants, or both?

- Is there enough water and organic wastes to feed a digester that will produce enough gas to run an engine?
- Are there ready uses and/or markets for a fertilizer that is mostly liquid?
- Should a biogas system be built for business, cooperatives, or family needs?
- Should a biogas business also build biogas systems for other people?

These are just some of the questions you will need to ask, and answer, before you can build a biogas system that will meet your needs.

There are many short "how-to" books on biogas. Why is this one so long? There are several reasons.

- With just a few pages of information, a digester can be made that produces biogas, but costs will be greater than profits or savings.
- To invest time and money in biogas is to invest in a business; it is that complicated. But a well run biogas business can be as profitable as any well run business.
- If you understand your business, you can find a solution to almost any problem. If you have enough information, you can make intelligent decisions.

Biogas manuals are often made short and simple in hopes of making biogas systems inexpensive and popular. The result is that many people are attracted to biogas believing that is no more complicated than building and operating a septic tank with a gas pipe connected to a stove. That is a frightening underestimation of the demands of what is in reality a small-scale business, not a backyard hobby. With a short, simple manual as a guide, a biogas digester can be built and operated, but it is very unlikely that it will be profitable. Discouraging people with a long manual is preferable to the disappointment and costs suffered when a project that was presented as simple turns out to be complicated.

Four general ideas guided the design of this handbook.

- 1) Ordinary words should be used as much as possible. Language special to a technical field is an easy short-cut for the expert, but it confuses the beginner. What is common sense to one person is brand new and unfamiliar to another.
- 2) One method of introducing a new concept is to repeat it in different ways.
- 3) All important aspects of a subject should be explored, social as well as technical.
- 4) Reasons should be given, not just how-to instructions. Understanding the why of a process leads to being able to make intelligent decisions on how to improve the process and solve problems not covered in directions.

Several books and magazines were used in writing this book. Unless otherwise noted, these sources are not quoted word for word. When a section is primarily from one source, that source will be acknowledged either at the beginning or end of the section. Ideas within sections are often illustrated by information from experience or other sources, and all source material is edited with the overall viewpoint and purpose of this book in mind. The Sources + Resources section of the Appendix describes the significant books and magazines used in writing this book and the Vocabulary section of the Appendix defines the technical words.

This handbook's start came from a year and a half's experience with a small 0.4 cubic meter capacity demonstration model biogas digester at the home of Doctor and Doctora Mercado in Butuan City, Agusan del Norte, Philippines, while I was a Peace Corps Volunteer. Many experiments, victories, disappointments, and surprises have been produced by that two-oil drum digester and two-oil drum gas storage tank. The digester can produce enough gas to cook rice three times a day plus more fertilizer than can possibly be used in the garden. Much was also learned from research, and studying several other working and non-working biogas digesters in the Philippines.

The following is adapted from the book, Biogas and Waste Recycling--The Philippine Experience by Felix Maramba, the developer of one of the world's most successful, popular, and profitable biogas systems.

The proliferation of biogas systems will uplift the social and economic life in the rural areas.

- It will improve the living conditions by controlling the pollution of the air and waters, and by promoting sanitation.
- It will raise the standard of living by providing the means for economic advancement.
- By utilizing wastes and local materials to serve farming needs, and by making the land more productive through recycling systems of farming, it will create a pattern of rural living that can lead towards self-reliance.

Although perfecting biogas technology requires experimentation, no expensive or complicated equipment is needed to build and operate biogas systems. Biogas systems are made-to-order for farm communities. Plant and animal waste is continuously produced on farms, hence there is a reliable and unending supply of raw materials. Biogas systems are well suited for agricultural power and fertilizer requirements.

After the biogas has been produced, the plant and animal waste is removed from the biogas digesters as a watery sludge. A sludge that retains all of the nutrients contained in the original plants and animal manure. In the Philippines, at Liberty Flour Mill's Maya Farms, it was found that when the manure of four sow units (one sow unit = the sow plus all offspring up to eight months old) is used as the raw material for a biogas digester that sufficient fertilizer will be produced for three crops on one hectare of crop land and 200 square meters of fish pond. The only fertilizer element of which there is not enough is potash, and extra potash can be supplied by the ashes of burnt crop waste.

Last but not least biogas systems control pollution caused by the manure and other farm wastes. Sanitary conditions are promoted by eliminating the manure which breeds flies and spreads diseases. It is known that the use of chemical fertilizers has contributed greatly to the pollution of streams. This pollution can be minimized if organic fertilizer from biogas digesters and compost piles is used as a replacement for chemical fertilizers.

Biogas technology is a new concept, and as is the fate of new ideas, it will encounter initial resistance. It costs money to construct and maintain biogas systems. It requires new techniques in operation. How well will it control pollution and promote sanitary conditions? How good is the fertilizer and feed value of the sludge? How good is the biogas as a fuel? Are biogas systems economically feasible and socially acceptable? A deeper understanding of these questions will go a long way toward general acceptance of biogas systems.

Biogas Biology

What follows is an introduction to the biology of biogas. It helps explain how and why plant and animal waste can become a burnable gas and a quality fertilizer. Understanding the why of biogas

will make it easier to understand how to operate a profitable system.

Millions of years ago the primitive air was composed mostly of carbon dioxide, water vapor, and methane. There was little or no oxygen in the air, and all life lived and moved in a world which would not allow us to survive. We are aerobic, that is, we need oxygen in the air we breathe. It is called free oxygen because it is not combined with any other element. Whatever primitive life existed in the dawn of prehistory was anaerobic, that is, it did not need or use free oxygen in its life processes.

An interesting question is, where was all the oxygen? Answer: It was locked up in iron oxide (oxide: oxygen combined with another element such as iron) deposits, locked up in carbon dioxide, locked up in hydrogen oxide (also known as water), and happily combined with whatever was available. Another interesting question is, why is the air so full of oxygen today? Answer: Green plants.

Photosynthesis means using light (photo), to make (synthesis) the chemicals necessary for life. Plants take in carbon dioxide and "break" it into its parts. They keep the carbon and release the oxygen into the air. Animals take in oxygen and release carbon dioxide. Life is one big balanced circular process--it is very intelligently designed.

Life on the primitive Earth was very simple, there were no animals, there were no photosynthesis plants, and so there was little or no free oxygen. The only important source of oxygen is the activity of green plants. (Protect your local forest!) Slowly, photosynthetic types of plant life developed and covered the Earth, but it took a long time for the oxygen level to build up to any great degree in the air.







As conditions changed on Earth, those life forms which once could live in the open air could not survive the gradually increasing oxygen levels in the air. Today these organisms can only survive in places where the ancient no-free-oxygen conditions still exist, such as in biogas digesters and the bottoms of swamps.

These organisms (mostly bacteria) are still important. In nature everything eventually returns or cycles, and these anaerobic organisms help to return complex organic matter such as plants and animals back to simple organic matter that plants and animals need in order to live and grow.

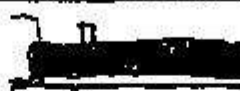
Plant food comes from the air and the soil. Plants take basic elements such as carbon, oxygen, hydrogen, nitrogen, phosphorus, and potassium from the air and soil to make their proteins and carbohydrates. People get proteins from meat, fish, and beans, and carbohydrates from rice, corn, and wheat.

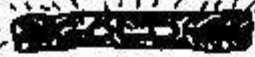
When plants and animals die, their remains, made up of complex molecules, are decomposed (broken down) into simple molecules by organisms such as bacteria and returned to the soil and air. In airless places such as swamps, lakes, and slow stream bottoms, the only way plant and animal remains can be broken down is by becoming food for anaerobic types of life.

DIAGRAM 3: FUEL AND FERTILIZER

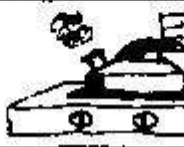
CAPITAL INTENSIVE (more machines, equipment, buildings)	LABOR
 <p>ONE LARGE COAL-BASED FERTILIZER PLANT IN THE CITY</p>	
 <p>TOTAL COST</p> <p>\$140,000,000</p>	
<p>\$70 MILLION</p> <p>FOREIGN EXCHANGE COST</p> 	<p>MONEY ONE</p>
<p>JOBS 1,000</p> 	
<p>ENERGY CONSUMED</p> <p>0.1 MILLION MWH/YEAR</p> 	

Two Ways of Producing 230,000 Tons of Nitrogen-rich Fertilizer

-The systems in this chart cost US\$ 4,800 each in India (1975), and each produced 140 cubic meters of biogas per day.

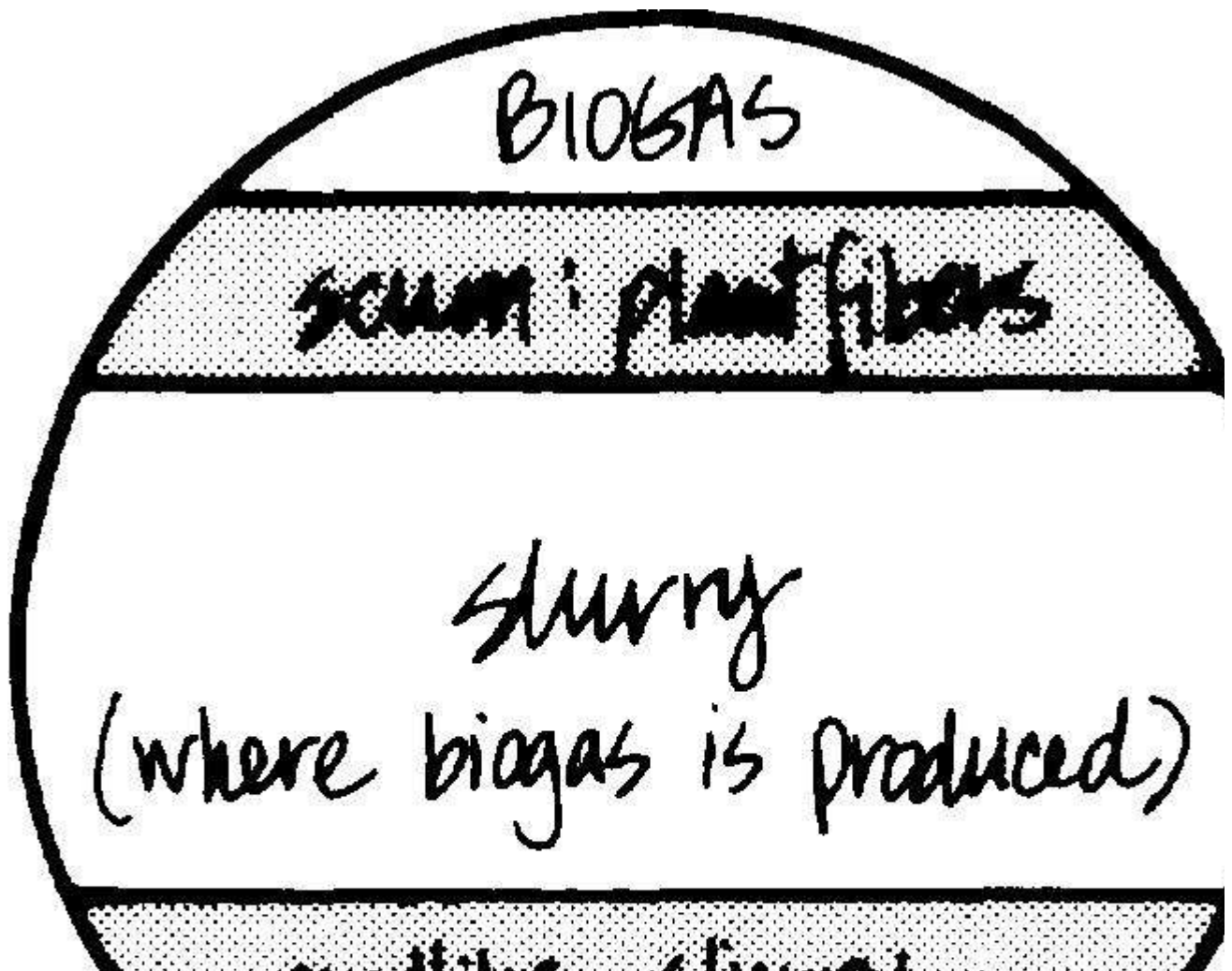

the oxygen into the air. Animals take in oxygen and release carbon dioxide. Life is one big balanced circular process--it is very intelligently designed.

Life on the primitive Earth was very simple, there were no animals, there were no photosynthesis plants, and so there was little or no free oxygen. The only important source of oxygen is the activity of green plants. (Protect your local forest!) Slowly, photosynthetic types of plant life developed and covered the Earth, but it took a long time for the oxygen level to build up to any great degree in the air.

As conditions changed on Earth, those life forms which once could live in the open air could not survive the gradually increasing oxygen levels in the air. Today these organisms can only survive in places where the ancient no-free-oxygen conditions still exist, such as in biogas digesters and the bottoms of swamps.

These organisms (mostly bacteria) are still important. In nature everything eventually returns or cycles, and these anaerobic organisms help to return complex organic matter such as plants and animals back to simple organic matter that plants and animals need in order to live and grow.

Plant food comes from the air and the soil. Plants take basic elements such as carbon, oxygen, hydrogen, nitrogen, phosphorus, and potassium from the air and soil to make their proteins and carbohydrates. People get proteins from meat, fish, and beans, and carbohydrates from rice, corn, and wheat.

When plants and animals die, their remains, made up of complex molecules, are decomposed (broken down) into simple molecules by organisms such as bacteria and returned to the soil and air. In airless places such as swamps, lakes, and slow stream bottoms, the only way plant and animal remains can be broken down is by becoming food for anaerobic types of life.

DIAGRAM 3: FUEL AND FERTILIZER

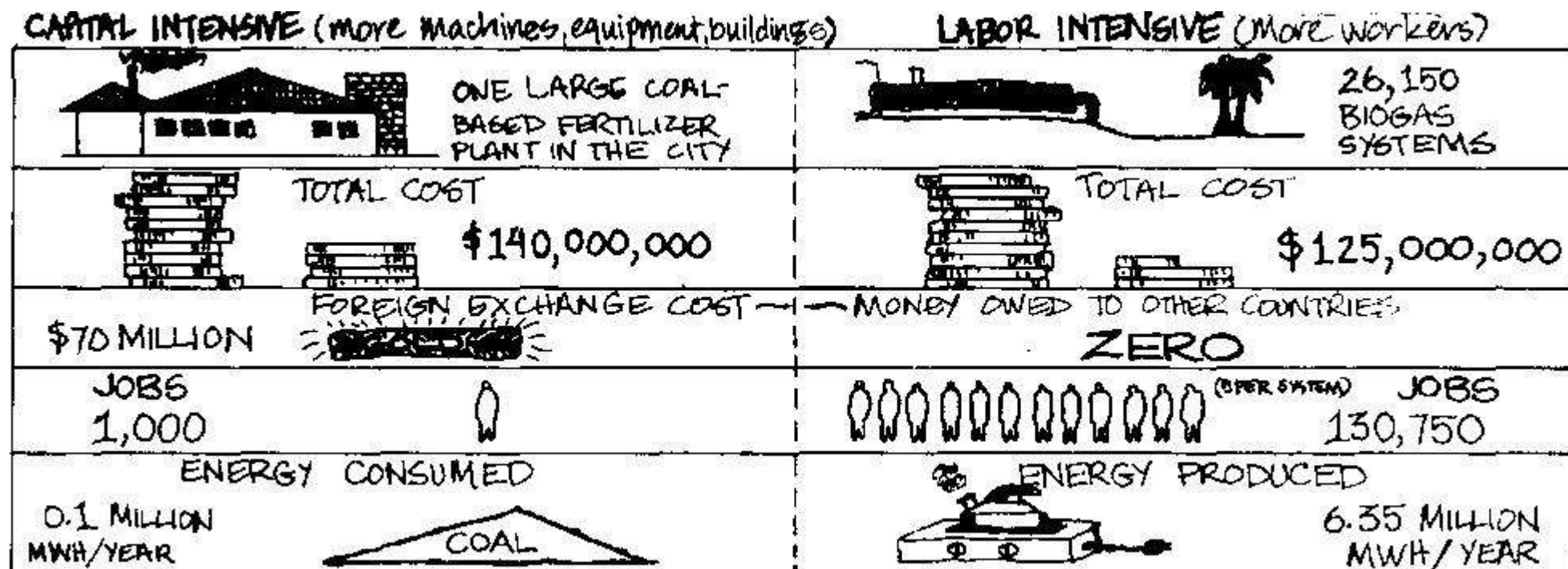

Two Ways of Producing 230,000 Tons of Nitrogen-rich Fertilizer

-The systems in this chart cost US\$ 4,800 each in India (1975), and each produced 140 cubic meters of biogas per day.

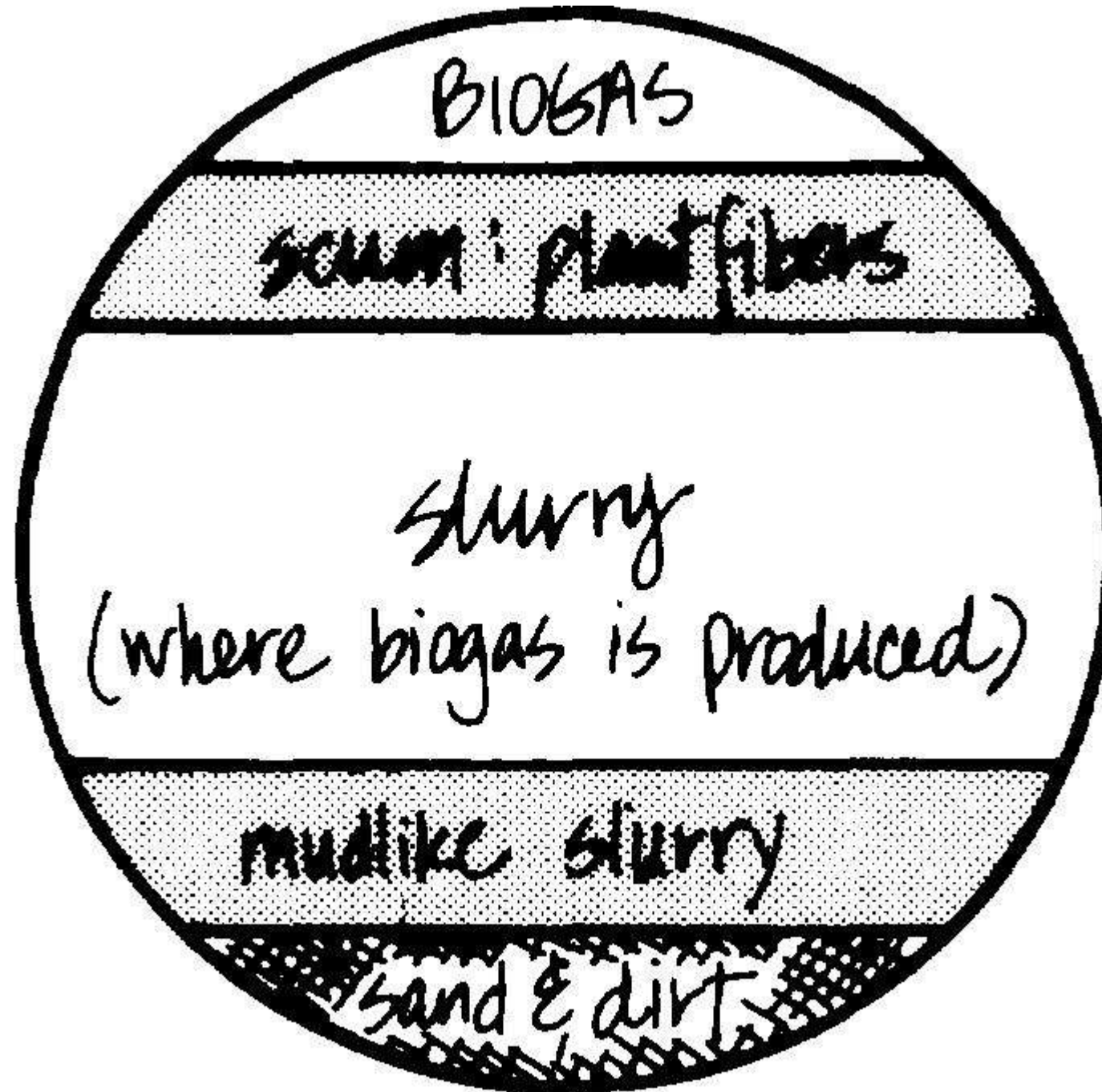

The Layers Inside A Digester

The Layers Inside A Digester

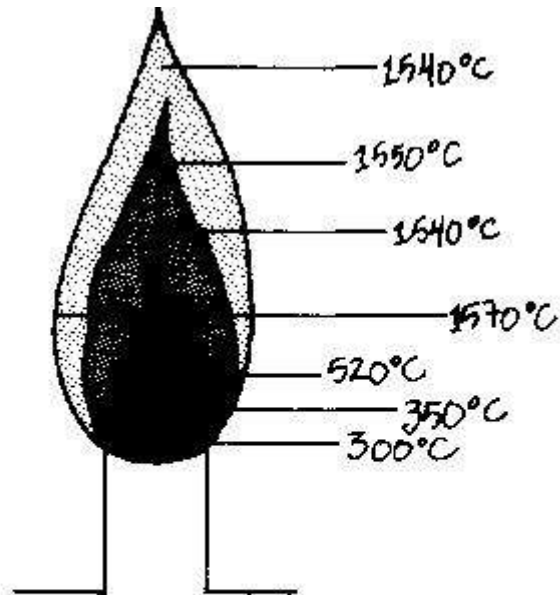

Only the top of flame should touch the cooking pot for most efficient use of gas.

Biogas Flame Temperatures

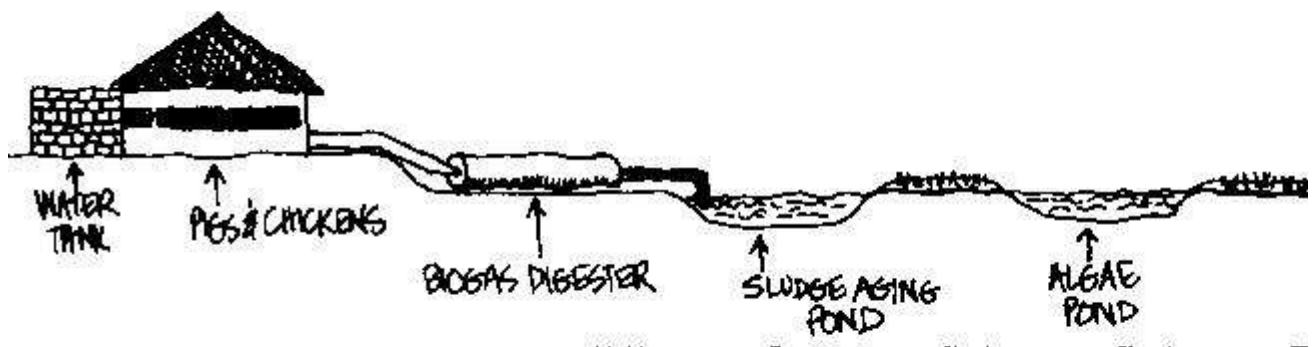

adapted from Lik-lik Buk, a rural develop

adapted from Lik-lik Buk, a rural development handbook

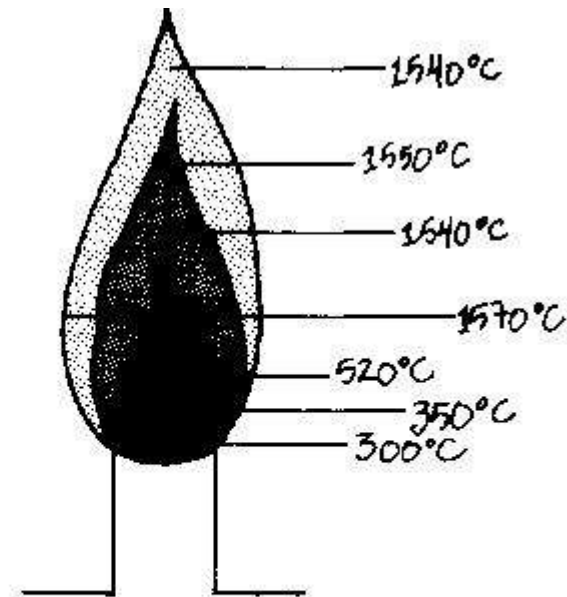

Only the top of flame should touch the cooking pot for most efficient use of gas.

Biogas Flame Temperatures

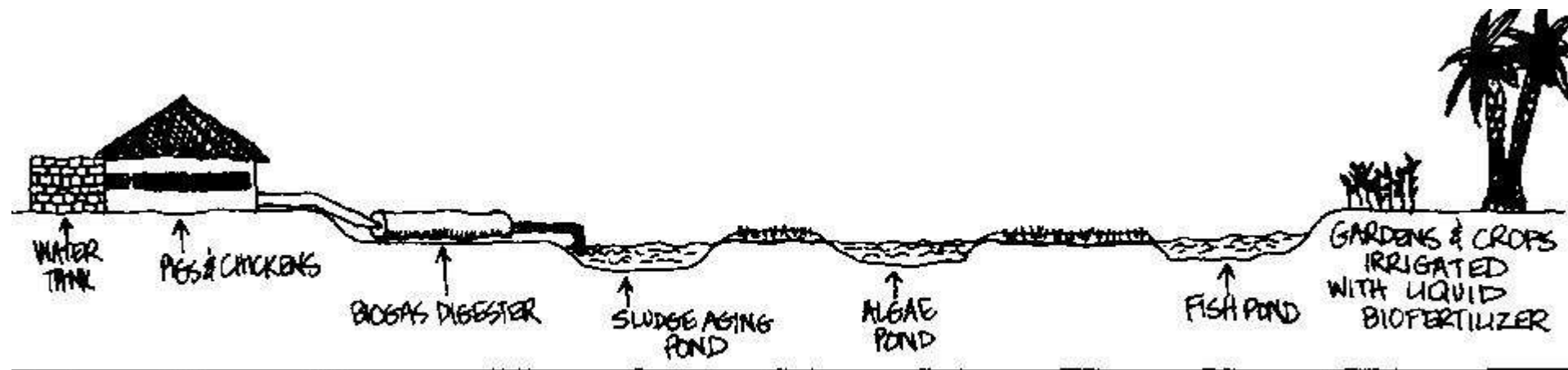

adapted from Lik-lik Buk, a rural development handbook

adapted from Lik-lik Buk, a rural development handbook

Another place where anaerobic bacteria help is in the digestive tracts of many creatures. Termites use them to break down the wood they eat. Cud-chewing animals such as cattle have

Another place where anaerobic bacteria help is in the digestive tracts of many creatures. Termites use them to break down the wood they eat. Cud-chewing animals such as cattle have many anaerobic "little bitty buddies" in their complex digestive tracts which help them to break down the plants they eat. The two main places where we find anaerobic life today are underwater and in digestive systems. A biogas digester is, in a way, an artificial digestive system.

Anaerobic metabolism, the internal life process of oxygenless bacteria, is not as efficient as aerobic metabolism. Anaerobic bacteria cannot use as much of the energy in their food as aerobic bacteria can from their food. Anaerobic bacteria lose much of their food energy when they give off methane gas--too bad for the bacteria, but just what we want.

When compost is made in the open air, aerobic bacteria take part in the rapid breakdown of organic matter. The temperature inside a compost pile is often as high as 70 degrees centigrade (160° F) during its most active period. Similar organic wastes, when placed in the airless world of a biogas digester, produce very little heat, decompose slowly, and as a by-product release most of the energy which was locked up in the organic molecules--still locked up as flammable methane gas.

This difference between aerobic and anaerobic metabolism, in regard to their ability to efficiently use biological energy, also shows up in the fact that the process inside a biogas digester is easier to upset than the process inside a compost pile. Changes in temperature, types of organic waste, and levels of toxic (poisonous) matter which would not harm the aerobic compost process, will slow down or even stop the anaerobic biogas process.

Understanding the breakdown of molecules for energy is really quite simple. Suppose there is a coil spring between your hands. When you force your hands together and lock your fingers together, the spring will try to push your hands apart, and your fingers will keep them together. It took force to bring your hands together, and now the spring stores potential energy, locked between your hands. In a similar way, atoms, which are the building blocks of all matter, are locked together to form molecules, and in doing so they store energy between them. When they are unlocked, energy is released.

When we put atoms like carbon and oxygen together, one carbon atom and two oxygen atoms, we get a molecule of carbon dioxide (CO₂). Two hydrogen and one oxygen gives us a molecule of water (H₂O). One carbon plus four hydrogen is a molecule of methane (CH₄). These are very simple molecules (combinations of atoms), but nature often puts together hundreds of atoms of many different kinds and comes up with very complex molecules.

If a molecule is unstable, the locks in it are not very good, and it may break apart very easily. More stable molecules are harder to break apart, just as your pushed-together hands would be hard to break apart if you had strong fingers, or if your hands were tied together with rope.

In everything that is or was alive, molecules are broken apart or formed, not by force, but with the help of enzymes. Enzymes are complex products of living organisms that cause or speed up chemical reactions. In the spring-hands-fingers model, a little grease or oil would act as an enzyme, causing the fingers to slip apart and the stored energy to be released. If the hands were tied together with rope, an enzyme would act like a pair of scissors, cutting the rope.

In a biogas digester, enzymes break complex molecules apart, step by step, into simpler molecules. The process has been compared to an assembly line, except that it is a disassembly line, where one group of workers take apart complex molecules, give the less complex molecules to another group of workers, who disassemble them further, and so on until the last group of workers breaks the molecules into the simple molecules: water (H₂O), carbon dioxide (CO₂) and methane (CH₄).

A biogas digester is like a factory (you are the boss), filled with workers, busy manufacturing gas and fertilizer from organic materials. Inside the factory, decay happens in steps:

- 1) Aerobic: Oxygen enters with the manure, plants, and water. First aerobic bacteria use up the oxygen. They also do what they can to break the materials down. Carbon dioxide is released and some heat is produced.
- 2) Enzymes: In this stage, anaerobic bacteria releases enzymes which attack the large organic molecules in what was manure and plants in order to break them down into bite-size pieces.
- 3) Acid digestion: The bite-size molecules, still fairly large, are absorbed by bacteria and digested (eaten). The main products of this process are simple molecules, the majority of which are short chain fatty acids, hydrogen, and carbon dioxide.
- 4) Gas digestion: Now comes the part we have been waiting for. The fatty acids are used as food by the last group of bacteria. These bacteria produce water, hydrogen sulfide, carbon dioxide, and best of all, methane. It is methane, mixed with carbon dioxide and a few other trace gases, that we call biogas (House, 1978).

DIAGRAM 4: THE PARTS OF A BIOGAS SYSTEM

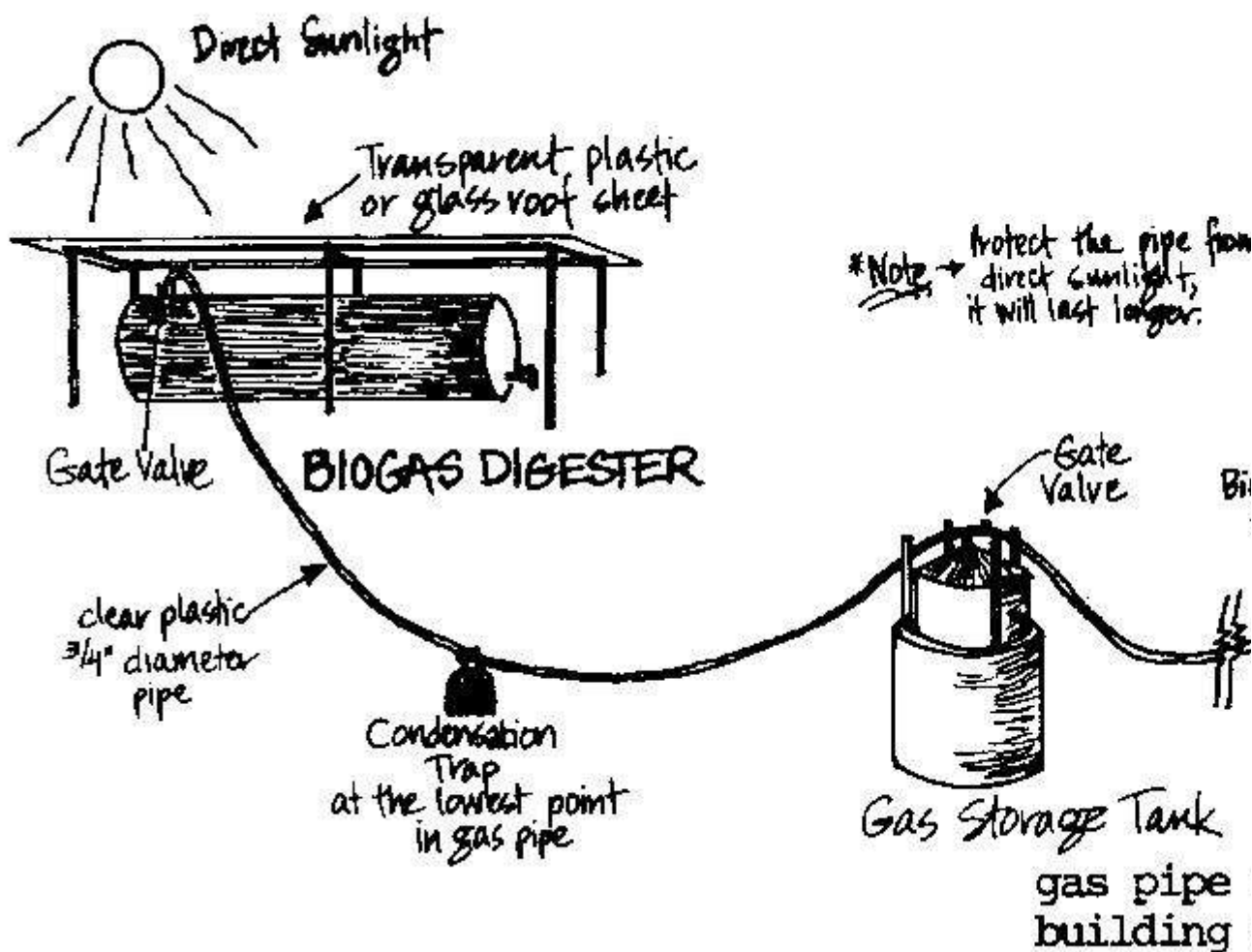

gas pipe to an engine and generator building and/or kitchen stove

4) Gas digestion: Now comes the part we have been waiting for. The fatty acids are used as food by the last group of bacteria. These bacteria produce water, hydrogen sulfide, carbon dioxide, and best of all, methane. It is methane, mixed with carbon dioxide and a few other trace gases, that we call biogas (House, 1978).

DIAGRAM 4: THE PARTS OF A BIOGAS SYSTEM

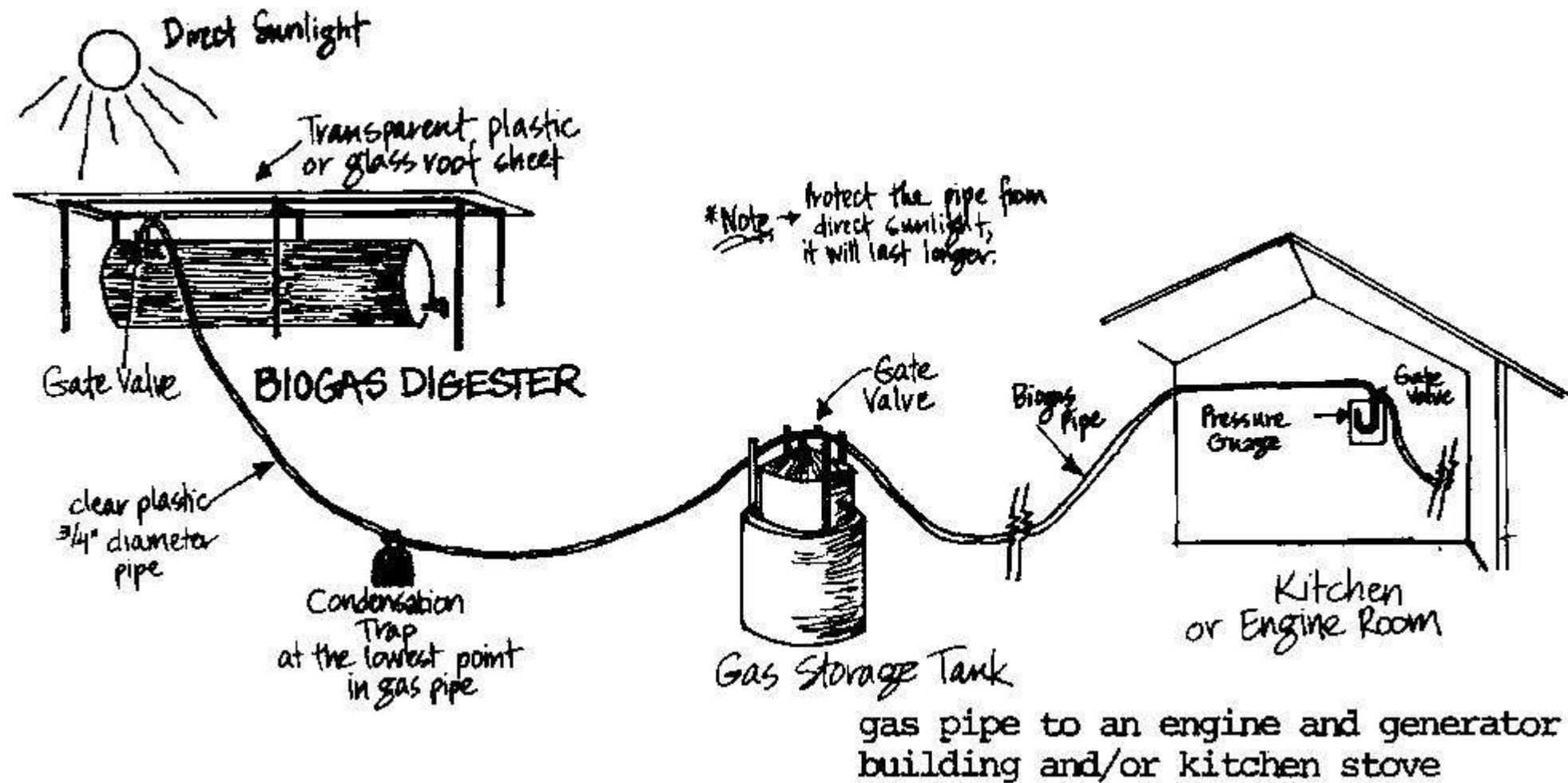

gas pipe to an engine and generator building and/or kitchen stove

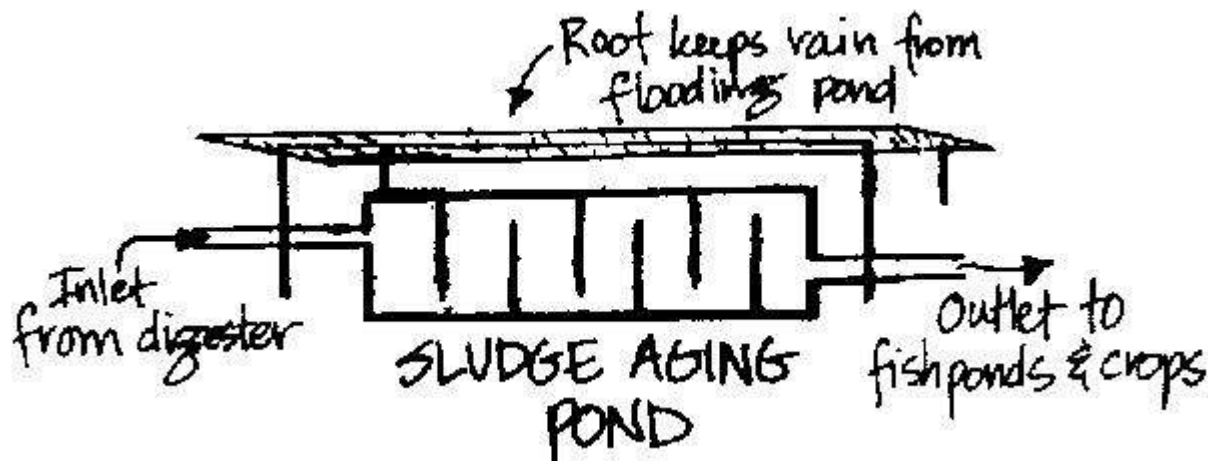

SLUDGE AGING POND

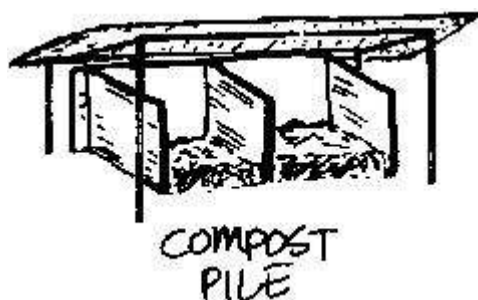

COMPOST PILE

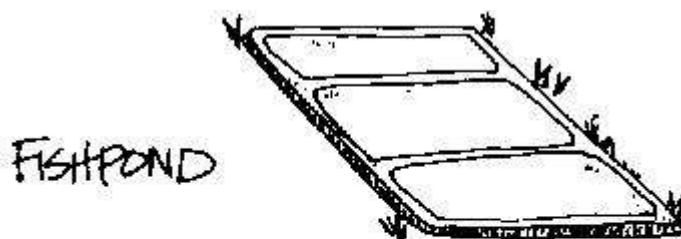

The aged sludge from a biogas digester is a good fishpond fertilizer.

FISHPOND

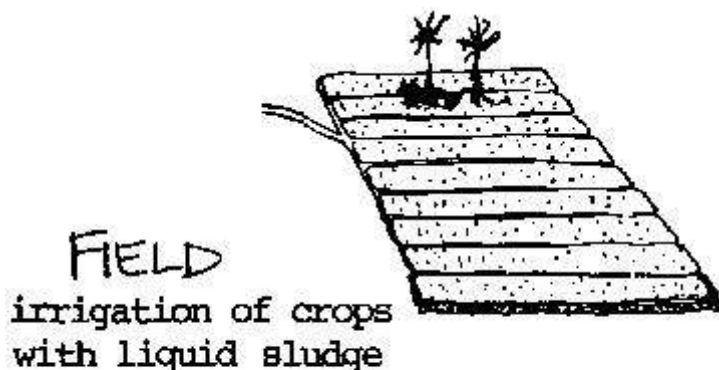

Plant waste is fuel for the biogas digester and compost pile.

FIELD

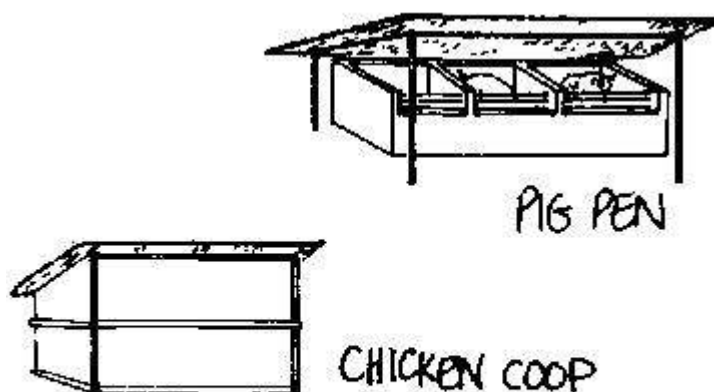

The manure is fuel for the biogas digester.

CHICKEN COOP & PIG PEN

Chapter two: Biogas systems are small factories

What design should be used in building a biogas digester? There are dozens of variations on two basic kinds of digesters. The design described in this book--an above ground, continuous-feed displacement digester with a separate gas storage tank--was chosen for several reasons. This design costs more to build than some other designs, but it produces more gas and a more sanitary fertilizer than most. It is also relatively easy to build, operate, repair, and to make profitable.

Digesters can be designed for either batch feeding or continuous feeding. Batch digesters are completely filled with a mixture of organic waste and water to make a slurry. The digester is then closed and left to digest as long as a sufficiently high level of biogas is produced. When gas production has slowed or stopped, the digester is emptied and then refilled with a new batch of slurry. Batch digesters have advantages where the availability of organic waste is not continuous or is limited to coarse plant waste. Batch digesters require little daily attention, but they do require a great deal of work to empty and load, and the gas and fertilizer production is never constant. This problem can be solved by building several batch digesters that are filled on different days and are all connected to the same gas storage tank. This can be expensive, but it guarantees a relatively constant supply of gas. Unconfirmed experiments at the Indian Institute of Technology have discovered that the nitrogen-phosphorus-potassium fertilizer value of sludge (digested slurry) is 30 percent less for batch-fed digesters than it is for continuous-fed digesters.

With continuous-fed digesters the slurry is added at regular intervals, usually every morning, and an equal volume of sludge is removed from an outlet opposite the inlet at the same time. The rate of gas and fertilizer production from even one continuous-fed digester is more or less constant. Continuous-fed digesters are made in two basic designs: vertical and horizontal. Vertical digesters are usually round or square tanks built underground and are as tall as, or taller than, they are wide or long. Horizontal digesters are usually built above ground and are much longer than they are wide or tall.

The horizontal (above ground) design has several advantages over the vertical (underground) design:

1) In the vertical digester organic waste often escapes being "eaten" by the bacteria. Slurry added one day can easily be withdrawn soon afterwards at the nearby outlet, as incompletely digested waste. In

horizontal digesters the slurry must pass an area of maximum digestion on its way from inlet to outlet, with no part of the slurry spending less time in the digester than any other part.

2) From a practical point of view, above ground digesters are easier to get at to repair and clean than underground digesters.

3) The problem of large scum layers is less for horizontal digesters because they have a larger slurry surface area than vertical digesters of the same size.

4) Horizontal digesters do not usually have to be repaired or cleaned as often as vertical digesters.

5) Given equal size and other factors, horizontal digesters will produce more biogas than vertical digesters (Merrill and Fry, 1973).

How big should the digester be? Some points to think about:

1) An average size family will need a two or three cubic meter capacity digester and a large family a three or five cubic meter digester, if the biogas is only used for cooking. Because of their small size, family digesters often cost more to build and operate than they are worth.

2) A limiting factor when deciding what size digester to build is the quantity and quality of available organic waste and water.

3) Plant waste, when prepared correctly, can produce biogas and biofertilizer without manure having to be used at all.

4) Gas production can be increased at the expense of fertilizer production by using the liquid portion of the sludge taken out of the digester, instead of water, to dilute the fresh waste going into the digester.

5) Unheated digesters will produce less gas and a less sanitary fertilizer during cold weather and rainy seasons, than they will during hot times of the year.

6) Biogas systems are more likely to be profitable when they are part of businesses such as piggeries, slaughter houses, mills, market places, restaurants, and agricultural cooperatives. These businesses have access to large quantities of organic wastes, and they can use or sell the fuel and fertilizer. They have the necessary management skills to run a biogas system as a business. A small business biogas system could be as small as ten cubic meters or bigger than 100 cubic meters.

The important question is not the size of the system, but rather: Can the needs be met by the resources in a way that does not cost more than it is worth?

Building

Information on building concrete digesters is in the Ferrocement section of the Appendix. Ferrocement information is presented separately because it goes into extensive detail. It can be used for any concrete construction project, not just for biogas digesters.

Metal digesters and metal gas storage tanks can be made by the same companies that make metal water tanks. The digesters and gas tanks should be made at the site where they will be used, and the welding and painting of the tanks should be done with great care. There are more details on metal digester construction in the Appendix, and more details on metal gas storage tanks in Chapter Six.

Biogas digesters should be built above ground for several reasons. (At most, only a few inches of the

digester should be underground.)

- The closer the temperature of the slurry (the mixture of organic waste and water) inside the digester is to 35 degrees centigrade/95 degrees Fahrenheit, the better it will be for the biogas producing bacteria.
- Underground digesters in hot climates will always be cooler than above ground digesters in the same areas, which means underground digesters will, everything else being equal, produce less gas.
- In climates with cold weather, the extra expense of heating digesters will prove more profitable in the long run than avoiding some of the cold by building underground.
- High water tables and the chance of flooding is another problem for underground digesters, and underground digesters are harder to clean than above ground digesters.
- The main advantage to building underground is that the dirt will help support the digester walls. The walls do not have to be as strong or expensive as the walls of above ground digesters. But if an above ground digester is made well, the increased construction costs can be rewarded with increased biogas production and a higher quality fertilizer.

It is often easier to put slurry in an underground digester because the slurry can flow down into it. But again, one-time savings in construction costs do not outweigh the continuously higher savings or profits of an above ground digester's higher gas production rate. Slurry loading ramps can be built if a down hill site cannot be found for an above ground digester. But there is nothing that can be done for an underground digester that has production costs that are higher than the value of the gas and fertilizer.

Greenhouses are buildings with glass or plastic walls and roofs in which plants are grown when it is too cold outside. Greenhouses let in the sunlight and trap the heat of the sun. When a greenhouse is built around a digester, an unheated digester will produce more gas than it would have and a heated digester will need less heat to produce biogas at the maximum rate. Greenhouses should not be completely sealed; as a safety measure to allow an exchange of air, there should be vents at the top of greenhouse roofs from which the biogas could escape if there was a leak in the digester. Biogas digesters have traditionally been made with concrete (underground digesters with brick or hollow block). But metal, plastic, and fiberglass can also be used to construct digesters (and gas storage tanks) using the designs and operation methods described in this book.

There are advantages and disadvantages to all possible construction materials.

- Concrete (using the ferrocement method) may be the cheapest method, but concrete digesters cannot be moved.
- Concrete digesters have to be very carefully made if they are to be watertight and airtight.
- Concrete will stay warmer at night longer than metal or plastic, and that means more gas.
- Metal can rust; the welding and painting must be done perfectly.
- The zinc in galvanized iron can kill biogas producing bacteria, so the inside walls of metal digesters must be painted.
- Once made, plastic and metal digesters are less likely to leak. When empty, plastic bag digesters can be moved. e Plastic and concrete will not rust....

This list could go on and on--the choice of building materials should be decided by using the material(s) that are affordable, available, and best suited to local resources and needs.

It is important to keep the proportion of length to diameter (or surface area of a cross section--which is width x height) of a digester to within certain limits (see chart in Appendix):

1) If a digester is too long and thin, the fresh slurry will not mix properly with the active bacteria and the digestion process will be slow in starting. Fresh slurry should come into contact with the slurry of previous days, which in turn, should be in the active stages of decomposition leading to the final stage of methane production.

2) If a digester is too short or too wide, the physical and biological steps will not be spread out enough. Square and round digesters produce less gas and a less sanitary fertilizer than long digesters. Today's fresh slurry is mixed at random with previous slurry, some will be taken out before it has been completely digested, and some will stay in the digester long after it has been completely digested.

3) The proportions of diameter to length of a digester is not very critical. A ratio of five in length to one in diameter is best. Ratios between 8/1 and 3/1 length to diameter are the outside extremes of digester proportions. Any digester which is longer and thinner or shorter and fatter will not produce as much gas and quality fertilizer as a digester of the same capacity, but with a better shape.

All biogas digesters should be built with a two to three degree tilt, starting at the inlet and going downhill towards the outlet. With a tilt which is less than two to three degrees, the slurry will not move through the digester fast enough. With a tilt greater than two to three degrees, the slurry will race through the digester too fast (Fry, 1974).

Money

A very difficult question to answer is, "How much does a biogas digester cost?"

- First of all, there is much more involved than just a digester. There are also gas storage tanks, ponds, engines, generators, pipes, valves, tools, and so on.
- Then there are questions such as which building materials are going to be used and what are local labor costs?
- One thing is for sure, once a biogas system is built, the major expenses are finished. Each year after construction, the costs of producing fuel and fertilizer (as a percentage of investment), should go down. Commercial fuel and fertilizer prices will without a doubt go up.

The following cost information comes, in part, from an article on biogas in the October, 1980, issue of "VITA NEWS."

Cost estimates for biogas systems vary widely depending on design, size, location, building materials, labor costs, and the method used to figure the costs. The Chinese claim to be able to build their underground digester for less than US\$ 100. However, this estimate has been challenged for not including true labor and material costs. Another problem with the Chinese digester is that it produces very little biogas. In China they are producing biogas at the rate of 0.2 to 0.3 cubic meters (per cubic meter of digester space per 24 hours) and one fourth that rate during the winter.

The design suggested in this book can produce four to ten times as much gas per day than the Chinese design can in the summer. One reason the Indian digester design has not become more popular in India and elsewhere is its high initial capital costs when compared with the value of its products. A

single family unit costs US\$ 375. Although this is several times the average annual individual income in rural areas, the Indian digester is promoted as a family investment, not a business investment. Another fact to think about is that many, maybe even most, of the Chinese and Indian model digesters that have been built around the world have also been abandoned.

The high price of biogas systems has increased interest in building and using biogas systems on a business and cooperative scale, instead of on a single family scale. That business or cooperative could be a group of relatives, neighbors, or friends, or it could be a restaurant, market place, hospital, fish farm, or even a whole village.

There are at least six steps to making a cooperative or business biogas system profitable. The system must:

- 1) include fish ponds and/or other uses for the fertilizer that is produced,
- 2) be large enough to benefit from the addition of a stationary engine to the system, fueled by the biogas, and heating the digester with the excess engine heat,
- 3) consider making financial payments to the investors in the business or cooperative as an alternative to using the fuel and fertilizer as payments,
- 4) consider trading for or buying organic wastes for the digester,
- 5) consider building central piggeries, chicken coops, and cattle stalls animals owned by cooperative members or business partners in order to collect as much organic waste as possible.

Practical experience with small business and cooperative biogas systems is still limited. But there do appear to be real economies of scale. The bigger a digester is, the more profitable it can be.

Making a feasibility study can provide an organized structure within which the many important questions of a beginner in the biogas business can be answered. Questions such as: What types and quantities of organic waste are available locally? How big should the business be, in the first year, in the second year? Is there enough water available to make the slurry? What about the local infrastructure? Are there markets for the fertilizer? Will the local banks provide loans? Can local construction companies build a biogas system? Are there government programs that can provide financial or technical help? (An outline of a feasibility study is in the Appendix.)

Success

Maya Farms, which has its own large scale biogas system in the Philippines, is now in the business of building biogas systems for other businesses. What follows is adapted from an article in the "Philippine Farmers Journal" of November, 1980, about the Maya Farms biogas systems construction business. Businesses interested in contact Maya Farms can write to them at the Maya Farms address given in the Appendix.

Foremost Farms, considered the biggest and the most modern pig farm not only in the Philippines, but also in Asia, has contracted Maya Farms to build a biogas system for them. The system when finished will produce up to 765 cubic meters of biogas every day.

The services of a Maya Farms biogas system contract include: site survey, biogas system design, construction, and the supervision and training of personnel who will later operate the system.

Maya Farms experts first survey the site to determine its topography, the water table, and the space available for a biogas system. Then they make the designs and plans. The farm owner has the option

of hiring local contractors to build the biogas system, but they have to be supervised by an engineer from Maya Farms. The engineer lives in with the workers until the construction is finished.

It is also included in the contract for Maya Farms to train the people who will eventually operate the biogas system. Specifically, they teach the people involved how to make the necessary adjustments for appliances, engines, and generators which will be fueled by the biogas, and how to process the solid sludge into a feed supplement and the liquid sludge as crop irrigation or fish pond fertilizer. Maya Farms also handles contracts where the client operates the biogas system with a Maya Farms supervisor.

The size of the biogas systems depends mainly on the site and size of the farm. Most of the systems are continuous-fed, multi-digester systems, and they range in size from 255 cubic meters of biogas per day to 765 cubic meters of biogas per day. Although contract prices amount to thousands of pesos, it is very reasonable and worth the investment, considering that biogas systems can last for a lifetime, providing fuel, feed, and fertilizer.

To date, the Bio-Energy System Division of Maya Farms has 12 big clients. Of these, four are already operating their systems [Aries Agro-Industrial Dev. Corp. of Laguna, Multi-Farm Agro-Industrial Dev. Corp. of Cebu, Aveco Farms of Pangasinan, Cardova Farms of Batangas], five are under construction [Green Field Piggery & Agricultural Corp. of Bulacan, Reliance Agricultural Dev. Corp. of Bulacan, San Victores Dev. Corp. of Bulacan, Gold Star Piggery Farms of Bulacan, Monterey Farm Corp. of Lipa City], and three are in the planning stage [Console Farms of Bulacan, Remman Ent. Corp. of Batangas, Foremost Farms Inc. of Rizal].

DIAGRAM 5: ROUND BIOGAS DIGESTERS

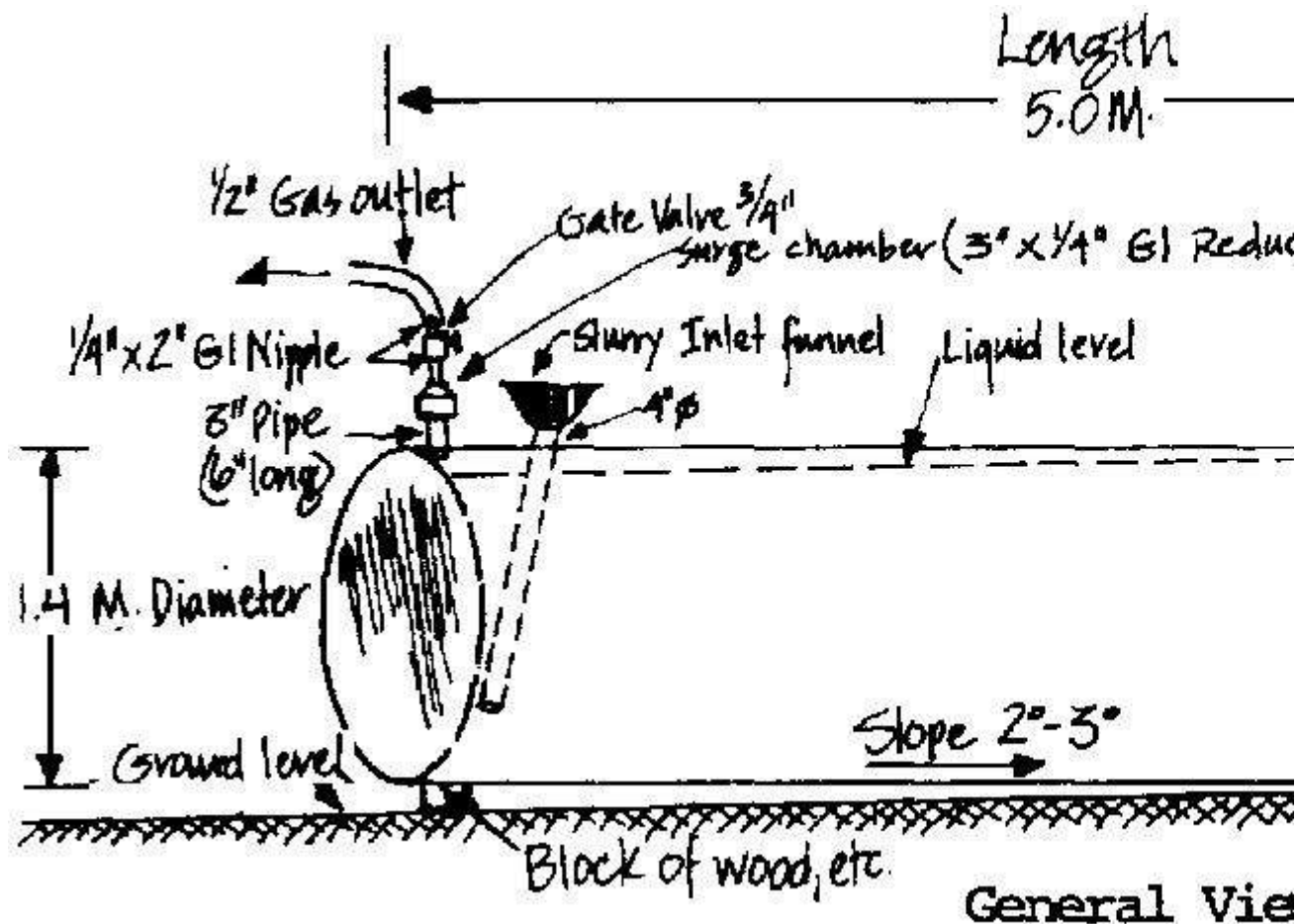

Inside measurements: length 6.9 meters, diameter 1.4 meters, capacity 10.6, metal model (plastic or

meters of biogas per day to 765 cubic meters of biogas per day. Although contract prices amount to thousands of pesos, it is very reasonable and worth the investment, considering that biogas systems can last for a lifetime, providing fuel, feed, and fertilizer.

To date, the Bio-Energy System Division of Maya Farms has 12 big clients. Of these, four are already operating their systems [Aries Agro-Industrial Dev. Corp. of Laguna, Multi-Farm Agro-Industrial Dev. Corp. of Cebu, Aveco Farms of Pangasinan, Cardova Farms of Batangas], five are under construction [Green Field Piggery & Agricultural Corp. of Bulacan, Reliance Agricultural Dev. Corp. of Bulacan, San Victores Dev. Corp. of Bulacan, Gold Star Piggery Farms of Bulacan, Monterey Farm Corp. of Lipa City], and three are in the planning stage [Console Farms of Bulacan, Remman Ent. Corp. of Batangas, Foremost Farms Inc. of Rizal].

DIAGRAM 5: ROUND BIOGAS DIGESTERS

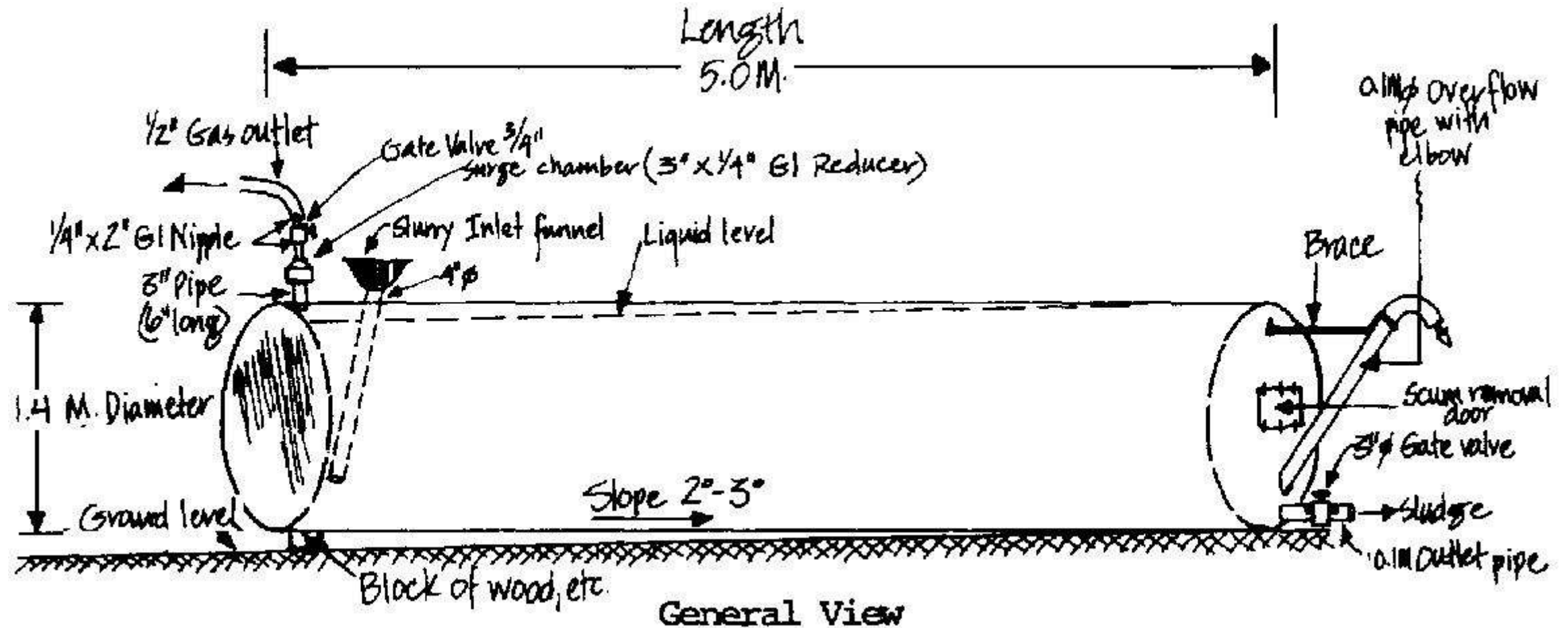

Inside measurements: length 6.9 meters, diameter 1.4 meters, capacity 10.6, metal model (plastic or ferrocement)

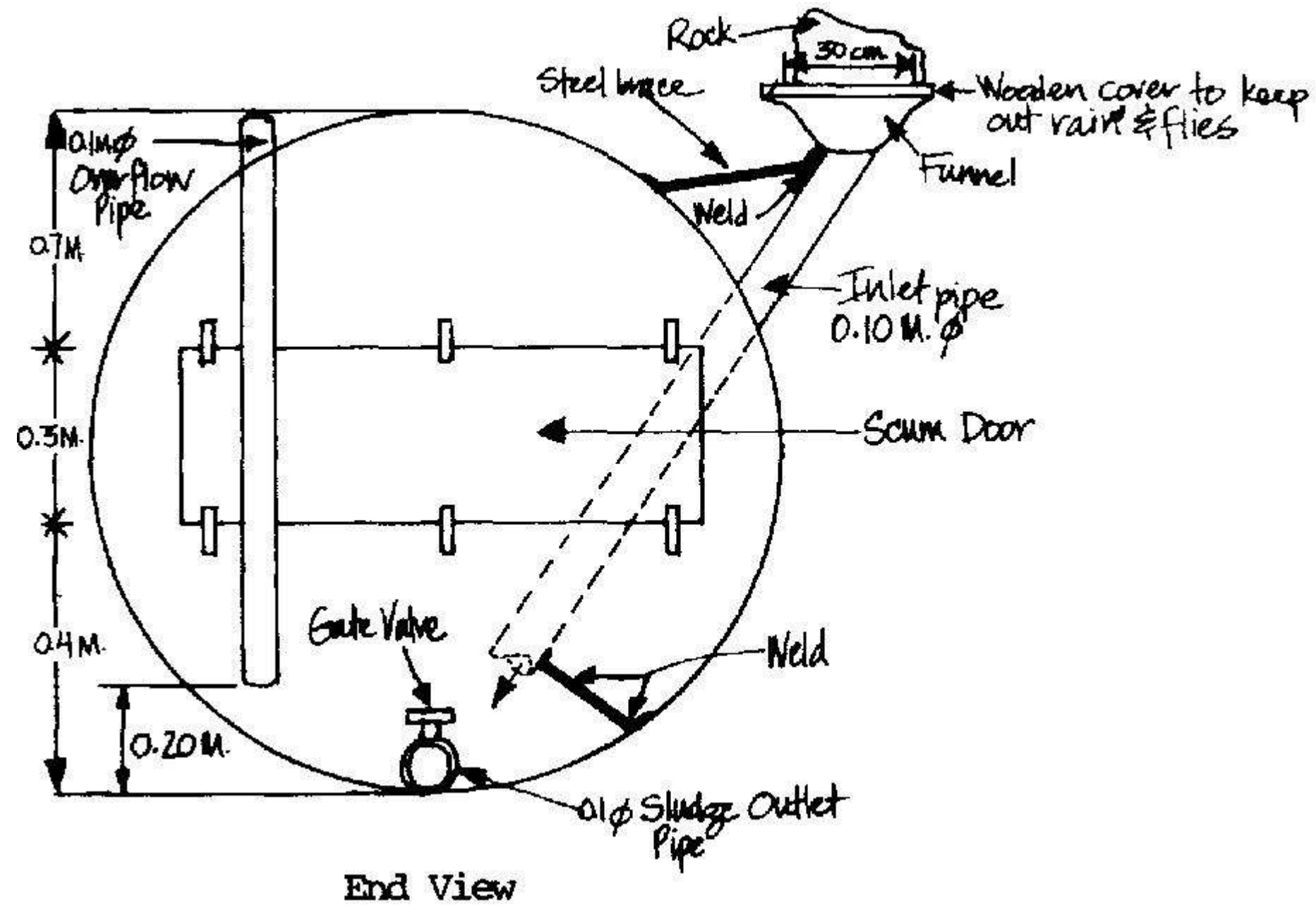

Large digesters will be easier to operate with large diameter inlets and outlets, but they should be the same size.

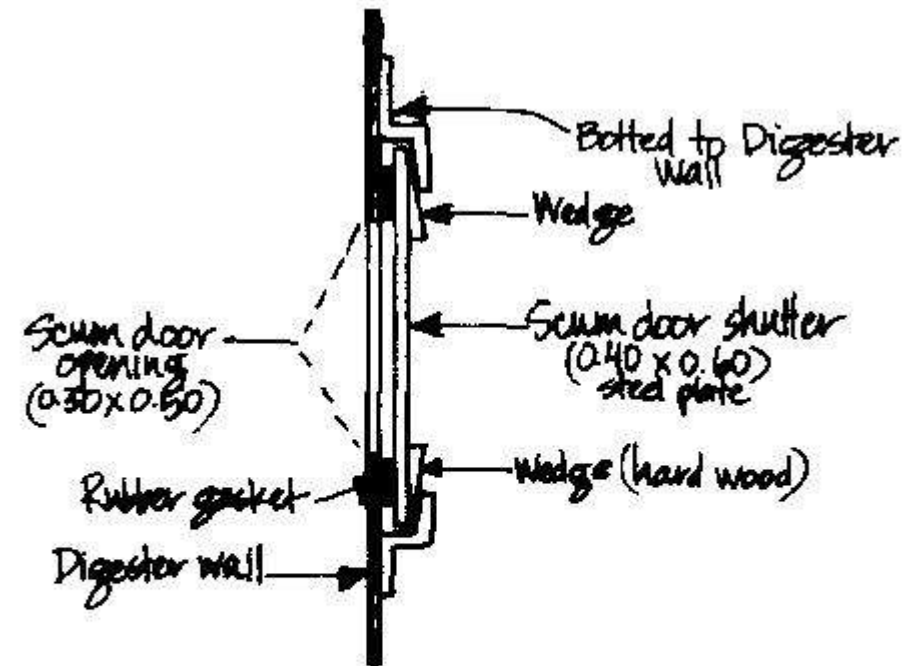

Suggested Scum Door Design
 (open scum door only after lowering
 slurry to a level below bottom
 of scum door)

Suggest Scum Door Design

Safety from Lightning:

Means should be provided on metal digesters and biogas holders to lead lightning away to the ground through conductors. Drive a metal stake deep into the ground near the digester and connect the digester and the stake together with thick electrical wire in order to make a good electrical contact.

DIAGRAM 6: RECTANGULAR BIOGAS DIGESTERS

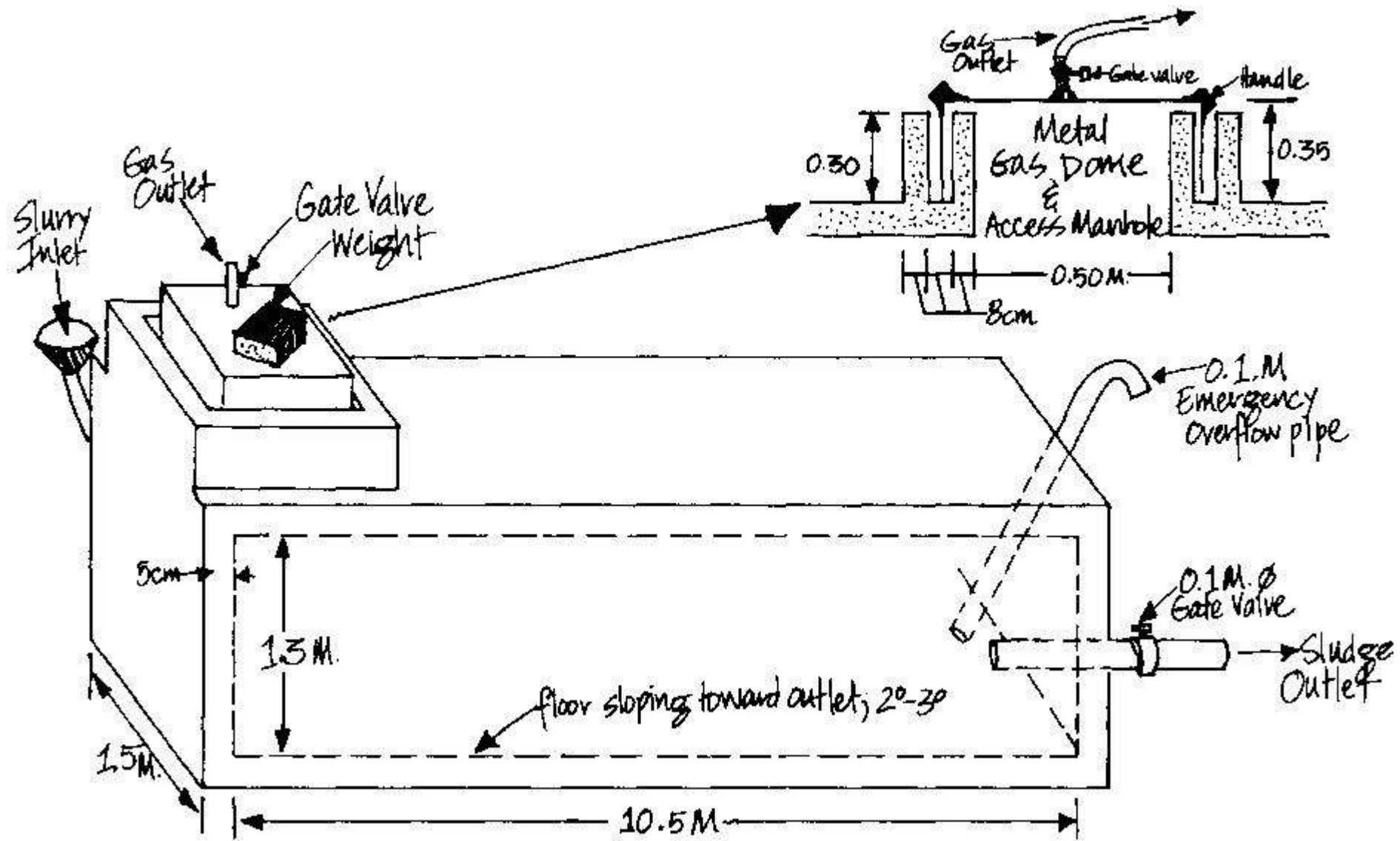

Ferrocement Model

-Inside measurements: 10.5m x 1.5m x 1.3m, Capacity 20.5 cubic meters

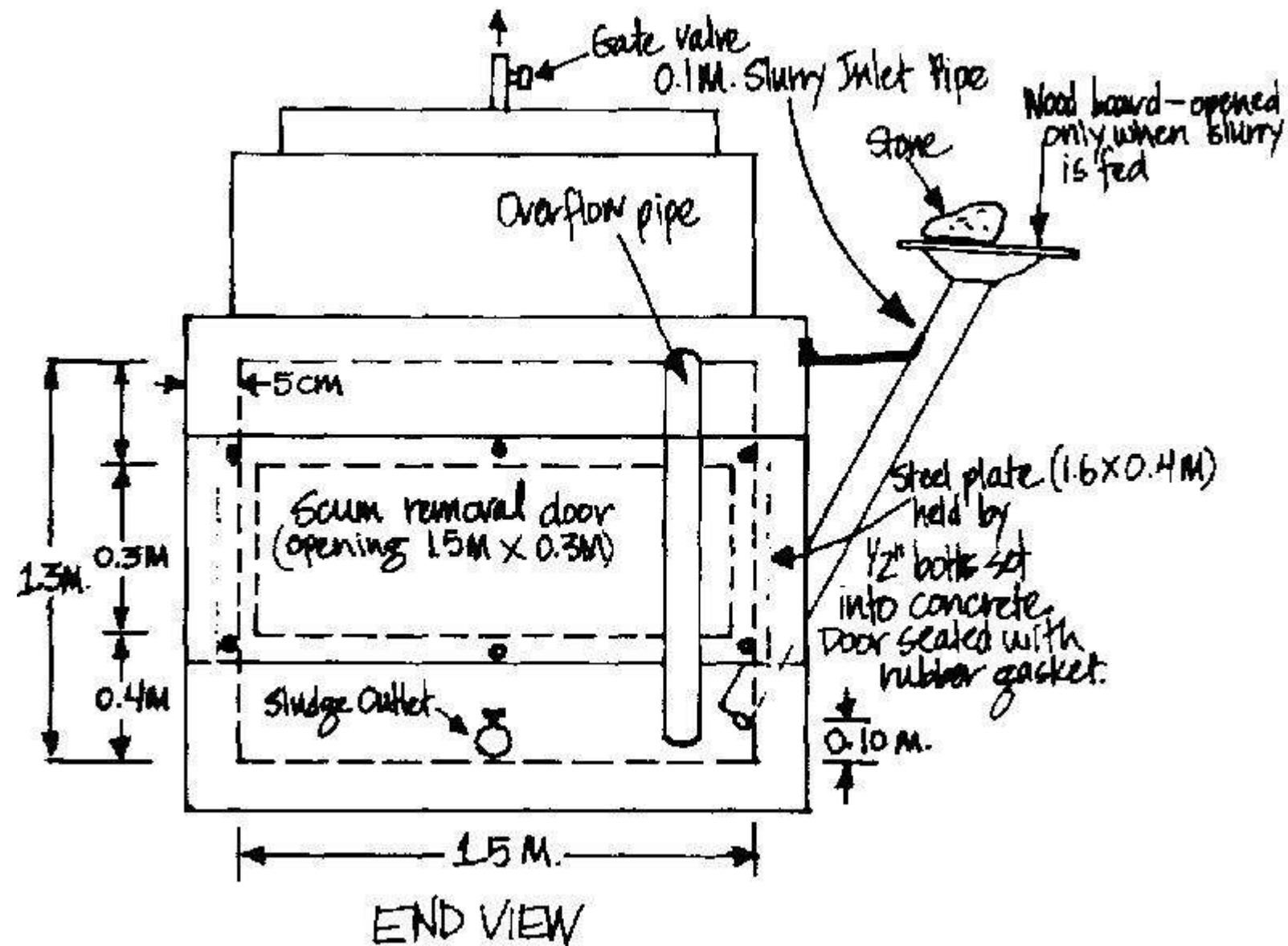

Ferrocement Model-End View

-The inlet is always on the side of the digester's inlet end in order to keep the slurry from going through the digester too fast.

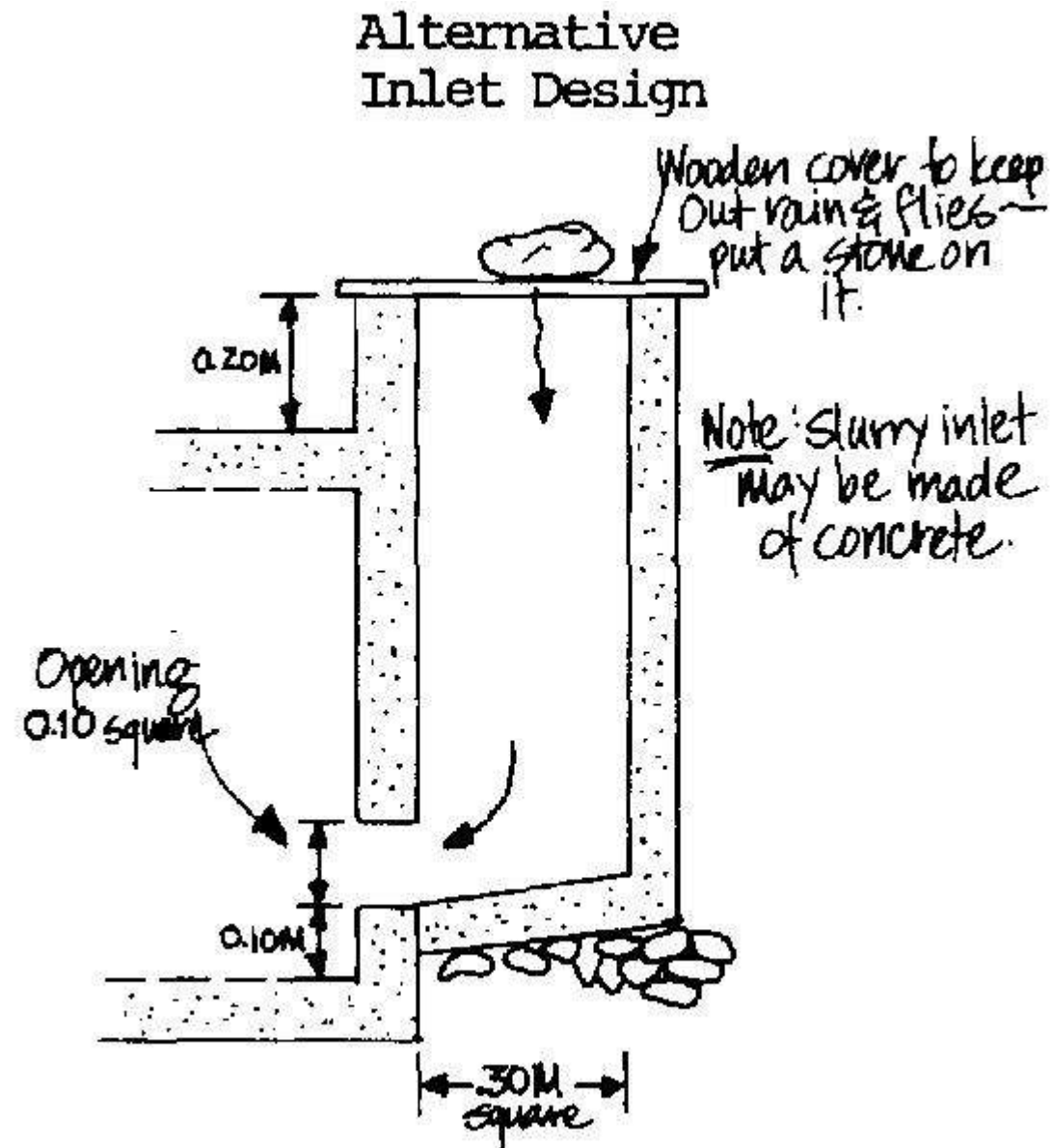

Alternative Inlet Design

-Large digesters will be easier to operate with large diameter inlets and outlets, but they should be the same size.

Chapter three: The raw materials of biogas digestion

The raw materials of biogas digestion are organic plant and animal matter. That organic matter can be animal manure, crop waste, weeds from lakes and rivers as well as from land, or the organic waste from restaurants, market places, slaughter houses, and factories that use a fermentation process.

Alternative Inlet Design

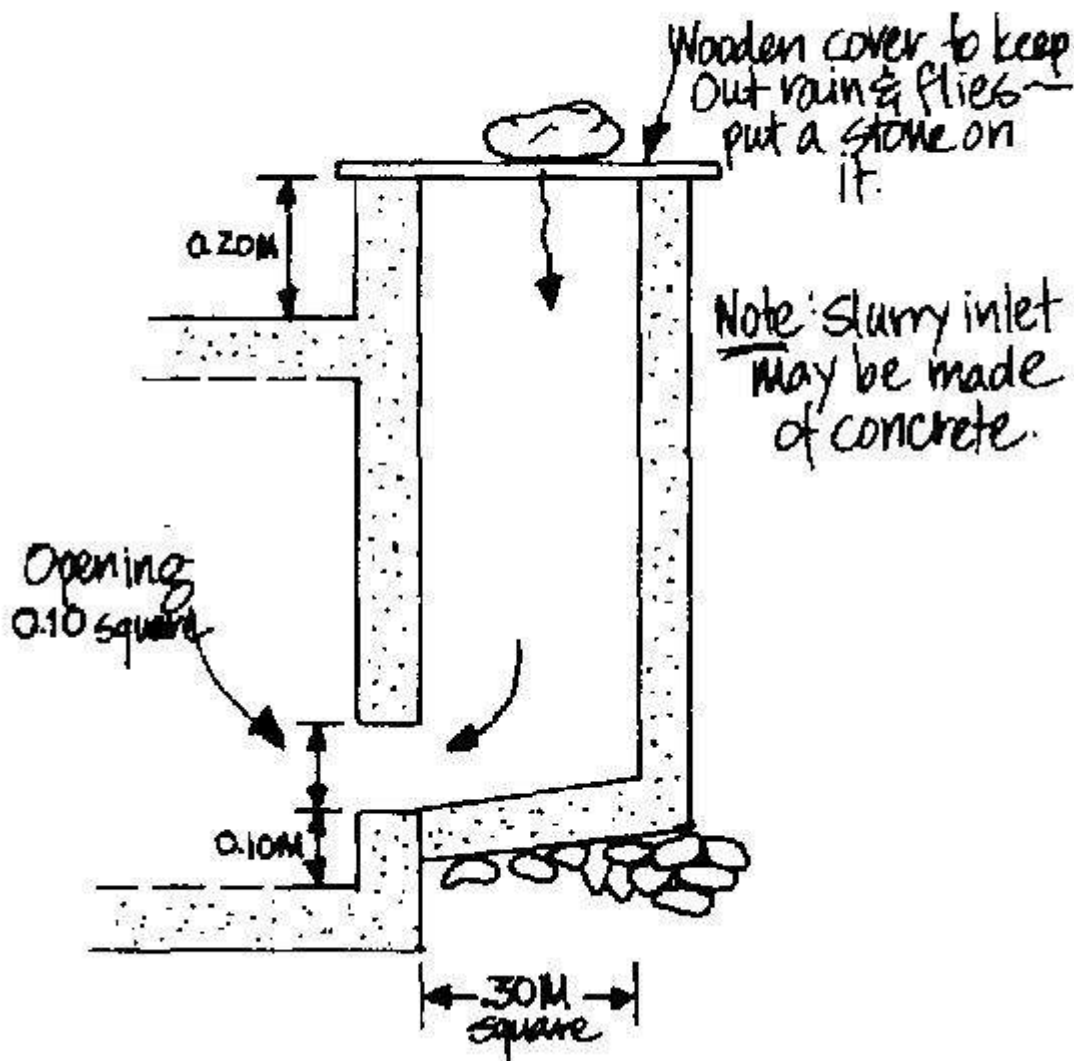

Alternative Inlet Design

-Large digesters will be easier to operate with large diameter inlets and outlets, but they should be the same size.

Chapter three: The raw materials of biogas digestion

The raw materials of biogas digestion are organic plant and animal matter. That organic matter can be animal manure, crop waste, weeds from lakes and rivers as well as from land, or the organic waste from restaurants, market places, slaughter houses, and factories that use a fermentation process.

Decayed organic matter is the chief basis of all fossil fuels such as coal, oil, and natural gas (methane)--which are in turn only a small fraction of the remains of all the plants and animals that have lived over the ages. As a result of special conditions, fossil fuels have been preserved and are now being used at a rate that increases every year. Most of the organic matter that was formed in past ages has long since been converted back into carbon dioxide and water (Fry, 1974).

What and How to Feed Digesters

Organic waste can be divided into two groups: carbon-rich such as grass and crop stalks, and nitrogen-rich such as urine, human feces, and chicken manure. The carbon-rich waste contains a lot of carbon cellulose, which promotes biogas production, and the nitrogen-rich waste provides nutrients which promote the growth and reproduction of anaerobic bacteria. Experiments have shown that biogas production can be increased if the various organic wastes can be fed into the digester in correctly balanced proportions.

Organic waste materials for gas and fertilizer production include crop wastes, grass, leaves, weeds, urine, and the manure of people, pigs, cattle, and chicken. If the digester inlet is connected directly to toilets and animal pens so that the manure can flow through drain pipes into underground or downhill digesters, no special management is required, but many experts say it is very important to mix the waste before putting it into the digester.

If the wastes are mixed before going into the digester, more gas and a better fertilizer will be produced, because there will not be any undigested lumps of manure going through the digester. The solids to liquids ratio can be kept closer to the ideal ratio of one to ten. There will be less danger of overfeeding the digester with waste or flooding it with water. One solution might be to have the drain pipes empty into a mixing basin instead of doing directly into the digester.

Sometimes collecting waste for a digester calls for creative problem solving. How would you collect the combination manure and urine droppings of chickens? One way would be to let the chicken droppings fall on leaves, grass, or water lilies spread under the chicken cases where the whole mess could be swept up on a daily basis. The manure plus plant waste could then be used to make a digester slurry.

In order to raise the biogas production level, all plant waste (but not manure) must be compost for a short time before it is put into a digester (using the composting method described in the Appendix). Plants must first be composted for seven to ten days so that the biogas bacteria will be able to digest the plants and produce biogas. The alternative is undigested plant waste floating on the surface of the slurry, forming a scum layer which will not decompose and will stop biogas from getting out of the slurry.

When plants have been composted with lime or an enzyme for a short time before being put in a digester, the waxy surface layers of the plants are broken down, which in turn speeds up the breakdown of the fibrous material in the plants. Shredding, grinding, or pulping plants into very small pieces before they are composted increases the amount of plant surface area which is exposed to the air, making it easier for the compost rotting process of aerobic decomposition to break the plant fibers down enough so that the biogas rotting process of anaerobic decomposition can produce biogas.

Another benefit of partial Composting is that it brings down the carbon/nitrogen ratio of the plants, which is often up around 60/1 to 100/1. After one week of Composting, the carbon/nitrogen ratio can be reduced to between 16/1 to 21/1, carbon nitrogen ratios that are much closer to the ideal environment for methane producing bacteria to live and grown in.

It cannot be emphasized too strongly that the raw materials of biogas digestion should not have specific gravities less than that of water. In other words, the waste must not float on water, as most plants can. The reason is very simple. If it floats in water, it will almost certainly float as scum inside a digester. It will not mix with the rest of the slurry. Scum is often the single biggest problem in a digester. It must be avoided at all costs. Even most animal manure will have pieces of plant matter that will float. Grinding or chopping up plants before they are used as animal feed will result in a manure that is not full of large plant fibers which will become scum inside digesters.

Cud-chewing (ruminant) animals such as cattle, goats, and sheep are different from animals such as

chickens and pigs. The manure of cud-chewing animals, if allowed to dry, will not absorb water again, it will float. Even grinding the dry manure into powder will not make the manure absorb water--it will always float.

It is an unavoidable restriction; the manure of cud-chewing animals must be collected in a naturally wet state and kept wet until put in a digester. Do not avoid using the manure of cud-chewing animals. When the manure is wet, it causes fewer scum problems than manure-from noncud-chewing animals, because cud-chewing animals grind and break down plants more completely than other animals can.

Different plants and different times of the year require different amounts of partial composting to get them ready for digesters. In general, Composting, should take only seven to ten days during hot weather (30 degrees centigrade and above) and ten to 15 days during cool weather (20 degrees centigrade and below). Too much Composting, and too little Composting, will both decrease biogas production levels; so the best thing to do is to try different lengths of time and use what works best.

Almost as important as not wanting scum floating on top of the slurry is not wanting dirt and sand taking up valuable space on the bottom. That some undigestible dirt will get in with the organic matter is unavoidable, but try to keep it to a minimum. Manure should, if at all possible, be collected off of concrete floors, not the ground, and a dirt trap like those shown in Diagrams 7, 8, and 9 should be used. The dirt and sand that is separated from the Blurry is not useless. It should be added to compost piles.

DIAGRAM 7: DIRT AND SAND TRAPS

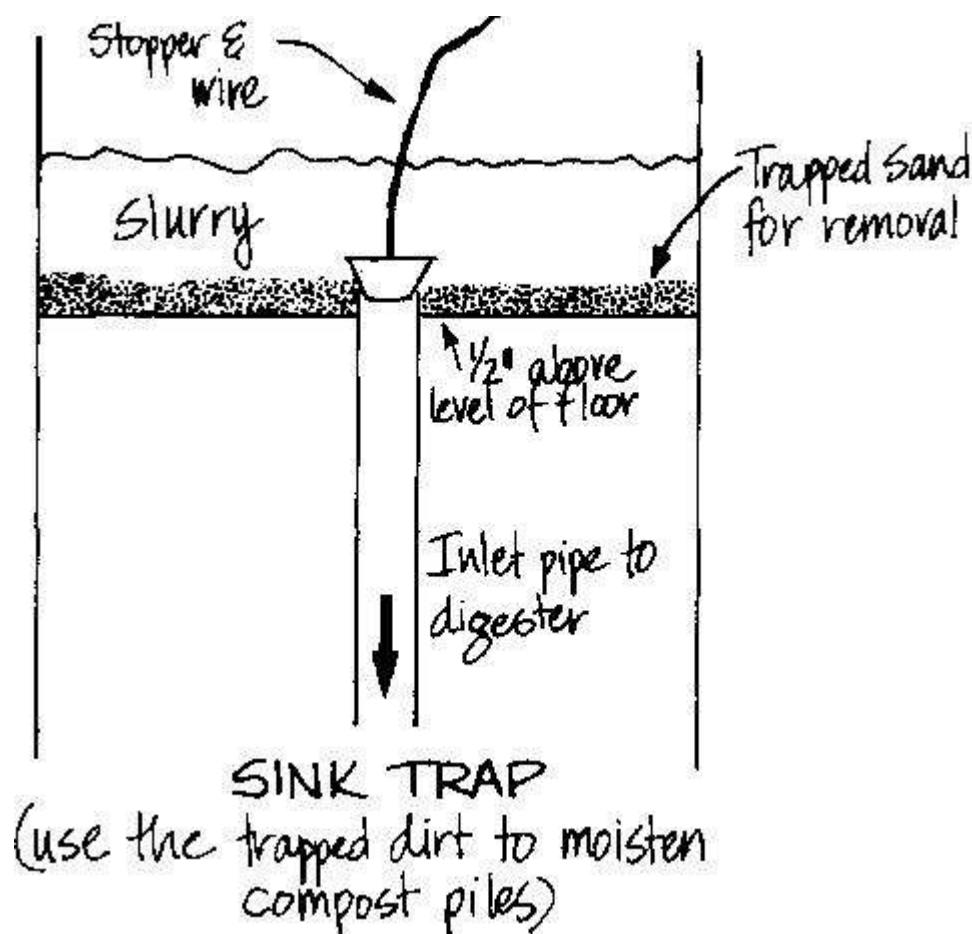

SNIK TRAP

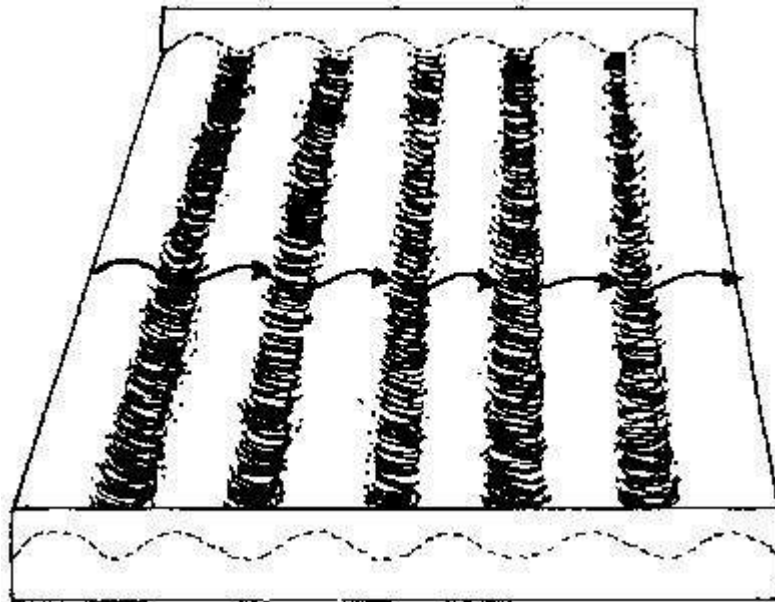

DIRT AND SAND SEPARATOR

-As slurry flows over the corrugations, sand settles in the hollows.

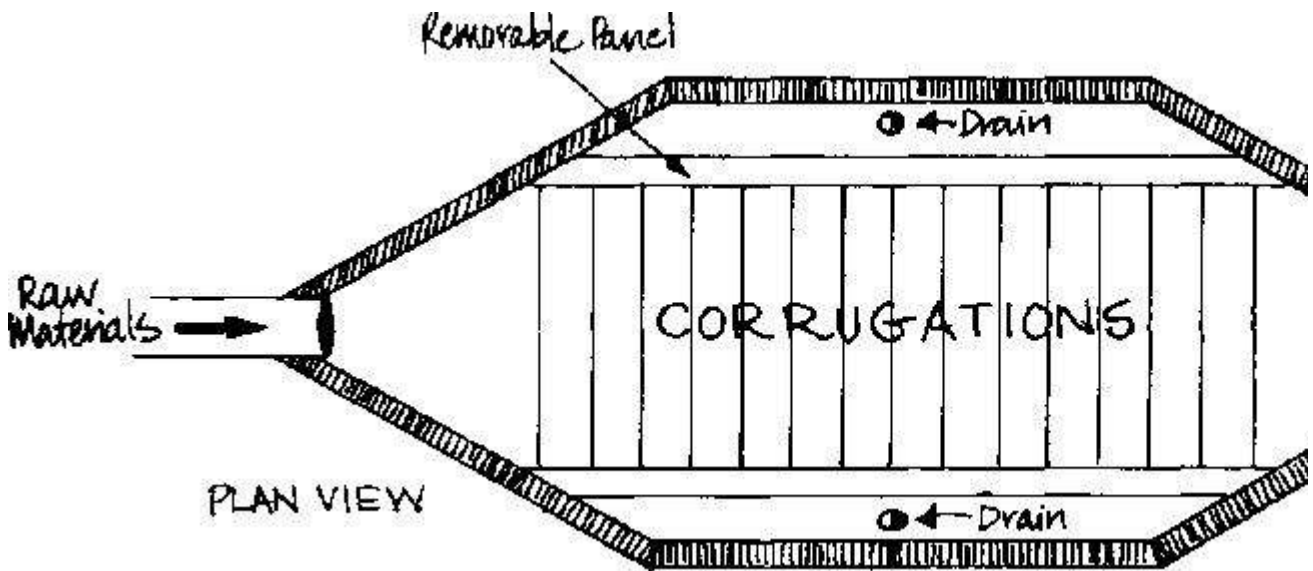

DIRT AND SAND SEPARATOR - PLAN VIEW

-This device can be made any width or length to suit the quantity of slurry.

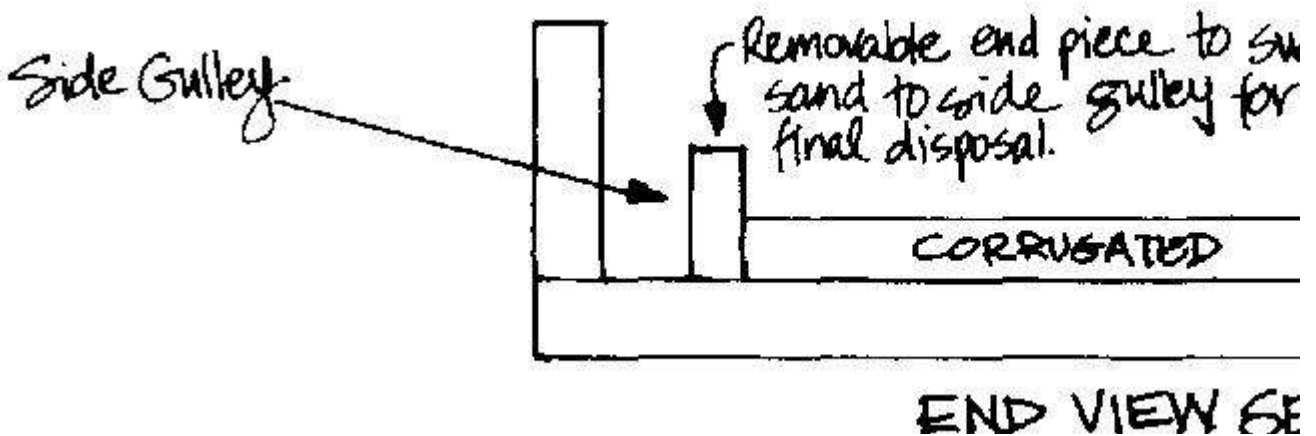

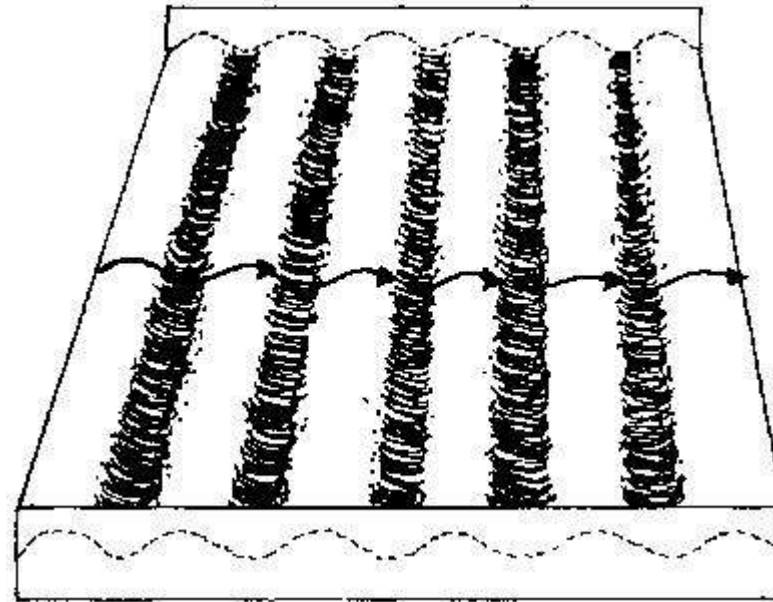

DIRT AND SAND SEPARATOR

-As slurry flows over the corrugations, sand settles in the hollows.

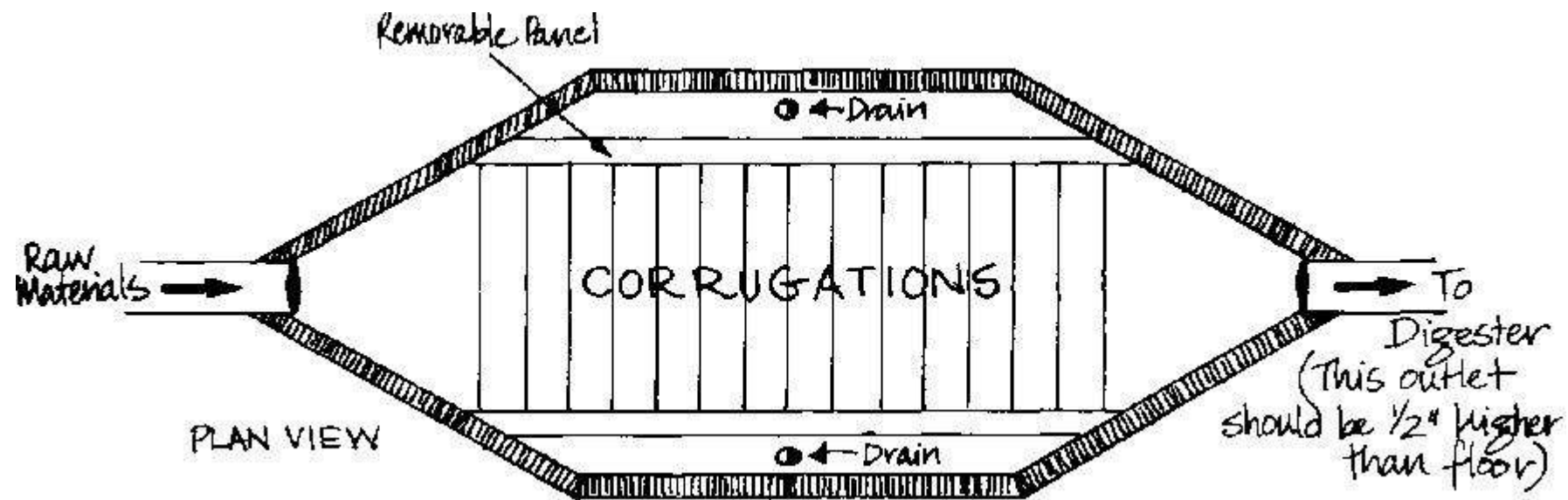

DIRT AND SAND SEPARATOR - PLAN VIEW

-This device can be made any width or length to suit the quantity of slurry.

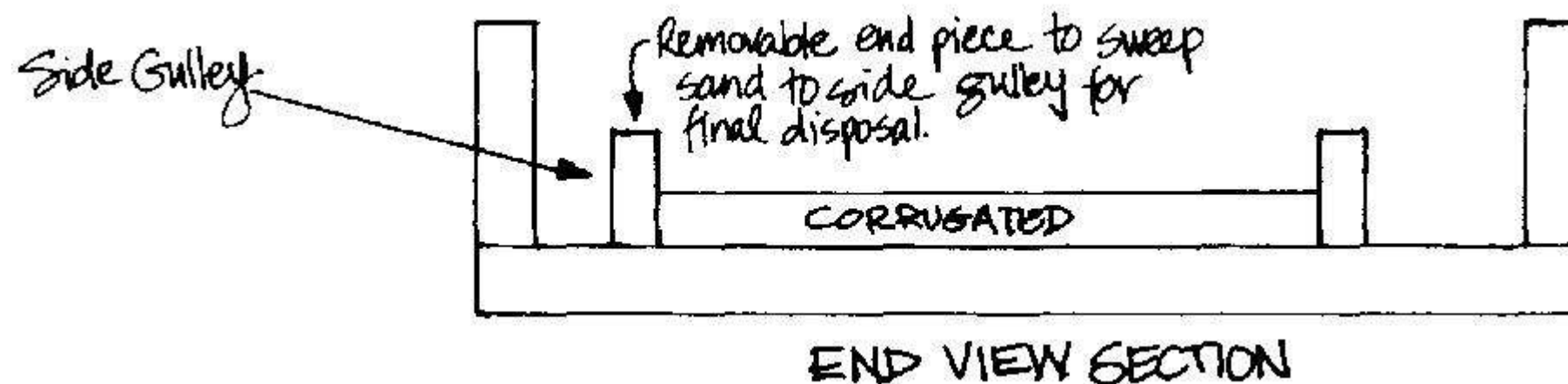

DIRT AND SAND SEPARATOR - END VIEW SECTION

Note: If these methods are not used, some other method should be used so that sand and dirt does not get into the digester and "waste" valuable space. Also, make sure that nothing that floats gets into the digester.

REMOVING SAND AND DIRT FROM SLURRY BEFORE IT IS PUT IN DIGESTER Fry, 1974

The slurry mixing machine in Diagram 8 can be designed to hold all, 1/2, 1/3, or 1/4 of the daily slurry load filled up to the level of the top of the slope beside the beater. Too much or too little slurry will make the machine difficult to operate. If the radius at the front of the beater is not correctly adjusted, then the slurry in the machine will not circulate easily.

A piece of wood should be attached to one blade, protruding one inch and used as a measure. Covers are usually fitted over the beater to avoid splashing. For the collection and removal of dirt and sand, a channel is made in the floor near the inlet pipe to the digester (the lowest point). This channel runs to a two inch diameter hole in the wall which can be plugged with a piece of wood. The inlet pipe to the digester is opened after the slurry has been mixed.

In Diagram 9 the level of the bottom of the pipe to the digester is one-half to one inch above the floor of the mixing basin in order to reduce the amount of dirt getting into the digester. A valve or plug should be at the floor level of the basin, at the end of a channel that crosses the middle of the basin from one side to the other. This dirt will make a profitable addition to a compost pile.

Carbon and Nitrogen

The first requirement of the raw materials of biogas production is that they must contain organic carbon and nitrogen in quantities that have a certain relationship to each other. From a biological point of view, biogas digesters can be considered as a community of very small animals called bacteria, feeding on and changing organic matter into methane gas and carbon dioxide. The element carbon (in the form of carbohydrates) is the bacteria's rice and bread, and the element nitrogen (in the form of proteins) is the bacteria's meat and fish. The bacteria use the carbon for energy and the nitrogen for growing.

A digester's bacteria uses carbon about 30 times faster than it uses nitrogen. This is also true for people, we need a lot more rice and bread than we need meat and fish. A carbon/nitrogen ratio (C/N) of 30 (30/1 or 30 times as much carbon as nitrogen) will permit digestion and gas production to proceed at the best possible rate, if other conditions such as temperature are favorable. If there is too much carbon (C/N of 60) in the slurry, all of the nitrogen will be used up first, leaving a lot of unused carbon. This will make the production of biogas slow down. If there is too much nitrogen (C/N of 10), the carbon will soon be all used up, digestion will slow down, and the remaining nitrogen will be lost as ammonia gas which smells bad but does not burn. In addition to a lower biogas production rate, the loss of the nitrogen decreases the quality of the fertilizer.

DIRT AND SAND SEPARATOR - END VIEW SECTION

Note: If these methods are not used, some other method should be used so that sand and dirt does not get into the digester and "waste" valuable space. Also, make sure that nothing that floats gets into the digester.

REMOVING SAND AND DIRT FROM SLURRY BEFORE IT IS PUT IN DIGESTER Fry, 1974

The slurry mixing machine in Diagram 8 can be designed to hold all, 1/2, 1/3, or 1/4 of the daily slurry load filled up to the level of the top of the slope beside the beater. Too much or too little slurry will make the machine difficult to operate. If the radius at the front of the beater is not correctly adjusted, then the slurry in the machine will not circulate easily.

A piece of wood should be attached to one blade, protruding one inch and used as a measure. Covers are usually fitted over the beater to avoid splashing. For the collection and removal of dirt and sand, a channel is made in the floor near the inlet pipe to the digester (the lowest point). This channel runs to a two inch diameter hole in the wall which can be plugged with a piece of wood. The inlet pipe to the digester is opened after the slurry has been mixed.

In Diagram 9 the level of the bottom of the pipe to the digester is one-half to one inch above the floor of the mixing basin in order to reduce the amount of dirt getting into the digester. A valve or plug should be at the floor level of the basin, at the end of a channel that crosses the middle of the basin from one side to the other. This dirt will make a profitable addition to a compost pile.

Carbon and Nitrogen

The first requirement of the raw materials of biogas production is that they must contain organic carbon and nitrogen in quantities that have a certain relationship to each other. From a biological point of view, biogas digesters can be considered as a community of very small animals called bacteria, feeding on and changing organic matter into methane gas and carbon dioxide. The element carbon (in the form of carbohydrates) is the bacteria's rice and bread, and the element nitrogen (in the form of proteins) is the bacteria's meat and fish. The bacteria use the carbon for energy and the nitrogen for growing.

A digester's bacteria uses carbon about 30 times faster than it uses nitrogen. This is also true for people, we need a lot more rice and bread than we need meat and fish. A carbon/nitrogen ratio (C/N) of 30 (30/1 or 30 times as much carbon as nitrogen) will permit digestion and gas production to proceed at the best possible rate, if other conditions such as temperature are favorable. If there is too much carbon (C/N of 60) in the slurry, all of the nitrogen will be used up first, leaving a lot of unused carbon. This will make the production of biogas slow down. If there is too much nitrogen (C/N of 10), the carbon will soon be all used up, digestion will slow down, and the remaining nitrogen will be lost as ammonia gas which smells bad but does not burn. In addition to a lower biogas production rate, the loss of the nitrogen decreases the quality of the fertilizer.

DIAGRAM 8

SLURRY MIXING MACHINE

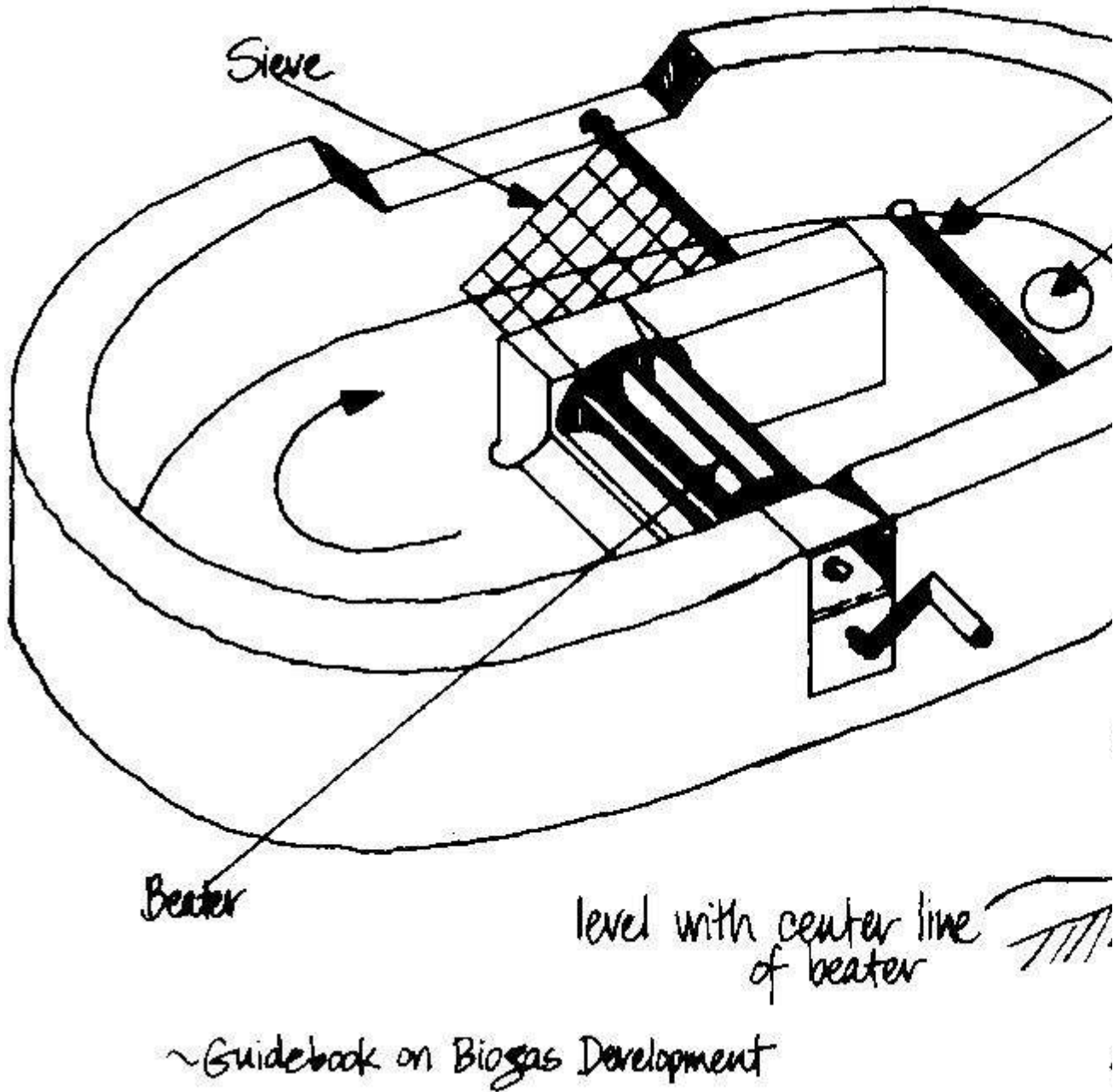

SLURRY MIXING MACHINE

DIAGRAM 9

DIAGRAM 8

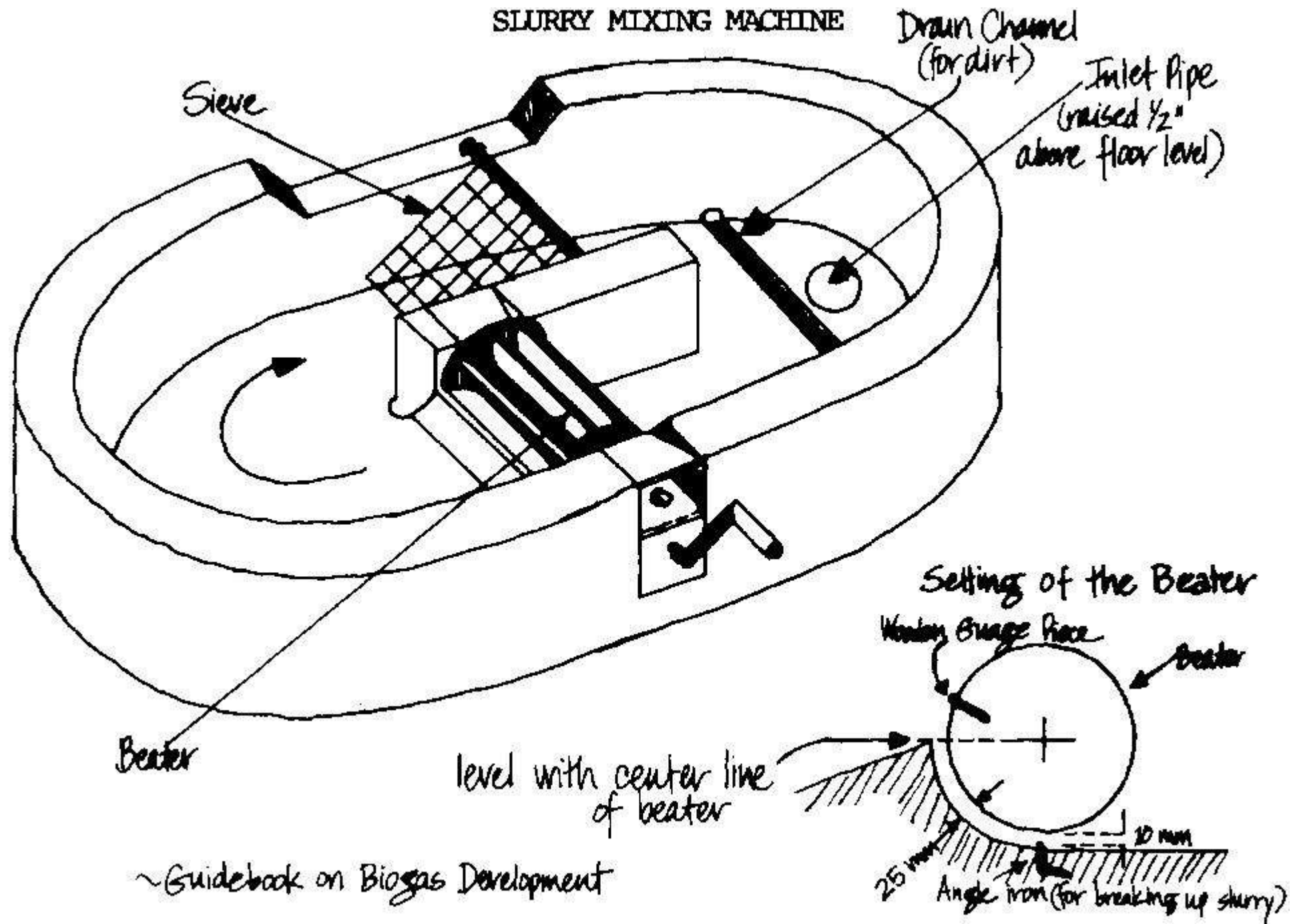

SLURRY MIXING MACHINE

DIAGRAM 9

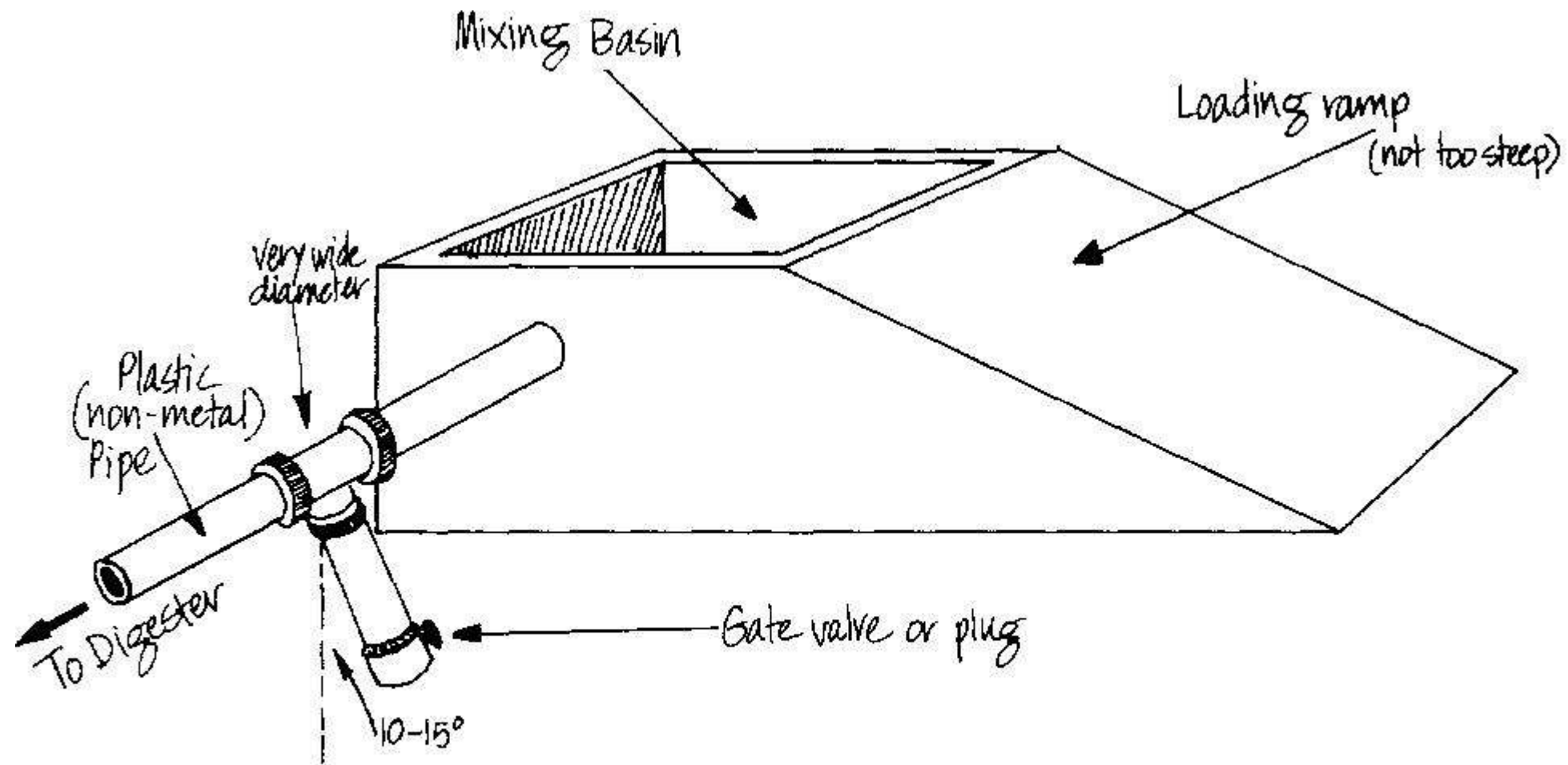

This pipe angles out 10-15" from the pipe to digester to make cleaning easy if it becomes clogged. It is an extra sand and dirt trap.

(Fry, 1974)

SLURRY MIXING BASIN FOR LARGE DIGESTERS

DIAGRAM 10: pH LEVELS

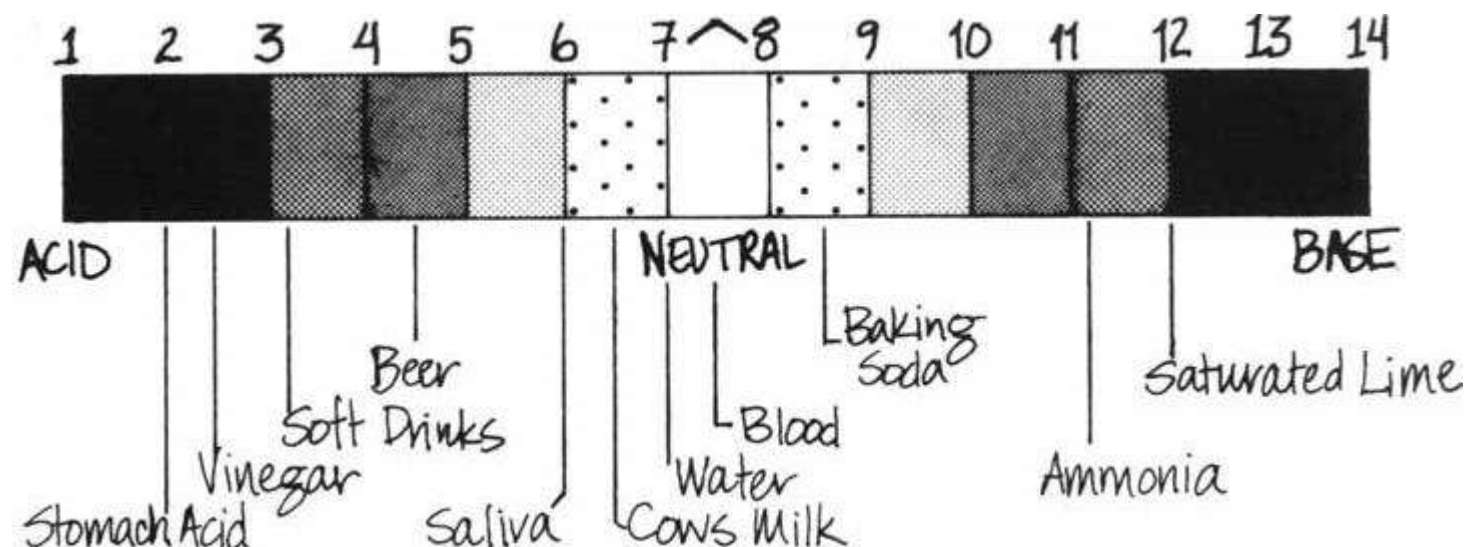

THE WELL-BUFFERED DIGESTER

pH

To measure the acid or base condition of anything, the symbol "pH" is used. The liquid in your stomach, vinegar, Coke, and beer are all acid. Ammonia and lime are base. A neutral solution has a pH of 7.0, an acid solution has a pH below 7.0, and a base (also called alkaline) solution has a pH above 7.0. The acid-base balance has a very big effect on all living things. The maintenance of a stable pH is very important to all life. Animals cannot eat food, nor can plants live in soil that is too acid or too base. Both strong acids and strong bases can destroy anything they come in contact with (see Diagram 10).

Blood has an almost neutral pH of about 7.8. Most living processes take place in the range of pH 5.0 to 9.0. The pH requirements of a biogas digester are in a narrow range of pH 6.6 to 7.6. When the pH level drops below 6.6 or goes above 7.6, biogas production slows down and if the pH level goes 0.5 of a point above or below that range, biogas production is likely to stop. Maintaining a good pH level is an important factor in keeping the biogas production rate high. The pH of a digester should be a little on the base side of neutral; some say pH 7.0 to 7.2 and others say 7.0 to 7.8.

In order to maintain the necessary acid-base balance, one can check the pH level from time to time. The method of checking the pH level is simple. Drop a piece of litmus paper into the slurry, immediately observe the change in color of the paper, and compare it with a standard chart of pH colors to tell what the pH of the slurry is. (If the local drug stores do not have litmus paper, ask one to order a supply of it.)

A good way to find out what is happening inside a digester is to attach a strip of litmus paper and a thermometer to a long stick and put it down the digester inlet for five minutes, bring it out, read and record the results, change the litmus paper and shake down the thermometer, and take a second reading down the overflow pipe at the outlet end, then compare the two sets of readings. Because of the different types of biological activity going on at the beginning and end of digesters, there may also be a difference in readings between the two ends. Litmus paper is the easiest and cheapest way to measure pH levels, but it is not the most accurate method. Litmus paper is useful for approximate, but not exact, readings.

It has been observed that a red or yellow biogas flame often means that the slurry is slightly acid. Adding a little lime or ash to the slurry mix should help adjust the acidity and restore normal gas production. Usually the answer is not to give the digester any medicine but rather to check and see what it might be that you are doing wrong. If the bad practice can be stopped, the digester will heal itself, usually. The problem may be overfeeding of slurry or it may be a wrong balance of types of plants and manure. Using only sludge to feed the digester for a few days can help sometimes, but never add any acid to a biogas digester that has become too base (alkaline). Adding acid will only increase the production of hydrogen sulfide, which is of no use at all. For more detailed information on C/N ratios and pH levels, read the Facts and Figures section of the Appendix.

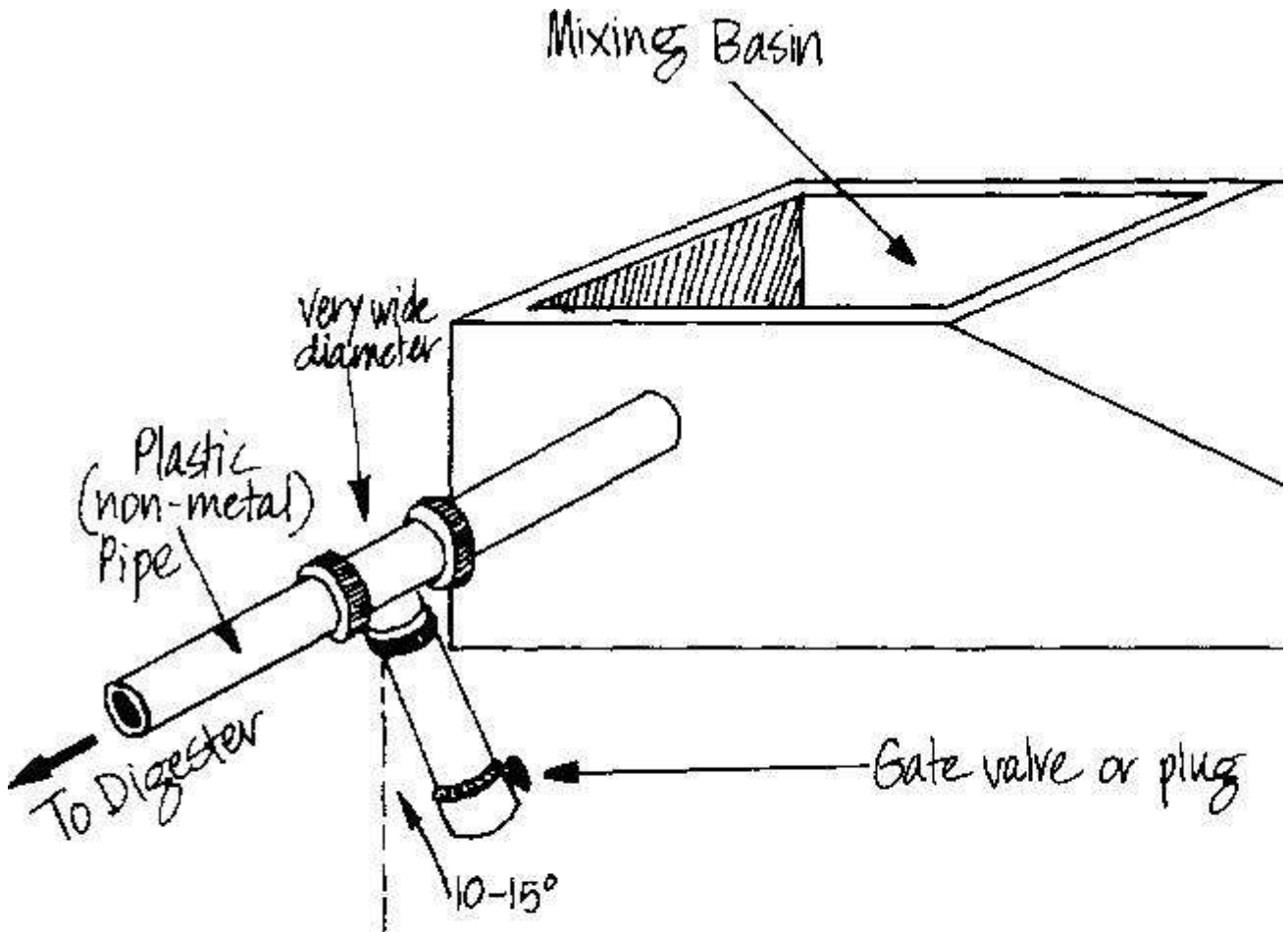

This pipe angles out 10-15" from the pipe to digester to make cleaning easy if it becomes clogged. It is extra sand and dirt trap.

SLURRY MIXING BASIN FOR LARGE DIGESTERS

DIAGRAM 10: pH LEVELS

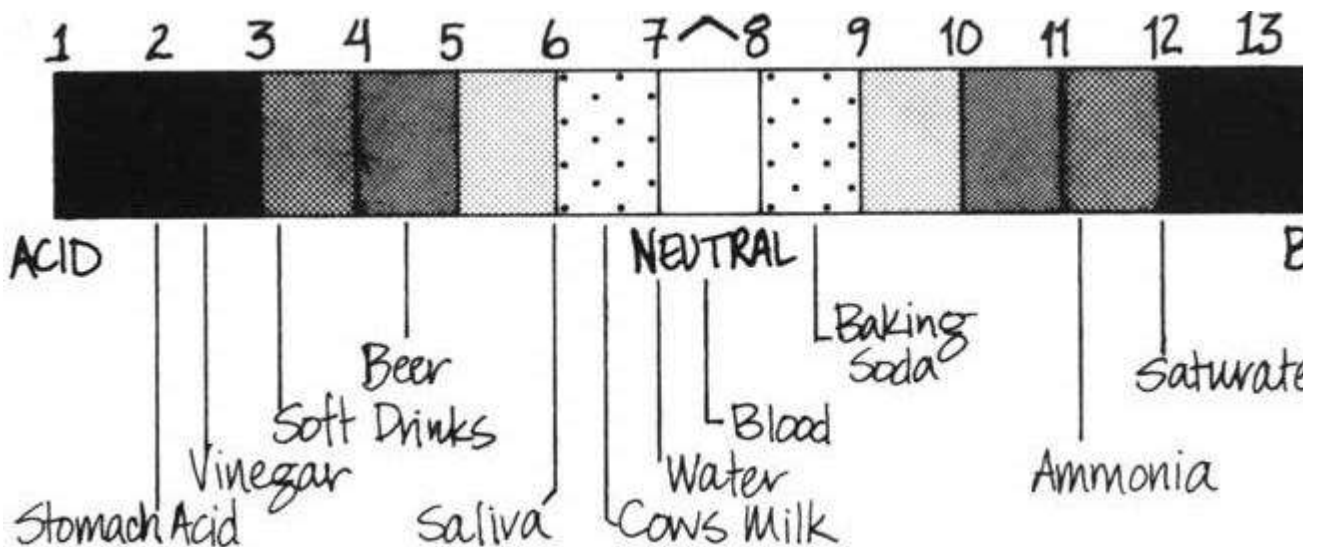

THE WELL-BUFFERED DIGESTER

pH

To measure the acid or base condition of anything, the symbol "pH" is used. The liquid in your stomach, vinegar, Coke, and beer are all acid. Ammonia and lime are base. A neutral solution has a pH of 7.0, an acid solution has a pH below 7.0, and a base (also called alkaline) solution has a pH above 7.0. The acid-base balance has a very big effect on all living things. The maintenance of a stable pH is very important to all life. Animals cannot eat food, nor can plants live in soil that is too acid or too base. Both strong acids and strong bases can destroy anything they come in contact with (see Diagram 10).

Blood has an almost neutral pH of about 7.8. Most living processes take place in the range of pH 5.0 to 9.0. The pH requirements of a biogas digester are in a narrow range of pH 6.6 to 7.6. When the pH level drops below 6.6 or goes above 7.6, biogas production slows down and if the pH level goes 0.5 of a point above or below that range, biogas production is likely to stop. Maintaining a good pH level is an important factor in keeping the biogas production rate high. The pH of a digester should be a little on the base side of neutral; some say pH 7.0 to 7.2 and others say 7.0 to 7.8.

In order to maintain the necessary acid-base balance, one can check the pH level from time to time. The method of checking the pH level is simple. Drop a piece of litmus paper into the slurry, immediately observe the change in color of the paper, and compare it with a standard chart of pH colors to tell what the pH of the slurry is. (If the local drug stores do not have litmus paper, ask one to order a supply of it.)

A good way to find out what is happening inside a digester is to attach a strip of litmus paper and a thermometer to a long stick and put it down the digester inlet for five minutes, bring it out, read and record the results, change the litmus paper and shake down the thermometer, and take a second reading down the overflow pipe at the outlet end, then compare the two sets of readings. Because of the different types of biological activity going on at the beginning and end of digesters, there may also be a difference in readings between the two ends. Litmus paper is the easiest and cheapest way to measure pH levels, but it is not the most accurate method. Litmus paper is useful for approximate, but not exact, readings.

It has been observed that a red or yellow biogas flame often means that the slurry is slightly acid. Adding a little lime or ash to the slurry mix should help adjust the acidity and restore normal gas production. Usually the answer is not to give the digester any medicine but rather to check and see what it might be that you are doing wrong. If the bad practice can be stopped, the digester will heal itself, usually. The problem may be overfeeding of slurry or it may be a wrong balance of types of plants and manure. Using only sludge to feed the digester for a few days can help sometimes, but never add any acid to a biogas digester that has become too base (alkaline). Adding acid will only increase the production of hydrogen sulfide, which is of no use at all. For more detailed information on C/N ratios and pH levels, read the Facts and Figures section of the Appendix.

Chapter four: The daily operation of a biogas factory

When the digester is built and ready to start. The safest way to start is to completely fill the digester and the gas storage tank with water. The floating gas tank should be an inch shorter than the water tank it will be floating in. It will be totally under water before biogas production begins. In this way there will be as little oxygen as possible in the system. Oxygen kills the biogas bacteria and under certain conditions, the mixture of oxygen and methane can be explosive. Come back 24 hours later, and if the water level has not dropped anywhere in the system, there are no leaks that need repairing.

Make sure that all gas pipes going to gas storage tanks, engines, stoves, etc., are connected but that only the gate valve going into the gas tank is open and that the water level in the digester inlet and in

the digester are the same. Open the outlet valve until the water level has dropped about 5.0 cm (2.0 inches) below the level of the bottom of the digester roof. Permanently mark this level on the side of the inlet pipe. In normal use, the level of the slurry should never be too far from this mark. If it is often above the mark, the digester has been overfed or the sludge under removed and the possibility of clogging the gas pipe with scum becomes real. On the other extreme, the slurry level can drop too low. If the openings from the inlet or the overflow pipe are exposed by the slurry level dropping below their tops, biogas will escape and oxygen will get in.

According to L. John Fry, 40 days is just about right for the amount of time any one day's load of slurry should stay in a horizontal digester. That is why the daily slurry volumes listed in the Facts and Figures section of the appendix are all 1/40 of the volume of the digesters they are going into. Another important factor in preparing the daily slurry is how much water to add to the animal and/or plant waste.

The percentage of solids in the slurry must be kept at approximately ten percent. More detailed information on this subject is in the Facts and Figures section of the Appendix. One other thing: add the slurry to the digester at the same time every day, or better yet, divide the daily slurry volume into two or three equal parts and add each part at the same time every day. This more gradual step-method of adding slurry will result in a more stable digester, which will result in more biogas.

Digesters are very sensitive. If there are lumps in the manure, if the plant waste is not in small pieces, the biogas-producing bacteria will have a hard time breaking down the waste so that methane can be produced. The more dissolved the solids are in the slurry, the higher the biogas production rates will be.

One method that can be used to solve the scum problems of using plant waste is to first crush, grind, or shred the plants. Then break down (saccharify) the plants with lime. The plants can then be used after a few days composting to make a digester slurry. Instead of going directly into the digesters, plants could be used as animal feed, especially for cud-chewing ruminant animals such as cattle and water buffalo. (Livestock can also be fed the water from sludge aging ponds, which are full of nitrogen-rich algae.)

Thirty-five degrees centigrade (96° F) is the digester temperature at which the highest rate of biogas production occurs. It is also important that there be no wild swings in the temperature of the slurry inside the digester. In addition to heating the digester, many heating systems also heat the slurry (or the water that is to be mixed with the organic matter) before the slurry goes into the digester.

A very efficient source of heat for the slurry, inside or outside the digester, is the excess engine heat from a stationary engine that is fueled by the biogas. Some systems use hot water from inexpensive solar heat collector panels. There is more information on heating digesters in Chapter Seven and on solar heating in the New Ideas section of the Appendix.

First Biogas

If at all possible, for the first few days, the slurry for a new digester should be sludge from a working biogas digester. This sludge will be full of biogas producing bacteria which will help get the new digester producing usable quantities of quality biogas within three to four weeks. If this is not possible, start with fresh waste. It will work ok; it will just take a few more weeks to get a gas production going that has a sufficiently high percentage of methane in it to burn on its own. When a biogas digester first starts producing gas, most of the gas is carbon dioxide, not methane.

For the first couple of months, use the sludge that is taken out of the digester to mix with the fresh waste going in. Because the digester started completely filled with water, the sludge will have a very small percentage of solids in it. It will have some biogas bacteria in it, which will help get the digester

working faster and in any case, the sludge will be too weak to make a good fertilizer.

After the digester has been in operation for one or two months, the sludge can be used for fertilizer or it can continue to be used to dilute the fresh waste.

If the decision is made to use the sludge to dilute the fresh waste, the solid portion of the sludge must first be separated out.

At this point, keeping the solids no greater than ten percent of the slurry becomes very important and will always remain important. There are many ways to separate the solid from the liquid sludge, including letting the sludge run through gravel or a screen or by a series of ponds where the solid portion is raked off. Once separated, the solid portion can be dried and used as fertilizer.

If the ten percent solids in the sludge are not separated out before the sludge is used to dilute the fresh waste, the slurry in the digester will, after a while, get too thick. Less and less gas will be produced and eventually it will be necessary to clean the digester out and start over again, long before it is time for the once a year cleaning that even most well-run digesters will need. Do not let the sludge fool you; it may look very watery, but it is full of solids and plant fibers (even if only manure is used) suspended in the liquid.

In any case, when the sludge, solid and/or liquid, is used for fertilizer, it will have to be aired out for a couple of weeks in shallow ponds before it becomes safe to use as a fertilizer. In that time, the parts of the sludge that are toxic, that can kill plants and fish, will evaporate into the air, and oxygen (which fish need) will mix with the sludge. (There is more on using sludge in Chapter Eight.)

During a biogas digester's start-up period the methane content of the gas is very low. Even if the gas will burn, the flame will go out when you take the match away. Do not try to save or use the gas, but remember not to smoke cigarettes when the low quality gas is released, or the result might be a burned face. Do not let all the low quality gas escape; leave some pressure in the system.

When fresh slurry was added to the demonstration model digester, the valve from the digester to the separate gas storage tank had to be closed because otherwise the process of removing sludge and adding fresh slurry made the gas tank fall quickly and then rise quickly.

Probably the most important thing to remember is not to let the level of the slurry drop below the top of the openings for the inlet or overflow pipe.

It can be very disappointing to see big bubbles of biogas escaping from the digester. Do not light a match to the bubbles to see if it is biogas; you might burn yourself, or if the flame gets inside the digester, the digester could explode. When the gate valve from the digester to the gas storage tank was closed before taking out the old sludge and putting in the new slurry, there were no more wild swings in gas pressure or loss of gas from the digester.

Daily Routine

The daily routine started with mixing the organic waste with water. A weighing scale makes it easy to get the right combination of waste and water. But if a scale is not available, weigh a bucket full of the usual waste on a friend's scale, in order to know the weight of a particular volume. Because a liter of water weighs one kilogram, it will be easy to figure out how much water or liquid sludge to mix with the waste (see chart in Appendix). The liquid sludge will not weigh too much more than water, but different kinds of waste will weight different amounts for the same volume.

Another method for getting the correct mix of solids and liquids in the slurry is to measure the specific gravity of the slurry. Details on this method are in the Facts and Figures section of the

Appendix.

After the slurry was mixed, the valve between the digester and the gas storage tank was closed. Then after checking to see what the slurry level was in the inlet, the sludge was removed. Next fresh slurry was added and if the inlet started to overflow before it was all in, more sludge was removed until the rest of the slurry could be added with the level of the slurry in the inlet equal to the mark 5.0 cm (2.0 inches) below the level of the bottom of the digester roof. Last but not least, the gate valve to the gas tank was reopened. Our experience was that if the gate valve from the digester is left closed for even half an hour, enough gas is produced to force slurry out of the digester.

The daily loading of slurry and removal of sludge should be followed by a regular routine of checks and preventive maintenance of the whole biogas system that include such things:

- checking the gas pipes for leaks and condensed water,
- checking the condensation traps to make sure they have enough water,
- checking gas storage tanks to make sure the water tanks have enough water and the gas tanks can move freely without tilting,
- checking that the gas pressure gauge is working correctly,
- checking engines and any other equipment fueled by the biogas, e checking the sludge ponds to make sure that all is as it should be.

The reason for all the regular checking is that preventive maintenance costs less in time and money than it costs to repair something that has broken down.

A wood cover on the inlet, with a rock or concrete hollow block on top to hold it in place, will keep children from falling into big digesters and rain from flooding digesters of all sizes.

The top of the overflow pipe should be 5.0 cm/2.0 inches lower than the bottom of the digester roof for two reasons. If slurry is forced out of the digester, it will be digested sludge coming out of the overflow pipe, not undigested slurry coming out of the inlet. Also, with the top of the overflow pipe lower than the bottom of the digester roof, slurry cannot rise high enough to block the gas pipe.

A biogas system is truly a small business and, like any business, good management is needed to keep it working right. Study how the system works, experiment with ways of improving it. If a biogas system is left to run itself with only minimal involvement on the part of the owner(s), it will not be a profit-making business.

Chapter five: The once a year cleaning of the digester

Many people who have written about their experiences with biogas say that cleaning the digester once a year is a good idea. But a digester does not have to be cleaned if the gas production rate is not dropping.

There are two problems that slow down gas production that cleaning the digester can solve.

- One is a build-up of dirt and sand on the floor of the digester which cannot be digested by the biogas bacteria. This layer of dirt will cut down on the usable capacity of the digester.
- The other reason is a layer of scum floating on top of the slurry. It is floating because, even though it is organic matter, it is lighter than water. Scum forms a growing blanket on top of the slurry that

takes up valuable space and does not allow the gas produced below it to rise out of the slurry and into the gas pipe.

What follows comes in large part from L John Fry's book Practical Building of Methane Power Plants for Rural Energy Independence. It describes his experience in cleaning continuous-type biogas digesters.

After about one year's operation, one of the two digesters began to produce less and less biogas. In addition to the low gas yield, the pH level was low and the sludge continued to produce gas after it was removed from the digester. Digestion was taking place outside of the digester. The digester was, in effect, being overloaded due to a reduction in available space caused by the buildup of scum. The digester had to be cleaned.

An important note: This is one time when extreme care must be taken not to have lights, cigarettes, flames, or sparks near the digester. A mixture of biogas and air, particularly in a closed or semi-closed space, plus a spark or flame, can spell EXPLOSION.

Scum is a mixture of animal hairs, skin particles, straw, and wood shavings from animal bedding, feathers, unrotted plants, and generally anything that will float. When removed and dried, it is so light that a piece 6.0 feet by 6.0 feet by 1.0 feet can be lifted with one finger. Yet it is so bound together by a layer that it can only be broken from the slurry's surface with a hoe. Scum is bound together in matted form by fine particles of sticky material brought up in the volcanic action of the bubbling digestion. It spreads evenly over the surface area of the slurry.

All digesters must have a device to separate and remove dirt and sand from the slurry before it is put in the digester.

1) For small digesters (less than 3.0 cubic meters capacity), a plastic bucket with an outlet 5.0 cm (2.0 inches) up from the bottom is suggested.

A) After the slurry has gone into the digester from the bucket's outlet, the dirt and sand that remain on the bottom of the bucket can be added to a compost pile

B) It would also be a good idea to scoop any floating matter off the top of the slurry. This floating matter could also be added to a compost pile.

2) For large digesters a corrugated dirt trap (see Diagram 7) would be more efficient.

A) As slurry flows over the corrugations, dirt will settle in the valleys.

B) After loading, one side of the dirt trap is removed, and the dirt is swept into the gully for use in a compost pile, and the side is replaced.

If animal manure is used that has been collected off of the ground, instead of concrete floors, there will be a lot of dirt in the slurry. A system that removes the dirt will be an absolute must.

A digester's cleaning door can either be on the top, on the outlet end, or on both the top and the outlet end. If it is an underground digester, the cleaning door can only be on the top (see Diagrams 5, 6, and 17).

An easy to open top-of-digester lid is pictured in Diagram 6. It is built at the inlet end of the digester and includes the gas pipe attachment. To make cleaning as easy as possible, this removable lid is made as wide as the digester.

Instead of making a lid that needs a semi-permanent, air-tight, water-tight cement seal, this removable lid uses a water seal. The gas pipe outlet is attached to an upside down concrete or metal cup that sits in a water seal. (A concrete cup will not rust but might be harder to make.) The water seal must always be kept deep enough so that the biogas does not escape unless the pressure goes too high (more than 20 cm/8.0 inches). This is done by keeping eight inches of water in the lid's water seal.

In addition to being an easy way to enter large digesters, this type of lid also serves another purpose. The gas pipe is higher above the digester than is usually the case, making it much less likely that a scum layer could block the pipe. This type of opening on top of the digester is useful, but to clean out scum and dirt a large door should also be built at the outlet end of the digester.

If just one opening is built on an above ground digester, it should be at the outlet end. Using a rubber gasket, a rustproofed metal plate is bolted onto the end of the digester (see Diagram 8). This will make the opening watertight, but not 100 percent airtight; so in normal operations the level of the slurry should never drop below the top of the scum door. Like a lid on top of a digester, a scum door should be built as wide as the digester.

Many people have abandoned biogas digesters simply and only because of scum problems. In vertical digesters, with their small surface area in proportion to volume, the buildup of scum can come to several feet in a few months. That is why vertical digesters are often built with expensive stirring mechanisms. Horizontal digesters with their large surface areas in proportion to volume, also have the problem of scum buildup, but the scum layer grows slowly in comparison to the rate of growth of scum layers in vertical digesters.

The scum layer, being as strong as a woven sleeping mat, can stop biogas from escaping the digester. This does not mean that the gas will stop being produced. If the gas cannot get out of the digester, it will make room for itself by forcing slurry out of the overflow pipe. Slurry will also be forced out of the overflow pipe if, somewhere along the gas line, the biogas is blocked by a closed valve, bent pipe, or water in a pipe. But if a blocked or otherwise closed pipe is not the cause, there is a good chance that there is a scum layer trapping gas in the digester.

The temporary solution is to break a hole in the scum so the gas can escape the digester. This can be done by pouring slurry from the overflow pipe and the outlet back into the digester's inlet. That is not a long-term solution because a scum layer big and strong enough to trap the gas is also reducing gas production by taking up lots of digester space. The long-term solution is to drain and clean the digester.

The whole digester should be cleaned once a year and if scum is a major problem the scum layer should be raked out halfway through the year. If scum has become that big a problem, time and effort should be put into reducing the amount of undigestible plant fibers that are getting into the digester.

The basic procedure for cleaning a digester is to:

- Close the gas line to the digester, remove the top-of-digester cover, and drain the digester from the outlet valve.
- After the slurry level has dropped to below the level of the scum door, the door can be safely opened and slurry removal can continue from both the outlet and the door.
- Once the liquid slurry has been drained, any remaining solid sludge and dirt must be raked, swept, or washed out.
- To make it quicker and easier for a digester to start producing gas after it has been cleaned, use the

liquid portion of the slurry that was removed to restart the digester.

- The solid portion of the slurry can either be used in a compost pile or, if it is possible to grind it up, it can be reused as slurry if it is free of dirt and sand.

There are advantages to building two medium-sized digesters instead of one large digester. When it comes time to clean or repair a digester, the other digester could take the extra waste for a few days. If there is just one digester, the waste that would have been fed into the digester should be composted.

Chapter six: Tanks and pipes: Storing and moving biogas

Because biogas is not used at exactly the same rate at which it is produced, it must be stored somewhere. The gas must be efficiently transported from digester to storage tank to use if it is to be used in a simple, low-cost manner.

What should the gas be stored in and how big should the storage tank be? There is no one answer. Each answer depends on what the gas will be used for, how often it will be used, at what rate it will be used, local costs of locally available building materials and so on.

Using the digester as a combination digester and gas storage tank is not considered here because even though it can reduce construction costs, it also reduces the gas production rate.

Much of the literature on the subject of biogas storage tanks says that the storage capacity should be equal to one day's gas production rate.

Another possible guideline to use is that the gas storage tank(s) should be able to store enough gas so that:

- Sludge is not forced out of the overflow pipe to make space for the gas in the digester.
- Gas never bubbles out of a storage tank's water seal because there is no more room for gas.
- The storage tank is never so empty of biogas that the gas pressure drops below one and one-half inches of pressure.

I have tried two different types of biogas storage tanks: the floating tank method and the truck inner tube method. At the demonstration model scale, the two methods cost approximately the same, for the same amount of storage space. A large 12 x 2400 size truck inner tube can hold a half hour of biogas used for cooking. Car inner tubes can only hold five to ten minutes worth of biogas used for cooking purposes. To use an inner tube for gas storage, unscrew the pressure valve and clamp a ¼ inch plastic gas pipe onto the nipple.

Floating gas tanks and inner tube storage methods both have problems.

- If the floating tank is not kept straight by a center guide post and/or outside tracks, the gas (because it is under pressure) will force the gas tank to tilt and biogas will escape out of the bottom of the tank.
- The inner tube does not maintain gas pressure very well, and a stable gas pressure is very important. A large board must be placed on top of the inner tube and that one board must cover the whole inner tube. When concrete hollow blocks were placed on the board, the all important gas pressure was maintained, but only when the inner tube was relatively full.
- An inner tube or plastic bag cannot maintain gas pressure as well as a floating gas tank can. When

the gas is used, the inner tube collapses under the weight of the hollow blocks, but the space inside the tube does not disappear as completely as it does when gas is used from a floating tank.

When pressure of the gas drops in a biogas system, the gas flame gets smaller and weaker, it can go out; then unburned biogas will escape, risking the danger of fire and explosion. It is best to use biogas between 7.5 cm/3.0 inches and 15 cm/6.0 inches of water pressure. Above that level and the biogas bacteria begin to find it hard to produce biogas; below that level and it becomes hard to maintain a flame. Adding up all the pluses and minuses, the separate floating gas storage tank is the method for gas storage recommended in this book.

Floating Tank Method

The floating tank method of gas storage consists of two parts: an open-top tank filled with water and another slightly smaller tank, with large holes in its bottom, floating in the water (see Diagrams 11 and 12). The floating tank, where the gas is stored, has a variable capacity to compensate for the differences between the rate of gas production and use. This variable capacity keeps the pressure inside the system constant. Biogas from the digester fills the gas tank, displacing water and pushing the gas tank up. When the biogas is used, water replaces the consumed gas and the gas tank falls.

The dimensions of the gas holder should be such that, when it is floating, no part should touch the water tank it is floating in. Guide posts should be provided so that the gas tank can move up and down without tilting or getting stuck.

- Guide posts and wheels can be placed in the space between the floating tank and the water tank, or a post or pipe can run through the middle of the floating tank.
- To prevent the gas tank from floating too high and letting gas escape, crossbars are located at a height such that when the floating tank is full of gas, its bottom remains eight inches below the rim of the water tank.
- The height of the cross bar above the top of the water tank should be eight inches less than the combined heights of the floating gas tank and the water tank. In this way, the pressure in the biogas system cannot go over 20 cm (8.0 inches) without the excess gas bubbling out of the water seal.

When the floating tank is not pressing up against the crossbar, the pressure in the system is only that which is necessary to raise the tank.

- If that pressure is less than four or five inches, put a concrete hollow block or two on top of the gas tank.
- Experience with the demonstration model system has shown that if the floating gas tank has room to tilt, the pressure of the gas inside it will force the bottom of the tank to move to one side or the other and biogas will escape in great big bubbles.
- In trying to keep the gas tank from tilting, do not stop it from being able to move up and down freely. If it happens while the gas is being used, the pressure will drop fast and the flame will go out. If the floating gas tank gets stuck when the gas is not in use, the pressure will build up very fast, forcing slurry out of the digester.

Biogas storage tanks can be made out of corrugated galvanized iron (GI sheets), concrete, fiberglass, plastic, etc. The following construction ideas were adapted from Practical Building of Methane Power Plants for Rural Energy Independence. These plans can be adapted to the building materials of your choice. The four guide poles can be replaced by one pole which runs through the center of the gas tank in small capacity tanks and perhaps in large tanks too, and the gas pipe coming in from the

bottom can be replaced by one attached to the top of the gas tank, as long as it is attached in such a way that the flexible plastic pipe never even starts to fold.

The biogas storage tanks described here were made inexpensively from corrugated galvanized iron water tanks. All fittings for the gas pipes, guide poles, and bracing were standard plumbing items with the exception of the pulley wheels (rollers) which were mounted on brackets. The base of the brackets were wide enough to be bolted onto the tops of two adjoining corrugations in the tank. The concave roller fitted loosely around a one-inch diameter guide pipe.

An important feature of a gas tank is that it should move up and down freely, without too much friction. If more than one gas tank is used, each can have weights placed on it in succession so that the first to fill with gas will be the lightest. As the first one reaches its capacity, the upward movement will be stopped by the top of the gas tank pressing up against the crossbar. Gas will then flow to the next heavier tank and so on until the last tank is full, at which time any excess biogas will bubble out through the water seal.

Concrete hollow blocks make ideal weights to increase the gas pressure to 15 cm/6.0 inches of water pressure. At that pressure biogas will easily flow through the gas pipes for engine and household purposes.

Two tanks were made at a water tank factory:

1) The gas holder was 8.0 feet 9.0 inches in diameter and 6.0 feet in height and made of 24 gauge, common-use corrugated galvanized iron. One end, the top end when used as a gas holder, was 22 gauge. The extra strength prevented the top from ballooning out when in use.

The bottom end floated constantly in water.

1.5) Since the bottom of the gas holder moved through the water when gas entered or exited, large holes were made to reduce friction. The whole bottom end was not removed in order to provide some lateral (sideways) strength and keep the rollers positioned firmly in relation to the guide pipes. The biogas pipe came up from the bottom through the largest of these openings.

2) The water tank was 9.0 feet, 8.0 inches in diameter, open at both ends, and 6.0 feet in height.

DIAGRAM 11: GAS STORAGE TANK DESIGN

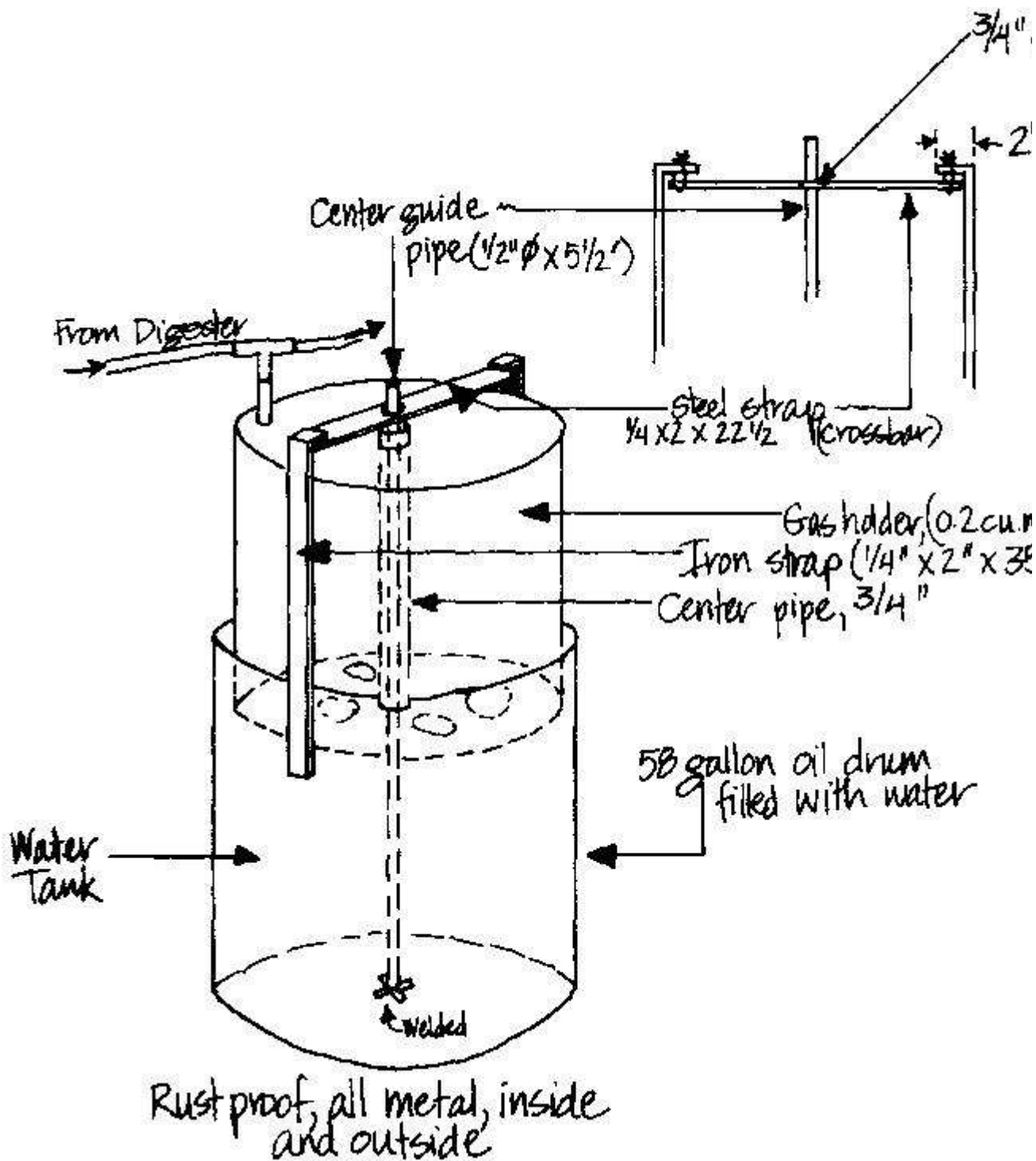

RUST PROOF

-The height of the cross bar above the top of the water tank must be eight inches shorter than the combined height of the water tank and the floating gas tank. This will keep the gas pressure from getting dangerously high. When the pressure goes over eight inches, the extra gas will escape from the bottom of the floating gas tank. If this happens often, gas is being wasted; build a second gas storage tank. Gas tank capacity should be about the same as digester capacity.

WARNING: A 58 gallon oil drum, cut down to be a gas holder, can only hold about 0.2 cubic meters of biogas.

The screw clamps need to be tightened very tightly to the plastic pipes and wrenches can tighten

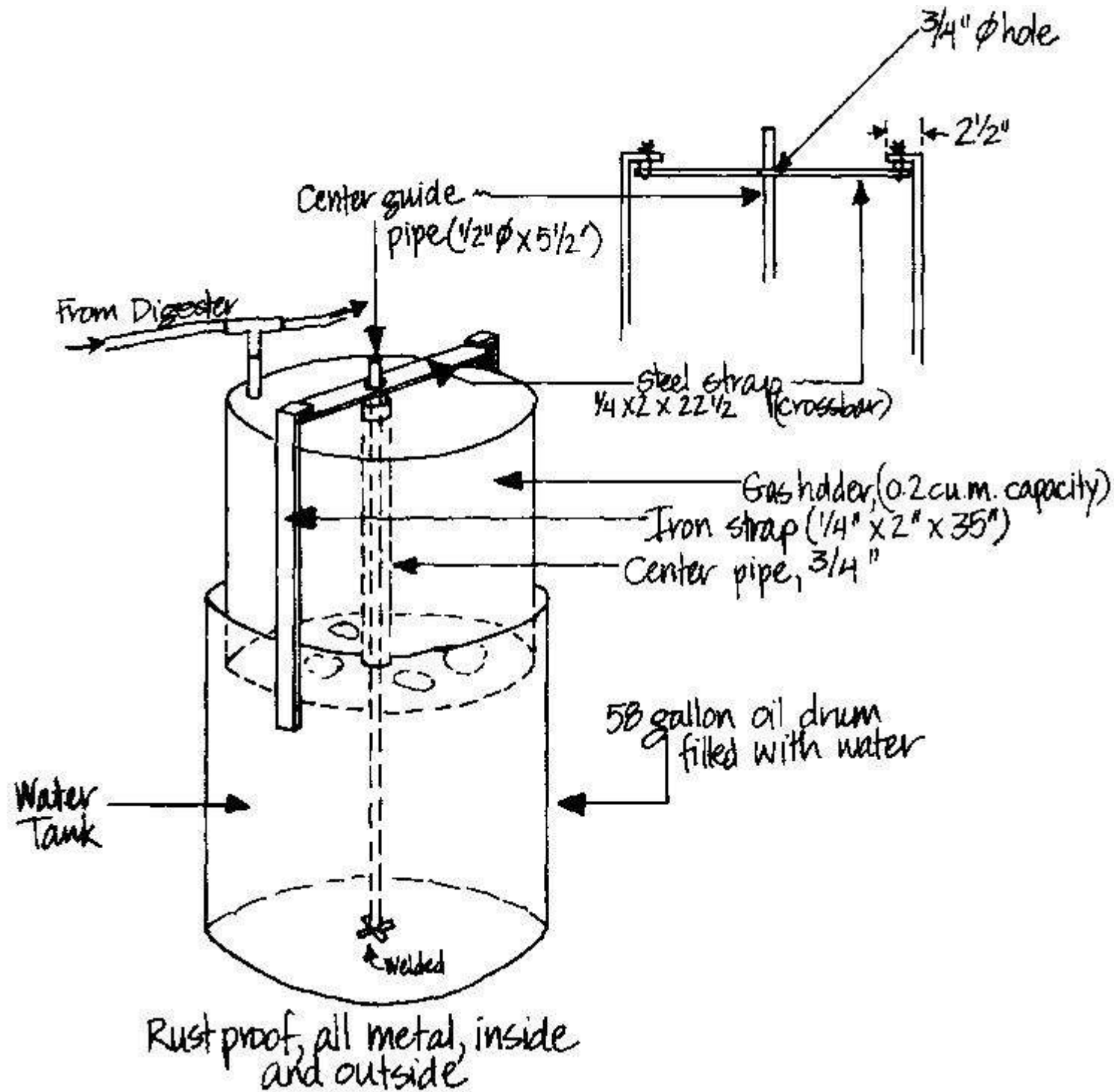

RUST PROOF

-The height of the cross bar above the top of the water tank must be eight inches shorter than the combined height of the water tank and the floating gas tank. This will keep the gas

them tighter than screwdrivers can.

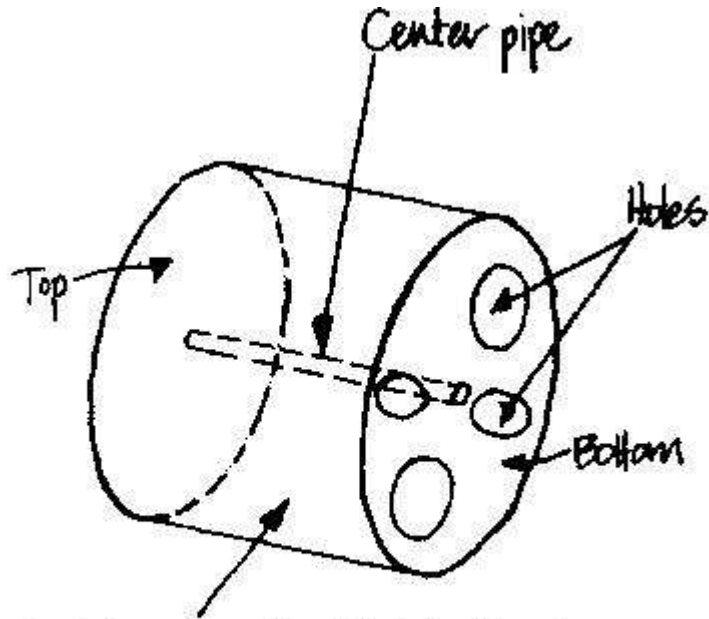

A Gas holder is simply a bottomless container floating on water, under which gas collects.

A GASHOLDER

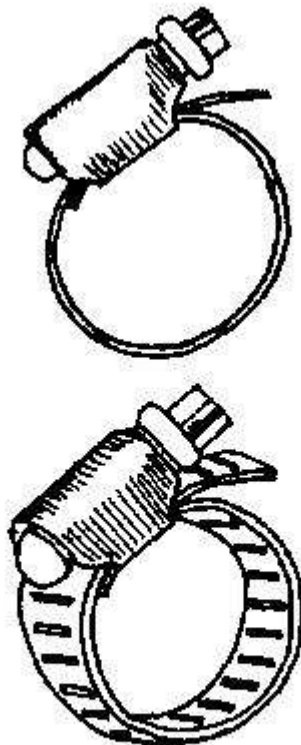

**METAL SCREW CLAMP
USED ON PLASTIC PIPING**

METAL SCREW CLAMP USED ON PLASTIC PIPING

DIAGRAM 12: LARGE CAPACITY GAS STORAGE TANK DESIGN (Fry, 1974)

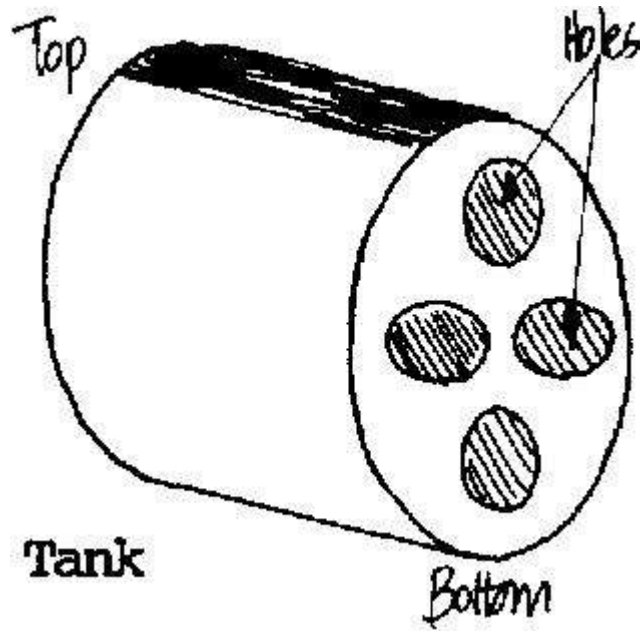

1. Gas Holder Tank

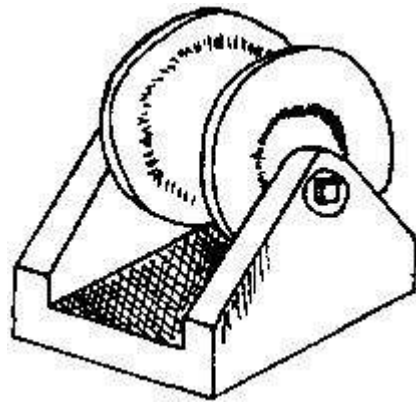

2. Gas Holder Roller

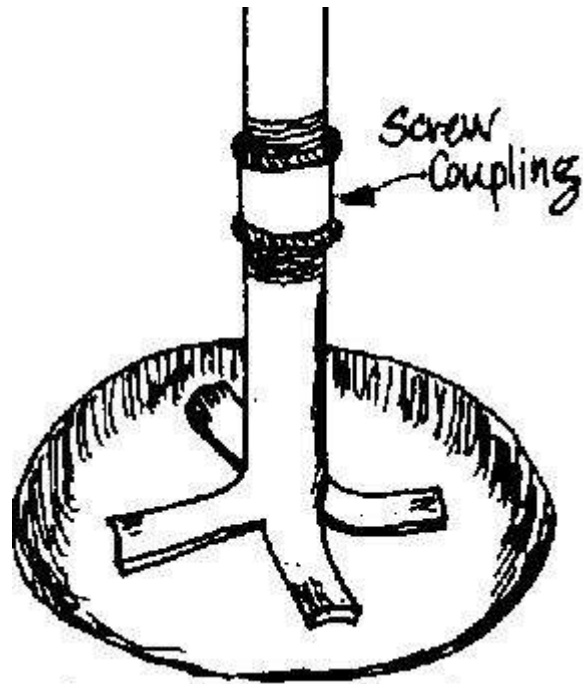

3. Splayed Pipe in Dug-Out Hole As Base to Guide Pipe

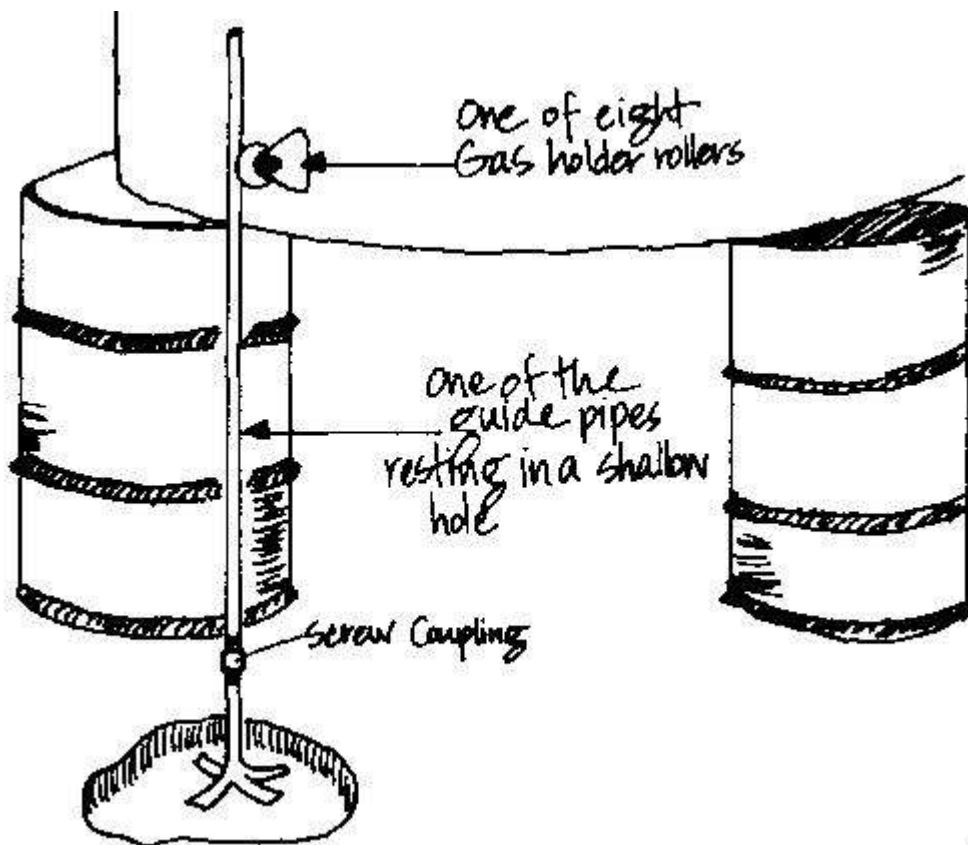

4. Positioning of Gas Holder

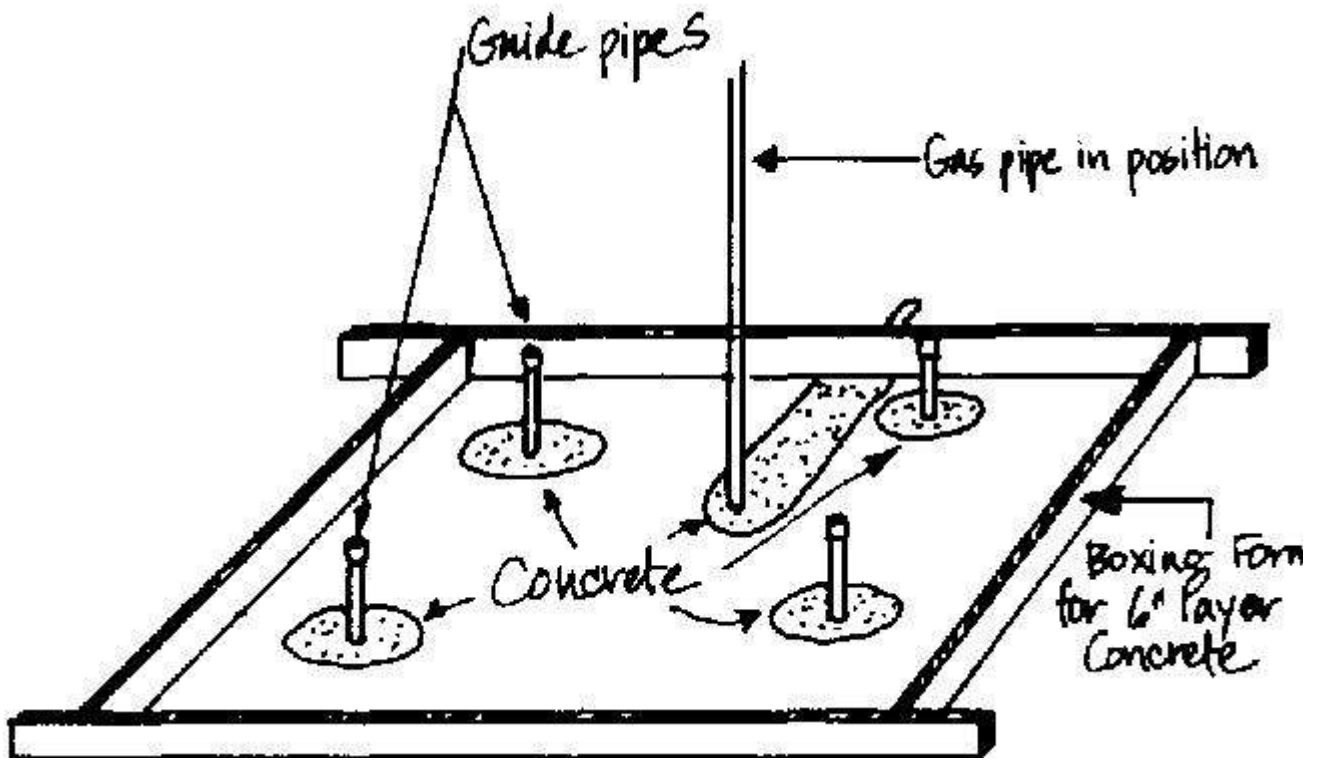

5. Base to Water Tank Being Made of Concrete

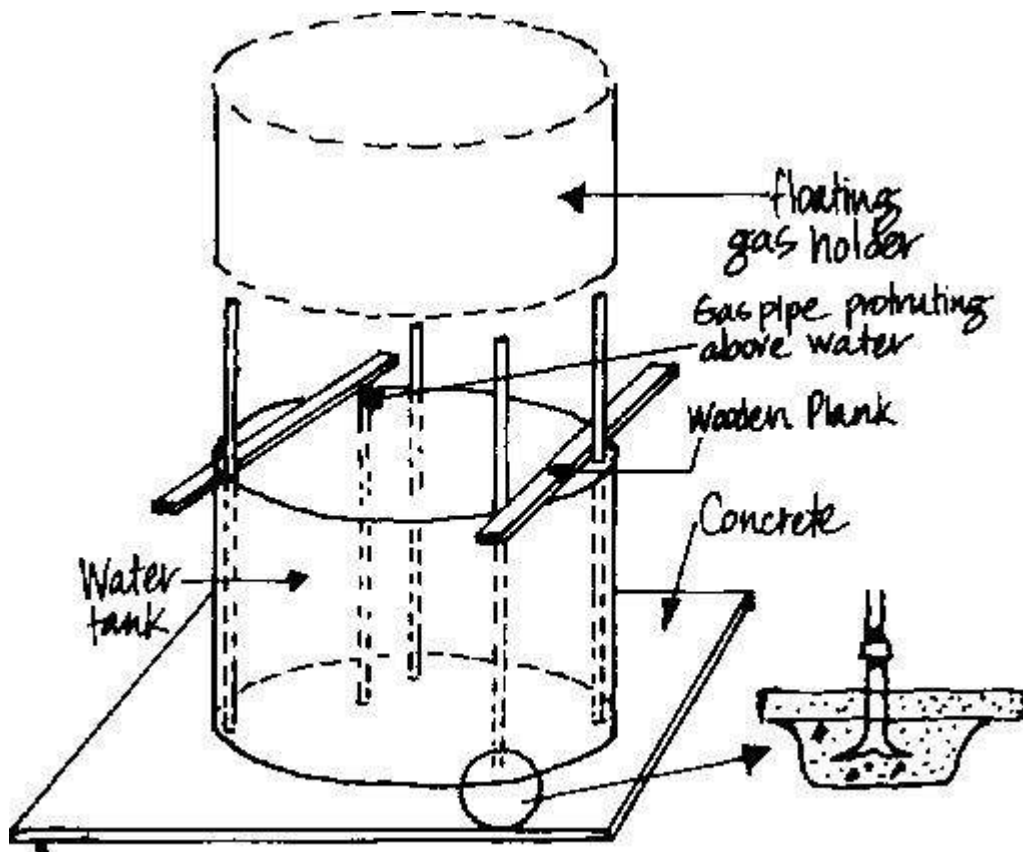

6. Water Tank Filled and Ready for the Gas Holder to Be Lifted into Position Along Planks

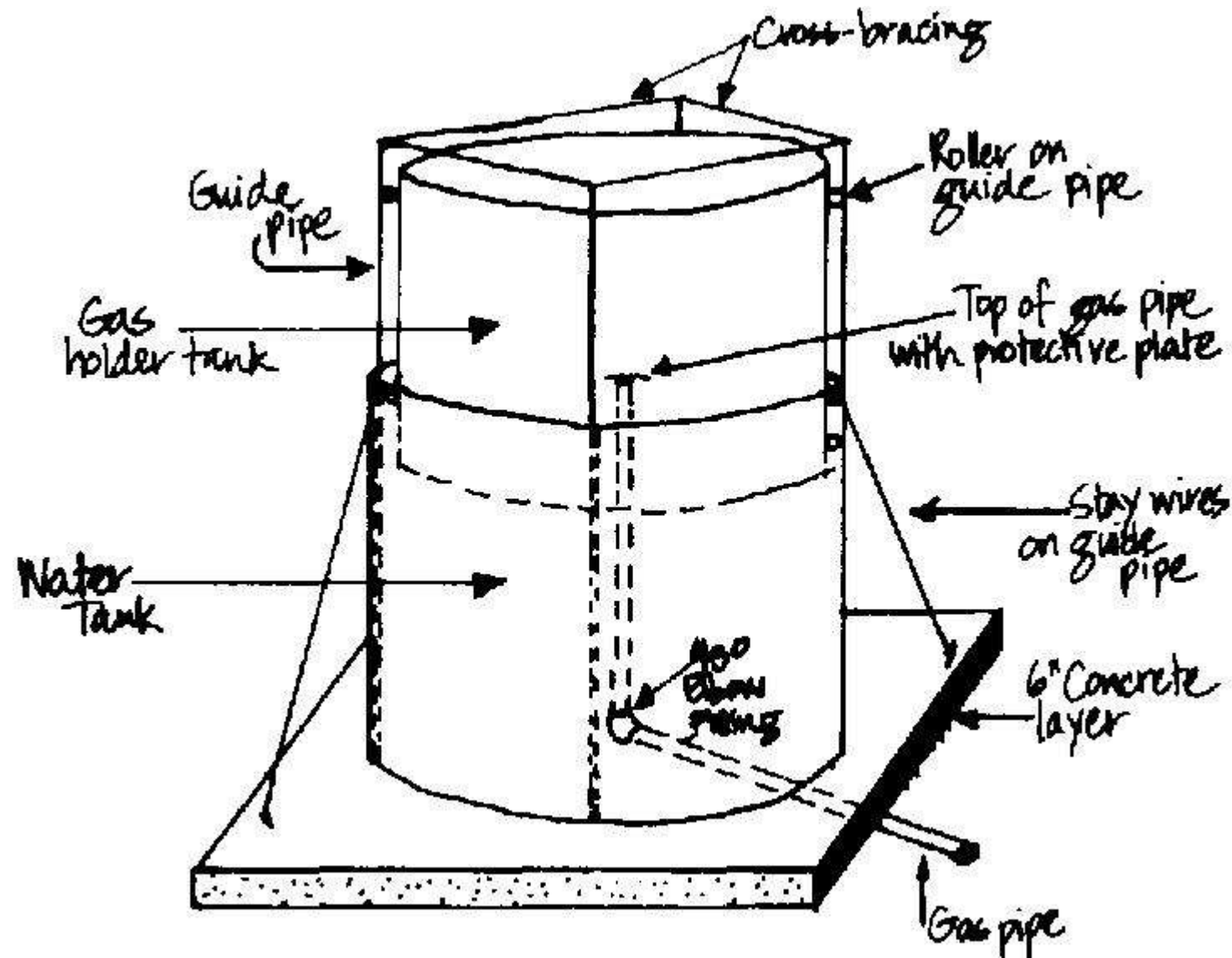

7. GAS HOLDER Filled Up

Construction Steps (see Diagram 12):

1) The floating gas tank was carefully measured and eight rollers were bolted on; first the four top rollers were placed one-quarter of the distance from each other around the circumference of the tank. The other four were bolted at the bottom and directly in line with the top ones. The tank was then positioned on level ground exactly where it was to be installed but raised off the ground for convenience in digging (explained later).

2) The four guide pipes were cut and threaded at both ends. The length was calculated as follows:

A) Since the tanks were each 6.0 feet the combined height had to be less than 12 feet.

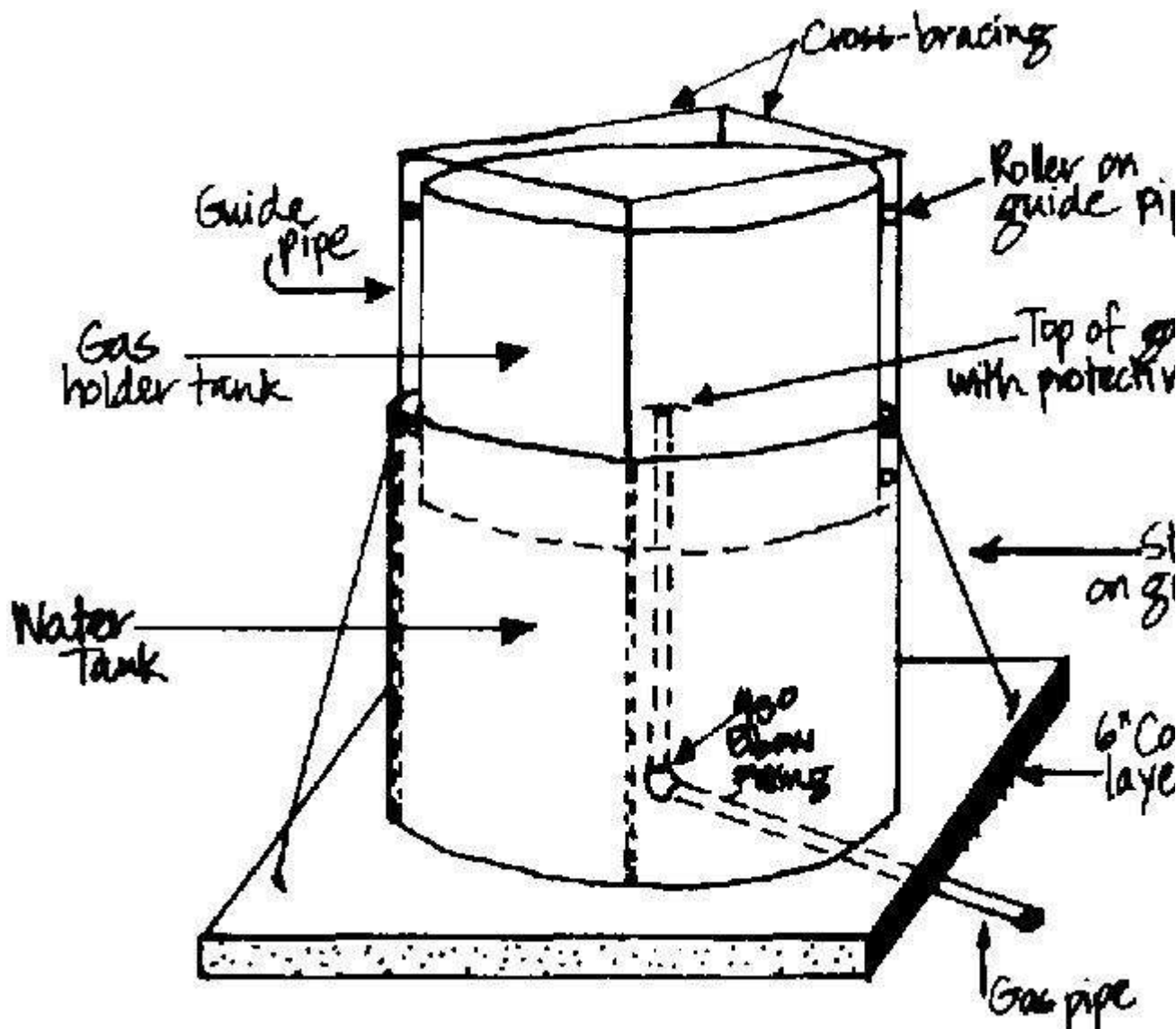

7. GAS HOLDER Filled Up

Construction Steps (see Diagram 12):

1) The floating gas tank was carefully measured and eight rollers were bolted on; first the four top rollers were placed one-quarter of the distance from each other around the circumference of the tank. The other four were bolted at the bottom and directly in line with the top ones. The tank was then positioned on level ground exactly where it was to be installed but raised off the ground for convenience in digging (explained later).

2) The four guide pipes were cut and threaded at both ends. The length was calculated as follows:

A) Since the tanks were each 6.0 feet the combined height had to be less than 12 feet.

B) 6.0 inches was deducted from each guide pipe. This 6.0 inches represented the upper limit of the gas pressure in the whole biogas system.

C) If the gas tank was to be any but the last holder in the series, a further 2.0 inches were removed. If the guide pipes were for the only gas tank, or the last of a series, the pipe length was 11 feet, 6.0 inches. Four more pieces of pipe, each 14 inches long, were then cut off the guide pipes and threaded at one end. The other end of the pipe was cut lengthwise for two inches in two cuts at right angles to

each other. Each of the four pieces were then splayed (spread) out to form a footing for holding firmly in concrete. A coupling, sometimes called a socket, was then screwed firmly onto the short pieces and loosely to the long guide pipes.

3) The four guide pipes were then placed against the rollers and held in place by a piece of wire drawn around all four pipes and the tank. The wire was placed midway between the two sets of rollers and slight tension was applied. The tension was enough to bend the pipes inward by only 1/8 to 1/4 of an inch. Later on when construction was finished, this slight misalignment would provide enough play so that the rollers would not press too hard against the guide pipes.

4) Making sure that the gas holder was completely vertical, so that gas could not accidentally escape, the four guide pipes with their couplings and short lengths screwed on were placed on the ground. A small hole was dug around each splayed foot to a depth of 6.0 inches below ground level and a little concrete was poured into and around each.

Because there is always the chance that lightning might strike, it is strongly recommended, at this point in the construction, to drive a metal stake deep into the ground near one of the feet and bind the two together with wire to make a good electrical contact. This should also be done with digesters that are made of metal. L. John Fry did this on his farm and one of the tanks was indeed struck by lightning. Because the gas tank was grounded, no damage, explosions, or fire occurred.

5) With the floating gas tank in position, the gas pipe was then installed. The size of the gas pipe had to be proportional to the size of both the pipe used for daily sludge removal and the loading pipe of the digester, for the simple reason that when the digester is loaded, biogas is pushed into the gas holder very rapidly.

If sludge is removed through a 3.0 inch outlet, gas to replace it has to flow back to the digester. Since gas flows more easily than liquids, a pipe size of 2.0 inches for the gas pipe proved to be large enough. The 2.0 inch pipe was set in the concrete base of the gas holder with a 90 degree bend leading up to the same height as the top of the water tank. The pipe consisted of a threaded length leading in from outside and laid in a shallow, 2.0 inch deep ditch.

A slow bend (not an elbow joint) and a vertical length of pipe was used to bring the pipe level with the top of the water tank, a distance of about 6.0 feet, 4.0 inches from ground level. The open end of the pipe was kept from damaging the gas holder and also from shutting off the gas flow when the gas holder was in the down position by welding a small metal plate at right angles to it, one-half inch above the pipe opening.

The final positioning of the gas pipe consisted of laying it in the shallow trench so that the vertical portion passed freely through the largest of the openings cut in the bottom of the gas tank, without being in line to touch the tank at any point of its travel up and down. The gas pipe in the trench was checked with a spirit level to make sure that it was slightly off the level, so that any water condensation would lead away from the tank, to an outside condensation trap. Later, a little concrete was laid around the gas pipe to keep it in position until the concrete base was poured to hold it firmly in position.

6) When the concrete was set, the guide pipes were unscrewed at the couplings. This was done very gently to avoid moving the concrete. The guide pipes were marked for their respective final positions and laid on the ground. The gas holder tank was removed so it and the water tank could be painted. The outside walls of the tanks were painted to delay corrosion (the process of rusting). The inside walls of the tanks were painted with asphalt emulsion, otherwise the biogas would have stripped the galvanizing from the metal, causing corrosion from the inside.

One tank was not treated on the inside and was in use for over four years before repairs had to be

made. The galvanizing had been completely removed by the gas, leaving bright steel which yellowed with rust within minutes of being exposed to air. This was further reason for coating the inside of the tanks, as well as the outside. Asphalt emulsion was used because of its relative cheapness and because no harmful fumes were let off while painting inside. A rule to remember is that corrosion is greatest at the line where water and air meet.

7) With the site clear except for the four short pieces of guide pipe with couplings and the gas pipe, the water tank was tested for fit by placing it over the four short guide pipe pieces. Boxing for concrete 6.0 inches deep was then made on all four sides, and the water tank was removed.

8) Concrete was then poured into the box 6.0 inches deep. Only the four couplings and the gas pipe were visible above the surface of the concrete. The outer (water) tank was immediately placed in position while the concrete was still wet and vibrated so that it sunk two inches into the concrete. A true vertical position was checked with a spirit level and the tank was propped with wood supports as necessary to hold the position while the concrete dried.

9) Final assembly: After a week to allow the concrete to slowly dry, three of the guide pipes were screwed into their respective couplings. The water tank was filled to the top. Planks of wood were laid across the top of the water tank and the gas tank was then placed on the planks in its designated position. The fourth guide pipe was then screwed into its coupling.

The four guide pipes were linked and cross-braced using ordinary pipe fittings and one-half inch pipe or railing fittings as used in pipe scaffolding. To ensure strength where high winds could damage the gas holder, guy wires went from the guide pipe structure to concrete hollow blocks a few feet from the base of the water tank. The gate valve on the 2.0 inch pipe was closed. Then by levering at a number of points, the planks were removed and the gas tank lowered to float in the water.

The gas holder was then left floating in the water tank for 24 hours to check for leaks. The next day, when the gate valve was opened, the air escaped and the gas holder slowly sank to its lowest point. The water tank was then topped off with water.

10) When first put into use as a gas holder, biogas displaced the water as it filled the gas tank, causing water to overflow the sides of the water tank until the gas tank began to float. After that, no more water overflowed and the gas tank rose and fell according to the flow of gas. More water does not need to be added to the water tank except to replace water that evaporates.

After four years of operation, sludge poured out from the overflow pipes of both digesters when the biogas went to one particular gas holder. The cause of this problem was that gas could not flow into the gas holder. The gas flow was switched to another gas holder and the pipes to the faulty one were taken apart. The metal gas pipes were found to be completely blocked with a black fur. It could be removed easily in the straight portion of pipe by rodding out, but this pipe had an elbow joint which prevented further cleaning and a plumber's snake drain cleaner had to be used to finish the job.

Caution: In the dismantling of metal biogas pipes--the rapid oxidation of iron sulfide deposits within the pipes may create heat or flame. In this respect, plastics pipes are safer.

The following paragraphs from the Guidebook on Biogas Development describe the use of concrete in making biogas digesters and biogas storage tanks.

Ferrocement

Ferrocement is a composite material made of thin wire mesh layers inside a high quality cement mixture. It is a reinforced concrete, but unlike ordinary reinforced concrete, it has a high resistance to cracking. Ferrocement can be cast into sections as thin as 1.0 cm/½ inch. It is suitable for precast

products because of its relatively low weight/high strength.

Ferrocement gas holders and digesters are:

- cheaper than mild steel gas holders and digesters of the same capacity,
- have lower thermal conductivity (will stay warmer longer),
- have a high resistance to corrosion (rust), and
- can be made in rural areas using local moderate-skill labor.

For manufacturing gas holders and digesters on a large scale, process equipment can be used to cast cylindrical ferrocement units. In this case, better control of the thickness and a higher degree of compactness may be achieved.

In bamboo-cement gas holders and digesters, the wire mesh is replaced by bamboo mesh, which is cheaper, lighter, and usually more available in many rural areas. Suitable coating should be applied to the inside and outside surfaces of both ferro- and bamboo-cement gas holders and digesters to improve their ability to be gaslight. It has been reported from India that bituminous (asphalt or tar) surface coatings have given satisfactory results. Ferro- and bamboo-cement gas holders and digesters should be tested for leaks before they are used and occasionally during their operation.

Where there are existing ferrocement skills, this technology can be tried. Otherwise it is best to learn the art first on structures where wall thickness, weight, and airtightness are less important. There is a complete set of instructions on the art of making ferrocement concrete structures in the Appendix.

Water Vapor

In addition to methane and carbon dioxide, there can also be a lot of water vapor (steam) mixed with the biogas. This water vapor can be a problem. If enough of it collects as water in a low point of a gas pipe, the flow of gas will be stopped. Water vapor can rust metal pipes and it lowers the temperature of the biogas flame (the flame may look reddish). If at all possible, trap the water before it does any harm by using what are called water or condensation traps (water condensation is the changing of steam into water). There are several ways to do this, including four designs shown in Diagram 13.

For steam to condense into water, it has to become colder. A water trap that the sun shines on may work, but it will not work as well as it could. If the water trap is shaded from the sun, it will work much better. It is best to have more than one water trap in a biogas system. Two good places for a water trap are just outside of the digester and Just after the gas storage tank.

DIAGRAM 13: FOUR WATER CONDENSATION TRAPS

danger: some gas will escape with the water & if the valve is left open, all the biogas in the system will escape

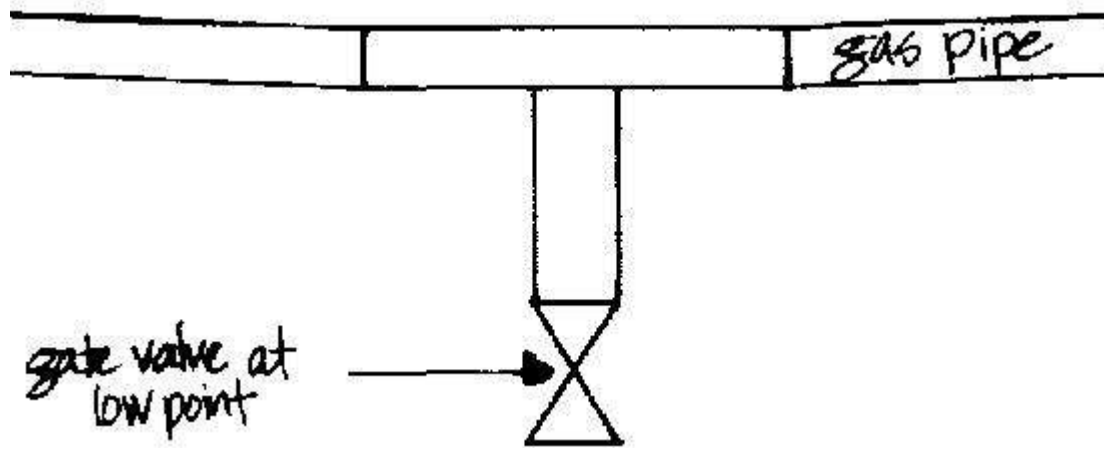

CONDENSATION TRAPS 1

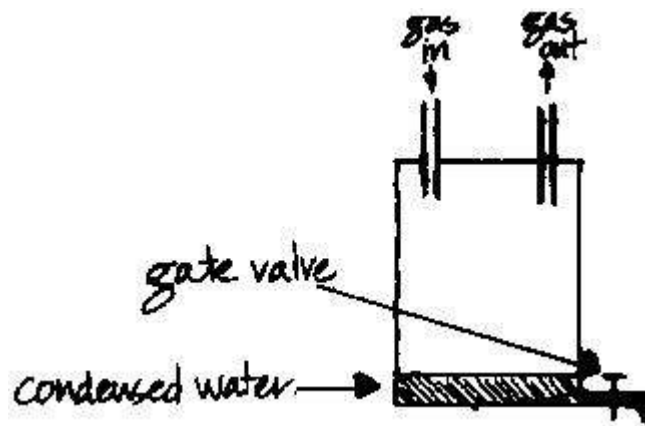

CONDENSATION TRAPS 2

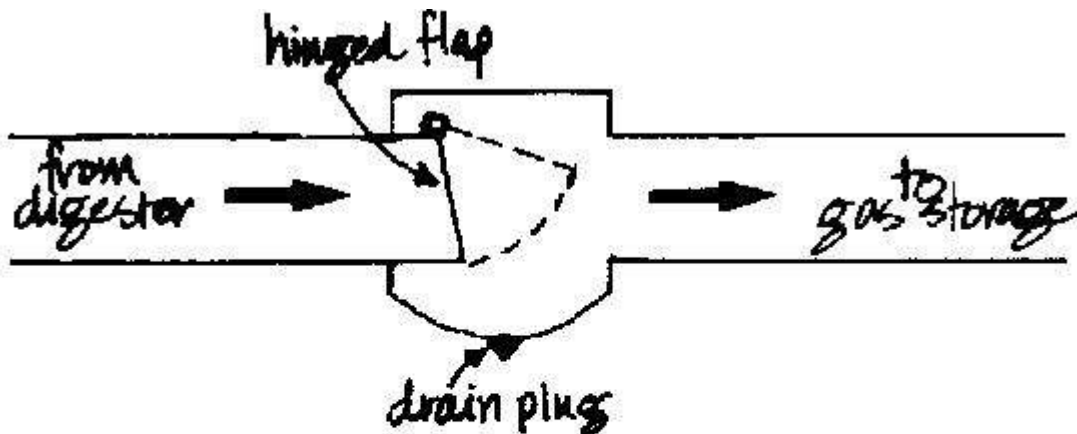

The hinged flap valve is more than a condensation trap. The hinge keeps air or gas from getting into the digester if something goes wrong.

CONDENSATION TRAPS 3

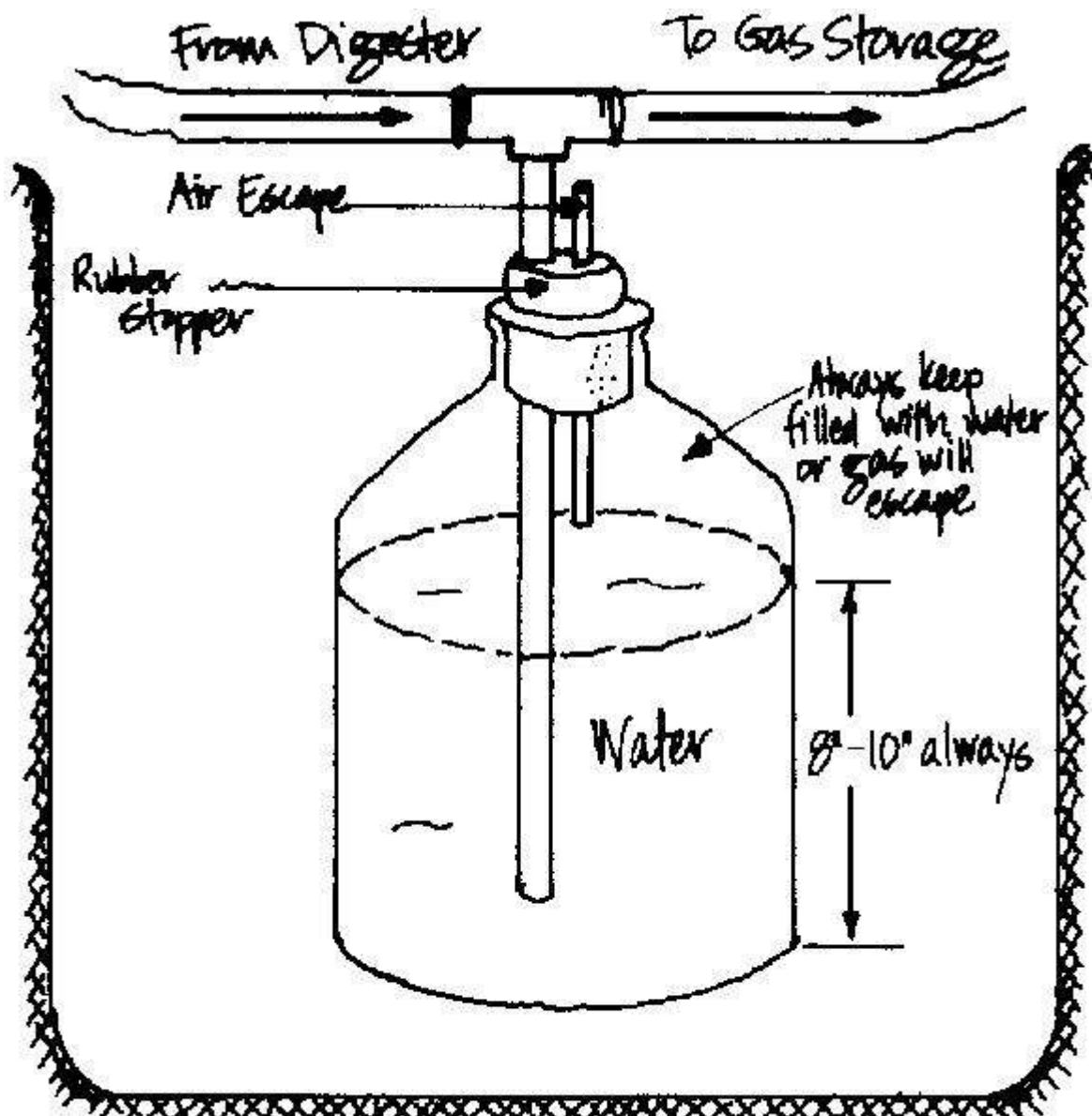

The number of inches of water is the upper limit of your gas pressure. Recommended pressure: 8 to 10 inches of water. Check water level regularly because the water will evaporate --- lowering your maximum gas pressure.

CONDENSATION TRAPS 4

Adapted from: Practical Building of Methane Power Plants for Rural Energy Independence.

Pressure

The gas pressure gauge in Diagram 14 is a simple, homemade instrument for measuring how much pressure the gas is under within the biogas system. The gauge does not measure how much gas is in the gas storage tank and the rest of the system; it measures how tightly packed the biogas is. If the gauge reads one inch or less, one can safely guess that there is not much gas in the system. If the gauge reads seven inches or more, one can safely guess that there is a lot of gas in the system. In the appendix there is a description of a method for figuring gas volume, but it takes time and involves measurements and a math formula.

There is a real need for pressure gauge readings. Four to six inches are the best pressures at which to use biogas. Above eight inches the gas production rate goes down; if this happens often, a bigger gas storage tank is needed.

When the gas pressure drops below one inch, all use of biogas should be stopped before the gas stops burning on its own. When biogas stops burning because the pressure is too low, the gas will continue to come out of the pipe, and the danger of fire and explosion becomes real. A pressure gauge should be next to each and every use of biogas such as stoves and engines.

DIAGRAM 14: GAS PRESSURE GAUGE

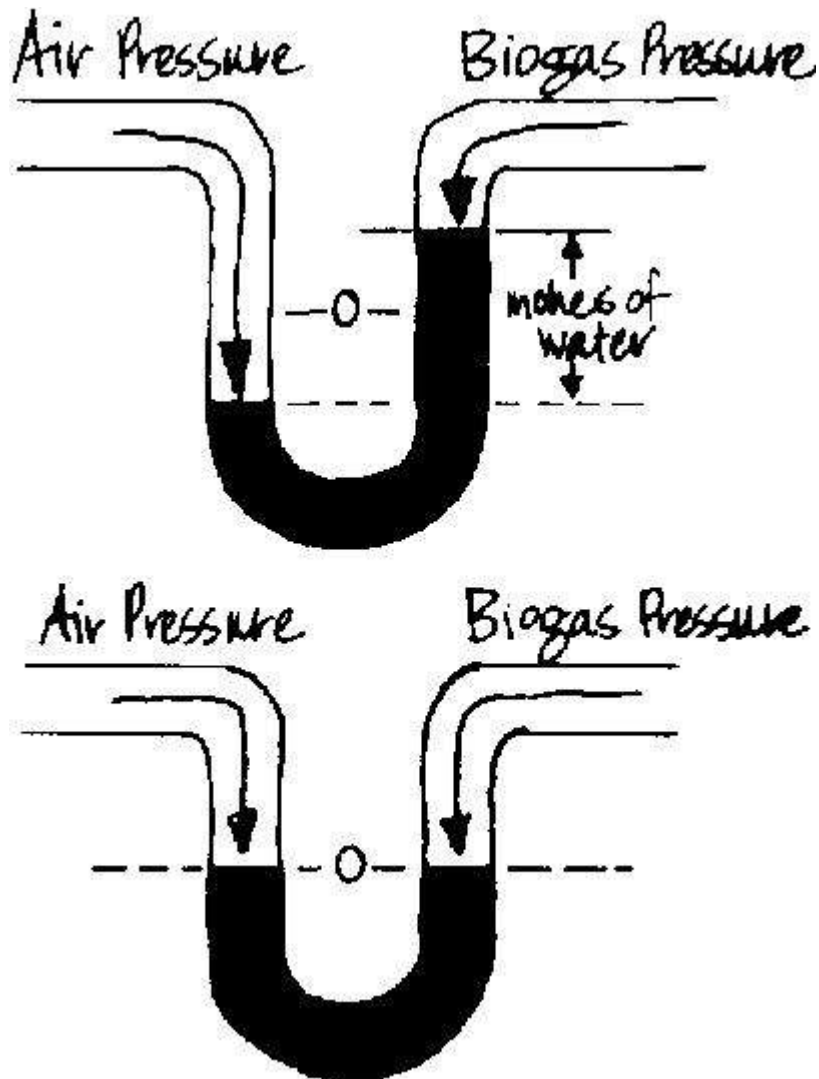

In drawings on left, switch biogas and air pressure to correspond with gauge on right.

-Gas pressure is greater than the air pressure and the difference is measured here in inches of water.

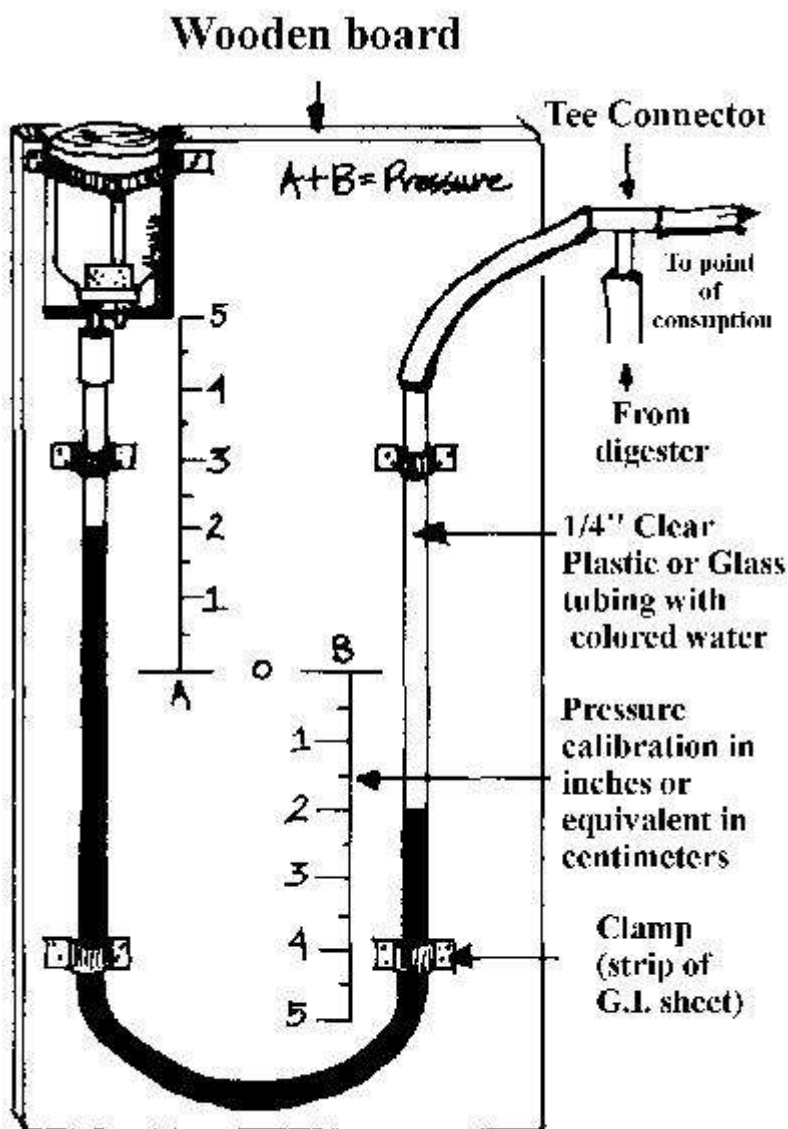

The gauge measures gas pressure not gas volume.

The safety valve bottle on top of the pressure gauge is optional. The pipe must be left open if the safety valve is not included. If the bottle is used and if the pressure goes over ten inches, the gauge water will be saved.

To find out how much pressure the gas in the digester and storage tank is under, add the level of the colored water in both sides together. That combined number is for the gas pressure. For example: two inches on left + two inches on right = four inches gas pressure.

Pipes

Why choose plastic (PVC: poly vinyl chloride) plastic pipes over metal pipes? Why choose clear plastic pipes over plastic pipes that cannot be seen through? Why choose expensive large diameter pipes over inexpensive small diameter pipes?

1) Plastics pipes are cheaper than metal pipes, they do not rust, and they can make turns without needing separate joint pieces (as long as the turns are gradual).

2) Clear plastic pipes can be checked for condensed water that could block the pipes.

3) PVC is a kind of plastic that is not as likely to leak as other kinds of plastic. All plastics eventually become hard, brittle, and crack; but some types age faster than others.

4) Small diameter pipes resist gas flow more than large diameter pipes do-this resistance lowers the all important gas pressure. If the price can be paid, use one or two inch diameter pipe, especially for long distances. Try not to use less than 3/4-inch pipe.

Plastic pipes have disadvantages, too.

1) If they touch something very hot, like a hot cooking pot, a hole can be melted very quickly.

2) Rats can bite holes in the pipes.

3) Unless clamped very tightly to metal pipes, there will be a gas leak.

4) If a plastic pipe is bent too sharply, it will develop a fold which the biogas will have a hard time getting past. The fold will decrease gas pressure and will be a point where a leak can easily develop.

Sometimes when PVC plastic pipes are bought, there are already folds in the pipe, and Just straightening the pipe does not get rid of the fold. There is an easy solution. Wrap a piece of cardboard around the spot and tie it very tightly with string, forcing the pipe to be round again. After a few months the cardboard can come off and the plastic pipe should stay round.

If the plastic pipe does not fit tightly over a metal pipe, wrap plastic tape around the metal several overlapping times, then push the plastic pipe on it (it should never go on too easily) and clamp the plastic pipe tightly to the metal using the type of clamp shown in Diagram 10. When the digester is in operation, check all Joints for gas leaks by smelling them. Sounds funny, but it works. The less than one percent of biogas which is hydrogen sulfide smells like rotten eggs.

A tool that makes a good temporary clamp for plastic gas pipes is the locking doctor's clamp called a forcep. One or two forceps can be used to seal a gas pipe while changes are being made, without damaging the plastic pipe. The locking type of adjustable vise-grip pliers were found to be very useful for working on metal pipes and gate valves.

Hot, direct sunlight and sharp changes in temperature shorten the useful life of plastic pipes. Soft PVC plastic, depending on conditions, could last three to ten years before becoming brittle and leaking. It will last longer if it is covered or in shade than it will in direct sunlight. A new kind of PVC plastic called red mud plastic is now being sold. It does not age as fast as ordinary plastic does, and it is supposed to last 20 to 30 years. Until red mud plastic is available, hide plastic pipes from the sun as much as possible. One way to do this might be to run plastic pipes through bamboo. There is more information on red mud plastic in the Facts and Figures section of the Appendix.

Chapter seven: The factory's products: Biogas

What are biogas systems good for? Mr. Alejandro Judan, a farmer-businessman in Nueva Ecija, Philippines, raises pigs in his backyard. Bothered by the smell and the flies attracted by the pig manure, he decided to put up a biogas system. It consists of a vertical continuous-fed digester and a single sludge aging pond. The biogas is used for cooking meals and ironing clothes. The sludge is used to fertilize rice fields and fish ponds.

Mr. Judan solved the pollution problem in his backyard, but his next-door neighbor also raises pigs. Mr. Judan plans included letting his neighbor direct the pen washings from his pig pens into the

digester. With the extra biogas, Mr. Judan was able to install an engine and electric generator to run a water pump and light both his and the neighbor's house.

Mr. Jose Parayno is a retired engineer and his wife is a retired school teacher. They operate a general store and a piggery of about 300 pigs behind their store in Pangasinan, Philippines. Although the manure was hauled every day to their rice fields some five kilometers away, their neighbors still complained of the foul odor coming from the piggery. Hearing about how biogas controls pollution and improves sanitation, Mr. Parayno visited the biogas system at Maya Farms and decided then and there to have one built for his piggery.

With the help of Maya Farms, he built a 31 cubic meter continuous-fed biogas digester, and for sludge conditioning he built a 5.0 foot by 13 foot by 3.0 foot deep sludge aging pond. The overflow from the pond went into a nipa palm grove behind the piggery. After the biogas system went into operation, his neighbors stopped complaining. Now it is Mr. Parayno who complains because so many visitors come to see his biogas system every day. The biogas is used for cooking, ironing clothes, and lighting the piggery.

Mr. Parayno enjoys recounting what happened during the long dry summer of 1977 when the hydroelectric plant in Central Luzon could not generate enough power. He extended the biogas pipe to the store and transferred some of the mantle lamps from the piggery. When the electric power was shut off, as frequently happened, he had the only brightly lit store in the area. This brought in many customers. Mr. Parayno is now thinking about using the gas to run an engine and a 2.5 kva electric generator (Maramba, 1978).

In Diagram 3 there is a picture of the temperature of the different parts of a biogas flame. Food cooks and water boils just as fast, maybe even a little faster, when only the top part of the flame is touching the cooking pot. When the flame spreads out around the bottom of the pot, it only looks hotter. More gas is used but the food is not cooked any faster.

The biogas flame will not usually stay lit in ordinary gas stoves or other gas appliances until the hole on the gas jet is enlarged or in some cases removed. (The air intake may also have to be opened slightly.) This should provide a stable flame. Fortunately, gas jets are made of soft brass, so it is easy to enlarge the hole using sharp pointed scissors. Because biogas pressure is low, it is necessary to modify most existing equipment. A gas stove burner will work only after the needle-thin Jet is enlarged to 1.5 mm. Stoves, lamps, and engines using biogas work best at the low pressures of 3.0 to 6.0 column inches (8.0 to 15.0 cm) of water. In India at least two commercial companies make small cooking stoves specifically for biogas. Stores that import consumer goods might want to inquire from their suppliers about the availability and prices of ready made biogas stoves. But it is easy to make simple biogas stoves such as those in Diagram 15.

DIAGRAM 15 : HOMEMADE BIOGAS BURNER DESIGNS

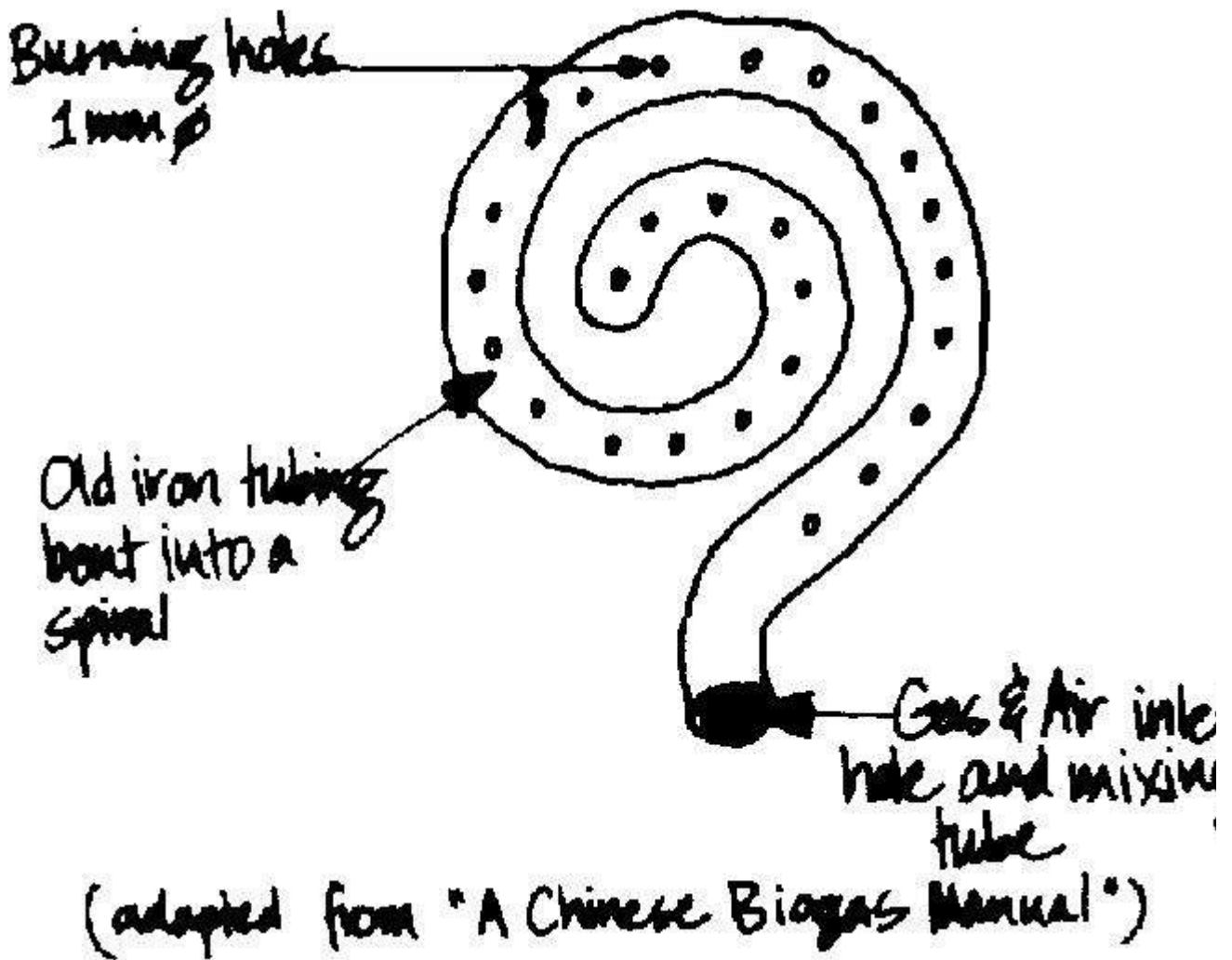

THE SPIRAL SINGLE-PIPE BURNER

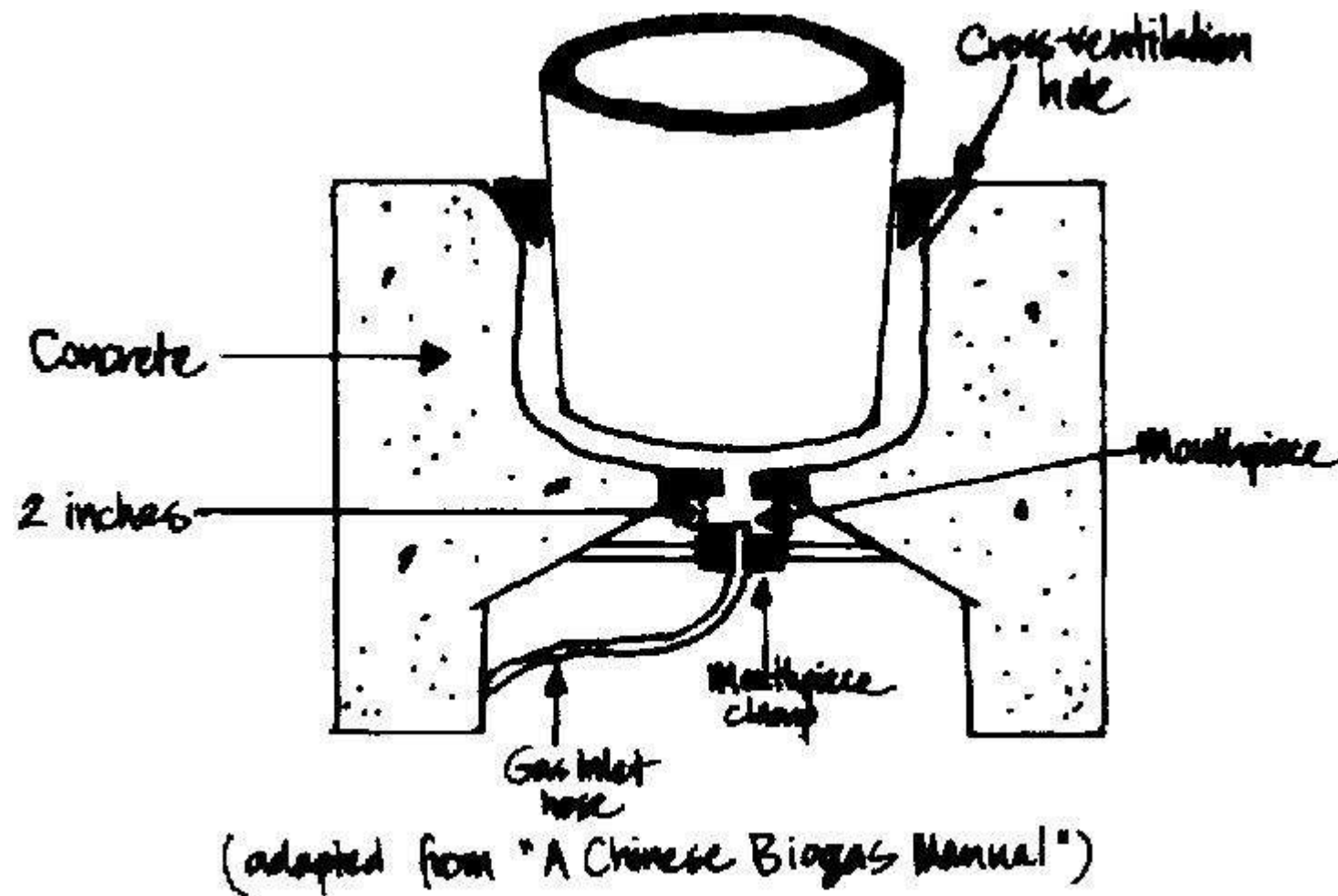

THE BIOGAS STOVE

For lighting purposes, biogas gives a soft, white light when burned in gas lamps. The light is not as bright as a kerosene lamp. The mantle is about as bright as a 40 to 60 watt electric light.

A cooperative or business should not try to distribute biogas to individual homes. It would be expensive and dangerous. The gas should fuel an engine plus generator and the electricity could be distributed, or the gas could be used to meet cooperative or business energy needs, and the profits could be distributed to shareholders or investors.

The same amount of biogas, for the same length of time will light three times as many electric lights as gas mantle lights of equal brightness.

Whatever appliance is used, it is important that an adequate volume of air is made available to burn with the gas. This air need not be pre-mixed. Biogas will burn on contact with air (and a match), but what is important is that air should not be restricted in any way. If it burns freely in air, the burnt gas will release only carbon dioxide and a little water vapor. If biogas is made to burn with an excess of air, the burnt gas may release sulfides, making the eyes itch and causing a sharp acrid smell.

L. John Fry reported two small failures with biogas. One involved a gas iron in which a flame burned to bring about heat. The flow of air into the iron was too much for the amount of gas, resulting in a foul smell. The other problem had to do with a gas refrigerator of the absorption type which was fueled with biogas for three years with a special burner. The problem

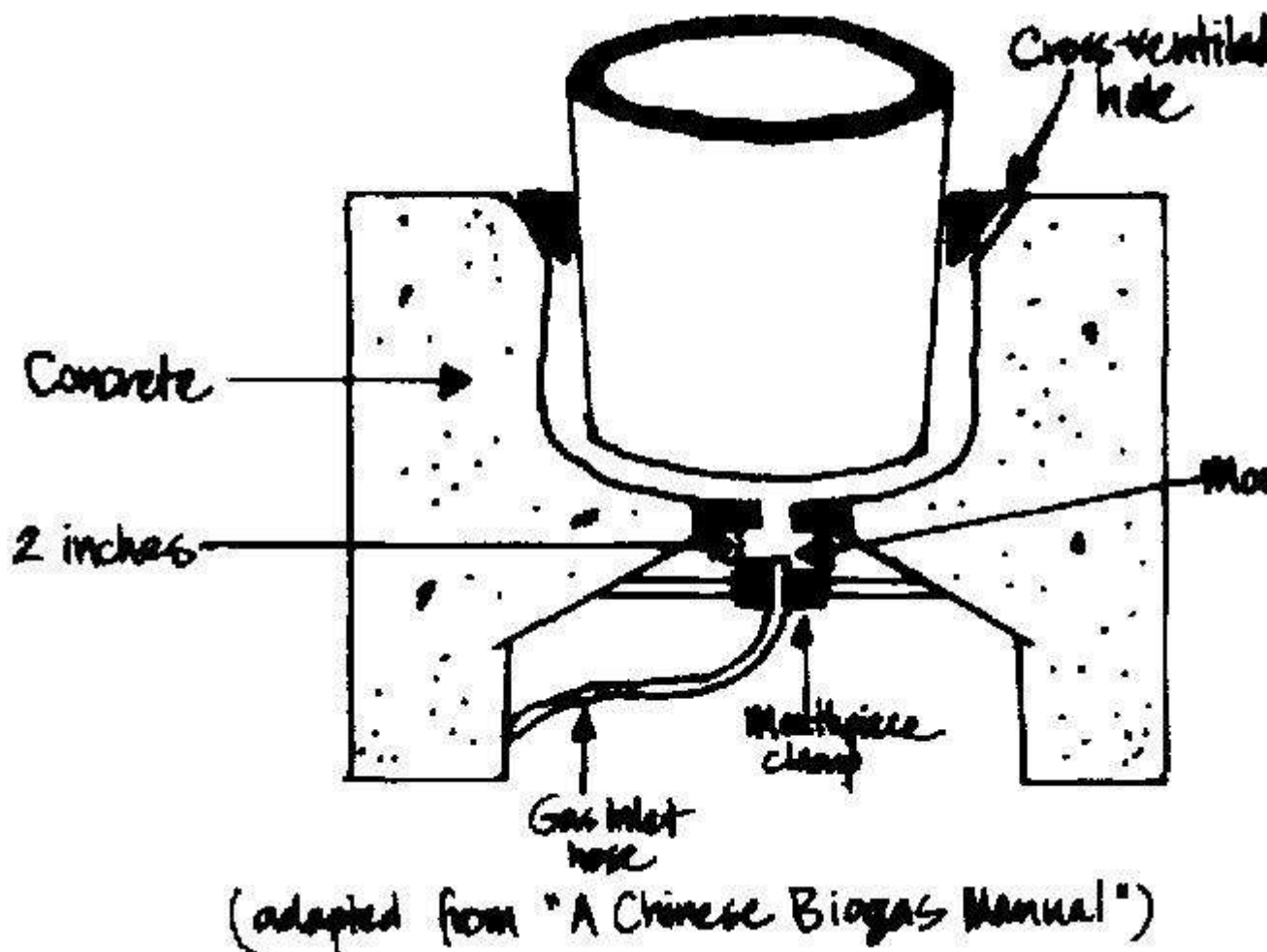

THE BIOGAS STOVE

For lighting purposes, biogas gives a soft, white light when burned in gas lamps. The light is not as bright as a kerosene lamp. The mantle is about as bright as a 40 to 60 watt electric light.

A cooperative or business should not try to distribute biogas to individual homes. It would be expensive and dangerous. The gas should fuel an engine plus generator and the electricity could be distributed, or the gas could be used to meet cooperative or business energy needs, and the profits could be distributed to shareholders or investors.

The same amount of biogas, for the same length of time will light three times as many electric lights as gas mantle lights of equal brightness.

Whatever appliance is used, it is important that an adequate volume of air is made available to burn with the gas. This air need not be pre-mixed. Biogas will burn on contact with air (and a match), but what is important is that air should not be restricted in any way. If it burns freely in air, the burnt gas will release only carbon dioxide and a little water vapor. If biogas is made to burn with an excess of air, the burnt gas may release sulfides, making the eyes itch and causing a sharp acrid smell.

L. John Fry reported two small failures with biogas. One involved a gas iron in which a flame burned to bring about heat. The flow of air into the iron was too much for the amount of gas, resulting in a foul smell. The other problem had to do with a gas refrigerator of the absorption type which was fueled with biogas for three years with a special burner. The problem here was the pilot light. The flame was small and delicate. A light wind could blow it out. Even the slamming of the kitchen door would blow out the flame. On the positive side everyone agrees that when biogas is used for cooking, the pots and pans remain spotless.

Biogas and Stationary Engines

Any internal combustion engine, except a two-stroke, can be adapted to run on biogas . On spark-ignition gasoline engines (hereafter referred to as gasoline engines), a biogas and air mixer is needed in advance of the carburetor near the choke. The biogas is introduced via a five mm diameter tube connected to the biogas supply through a control valve. The engine is started on gasoline and then switched over to biogas after the engine is running. The engine can be switched back to gasoline if there is a shortage of biogas. For smooth running of the engine, the biogas flow should be steady; this can be done on stationary engines by counterbalancing the gas cap. Sheaffer and Roland, a company that has developed biogas systems for use in the United States recommends using gasoline engines. They only use biogas for fuel, but they keep propane bottled gas as a backup in case there is a shortage of biogas. The company also recommends that engines that are run continuously have once a week oil and filter changes.

Because the use of biogas to run engines and the use of the excess engine heat to heat digesters are often the most important factors in making biogas systems profitable, what follows are three different reports on using biogas as an engine fuel.

L. John Fry's account of his use of biogas to run engines on a farm during a six year period is one of the more impressive ones to be found in biogas literature. The following section is adapted from his book, Practical Building of Methane Power Plants for Rural Energy Independence.

Methane (biogas without carbon dioxide) makes an excellent fuel for internal combustion engines because it:

- 1) has a very high octane rating,
- 2) leaves little or no carbon deposits in cylinders or on pistons,
- 3) greatly reduces the amount of sludge build-up in the oil, which means longer operating times between oil changes,
- 4) does not dilute the oil on the cylinder walls during engine start-up as liquid fuels do, and thus promotes longer engine life (as do numbers 2 & 3),
- 5) has no tetra-ethyl lead in it to foul spark plugs and pollute the air,
- 6) mixes better with air than gasoline, resulting in a better explosion in the cylinder,
- 7) results in less valve burning,
- 8) burns clean, with fewer pollutants than many other fuels.

There is a direct relationship between pressure and temperature. When pressure goes up, so does temperature; when pressure goes down, so does temperature. This is exactly what happens inside the cylinders of gasoline and diesel engines.

In gasoline engines a fuel-air mixture is let into the cylinder, the piston pushes up and compresses the mixture, the spark plug fires, there is an explosion, and the hot gases formed by the burning fuel expand and push the piston down. At the very bottom of the piston's travel, the cylinder space has its greatest volume. At the very top of the piston's travel, the cylinder space is as small as it can be. The ratio of the largest volume to the smallest volume is called the compression ratio. If the compression ratio is four to one, the fuel-air mixture will be compressed by a factor of four. Or, to look at it

another way, the exploding gases will expand four times their original volume.

Now, as the process of compression and firing repeats and continues, the cylinder walls heat up, and this increases the temperature of the incoming fuel-gas mixture. As this mixture is compressed by the piston, it becomes hotter than it would in a cold engine and may reach its ignition temperature before the piston has finished compressing it. Boom, the fuel-air mixture explodes too soon (predetonates). This is commonly called knock. It steals power from the engine because the piston must continue upward against the force of the explosion pushing it down. Obviously, the more the fuel-air mixture is compressed, the greater will be its tendency to predetonate, since greater compression will mean higher pressures and temperatures.

It would seem that what is wanted in an engine is a low compression ratio, right? Wrong. As was pointed out above, the compression ratio is also the expansion ratio, and the more the exploding hot gases are allowed to expand, the more they will fall in temperature. In essence, this means that the greater the expansion of these hot gases in the cylinder space, the more efficient the engine will be because it will convert more of that heat into the motion of the piston. The trade-off is between the knocking of predetonation and thermal (heat) efficiency.

Spark engine fuels such as gasoline are rated by their octane number. The octane rating of a fuel is a measure of how well it avoids predetonation. Methane has an octane number of 120 or more. This means that it can easily be used in high compression engines, because it rarely predetonates.

Biogas, which is methane mixed with carbon dioxide, has a lower octane rating than methane (but still over 100). Carbon dioxide also acts to decrease methane's ability to detonate when it is ignited, so not as much power is available from the methane in unscrubbed biogas as is from pure methane, given equal volumes of methane. The fact is that anything except oxygen mixed with methane will dilute it, because not as much methane can get into the cylinder, and clearly this will further reduce the power available from each power stroke in the cylinder. Removing the carbon dioxide will increase the power available.

The trace of hydrogen sulfide that is in biogas should only be removed if it is present in amounts (by volume) greater than 0.1 percent. But then there would be no way to smell gas leaks--because of all the gases in biogas, only hydrogen sulfide has any smell (rotten eggs). Hydrogen sulfide troubles can be partly overcome by replacing the standard engine valves with heat resistant valves and changing the thermostat in the cooling system so that the water circulates at 65 degrees centigrade (150° F) rather than 50 degrees centigrade (120° F). Sometimes even these precautions are not taken and the engine runs just fine.

Tests show that by using the best fuel-air ratios and averaging outputs, 100 percent methane outperforms a 50 percent methane/50 percent carbon dioxide mixture by approximately 86 percent in the same engine, all other conditions being equal. Looked at another way, diluted methane (biogas) has to provide 1.86 times the energy input to provide the same energy output that pure methane can.

Using a gasoline engine designed for research which had a variable compression ratio (4:1 to 16:1), it was found that output peaked at a compression ratio 15:1, a fuel-air ratio of 1:10 (10 percent methane to 90 percent air by volume), and with the timing set so that the engine fired 30 percent before top dead center.

Ordinary four-cycle, spark-ignition gasoline engines can be easily converted to run on biogas, but they tend not to have the high compression ratios which can be used with biogas. Very small engines such as motorcycle engines often require a fuel mix of gasoline and oil. These two-cycle spark-ignition engines are not very suitable for biogas, but they can be used. Lubrication may be a problem, because these engines get some of their piston lubrication from the oil in the fuel mixture, of which biogas has none. Operating a two-cycle engine as a dual fuel (biogas and oil) engine might

be an experiment worth trying, especially if the capacity of the biogas digester is too small to provide enough gas for a larger engine.

Another common engine type is the diesel. Diesel engines do not have spark plugs. What happens in a diesel engine is that air is compressed and when the piston reaches the right place in the cylinder space, the diesel fuel is squirted (injected) into the cylinder and the heat which has been developed by compressing the air ignites the fuel-air mixture, causing an explosion without need of a spark.

Diesel fuels do not have octane ratings; they have cetane ratings. The kind of measurement is different for diesel because the qualities needed for diesel fuel are very different than the qualities needed for gasoline fuel. In gasoline engines the fuel should not burn until it is lit with a spark. In diesel engines the injected fuel should burn as soon as it enters the cylinder. That is why cetane numbers are all about how easily the fuel ignites on its own in the cylinder.

Diesel engines are usually noisier than gasoline engines because the fuel burns with a faster and bigger bang. The compression ratios they use are higher than those for gasoline engines. Because of greater stresses, diesel engines are built better than gasoline engines and they generally last longer.

Diesel engines get better mileage per liter (or gallon) of fuel, but they are also more expensive.

Biogas is a great fuel for diesel engines. It has a low cetane number, so it works well when introduced into the cylinder with the air, compressed, and mixed with a little diesel fuel in order to cause an explosion (6-13 percent of the usual amount). A diesel engine run in this manner is referred to as a dual-fuel engine and the injected diesel fuel as the pilot oil.

The following is a summary list of ideas about running gasoline and diesel engines on biogas:

- 1) Pure methane will outperform unscrubbed biogas in the same engine, because with biogas not as much space in the cylinder can be devoted to methane; some space must be given to carbon dioxide which "steals" heat from the combustion reaction.
- 2) Higher compression ratios such as those used in diesel engines increase the power available when operated as dual-fuel engines with biogas.
- 3) The timing is often advanced in biogas powered gasoline engines.
- 4) The efficiency of an engine is affected by the load. A free running engine may not appear to use as much biogas as an engine which is driving a water pump or electrical generator, but per horsepower hour delivered, an engine without a load will actually use more biogas.
- 5) Use a high compression ratio. Some gasoline engines can be converted to a higher ratio using a special head. But remember that among other differences, a higher compression ratio will create greater engine stresses which could shorten engine life. Diesel engines already have higher compression ratios, but their effective compression can be increased with turbo-chargers. Talk to local auto parts dealers for more information.
- 6) In high compression engines, the spark plug gap may need to be set smaller. Fry ran a 13 brake horsepower, diesel-converted-to-spark engine with a spark plug gap of .008 inches/.20 mm, which had to be regapped every two weeks. (No one else has reported this change.)
- 7) If the biogas has a high but not extremely high percentage of hydrogen sulfide in it (between 0.05 and 0.10 percent), change the oil or check it for an acid pH often. Always change the oil when the pH turns acid and if it turns acid quickly and very often, think about hydrogen sulfide scrubbing.

8) Change the oil whenever it thickens by 30 percent. You can measure this by counting the number of drops coming out of a small hole in a can in a certain amount of time. Measure the drip rate of the oil when it is new, and measure the drip rate of the oil when used at the same temperature and for the same depth of oil above the drip hole. When the drops come out only 70 percent as fast as did a sample of the oil when it was new, it is time to change the oil. The crankcase can be modified by replacing the plug with a valve if this test is to be used often.

9) The best way to find out how to use biogas as an engine fuel is to run an engine on biogas and experiment. There is an automotive testing instrument called a dynamometer which can be used to help judge engine performance; it should be available from auto parts dealers (House, 1978).

L. John Fry used biogas to supplement diesel fuel in a three brake horsepower Petter engine driving a water pump and a three kw alternator which supplied electricity to his entire farm. At first the engine was started at four in the afternoon and shut down at bedtime so as to save fuel. However, the supply of no-cost gas meant such diesel fuels savings that eventually the engine was left on all night.

According to Mr. Fry, the conversion process for diesel engines is almost unbelievably simple. Biogas (methane plus carbon dioxide) flowed directly from the gas storage tank under pressure generated by the digestion process and kept constant by the weight of the gas storage tank at a pressure of four inches of water pressure. Two valves were placed along the gas pipe to the engine. The first valve was used for fine tuning of the gas flow and the second, in series with the first, was used for on-off. Just after the two valves, the pipe led straight into the air intake of the diesel engine.

The engine was started on diesel only and warmed up for a few minutes. Then after opening the on-off valve, the fine tuning valve was adjusted slowly. While adjusting the fine tuning valve, one could see the diesel pump governor returning to about the idling, no-load position. The engine was then running mainly on biogas. The normal black diesel exhaust smoke disappeared completely (white smoke replaced it if too much biogas was used); and the characteristic knocking of diesel engines vanished. The latter can be explained by the cushioning effect of the carbon dioxide content of the biogas (carbon dioxide has no fuel value). To stop the engine, the biogas on-off valve was closed and to start the engine again, only the on-off valve was opened after the engine had been started on diesel fuel. This three-brake horsepower diesel engine was run for two years on a mixture of biogas and diesel fuel.

When accurate measurements of diesel fuel consumption in a given time with and without biogas were made, the tests showed that on nearly full engine load the biogas supplied 87 percent of the energy and the diesel fuel supplied 13 percent. Any lesser quantity of diesel fuel would cause the diesel injector to dribble over a period of time and eventually stop operating properly. The injector supplied the "firing" of the engine and had to be maintained in good running order or the diesel and biogas mixture would not explode within the cylinder. When operating a diesel engine as a dual-fuel engine, approximately 20 percent of the power should come from diesel fuel in order to avoid injector trouble. As for gasoline engines, they should not be run on biogas unless the engine is designed to use fuel with an octane rating of approximately 100.

A 13-brake horsepower Crossley slow-speed diesel engine had very little corrosion due to the hydrogen sulfide in biogas. Engine wear was only very slight after six years of continuous operation using 170 cubic meters of biogas every (24 hour) day. The fact that combustion took place at high pressure and at a relatively high temperature could account for the hydrogen sulfide being burned along with the methane and remaining in the cylinder for so short a period of time as not to corrode the metal. However, the exhaust gas was comparatively hot at 535 degrees centigrade (1,000° F) and caused pitting of the exhaust valve which required maintenance a little more frequently than is normal with diesel engines.

This is how the 13-brake horsepower diesel engine was converted:

1) A magneto (generator) from a six cylinder bus was bought at a scrap yard. Five of the six cams were ground-off so that only one spark was given off per revolution. The magneto was linked to the engine crankshaft by a simple bicycle chain around a sprocket welded to the magneto and another to a pulley on the drive shaft. In six years of operation about eight bicycle chains were worn out.

2) The one spark plug could be screwed in either at the top of the combustion chamber opposite the piston or to one side. It was found that the side position ran best. The spark plug gap had to be set at 0.008 of an inch for the spark to leap under the high compression of 15:1. When the gap burned to 0.016 of an inch after about 15 days of continuous operation, the spark would not occur and the engine would stop. A routine was developed to reset the spark plug gap at two week intervals.

3) Biogas was piped in a one inch diameter plastic pipe through a gate valve to a "butterfly" valve taken from the base of a Ford carburetor. The gas then mixed with air at the air intake. The mixing of gas and air took place in bends of the manifold before the gas-air mixture entered the combustion chamber (cylinder) itself. The butterfly-operating lever was connected to the engine's speed-regulating governor.

Engine speed was 475 revolutions per minute (RPM). The engine was run with the conversion as above, but it was found to increase and decrease speed, to hunt, as it called. To prevent this, a shock absorber of the lever movement (Armstrong) type from a small English car was installed. It was bolted to a place on the engine and the lever to the governor control point. The engine then ran very smoothly and if a sudden extra load was imposed on it, the speed pick-up took a fraction of a second. Electric lights would dip for only a second.

The engine drove a five cm (two inch) shaft which ran the entire width of the engine room and right outside, through a hole in the wall, where a flywheel was mounted to keep the revolutions steady. From the shaft a combined alternator (six AC kw) and generator (six DC kw) was driven. The DC current was used to drive a water pump for irrigation 183 meters (200 yards) away. When the pump was in use, the AC load had to be reduced to prevent overloading the engine.

Belts could be shifted so that the shaft could drive a nearby water pump directly. A deep well pump was also kept permanently in action pumping water. The small pump used for circulating water through the engine and heating the biogas digester was also driven from a pulley attached to the engine shaft.

A 24 or 30 brake horsepower engine should be operated at 20 brake horsepower in order to increase engine endurance and lower maintenance costs. Operated in this way, the engine will need approximately 300 cubic meters of biogas per 24-hour day. A heated horizontal digester with a 175 to 200 cubic meter capacity should be big enough to always be able to supply the engine with enough biogas.

In most cases it is not practical to make a bottled gas out of biogas because the processing of compressing the gas would cost too much. For those situations where it might be practical, the book Practical Building of Methane Power Plants for Rural Energy Independence has some basic, introductory information on how to compress biogas.

The importance of the detailed description of the machinery run from the engine is that a schedule must be adhered to so as to spread the power available over a series of different kinds of work at different times of the day. In many situations, not all power demands can be met at one time. Although there are many advantages to the almost free power of biogas, it is usually impossible to draw on that power as from electric power lines in order to drive many motors at the same time. The size of the digester will effectively limit the amount of biogas available.

If biogas is used to run an engine, there are two things that can be done to increase biogas production from an average of one cubic meter to better than two cubic meters of biogas per cubic meter of digester space per day:

1) Build large: A horizontal, above ground digester, built and operated along the lines suggested in this book and with a digester capacity of at least 30 to 40 cubic meters, will be necessary. The larger the digester, the more efficient it is. Even small one and two horsepower engines can use 10 to 20 cubic meters of biogas every day. Depending on needs and costs, anywhere from a 20 cubic meter digester to a 60 cubic meter digester could be the smallest economically profitable size. It all depends on local needs, costs, and the efficiency of the biogas system.

2) Heat the digester: Much of the engine's energy output goes out the exhaust pipe or is removed by the radiator water (or air cooling system) as heat. Only some of the energy released by the explosions in the cylinders is used to move the pistons. If the heat from the engine's exhaust and cooling system is used to heat the slurry in the digester--keeping the slurry at a constant temperature of 35 degrees centigrade (96° F) all day and all night--the digester should be able to double the gas production rate.

According to L. John Fry, one of the most effective ways to heat a digester is to have an engine fueled by some or all of the biogas with a pump to circulate the radiator water through the digester. An engine has about the same efficiency as a hot water boiler (50 percent) in converting energy into heat. The useful energy from the engine (about 25 percent of the original) can be profitably used to generate electricity or power to an endless variety of machinery.

A limiting factor in digester heating is that the hot water circulating through pipes in the digester should not exceed 55 degrees centigrade (130° F), since above that temperature the slurry will cake to the pipes and prevent the transfer of heat. This problem can be solved by burying the pipes just below the surface of the digester floor so that the heat can radiate through the floor into the digester slurry. The rule is that one square foot (929 sq. cm.) of pipe outside surface is needed for every 100 cubic feet (2.8 cubic meters) of digester space. These are minimum requirements; more pipe can and should be added to ensure sufficient heat transfer. Fry believes that two separate sets of pipe should be installed and set firmly in the floor. Should one set fail for any reason, there would be no necessity to clean out the digester to make repairs.

The digesters on Fry's farm were heated in this way, but the pipes were not laid in the concrete floor. They were laid against the inside walls of the digester floor. As a result, the pipes became displaced, bent, and ripped when the digester was cleaned. Black plastic pipe was used at first but later switched to steel pipe which clogged up after a few years. Next Fry tried copper pipe which he does not recommend because of its high price. Finally, he used galvanized iron pipe, passing the water through a water softener to prevent clogging the pipes and engine cooling system with mineral deposits.

There have been reports that burying the hot water pipes in the digester floor is not a very effective way to heat the slurry. When the heating pipes are laid on the digester floor, not in it, the digester gets the heat it needs, and the risk of the slurry caking on the pipes is minimal. If the pipes are buried in the digester floor, they should definitely be placed just below the surface. If the pipes are laid on the floor, they should be fastened to the floor so that they cannot move. One builder of biogas systems recommends using one inch diameter pipes raised a few inches above the floor of the digester.

Fry built the engine room next to the digester. The heat from the radiator water and the exhaust gas was used to maintain the digester temperature at the ideal of 35 degrees centigrade (96° F). The engine's exhaust gas was discharged against an outside wall of the digester. Rocks were packed against this wall and then covered with dirt. A thin layer of cement plastering was then used to cover the dirt and keep the heat in.

The engine design called for a maximum cooling water temperature of 60 degrees centigrade (140°

F). This is also the maximum temperature pipes can be used in a digester. If a higher temperature is used, the slurry will cake on the pipes and prevent the transfer of heat.

A small 3/4-inch pump was installed and driven directly by the engine. It was run at slow speed (so that it would last longer) to circulate water between the hot engine and the cool digester. In the circuit was a 760 liter (200 gallon) insulated water tank that was used to keep the lines full at all times. The tank was also used as a means of cooling the water in order to prevent the digester temperature from rising above 35 degrees centigrade (96° F). (This water tank was not designed as a heat exchanger, but many engine/digester water systems do use heat exchangers.)

A thermostat controlled bypass valve is a device that automatically controls temperature; such a device must be attached to the water cooling system to control the temperature of the water which is heating the digester. L. John Fry operated this engine and digester combination day and night for six years, except for rare stoppages for cleaning and repairs.

Simple solar heat collectors that cost less than US\$ 100 (VITA design) can be adapted to work with engines as a second source of hot water. In biogas systems that do not have engines, solar collectors can be used as the only source of hot water for heating the slurry. Digesters can also be heated in climates with cold winters or long rainy seasons by building greenhouses around them. There is more information on solar collectors and greenhouses in the New Ideas section of the Appendix.

Heating the slurry before it goes into the digester will make it easier to maintain an even digester temperature. If the temperature increases to 40 degrees centigrade (104° F), the biogas production rate will begin to swing wildly, sometimes up, sometimes down. If the digester temperature does get too high or too low, bring it back to 35 degrees centigrade very slowly, at the rate of one degree centigrade per day. Any fast temperature change can easily kill biogas bacteria.

The Chinese have had a lot of experience with biogas fueled diesel engines. The primary purpose of the Chinese engines is to run irrigation pumps. This section, edited and adapted from VITA's biogas literature files, is an account of some of that experience.

Dual-fuel means that internal combustion engines can use diesel fuel oil and another fuel, in this case of biogas and diesel oil. In practice biogas is the main fuel. Only a small amount of diesel oil is needed to ignite the compressed mixture of biogas and air. In case the supply of biogas is not sufficient to meet energy needs, the engine can be transferred quickly back to 100 percent diesel oil by an extremely simple method without the engine's performance being affected. (Switch back to diesel fuel before all of the biogas is used. It is dangerous to totally empty a biogas system because air could get into the digester and cause an explosion or kill the biogas bacteria.)

When diesel engines are used as dual-fuel engines, some fear that the engine might run rough because of the high compression ratios. But many experiments and much experience has shown that biogas has a good anti-detonation combustion property. Combustion detonation caused by pre-ignition has never happened. The engine may run smoother if the compression ratio is lowered, but then its power rating will also be lower. It is best not to change original compression ratios.

Biogas will burn readily when mixed with a proper quantity of air (5.0 to 15 percent biogas). The temperature of spontaneous combustion of the mixture of biogas and air is 814 degrees centigrade and the temperature at the end of the compression stroke is usually not over 700 degrees centigrade, which itself is higher than the spontaneous ignition temperature of diesel fuel. So the advanced injection of a little diesel fuel just before the end of the compression stroke is used to ignite the biogas and to assure the normal running of dual-fuel engines.

To insure the smooth running of the engines when they are switched back to just diesel fuel and to maintain engine performance, the advanced injection angle should not be changed. As the biogas

supply temporarily falling short of demand is a common occurrence in rural areas due to maintenance and so on, it is very important to maintain the engine's ability to run on just diesel fuel oil.

The way to convert the intake system of a dual-fuel diesel engine is to install an extra mixing device at the rear of the air filter. This mixer consists of a valve controlling the quantity of biogas and a three-way pipe. Its principle is shown below in Diagram 16.

Two kinds of mixers, direct intake and cross pipe, are used with the single cylinder water-cooled diesel engines which are used in the rural areas of China. The direct intake mixer consists of cast three-way pipe (welded parts can be used), rear and front intake pipes with biogas valves. There are flanges at both ends of the three-way pipe connecting the intake pipe and air filter, respectively.

DIAGRAM 16

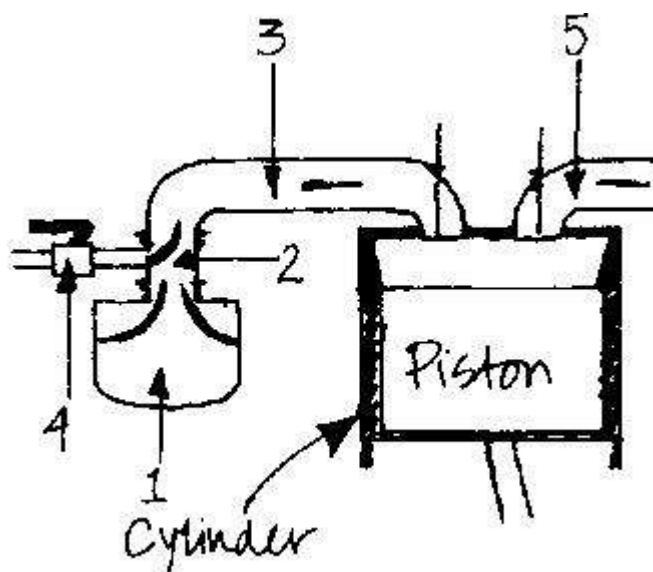

DIESEL ENGINE ADAPTED FOR BIOGAS

1. Air-filter
2. Mixed gas
3. Intake pipe
4. Bio-gas choke (3/4 inch ball valve)
5. Exhaust pipe

The cross pipe mixer is basically the same as the direct intake mixers. The principal difference between them is that there are several small holes drilled in the cross pipe, from which biogas flows and mixes with the air.

The starting procedure for a dual-fuel engine is the same as with an unconverted engine.

- 1) First, make sure the biogas choke is closed; then start the engine with just diesel fuel.
- 2) After starting, move the diesel throttle to the suitable position when the engine is under a load.
- 3) After normal running has begun, open the biogas choke slowly to let in the gas; by so doing the

diesel fuel supply will automatically reduce under the action of the speed governor, and the engine will continue to run steadily.

4) If the engine takes in too much biogas, the diesel fuel may be cut off and an intermittent noise will be heard from the engine. If this happens, close the biogas choke a little until the engine runs normally.

Adjusting engine speed is done the same way as with unconverted engines that only use diesel fuel. That is, adjust the throttle handle only. In response to varying engine speeds or loads, the biogas choke should be slowly opened or closed to ensure smooth running and better fuel consumption rates. If the cooling water temperature is lower than it should be and the engine is under a light load or just idling, the efficiency of the fuel savings will be reduced. To stop the engine, close the biogas choke first; then shut the throttle.

Frequently check the biogas choke, pipes, and flanges for gas leaks to reduce the chance of fire. Operate the biogas choke gently; do not open it wide or close it suddenly. In order to avoid the frequent adjusting of the biogas choke that interferes with normal running and lowers the efficiency of fuel savings, the engine speed must be kept as steady as possible. In case there is not enough biogas or for other reasons the diesel fuel has to be used alone, close the biogas choke and the engine will operate again as a diesel engine.

Possible Problems and Their Remedies

Problem: Insufficient speed after starting, the engine cannot take on load, emits white or black smoke from the exhaust pipe and sometimes stalls.

- Cause: Overload of the engine or intake of biogas began too soon.
- Remedy: First let the engine idle for a while; then put on a load only after the engine is running normally. If it is necessary to start under load, diesel fuel should be used until the engine is running normally; then a gradual switch to biogas can be made.

Problem: Insufficient engine speed after starting and failure to take on load.

- Cause: Improper positioning of the governor control (throttle) handle.
- Remedy: Start with diesel fuel in the same way as with a purely diesel engine and then put on the load. Next, place the throttle handle at the proper position according to load and keep it in position; then introduce the biogas gradually.

Problem: After the engine has switched to biogas, its speed decreases or even stalls.

- Cause: The introduction of biogas has been too much, too soon.
- Remedy: Open the biogas choke slowly and let the biogas percentage of the fuel increase slowly. If an intermittent noise or knocking is heard, close the choke a little until the sound stops.

Problem: Occasional noise and knocking occurs when the engine is running.

- Cause: When the load is reduced during running, the engine takes in too much biogas.
- Remedy: When this happens, gently close the biogas choke some or increase the load until the sounds disappear.

When there is enough biogas, the load level is steady, and the engine is operating properly, the efficiency of diesel fuel savings in dual-fuel engines is from 75 to 95 percent. The main factors which affect the efficiency of fuel savings are:

- 1) a sufficient supply of biogas,
- 2) a skilled operator, and
- 3) maintaining a steady load on the engine with few changes or stops.

Biogas can be used in dual-fuel diesel engines for extended working periods without any early engine wear-out or serious corrosion. The only problem that might develop is fine cracks around the cylinder combustion chamber due to the local overheating on multicylinder engines which are equipped with swirl combustion chambers or pre-ignition chambers.

Biogas can be used for lighting in rural areas. But biogas lamps have a high gas consumption rate, therefore, from the point of view of better energy utilization, it is more economical and convenient to use biogas to generate electricity for lighting. In such a way, one cubic meter of biogas can light twenty-five 60-watt lamps for one hour, while one cubic meter of biogas can only light seven gas mantle lamps for one hour.

In rural areas it is very practical to include small internal combustion engines and asynchronous generators in biogas systems. There are many advantages, such as: simple structure, safe, easy to operate and maintain, few problems, and low installation cost. In China, asynchronous electric generator units of 3.0, 5.5, and 7.5 kilowatts have been put into mass production especially for use with biogas fueled engines.

While L. John Fry never had serious problems caused by the hydrogen sulfide in biogas, other people--especially in hot, damp tropical climates--have had problems. Engines run on biogas have been damaged by corrosion caused by hydrogen sulfide.

A simple and effective solution to this problem is in use in the Philippines. Just before the biogas goes into the engine, it is passed through a sealed box of rusty nails. The rust absorbs the hydrogen sulfide, and the engine escapes unharmed.

Another method of removing the hydrogen sulfide would be to have the pipe diameter doubled from a meter (3.0 feet) just before the engine. Inside the enlarged pipe loosely packed balls of rusty iron wire would absorb the hydrogen sulfide. The pipe size would have to be enlarged to keep the "all important" gas pressure from dropping. If the box method is used, loosely packed rusty wire--if it is available--would allow more hydrogen sulfide to come in contact with more rust and be absorbed.

Whatever method is used, the rusty iron would have to be changed on a regular basis when its ability to absorb hydrogen sulfide was used up.

In his book, Practical Building of Methane Power Plants for Rural Energy Independence, L. John Fry makes the following suggestions. "As an alternative to the expense and technology required to scrub the gas of carbon dioxide, hydrogen sulfide and moisture, the gas could be burnt to create steam to drive a steam engine (see the information on rankine-cycle engines in the New Ideas section of the Appendix)...Efficiency would be high and waste heat could be returned to the digester....The traces of hydrogen sulfide can also be filtered out by a sponge of saw dust mixed with ferrous oxide or iron filings from a machine shop [they should be rusty, not oily]...when the filter is saturated with hydrogen sulfide care must be taken when opening the lid since this gas is explosive and iron sulfides are known to heat even to the point of burning when concentrated and then exposed to oxygen in the air."

Chapter eight: The factory's products: Biofertilizer

With all the talk about digesters as biogas producers, it is easy to forget that digesters produce two main products. The second product is organic fertilizer, in other words, biofertilizer.

Some background on fertilizers and plant growth is in order here. Of necessity, it will be brief, but this is a subject of great importance to anyone trying for greater self-reliance, and it is financially important to anyone concerned with making a biogas system profitable.

Fertilizer is perhaps the single most important factor in agricultural plant growth. One-fourth of the world's food supply is the result of the use of chemical fertilizers, but chemicals have no bulk, no fibers; they cannot hold the soil. In the American state of Illinois, approximately 3.9 tons of topsoil per acre of land are eroded away each year. One of the main reasons for this is farming methods that use only chemical fertilizers. The value of organic fertilizers (compost and digester sludge) is not only in the nutritional value of its chemicals (such as nitrogen), but also in the anti-erosion qualities of its humus (plant fibers).

Estimates show that organic wastes from animals, plants, and people could supply developing nations with six to eight times more plant nutrients than they now get from manufactured chemical fertilizers. Crops grown in soils fertilized with organic matter tend to be larger, healthier, less troubled by insects and plant diseases, and the soil suffers less from compaction or erosion.

In India, where there is more than 20 years of experience with wide-scale use of biogas systems, more than twice as much value is placed on the fertilizer than is placed on the gas.

This first section is based in large part on the introduction to biofertilizer in The Compleat Biogas Handbook.

The modern method of agriculture usually compares fertilizers by using their chemical analysis, particularly their relative amounts of the nutrient elements: N. P. and K (N-nitrogen, P-phosphorus, and K-potassium). This is because of the large quantities of these three nutrients (that which causes growth and development) in plants, in comparison to the quantities of other elements in plants. Also present in plants in large quantities are carbon, hydrogen, and oxygen; but these elements are easily gained by plants from air and water. Often chemical fertilizers are spoken of as "5-2-2" or "10-5-2." These numbers refer to the percentages of N. P. and K in the fertilizer.

In chemical terms, the dried solid sludge from digesters is a poor fertilizer. But when used in the large volumes that digesters produce sludge in, the whole sludge, liquid plus solid, is a good to excellent fertilizer in terms of its chemical analysis. The difference lies in the fact that most of the fertilizer value is in the liquid portion of the sludge and is in the form of ammonia-nitrogen (and related compounds), which will rapidly evaporate or wash away when the solid portion is dried. The local use of liquid sludge (with or without the solid portion) should not be too much of a problem if the sludge is used in fish ponds and in nearby irrigation systems. Large biogas businesses might think about buying old water or (cleaned-out) gasoline tank trucks to distribute and sell the liquid fertilizer.

It has been proven many times that the nitrogen in the waste that goes into a digester remains in the sludge that comes out to a greater degree than it does with composted waste. In NPK terms, the biogas process produces a better fertilizer than the compost process does. Basicly, the whole NPK value of the original plant and animal waste remains and is usable by the growing crops. One study claimed that biogas sludge has three times more nitrogen than the fertilizer produced by the best compost process.

When using many organic wastes, especially manure, aerobic composting will result in a 25 percent

loss of nitrogen as compared with anaerobic digestion. Aerobic compost will have more of its nitrogen tied up in a slow release form that is not as easily released as the ammonia-nitrogen of anaerobic sludge. For use on pastures, grasses, and crops such as rice, corn, and other grains, the ammonia-nitrogen of biogas sludge is best. For use on tree crops (fruits and nuts), legumes, and most vegetables, the slow release nitrogen of compost is best.

Operating large aerobic compost systems can be as time consuming as operating large biogas systems. The equipment needed for biogas systems will be more expensive than the equipment needed for making aerobic compost, but then composting does not produce methane. And even a well-run composting operation cannot kill as many disease-causing organisms as the anaerobic process can in a well-run, continuous-fed horizontal biogas digester.

Some soils respond better to liquid sludge than others. Open, porous soils (sandy or loamy) will in general be more capable of remaining loose and tillable than silt or clay soil when digester sludge is used as a fertilizer.

The nutrients in biogas sludge encourage the growth of soil bacteria, an event which can have many benefits for the soil structure and humus content. But if too much sludge is used too often, the soil will become clogged with the products of this growth, and slime organisms will begin to grow.

Percolation, the ability of water to move through the soil, is then dangerously reduced, and the carbon dioxide released by aerobic decay in the soil cannot leave the soil, causing the soil to become acidic, which is usually not very good for the plants. A close check on the soil pH will provide evidence that this is happening.

The use of liquid sludge could probably be increased if the soil is first tilled (harrowed or plowed), with the sludge applied a few days later. Compact clay soils respond to sludge by clogging more rapidly than sandy, open soils, so plowing before using the sludge can be very important. The use of an agricultural lime or dolomite before the sludge is applied will, to some degree, lessen the acidifying tendency of biogas sludge. The real cure is to keep the soil open, so that carbon dioxide can escape, and oxygen can enter.

Both digester sludge and compost have something that agricultural lands need and which chemical fertilizer do not have. That thing is humus. Humus is rich organic matter which, in addition to having value as a fertilizer, helps hold soil together, reducing the damage that can be caused by wind and rain.

Key elements in the following section were adapted from the book, Biogas and Waste Recycling--The Philippine Experience.

From a farmer's point of view, it might be better to call them biofertilizer digesters instead of biogas digester. The second product of digesters is a sludge which is a very watery liquid with usually only eight to ten percent solids floating in it. It has the appearance of a dark, but thin, mud (if it has been in the digester long enough), but on closer look, small plant fibers and bits of organic matter can be seen floating in it or settling to the bottom.

When newly discharged from the digester, it still lets off some biogas. The original offensive odor of manure is replaced by an entirely different smell, that of hydrogen sulfide which disappears as the sludge is exposed to the air. The volume of the sludge is large, because there is very little volume decrease brought about by the biogas digestion process.

The ten percent of the sludge which is solid has a known fertilizer value for crops. A rather unexpected benefit comes when the dried sludge is used after sterilization, as a food component for pigs. Not only does the sludge satisfactorily perform as feed, it also definitely hastened weight

increase. While some of the favorable effect on pig growth can be attributed to the presence of amino acids and trace elements in the sludge, it is more probable that the large effect on pig growth by so small an amount, just ten percent of the feed, is due to vitamins, B-12 in particular, and what is called unidentified growth factors. More information on the use of solid sludge as a feed supplement can be found in the book, Biogas and Waste Recycling--The Philippine Experience. (Dried solid sludge has also been found to make a very sanitary bedding for animals kept in pens.)

The liquid sludge is about 90 percent of the total sludge. This large volume can be a big disposal problem. Of the ten percent solid sludge, it can be said that the problem has been satisfactorily solved through its utilization as a livestock feed ingredient or as a fertilizer and soil conditioner (humus). The solid sludge is small in quantity, and can be dried in the sun and stored, used immediately, or sold. By contrast, the 90 percent liquid sludge is very large in quantity. Sludge collected in ponds showed no indication or tendency for ill effect on plants due to salinity (salts). But, since the sludge is the end product of an anaerobic process, it takes weeks to get atmospheric oxygen to dissolve in the liquid. The big problem is the practical use of such a big volume of liquid. There are several good possibilities.

The liquid sludge, with or without the solid portion, can be used as a combination irrigation water and fertilizer. Using the liquid sludge in this way has been very successful. Blue-green algae grow in great abundance in rice fields irrigated with biogas sludge, and the algae increase the fertilizer value of the sludge by taking nitrogen from the air and making it available to the crops (nitrogen is 78 percent of the air). It is also likely that the sludge contains plant hormones and other plant growth factors, because the dark green leaves and general robust appearance of sludge fertilized plants cannot be explained by the chemical composition of the sludge, which is low in nitrogen.

The liquid sludge can be valuable in aqua-culture fish ponds. When the sludge is exposed to the brilliant tropical sunlight, it supports a profuse growth of plankton (miniature water plants and animals). Fish, particularly tilapia (silver carp), feed on plankton. The rice fields at Maya Farms are now being replaced by tilapia ponds.

Fresh Air + Sludge = Fertilizer

Literature on biogas is generally silent about the toxic effect of biogas digester sludge. The sludge is hailed as an excellent fertilizer. That all is not well, however, is hinted at in the statement that the sludge must be allowed to ripen before it is used as a fertilizer. Indeed, the freshly discharged sludge is very toxic to fish and plants, even when greatly diluted with water. Tilapia, a fish noted for its ability to survive in very hostile environments, dies in fresh sludge. A hardy water-loving plant, kang-kong, fails to develop, and even grass withers when watered with fresh sludge.

The cause of this toxicity could be the lack of oxygen in fresh sludge, the osmotic effect of high salt levels in sludge, or the presence of toxic substances. Recent work on rice cropping in India and at the International Rice Research Institute in the Philippines points to hydrogen sulfide as a material which is toxic to rice. If the cause of toxicity of the sludge is hydrogen sulfide, then detoxification can be achieved by oxidizing the hydrogen sulfide. In other words: expose the sludge to air for 15 to 30 days before using it.

Well-aerated sludge is free from the sulfide odor and is no longer toxic to fish or plants. Even before it dries, aerated solid sludge attracts ants, insects, chickens, etc., a sure sign of detoxification. It is also a sign that the sludge may have feed value. When dissolved in water, hydrogen sulfide is, within weeks, broken down by the oxygen in water--hence the need to create conditions for effective aeration (exposure to air), such as bubbling air through the sludge and/or exposure of large surface areas of sludge to air.

A sludge aging pond is usually a biogas system necessity; algae and fish ponds are also included if

they serve the purposes of a biogas system's design. If all the ponds are down hill from the digester, gravity will carry the sludge from pond to pond, and pumps or water wheels will not be needed to lift the sludge from pond to pond.

The first pond, the aging pond, can be used to reclaim some or all of the liquid portion of the sludge for mixing with fresh waste to make new slurry. This could be done with filters made of straw, gravel, or screens. Another way to separate the solid from the liquid sludge is to rake out the solids and drain off the liquid portion. The solids can then be aired for use in gardens and fields, used in compost piles, or sold in bags.

The purpose of the first pond must be to make sure that all of the sludge gets enough exposure to enough air. The ponds should have thin concrete or plastic bottoms and sides to keep the valuable fertilizer from being soaked up by the ground.

The first ponds should only be a few inches deep so that there is a large surface area exposed to the air and the pond must be divided into sections like those in the aging pond in Diagram 1. The dividers will make sure that all of the sludge spends enough time in the pond. The total volume of the aging pond (not counting the space taken up by the dividers) should be at least three-fourths the volume of the digester that the sludge came from, so that all of the sludge will be in the pond for approximately 30 days. For example, a six cubic meter digester will need a 4.5 cubic meter aging pond with approximate dimensions of 3.0 meters by 5.0 meters by 0.3 meters. The final dimensions cannot be figured until the space taken up by the dividers is known.

After going through the aging pond, the sludge, with or without the solid portion, should flow into algae and fish ponds, or it can go into an irrigation system to fertilize crops. Palm-leaf roofs to protect the sludge ponds from being diluted or flooded by rain, greenhouses to use the sludge during cold weather, and storage ponds to save the sludge during times of the year when there is not a large demand for fertilizer are just three of the many solutions that have been thought of to answer the many questions that come up when working with liquid fertilizer.

Algae ponds can be very useful. Algae release oxygen that mixes with the sludge, making it less toxic to fish and other plants. The water of algae ponds has been found to be a good high protein drinking water for all kinds of farm animals. In several cases the algae is harvested with rakes, dried, and feed to chickens. At Maya Farms, ducks get up to 50 percent of their food from the sludge of algae ponds, though at first Maya Farms had to add other feeds to the ponds to get the ducks interested in eating the digester sludge and algae.

Growing plants need certain nutritional elements. Carbon, hydrogen, and oxygen are obtained by plants from the air and water. The other essential elements are supplied through the soil. The elements in the soil may be greatly reduced after severe cropping and through leaching, that is, the elements may be washed away by water seeping through the soil. Unless these nutrients are replaced, future crops may give increasingly poorer yields. Nature's way of keeping the soil fertile is by recycling the organic waste of old plants by returning all organic matter back to the soil.

Biofertilizers and Chemical Fertilizers

Continuous use of chemical fertilizers, which are in part made from increasingly expensive oil, can deplete the soil of many nutritional elements. The Guidebook on Biogas Development states that chemical fertilizers are effective in the soil for one year while biogas fertilizers are effective for three years. While half of the nitrogen in digester sludge is in the form of fast-acting ammonia-nitrogen, the sludge in general is a slow release fertilizer which will continue to fertilize the soil for three years.

Another disadvantage in using chemical fertilizers is the water pollution that can occur when excess chemicals find their way into rivers and streams. But farmers have persisted in the exclusive use of

chemical fertilizers in spite of the warnings that complete abandonment of organic fertilizers would cause the soil to become less fertile and in spite of the pollution caused by chemical fertilizers and unused plant and animal wastes. The disadvantages have been overshadowed by the easy-to-use nature of chemical fertilizers and the immediate but short-term increase of crop yields. Over the years increasing quantities of chemical fertilizers have to be used to maintain high crop yields.

The natural fertilizers such as compost have not been totally abandoned. New ways are being developed to shorten composting time and to improve the quality of compost. These developments, together with the increasing prices, unreliable supply, and pollution problems of chemical fertilizers have started a return to traditional organic fertilizers (see Compost section of the Appendix).

The biogas process is an improved treatment for plant waste and animal manure. In aerobic decomposition of organic matter, ammonia and carbon dioxide are lost to the air. There is also considerable leaching of plant nutrients that can dissolve in water. The resulting compost has less food value for crops than was in the original organic material. In the biogas process, the organic material is decomposed in waterproof, airtight tanks. Only the elements carbon, hydrogen, and oxygen in the form of methane and carbon dioxide molecules are lost. Almost all the other essential elements are retained in the sludge.

The nutrient value of biofertilizers vary with the type of organic waste used to make them. When only animal manure is used, the phosphorus content is usually less than the nitrogen and potassium. Depending on the soil analysis and the crop to be grown, it may be necessary to supplement the biofertilizer, be it biogas sludge or compost with small quantities of chemical fertilizers to meet the requirements of normal plant growth.

Solid Biogas Fertilizer

Solid biogas sludge is composed mainly of humus (organic matter) and plant nutrients. It has a carbon to nitrogen ratio of approximately 13 to 1, which is good, because of its closeness to the C/N ratio that is found in land which is good for farming. This means that the sludge can be used directly (after aging) as fertilizer. The sludge will not compete with crops and decay organisms in the soil for the available nitrogen.

As an organic fertilizer, solid sludge plays an important role in plant nutrition and soil conservation.

- 1) It improves the physical condition of the soil by improving texture, moisture holding capacity, and aeration.
- 2) It increases the pH buffering capacity of the soil.
- 3) It combines with inorganic soil compounds to prevent their loss by leaching and releases them for use by the plants.
- 4) It stimulates the growth of micro-organisms, retards the irreversible fixation of nutrients, and helps prevent soil erosion.

Liquid Biogas Fertilizer

The liquid sludge contains less concentrated quantities of nitrogen, phosphorus, and potassium than solid sludge does, but considering the fact that a large amount of water is needed for irrigation and the large quantities of liquid sludge, these nutrients can build up to become too much of a good thing. Liquid sludge promotes the growth of large quantities of nitrogen-fixing algae wherever it applied. Since algae have a short life cycle, the decaying algae increase the nitrogen content of the sludge--a good thing only if it is controlled.

In addition to the major plant nutrients: nitrogen, phosphorus, and potassium (NPK), biogas sludge also contains fertilizer elements such as calcium, sulfur, magnesium, and the essential trace elements copper, zinc, manganese, and others.

When the liquid sludge was used at Maya Farms as irrigation water for flooded rice (IR-26), the available phosphorus content of the irrigated soil increased by 80 to 500 ppm (parts per million), while available potassium increased by as much as 300 ppm. In addition to phosphorus and potassium, a sufficient nitrogen supply was apparent from the appearance of the crop.

The effect on plants caused by the continuous use of biogas sludge should be continuously watched. Use of the sludge should be regulated in order not to subject the soil to excessive amounts of nutrient elements. Without regulated use, unbalanced proportions of nutrients may result in abnormal plant growth or yield. For example, an excessive amount of phosphorus represses the availability of trace elements like iron and zinc, which are essential to plant growth. Unregulated use of the liquid sludge for irrigation also has the tendency of making the pH level of the soil slightly alkaline, although alternate flooding and draining tends to bring the pH somewhat lower.

One study found that an uncontrolled supply of nutrients, especially nitrogen, may depress crop yields. When biogas sludge runs directly into rice fields, there is a large increase in the growth of blue-green algae. These algae absorb nitrogen from the air, which is good for the crop. But there can be too much of a good thing.

If the supply of sludge is not stopped halfway through the growth cycle of the rice, flower initiation is harmed. The rice plants continue to grow, but the rice grains do not develop.

In the Philippines and other countries with hot, humid climates, the decomposition and reuse of organic matter in the soil is much faster than in colder countries. In the tropics the soil is generally low in organic matter content. The soil can easily lose the plant nutrients which are the fertility of the soil. The surface soil also becomes easily eroded when there is a lack of organic matter. The use of the organic fertilizers, biogas sludge and compost, is very important, particularly in tropical countries.

Experiments are being conducted to find out if the biogas process can make the sludge completely free from parasites and pathogens (disease causing organisms). Preliminary results are encouraging, but more work is necessary to establish a definite conclusion. A lot depends on how long the waste stays in the digester: the detention time. If the digester is fed too much slurry too often, the amount of time any one portion of organic (and disease carrying) waste stays in the digester will be shortened. Overloading can change a safe 40 day detention time into an unsafe 20 day detention time very easily.

How to Use Biofertilizer in Fields

1) Fresh sludge from digesters contain compounds such as hydrogen sulfide which can kill plants and fish. Symptoms of this have been observed at Maya Farms when fresh sludge went directly to the rice fields. Aging and aeration of the sludge in a shallow pond for 15 to 30 days brings down the concentration of these toxic compounds and brings up the concentration of oxygen.

2) Continuous use of biofertilizer may result in too much growth of nitrogen fixing algae. The excessive nitrogen may cause weak roots and stems. This is particularly dangerous at the heading stage of rice.

3) Continuous application of sludge in clay soils may cause problems around the root areas of the crops.

4) Too much sludge in fish ponds can cause too much algae growth. Since algae has a short life cycle, the decaying algae, if not raked out and used as food for animals or biogas digesters, can use up all the oxygen supply in water and cause fish to die.

5) Continuous use of sludge on fields can make the soil acidic or alkaline, depending on the pH of the organic waste used in the digester and the original pH of the soil. If the soil becomes too acidic, a little limestone can be added to the sludge, but only if and when needed.

6) Sludge should be plowed into the soil about one week before sowing seeds for best results with non-irrigation crops. Grain crops can be fertilized once or twice more before harvesting. Vegetable crops should not be fertilized again.

How to Use Biofertilizer in Fish Ponds

The basic source of food for pond fish is plankton: the large number of very small plants and animals found near the surface of bodies of water. The plant population of plankton consists mainly of algae. The animal population of plankton consists of many kinds of one cell organisms, miniature shell fish, and the larvae form of larger animals.

Poultry and livestock manure can be used directly in fish ponds to grow plankton but the odor of the manure has a tendency to have a bad effect on the taste of the fish. This is particularly true in the case of Bangus (milk fish/Chanos chanos).

A better way to fertilize a fish pond is to use the manure in a biogas digester. Then use the digester sludge to fertilize the fish pond--after the sludge has been aged. There are several advantages to this method.

- 1) The sludge does not smell bad and will not give fish a bad taste.
- 2) The sludge promotes the growth of plankton better than manure does.
- 3) Fish need oxygen, and aged sludge leaves more oxygen in the water than manure does.
- 4) When the biofertilizer is made, biogas is also made.
- 5) Fish ponds are probably the easiest year-round use for biogas sludge.
- 6) Only a relatively small amount of sludge is needed to fertilize a fish pond.

Maya Farms raises Tilapia, a hardy fish which thrives in fresh and brackish water conditions. Tilapia feed primarily on plankton but also eat other organic matter. With nothing but plankton and pig feed sweepings as fish food, the fish ponds yield about two tons of Tilapia per hectare every three months.

The culture of Tilapia can be a very profitable operation. Once started, the maintenance costs are minimal. The sludge from a biogas digester is enough to support the growth of plankton in fish ponds and the undigested solids in the sludge can serve as direct feed supplement for the fish. There is no problem with the cost or supply of fingerlings because Tilapia reproduce very fast. They reach sexual maturity in about three months and breed as often as once a month. In fact, there is need to control the Tilapia population in fish ponds, otherwise overcrowding will cause stunted growth and poor harvests of large fish.

Overcrowding can be controlled by maintaining separate male and female ponds for breeding, and stocking the other ponds with only manually selected male fingerlings. The male Tilapia can be

identified by examining the "urogenital papillae," a finger-like structure behind the anus on the belly of the fish. The male has one opening at the tip of the papilla while the female has two openings, one for the exit of eggs and the other for urine. Another difference is that the papilla of the male is pointed while the papilla of the female is somewhat brown and round.

For raising Tilapia on plankton, the best depth for the fish pond is 75-100 cm (30-40 inches). The recommended stocking rate is about one to two fish per square meter of water surface. The formula for figuring surface area is length times height.

1) A 29 cubic meter biogas system in the Philippines for 50 cows included a 52 square meter sludge aging pond and a 80 square meter fish pond from which 20 kilograms of Tilapia were harvested every two months.

2) Compared to the traditional method of fertilizing the fish pond, digester sludge can increase the size of the fish harvest by 25 percent in two-third the usual time.

A biogas system on a farm in Thailand uses sludge to fertilize gardens and fish ponds. After two or three harvests, it switches the gardens to fish ponds and the fish ponds to gardens. After another two or three harvests, it switches the fish ponds back to gardens and the gardens back to fish ponds. The purpose of this continuous switching of land back and forth between use as fish ponds and gardens is to benefit more completely from the fertilizer value of biogas sludge.

Well-operated fish ponds, as part of biogas systems or as separate businesses, can be very profitable. VITA and the Peace Corps has an excellent (long) book, Freshwater Fish Pond Culture and Management, that studies the subject of fish ponds in great detail.

Sales of inorganic fertilizers, especially nitrogen, have increased in recent years resulting in a depletion of humus in the soil and therefore still heavier applications of inorganic fertilizers leading to unavoidable ecological imbalance. This lack of humus is causing serious problems and concern.

The availability of a natural fertilizer, such as biogas sludge, offers the farming world a means to return to the classic use of organic fertilizer (compost) in a new form. The choice is made more attractive by the continuing price increases of inorganic fertilizers. The average international price of ammonia (nitrogen) fertilizer increased nine times between 1972 and the end of 1974 (Barnette, et al., 1978).

The conclusion of almost all of the literature on pathogens (disease-causing agents) in the sludge from sewage biogas systems is that the pathogens are destroyed. If pathogenic bacteria do find their way through a digester, it is because of faulty design of the digester itself or from putting too much waste in the digester for its size (Fry, 1974).

An Important Question

There is an important question which every owner of a biogas system must answer. Should human waste--feces and urine--be used as fuel for digesters? And if human waste is used, should the sludge be used as a biofertilizer?

These are not all-or-nothing questions. Most of the sludge, the liquid portion, could be used instead of water to dilute the fresh waste. This would not only provide a use for the liquid sludge, it would also increase biogas production by 10 to 20 percent (a guess). Another possibility is to have digesters: one for human waste and one for all other organic waste. The human waste digester would be used for gas production only, with the sludge going directly into a septic tank (see Diagram 17).

Human waste can be safely used in biogas and biofertilizer production:

- If the waste is calculated to stay in the digester long enough for the sludge to become sanitary (see Facts and Figures section of Appendix for details).
- If a sanitary way can be found to collect the human waste, find its approximate weight, mix it into a slurry without lumps, when at all possible, and get it into the digester with the diluting liquid (water or liquid sludge) in a way that is not more trouble than it is worth.
- If no soap of any kind gets into the digester, because the chemicals in all soaps can kill biogas producing bacteria.

There are a few points to remember when considering building a combination digester and septic tank. The digester will most likely be underground, unless all the toilets are on the second floor, so the water table must be low enough at all times of the year to not be a danger to the digester.

DIAGRAM 17

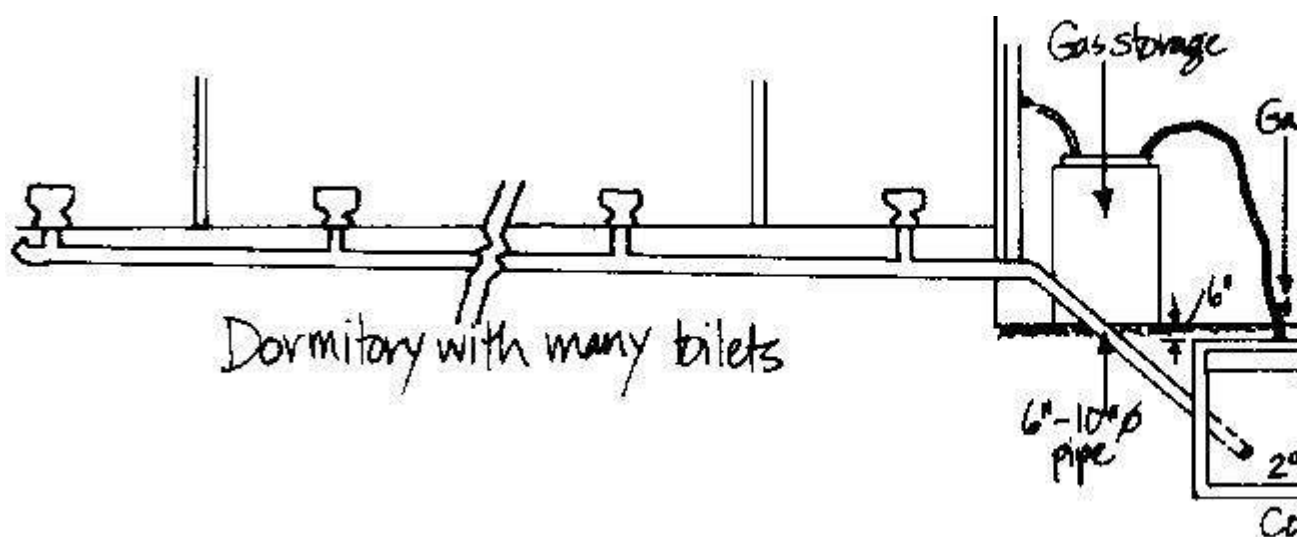

BIOGAS-TOILET SYSTEM

- Digester capacity should be one cubic meter for every ten times per day each toilet is used.
- To clean this digester, either buckets or a pump will be needed. Like all digesters, it should be cleaned once a year.

The best gas production rate for an unheated, underground horizontal digester, such as a biogas-toilet system, will probably be about 0.8 cubic meters of biogas per cubic meter of digester space per 24-hour day. The drains of the toilets should come out from under the building (it would not be safe to build a digester under a building) at a 45 percent angle to the underground digester. The digester should be large enough to take the largest possible quantity of daily waste and still maintain a 40-day detention time.

The pipe going from the digester to the septic tank should have a large diameter to keep it from getting blocked. The top of the pipe to the septic tank should be 15 cm (6.0 inches) below the bottom of the digester roof to reduce the chance that scum will be able to block the gas pipe. The digester's inlet and outlet pipes must have the same large diameter to keep the slurry moving safely from toilets to digester to septic tank.

A removable top on the digester will be necessary so that the digester can be cleaned at least once a

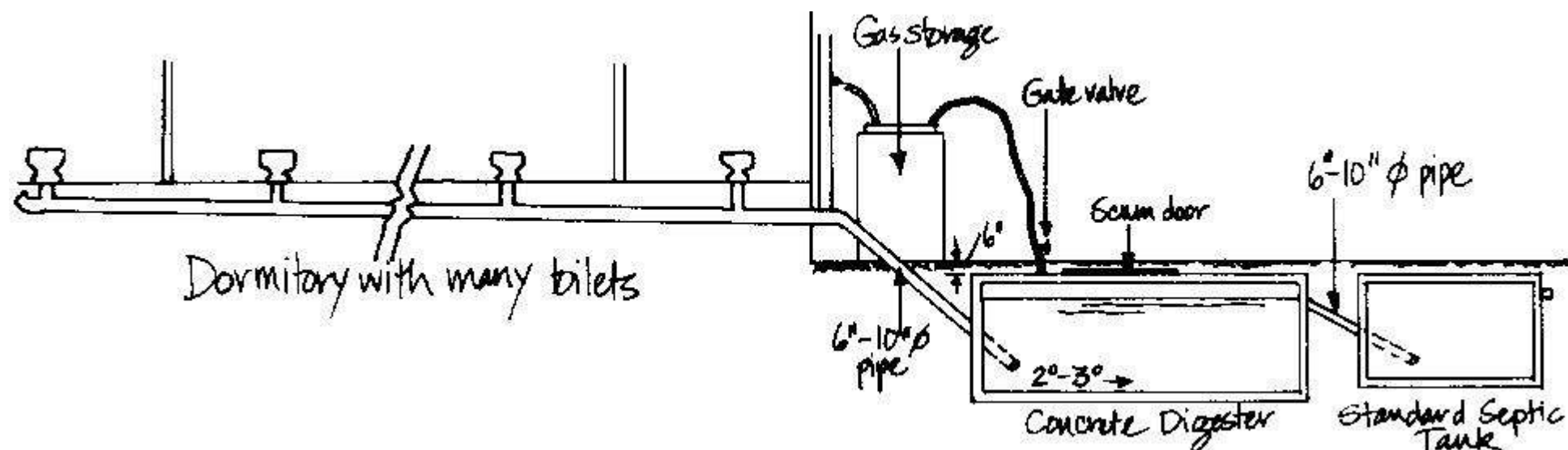

BIOGAS-TOILET SYSTEM

-Digester capacity should be one cubic meter for every ten times per day each toilet is used.

-To clean this digester, either buckets or a pump will be needed. Like all digesters, it should be cleaned once a year.

The best gas production rate for an unheated, underground horizontal digester, such as a biogas-toilet system, will probably be about 0.8 cubic meters of biogas per cubic meter of digester space per 24-hour day. The drains of the toilets should come out from under the building (it would not be safe to build a digester under a building) at a 45 percent angle to the underground digester. The digester should be large enough to take the largest possible quantity of daily waste and still maintain a 40-day detention time.

The pipe going from the digester to the septic tank should have a large diameter to keep it from getting blocked. The top of the pipe to the septic tank should be 15 cm (6.0 inches) below the bottom of the digester roof to reduce the chance that scum will be able to block the gas pipe. The digester's inlet and outlet pipes must have the same large diameter to keep the slurry moving safely from toilets to digester to septic tank.

A removable top on the digester will be necessary so that the digester can be cleaned at least once a year. The septic tank will still need its own removable cover. If the biogas is not used fast enough, one of the openings through which the gas might push digesting waste will be the toilets. For this reason, it is very important to regularly check water condensation traps and gas storage tanks to make sure they are working correctly. If a metal gas storage tank is used, do not forget to include a lightning rod because the gas tank will probably be near homes.

Because human waste has a very low carbon to nitrogen ratio, another organic waste with a high carbon to nitrogen ratio, such as newspaper, after it has been partly composted and turned into a watery newspaper mud, should be added in order to get a biogas production level that is closer to the digester's potential. It will probably not take much newspaper (or other high carbon waste), but experimenting will be the best way to find out just how much.

Concluding Thoughts on Biofertilizer

The following observation from the book, Economics for a Developing World, is an appropriate conclusion to a chapter on fertilizer: "In addition to land, fresh water and energy, supplies of fertilizer are becoming more and more scarce as a result of higher prices and alternative uses for the petroleum inputs into fertilizer production. The process of manufacturing chemical fertilizers requires large amounts of costly energy inputs. In the face of these rising costs and the enormous expansion of world demand for fertilizers, it is clear that future (chemical fertilizer) prices will continue to rise...."

year. The septic tank will still needs its own removable cover. If the biogas is not used fast enough, one of the openings through which the gas might push digesting waste will be the toilets. For this reason, it is very important to regularly check water condensation traps and gas storage tanks to make sure they are working correctly. If a metal gas storage tank is used, do not forget to include a lightning rod because the gas tank will probably be near homes.

Because human waste has a very low carbon to nitrogen ratio, another organic waste with a high carbon to nitrogen ratio, such as newspaper, after it has been partly composted and turned into a watery newspaper mud, should be added in order to get a biogas production level that is closer to the digester's potential. It will probably not take much newspaper (or other high carbon waste), but experimenting will be the best way to find out just how much.

Concluding Thoughts on Biofertilizer

The following observation from the book, Economics for a Developing World, is an appropriate conclusion to a chapter on fertilizer: "In addition to land, fresh water and energy, supplies of fertilizer are becoming more and more scarce as a result of higher prices and alternative uses for the petroleum inputs into fertilizer production. The process of manufacturing chemical fertilizers requires large amounts of costly energy inputs. In the face of these rising costs and the enormous expansion of world demand for fertilizers, it is clear that future (chemical fertilizer) prices will continue to rise....

It becomes all the more urgent, therefore, for...populous food-short nations...to intensify their efforts to promote labor-intensive and energy-saving small and medium-scale commercial farm development. This is where the greatest and least costly output potential lies."

Chapter nine: The ABCs of safety

Biogas is really no more dangerous than other fuels such as wood, gasoline, or bottled gas. But just as these fuels have their ways of being dangerous, so does biogas. Face it; anything that can cook meals and fuel an engine can also burn people.

Certain precautions should be observed in the operation of biogas systems. Biogas can be explosive when mixed with air in the proportion of one part biogas to 8-20 parts air in an enclosed space. This situation can occur when a digester is opened for cleaning, when biogas is released to repair a gas storage tank, or when there is a gas leak in a poorly ventilated room. In such cases, avoid sparks, smoking, and open flames.

A biogas leak can be smelled if the hydrogen sulfide has not been removed from the biogas. It smells like rotten eggs. No one should go inside large digesters unless they have a companion on the outside who can get them out in case they need help. Although the methane and carbon dioxide of biogas are not poisonous, a person may stop breathing if there is too much biogas and not enough oxygen in the air they are trying to breath.

Never allow negative pressure in a biogas system. Negative pressure occurs when the force created by the weight of the gases outside the biogas system is greater than the force inside the system. In normal operations the pressure inside the system should always be greater. How much greater should always be measured on a pressure gauge (see Diagram 14).

Negative pressure will pull air into the biogas system and the mixture of biogas and air might explode. If that does not happen, the oxygen in the air will kill the biogas bacteria and the gas production rate will drop. The only time the danger of negative pressure usually becomes a real possibility is when a person wants more gas from a digester than it can produce or there is an unnoticed gas leak.

When biogas is used at pressures below one column inch of water as measured on a pressure gauge, it is very likely that the flame will go out. Even though there is not much gas left in the system, biogas will continue to come out. Then the possibility for a spark or flame causing an explosion in the room or negative pressure pulling air into the biogas system causing an explosion in the system, becomes real (Maramba, 1978).

When opening a biogas digester for cleaning or repairing, do not use candles or smoke cigarettes. For light inside the digester, use a flashlight or have a person standing outside reflect sunlight off a mirror.

Make frequent smell checks for gas leaks in plastic pipes, Joints, clamps, and gate valves. Rats have been known to bite holes in plastic pipes. Stoves and gas mantle lamps should be placed with fire safety in mind. Special care must be taken in buildings with grass roofs to make sure that gas lamps are a good distance from the roof.

If the rotten egg smell of biogas is noticed in a room, immediately open doors and windows in order to get rid of the trapped gas before looking for the leak. On no account should anyone smoke cigarettes in the room. In case of fire in a house or engine room, shut the gas off at the gate valve just after the gas storage tank to keep biogas from feeding the fire.

When using any kind of gas, light the match first, then open the gas valve. If the valve is opened first and gas is allowed to flow without being lit for any length of time, large amounts of gas can escape and any flame might ignite a fireball.

Children must be taught not to play with fire close to biogas systems, in case there are any gas leaks which could cause a fire or explosion (A Chinese Biogas Manual, 1976).

Brass gate valves and pipes used in biogas systems must be of a lead-free type. The hydrogen sulfide in biogas will destroy lead, which will cause gas leaks.

The following flame arrester suggestion is adapted from the Guidebook on Biogas Development. A flame arrester is a safety device that should be added to every gas line. It is usually placed either just after the gate valve at the digester and just before the gas stove or stationary engine. Its purpose is, in case of fire, to prevent the flame from travelling down the gas pipe into the gas storage tank or digester and causing an explosion.

The arrester can be a ball or roll of fine mesh copper wire (iron and steel would rust) inserted into the gas pipe. It is sometimes not realized that this forms a barrier to the free and full flow of gas. It is recommended that the flame arrester be placed in a length of pipe of slightly larger diameter than the gas pipe. For a 0.5 inch pipe use a 0.75 inch arrester pipe; for a 1.0 inch pipe use a 1.25 inch arrester pipe.

It is very important that if a digester is built underground, that it is built in a place that never floods. If an above ground digester is built in an area that sometimes floods, make sure that the openings into the digester are above the high water mark. If a digester is built in an area that does have floods, safety measures should be taken in advance so that the gas can escape in case the digester and/or the gas storage tank are flooded. Failure to do so could result in dangerous, uncontrolled release of biogas and if the digester is a plastic bag, it could float up and away. An upside-down "T" pipe should be placed at the highest vertical point in the gas pipe line above the gas outlet from the digester. A vertical pipe and a gate valve should be joined to the stem of the upside-down "T" pipe. The gate valve can then be opened to release the biogas if a flood threatens to cover either the digester or the gas storage tank.

The following is a list of safety measures that should be read with great care before a biogas system is

built.

- 1) Regularly check the whole system for leaks.
- 2) Provide ventilation around all gas lines.
- 3) Always maintain a positive pressure in the system.
- 4) The engine room floor must be at or above ground level to avoid the buildup of heavier- than- air gases.
- 5) The engine room roof must be vented at its highest point to allow lighter-than-air gases to escape. This is also true for greenhouses that have biogas digesters, engines, or burners in them.
- 6) The engine exhaust pipe must be extended so that the dangerous and deadly exhaust gases are released outside the building.
- 7) Metal digesters and gas storage tanks must have wires to lead lightning to the ground.
- 8) Gas lines must drain water into condensation traps.
- 9) No smoking or open flames should be allowed near biogas digesters and gas storage tanks, especially when checking for gas leaks.

Methane, the flammable part of biogas, is a lesser danger to life than many other fuels. However, in the making and using of an invisible fuel, dangerous situations can arise unexpectedly and swiftly--such as when a gas pipe is accidently cut. On the other hand, precaution can be exaggerated. When cars first appeared on the roads, a man waving a red flag came first. Remember the ABC's: Always Be Careful (Fry, 1974).

Chapter ten: Conclusion: Profiting from an appropriate technology

Many of the organizations that promote and provide information on biogas systems believe the systems are an appropriate technology. A dictionary definition of appropriate technology would be a "suitable technical method of achieving a practical purpose." That definition only begins to describe what people involved in community development mean when they say biogas is an appropriate technology.

The following explanation adapted from the Appropriate Technology Sourcebook should help explain appropriate technology and why biogas systems can be used as an appropriate technology.

The tools and methods of appropriate technology share the following characteristics:

- 1) low in capital (money and machines) costs;
- 2) use local materials whenever possible;
- 3) create jobs, employing local skills and labor;
- 4) are small enough in scale to be affordable by individuals or small businesses and cooperatives;
- 5) can be understood, controlled, and maintained by people who are not experts whenever possible;
- 6) can be made locally;

- 7) has faith that people can and will work together to bring improvements to their communities;
- 8) involves decentralized renewable energy sources, such as wind power, solar energy, water power, methane gas, animal power, and pedal power;
- 9) makes technology understandable to the people who are using it and thus suggests ideas that could be used in developing more new ideas, methods, machines, and tools;
- 10) are flexible so that they can continue to be used or adapted to fit changing conditions;
- 11) do not involve patents, royalties, consultant fees, import duties, shipping charges, or financial experts; practical plans can be obtained free or at low cost and no further payment is involved.

Some of the thinking that supports the idea of appropriate technology can be explained this way:

- 1) it permits local needs to be met more effectively, because local people are involved in identifying and working to meet those needs;
- 2) it means the development of tools and machines that extend human labor and skills, instead of tools and machines that replace human labor and eliminate human skills; there is no attempt to eliminate the human element, but to make it both more productive and more creative;
- 3) it represents an understandable and controllable scale of activities, organization, and mistakes, at which people without expensive management training can work together and understand what they are doing;
- 4) it allows a more economical operation by cutting down on the amount of goods that have to be transported in this time of expensive oil, allowing greater growth of local industry and permitting greater use of local resources, both human and material;
- 5) it makes unnecessary many expensive or unavailable finance, transportation, education, advertising, management and energy services, and avoids the loss of local control that the use of such outside services so often means;
- 6) it helps establish skills in a community that are not dependent on outside control, that are not expensive to learn or use, that are self-sustaining, expanding, and have their beginning with skills that already exist in the community;
- 7) it tends toward decentralization of production, thus permitting the full benefits of work to remain within the community; this also allows control to remain within the community;
- 8) it provides a region with protection against the effects of outside economic changes such as the collapse of a cash crop market or an increase in fertilizer prices;
- 9) it helps reduce, economic, social, and political dependency between individuals, regions, and nations by recognizing that people can and will do things for themselves if the obstacles are removed;
- 10) it is in harmony with the cultural traditions of the area; this does not mean that it is stagnant, but that it grows along with the culture and does not contradict values people believe to be important; the technology is adapted to fit the culture rather than the culture being forced to adapt to fit the technology.

A few more ideas about the purpose of appropriate technology, from a slightly different viewpoint,

adapted from Experiences in Appropriate Technology.

Appropriate technology is not just windmills, solar energy, water pumps, and biogas systems. It is not so much a particular type of hardware as it is a process of local people choosing a particular type of hardware that will best help them generate social and economic development. Like any other technology, the hardware of appropriate technology is nuts and bolts, systems and procedures, motors and tools. It differs in how it is used.

It is both a technology which combines existing local knowledge and resources with new information and a style of technical, social, and economic development where local people and outside experts work together as partners. One can easily photograph the hardware of appropriate technology but not the process of people identifying their problems, discussing options, and choosing workable solutions. This process is the critical element often lacking in most descriptions of appropriate technology.

In many cases, local knowledge or skills are not more productive because social, political, or economic conditions prevent them from being so. An approach to appropriate technology that only focuses on adapting technology to social and economic conditions, and not on helping to strengthen local organizations to change these conditions, is incomplete. The use of appropriate technology in development is a process that should never stop. It is the sharing of knowledge, the learning from experience, and the development of local organizations and skills.

The concept of appropriate technology was a result of what was learned from Third World development projects of the 1960s. In response to poor and often negative results from the use of imported technologies, many people began to question the choices of technology and the way these choices were made. Even the most optimistic observer had severe doubts when faced with the discarded tractors that farmers could not maintain, broken and abandoned water pumps and biogas digesters, and new hospitals which treat diseases which could be prevented by clean water supplies.

The term appropriate technology has been used to mean many things. In the last five years many organizations have become interested in appropriate technology, some because it is now in fashion, others because they are seriously thinking about answers to the questions it addresses. Critics have dismissed appropriate technology as an extremist, anti-modernization, or anti-industrialization ethic. It is none of these.

Appropriate technology asks what style of progress or industrialization is wanted, what balance between large and small-scale production is needed, what choices of technology will promote development, and who will participate in the selection of the choices. Appropriate technology is more than machines, tools, and "how-to" manuals; it is also less tangible things such as knowledge, management, and organization of work.

Appropriate technology is an approach to development:

- 1) A technology designed, developed, and chosen in partnership with people to increase their productivity and meet their immediate and long-term needs, without in any major way increasing their dependence on outside sources of materials, energy, money, or knowledge.
- 2) A social and political process of integrating better technology into communities.
- 3) A style of development which recognizes the fact that users of any technical method have important and necessary social, economic, and technical information and resources to contribute.
- 4) A technology that can promote and strengthen local organizations and businesses so that they can increasingly assume more control over the choice of improved technology and adapt outside

resources to their own situations.

5) An approach to designing technology that promotes local economic linkages between the public, experts, local leaders, skilled workers, and business people.

6) A technology that will work, that local people and organizations can afford, control, maintain, and improve on.

The benefits of biogas technology can expand, like waves from a stone thrown into still water.

A cooperative builds a chicken coop to house chickens owned by its members and to make possible the collection of the chicken manure from a cooperative biogas digester.

- It should also be easier to keep the chickens dewormed and healthy.
- Not only do the cooperative members now have biogas and biofertilizer, they also have larger eggs, larger chickens, and at least two or three Jobs have been created.

This story can work just as well with a cooperative or business that operates a piggery or cattle pens and uses the manure to feed a digester.

- A concrete floor is added to the pens to make it easier to collect the waste and keep dirt from getting into the digester.
- Because the pens are easier to clean, it is easier to keep the animals healthy.
- Pens also make vegetable gardens safe from damage by wandering pigs and cattle.

A barn (with a concrete floor) that cattle and other farm animals can be kept in when they are not in the fields, will not collect all of the manure produced by the animals. But the manure it does collect for biogas and biofertilizer uses and the advantages of improved public sanitation, animal health, and shelter from bad weather should make the costs of animal feed, buildings, and labor worthwhile investment towards biogas system profits.

The benefits of large business or cooperative biogas systems are many:

- high gas and fertilizer production rates,
- low per cubic meter of digester capacity construction and operating costs,
- plenty of fertilizer for fish ponds and/or crops,
- engine-generator combinations that in many cases can use or distribute mechanical and/or electrical energy made from biogas more efficiently than biogas itself can be used or distributed,
- and a large biogas system could even afford a tank truck to distribute or sell the liquid fertilizer.

Biofertilizer which, after aging, can be used in fish ponds and on crops may be more valuable than biogas. It has been estimated that 230,000 tons of nitrogen fertilizer that is produced in a year by one high-technology coal-based fertilizer plant will employ 1,000 people. At approximately the same cost, 26,000 biogas systems could produce the same amount of nitrogen fertilizer and create 130,750 jobs (Diagram 3).

But if the owners ignore the needs of their biogas system, it will ignore their needs for fuel and

fertilizer. The operation of a biogas system is not as simple as putting in waste and taking out fuel and fertilizer. If that is how a biogas system is operated, it will become a disappointment. Poor performance will sooner or later lead to abandonment of the biogas system.

Think of a biogas system as a small factory or mill. A factory whose products of fuel and fertilizer are of high quantity and quality only when the owners: understand how and why the factory produces fuel and fertilizer, make sure routine work is done correctly, and are able to solve unexpected problems. Biogas is a business where questions of management and sales are as important as technical questions.

To find out if biogas technology, or any technology is practical, ask:

- How is it made?
- How does it work?
- How is it used?
- How could it be used here?
- Who pays the costs?
- Who gets the profits?
- Who controls it?

In other words, ask questions about how the technology might change the way things are. This handbook has enough information to begin to answer these questions, but only the people who will use and live with the technology can finish answering the questions with the knowledge of their own situation, resources, and needs.

Where biogas has been a successful response to local needs, it is because the people who tried biogas asked questions and experimented with the technology and the management of the systems. They compared their experiences with other people using biogas systems and decided for themselves how to use biogas technology to help meet their needs. The gas and fertilizer products, the sanitation benefits, and the economic opportunities of biogas systems are tools which families and communities can use to create more financial security, health, and independence.

Appendix

New ideas

This section is a brief look at a few new ideas that have the potential for increasing the uses and profits of biogas systems.

Carbon Dioxide

Biogas is primarily two gases: methane and carbon dioxide. Some people say that the carbon dioxide should be removed from the biogas and some people say that removing the carbon dioxide would cost more than the costs involved in not removing it.

There are costs in not removing the carbon dioxide because carbon dioxide, which is 30 to 40 percent biogas, does not burn. Carbon dioxide takes up expensive gas storage space and dilutes the heat value of biogas in the same way water dilutes the food value of soup.

What if there were uses for the carbon dioxide, just as there are uses for the methane? That would mean there would be a third biogas system product, an additional way to make biogas systems profitable to the system owners and useful to the community. Two possible uses for carbon dioxide are in greenhouse operations and in the manufacture of dry ice. First, an outline on removing carbon dioxide from biogas and then a few notes on the uses of carbon dioxide.

The heat available from a unit volume of biogas can be increased if the carbon dioxide is removed. In a sample of biogas which is 55 percent methane and 45 percent carbon dioxide, completely removing the carbon dioxide will increase the heat available from a unit volume of that biogas by a factor of 1.8, more than one and a half times the original heat value.

Where biogas is produced for several days but only used intensively at the end of that period or where pressurized bottled gas storage is used, scrubbing the carbon dioxide out will significantly reduce the cost of gas storage. A simple carbon dioxide scrubber consists of a tank with stirrers to mix lime or ash in water (see Diagram 17).

The scrubber is placed on the gas pipe line between the digester and the gas storage tank. When the biogas from the digester bubbles through the lime water, the carbon dioxide is absorbed by the lime water mixture. The lime residue is removed from time to time from the bottom of the scrubber and can be used as potash fertilizer.

For many uses and most biogas systems, carbon dioxide scrubbing is usually not necessary. A simple method that will get rid of some of the carbon dioxide is to add a few cups of lime to the water in the gas storage tank. This will absorb some, but not all, of the carbon dioxide. Every once in a while, by siphoning, a gate valve, or some other method it will be necessary to replace the used lime water with fresh lime water. This must be done without losing the water seal which traps the biogas in the gas tank or when the gas tank is not in use.

DIAGRAM 18

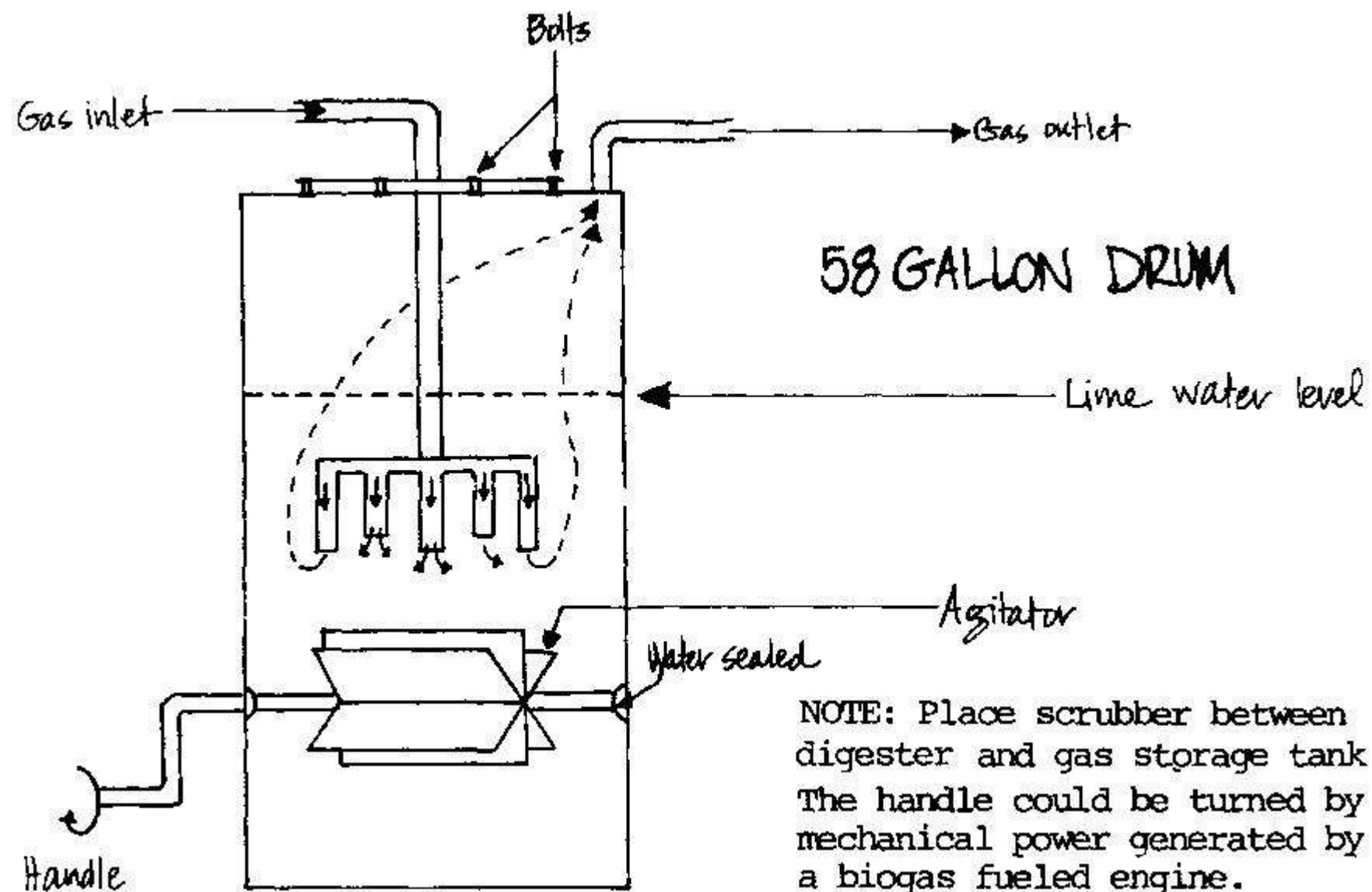

CARBON DIOXIDE SCRUBBER

-NOTE: Place scrubber between digester and gas storage tank. The handle could be turned by mechanical power generated by a biogas fueled engine.

-From: Methane Digesters

L. John Fry had two 80 cubic meter digesters, used much of his biogas to fuel engines, and as far as I can tell, never scrubbed out either the carbon dioxide or the hydrogen sulfide. For those interested in removing the hydrogen sulfide (less than one percent of most biogas), there is in the book, The Compleat Biogas Handbook for Farm and Home, instructions on how to make and use a hydrogen sulfide scrubber. VITA also has design information for carbon dioxide and hydrogen sulfide scrubbers.

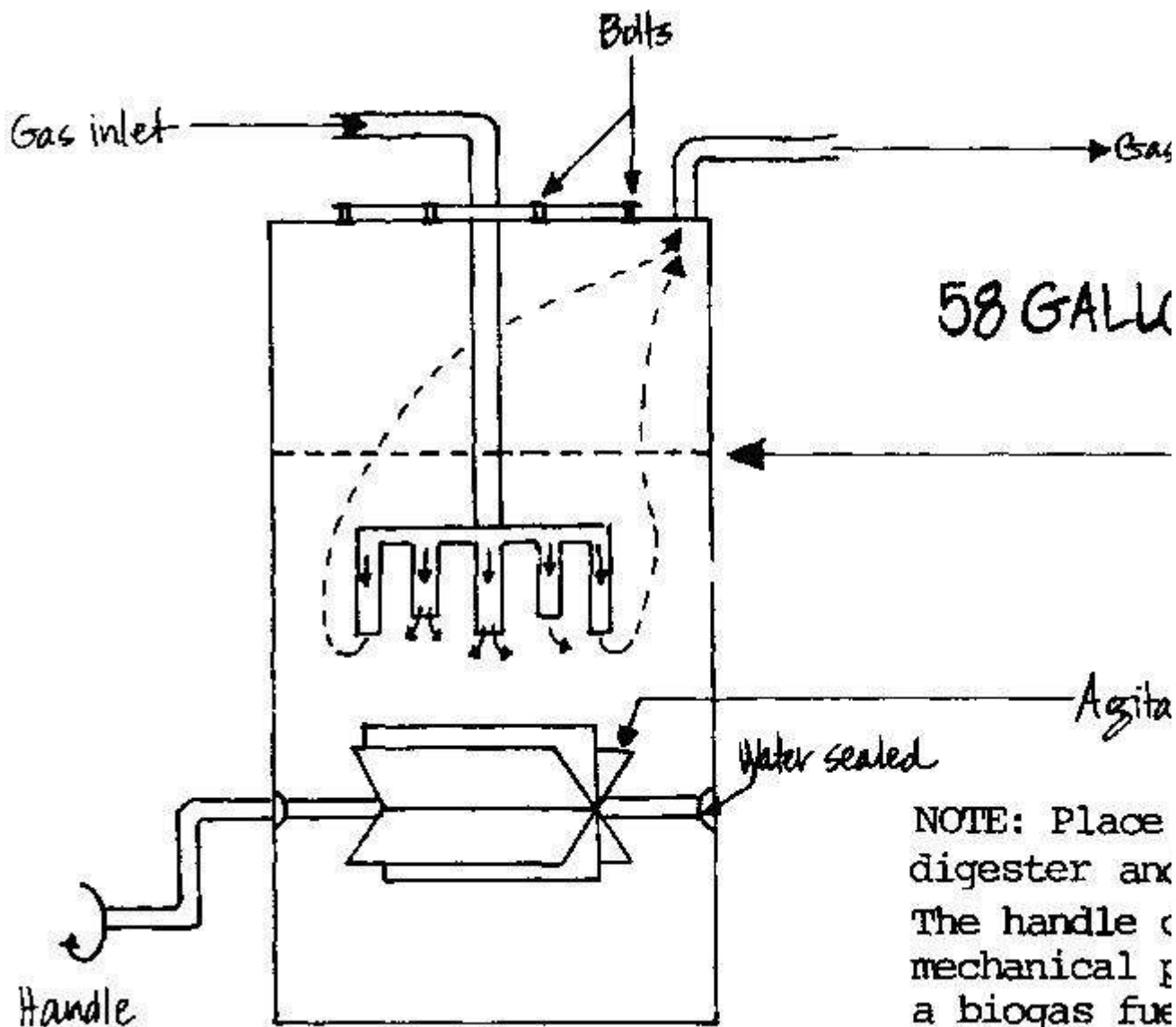

CARBON DIOXIDE SCRUBBER

-NOTE: Place scrubber between digester and gas storage tank. The handle could be turned by mechanical power generated by a biogas fueled engine.

-From: Methane Digesters

L. John Fry had two 80 cubic meter digesters, used much of his biogas to fuel engines, and as far as I can tell, never scrubbed out either the carbon dioxide or the hydrogen sulfide. For those interested in removing the hydrogen sulfide (less than one percent of most biogas), there is in the book, The Compleat Biogas Handbook for Farm and Home, instructions on how to make and use a hydrogen sulfide scrubber. VITA also has design information for carbon dioxide and hydrogen sulfide scrubbers.

The Indian Agricultural Research Institute has reported the following method for removing carbon dioxide from biogas (as reported in Nepal's Biogas Newsletter). Biogas is bubbled through a solution of ten percent monoethanolamine (MEA) in

water. The carbon dioxide content of the biogas is reduced to 0.5 to 1.0 percent by volume from an initial content of about 40 percent by single bubbling through a plain column 6.0 cm (2½ inches) in height. The scrubbing column is made of an inexpensive plastic bubbler (5.0 cm in diameter and 15 cm in height), having only one opening. Maximum removal of carbon dioxide is observed when the bubbling coming from the opening comes out slowly enough so that each bubble is separate from the others and the stream of bubbles is never in danger of merging into a continuous "tube."

The ideal rate of flow is 100 milliliters per minute at the regulator. This rate yields 60 milliliters of pure methane per minute. A decrease in this rate of flow does not result in any increase in scrubbing effect. Initial pressure of the biogas introduced into the bubbler is 10.0 cm (4.0 inches) of water column, and the drop in pressure head is about 5.0 cm (2.0 inches) of water.

Both caustic potash and MEA are equally effective. But MEA solution can be completely stripped of the carbon dioxide by boiling it for five minutes, after which it can be used again. MEA is also less caustic (able to cause chemical burns) than other solutions that can be used. It will not cause any damage to the skin in case of accidental contact.

Once the carbon dioxide is separated from the biogas, it can be used. The two uses outlined below are adding the carbon dioxide to the air in greenhouses and freezing the carbon dioxide to make dry ice.

Greenhouses

Greenhouses have glass or plastic walls and roof and are used for growing plants. They trap the solar energy of the sun that green plants need to make their food. Greenhouses also protect plants from cold weather, wind, heavy rain, dry weather, and insects.

Solar greenhouses are greenhouses designed to be heated primarily by the sun, even during cold weather. Traditional greenhouses require large amounts of fuel for heating. Solar greenhouses can also be designed to heat attached houses, acting as solar collectors.

Solar greenhouses require double glazing (two layers of glass) and/or night insulation, a storage mass, the proper glazing tilt, and an insulated upper roof and northern wall. For a solar greenhouse attached to a house, the northern wall of the greenhouse is replaced by the house so that it can receive heat from the greenhouse during the day.

Solar greenhouses also work well in hot climates. They can be designed for cooling by venting hot air up a chimney and drawing cool air in the bottom. In all climates, hot and cold, greenhouses save water when compared with crops grown outside. Some reports have shown water usage for greenhouse crops to be 1/10 to

1/30 of field crops.

The Philippines is the first tropical country in which greenhouse food production has been done on a commercial basis. The main reason for using greenhouses was to protect the crops from the force of heavy seasonal rains. The greenhouses also provided other benefits of water control, such as reduced leaching of fertilizer, less washing-off of insecticides, fewer cases of crop diseases, and easier weed control.

When plants are grown in greenhouses, the crop yields can be increased by increasing the percentage of carbon dioxide in the air (normally only 0.04 percent) during the daylight hours. Plants absorb carbon dioxide through their leaves and use it to manufacture plant food.

Greenhouse experiments with carbon dioxide were done at Michigan State University in the United States during the winter of 1961-62. Plastic tubing was used to distribute the carbon dioxide through the greenhouse.

In the first year increases of 30 percent in lettuce crop yield were obtained, and in the second year increases of 70 percent were obtained--in part because very cold weather made it necessary to close the ventilators more than usual. Increases in tomato yields ranged from 25 to 70 percent, depending on variety. The percentage of the air which is carbon dioxide gas is the main factor controlling plant growth and development under all levels of light intensity except the very lowest.

In countries with cold weather, a greenhouse could be built as part of a biogas system. The greenhouse could even be built around and over the digester in order to reduce the amount of heat needed to maintain the digester temperature at 35 degrees centigrade. The excess engine heat could be used to help heat the greenhouse as well as the digester. In such a system it may be economical to increase the carbon dioxide content of the greenhouse air by separating the carbon dioxide from the methane in biogas. The carbon dioxide gas would then be used as a plant growth factor to increase yields in greenhouse crops.

There are two ways to separate carbon dioxide from biogas so that it can be used by greenhouse plants. The carbon dioxide could be chemically removed from the biogas (the MEA method described in Diagram 19) or it could be released by burning the biogas.

One way to do that would be to heat a water boiler inside the greenhouse. The boiler would produce steam which would power a Rankine-cycle engine (more on that later), and the carbon dioxide (and some heat) would be released into the greenhouse air where the plants could use it.

Detailed information on solar greenhouse design and construction methods are available from the same sources of information that were used to write this introduction to the subject. They were: Chris Ahrens' Greenhouse from VITA;

The Appropriate Technology Sourcebook, Volumes I and II; and **Energy for Rural Development**, the original book and the supplement. VITA might also be able to find more information on the process of carbon dioxide enrichment of greenhouse air.

DIAGRAM 19

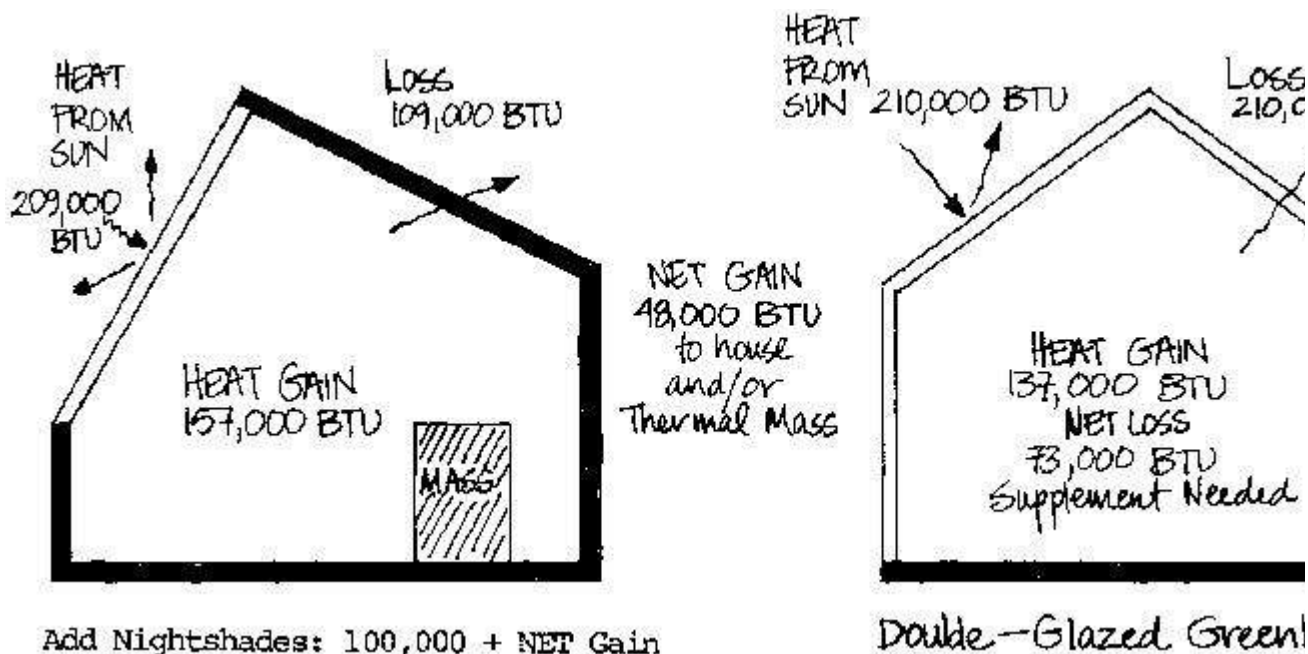

SOLAR GREENHOUSES TYPICAL HEAT GAINS AND LOSSES

Dry Ice

Leo Pyle, Chairman of the Methane and Fertilizer Working Group of the Intermediate Technology Development Group, makes a very interesting statement in the book, **Biogas Technology in the Third World: A Multidisciplinary Review**. He said, "The possible reuse of carbon dioxide merits serious consideration. Carbon dioxide can be regenerated easily from lime water and could be used as dry ice for local health services, refrigerators, etc..."

It is true that carbon dioxide can be easily separated (scrubbed) from the methane of biogas and then separated from the liquid that was used to do the separating. But scrubbing costs money and time; it should only be done if the increased value of the methane and the value of the separated carbon dioxide is greater than the costs involved.

One way to get a value out of carbon dioxide is to freeze it; make it into what is called dry ice.

- Dry ice has a 70 percent greater cooling value than the same amount of water ice.

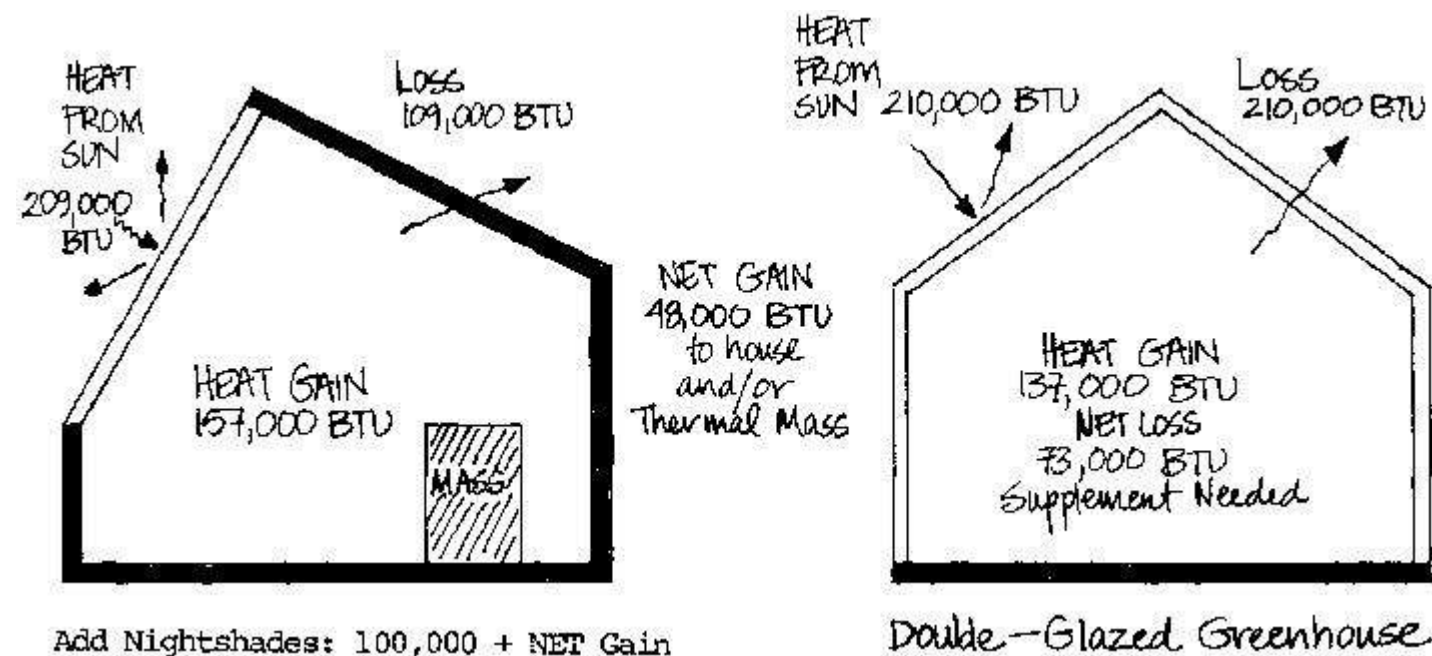

SOLAR GREENHOUSES TYPICAL HEAT GAINS AND LOSSES

Dry Ice

Leo Pyle, Chairman of the Methane and Fertilizer Working Group of the Intermediate Technology Development Group, makes a very interesting statement in the book, Biogas Technology in the Third World: A Multidisciplinary Review. He said, "The possible reuse of carbon dioxide merits serious consideration. Carbon dioxide can be regenerated easily from lime water and could be used as dry ice for local health services, refrigerators, etc..."

It is true that carbon dioxide can be easily separated (scrubbed) from the methane of biogas and then separated from the liquid that was used to do the separating. But scrubbing costs money and time; it should only be done if the increased value of the methane and the value of the separated carbon dioxide is greater than the costs involved.

One way to get a value out of carbon dioxide is to freeze it; make it into what is called dry ice.

- Dry ice has a 70 percent greater cooling value than the same amount of water ice.
- When water ice melts, it becomes a puddle of water; when dry ice melts, it becomes a part of the air.
- Dry ice is much more useful than water ice for shipping and storing foods and medicines that would rot or otherwise go bad if not kept cold.

- **When water ice melts, it becomes a puddle of water; when dry ice melts, it becomes a part of the air.**
- **Dry ice is much more useful than water ice for shipping and storing foods and medicines that would rot or otherwise go bad if not kept cold.**
- **When compared with water ice, the process of making dry ice is much more expensive and requires much more complicated machines and methods.**

At normal, everyday air pressure, there is a 1.512 kilograms of carbon dioxide in a cubic meter of carbon dioxide. In other words, a cubic meter of carbon dioxide gas weighs 1.512 kilograms.

- **If that carbon dioxide is in a biogas system's gas storage tank at 7.5 column inches of water pressure, there will be 1.789 kilograms of carbon dioxide in a cubic meter of carbon dioxide.**
- **In an ordinary biogas system that produces 100 cubic meters of biogas per day (60 percent methane, 40 percent carbon dioxide), there will be 40 cubic meters of carbon dioxide produced per day.**
- **Because the carbon dioxide scrubbing systems and the dry ice manufacturing systems will not be 100 percent efficient, estimate that only approximately one kilogram of carbon dioxide in a cubic meter of biogas will end up as dry ice.**
- **So a biogas system that produces 100 cubic meters of biogas will be able to produce 30 to 50 kilograms of dry ice per day.**

This is a very approximate estimate because very little work has been done or information been made available on the production of dry ice from small-business biogas systems.

DIAGRAM 20

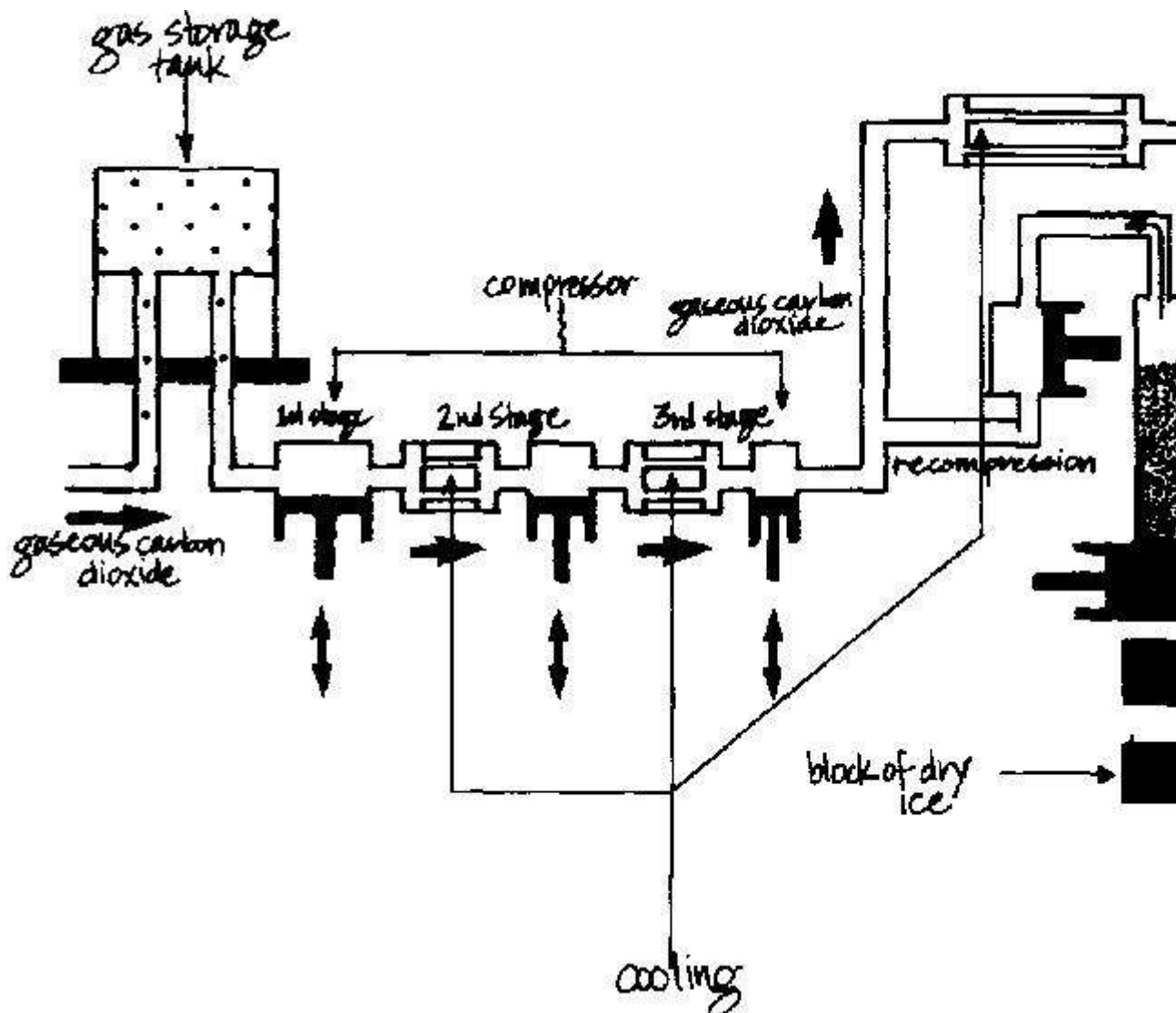

MANUFACTURE OF DRY ICE

Diagram 20 shows how dry ice is made. A combination of very cold temperatures and very high pressures turns the carbon dioxide gas into a liquid; then a "snow," and then into a solid (dry ice). If a dry ice business already exists, it might want to start a biogas system and use the methane for fuel, sell the sludge for fertilizer, and use the carbon dioxide to reduce the amount of carbon dioxide it has to buy--but only if the biogas system would reduce, not increase, costs.

A biogas business thinking of starting a dry ice operation would have to make sure that there would be a market for the dry ice at a price that would cover costs and allow for a profit. A biogas business thinking about going into the dry ice business should visit dry ice businesses in their own country to find out such things as local dry ice business expenses, profits, markets, potentials, and problems. Then if dry ice still looks like a profitable business, VITA and/or a Peace Corps Volunteer might be able to help find ways to reduce the costs and risks of operating a biogas system that included a dry ice business.

Solar Water Heaters

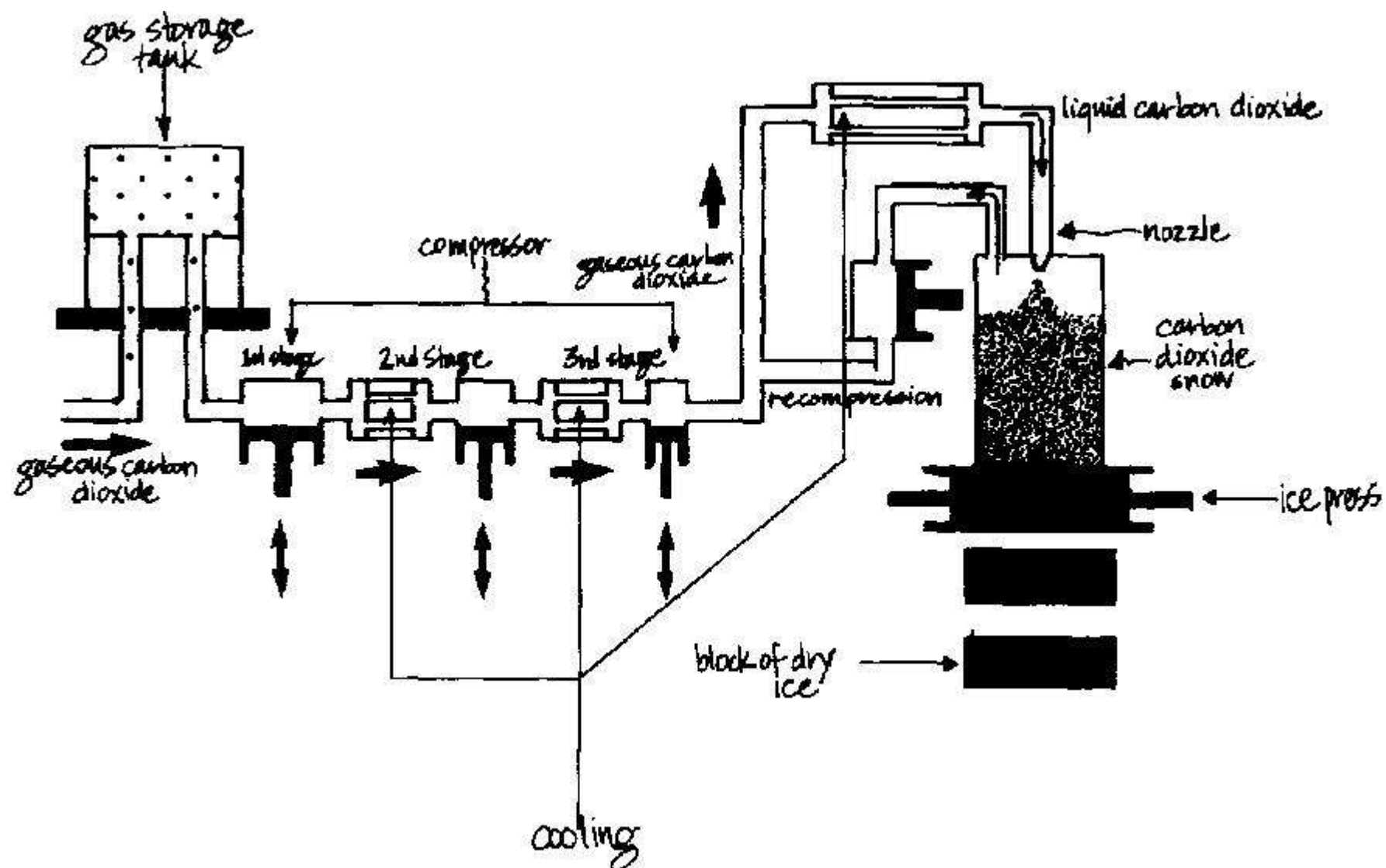

MANUFACTURE OF DRY ICE

Diagram 20 shows how dry ice is made. A combination of very cold temperatures and very high pressures turns the carbon dioxide gas into a liquid; then a "snow," and then into a solid (dry ice). If a dry ice business already exists, it might want to start a biogas system and use the methane for fuel, sell the sludge for fertilizer, and use the carbon dioxide to reduce the amount of carbon dioxide it has to buy--but only if the biogas system would reduce, not increase, costs.

A biogas business thinking of starting a dry ice operation would have to make sure that there would be a market for the dry ice at a price that would cover costs and allow for a profit. A biogas business thinking about going into the dry ice business should visit dry ice businesses in their own country to find out such things as local dry ice business expenses, profits, markets, potentials, and problems. Then if dry ice still looks like a profitable

business, VITA and/or a Peace Corps Volunteer might be able to help find ways to reduce the costs and risks of operating a biogas system that included a dry ice business.

Solar Water Heaters

How does a solar water heater work? Any surface that is exposed to the sun will get hot as it absorbs radiant solar heat. When the surface becomes hotter than its surroundings, it will begin to lose heat in three ways:

- 1) By conduction--through any object with which it is in contact;
- 2) By convection--through contact with air or water;
- 3) By re-radiation to the sky or to other nearby cooler objects.

By minimizing heat losses and diverting the heat to a storage tank, a "solar collector" has been created.

DIAGRAM 21

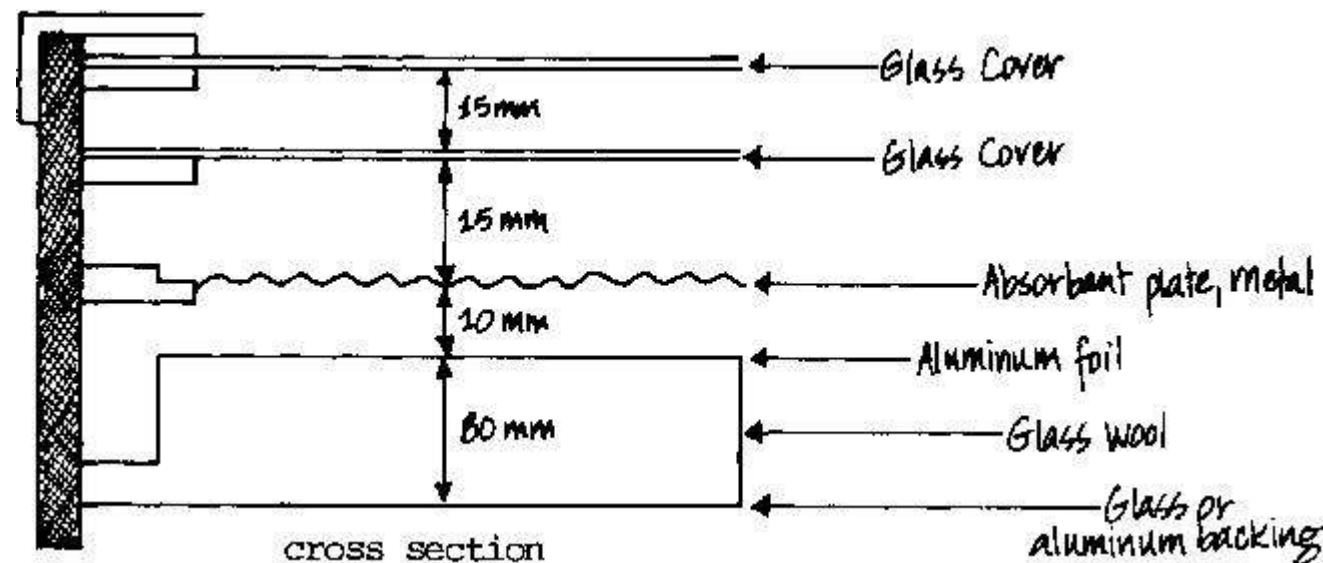

SOLAR COLLECTOR PLATE

-from; Technology for Solar Energy Utilization

Several conditions must be met before a useful amount of heat can be collected. The collector must be facing toward the sun and be tilted to the sun's rays in order to collect the maximum amount of solar radiation. The conduction of heat from the absorber surface to a storage tank must be fast and

How does a solar water heater work? Any surface that is exposed to the sun will get hot as it absorbs radiant solar heat. When the surface becomes hotter than its surroundings, it will begin to lose heat in three ways:

- 1) By conduction--through any object with which it is in contact;
- 2) By convection--through contact with air or water;
- 3) By re-radiation to the sky or to other nearby cooler objects.

By minimizing heat losses and diverting the heat to a storage tank, a "solar collector" has been created.

DIAGRAM 21

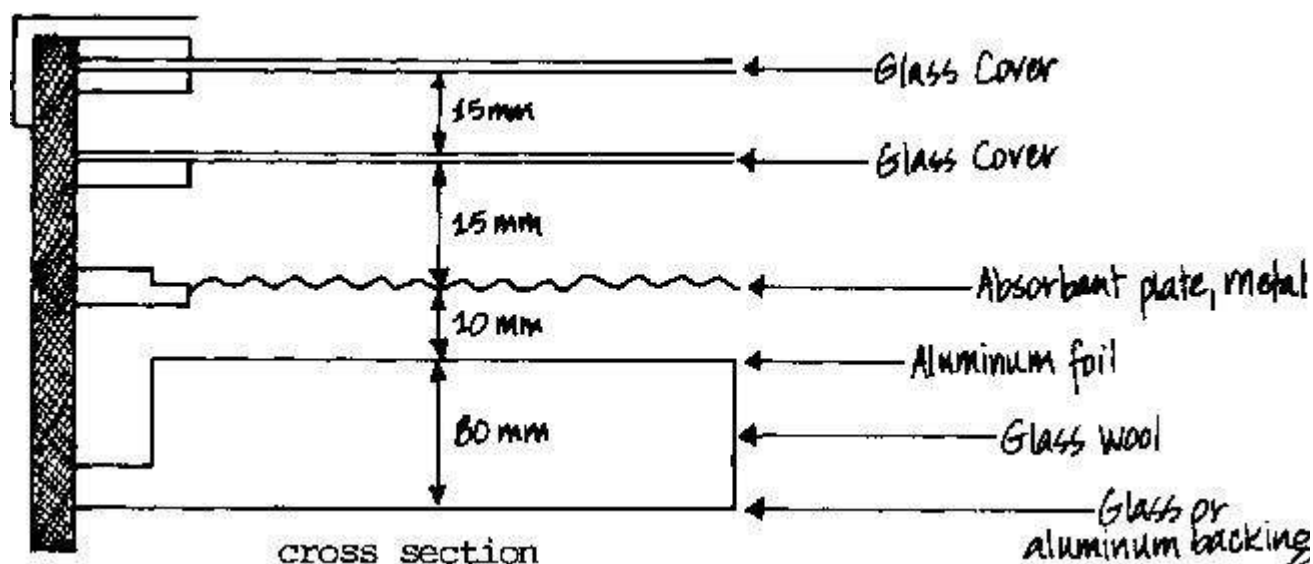

SOLAR COLLECTOR PLATE

-from; Technology for Solar Energy Utilization

Several conditions must be met before a useful amount of heat can be collected. The collector must be facing toward the sun and be tilted to the sun's rays in order to collect the maximum amount of solar radiation. The conduction of heat from the absorber surface to a storage tank must be fast and efficient, and the heat loss from the absorber surface must be kept at a minimum.

VITA has a very good small book on how to build and operate solar hot water heaters for less than US\$ 100. The hot water can be used to heat biogas digesters or preheat the slurry when an engine is not part of the biogas system. A solar hot water heater would also be useful for a biogas system where the engine was not run all the time. The hot water could fuel Rankine-cycle engines which could be used to produce mechanical and/or electrical power. And last but not least the hot

water could be used for bathing, cleaning, and heating purposes.

There are many books and magazines on the different kinds and prices of solar systems (the Appropriate Technology Sourcebook, Volumes I and II, have very complete lists). The following introduction to the subject is from the VITA book, Solar Water Heater. The design is simple, inexpensive, can be made just about anywhere, and can be easily used in biogas systems.

"Heat from the sun's rays is easily captured. Black-painted surfaces exposed to the sun will get hotter than those of any other color. A metal surface painted flat black and placed in contact with water will heat the water. The black metal plate is called an absorber.

"Once the water is heated, it is kept hot with insulation. The heated water behind the absorber can be insulated with a variety of substances such as fiberglass, straw, sawdust, hair, or polyurethane foam. In some designs a sheet (or two) of glass is placed between the absorber plate and the sun (Diagram 21). Glass transmits the high radiation from the sun that heats the water but stops the low-energy infrared radiation that is reradiated from the absorber. It also keeps air from passing over the absorber and causing heat loss. The reduction of the two forms of heat loss makes glass an ideal insulator. Clear plastics can be used but their life expectancy is limited.

"(The VITA) system will heat 70 liters (18.5 gallons) of water to 60 degrees centigrade (140° F) between sunrise and noon on a clear day with an average outside temperature of 32 degrees centigrade (90° F). (If one or two glass plates are placed between the absorber and the sun, as in Diagram 21, more water can be heated to higher temperatures in the same or less amount of time.) Obviously, water does not have to be this hot for many purposes: very hot water can be mixed with cool water to provide water warm enough for bathing and washing clothes and dishes. This factor should be taken into account when estimating the amount of water needed each day.

"There are two main parts to the solar water heater (Diagram 22): (1) a heat-absorbing collector that is rather like an envelope made of (two) metal sheets; and (2) a storage tank that holds the water for the system. The collector can be made either of flat or corrugated galvanized metal sheets that have been painted with several coats of black rustproof paint. (If the cost is not too high, the sheets can be made of copper, which will not rust. Copper will also capture more heat than any other metal.)

"It is important to remember that the storage tank must be located 46 cm (18 inches) or higher above the collector to enable the thermosyphon to work (Diagram 23).

"The Thermosyphon Principle: The tank, filled with water, is connected to the collector. The collector is positioned below the bottom of the tank. Water runs

through a hose at the bottom of the tank to the collector. Hotter water flows toward the top of the collector. Hot water is forced out of the hose at the top of the tank and cooler water flows to the collector. The flow established continues until the water is no longer being heated by the sun (Diagram 23). For example, at night the flow becomes stable and the hot water remains until it is used or it cools.

DIAGRAM 22

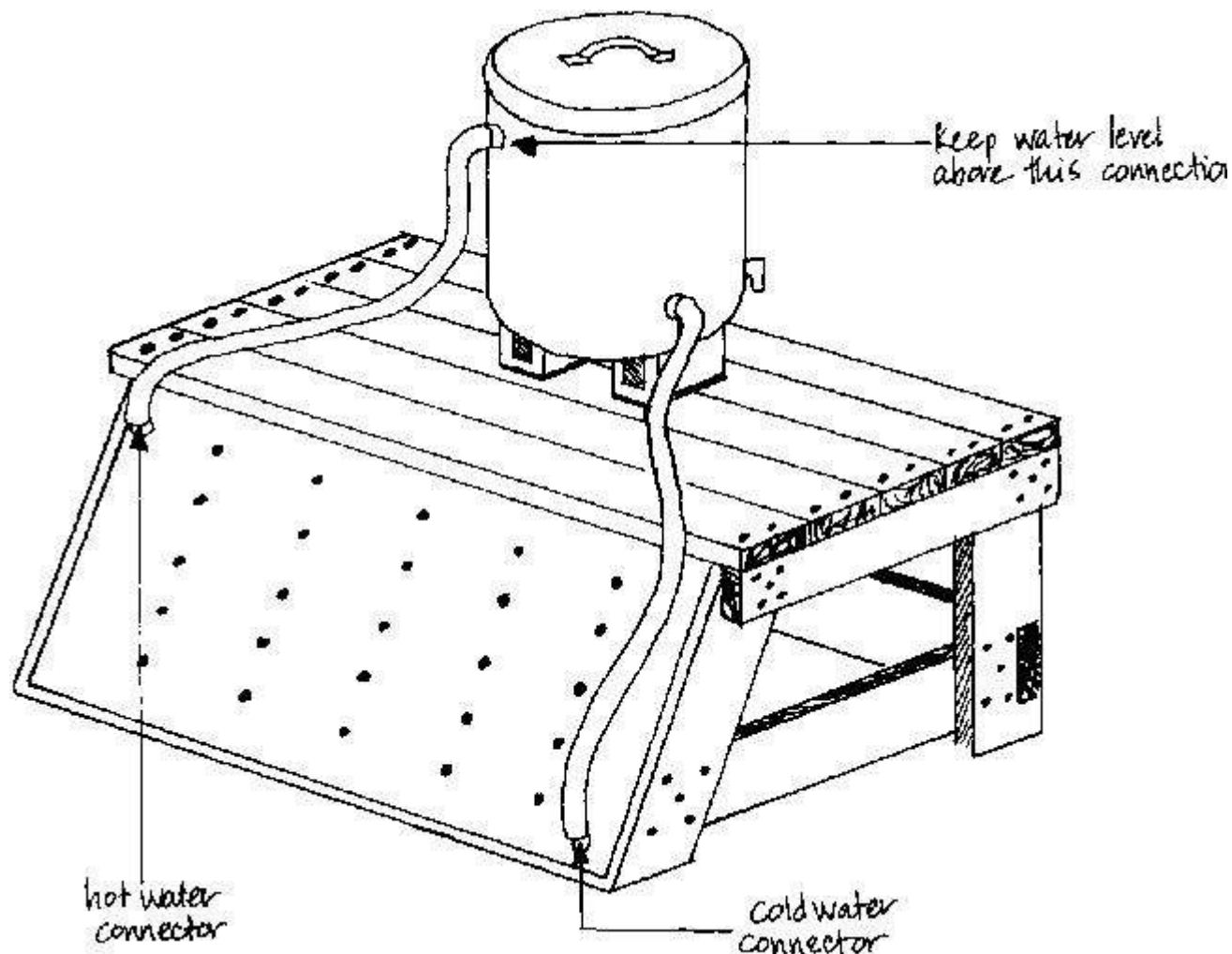

VITA PORTABLE SOLAR COLLECTOR AND STORAGE TANK

DIAGRAM 23

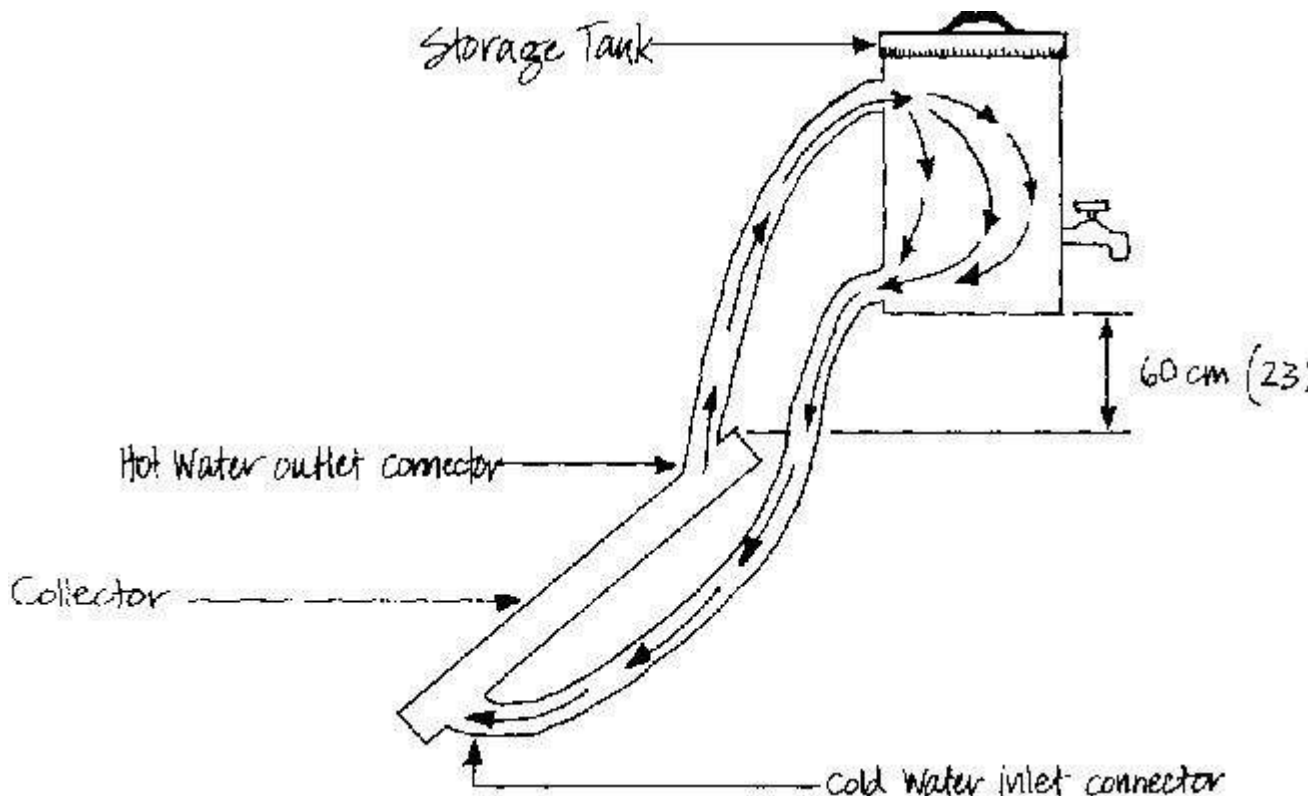

MOVEMENT OF WATER THROUGH A COT COLLECTOR

"(It would cost more money, but if the hot and cold water pipes were connected inside the water tank by a long coil of copper pipe, a heat exchanger, the water would get heated without it being necessary to keep the water level in the tank above the hot water connection in order to maintain the thermosyphon circulation. A closed circulation heat exchanger design would have to be used if a solar water heater is used to heat biogas slurry and digesters.)

"Site conditions are important. Collectors should face directly south. Turning a collector southeast or southwest can affect its performance by 20 percent or more. If hot water is needed by noon, face the collector to the southeast; if hot water is more important in late afternoon, face the collector to the southwest. (Building a collector platform that can be easily turned is a simple but effective way to follow the sun and increase hot water production.)

"The site should be free from shade. Collectors should be placed so that they can be tilted from the horizon to an angle equal to the latitude of the location. In more temperate climates (cold winters and hot summers), the angle should equal the latitude plus ten degrees..."

Rankine-Cycle Engines

Rankine-cycle engines are simple, low-cost steam engines that can be powered by solar collector heated water. Rankine engines involve the evaporation and condensation of a fluid under differing pressure and temperature conditions.

When the fluid is evaporated at high temperature and pressure and condensed at low temperature and pressure, useful work can be extracted from the vapor during its expansion from the higher pressure to the lower pressure. Only a small part of this work need be re-invested in pumping the liquid back to the high-pressure state because of the small liquid volume. This cycle of pumping/evaporation/expansion/condensation is the basis of all steam engines, whether they employ pistons or turbines to extract work from vapor.

The Rankine engines described here get their energy from heat exchangers that are heated by hot water coming from solar collectors. If biogas is used to heat the heat exchanger, in addition to the heat coming from the solar collectors, the engine can run day and night, in all kinds of weather. If the biogas digester and the Rankine engine, or at least the heat exchanger, are in a greenhouse, the carbon dioxide that is released when the biogas is burned to heat the heat exchanger will increase the percentage of carbon dioxide in the greenhouse air. The extra carbon dioxide will act like a fertilizer and increase the crop yield of the greenhouse plants.

A note of caution. Just as in the case of a building with a biogas powered stationary engine in it, the roof of the greenhouse must be vented in case something goes wrong and unburned gas escapes.

When the engine part of a biogas system is a Rankine engine, the preheating of slurry and the heating of the digester might be more efficiently achieved than it is with gasoline or diesel engines.

No books or magazine articles were found that describe combining solar collector/Rankine-cycle engines with biogas systems. What follows are quotes from a book and an article on Rankine engines. Anyone interested in Rankine engines, powered either by solar collectors, biogas digesters, or both, should write to the authors or to VITA for more information.

This first report is from the book, Energy for Rural Development . "The traditional example of a Rankine engine is the familiar steam engine...This discussion, however, will be restricted to engines that are more useful on a smaller scale and that operate at temperatures in the range that can be achieved with solar collectors. For these lower temperatures, Rankine-cycle engines have been designed that use organic materials (such as freon) instead of water as the working fluid. The analysis that follows illustrates the type of system that would be associated with a solar-powered Rankine-engine-operated electric power plant (see Diagram 24). It is based on current manufacturing capabilities for the individual components.

DIAGRAM 24

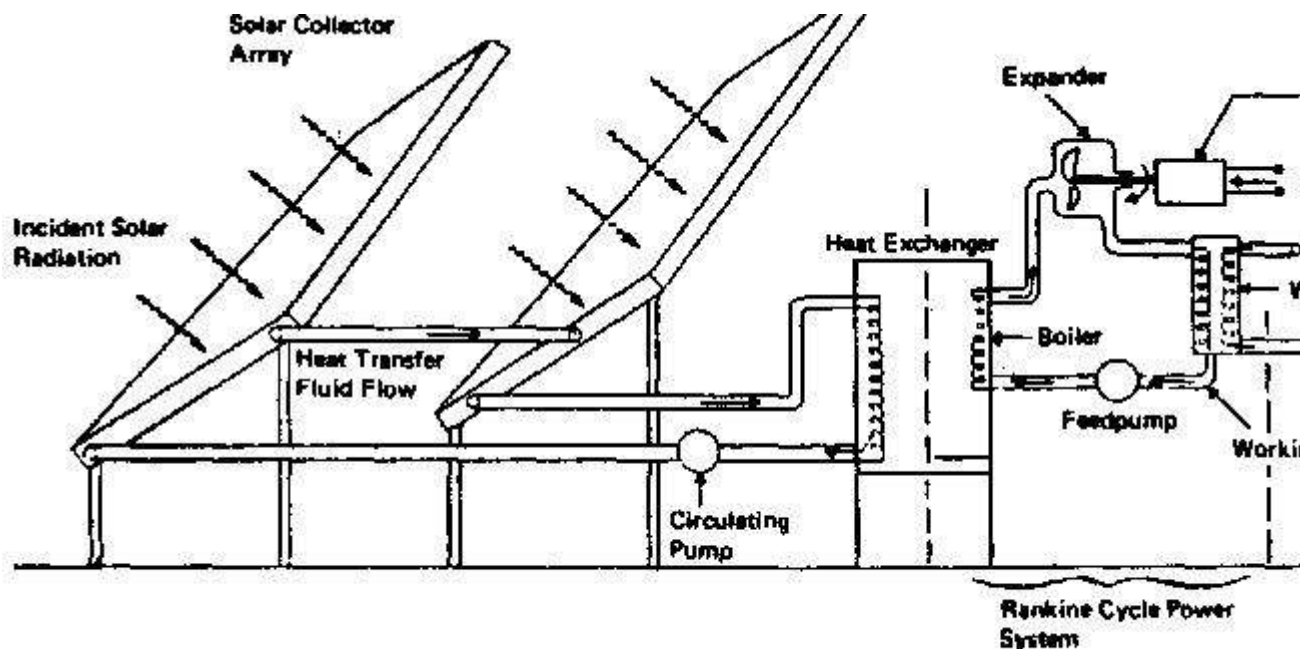

Solar-powered electric power plant. (Courtesy Arthur D. Little)

SOLAR COLLECTOR AND RANKINE ENGINE

"The engine consists of four major components: expander, boiler, feedpump, and condenser. During operation, a heat-transfer fluid (typically pressurized water) flows through the collector array and is heated to a temperature in the 200-400° F (100-200° C) range depending on solar-collector configuration (design), solar flux (changes), and engine operating conditions. This would entail a system capable of operating at about 235 psi (16.5 kg/sq cm gauge).

"The hot fluid (water) is then used to vaporize the working fluid (freon) of the engine in a heat exchanger; a number of common refrigeration fluids are appropriate for use in the engine loop. The hot, high-pressure, working fluid is then used to drive the expander of the Rankine-cycle engine. For higher-power-output applications (greater than 100 kw), the expander will be a turbine. Lower-power systems can use positive displacement configurations (designs) such as reciprocating (piston) or vane-type expanders. After leaving the expander, the working-fluid vapor is condensed and the liquid is then pumped back into the solar collector heat exchanger, completing the cycle.

"Engine performance calculated on the basis of an expander efficiency of 80 percent and a feedpump efficiency of 80 percent indicates that it is possible to achieve about 65 percent of the ideal Carnot efficiency when the engine is operating in its appropriate temperature range.

"Both focusing and non-focusing collectors can be used as the heat source for organic Rankine-cycle engines. Flat-plate (non-focusing) collectors are used here to illustrate the effect of thermal collector characteristics on overall system performance for the following reasons: Flat plate collectors have the advantage of being capable of effective operation mounted in a fixed position. The collectors

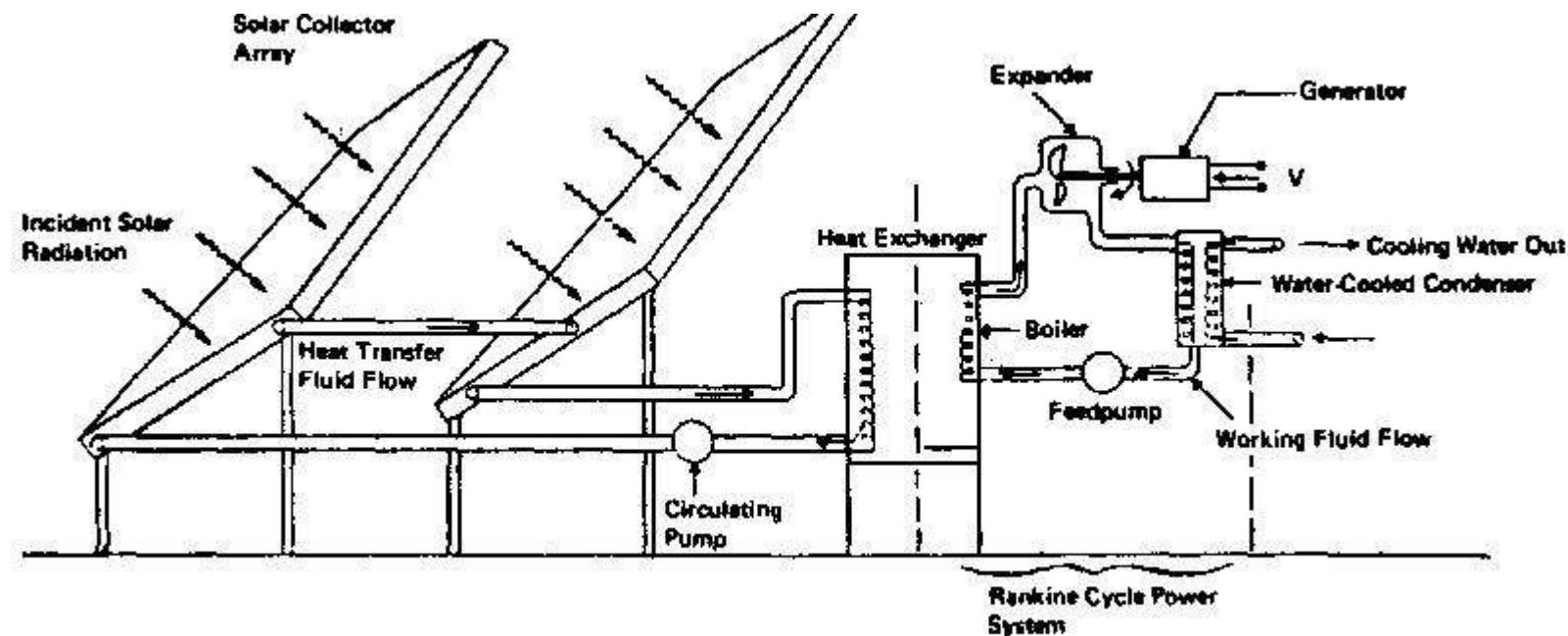

Solar-powered electric power plant. (Courtesy Arthur D. Little, Inc.)

SOLAR COLLECTOR AND RANKINE ENGINE

"The engine consists of four major components: expander, boiler, feedpump, and condenser. During operation, a heat-transfer fluid (typically pressurized water) flows through the collector array and is heated to a temperature in the 200-400° F (100-200° C) range depending on solar-collector configuration (design), solar flux (changes), and engine operating conditions. This would entail a system capable of operating at about 235 psi (16.5 kg/sq cm gauge).

"The hot fluid (water) is then used to vaporize the working fluid (freon) of the engine in a heat exchanger; a number of common refrigeration fluids are appropriate for use in the engine loop. The hot, high-pressure, working fluid is then used to drive the expander of the Rankine-cycle engine. For higher-power-output applications (greater than 100 kw), the expander will be a turbine. Lower-power systems can use positive displacement configurations (designs) such as reciprocating (piston) or vane-type expanders. After leaving the expander, the working-fluid vapor is condensed and the liquid is then pumped back into the solar collector heat exchanger, completing the cycle.

"Engine performance calculated on the basis of an expander efficiency of 80 percent and a feedpump efficiency of 80 percent indicates that it is possible to achieve about 65 percent of the ideal Carnot efficiency when the engine is operating in its appropriate temperature range.

"Both focusing and non-focusing collectors can be used as the heat source for organic Rankine-cycle engines. Flat-plate (non-focusing) collectors are used here to illustrate the effect of thermal collector characteristics on overall system performance for the following reasons: Flat plate collectors have the advantage of being capable of effective operation mounted in a fixed position. The collectors and their mounting structure are, therefore, structurally simple--an advantage for use in remote areas. The technology of flat-plate collectors is advancing...(and) organic Rankine-cycle engines

can effectively use the low to moderate temperatures achievable with flat-plate collectors."

The second report on Rankine engines is from an article entitled, "Conversion of Solar into Mechanical or Electrical Energy: Indian Experience." The development and production of solar pumps in the range 1.5 - 4.0 kw (two to five hp.) have received highest priority (in India). The pumps will preferably be in a modular form so that when pumping is not required, the same system can be used to produce equivalent mechanical or electrical energy for minor industrial operations or lighting.

"(Diagram 25) shows the Abhimanyu solar water pump developed by the National Physical Laboratory (NPL, New Delhi, India). Its primary components are a flat-plate collector array and a closed-cycle Rankine-cycle engine. During operation, a heat-transfer fluid (water) flows through the collector array and is heated to a temperature of 80 to 90 degrees centigrade, depending upon the collector efficiency and configuration and the solar flux. This hot water is used to vaporize an organic fluid with a low boiling point (such as freon) in a reverse-flow heat-exchanger (a boiler). The hot, high-pressure organic vapor is then used to drive the expander of the Rankine-cycle engine. After leaving the expander, the vapor is condensed in a condenser, where the water being pumped is used as the heat sink. The condensed organic liquid is pressurized and then pumped back into the boiler with the help of a reinjection feed pump and driven by the shaft of the expander. For some organic fluids, there may also be a regenerator that utilizes exhaust vapor superheat to preheat the fluid coming into the boiler.

DIAGRAM 25: INDIAN SOLAR COLLECTOR AND RANKINE ENGINE

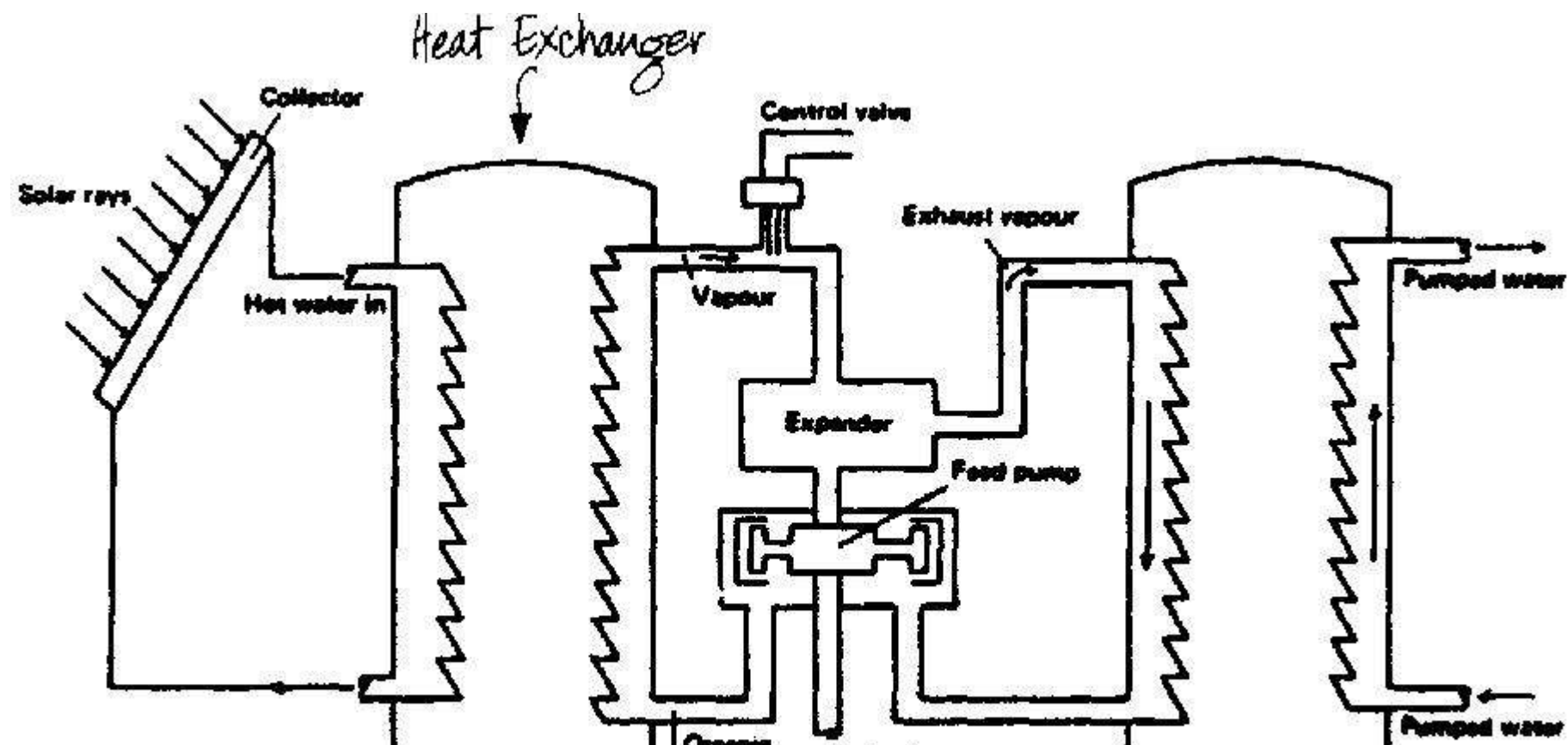

and their mounting structure are, therefore, structurally simple--an advantage for use in remote areas. The technology of flat-plate collectors is advancing...(and) organic Rankine-cycle engines can effectively use the low to moderate temperatures achievable with flat-plate collectors."

The second report on Rankine engines is from an article entitled, "Conversion of Solar into Mechanical or Electrical Energy: Indian Experience." The development and production of solar pumps in the range 1.5 - 4.0 kw (two to five hp.) have received highest priority (in India). The pumps will preferably be in a modular form so that when pumping is not required, the same system can be used to produce equivalent mechanical or electrical energy for minor industrial operations or lighting.

"(Diagram 25) shows the Abhimanyu solar water pump developed by the National Physical Laboratory (NPL, New Delhi, India). Its primary components are a flat-plate collector array and a closed-cycle Rankine-cycle engine. During operation, a heat-transfer fluid (water) flows through the collector array and is heated to a temperature of 80 to 90 degrees centigrade, depending upon the collector efficiency and configuration and the solar flux. This hot water is used to vaporize an organic fluid with a low boiling point (such as freon) in a reverse-flow heat-exchanger (a boiler). The hot, high-pressure organic vapor is then used to drive the expander of the Rankine-cycle engine. After leaving the expander, the vapor is condensed in a condenser, where the water being pumped is used as the heat sink. The condensed organic liquid is pressurized and then pumped back into the boiler with the help of a reinjection feed pump and driven by the shaft of the expander. For some organic fluids, there may also be a regenerator that utilizes exhaust vapor superheat to preheat the fluid coming into the boiler.

DIAGRAM 25: INDIAN SOLAR COLLECTOR AND RANKINE ENGINE

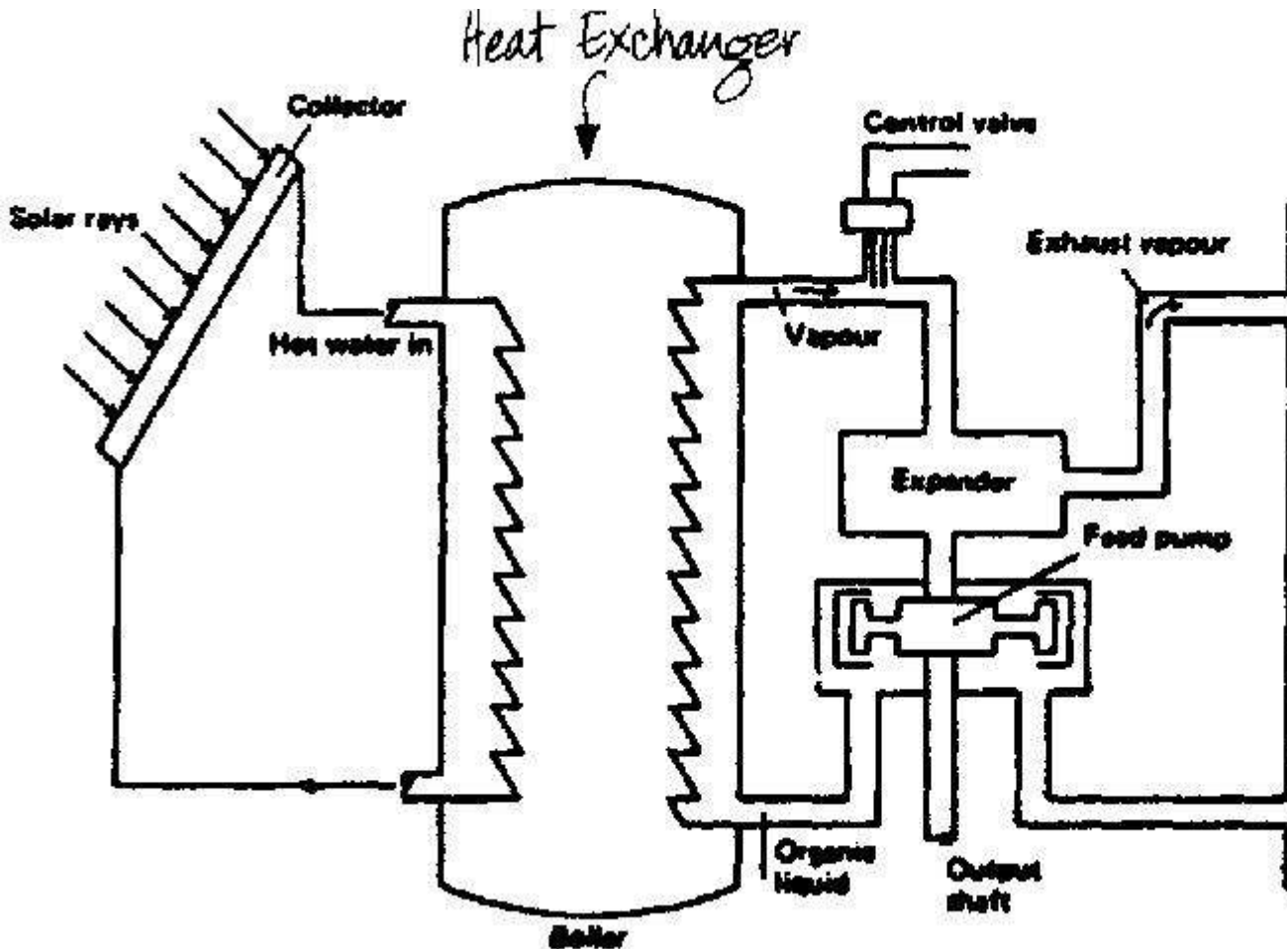

Abhimanyu solar water pump

"The organic Rankine-cycle engine is particularly suitable for solar pumping, power generation, and for waste-heat utilization for several reasons:

- (a) High thermal efficiency (60-70 percent) even when operating with the low to moderate temperatures (80-200 degrees centigrade) achievable with flat-plate collectors;
- (b) Low-cost components owing to the use of commonly available construction materials and simple mechanical components;
- (c) High reliability because of its sealed construction, which protects it from harmful effects of environment such as sand, dust, and moisture;
- (d) No problem with freezing, since the working fluids have very low freezing points;
- (e) Finally, they are adaptable for use over a wide power range from one kw pumping systems to multimegawatt power stations.

"(While) the engine efficiency increases as the collector temperature increases, the collector efficiency decreases on increasing the collector temperature. It is

therefore necessary to determine the temperature range for each collector-engine combination that produces the maximum system efficiency. This optimum system efficiency depends upon several factors such as the insulation, the condenser temperature, and the characteristics of the solar collector array, expander, reinjection feed pump, and working fluid. Nevertheless, it is obvious that the higher the efficiency of the collector array and the higher the temperature it can produce, the higher the system efficiency. It is all the more necessary to optimize the collector assembly in a large-scale power plant because a substantial fraction of the total cost is accounted for by the solar collectors.

"Flat-plate collectors were used in the Abhimanyu pump. The absorber plate is made of aluminium alloy with channels built into it by the pressure-bonding technique (Diagram 21). The complete mechanical design of the collector was optimized.

"Since it is advisable to operate the expander at a constant input temperature, a reservoir is needed to store hot water; the reservoir is connected to the array by means of a thermostatically controlled bypass valve. Under operating conditions nearly one-half of the heat is required to preheat the organic liquid and the other half is used during the process of boiling. Some saving on the collector area requirement can be effected by having one collector array for low temperatures and one for high temperatures. The former is used to provide preheating whereas the latter serves to boil and super-heat the organic vapor."

A few additional points:

(a) If the solar collector is built on a base that can be turned during the day so that the collector always faces the sun, more water will be heated to higher temperatures. The collector could rotate on wheels set along the outer circumference of the base.

(b) Mechanical power uses such as a water pump, thresher, small lathe, or a one kw generator for electrical power can be obtained from one ten-square meter solar collector. A 400-square meter collector array can provide enough power to generate ten kw of electrical power.

(c) The response of turbines to variable loads is poor. Screw and spiral expanders work better with Rankine engines that get their power from flat-plate solar collectors.

(d) The costs of solar collector/Rankine engine combinations compare favorably with diesel engines, especially where the maintenance and repair of diesel engines is a problem.

What follows is a list of people, organizations, and businesses that are working in the field of solar collectors and Rankine-cycle engines. The sources quoted above are listed in the Sources and Resources section of the Appendix.

1. **Professor Redfield Allen, Dept. of Mechanical Engineering, College of Engineering, University of Maryland, College Park, Maryland 20742, U.S.A. He has done research on organic Rankine-cycle engines.**
2. **All-India Solar Energy Working Group, c/o Dr. K. S. Rao, Central Salt and Marine Chemical Research Institute; Bhavnagar, Gujarat, India. Publishes proceedings devoted to the promotion, development, and spread of knowledge in several areas, including solar energy and biogas systems.**
3. **Rolf T. Skrinde, Olympic Associates Company, 1214 John Street, Seattle, Washington 98109, U.S.A.**
4. **Jerry P. Davis, Thermo Electron Corporation, P.O. Box 459, 101 First Ave., Waltham, Massachusetts 02254, U.S.A. Organic Rankine-cycle engines from low-temperature heat sources.**
5. **Ormat Turbines Ltd., New Industrial Area, Szydlowski Road, P.O. Box 68, Yavne, Israel. The company was formed in 1965 to develop, manufacture, and market Rankine-cycle turbine-driven systems for the generation of electrical power. Examples of products include solar-powered turbogenerators and water pumps.**

Plant Shredder

If a biogas digester is going to produce biogas instead of a scum layer when it tries to digest plants, the plants have to be properly prepared; and that can mean time and money. How can plants be used without the costs being higher than the profits?

The simplest way is to feed the plants to animals and then feed the animals' manure to the digester. The animals best suited to do this are the ones with double stomachs, the cud chewers (ruminants): cattle, cows, sheep, goats, water buffalo (carabao), and horses. Cud-chewers have digestive systems especially designed for breaking down plants.

If there are not enough cud-chewers or other animals available, the plants have to be partly composted before they can go into the digester. For the partial composting to be effective, as much plant surface area as possible must be exposed; that is where shredding, grinding, and pulping of plants becomes important.

Still the question remains; how can plants (and if possible the plant fibers in manure) be shredded, ground, or pulped in a way that does not cost more than it is worth? The method or methods must be low-cost in time and money, and they must be easy to build and operate. One good choice is the use of simple machines powered by bicycles (pedal power). Another possible source of power is

mechanical power from the biogas system's stationary engine.

Both VITA and the Appropriate Technology Sourcebook, Volumes I and II, have lots of information on using bicycles to power simple machines such as lathes, threshers, washing machines, saws, pumps, and generators. But no designs were found that could easily be used to prepare plant leaves and stalks for biogas digesters. It can be done; it may have already been done, but reports on the work have not yet found their way into the mainstream of appropriate technology literature.

People interested in finding low-cost, easy ways to prepare plants for biogas digesters should get a good pedal-power manual and adapt the information to preparing plants for digesters. After the plants are finely ground, they will still need several days of partial composting in order to begin the rotting process that breaks down the walls of plant cells. Then when the plants are in a digester, they will, like manure, produce lots of biogas and very little scum,

Solids Separator

It would be very useful if large plant fibers could be easily separated from the liquids before slurry went into digesters. Solids in slurry made from plants are not the only problem. There is also a lot of undigested plant matter in most manure. If separated, the solids could be ground up so that they could not form a scum layer in the digester. The biogas bacteria could digest a higher percentage of the organic matter with an end result of higher biogas production rates.

It would also be very useful if the solids could be easily separated from the liquids in the sludge taken out of the digester. It would then be easier to dry (and bag if so desired) the solid sludge for use as fertilizer and to use the liquid sludge as fertilizer for fish ponds and crops or as the liquid portion of new slurry.

Both these things can be done now, and this book has many suggestions on how to do them. But none of the methods for separating solids from liquids is at the same time: low-cost, efficient, easy to build, simple to operate, and not very time consuming.

The principle of the centrifuge (Diagram 26) offers the possibility of an ideal way to separate the solids from the liquids in slurry and sludge. A centrifuge is a machine that spins fluids at high speeds to separate matter of different densities. Powered by a bicycle or the mechanical power of a biogas-fueled stationary engine, a simple centrifuge could quickly separate solids from liquids.

The big question is what does a simple, practical centrifuge design look like? Then there are the other important questions: How much would it cost? Would it need a pump? What is the smallest size digester that a centrifuge would be practical to use with? And so on.

VITA has a US\$ 1.00, seven page booklet entitled, Centrifugal Honey Extractor. It might have enough information about centrifuges to make designing one for separating the solids from the liquids in biogas slurry and sludge possible. The VITA description of the booklet says, "Made of wood, this is an easy-to-build, simple-to-operate method of extracting honey from a comb."

DIAGRAM 26

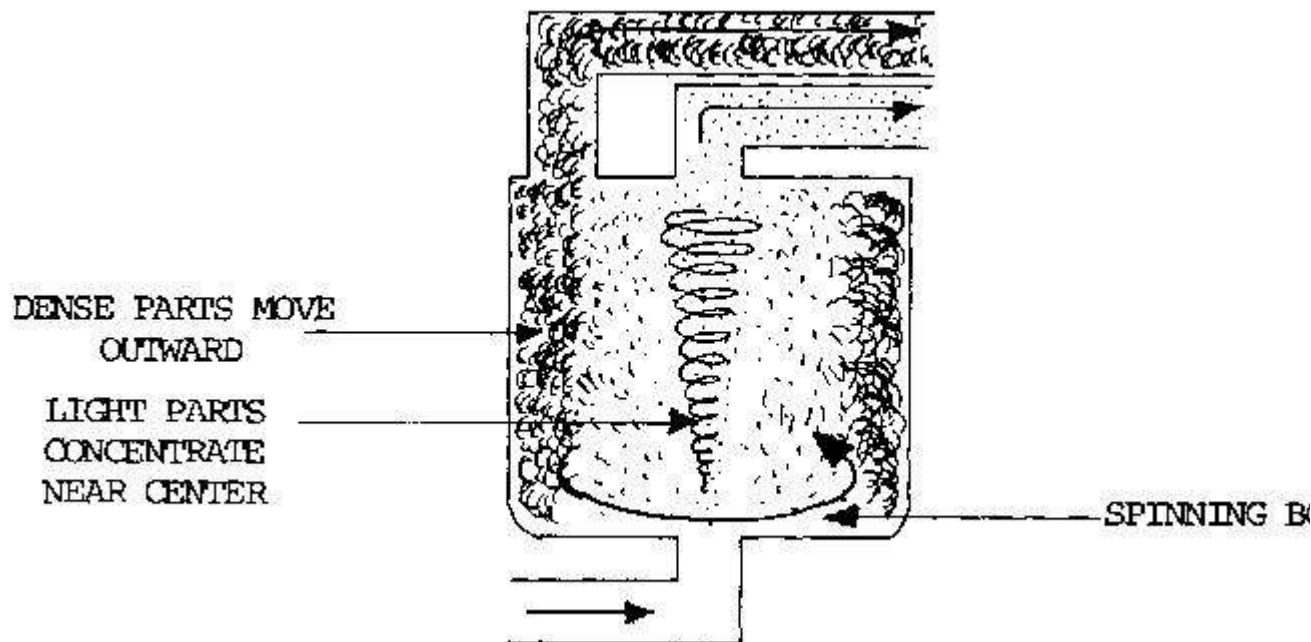

PRINCIPLE OF THE CENTRIFUGE

Composting

Partial composting (seven to ten days) can be used to prepare ground-up plants for biogas digesters. Complete composting (three to six weeks) can be used to make a solid organic fertilizer. With composting there is no methane gas, and compost does not have as much nitrogen as biogas sludge made from the same organic waste would. With compost the fertilizer is a solid, while 90 percent of the fertilizer from biogas digesters is a liquid. What follows is a method of composting adapted from the Filipino handbook, The Samka Guide to Homesite Farming.

When organic waste is composted, it becomes a biofertilizer that was made by organic waste rotting in air. When organic waste is digested in a biogas digester, it becomes a biofertilizer that was made by rotting where there was no air. Both types of fertilizer are very useful. The method that is chosen depends on local resources and needs.

The old method of making compost fertilizer is to pile plant wastes on the ground until the pile is 30 centimeters (1.0 foot) high, then to add animal manure. Ashes and lime are sprinkled on top of the manure. Another layer of plant waste is added, then more manure and lime, and in this way alternating layers are built

VITA has a US\$ 1.00, seven page booklet entitled, Centrifugal Honey Extractor. It might have enough information about centrifuges to make designing one for separating the solids from the liquids in biogas slurry and sludge possible. The VITA description of the booklet says, "Made of wood, this is an easy-to-build, simple-to-operate method of extracting honey from a comb."

DIAGRAM 26

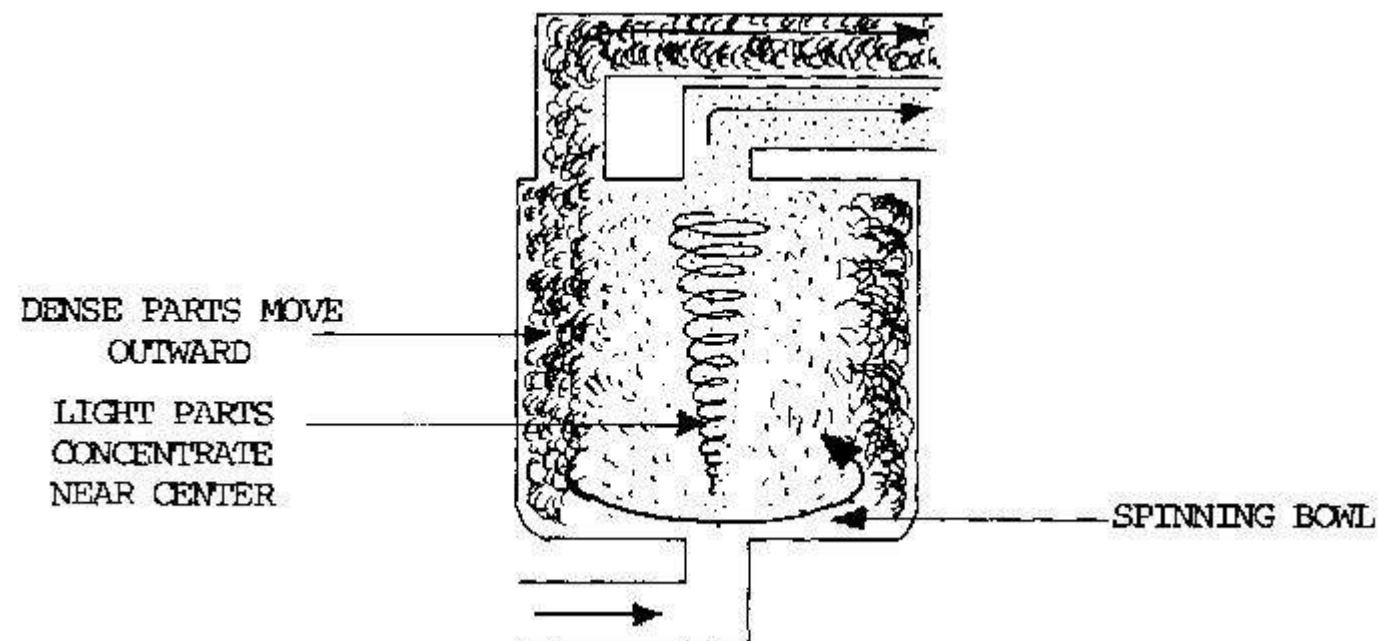

PRINCIPLE OF THE CENTRIFUGE

Composting

Partial composting (seven to ten days) can be used to prepare ground-up plants for biogas digesters. Complete composting (three to six weeks) can be used to make a solid organic fertilizer. With composting there is no methane gas, and compost does not have as much nitrogen as biogas sludge made from the same organic waste would. With compost the fertilizer is a solid, while 90 percent of the fertilizer from biogas digesters is a liquid. What follows is a method of composting adapted from the Filipino handbook, The Samka Guide to Homesite Farming.

When organic waste is composted, it becomes a biofertilizer that was made by organic waste rotting in air. When organic waste is digested in a biogas digester, it becomes a biofertilizer that was made by rotting where there was no air. Both types of fertilizer are very useful. The method that is chosen depends on local resources and needs.

The old method of making compost fertilizer is to pile plant wastes on the ground until the pile is 30 centimeters (1.0 foot) high, then to add animal manure. Ashes and lime are sprinkled on top of the manure. Another layer of plant waste is added, then more manure and lime, and in this way

up until the pile is about 1.5 meters (5.0 feet) high, wide, and long.

The compost pile is kept moist, but not wet or flooded with water. Most farmers cover their compost with a grass or banana leaf roof in the rainy season so it will not get too wet. In about three months the compost pile shrinks to about one tenth of its original size and has become a rich organic fertilizer which can be spaded into garden planting beds or plowed into field.

Now there is a better way to change organic wastes into rich organic fertilizer. Instead of waiting three months, compost fertilizer can be made in three weeks. And it will be a better fertilizer! The secrets of this quick process are as follows:

The first secret is to use plenty of organic waste that is high in nitrogen to add to the compost mixture, such as urine, fish and meat scraps, algae, and manure (see Facts and Figures section of Appendix). Most plant and crop wastes are high in fiber which means they are also high in carbon and will need lots of nitrogen to help them rot. Scientists call this the carbon/nitrogen ratio. It has been found that the best compost mixture is about 30 parts carbon to every one part nitrogen (C/N 30).

When a good mixture of organic matter has been collected, chop the plants into small pieces, 3.0 to 5.0 cm (1.0 to 2.0 inches) long, to speed up the rotting (decay) process. The rotting process is faster when there is more plant surface area exposed to moisture and air. The more pieces a plant is cut into, the greater the exposed surface area will be. If the plants can be ground, shredded, or pulped, the quality of the compost will be even higher. On a small farm there is no way to be sure of getting the right mix of carbon and nitrogen except by trying different combinations and observing the results. It is better to have too much nitrogen than too little.

DIAGRAM 27

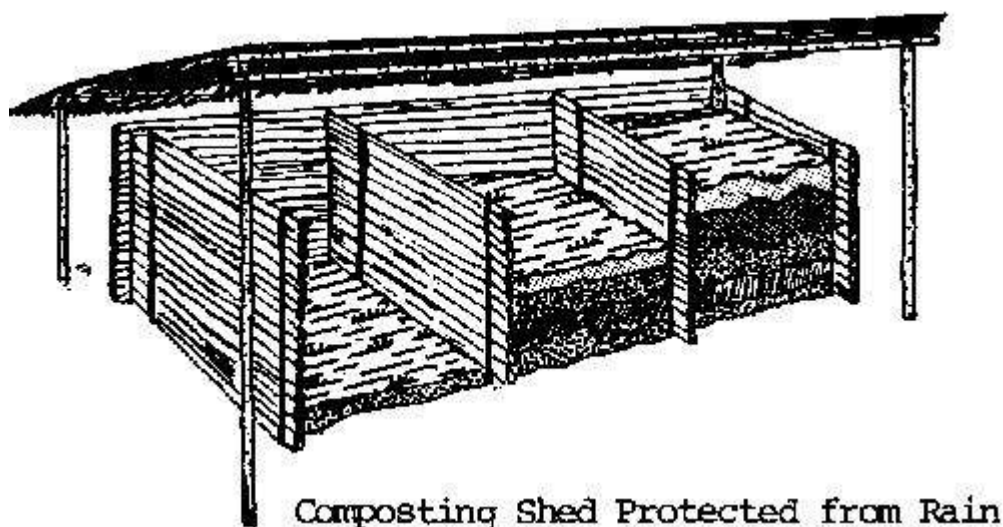

COMPOSTING

-From the Samaka Guide to Homesite Farming

COMPOSTING B.

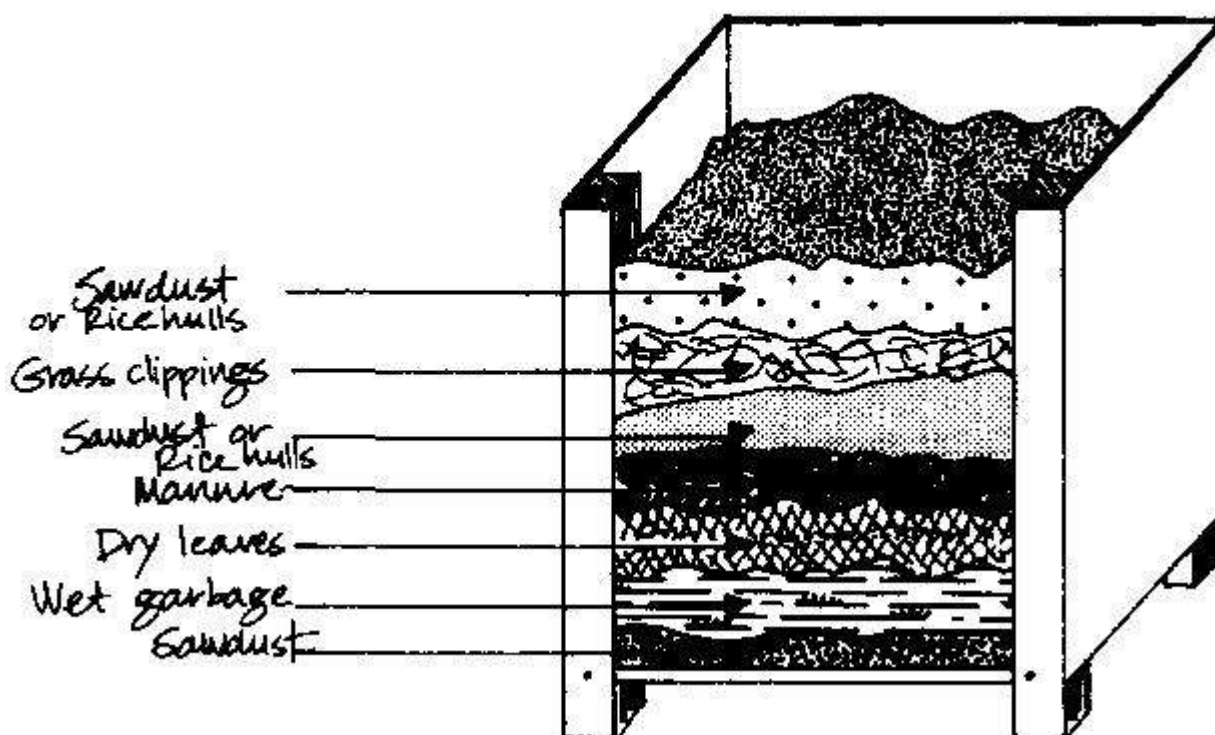

COMPOSTING BIN

-Build your compost pile with alternating layers of fresh materials, dry matter, and manure.

All plant waste should be composted for four to seven days before being put in a biogas digester. If the plants are to be completely rotted, they must be composted for three to five weeks. The shorter times are for hot weather, and the longer times are for cold weather.

If there is not enough plant or animal waste with high nitrogen content, add chemical fertilizers containing nitrogen to the compost. This has three advantages.

- It will help the compost materials change quickly to organic fertilizer.
- It will make the chemical fertilizer into a better fertilizer which will be easier for plants to take up and digest.
- It will help prevent the nitrogen in the chemical fertilizer from evaporating or being washed away by the rain.

The second secret is to turn the compost pile every few days.

- **If the right compost mixture is used, the pile will get very hot in the center.**
- **If it stays too hot too long, it will begin to smell bad and the pile will become dry.**
- **The solution is to push a bamboo stick into the center of the pile and pull it out after three minutes.**
- **If the stick is very hot, turn the pile. e If the stick smells bad, turn the pile.**
- **If the stick is dry, turn the pile.**

The third secret is to keep the compost pile moist, but not wet, something like a wet rag out of which the water has been squeezed.

- **The hot temperature in the compost pile causes much of the water to evaporate as steam.**
- **So every time the pile is turned, sprinkle water or sludge from a biogas digester on the compost to keep it moist. e If the pile is turned often and kept moist, it will smell sweet.**
- **If it smells bad, it is because the pile was not turned often enough. The bad smell is the smell of valuable nitrogen fertilizer escaping into the air.**

To turn a compost pile, first gather the material from the outside of the old pile and place it in the center of the new pile. Being dry, it will need more water. Then take the material from the inside of the old pile and place it on the top and sides of the new pile. In this way, every time the pile is turned, the mixture alternates its position from inside to outside and from outside to inside.

A successful compost pile needs three things: a good mixture of organic materials broken up into very small pieces with enough high nitrogen content waste, the right amount of water or biogas sludge, and plenty of air.

If farm animals are kept in pens, the floors of the pens should be made of concrete so that channels and holes can be made to guide the manure and urine to holding areas where the wastes can be easily added to compost piles. The holding areas can be filled with shredded straw and leaves to absorb the urine and begin the rotting process.

For thousands of years people have used animal manure, ash, and plant wastes to restore to the soil the elements that plants need to grow strong and healthy. Plants take certain substances from the soil in order to grow. These substances are food for the plants. They are just as necessary to plants as rice, corn, meat, fish, and vegetables are to people.

When a family's rice sack is empty, the rice must be replaced or else they will starve. The same is true for plants; the farmer must return to the soil the substances that are taken from it when a crop is harvested or the next crop will starve. About 100 years ago scientists began to study what was in the soil that gave food to the plants through their roots. Today three elements are believed essential to all plant food. These three elements are: nitrogen (N), phosphorus (P), and potassium (K). There are secondary elements in addition to these three which are needed in small amounts, but which must be present in the soil to make healthy plants. They are: calcium, magnesium, sulfur, boron, iron, manganese, copper, zinc, molybdenum, and cobalt.

In fertile soil all of these elements are present in the correct amounts so crops grow well and harvests are big. Poor soil does not have enough of some of these plant foods so the plants are not healthy and harvests are small. Plant food can be made in factories and put into the soil to supply what is lacking or to replace what has been taken from the soil by harvested crops. Today, farmers all over the world are using manufactured chemical fertilizers to increase the yields of their crops. It has been found that fertilizers can increase the value of crops by as much as ten times the cost of the fertilizer. It is often said that "fertilizers pay; they do not cost."

The kind of fertilizer that should be used depends on two things: what kind of crop is to be planted and what the soil lacks that is needed in order to make that crop grow well.

When there is not enough nitrogen in the soil:

- 1) The plants have light green or yellowish leaves.**
- 2) The plants do not grow big and they grow slowly.**
- 3) The plants have stalks which are thin and stiff.**
- 4) The plants have leaves which form a small angle with the stem.**

When there is not enough phosphorus in the soil:

- 1) The plants are thin and short.**
- 2) Beans have dark green or bluish color, like the leaves of plants during a long dry season.**
- 3) The stems and leaves of corn and some vegetables become purple in color.**
- 4) Grains are thin and light in weight.**

When there is not enough potassium in the soil:

- 1) The leaves die along the edges. In bean leaves, gray spotted half circles form on the edge of the leaves.**
- 2) The stems are weak and brittle.**
- 3) Growth is slow.**
- 4) Grains are thin and light in weight.**

Leafy vegetables such as lettuce, cabbage, and mustard need more nitrogen the phosphorus or potassium . A complete fertilizer containing the three major elements should be used before planting. The fertilizer should be mixed very well with the soil. After two weeks if the leaves of the plants are not dark green in color, add fertilizer containing only nitrogen to the soil.

Plants which have fruits and seeds such as corn, mango, tomato, peanuts, string beans, potatoes, cucumbers, papayas, bananas, pineapples, peppers, and squash need as much phosphorus and potassium as they need nitrogen.

The appearance of the plants will tell when there is a serious lack of a fertilizer element. When in doubt as to what fertilizer element is lacking, the best thing to do is to use a complete fertilizer.

It is not only fertilizer which plants need. Plant food must be "seasoned." It must be prepared correctly, and it must be mixed with water. When people put salt and sugar on food, it makes the juices of the mouth and stomach come out in large quantities. Without these juices, the food we eat will not nourish us. If soil is too sour (too acid), plant food cannot be completely digested by the plants. In such cases, add seasoning by mixing fine powdered lime into the soil at least two weeks before planting. This will help the plants in absorbing and digesting the fertilizer. Finally, water is needed to dissolve the fertilizer and lime, so that the roots of the plants can take up the nutritional elements.

Always remember that chemical fertilizers work best when used only as a supplement to organic fertilizers. The more organic material that is mixed with chemical fertilizers, the better it will be for the plants and for the continued fertility of the soil. A large percentage of expensive chemical fertilizers can be washed out of fields by rain and evaporated into the air. If chemical fertilizers are mixed with organic fertilizers, the soil will be able to hold more of the nutrients from being washed away or evaporated.

Organic fertilizers, which add humus (decayed plant matter) to the soil, are necessary to profitable farming and to successful home gardening. Chemical fertilizers can be a valuable supplement if there is not enough organic fertilizer. When chemical fertilizers are used: mix them with compost first and make it into an enriched organic fertilizer--this will benefit the crops, the soil, and it will

reduce costs to the farmer.

What follows is another way to profit from plant wastes. It will not directly help biogas systems, but it should be of help to farmers who have plant wastes. This method is especially good for crop wastes, such as straw from grain crops.

Crop waste can be:

- 1) Composted for a week until the fibers are broken down enough to be used in a biogas digester.**
- 2) Composted for a month and used as compost fertilizer.**
- 3) Composted by the following method which is adapted from an article by Art Bell in the magazine, "Peace Corps/Philippines" of December, 1979.**

In order to clear fields, crop wastes are often burned. Every time plants are burned, nitrogen and other fertilizer compounds are wasted that the crops need.

Nitrogen is energy--plant energy; to burn it is to lose that energy. It is like burning fertilizer instead of spreading it on the fields. Using all of a field's crop wastes as fertilizer for future crops, returns approximately 25 percent of the nitrogen, 40 percent of the phosphorus, and 75 percent of the potassium, along with the humus which holds the soil together, and stops erosion.

In order to understand how to make use of plant energy, the situation of the rice farmer can be used as an example. The rice is harvested, threshed, the grain is sacked, and now the fields are covered with six-inch strands of rice stubble, and there are large piles of rice straw. The rice straw is often burned, a process that burns up thousands of pesos of plant nutrients.

If this stubble and straw is plowed under, what would happen? How could this waste be made to rot, to decompose fast enough and completely enough so that another crop could be plants in two to three weeks? In nature there is what is called a carbon/nitrogen ratio which must be kept in balance for normal plant growth to occur. This is just a scientific way of saying that energy for breaking down plant and animal matter, which is usually carbon, comes from nitrogen. This decay process is carried out by bacteria working on the carbon materials, and the size of the bacteria populations increase in proportion to the amount of nitrogen that is present in their surroundings.

Plowing under a large amount of plant waste, such as rice stubble and straw, calls upon the soil to supply a large amount of nitrogen for the bacterial decay of all this plant material. This process is the first priority. Plants growing in the soil will be starved for nitrogen as long as there are high levels of carbon plant matter left to be decayed by the bacteria.

To offset this nitrogen starvation and speed up the decomposition process, a nitrogen fertilizer such as sulphate of ammonia or urea is added. What this means is that the farmer can subtract this from the basic fertilizer application for the next crop. In practice, many farmers still use their normal fertilizers, and the added nitrogen plus the increased organic matter produces crops with much higher yields.

Normally, broadcasting (scattering) 30 kilograms of nitrogen per hectare (three bags sulphate of ammonia or one and a half bags of urea per hectare), followed by plowing under the crop wastes; and if the soil is not very moist, a light irrigation is all that is needed to break down the plants.

It should be pointed out that this nitrogen cannot be lost by leaching from the soil because it is captured and held within the bacterial cells that are decaying the plants. When the last of the plant matter is broken down into basic organic plant nutrients, the bacteria die and the nitrogen inside their cell bodies becomes available for new plants as nutritional nitrogen and other plant nutrients.

The time required for this decomposition process is only two to three weeks. It should be noted that this process is the same for all crops, whether they are cereal grains such as rice and wheat, or crops such as corn, cotton, or vegetables. For very woody-stemmed crops like cotton, pull the plants up and chop or grind them into six inch or smaller pieces. Spray the chopped-up plants with a water solution of sulphate of ammonia or urea, which will supply the 30 kilograms of nitrogen per hectare. Then immediately plow the plants under and if the soil is not very moist, follow with a light irrigation. Again, all this crop waste will be decomposed and part of the soil within the same two to three weeks as with the lighter, less woody crop wastes.

This is a simple process which takes a little work and a little time. Who knows, maybe some enterprising person can put together a well-paying business, making fertilizer out of all the plant wastes that are being dumped or burned.

Bioinsecticides

Bioinsecticides do not come out of biogas digesters, but there is a strong connection between the products of biogas digesters and bioinsecticides.

Bioinsecticides, like biogas and biofertilizers, can be made and used by the people who need them, at a low cost, using local resources. Two of the most important products that farmers use to increase crop production are fertilizers to help plants grow and insecticides to protect the plants from insects.

Bioinsecticides are one weapon in a battle plan of pest control called integrated pest management (IPM). The IPM battle plan has fewer risks and lower costs than total dependency on chemical poison pest control. Groups such as the Peace Corps, Volunteers in Asia, and VITA can provide information on integrated pest

management battle strategies and tactics.

A low-cost, safe, and easy-to-use insecticide is what this section is all about, just as low-cost, high-quality fertilizers are one of the main subjects of this book. This bioinsecticide information is adapted from four articles written by Jeff Cox (October, 1976; May, 1977; April, 1978; July, 1979) and one article written by Michael Lafavore (August, 1978) for the "Organic Gardening and Farming" magazine.

From the October, 1976, Article

Frank Batey grows peanuts and soy beans in bug-ridden Archer, Florida. For years he and his father used the chemical insecticides guthion, toxaphene, sevin, methyl parathion, and other insecticides to kill the fierce semitropical insects that would otherwise have destroyed their crops. Today, Batey's fields are crawling with insects, but his crops suffer only minor, unimportant damage. So far he has saved US\$ 5,000 in insecticide costs. Best of all, he says, "I do not have to breathe that peanut poison anymore."

Mike Sipe, a pest-control specialist, suggested a simple method of controlling insects to Mr. Batey.

- Go into the fields and collect a cup or two of the insects that are damaging the crops.**
- Grind up the insects in a blender with some rain water, strain out the solids, and add more water.**
- Put the solution in an ordinary sprayer, and spray the crops that the insects were found on.**

So effective has this method been for over two years that in 1976, the third year, Mr. Batey did not even have to spray the bug juice insecticide on his fields.

"We had cabbage looper, stink bug, army worm, velvet bean caterpillar, granular cutworm, southern corn borer, and other pests on our crops," Batey says. "I collected samples of all of them, except for the southern corn borer, which makes a webbed tunnel underground and attacks the pegs of peanuts. It is Just too difficult to find enough of them to make a spray. But on the other pests, the method did a great Job. I am not against using chemicals to help grow food crops, but I hate insecticides and always have. We should not be eating food with these poisons on them. It is important to have good, clean food."

Batey told of a farmer who lives near him. "Last year he used so much insecticide that his peanuts almost died. He came over and looked at our crop. There were ants, earwigs, and beetles crawling around on the ground and on the plants, but none of the major pests. He did not understand what was happening." Batey says

his neighbors do not like to experiment with new methods, and so he has not told them about the bug juice method yet. "They would think it is crazy. But I can prove it works. I know it works."

It seems most likely that the bioinsecticides kill insects by spreading diseases that can kill insects. Batey farms 74 acres (29 hectares) of his own land and he sharecrops neighbor Bill Matthew's 39 acres (16 hectares) allotment. "I told Bill that we were going to use the bug Juice to combat insects on his land, and he thought I was crazy. When I sprayed the bug juice on the crops, he thought it was very funny. But in three or four days most of the worms were hanging dead from the leaves or lay dead in the rows. Bill had the worst insect problem I had ever seen, but the bug Juice method took care of it." Batey also farms 100 acres (40 hectares) of soy beans and uses the bioinsecticide spray effectively on that crop, too.

A handful of insects should be enough to spray a large garden. But Mike Sipe has a few important warnings: "In most cases where insects are only doing a little damage, it is best to do nothing. There must be pests for pest-eating insects, lizards, frogs, and birds to eat. When there are too many pests and a crop is threatened, use the bug juice method. It should reduce the pest populations to a safe level but allow enough pests to survive to support a population of the enemies of the pests. Also, make sure that you are collecting only those pests that are threatening to destroy the crops. If you gather harmless insects or insects that eat other insects, you will be upsetting the natural insect controls."

To make sure you have found the real pests, study the plants very closely and watch for the insects that feed on leaves or fruit. If any insect is parasitized (has tiny cottony cocoons of insect-eating insects on its back), do not take it; or you will be making a spray that could kill insects that eat insects.

The results from Alachua County in Florida, a hot weather area where crops are grown all year, are encouraging. Batey's peanut production was 5,251 to 5,351 pounds per acre (6,000 kilograms per hectare) in 1974--a very large harvest that won him the local County Peanut Production Award. Minor insect pest damage had a part in making that record. The average production in Alachua County is between 2,000 and 3,000 pounds per acre (2,200 to 3,300 kilograms per hectare). Batey's chemical insecticide costs were about US\$ 2,000 per year, so over the three years that he has been using the bug juice bioinsecticides, he has saved more than US\$ 5,000.

From the May, 1977, Article

Safe insect control has always been a goal of farmers, but what is safe for people, is often safe for bugs; and what is dangerous for insects, is often dangerous for people. **Is there then, any danger to people from the bug juice bioinsecticide method?**

The following comments are from quotes by several plant scientists:

- **"The method is definitely safe, but I would still use caution in applying the bug juice. I would rather see people use as little as possible to control insect problems. If all of a pest insect population is killed in an area, the insect's natural enemies might die out too..."**
- **"I have been working in this area for eight years, and I do not think there is any danger. The only danger I can see is that if the bug juice method does not work, the farmer may never try biological control methods again..."**
- **"Most people who have worked with insect pathogens (organisms that cause disease) feel that they are safe..."**
- **"Californians have been using a modified bug juice method for 25 years, collecting sick insects and grinding them up to make a bug juice spray...these insect pathogens are very effective, but this is the first time that using healthy insects has been recommended..."**
- **"He applied it to his okra (a vegetable), which was infested with five different kinds of caterpillars and army worms. It killed all the caterpillars and worms. I did not believe it at the time and told him I thought he had forgotten to clean the chemical insecticide out of the spray equipment he has used. But he insisted he had cleaned the sprayer..."**
- **"The use of insect disease successfully and completely controlled the bug problem in a Malaysian rubber plantation."**

It seems that the use of bug juice bioinsecticide is safe, according to the scientists we talked to. One said, "If these insect diseases were transmissible, farm animals and farmers everywhere would have been made sick by them many, many years ago." U.S. Department of Agriculture studies have shown that insect viruses (diseases) of common pest insects reproduce themselves only in specific insects.

(According to World Health Organization figures, chemical pesticides poison 500,000 people annually, killing 5,000 people; and most of the victims are in the Third World. Companies regularly sell pesticides in the Third World that are banned in North America and Western Europe because the chemical poisons are too dangerous.)

The following are adapted excerpts from some of the hundreds of letters "Organic Gardening and Farming" magazine received after the October, 1976, report on the bug juice method.

"I had scale infection on my plants, so I scraped, with difficulty, about a teaspoon of scale into my blender, added water; and after blending, I diluted the mixture with more water and sprayed the solution on the plants. For three days I did not

mention my experiment to anyone. When I told my husband and we went to inspect, I was very happy. A shake of a branch or a push on a pile of scale caused the scale to fall off. Scale, I have read, does not fall off. I guess the remains on the plants are as dead as the scale I shook off. The insect-eating praying mantis bug that lived on one plant was not harmed by the bug juice spray, which would have been true with a chemical poison..."

"I noticed my Chinese celery cabbage beginning to wilt. I pulled one up and found most of the roots badly eaten by some kind of white maggot (wormlike larva of a fly) and by wireworms. There were also slugs on the leaves. I collected some of the slugs, maggots, and worms, blended them with a cup of water and poured (not sprayed) a diluted mixture on the plants very slowly, so that the bug juice ran off the leaves and down around the roots. There was no more wilting, but after heavy rains a week later, the maggots started to come back. Maybe the rains reduced the effectiveness of the bug juice over time. But I believe the method worked very well."

Do not use the bug juice method against ticks, fleas, mosquitoes, or other insects that attack people, because these insects can carry human disease. The diseases of plant-eating insects are everywhere in the world. They are all over the leafy vegetables that we eat, and we have been constantly exposed to them for millions of years on the foods we eat and in the gardens and fields we work in. If plant insect diseases could make us sick, we would have them by now.

The most important part of making bug juice is the collection of enough pest insects to increase the chances in favor of spreading an inactive insect disease. The amount collected in weight is not as important as the number collected. For example: if 300 insects are collected and only one tenth of the blender concentrate is used to make a dilute solution, success will be ten times more likely than if only 30 insects are collected and all of the concentrate is used to make the dilute solution.

The reason for this is: even if there is only one sick insect in a batch, its disease will be spread throughout the dilute solution. That one sick insect can be the source of 1,000,000,000 (one billion) virus spores (a "disease seed"). This means that when those virus spores are spread evenly over the leaves of a plant, almost all of the insects will eat some spores. Many of these insects will be killed by the virus. Each pest killed in this way will provide many more virus spores in the weeks to come.

If any pest insects look weak or are moving slowly, they may be sick and should definitely be used to make a bug spray. Three or four days after a solution has been sprayed on the plants, look for dying pests. These insects should be collected and stored in a jar in a freezer or dried slowly at about 38 degrees centigrade (100 F) for four to five hours and then stored in an airtight container until needed. These stored insect pests can be saved until the next crop or shared with a friend who is having trouble with the same pest.

Do not expect to control one kind of insect by grinding up and using another kind of insect in a spray. Each insect carries diseases that harm no other kind of insect. Only a few kinds of insects can be killed by diseases that affect other, even closely related, insects. Do not expect to control aphids with ground up corn earworms.

If ground up bugs are saved for use at another time, keep some record of what insects went into the bug juice solution. A simple way to do this is to place two or three of each kind of insect in a jar of 70 percent isopropyl alcohol (rubbing alcohol). Label the jar as to when the insects were collected, off of what kind of plants they were collected, and how many of each kind of insect was used in making the bug juice concentrate.

If the pest shows up again, the insects on the crops can be compared with the ones in the bottle of rubbing alcohol. The insects in the alcohol cannot be used in a bug juice spray; they are for identification purposes only. Only the dried or frozen concentrate can be used to make a dilute solution for spraying. Pest insects in jars of rubbing alcohol would be a good way for stores that sell bug juice bioinsecticides to advertise which insects they have frozen bug juice concentrate for.

The following precautions are based on the idea that too much safety is better than too little safety. Wash your hands after handling the insects. Use drinking quality water to dilute the concentrate. Sterilize a blender after using it to grind insects by placing the non-electric blender parts in boiling water for 15 minutes after they have been cleaned. Do not breathe the spray. Wash fruits and vegetables before eating them if the spray has been used recently. These precautions should be followed much more carefully when chemical insecticides are used.

From the April, 1978, Article

The bug juice method of insect control proved its worth last summer, according to reports from "Organic Gardening and Farming" readers and newspaper accounts from around the country. The bioinsecticide method was successfully used on an 80 hectare (200 acre) peanut and soy bean farm in Florida, when first reported in this magazine's October, 1976, issue. Now there are reports from many areas of the country saying that it works.

Two letters were received saying that it did not work. One man tried it on grasshoppers, and a woman tried it on Japanese beetles, both without success. The bug juice also failed to kill Japanese beetles on grapevines when "Organic Gardening and Farming" staff tried it, but the bioinsecticide did clear up infestations of aphids on corn. (Other scientifically controlled experiments have been very successful in killing Japanese beetle grubs with a bug juice insecticide. The scientists made sure that the grubs they used were sick with milky spore disease.)

Warning: There are some plant diseases, such as the rice plant virus called tungro in the Philippines, which are carried from plant to plant by insects, in the case of tungro by leafhoppers. Do not use the bug juice method if the crop is sick with a plant disease. Using the bug juice could spread the plant disease. Use the following plant juice method when plants are being eaten by insects and may also have a plant disease.

Sprays that spread insect diseases may not be the only effective biological blender spray. The magazine "Soil News" from September, 1977, reports that blending weeds that insects will not eat and then spraying a diluted solution on crops that insects love to eat is an effective way of protecting crops. Plants that insects refuse to eat contain distasteful substances that when sprayed on tasty crops, makes the tasty crops just as impossible for the bugs to eat as are the never-eaten weeds.

One letter writer said he collected the leaves from plants that insects never seem to eat, ground them up, made a tea with water from the solution, and sprayed it on his garden. "When I checked the garden a few days later, I swear I could not find a moth, bug, or worm of any kind under the leaves, on top of the leaves, or on the ground. The bugs had said ugh and silently crawled away."

Find weeds and tree leaves that insects never eat, as indicated by a lack of holes in the leaves.

- Grind them up in a blender with a little water, add some more room temperature water, not hot water, and let the solution sit for 24 hours.
- Then strain, dilute, and use as a spray on vegetables and other crops.
- Do not cook the solution, let the ground-up leaves just soak in water like a tea for a day before straining, diluting, and spraying.
- Do not dilute the solution more than five times the original volume.
- Smooth leaves are more likely to have chemicals that taste bad to insects than "hairy" leaves because hairy leaves repel insects mechanically.
- Choose plants like pines, poplars, and herbs that are not poisonous, yet contain volatile oils.

It is very possible that whatever insects do not like about one plant might make them hate another, different type of plant, if by using a spray made from the first plant, the second plant can be made to taste like the first plant.

There have also been reports that using a plant juice solution made from weeds might stop the growth of more weeds of the same type. There is very little information on this idea of killing a weed by spraying it with a "tea" made from

its own kind. It may not work, but it is worth experimenting with.

One plant spray that has met with success is the hot pepper spray made from grinding up hot peppers and diluting the concentrate with water. There are reports of hot pepper spray stopping rats, mice, and some kinds of insects from eating plants. From Papua, New Guinea, comes the suggestion to add a little liquid or powdered soap to the solution (make sure it dissolves). The soap will help the pepper spray stick to the leaves.

From the July, 1979, Article

The bug juice method works successfully on over 20 pest insects, including: cabbage loopers, grape skeletonizers, stink bugs, armyworms, velvet bean caterpillars, granular cutworms, ants, slugs, fungus gnats, sawfly worms, aphids, wireworms, striped potato beetles, and several types of caterpillars.

The Center for Tropical Agronomy in Turrialba, Costa Rica, reported that insect populations in bean plots sprayed with bug juice were very low (one or two insects per 12 foot row), while the untreated plots had normal insect populations (four or five insects per plant). There was a need for once a week reapplication until pest levels decreased permanently.

The bug juice method is not totally understood yet. Sometimes it does not work as well as was hoped. Sometimes it does not work at all. One scientifically controlled study showed that cutworm bug juice, which has worked successfully many times, actually attracted cutworms. (Maybe the insects were collected during their mating season and were releasing chemicals meant to attract others of their kind. When the bug juice spray was made, these chemicals naturally enough ended up in the solution.)

The usual difference between success and failure with bug juice is whether or not any sick insects are used in making the solution, It is not always easy to see if an insect is sick, so all pest insects of the kinds wanted should be collected, in hopes that some of them will be sick.

More information on the "plant" juice spray: Certain chemicals in plants may serve as barriers to plant-eating insects. If those chemicals are put into a solution and sprayed on crops, the bugs will look elsewhere for food.

The neem tree of India is reported to have a taste that insects hate to eat, and some pine tree needles contain chemicals that can kill houseflies, codling moths, and apple moths.

Healthy plants in a healthy soil will attract few insect pests. More insecticides are needed to control insects when a crop has been given too little or too much fertilizer. A balance of plant nutrients in the soil grows plants that are resistant to insects, just as people who eat well do not get sick as often as people who do not

eat well. Rotate crops, use biofertilizers and chemical fertilizers wisely, and less insecticide of any kind will be needed (August, 1980).

From the August, 1981, Article

The history of organic pest control is one of trial and error, success and failure. Gardeners and farmers have planted aromatic herbs and flowers to ward off bugs. They have planted several different vegetables in the same plot to confuse insects. They have tried to disguise their vegetables with sprays made from plants which bugs seem to avoid. They try to kill insects with sprays made from grinding up the insects themselves. Sometimes these measure work, and sometimes they do not work.

Do not let the fact that all attempts have not met with success stop you from trying. Try several small-scale experiments of the methods described here. Ideas that do not work can be easily dropped; ideas that do not work as well as one would hope can be improved on; and in the end large-scale safe, low-cost biological control of insect pests can be done successfully with confidence.

One man who successfully uses bug juice bioinsecticides does not separate the bugs from the leaves. He collects several leaves that are covered with aphids; then he grinds up the leaves and the bugs together in a blender and sprays a diluted solution back onto the vegetables. In one day he reports many of the aphids are gone; in three days they are all gone.

Pill bugs and slugs are not insects, but the bug juice method has been used successfully against them. However, more than one spraying is often necessary.

Bug juice has been used to treat soil planted to squash and beans.

- An ounce of ground up pill bugs (root-eating soil pests) was mixed with two ounces of water to make a paste and then diluted, one ounce to a gallon of water (three milliliters to 3.78 liters of water).
- One section of land was soaked with the solution; the other section was soaked with plain water,
- Two days after sowing, the seedlings came up. The roots of the plants in the untreated section were eaten by pill bugs on the first night, but the roots of the plants in the section watered with bug juice were not eaten.

A few warnings:

1) Bug juice bioinsecticides can quickly lose their effectiveness by becoming spoiled with bacteria; in other words, bug juice can rot. Use all of it right away or freeze the remainder. The only possible danger with the bug juice method is to let it sit out and become contaminated with salmonella bacteria as it decays.

There is no danger to people if the bug juice is used within an hour or two of being made or if the unused portion is frozen. Since the concentrate can be diluted up to 25,000 times, it is a good idea to freeze some for reuse after a rain.

2) Some people develop allergies when working with insect parts. If this starts to happen, wear a mask, long-sleeved shirt, pants, and gloves when spraying with bug juice.

3) Do not use the bug juice method against fleas, ticks, mosquitoes, and other insects that attack people and may carry human disease.

4) If a grinder is used to grind up the bugs, use that grinder only for making bug juice. If a blender has to be used to prepare food for people, use a mortar and pestle to grind up the insects.

Directions for making and using bug juice bioinsecticides:

1) Check for damage. Do not use the method if the crop is not being seriously attacked. If there are only a few pest insects, then there is a balance between insects that eat plants and insects that eat insects. Do not upset this balance.

2) Identify the pest insect. If the crop is being attacked by a pest, identify which insects are doing the damage. It is important not to kill insects that are not major pests. They provide food for insect-eating insects, birds, and animals.

3) Collect the pest insects. Collect as many insects as can be found in 15 minutes or at least 100 insects of each type for every five hectares (12½ acres). Protect the insects from the sun; they will not make a good bug spray if they die before being ground up.

4) Put the insects in a blender. Cover the insects with a cup of two of rain water or boiled water that has been allowed to cool. The volume ratio should be about one third insects to two thirds water. Run the blender at high speed until the solution is all liquid. This should take about one minute.

5) Strain the solution through cheese cloth, a paper filter, a clean rag, or towel. This will prevent the sprayer from becoming clogged with small insect parts.

6) Dilute the concentrate solution. For gardens, use a small hand sprayer, the degree of dilution is not critical. Dilute one quarter cup of concentrate with one or more cups of rain water or boiled water that has been cooled. Freeze, do not just refrigerate, the rest of the concentrate in small batches in case repeat sprayings are necessary.

For farms, a dilution as weak as one ounce (30 milliliters) of concentrate in about 100 gallons (378 liters) of rain water has worked. (Liquid soap, corn syrup, or

other sugars that dissolve easily in water can be added to the solution to help the spray stick to plants.)

7) **Spray the crops** with the diluted concentrate. Use a standard insecticide sprayer to spray bioinsecticides. Spray both sides of the leaves and spray the stems, too. If a rain occurs soon after spraying, repeat with the solution that was frozen or make a new batch. Even if it does not rain, it is not unusual for repeat sprayings to be necessary.

8) **Check the plants before spraying**, in a few hours after spraying, one day, three days, and one week later to see what is happening to the pest insects. Some effects may not show up until a few days or weeks after spraying, depending on the type or types of insect disease or parasite that is in the bug juice; so keep watching.

Ferrocement

This ferrocement concrete information can be used to make concrete biogas digesters and gas storage tanks. This information can also be used for the construction of water tanks, grain storage tanks, or for almost any construction project that needs strong concrete walls.

This section is adapted from the book, **Ferrocement Water Tanks and Their Construction**. The book describes methods of constructing water storage tanks from wire-reinforced concrete. These tanks are widely used in many parts of the world to collect and store water for housing, irrigation, and industrial purposes. The tanks are made by hand troweling a cement-rich concrete onto a mesh of wire reinforcement to form cylindrical (round) tanks with thin walls which vary in thickness from 3.0 to 10.0 centimeters (1.0 to 4.0 inches) depending on the size of the tank.

Part One

Although the word ferrocement is used here, this is not strictly true. These tanks should really be called wire-reinforced concrete tanks. The main difference is that in ferrocement there is a very dense layer of mesh reinforcing wire that has to have a minimum value of wire volume for each unit volume of concrete. The quantities of straight wire reinforcement used here fall far below this minimum value, but they provide enough strength for the tank sizes described here.

Still, wire-reinforced concrete is closer to ferrocement concrete than to ordinary steel-bar reinforced concrete. The wire distributes the load throughout the concrete, preventing the force of the load from concentrating in planes of weakness which would lead to early failure (Diagram 29, Figure 3). Straight wire is used because it is many times cheaper than the same weight of mesh wire.

This method of water tank construction is useful in rural areas for several reasons.

- **The basic raw materials are available and are already being used for many familiar purposes.**
- **Except for the cement, which must be kept dry, the materials are not easily damaged.**
- **The skills needed to use the materials are often already known, and people can learn to make good tanks after only a few days of instruction.**
- **The users of the tank can contribute their labor to pay for part of the cost.**
- **The construction techniques are not complicated and do not demand the use of expensive and complicated machines or electricity.**
- **Trained supervision can be kept to a minimum.**
- **Leaks resulting from bad workmanship or damage are easy to repair, and only minimal maintenance is needed.**
- **The framework can be carried from site to site and used to build many separate tanks.**

Wire-reinforced concrete is used for a wide variety of purposes, but its main advantage for water tanks (and biogas systems) is its ability to resist rusting and its low cost in comparison with other building materials. Galvanized iron (GI) tanks have been widely used in the past for water storage, but they are expensive and galvanized iron will rust and leak in five to ten years, even if they are carefully maintained. The life of reinforced concrete water tanks is expected to be more than 50 years.

The thin walls of ferrocement tanks are able to bend under load; this helps prevent the concentration of stresses that cause cracking. The wire reinforcement distributes the stresses throughout the concrete, increasing its ability to carry pulling and bending loads (tensile loads) without cracking. The thick walls of steel-bar reinforced tanks are not able to bend very much under load; they are more likely to crack than to bend.

Wire-reinforced concrete tanks have been proven in use over many years in all extremes of weather conditions and can be built confidently with capacities up to 125 cubic meters (4,400 cubic feet or 33,000 gallons). But the tanks should not be built off the ground unless expert advice is available.

Cost of construction: While the final price of the tanks will vary according to local conditions, it will depend on the following.

- **Materials: the cost of sand, cement, straight wire, mesh wire, and formwork.**

The formwork can be made either for one usage with temporary local materials or of more permanent construction from steel sheeting and angle iron. Well-made forms will last for many years and the formwork cost for each tank will become increasingly smaller.

- **Wages:** the cost of wages for plasterers, laborers, and supervisors if the tank is not built totally by self-help.
- **Transportation:** the cost of transporting people and materials.

The quality of the water stored in the tank will depend initially on the quality of the water put into the tank. Diseases that are related to water and water use are causes of sickness and death to people who do not have protected or purified water supplies or efficient sanitation. Any measures that reduce the risk of these diseases will be of great value to water users.

The bacteria that cause some of the most serious illnesses, especially cholera, typhoid, and diarrhea in children, cannot live long outside of the human body. In stored water, most will die within one week, although cholera and typhoid germs can remain dangerous in stored water for up to four weeks.

Water in a tank must be protected from contamination. As shown in Diagram 28, a cover is usually necessary. The tank must not be allowed to become a breeding ground for malarial mosquitoes. Overflow pipes should be covered with window screen and so should the inlet. These precautions will prevent trash, insects, rats, and mice from falling into the tank.

To further improve the quality of the water, certain chemicals can be added. Both chlorine and iodine kill disease-causing bacteria and viruses in water. But unlike chlorine, iodine has no taste or smell, and iodine is medicinal in that it can prevent and cure goiter.

Chlorine, even though it is used all over the world to make water safe to drink, can increase the risk of some types of cancer; it is made inactive by organic matter in water, and its strength is reduced if the water is alkaline (base).

Too much iodine, like too much chlorine, can be poisonous. Follow the directions for using iodine very carefully. The result will be a method of purifying water that is an improvement on the chlorine method. Iomech Ltd., a Canadian company, sells systems that add measured amounts of iodine to water systems in many developing countries, including Egypt and New Guinea.

Designing the tank : The great advantage of wire-reinforced concrete over standard reinforced concrete is its ability to resist shrinkage during the curing (drying) process, its resistance to severe cracking under tensile load, and the need for only one set of forms for construction. Pouring a thin shell of concrete between two closely spaced shutters, the usual method of ferrocement

construction, is a highly skilled and difficult job.

The weakness in tension and the brittle type of failure occur because no matter how carefully the concrete is mixed and placed, there will always be planes of weakness between the edges of the different lumps that make up the concrete. In compression (top-down pressure), these planes of weakness are held together by the load; but under tensile loading (sideways pressure), they can open up beyond their elastic limit. The separate cracks then join together, causing the concrete to fail (Diagram 29, Figure 3).

In standard reinforced concrete, the reinforcing bars work to limit and control the tendency of the concrete to crack under tensile load according to the amount and distribution of the steel bars and the degree of loading. In wire-reinforced concrete under moderate tensile loads, the concrete contributes greatly to the tensile strength of the whole structure. This is because the wire, distributed throughout the concrete, will allow the load to be absorbed throughout the concrete and will prevent the buildup of too much stress in weak spots.

DIAGRAM 28

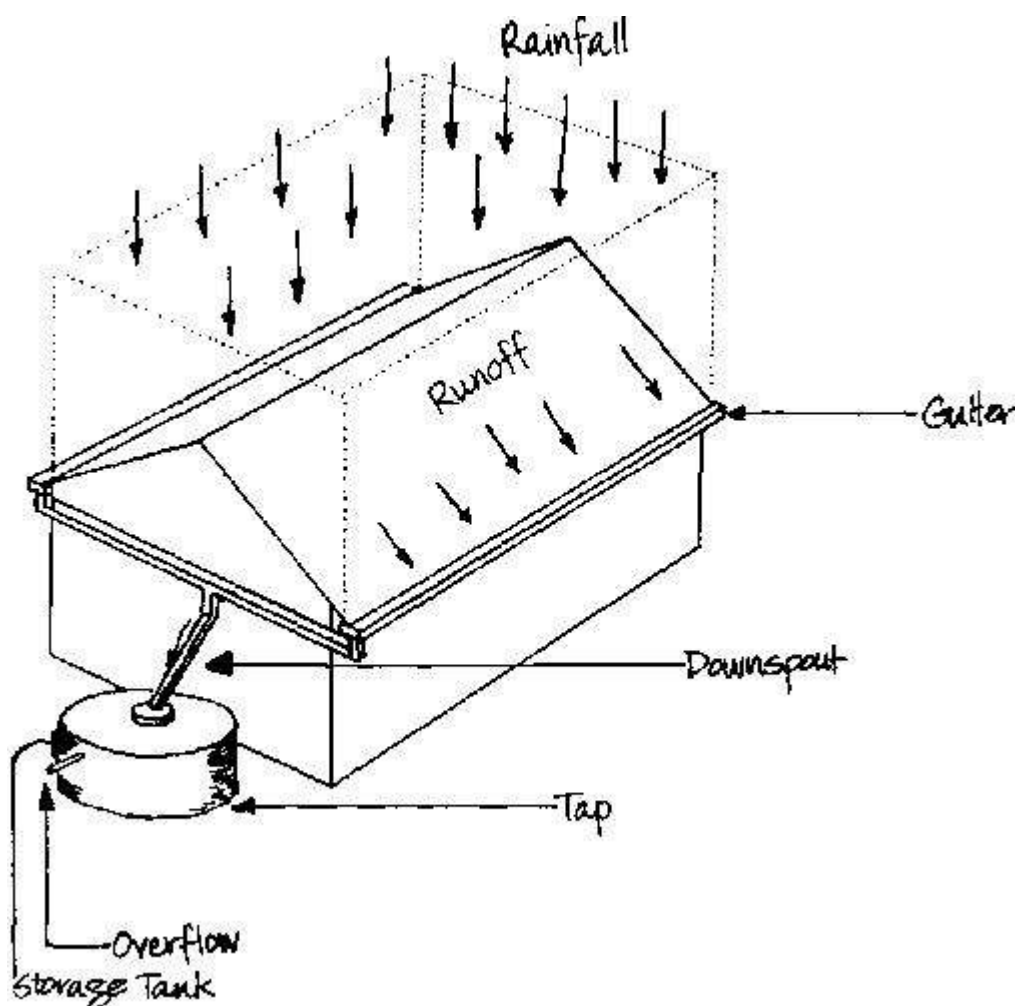
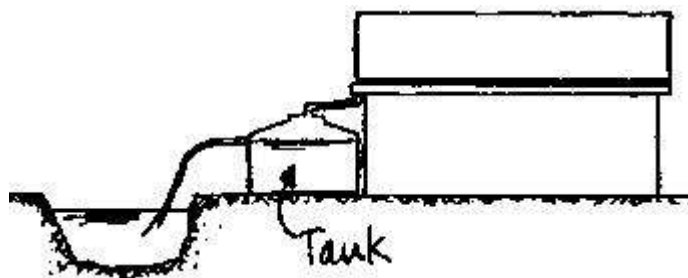

Figure 1: Catching and using the rain water from a roof



Secondary storage, fish pond, or irrigation

-Strainer (mesh sieve) to prevent rubbish from flowing into the tank with the water and to stop insects, flies, and rodents from flowing into the tank.

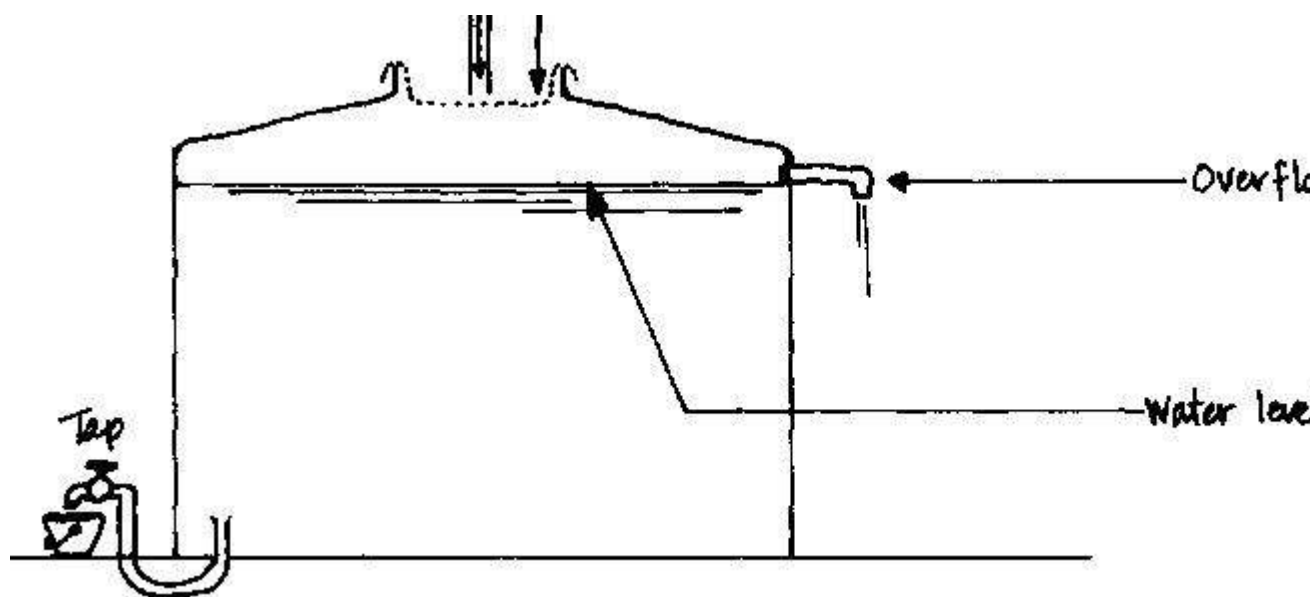

Figure 2: Protecting the tank from further contamination

-The concrete diagrams in this section are from the book, Ferrocement Water Tanks and Their Construction.

Foundation: The foundation of the tanks carry the weight of the tank and water down to the ground. The floor in smaller tanks is usually continuous with the walls. The floor slab carries the weight of the walls and the water directly onto the foundation (Diagram 29, Figure 5).

Walls: The vertical tensile stresses set up across a horizontal plane at the joint of the wall and the floor are nearly double the hoop tension stresses produced by the walls stretching outward under load. The tanks should be designed with vertical reinforcement both within the walls and between the walls and the floor to prevent cracking (Diagram 32, Figures 21 and 22).

The tanks described here have one layer of straight wire reinforcement and one layer of the more expensive woven mesh (chicken) wire. The mesh wire, which starts in the floor and goes into the walls, will provide the reinforcement that

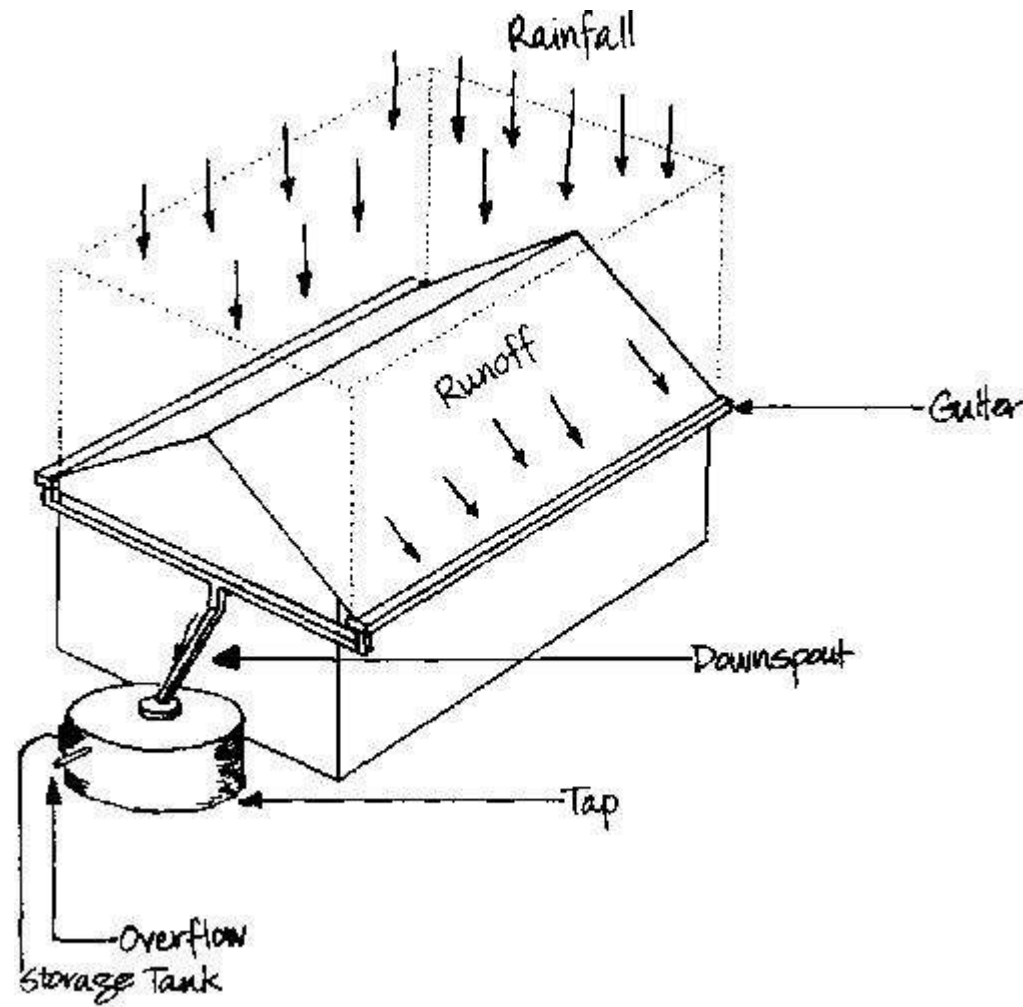
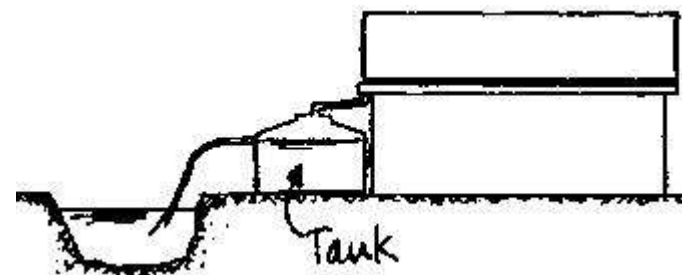

Figure 1: Catching and using the rain water from a roof



Secondary storage, fish pond, or irrigation

-Strainer (mesh sieve) to prevent rubbish from flowing into the tank with the water and to stop insects, flies, and rodents from flowing into the tank.

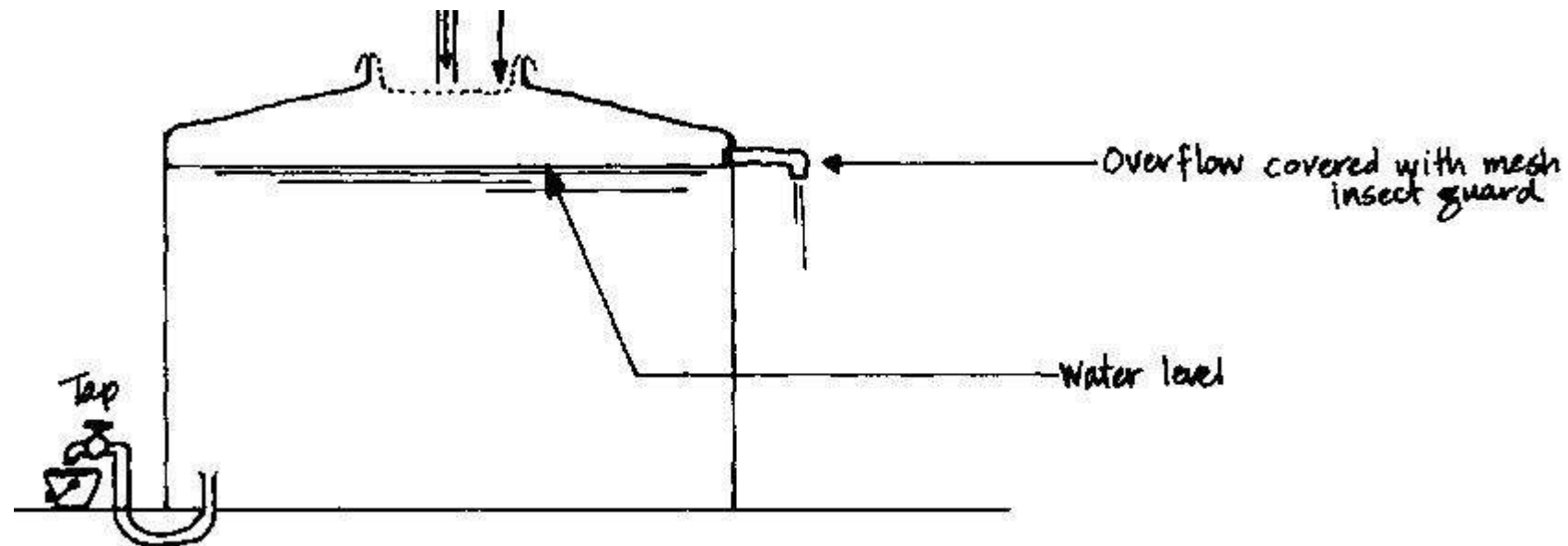

Figure 2: Protecting the tank from further contamination

-The concrete diagrams in this section are from the book, Ferrocement Water Tanks and Their Construction.

Foundation: The foundation of the tanks carry the weight of the tank and water down to the ground. The floor in smaller tanks is usually continuous with the walls. The floor slab carries the weight of the walls and the water directly onto the foundation (Diagram 29, Figure 5).

Walls: The vertical tensile stresses set up across a horizontal plane at the joint of the wall and the floor are nearly double the hoop tension stresses produced by the walls stretching outward under load. The tanks should be designed with vertical reinforcement both within the walls and between the walls and the floor to prevent cracking (Diagram 32, Figures 21 and 22).

The tanks described here have one layer of straight wire reinforcement and one layer of the more expensive woven mesh (chicken) wire. The mesh wire, which starts in the floor and goes into the walls, will provide the reinforcement that limits cracking between floor and walls.

The joint between walls and floor will not remain completely rigid. It is likely that very small cracks will open and that the joint will bend outwards and throw a greater part of the load onto the wire reinforcement (Diagram 30, Figure 9). These small cracks are unlikely to be serious. If the cracks become wide enough to allow water to reach the wire because there is not enough wire or the wires are too widely spaced--the wire will rust and eventual tank failure will occur. In most of the tanks a thick concrete layer is built up around the junction of the floor and the walls to strengthen the joint.

The chicken wire layer that is wrapped around the formwork (before the straight wire is added) will play an important part in preventing cracks from occurring as a result of shrinkage and loading. Although the mesh wire is expensive, it will contribute greatly to the strength of a water tank.

limits cracking between floor and walls.

The joint between walls and floor will not remain completely rigid. It is likely that very small cracks will open and that the joint will bend outwards and throw a greater part of the load onto the wire reinforcement (Diagram 30, Figure 9). These small cracks are unlikely to be serious. If the cracks become wide enough to allow water to reach the wire because there is not enough wire or the wires are too widely spaced--the wire will rust and eventual tank failure will occur. In most of the tanks a thick concrete layer is built up around the junction of the floor and the walls to strengthen the joint.

The chicken wire layer that is wrapped around the formwork (before the straight wire is added) will play an important part in preventing cracks from occurring as a result of shrinkage and loading. Although the mesh wire is expensive, it will contribute greatly to the strength of a water tank.

Floor: The concrete floor of a tank is usually built first to give the walls a solid foundation. There should be mesh wire running from the floor up into the walls to provide resistance against cracking. A bitumen (asphalt or tar) movement joint between the floor and the walls is usually provided to take expansion and settlement.

The concrete floor of large tanks (over 10.0 meters in diameter) must be cast in sections with bitumen-sealed expansion joints between the sections. This will allow the floor to expand and contract without cracking. The floors of the smaller tanks can be built as one continuous piece.

Roof: A roof provides a good cover against the loss of water from evaporation, which in hot, dry parts of the world, can exceed two meters per year. It prevents trash, insects, rats, and mice from getting in and it keeps the water cool. The extra stresses set up by the weight of a concrete roof are not great if the junction between the roof and the walls is curved. Sharp angles concentrate stresses and start cracks.

The greatest stresses set up in a roof of this kind are caused by its expansion in hot weather from the heat of the sun. These stresses can be over 20 times greater than the static load stresses due to the weight of the tank. For this reason, the roof and walls should be painted white to reflect the heat of the sun or be protected with a grass roof (Diagram 30, Figure 11) over the concrete roof. The roof may also be built from lightweight materials, such as galvanized iron, fastened to a conventional structure built over the tank (Diagram 30, Figure 12).

DIAGRAM 29

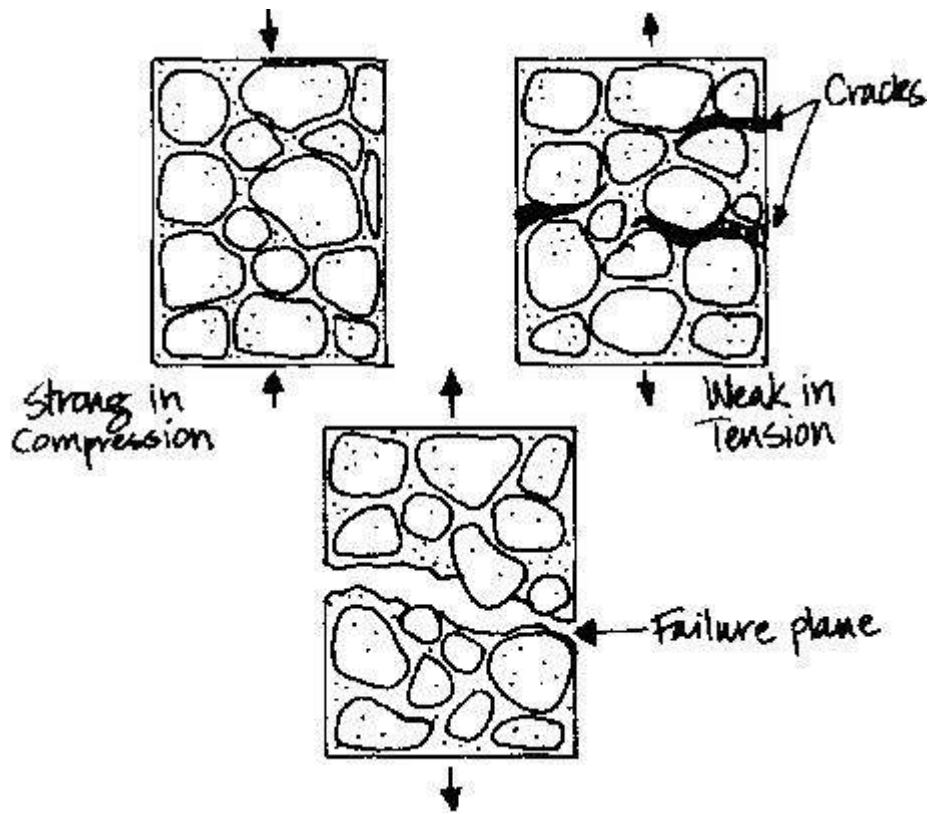

Figure 3: MORTAR UNDER LOAD

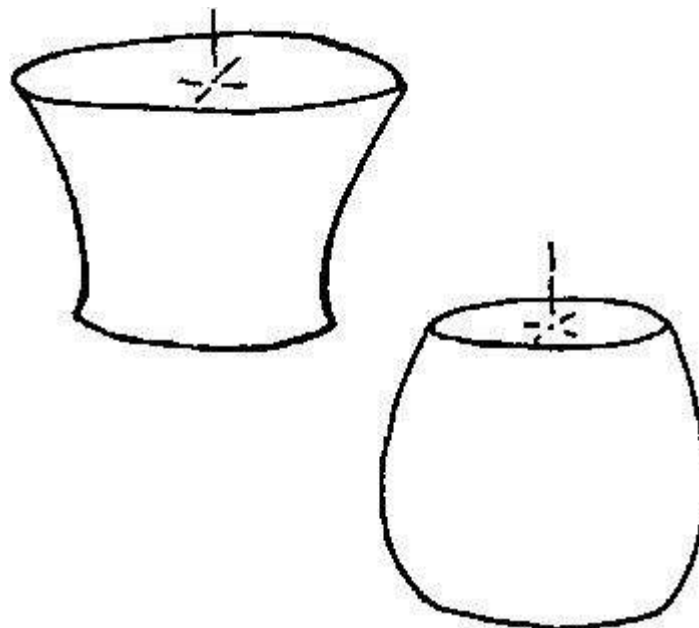

Figure 4: Curved walls are stronger than flat walls

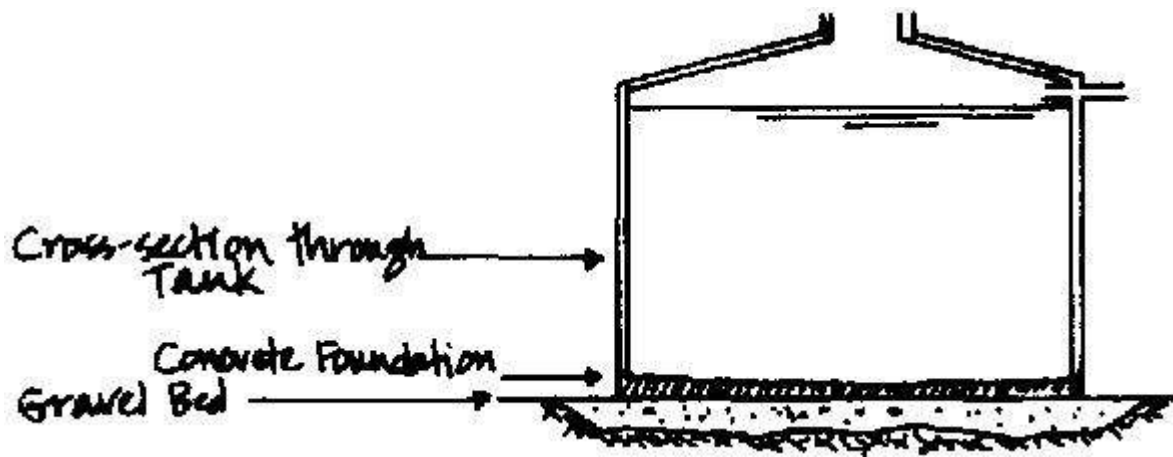

Figure 5A: Foundation of small tank

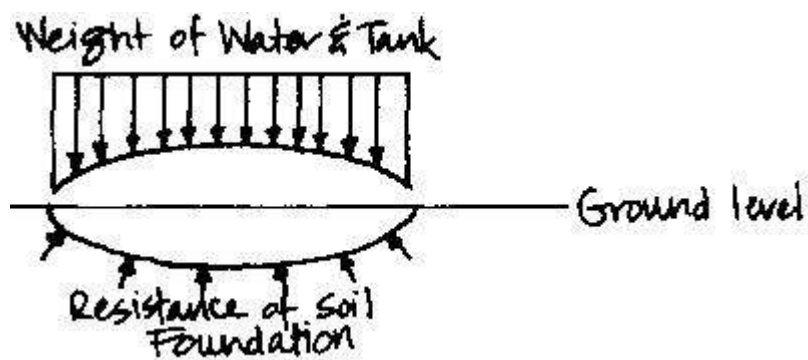

Figure 5B: Walls and base joined

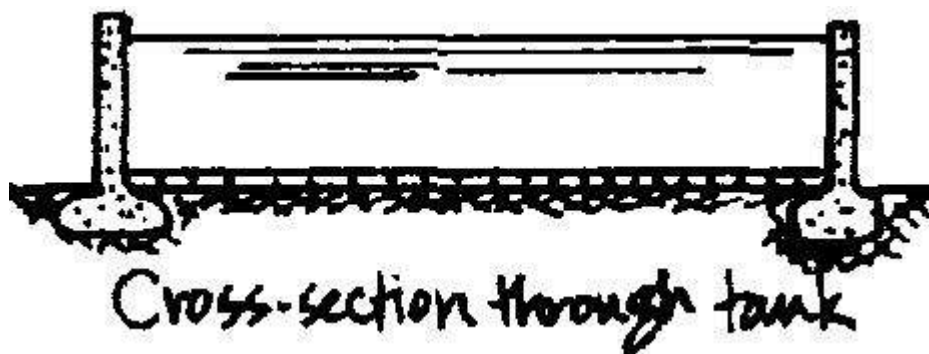

Figure 6A: Foundation of Large open tank -

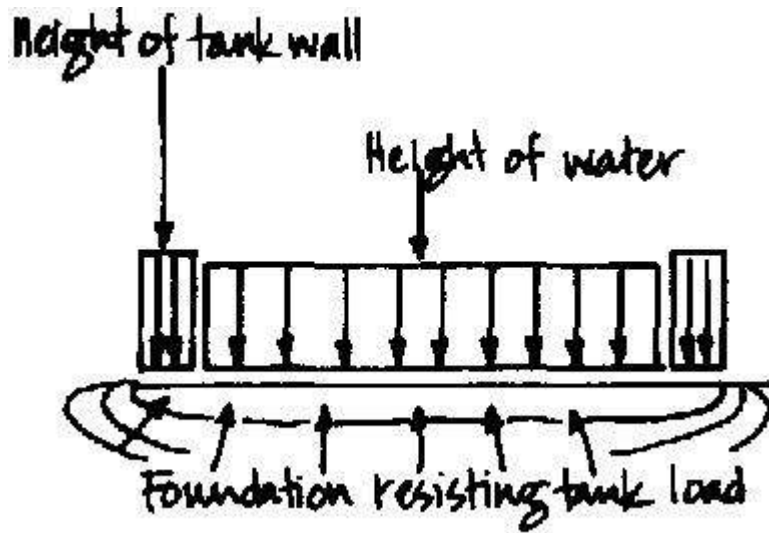
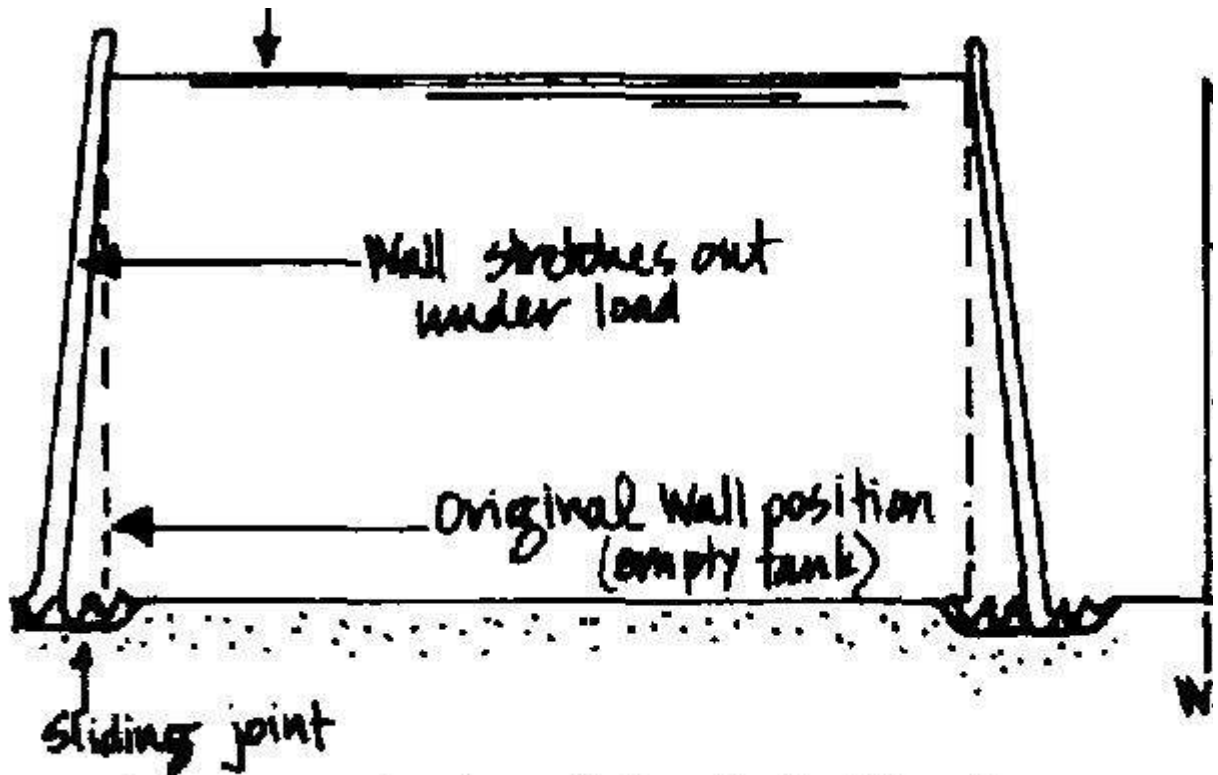

Figure 6B: Walls and floor separate



*NOTE: Wall movement enlarged for illustration purposes.

Figure 7: WALLS FREE TO MOVE

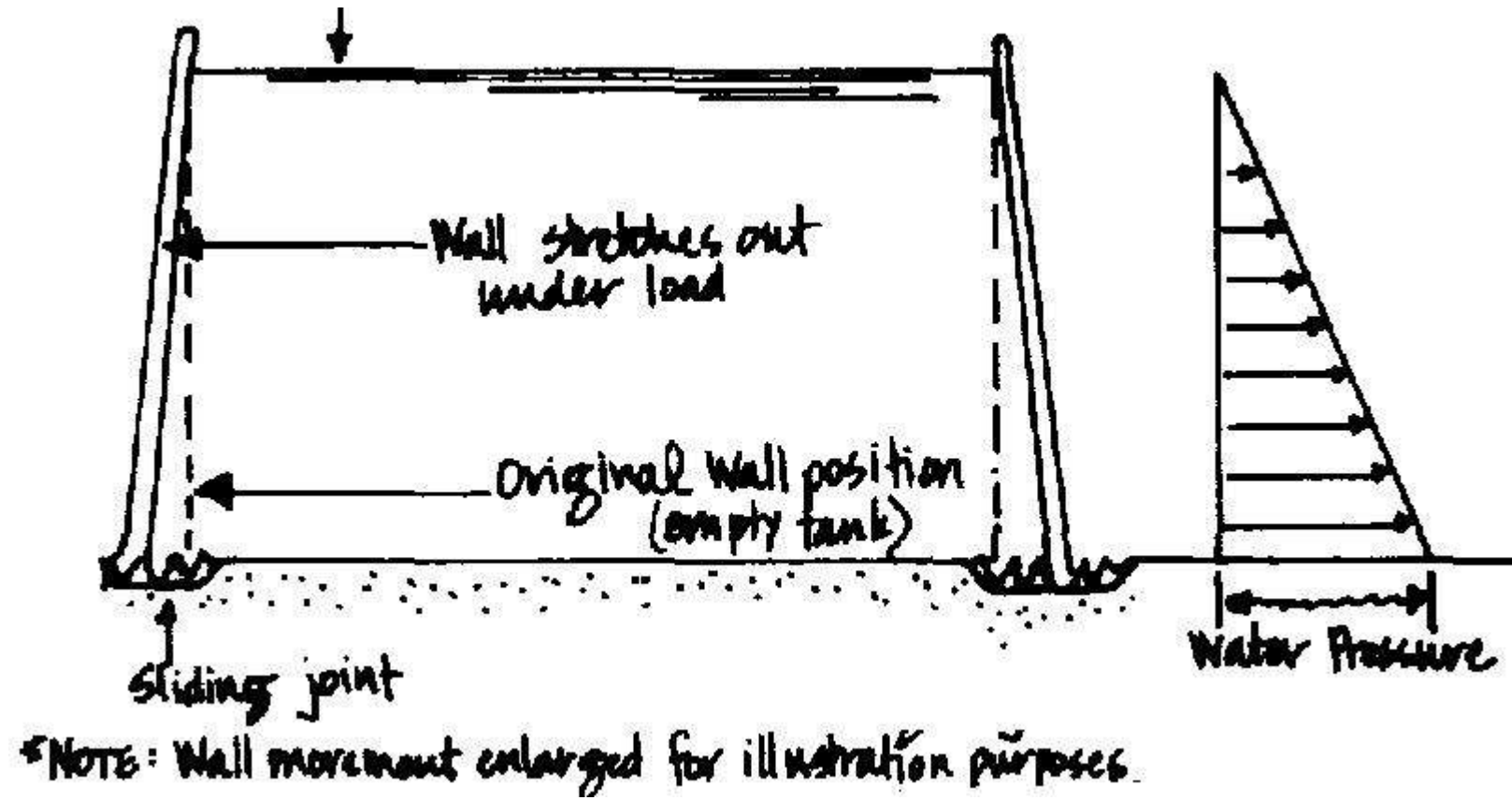

Figure 7: WALLS FREE TO MOVE

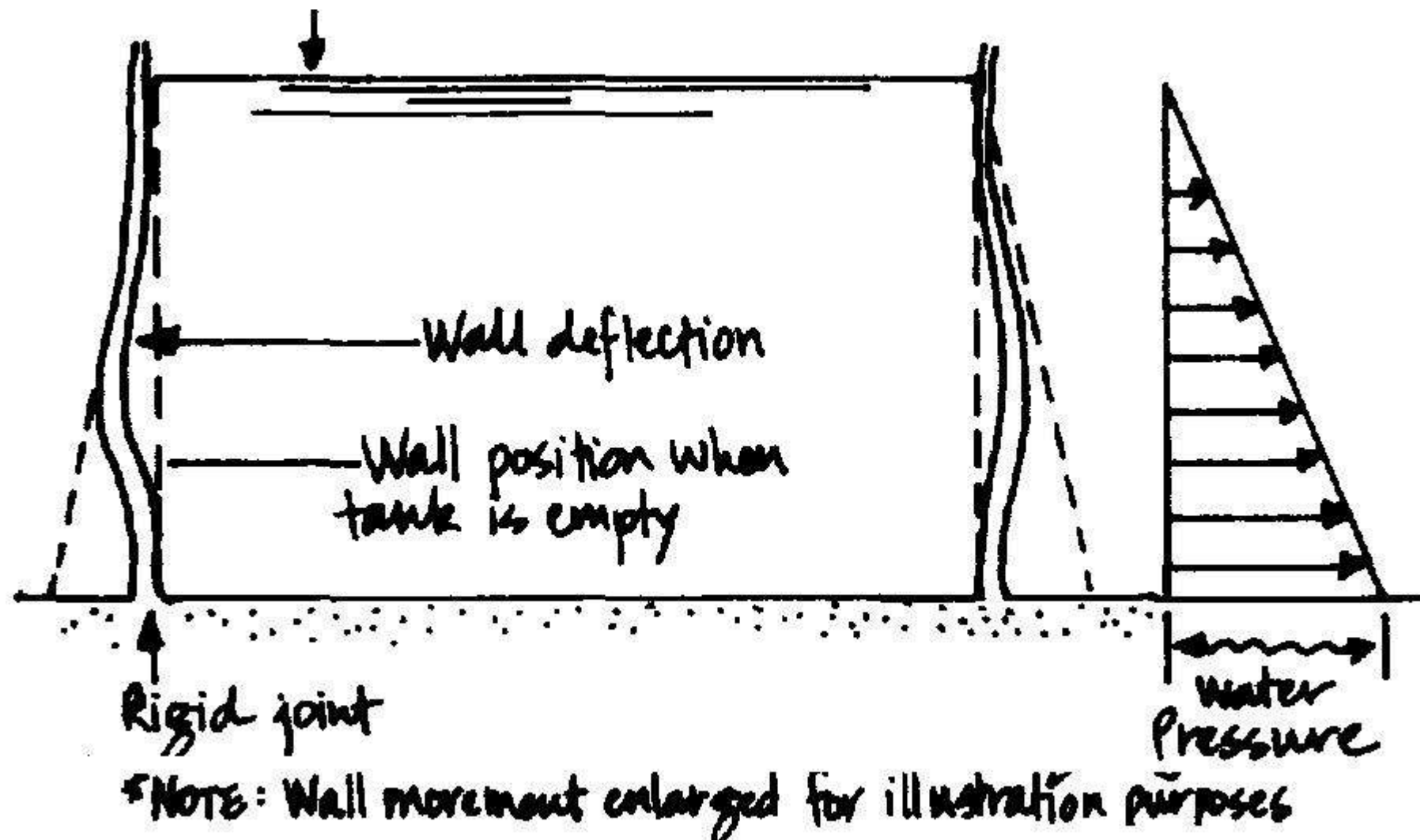

Figure 8: WALLS JOINED WITH FLOOR

Tank fittings: Most tanks will have pipes of some sort to take water in and out. The outlet pipe for smaller tanks often goes through the bottom of the walls, the overflow pipe through the top of the walls, and the water enters through the roof. With larger tanks, the inlet and outlet pipes should both go through the floor. This reduces the risk of cracking and leakage around the pipes which could happen if the pipes were cut into the walls. The overflow pipe should still go through the top of the walls. In all cases where the outlet pipe passes through the floor, a wire screen of some sort is recommended to prevent the outlet pipe from being blocked by trash.

The opening of the outlet pipe is usually placed 10.0 centimeters (4.0 inches) or so above the level of the tank floor to prevent dirt that has settled to the bottom of the tank from being used. The hole for the overflow pipe is cut out while the concrete is still green (half dry). The overflow pipe is then set in the hole. The open end of the pipe should be covered with a layer of window screen to stop mosquitoes and other insects from entering and breeding in the tank.

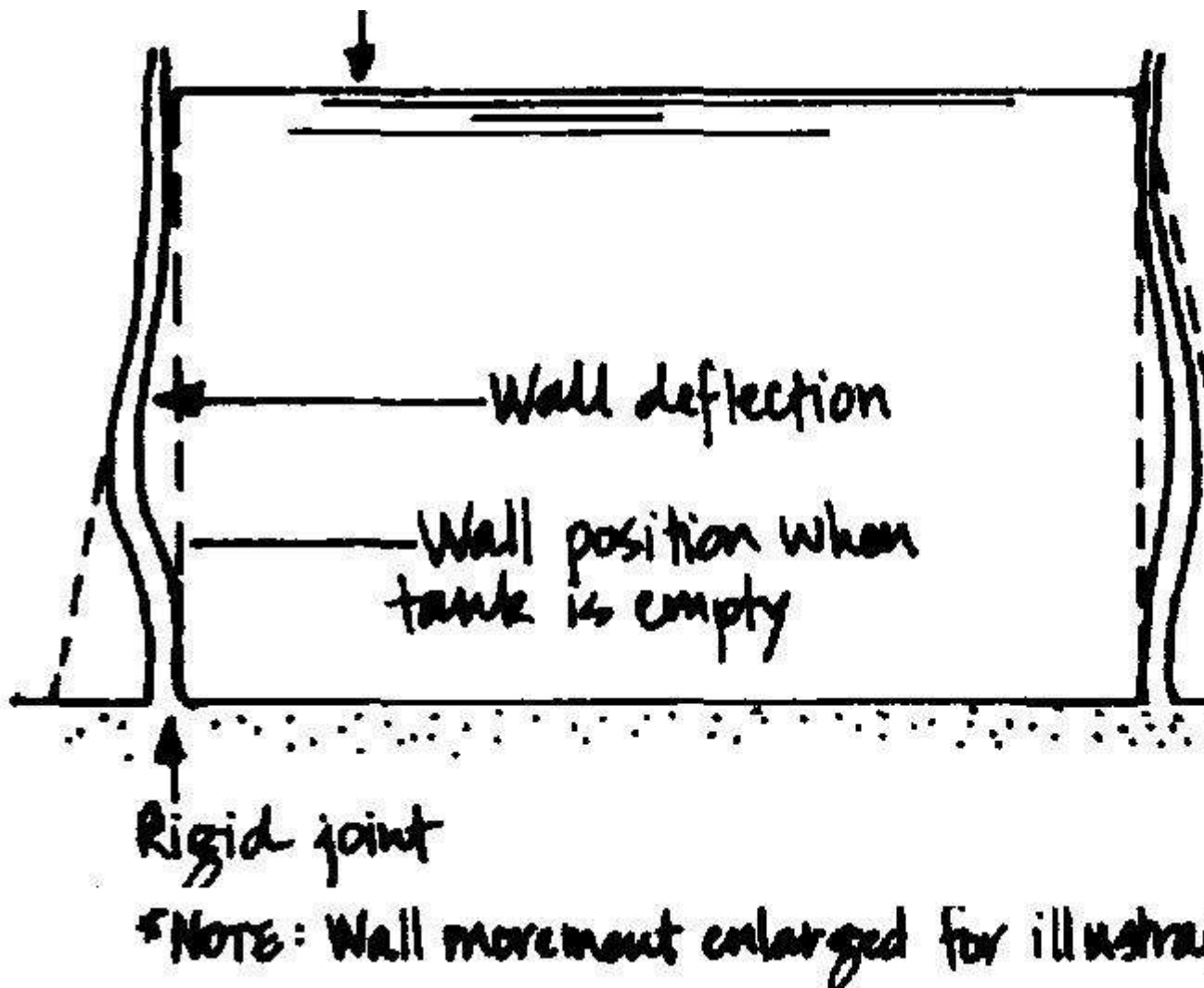

Figure 8: WALLS JOINED WITH FLOOR

Tank fittings: Most tanks will have pipes of some sort to take water in and out. The outlet pipe for smaller tanks often goes through the bottom of the walls, the overflow pipe through the top of the walls, and the water enters through the roof. With larger tanks, the inlet and outlet pipes should both go through the floor. This reduces the risk of cracking and leakage around the pipes which could happen if the pipes were cut into the walls. The overflow pipe should still go through the top of the walls. In all cases where the outlet pipe passes through the floor, a wire screen of some sort is recommended to prevent the outlet pipe from being blocked by trash.

The opening of the outlet pipe is usually placed 10.0 centimeters (4.0 inches) or so above the level of the tank floor to prevent dirt that has settled to the bottom of the tank from being used. The hole for the overflow pipe is cut out while the concrete is still green (half dry). The overflow pipe is then set in the hole. The open end of the pipe should be covered with a layer of window screen to stop mosquitoes and other insects from entering and breeding in the tank.

On large tanks used for watering animals (Diagram 30, Figure 13), the outlet is

often provided with an adjustable pipe section fitted inside the tank. If the water trough is damaged by the animals or if the ball valve in the trough sticks open, only a little water will be lost. The outlet to the tank should be fitted with a sand filter to screen the water before it is used in order to remove most organic matter and bacteria. This sand filter must be kept permanently wet if it is to work correctly. The sand should be cleaned or replaced from time to time (Diagram 30, Figure 14).

Reinforcing wire: There are many different types of steel reinforcing mesh that can be used to make reinforced concrete. These generally consist of thin wires, either woven or welded into a mesh, but the main requirement is that the wire must be easy to use and, if necessary, flexible enough to be bent around sharp corners. The wire is tied and held firmly in place so that the concrete can be troweled over it.

Chicken wire can be expensive to buy. It can cost over ten times as much as an equal weight of straight wire. For these reasons, straight wire is used for the second wire layer. Because reinforcement is needed in the vertical direction, a single layer of mesh wire is wrapped onto the formwork before the straight wire. To reduce the cost of buying ready-made mesh wire, handlooms can be adapted to weave mesh wire from straight wire.

The straight and mesh wire can be galvanized iron or steel, but under no circumstance should aluminum painted wire be used. Aluminum can react with cement to give a very poor bond between the wire and the concrete.

Cement, sand, and water: The cement that is used to make the concrete can be an ordinary Type One or Type Two Portland cement (to BS-12 or similar specification). Lower strength cement has been used in the past with some success, but it cannot be recommended. Sometimes lime is mixed with the cement in the ratio of one bag of lime to five bags of cement to improve the workability of the concrete and to reduce shrinkage cracks. The cement should always be kept dry until it is used.

The main requirement for the sand is that it be free from organic and chemical impurities that would weaken the concrete. Most clean sands are usable. If the quality of the sand is in doubt (such as salt contamination), it should be washed with clean water. A silica sand is probably best, but sands consisting of other hard minerals can be used. Moderately coarse sand, although it makes the concrete more difficult to work, will resist shrinkage and cracking better than a fine grain sand. If the sand has a high dirt content, the concrete will be weak. There should be a mixture of all grain sizes without too many of any one particle size.

DIAGRAM 30

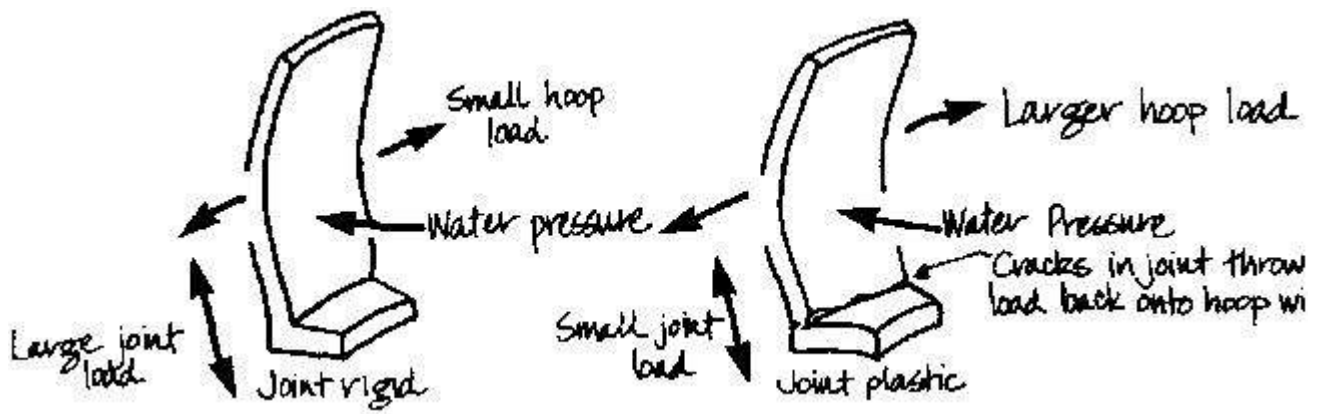

Figure 9: How the loads are taken

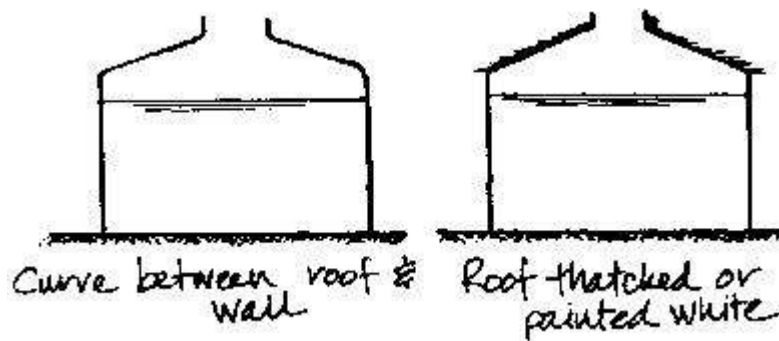

Figure 11: Roofs for tanks less than 5m diameter

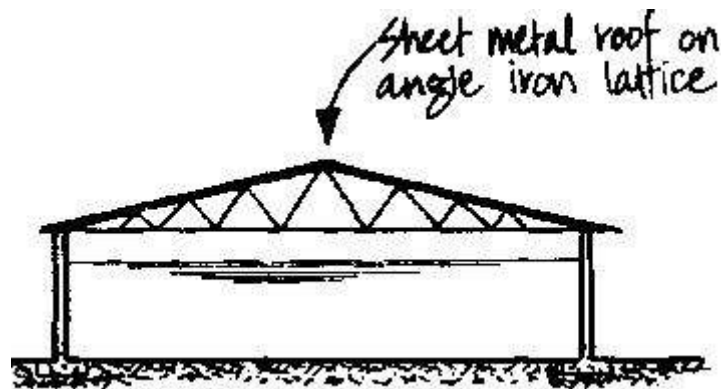

Figure 12: Roof for larger tank

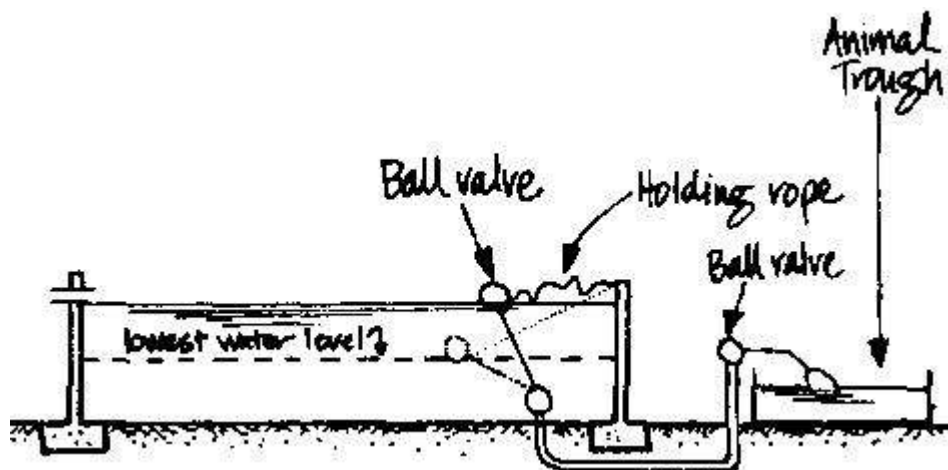

Figure 13: Ball valves for cattle watering

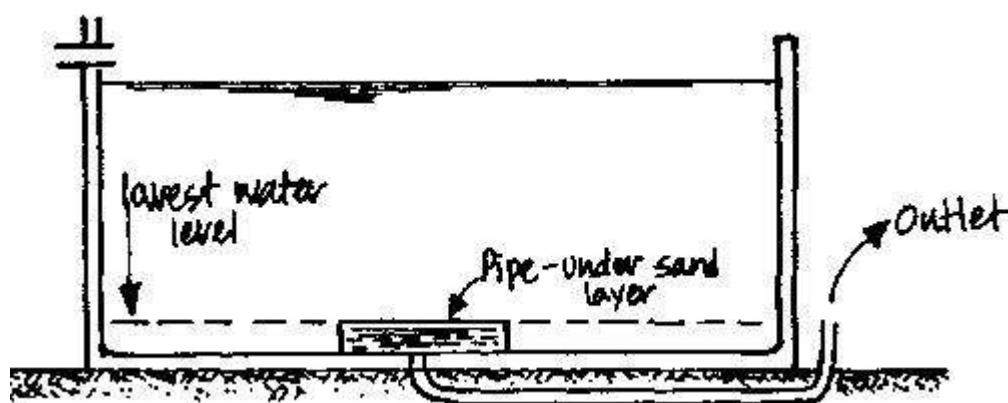

Figure 14: Slow sand filter in tank over outlet

The water must be fresh and free of chemicals in solution or suspended dirt and organic material. Clean water is a must for a strong, long-lasting concrete. Salt water should never be used.

The concrete mix: Making a strong concrete mix from cement, sand, and water is one of the most important stages in building with concrete. The concrete must be prepared with the correct proportions of materials. It must be well mixed and workable enough to be troweled by hand onto the formwork and between the wires to form a dense, compact layer. It must also be dried slowly in order for the concrete to achieve its full potential strength and durability.

Ratio of cement and sand by volume: Increasing the proportion of cement in the concrete will increase the concrete's strength and make it more workable. Extra cement will also increase the danger of shrinkage and cracking which may cancel out the value of the increase in strength.

The concrete mixture preferred here uses a cement to sand volume ratio of 1:3 (one part by volume cement to three parts by volume sand). Measuring boxes or buckets should be part of the construction equipment and should be used to achieve the correct proportions. Measuring the materials on a shovel does not

give reliable results.

Ratio of water and cement plus sand by weight: A dry, low water concrete mix will be stronger than a wet, high water mix made with the same proportions of cement and sand. Dry mixes are difficult to work with on formwork. They are more likely to contain air pockets and be poorly bonded to the reinforcing wire. Wet mixes are easy to trowel by hand, but the finished concrete will not be as watertight or airtight as a carefully made and used dry mix nor will the wet mix be as strong or as long lasting as a dry mix can be.

A compromise between wet and dry mixes must be made. Experience has shown that a 1:3 cement to sand by volume ratio and a 0.5:1 water to cement plus sand by weight ratio will work. If, in order to make the mix more workable, extra water has to be added to give a water to cement plus sand weight ratio of 0.6:1, then a better grade of sand or a larger proportion of cement should be used. (Other makers of ferrocement structures use a 1:2 cement to sand by volume and a 0.4:1 water to cement plus sand by weight ratio.)

Under most conditions the workability is usually controlled by eye during mixing. (If someone is skilled in using a funnel to make what is called a slump test, they should use it to determine the workability of the mix.) If the water to cement plus sand by weight ratio is not to exceed 0.5:1, the mixing must be carefully supervised.

The amount of water to be added to the dry mix of cement and sand is affected by the presence of moisture in the sand, which can vary greatly between the top and bottom layers of the sand pile. The wetter the sand is to begin with, the less additional water is needed. One or two small-scale trial mixes using a sample of completely dry sand and a measured water to cement plus sand weight ratio will allow the people who will be mixing the concrete to see and learn the feel of a good mix.

DIAGRAM 31

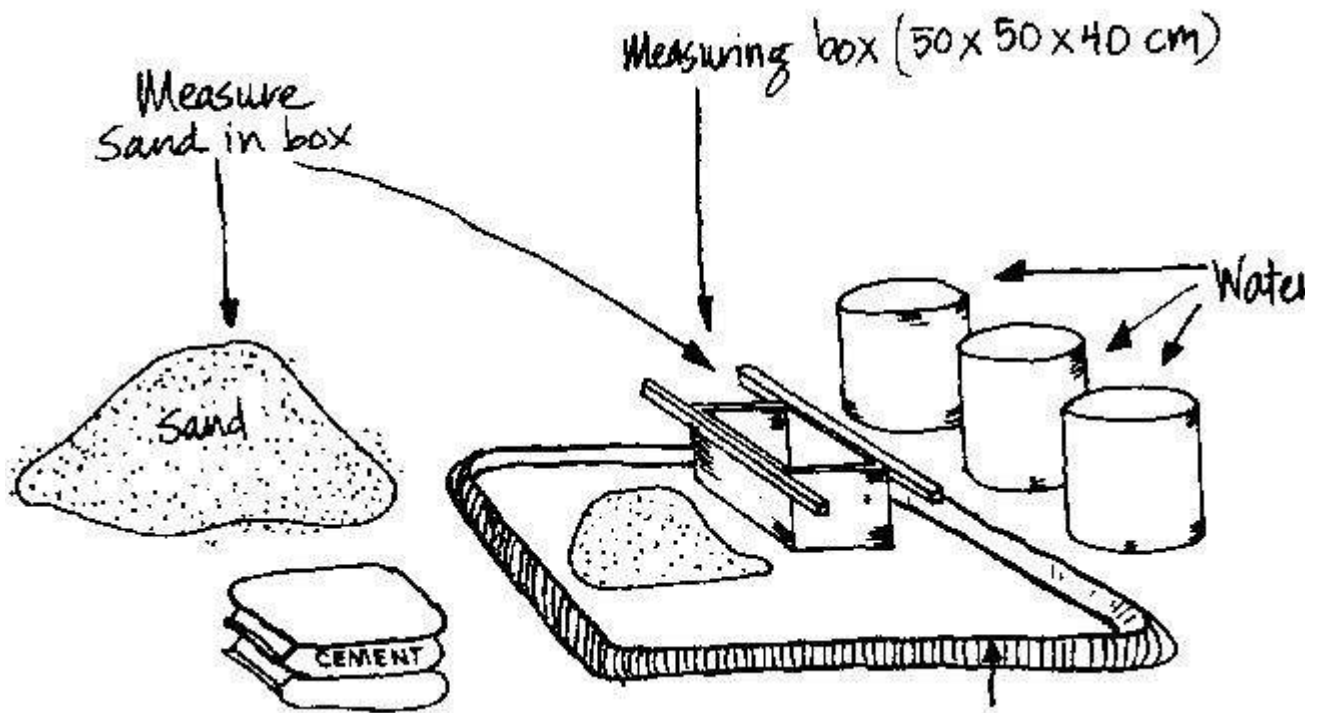

Figure 15: Mixing the concrete by hand

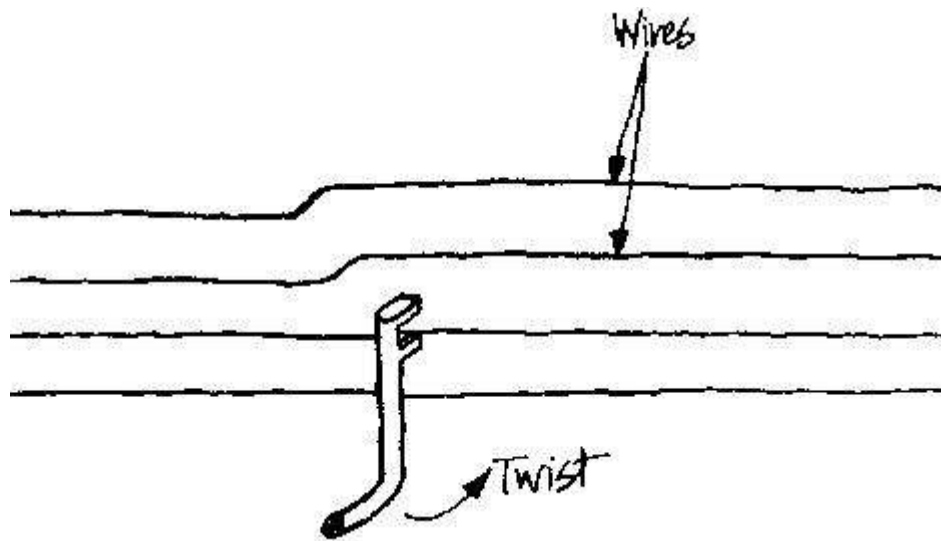

Figure 16: A tool for straightening and tightening wires that are bent and slack

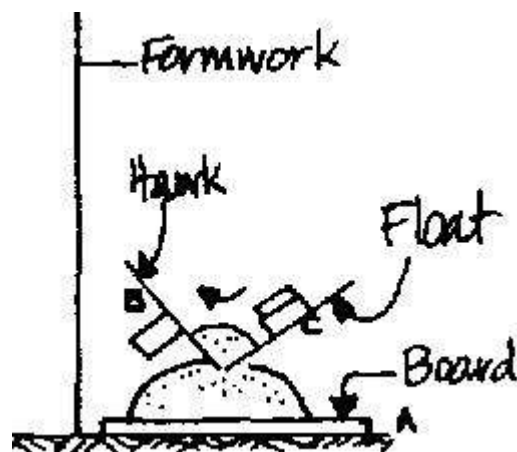

Figure 17: Trowelling the concrete onto the formwork - 1. concrete onto hawk

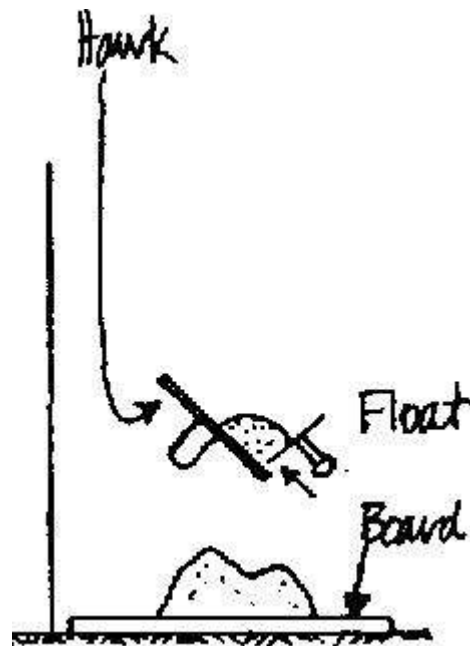

Figure 17: Trowelling the concrete onto the formwork - 2. concrete onto float

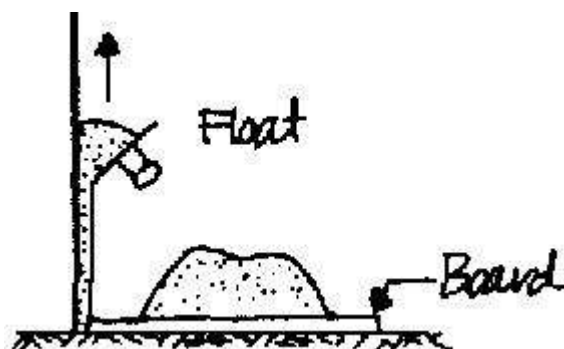

Figure 17: Trowelling the concrete onto the formwork - 3. concrete onto formwork

Formwork: Formwork is needed to support the walls while the concrete that has been troweled on hardens and sets. Well-made formwork is expensive but will, with care, last for years. Its initial cost will be spread out over many construction projects. Experience shows that well-made formwork makes construction work almost foolproof. The chicken wire and the straight wire are wound easily and quickly around the cylindrical forms and the concrete is then troweled over the wire layers. The formwork must be rigid enough to hold the weight of the concrete as it is being applied and dried without moving. If the formwork moves during the setting period, the concrete is likely to crack and be very weak.

The formwork can be made from circular corrugated iron (GI) sheets. The "hills and valleys" of the corrugations provide a mark for the tank builders to help them wind the reinforcing wire on at the correct spacing, although the straight

wire will tend to bundle together in the valleys of the corrugations.

The main advantage of the corrugated sheets, besides durability, low cost, and light weight, is that they allow for an accurate measurement of the final wall thickness when the corrugations on both the inside and the outside faces of the tanks are filled with concrete. In this way the total wall thickness is easily achieved.

Tools: The necessary tools should be collected in advance to make a standard kit for tank construction. It is possible to use local tools and equipment if they are available, but it is always safer to make sure that all necessary tools are on hand by bringing the standard tools. The concrete can be mixed either by hand or with a concrete mixer. Hand mixing is hard work and if incomplete will result in a lumpy concrete that is difficult to trowel onto a tank wall. Hand mixing can manage drier mixes better than concrete mixers, because the drums of concrete mixers tend to do a poor job at mixing low-water mixes. Treading the concrete under foot on the mixing slab is one of the best ways of working a dry mix. Steel (plasterer's) floats are much easier to use than floats made of wood. Because overworking wet concrete, especially with a steel float, can cause the concrete layer to drop off, the concrete should be applied quickly and carefully. The surface of the first layer (there are two per side) must be roughed or brushed when it has hardened a little, to give the second layer something to hold on to.

List of tools and equipment: Four plasterer's steel hand floats, four hand hawks 30 x 30 cm with 4.0 cm diameter handles, four troweling boards 75 x 75 cm, two wire brushes for cleaning formwork, two oiling brushes, one brush or scratching tool for concrete, one hacksaw and spare blades, one woodsaw, one set of wrenches, one crowbar--1.0 meter long one wire snip for mesh wire one bolt cutter for straight wire, two cold chisels for cutting green concrete, one two-kilogram sledgehammer, one gauging box for sand and cement 50 x 50 x 40 cm or other container to hold 100 liters of sand, one sieve 5.0 mm maximum openings for sand, four flat-ended shovels for mixing, one spirit level, one 50 meter long cloth or plastic tape measure, one string line, one axe for trimming wood, two pickaxes for digging, two mattocks for ground leveling, one wire tension tool, one set of formwork sections, one wheelbarrow for carrying concrete, water containers, and plastic sheeting to cover the drying concrete.

Part Two

Summary of methods: This section contains a detailed description of standard tank construction practices that have been used successfully for over 25 years in many countries all over the world. What is outlined here is a design for a small ten cubic meter capacity water tank. The book, Ferrocement Water Tanks and Their Construction, from which this information was taken, has information for building large 150 cubic meter capacity open tanks and many other different water tank designs, sizes, and adaptations of the basic design described here. VITA is another good source of information on ferrocement construction.

Clearing the site and preparing the foundation: The site chosen for the tank should be cleared of plants, loose soil, and any rocks that could cut through the floor of the tank. For small tanks it is often only necessary to clear the site and put down a 15 cm (6.0 inch) layer of sand and gravel. Larger tanks need a ring of concrete, separate from the tank floor, to support the walls. The ring is prepared by digging a trench under the line of the walls and backfilling it with concrete (Diagram 29, Figure 6).

Collecting the materials: The sand, gravel, and water should be collected before construction starts. If this is done by the people who will be using the tank, they will be able to contribute a large proportion of the total cost of the construction. With experience, a trained builder with five helpers can build a tank in about three days.

The sand and gravel should be stored in piles next to the concrete mixing slab. The slab is built by troweling a layer of concrete onto a layer of gravel 2.0 meters by 2.0 meters square. The slab is finished with a small wall to prevent the spillage of concrete slurry during mixing (Diagram 30, Figure 15). For smaller tanks, it may be cheaper to include a wooden mixing platform as part of the basic equipment. Mixing the concrete on the bare ground will contaminate and weaken the concrete with dirt.

Make sure that enough sand is collected for each tank before construction begins. The cement, mesh wire, and straight wire should be collected and stored under cover. The formwork and any other materials or tools should be collected and checked. All underground pipes should be installed before the concrete is laid. Although approximate quantities of materials needed for each tank are known, it is always a good idea to have extra materials on hand to allow for wastage.

Design: The tanks have been designed for construction by relatively unskilled workers. The tanks have a diameter of 2.5 meters, a height of 2.0 meters, and a capacity of approximately 10.0 cubic meters. The final wall thickness will be about 4.0 centimeters (1.5 inches). The tanks are built on site and should not be moved. (Portable tank construction is described in the book, Ferrocement Water Tanks and Their Construction.)

Casting the foundation: The foundations of small tanks are below and separate from the tank floor. They are made by casting a 7.5 cm (3.0 inch) thick slab of concrete 2.8 meters in diameter onto a 10.0 cm (4.0 inch) thick layer of sand and gravel. The concrete is prepared from a by volume mix of 1:2:4 of cement to sand to gravel. It should be kept wet in such a way that drying takes seven days. The ring trench of large tanks is filled with concrete after the floor slab has been cast.

Into the concrete foundation is cast a 1.0 meter length of 20 mm diameter steel water pipe with a tap on the outside end. The pipe is curved (with 45 percent joints) so that it projects 10.0 cm (4.0 inches) above the floor of the tank. A piece

of wire is threaded through the pipe to act as a "pull-through" after the tank is completed (Diagram 32, Figure 20).

Mixing the concrete for the floors and walls: The cement and sand are gauged either onto the mixing slab or into a cement mixer in the by volume ratio of 1:3. It is difficult to judge these volumes accurately by shoveling. A gauging box should be made to measure the sand. If the box is 50 x 50 x 40 cm, then one box of sand mixed with a 50 kilogram bag of cement will give a concrete volume mix of 1:3 (cement to sand).

The dry cement and sand on the mixing slab are turned by hand (if a cement mixer is not used) several times into piles from one side of the slab to the other until they are completely mixed together. A hole is then made in the center of the pile and water is added into the mix until the desired consistency is achieved (0.5:1 water to cement plus sand by weight. Add only a small amount of water at a time. It is very difficult to make a wet mix drier by adding more cement and sand. The workability of a dry mix can be increased by treading it with one's feet to break up any dry lumps. (Warning! If lime is used in the mix, it can burn!)

It is usually easier to build the floor of a tank before the walls are built. The floor is made of two 1.0 cm (0.5 inch) thick layers of concrete with one layer of chicken wire between the two concrete layers. This mesh (chicken) wire extends 1.5 meters from the floor into the walls if the floor is built first. The mesh wire extends 1.5 meters from the walls into the floor if the walls are built first. The inside corners between the floor and the walls should be built up with extra concrete. This is called "coving."

Take care that the concrete does not block the outlet pipe. Before the concrete on the floor has stiffened, make a shallow depression in the middle; this will allow the tank to be easily cleaned in the future. The dirt can be brushed into the valley and cupped out (Diagram 32, Figure 22). After the concrete has dried, the inside of the tank is painted with a thick adhesive cement or asphalt layer to seal the tank.

Formwork: The 2.0 meter high formwork is made from standard galvanized iron (GI) roofing, 0.6 mm thick with 7.5 cm corrugations. The formwork is rolled into a cylinder with a radius of 1.25 meters. Steel angle iron (40 x 40 x 5.0 mm) is bolted vertically on the inside face at the ends of each set of four sheets. This allows the metal sheets to form a circle when they are bolted together. Between the ends of each section is placed a wedge which is pulled out to allow the formwork to be dismantled (Diagram 32, Figures 18 and 19).

The formwork is erected after the concrete floor has hardened. The bolts passing through the angle iron and wood wedges are tightened to provide a rigid cylindrical form. The formwork is cleaned free from concrete and dirt. It is then oiled to prevent the new concrete walls from sticking to it. Mesh wire is then wrapped tightly around the formwork to a single thickness and tied with short

pieces of straight wire.

The 1.5 meters of mesh wire coming out of the concrete floor are overlapped with and tied tightly with straight wire to the wall's mesh wire. The mesh wire has a 50 mm mesh and is made from 1.0 mm wire (Diagram 32, Figure 21). Other makers of ferrocement structures use chicken wire with mesh openings as small as 15 mm. The smaller the mesh opening, the stronger and more expensive the tank will be.

To complete the reinforcement, the straight wire, 2.5 mm in diameter, is then wound tightly around the tank from the base up, at the following spacings:

- two wires in each corrugation for the first eight,
- one wire in each corrugation to the top, and
- two wires in the top corrugation.

DIAGRAM 32

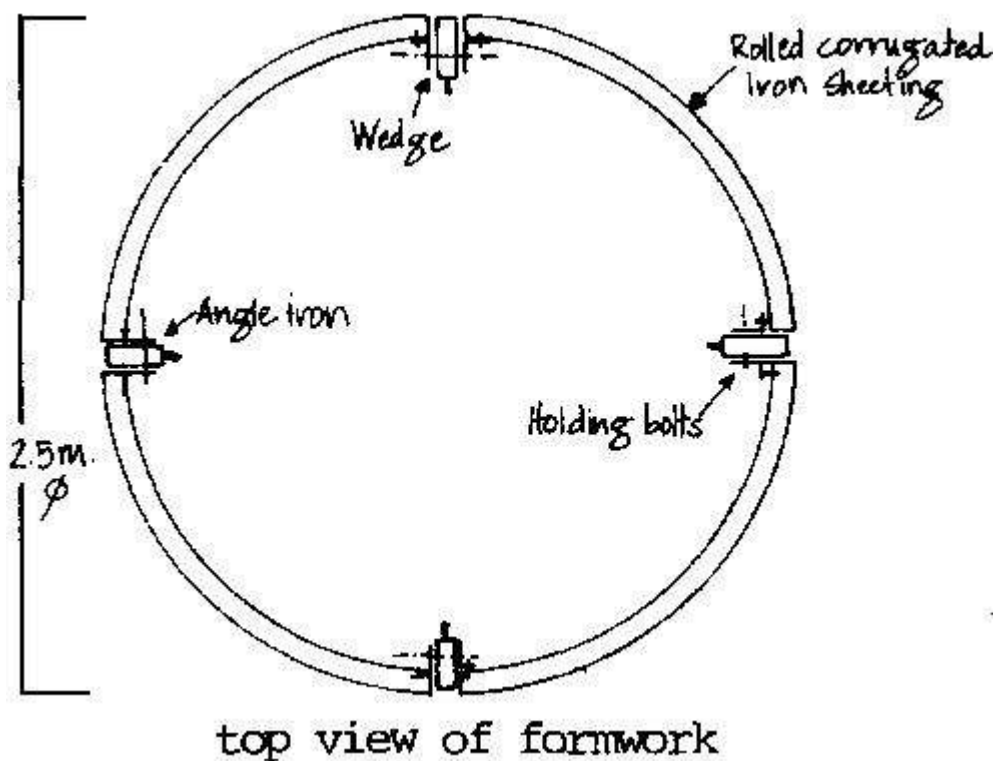

Figure 18: Standard formwork for 10 cubic meter tank - top view of format

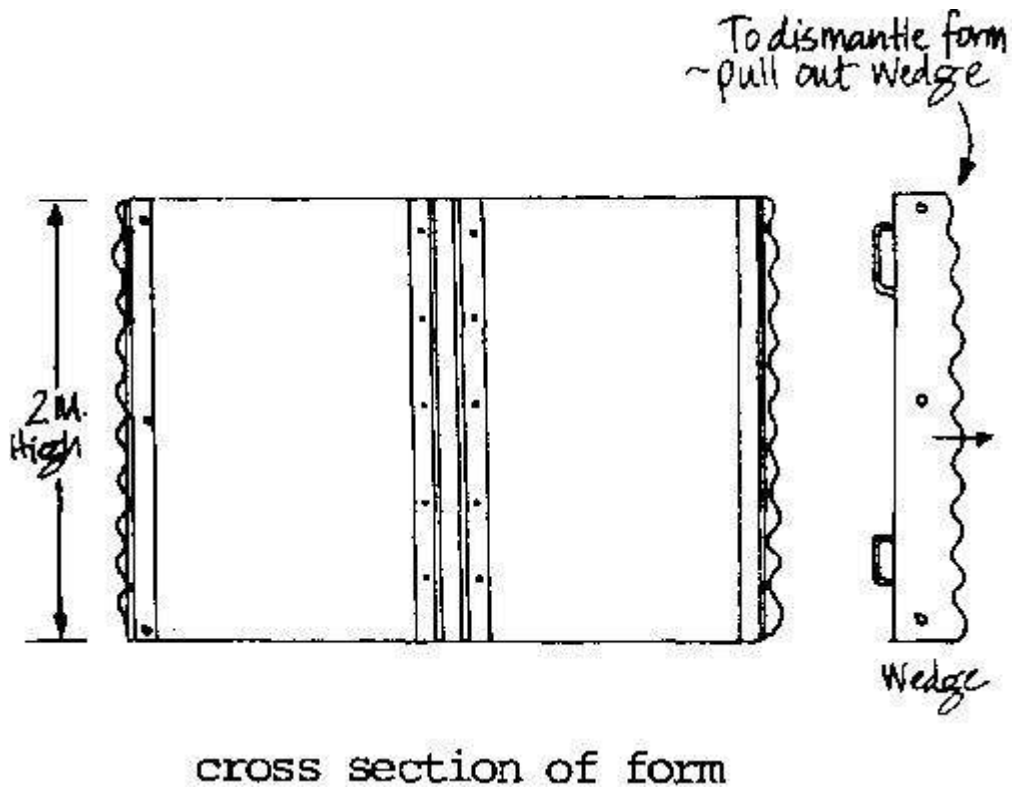

Figure 18: Standard formwork for 10 cubic meter tank - cross section of form

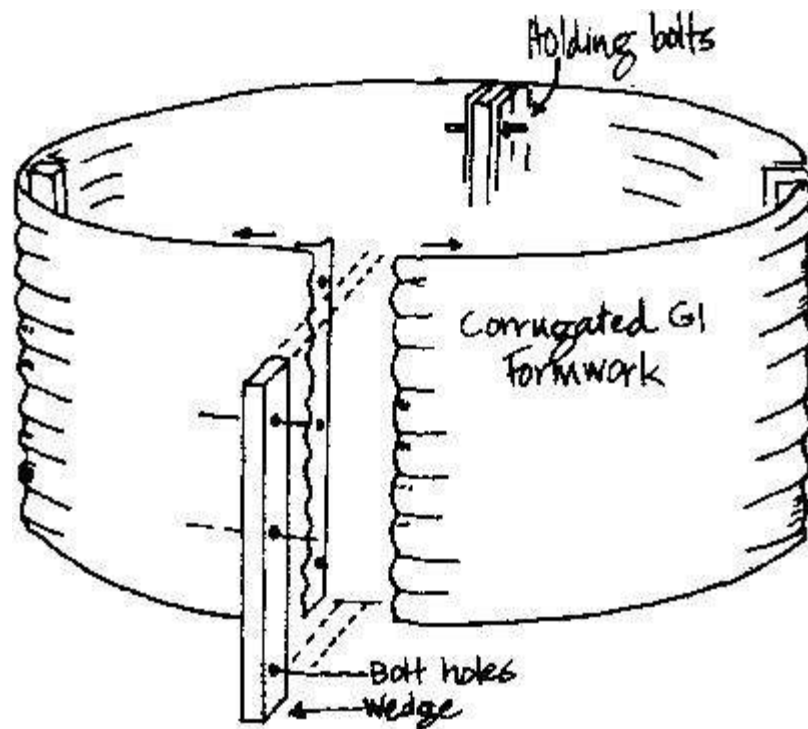

Figure 19: Tank foundation

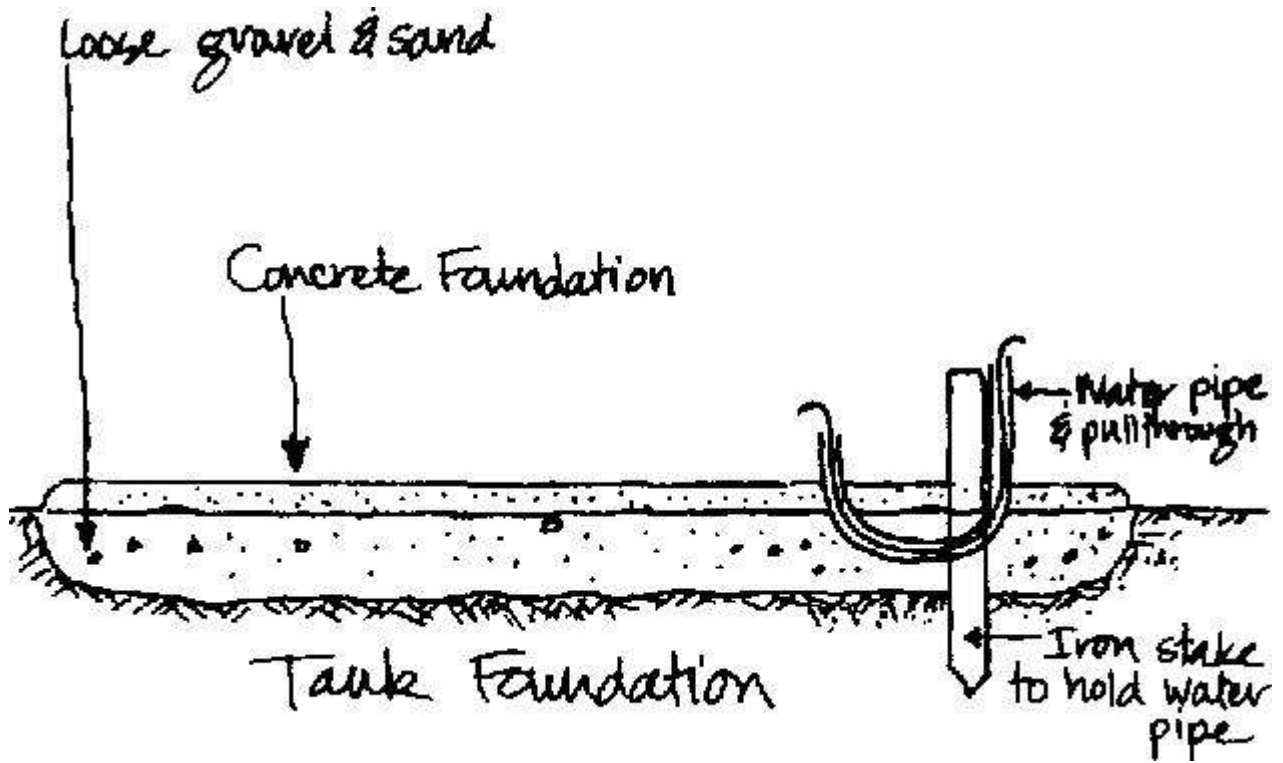

Figure 20: Assembling the formwork

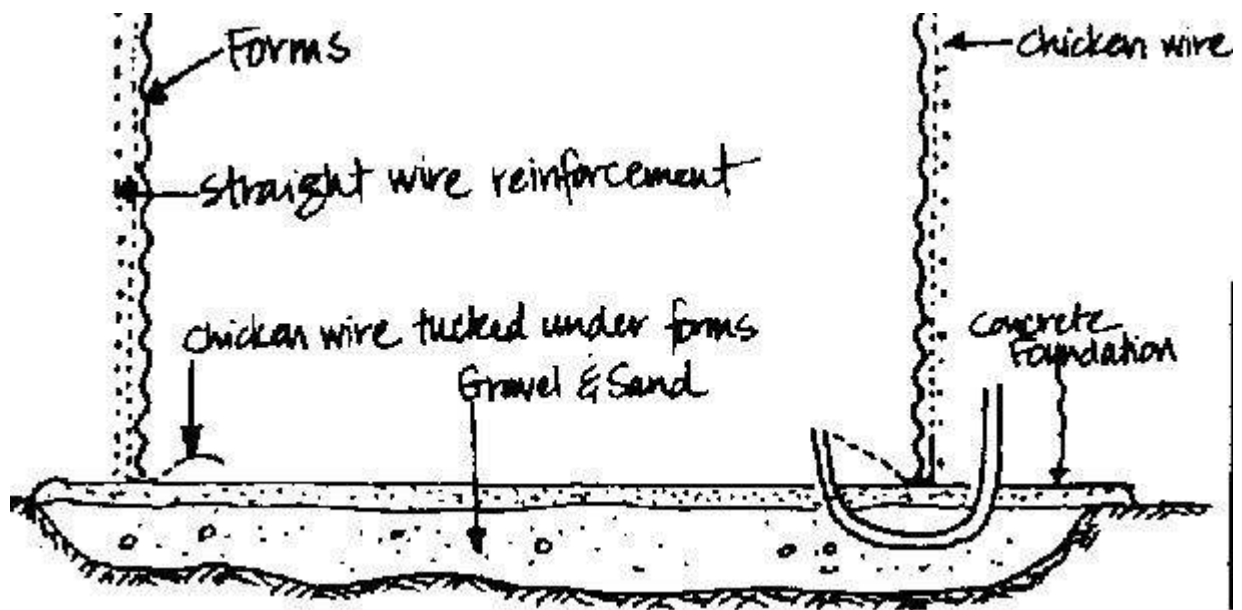

Figure 21: Erecting formwork and winding on reinforcing wire

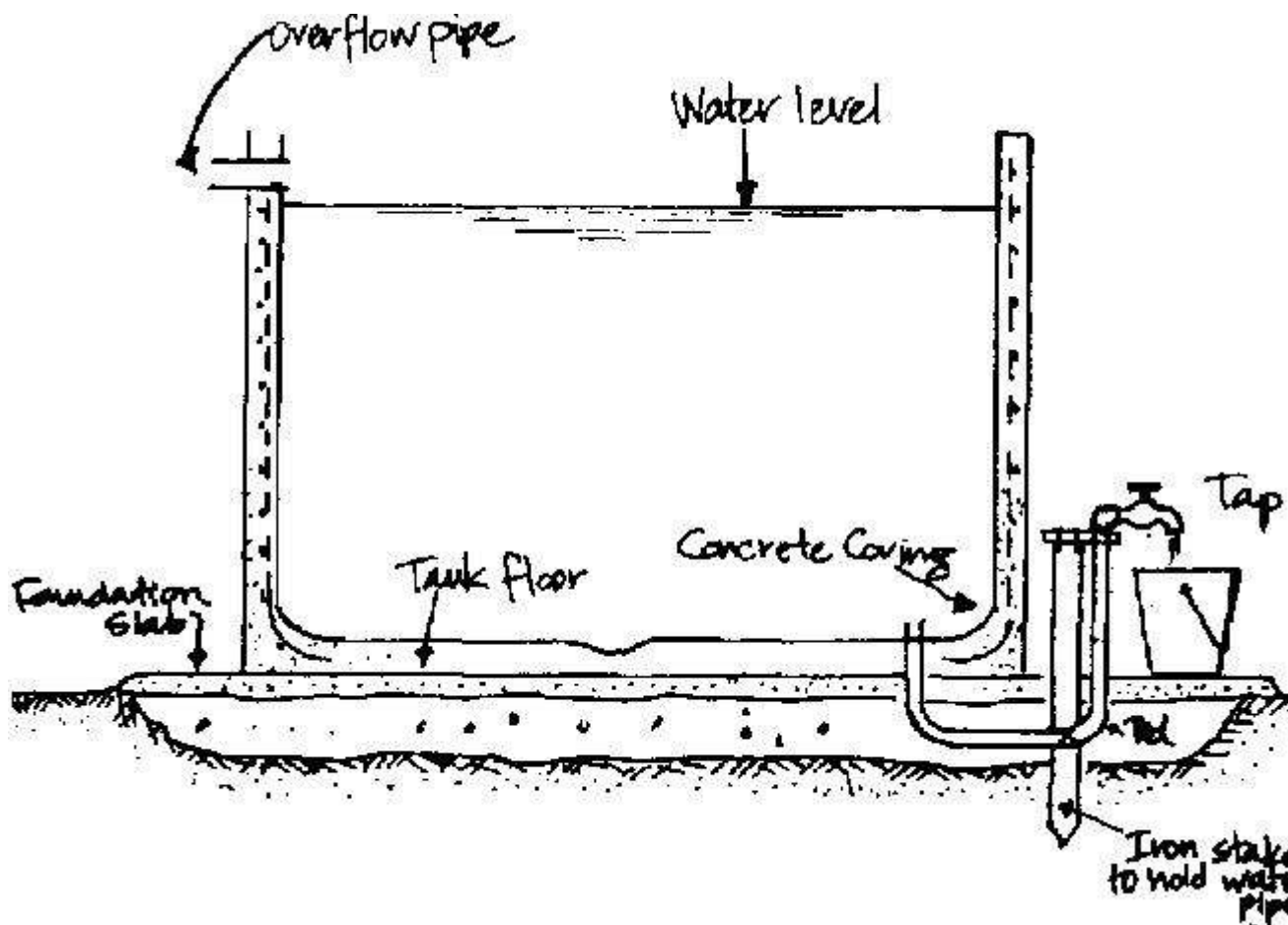

Figure 22: The completed tank

About 200 meters of wire will be needed (weight 78.0 kg). The chicken wire must be wound tight enough to hold the straight wire out of the valleys in the corrugations. If the straight wire is bent, it can be straightened by making and using a special tool (Diagram 31, Figure 16). A wrench or a pair of pliers may be able to do the same job.

When building ferrocement biogas digesters, use two wires in all corrugations and two layers of mesh wire in the end pieces. Because digesters lie on their sides, the stress on the concrete may be greater.

The concrete is applied by hand to the wire covered walls with a plasterer's steel float in layers not greater than 1.0 cm ($\frac{1}{2}$ inch) thick because thicker layers tend to fall off. The concrete which has already been prepared at the mixing slab is carried to the side of the tank and emptied onto a square board (A). This board prevents dirt from becoming mixed with the concrete and catches any concrete that falls off of the wall during troweling. The concrete is scooped off this board using a plasterer's float (B) and a builder's hawk (C). The concrete is then transferred back onto the face side of the float and pressed into the formwork (Diagram 31, Figure 17).

The concrete is troweled onto the formwork from the base of the tank upwards to

fill the corrugations and just barely cover the reinforcing wire. The walls are built up in this way in horizontal sections around the tank. The square board is kept under the section being worked on. Some experts say that vibrating the float as the concrete is pushed into the formwork will help the concrete penetrate the wire mesh so that there will be no air pockets.

When the first layer of concrete has hardened sufficiently, the surface is brushed rough or scratched so that it will be easier for the second layer to stick to the first layer. The 1.0 cm (3/8 inch) thick second layer, which provides the outside surface, is finished with a smooth surface. It must be well bonded to the first layer, which should be only a day or so old when the second layer is applied.

Concrete must be applied quickly. If it is more than half an hour old, it should be used to make a floor slab or concrete path. The concrete quickly becomes unworkable without adding an excessive amount of water that would weaken the final product. In hot climates the concrete pile should be covered with wet sacks or plastic to prevent rapid drying.

In order to make tanks more watertight and airtight, an asphalt seal can be used between the two layers of concrete. The seal is not necessary; it is extra protection. The asphalt seal (bitumen emulsion) is applied in two layers. The first layer is mixed with water--one part asphalt, three parts water. The second layer contains no water. After the asphalt seal has dried, the second layer of concrete can be applied.

After the second layer of concrete has had a day or two to dry, the formwork is removed by removing the holding bolts and pulling out the wooden wedges which will leave the formwork free to be pulled away from the inside of the concrete tank. The sections are then lifted clear of the tank, cleaned of all concrete, and stored for later use.

DIAGRAM 33

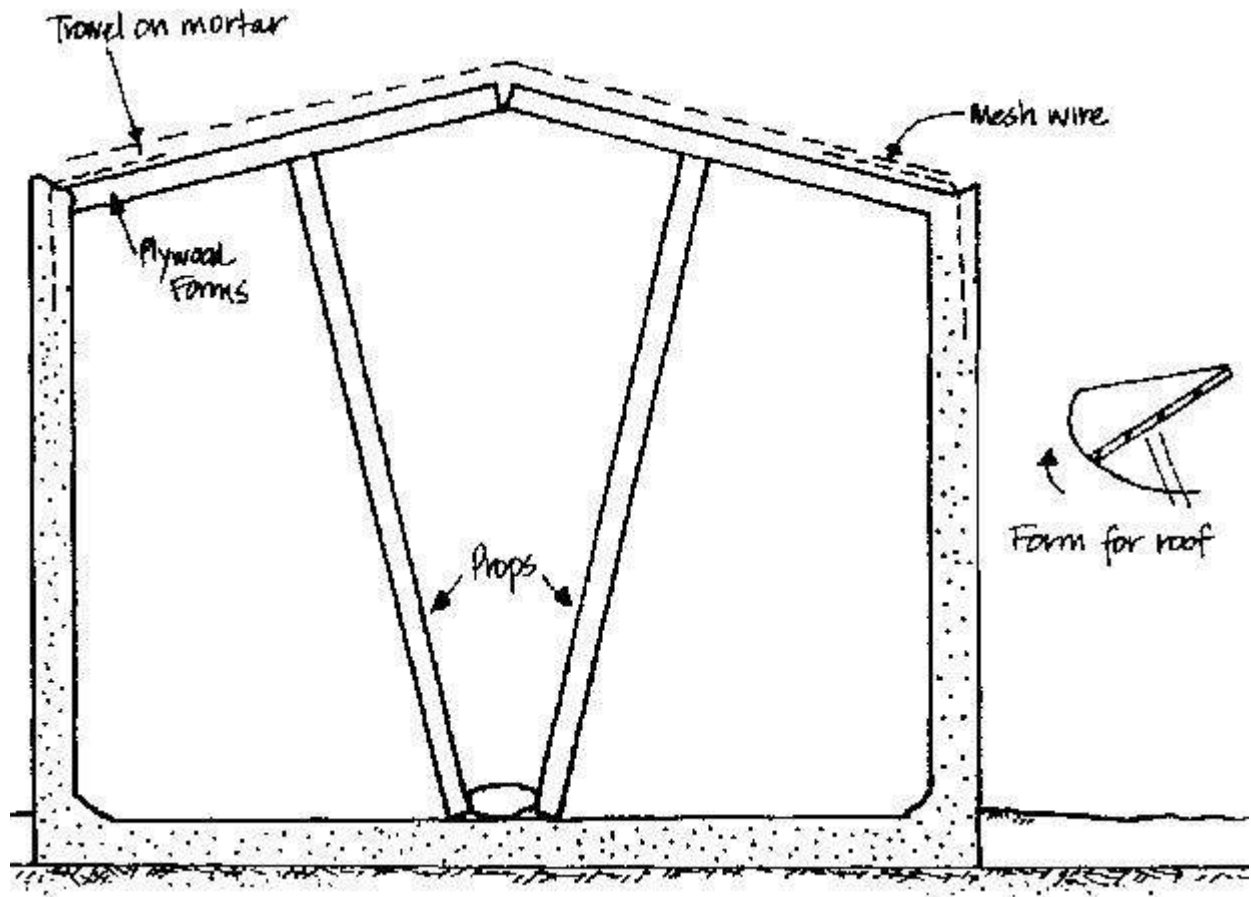

Figure 31: Constructing the roof

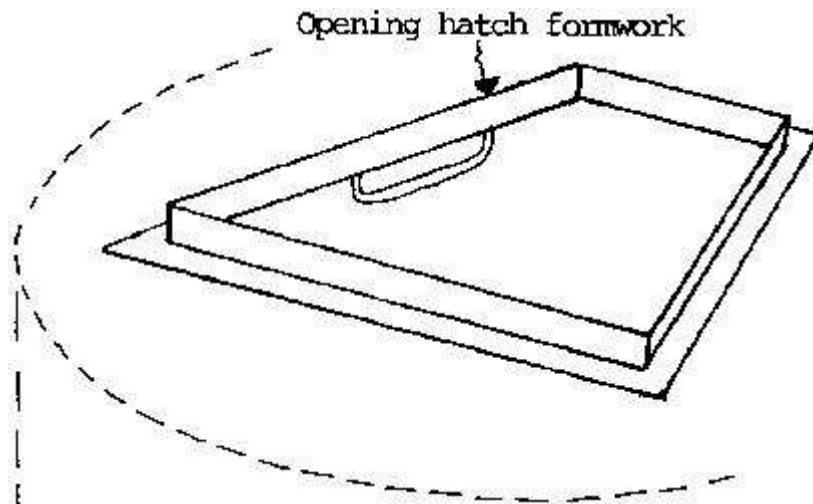

Figure 32A: Making the access hatch

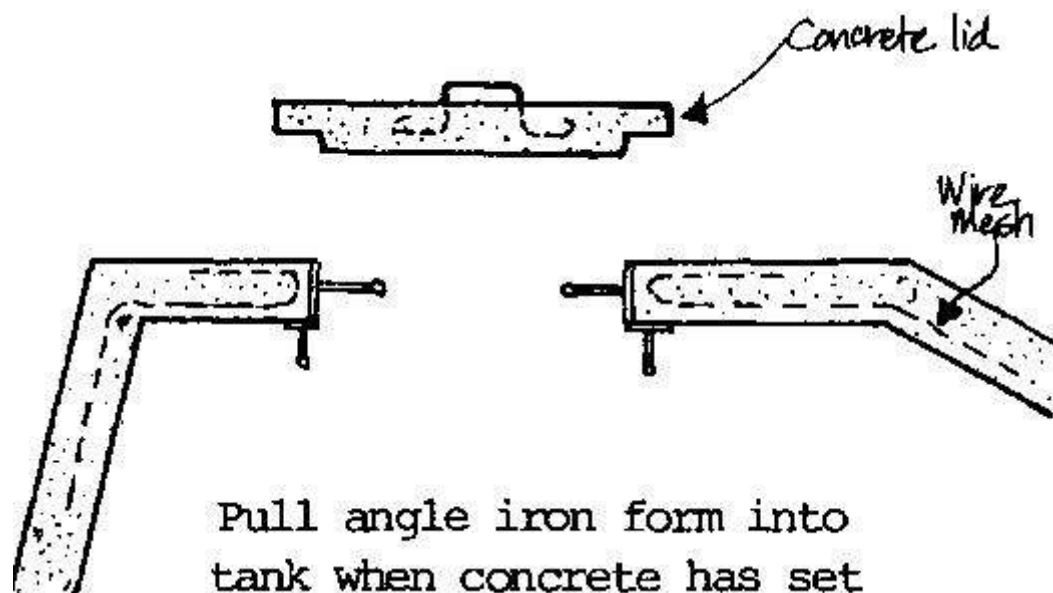

Figure 32B: Making the access hatch

The exposed corrugated concrete on the inside of the tank is brushed rough, and two 1.0 cm (3/8 inch) layers of concrete are troweled on a day or two apart to fill up the corrugations and cover up any exposed reinforcing wires. The methods for applying the concrete on the inside are the same as those used on the outside of the tank.

If the tank has to be left overnight with a layer incomplete, the top edge of the concrete should be at the same height all around the tank. On the next day, the joint should be brushed rough and coated with a cement and water mix to make a strong bond before applying fresh concrete. It is best to complete any one layer in the same day. If that cannot be done, finish a complete band around the tank. Concrete joints will then only occur on a horizontal line. Vertical joints are more likely to crack when the concrete dries.

Roof: The tank can have a galvanized iron sheet roof supported by angle-iron, or a reinforced concrete roof can be made. A ferrocement roof is built onto a tank by laying concrete onto shaped formwork which is supported from below (Diagram 32, Figures 31 and 32). The roof is reinforced with two layers of mesh wire which are tied onto mesh wire coming out of the top of the walls. A prefabricated angle-iron frame is set into the wire mesh to provide formwork for an access hatch into the tank.

This is how both ends should be built when making digesters, though of course only one access hatch will be needed.

Concrete is troweled onto the roof in 1.0 cm (3/8 inch) layers with two layers of mesh wire in the middle and allowed to slowly dry over a seven day period. When the concrete is strong enough, the roof and access hatch formwork is removed and two 1.0 cm (3/8 inch) layers of concrete are troweled onto the bottom of the tank

roof and the access hatch. Do not add a concrete roof to a concrete tank until the walls are strong enough to hold it; that will be at least several days after the walls have been finished.

Applying concrete to a tank may look difficult at first, but most people can learn within a few hours. The secret is to apply well-mixed concrete quickly and firmly with the float and work it smoothly over the wall. The surface finish is not of greatest importance on water tanks. What is important is that the layers be of uniform thickness throughout, with no gaps or weak spots.

Drying the tank: After the concrete has been applied, the tank should be covered with black plastic or wet sacks. If the drying concrete is exposed to hot sunlight or wind, it will dry too fast and the final strength will be greatly reduced. Loss of moisture at too fast a rate enlarges the shrinkage cracks that form in the drying concrete and can lead to tank failure.

In very hot weather, tanks must be covered anytime work is stopped. In milder weather, the tanks can be left uncovered except at night. When finished, keep the tanks covered for seven days or more to allow the concrete to slowly dry. The concrete should be sprayed with water as often as three times a day for the seven days. The concrete will take at least one month to reach its full strength, and for the first few days it will be soft enough to allow holes to be cut in it for pipes.

Slow drying is absolutely necessary for strong, waterproof tanks. It is one of the most important construction steps. It is also one of the most difficult things to guarantee in the field.

Filling the tank with water: Concrete shrinks as it dries. If the tank is filled rapidly with water, the concrete will not have enough time to expand again as it reabsorbs water. There is a great risk of severe cracking or even tank failure. An empty tank (or biogas digester), especially a new one, should always be filled over a several day period. It should be left for a week or so with only a shallow depth of water before complete filling is begun.

Materials needed for a ten cubic meter water tank (roof not included): 600 kg of cement, 200 meters of 2.5 mm diameter straight wire, 20 meters of 50 mm mesh and 1.0 mm wide chicken wire, water pipes, water tap, gate valves, overflow pipe, one cubic meter of sand, and 0.5 cubic meter of gravel.

The ferrocement information described above can be used to make water tanks, concrete biogas digesters, the water tanks for concrete biogas storage tanks, or just about anything that can be made out of concrete, including boats.

Remember that whatever is built should be built on the ground where it is to be used and that it will be hard to construct if it is too small to be worked on from the inside.

In this ferrocement design, gravel is not used except in foundations which are not really part of the ferrocement structure. The foundations are beds upon which the floor of the ferrocement tanks are built. Thin steel reinforcing rods can be added to the mesh and straight wire reinforcement, but they are not necessary in small tank (ten cubic meter capacity or less) construction. Ferrocement walls are thin, usually only 2.0 cm (3/4 inch) to 10.0 cm (4.0 inches) thick, but they are very strong.

If these directions are adapted to design a concrete biogas digester, two layers of mesh wire should be used at both ends of the digester. Digester walls can use the straight wire and mesh wire combination for digesters of ten cubic meters capacity or less. Digesters with capacities between ten and 100 cubic meters should probably use two layers of mesh wire. Building digesters with capacities larger than 100 cubic meters will require a more complicated level of ferrocement techniques than those described here. VITA should be able to help anyone interested in more information on different ferrocement techniques.

If it becomes too complicated to make totally round ferrocement biogas digesters, try making the digesters with flat floors and round walls and roofs. The sides of the floor should tilt down a few degrees towards the center line of the digesters. This tilt, in addition to the few degrees tilt down from inlet to outlet (necessary to the biogas digestion process), will make the digesters easier to clean than completely level floors would be.

Keeping the walls and roof curved will make for stronger digesters. The walls and floors should be connected with overlapping mesh wire. Concrete coving should be used on the insides of the tanks where floor meets wall.

A few ideas on making concrete digesters watertight and airtight:

1) Make a cement paste, replacing five to ten percent of the water with poly vinyl acetate latex paint. The combination can also be used as a paint to coat the inside or outside of a digester or gas tank.

2) Sodium silicate can be mixed with cement for patching gas, digester slurry, or water leaks. The sodium silicate and cement solution will harden in the mixing bucket within two to three minutes. To make a large area airtight, extra water can be used when making the mixture.

3) Paint the concrete with a chlorinated rubber-based coal tar or bitumen paint in order to make sure the concrete is completely airtight and watertight.

4) Wet new concrete three times a day for seven days. Cover the concrete with moist sacks and make sure the cover is kept wet. It is very important not to let the sun dry the concrete too quickly. Slow drying, called curing, gives concrete much of its durability, strength, and helps make it watertight and airtight.

There is a Chinese method of sealing concrete digesters against leaks that does not cost very much, does not kill biogas producing bacteria, and does not harm the fertilizer value of the sludge. It is the paraffin/wax method. The following description of the method is adapted from the book Chinese Biogas Digester by Charles H. Nakagawa of the U.S. Peace Corps and Q. L. Honquilada of The Philippine Rural Reconstruction Movement.

The tools needed to apply the paraffin/wax are: a blow torch, a large paint brush, an old pot or tin can to melt the wax in, a small bowl or can with a wide mouth to hold the melted wax while it is being applied, and a steel brush.

The sealing of the inside surface of a concrete digester should be done at least two weeks after the concrete work has been completed.

The steps involved in paraffin/wax application are as follows:

1) Inspect the inside of the digester carefully.

1.1) Check for cracks or weak sections that make a "hollow" sound when tapped. If there are problems, make repairs.

1.2) Check for dampness by spreading cement powder on the concrete to see if it "wets" the cement. If a wetting or leak rate is fast, concrete repair is necessary.

1.3) Check for water on the floor of the digester. If there is any, it should be dried up and the floor should be checked again on the next day. If the water returns, there is a leak that has to be repaired.

Use the dry cement powder method to determine where the leak is coming from.

2) If there are no damaged areas in the digester, clean the walls and floor of loose concrete and sand particles with a steel brush. Wax sticks to rough surfaces much better than it sticks to smooth surfaces.

3) Use colored wax if possible. Colored wax makes it easy to see which sections have been painted with wax.

4) Melt the wax and carefully add kerosene to the melted wax in a volume ratio of 3.0 parts kerosene to every 10.0 parts melted wax. This will lengthen the hardening time of the wax and make it easier to work with. Be careful when adding the kerosene to the melted wax over open fires--it may burst into flame!

5) Place the melted wax and kerosene mixture in a smaller, wide-mouth container and allow it to cool off a little. Very hot wax does not stick to concrete very well. The hot wax drips off the paint brush, wasting much of the wax and may also ruin the brush hairs. A good sign of a workable temperature for wax is when it starts to develop a thin skin or film on the surface.

6) Apply the melted wax with a paint brush.

6.1) Place the bowl of melted wax below the work area to collect any drippings or fill the bottom of the digester with water. Any dripping wax will float in the water and can be easily recovered.

6.2) Apply with up-strokes and by "splashing" the wax on the surface using the brush.

6.3) Paint from the bottom up, working towards the top.

6.4) When finishing a small area, use left-right-left and diagonal strokes. This will guarantee that most of the concrete is covered with a layer of wax.

6.5) Place extra wax around joints and corners.

7) When the inside of the digester has been completely covered with wax, smooth it and force it into the concrete with heat. Use a blow torch operating on a medium-high flame. Using a flow torch will change the wax finish into a smooth, continuous layer of wax. This wax layer should effectively seal the digester against gas and water leaks.

8) When using the blow torch, do not let the flame remain on one section too long. This will burn away all of the wax and the high heat may crack the concrete, Constant left-right-left and circular motions work best.

9) After blow torching, there will be many very small holes visible. These areas will need "touch-up" patching with another layer of wax and blow torch application. Inspect again and repeat if necessary.

After a concrete digester has been in operation producing gas for a few weeks, it would be a good idea to check the walls and roof for leaks. Leaks below the slurry level should be easy to spot. For biogas leaks above that level, pour very soapy water on the concrete. If gas is leaking, fine bubbles will appear in the soapy water. A coat of adhesive cement should be applied to any area that fails the soap test. After the adhesive cement has dried, the area should be tested again for leaks.

Using concrete culverts to make digesters or water tanks for gas storage tanks can cause more problems than they are worth. Concrete culverts often sweat water under normal conditions. They are made strong enough to hold water underground, not aboveground. They are not made airtight or watertight. They often crack if used aboveground. If concrete culverts are used, at least one layer of cement or asphalt sealant will be needed. The least expensive method for making concrete digesters and gas storage tanks is to use the ferrocement method.

Facts & Figures

Conversion Tables

Units of Length:

1 centimeter (cm) = 10 millimeters (mm) = 0.39 inches

1 meter = 100 centimeters = 39.37 inches = 3.28 feet

1 kilometer (km) = 1,000 meters = 0.62 miles

1 inch (in) = 2.54 centimeters

1 foot (ft) = 12 inches = 0.30 meters

1 yard (yd) = 3 feet

1 mile = 1,760 yards = 1.61 kilometers

Units of Area:

1 square centimeter (sq cm) = 0.15 square inches

1 square meter (sq m) = 10.76 square feet

1 hectare = 10,000 square meters - 2.47 acres

1 square inch (sq in) = 6.45 square centimeters

1 square foot (sq ft) = 0.69 square meters

1 acre = 4,840 square yards = 0.40 hectares

Units of Volumes and Capacity:

1 milliliter = 1 cubic centimeter = 0.33 fluid ounces

1 liter = 1,000 milliliters = 0.26 US gallons = 0.22 Imp gallons

1 liter = 0.001 cubic meters = 0.035 cubic feet

1 cubic meter (cu m) = 1,000 liters = 264.2 US gallons

1 cubic meter = 35.31 cubic feet = 993 kg of water = 2,184 lb of water

1 fluid ounce = 30 milliliters

1 US gallon = 64 fluid ounces = 0.13 cubic feet = 3.78 liters = 8 pints

1 cubic foot (cu ft) = 1,728 cubic inches = 7.48 US gallons

1 cubic foot = 28.3 liters = 0.028 cubic meters = 62.4 lb of water

Units of Weight:

1 gram = 1,000 milligrams = 0.035 ounces

1 kilogram (kg) = 1,000 grams = 1 liter water = 2.2 pounds

1 ounce = 28.35 grams

1 pound (lb) = 16 ounces = 0.45 kilograms

Units of Pressure:

1.0 foot of water = 0.433 pounds per square inch (psi)

1.0 kilogram per square centimeter = 14.22 pounds per square inch

1.0 pound per square inch = 0.07 kilograms per square centimeter

1.0 pound per square inch = 27.7 inches of water

Units of Power:

1 horsepower (English) = 764 watt = 0.746 kilowatt

1 horsepower (English) = 1.0139 metric horsepower

1 metric horsepower = 736 watt = 0.736 kilowatt = 0.98 HP/English

1 kilowatt (kw) = 1,000 watt = 1.34 horsepower HP/English

Digester Dimensions

Dimensions of the volumes of the insides of round digesters: volume of digester in cubic meters = radius x radius x 3.14 x length.

digester volume	length	diameter	ratio of length/diameter
	in meters		
1.3 cubic meters	3.5 m	0.7 m	5.0/1
2.2 cubic meters	4.3 m	0.8 m	5.4/1
3.2 cubic meters	5.0 m	0.9 m	5.5/1
5.3 cubic meters	5.6 m	1.1 m	5.1/1
10.6 cubic meters	6.9 m	1.4 m	4.9/1
20.6 cubic meters	9.1 m	1.7 m	5.3/1
30.9 cubic meters	10.9 m	1.9 m	5.7/1
41.0 cubic meters	10.8 m	2.2 m	4.9/1
51.1 cubic meters	12.3 m	2.3 m	5.3/1
61.3 cubic meters	12.5 m	2.5 m	5.0/1

Dimensions of the volumes of the insides of rectangular digesters: volume of the digester in cubic meters = length x width x height.

digester volume	length	width	height	ratio of length/ width x height
	in meters			
1.2 cubic meters	2.5 m	0.8 m	0.6 m	5.2/1
2.2 cubic meters	3.5 m	0.9 m	0.7 m	5.5/1
3.2 cubic meters	4.0 m	1.0 m	0.8 m	5.0/1
5.2 cubic meters	5.3 m	1.1 m	0.9 m	5.3/1
10.4 cubic meters	7.3 m	1.3 m	1.1 m	5.1/1
20.5 cubic meters	10.5 m	1.5 m	1.3 m	5.4/1
30.7 cubic meters	12.8 m	1.6 m	1.5 m	5.3/1
41.1 cubic meters	15.1 m	1.7 m	1.6 m	5.5/1
51.1 cubic meters	16.7 m	1.8 m	1.7 m	5.4/1
61.2 cubic meters	17.9 m	1.9 m	1.8 m	5.2/1

When the cubic measurement of a container is referred to, it is usually in cubic feet or cubic meters. It is the volume, the capacity of the container that is being talked about. When people talk about the size of a biogas digester, they are usually talking about the digester's capacity in cubic feet or cubic meters. In this book it will always be in cubic meters.

The actual volume of the insides of the digesters that are listed above are all a little bit bigger than they should be (such as 5.3 cubic meters instead of 5.0 cubic meters). A little extra space has been added to each digester so that the chances of overfeeding a digester are reduced.

One extra step has to be added before checking the 5:1 ratio on rectangular digesters if the measurements are in feet --divide the result of multiplying the "width x height" by 3.28 or change the feet into meters.

The digester sizes listed above are just examples. If there is a need for a different size, the charts and the equations can be used as guides to figure out the dimension.

The ratios between the length and the diameter of the round digesters and between the length and the surface area of a cross section of the rectangular digesters are also listed in the chart. Any ratio between 3:1 and 9:1 is ok. It is just that a 5:1 ratio is one of the variable factors like a slurry temperature of 35 degrees centigrade (96° F), an acid/base balance of pH 7.0 to 7.5, and a carbon/nitrogen ratio of 30. When the variable factors are all at their best, the digester's biogas production rate and the sanitary quality of the biofertilizer will be at their best.

A 1.0 cubic meter digester is a demonstration model. A 1.0 cubic meter digester has almost the same capacity as five 55-gallon oil drums. The 2.0 and the 3.0 cubic meter digesters are small family-size digesters. Depending on family size, they could be used to meet a family's cooking needs. Remember, digesters will produce less gas during cold weather and rainy seasons, so a digester that is big enough most of the year, may not be big enough all of the year.

A 5.0 cubic meter digester is either a large family digester or a small business digester. The larger digesters are definitely business and cooperative-size digesters. A 10.0 or a 20.0 cubic meter digester may be large enough to economically fuel a stationary engine. The engine could run pumps, small machines and electric generators, or anything that can be powered by stationary engines. The excess engine heat could be used to heat the digester.

I believe that digesters smaller than 5.0 cubic meters will cost more in time and money than they are worth. The smallest digester I would want to build would have a capacity of ten cubic meters. But I would prefer to risk my time and money on larger systems operated as business or cooperative enterprises. The costs of business systems are bigger than the costs of family systems but so are the chances of making money instead of losing money.

Digester Building Materials

When using metal to make digesters or gas storage tanks, use rolled sheet metal (often called mild steel) or galvanized iron (GI), if it is available in large enough sheets to make its use economical. In either case, the sides should be made from 22 gauge metal and the end pieces from thicker 20 gauge metal. The metal sections should be welded together or first riveted, then soldered. (Warning: The hydrogen sulfide in biogas will dissolve lead solder.)

The following two paragraphs are adapted from the **Guidebook on Biogas Development**. In most countries mild steel is the material which costs the least. Its disadvantage is that it rusts. Usually it is only possible to wirebrush or sandpaper the steel to remove rust before the metal is painted. Ideally, the steel should be sand- or grit-blasted to remove all rust and millseals (the dark blue or black color on new steel) prior to painting. If this is done properly, the life of the paint will be about **three** times longer than the life of the same paint applied on wirebrushed

steel.

The best paints for rustproofing seem to be:

- **Low cost--red oxide primer (one coat) followed by enamel paint (two coats).**
- **Medium cost--anti-saline primer (one coat) followed by high-build black bitumen (two coats).**
- **High cost--epoxy primer (one coat) followed by epoxy paint (two coats). Epoxy paint should only be used on sand- or grit-blasted steel.**

The life of mild steel and galvanized iron could be extended greatly if it is painted on a regular basis or whenever rust appears. Galvanized iron is a low-cost metal, but the joints should be soldered as mastic glue dries, allowing gas and water to escape. Paint does not easily stick to new galvanized iron unless the metal is pretreated with a special preparation sold by large paint companies. If not painted, galvanized iron has a life expectancy of about five years. If properly painted and maintained, galvanized iron, like mild steel, should give many years of good service,

Metal digesters and gas storage tanks can be made with the same types of metal that water tanks are made of and by the same welding shops that make water tanks. e All surfaces must be painted with asphalt or other rustproofing paint, and the outside surfaces should be painted with black enamel paint in addition to the rustproofing paint. The black color of the paint will help the digester absorb more heat.

- **Painting the inside of metal digesters and tanks before welding and soldering work is done, will not work. The paint will crack and peel away from the hot metal.**
- **After the welding or soldering work is finished and the metal has cooled, pour an epoxy primer paint or a plastic paint such as Nylon-60 into the digester. To completely cover the inside of the digester with paint, slowly turn the digester over several times, then pour out the excess paint.**
- **The inside surface of galvanized iron digesters must be painted because the zinc galvanizing can kill the biogas-producing bacteria.**
- **If a metal digester is big enough for a person to crawl inside to do the necessary painting, remember that most paint fumes are dangerous, especially when breathed in an enclosed space. Paint fumes can kill. Asphalt paints are the only relatively safe paints.**

If it is available from a local hardware store, put what is called pipe joint compound on the threads of all metal pipe to metal pipe connections. Use a pipe

joint compound that does not contain lead because biogas destroys lead. The compound will improve the gas-tight quality of the joint, and if the piping system has to be changed in the future, the compound will make it easier to unscrew the pipes from each other because the compound prevents the rust caused by the moisture in biogas from forming on the metal threads.

Red Mud Plastic Bag Biogas Digesters

There is a method of making biogas digesters out of plastic bags. According to the manufacturer, more than 1,000 plastic bag digesters are now in use in Taiwan and more than 60 are in use in the Philippines, Tahiti, Hong Kong, Egypt, Thailand, Singapore, Australia, Brazil, and Paraguay. Red mud plastic is also made into a rigid, hard type of plastic, but so far biogas digesters are just being made from plastic sheets. The digesters look like very large, very long sealed bags with an inlet, an outlet, and a gas pipe coming out of the top near the inlet (Diagram 34).

DIAGRAM 34: RED MUD PLASTIC DIGESTER

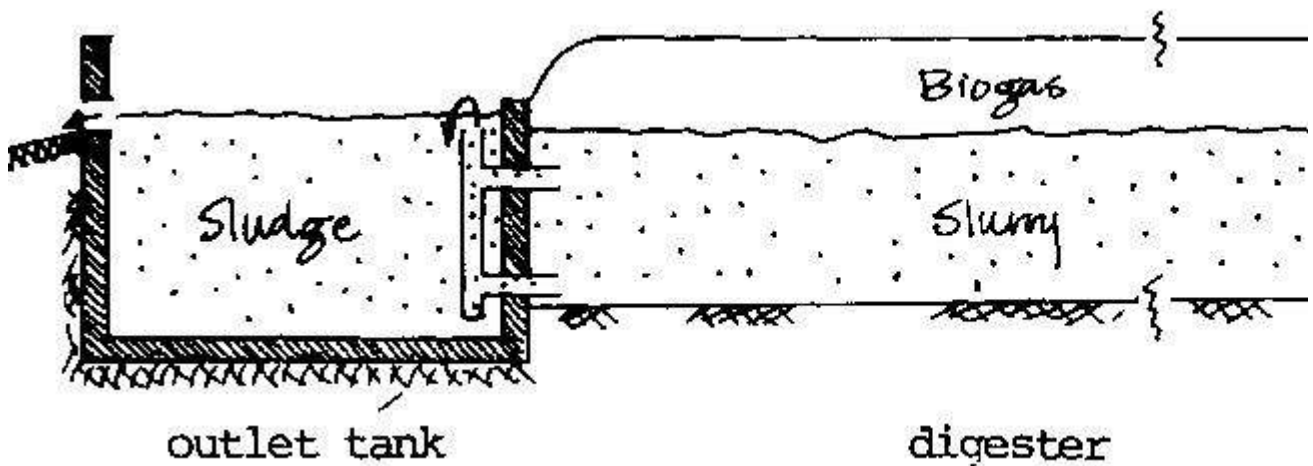

outlet tank & digester & inlet tank

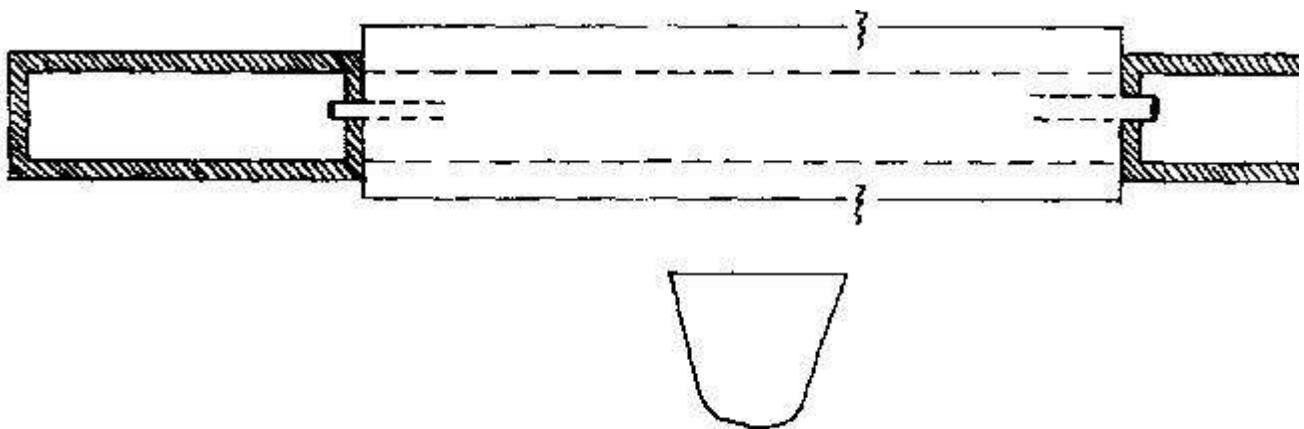

transverse (crosswise) section of trench

transverse (crosswise) section of trench

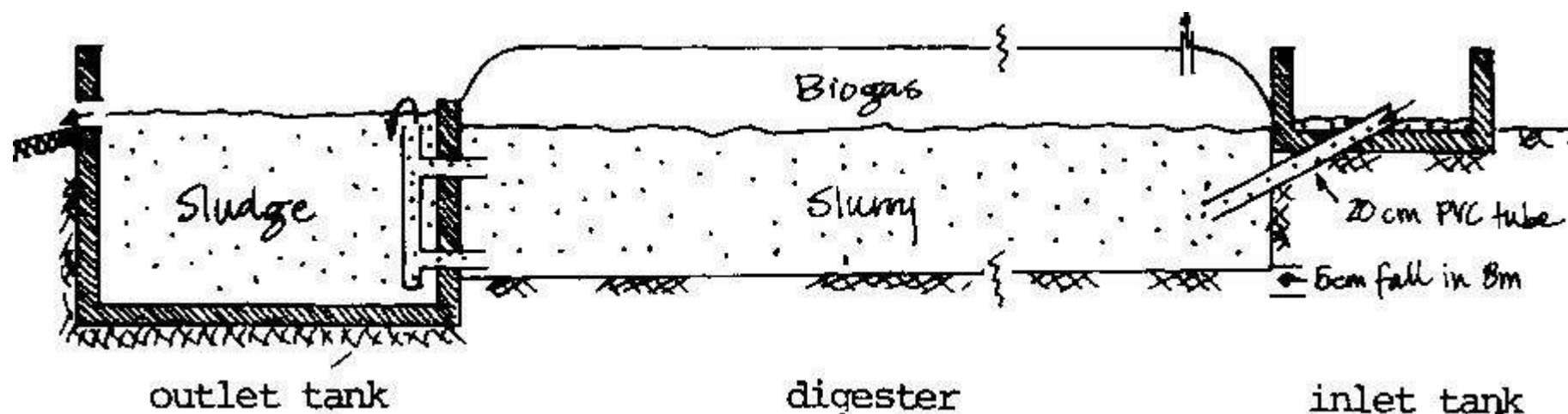

outlet tank & digester & inlet tank

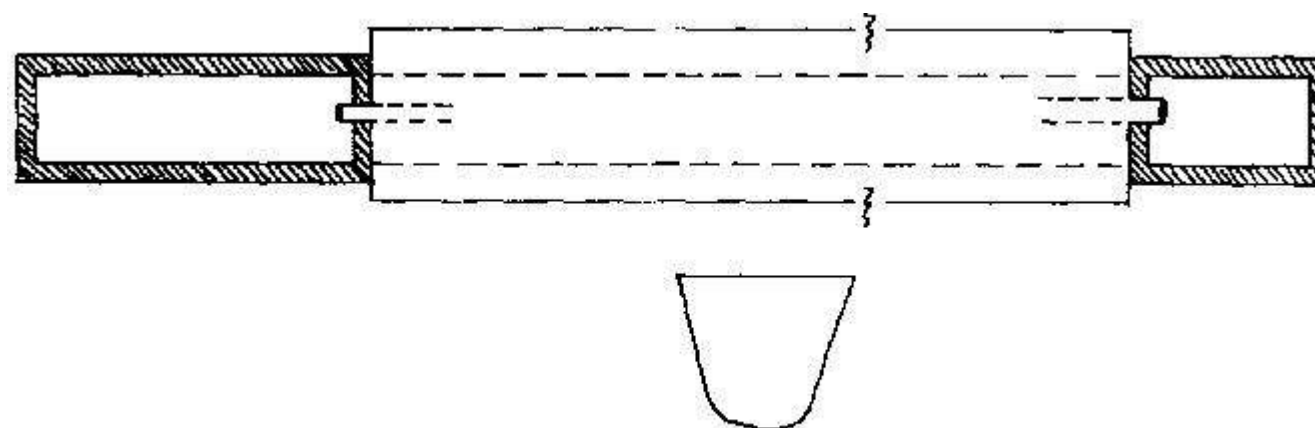

transverse (crosswise) section of trench

transverse (crosswise) section of trench

Red mud plastic is a strong plastic which, according to the manufacturer, is ideal for many agricultural purposes because it does not get brittle and crack as fast as most plastics will when exposed to years of direct sunlight. It is flame resistant (but not fireproof) and can be made into either a flexible film or a rigid plastic,

Red mud plastic is easy to repair; a simple patch of the same material can be heat welded onto a hole or cut. Red mud plastic should last more than ten years and maybe as long as 30 years. The plastic gets its name from the waste product called "red mud" that is left over after bauxite ore is used to make aluminum metal. For every ton of aluminum produced, a half ton of red mud is also produced. The plastic is being made by mixing the red mud with (new or used) poly vinyl chloride (PVC) plastic and used engine lubricating oil.

Red mud plastic is a strong plastic which, according to the manufacturer, is ideal for many agricultural purposes because it does not get brittle and crack as fast as most plastics will when exposed to years of direct sunlight. It is flame resistant (but not fireproof) and can be made into either a flexible film or a rigid plastic,

Red mud plastic is easy to repair; a simple patch of the same material can be heat welded onto a hole or cut. Red mud plastic should last more than ten years and maybe as long as 30 years. The plastic gets its name from the waste product called "red mud" that is left over after bauxite ore is used to make aluminum metal. For every ton of aluminum produced, a half ton of red mud is also produced. The plastic is being made by mixing the red mud with (new or used) poly vinyl chloride (PVC) plastic and used engine lubricating oil.

Any country that makes aluminum or plastics should look into the possibility of buying the rights to manufacture red mud plastic products. Where local aluminum industries do not exist, blocks of red mud plastic could be imported and fabricated into products. In these ways, long-lasting agricultural plastic products could be designed for local markets, reflecting local needs and conditions.

The makers of red mud bag digesters claim that the digesters are easy to manufacture, easy to install, easy to transport, easy to maintain, and easy to clean. They say that red mud plastic makes better digesters than those made from other plastics, metal, or concrete. They do add a warning. Even though the plastic bags are strong, it would be very dangerous to walk on the digesters or drop heavy or sharp objects on them. The bags should be protected from these dangers. Red mud digesters, like all digesters, should be heated. Plastic hot water pipes running through a layer of concrete under the digester would heat the digester and the concrete would protect the plastic digester from the colder ground and from attack by insects, rats, and mice.

In Volume 6, Number 2, 1981 issue of the Mexican magazine, "Tropical Animal Production," B. Pond and others wrote an article on the use of a red mud digester in the Caribbean island nation of the Dominican Republic. Diagram 34 shows how the digester was set up.

There was no gas storage tank, so approximately 5.0 cubic meters of the 15 cubic meter digester was used for gas storage. The concrete inlet tank was built big enough to hold one day's slurry load, and the concrete outlet tank was built to hold five day's worth of sludge.

The digester was placed in an unlined trench to support the weight of the slurry. Because the digester was not heated, the average digester temperature was 27 degrees centigrade. Using manure from 15 head of cattle that were kept in a building with a concrete floor, a slurry was made which was only six percent solids (a manure to solids ratio of approximately 1:2). A detention time of 40 days

was used and the daily slurry put in and sludge removed volume was 250 liters. The digester was on a slight downhill tilt and the sludge flowed by gravity to fertilize vegetable gardens.

The rate of biogas production was only 0.5 cubic meters of gas per cubic meter of slurry volume. This very low rate of gas production is probably due to the cool operating temperature of the digester. More gas could be produced if the trench was lined with concrete in which hot water pipes were buried in order to heat the digester. It is also possible that a method could be devised to run the heating pipes through the digester itself. Building a greenhouse over the digester would also raise the slurry temperature.

A higher gas production rate could also be produced by reducing the manure to water ration from 1:2 to 1:1.2 or 1:1.5 so that the solids percentage of the slurry would go up from six percent to approximately ten percent. A separate gas storage tank would also help increase gas production. When the biogas is not used fast enough on a continuous basis in a combination digester and gas storage tank, undigested waste is forced out of the digester. A clue that the Dominican Republic digester could produce more gas is the fact that biogas continued to bubble out of the sludge in the outlet tank.

The cost of the 15 cubic meter red mud digester, including shipping to the Dominican Republic (no import tax) and the installation, was US\$ 890 in 1980. When compared with other digester designs, the red mud digester was considered by those that used it to be inexpensive, easy to install, and with adequate management, easy to operate. The payback period on the digester was estimated at two and one-half years, using bottled gas (propane) as the only basis for comparison. The value of the fertilizer was not used in the payback comparison.

The June, 1982, export prices (shipping not included) for red mud digesters from Taiwan include: US\$ 930 for a 15 cubic meter digester; US\$ 1,050 for a 20 cubic meter digester; US\$ 1,240 for a 30 cubic meter digester; and US\$ 1,820 for a 50 cubic meter digester. The red mud digesters have length to diameter ratios ranging from 2.4:1 to 8:1 in the 15 to 50 cubic meter capacity size range.

As of 1982, red mud plastic was not being used to make the small diameter, flexible pipe which is used for piping biogas for digester to storage tank to use. It would be worth writing the manufacturer to encourage them to produce both flexible and rigid pipe in the ¼ inch to 2.0 inch diameter size range. Red mud plastic pipe would have the advantage of lasting longer than uncovered ordinary plastic pipes, although it would have the disadvantage of not being transparent. It would be impossible to see condensed water blocking the pipes, but if the pipes are laid out correctly, all water should drain into condensation traps.

For current information and prices on red mud agricultural, fish pond, and biogas digester products, write the Taiwan manufacturer. The person to write to is: Daniel F. Lee, President; Lupton Engineering Corp.; 12F-1, Chung Nan

Building E; 7 Tung-Feng St.; Taipei, Taiwan, R.O.C. The telex and cable addresses are--TLX: 20246 Daniel Taipei and CABLE: Lenco, Taipei.

Important Digester Loading Rates Information

The organic waste (human, animal, or plant) going into a digester is mixed with water. The liquid portion of the used sludge can be used instead of water, but only after it has been strained of its ten percent solids portion. The solids can be used as fertilizer after being dried in the sun. If the liquid portion is not used to dilute fresh waste, it must be aged in a pond before it can be safely used as a fertilizer.

The organic waste that feeds a biogas digester is only supposed to stay in the digester for a certain number of days; after that time, very little additional biogas can be produced.

All digesters have a limit as to the amount of waste that can be put into them in any one day. The waste will be pushed through the digester too fast and less gas will be produced if the digester is "fed" too much.

The following information shows how much slurry (waste plus liquid) to put into different size digesters.

1) Plant and animal waste is already part liquid; in fact the normal wet weight of pig manure is about three times what it would be if all of the water was cooked out of it: the dry weight.

Moisture content is different for different wastes. Cattle manure contains more water than pig manure, and chicken manure contains less water than pig manure. Digester slurry should be eight to ten percent total solids (the dry weight percentage). The total solids portion is what is left after the liquid portion has been "cooked" out.

2) To make sure the sludge that is taken out of the digester is not carrying any disease organisms, the slurry should stay in the digester for 40 days; this is called the detention time. In other words, 40 days is the total time that any one part of the slurry is in the digester. The daily slurry loading rate is 1/40 of the digester capacity.

3) The loading rate for wet pig manure is approximately ten kilograms per day per cubic meter of digester space. The ratio of pig manure to added liquid is 1.0 to 1.5. If the slurry is weighed in a container, such as a bucket, remember to subtract the weight of the bucket.

4) Take out of the digester a volume of sludge equal to the volume of slurry that is put in. Digesters should be fed at least once a day. Biogas production can be increased by dividing the daily slurry volume into two or more feedings, the more the better; but do not increase the total amount added per day.

Digester volume	=	detention time	x	daily slurry volume.		
digester size in cubic meters and liters	=	detention time in days	x	quantity of slurry added daily and sludge removed daily for pig manure, divided into waste and added liquid		
1.....1,000	=	40 days	x	10 kilo manure	+	15 kilo liquid/25 liters
2.....2,000	=	40 days	x	20 kilo manure	+	30 kilo liquid/50 liters
3.....3,000	=	40 days	x	30 kilo manure	+	45 kilo liquid/75 liters
5.....5,000	=	40 days	x	50 kilo manure	+	75 kilo liquid/125 liters
10...10,000	=	40 days	x	100 kilo manure	+	150 kilo liquid/250 liters
20...20,000	=	40 days	x	200 kilo manure	+	300 kilo liquid/500 liters
30...30,000	=	40 days	x	300 kilo manure	+	450 kilo liquid/750 liters
40...40,000	=	40 days	x	400 kilo manure	+	600 kilo liquid/1,000 liters
50...50,000	=	40 days	x	500 kilo manure	+	750 kilo liquid/1,250 liters
60...60,000	=	40 days	x	600 kilo manure	+	900 kilo liquid/1,500 liters

This slurry ratio formula is for pig manure. If plant waste is used, more liquid will be needed to achieve a ten percent solid content in the slurry. The waste to water ratio may be 1.0:2.0 or even higher. The higher the water content of the original waste, the less additional liquid is needed. The lower the liquid content of the original waste, the more additional liquid is needed. This table is only a guide.

The slurry, when it goes into the digester, should look like thin, watery mud (manure mud, plant mud, manure plus plant mud). The total number of liters going in and coming out of the digester remains the same; it is the ratio between waste and added liquid that changes--depending on the water content of the waste.

An example: Only cattle (water buffalo, carabao or milk cow) manure is used and there are 25 cattle, each producing nine kilograms of manure per day. Cattle manure has a higher liquid content than pig manure, so to maintain an eight to ten percent solids content in the slurry, a ratio of cattle manure to additional

water of 1:1 is used, not 1:1.5, which is the ratio for pig manure and water. The daily slurry volume is then 225 (25 x 9) kilograms of manure plus 225 liters of water (one liter of water weighs one kilogram) for an approximate total of 450 kilograms/liters of slurry.

To find the best size for a digester, multiply the daily slurry volume times 40 (the number of days it should take before one day's load is taken out of the digester). The total volume is 18,000 (450 x 40) and since there are 1,000 liters in a cubic meter, the volume of the digester should be 18 cubic meters (18,000 divided by 1,000), or better yet, 20 cubic meters to allow space for extra manure and/or plant waste.

Approximate total solids content of several digester fuel sources:

water lily (hyacinth)	11%
plant waste average	75%
grass	30-80%
kelp	11%
seaweed	33%
chicken manure (fresh)	35%
chicken manure (day old)	90%
pig manure	14%
human feces	27%
newspaper	93%

DIAGRAM 35: HYDROMETER

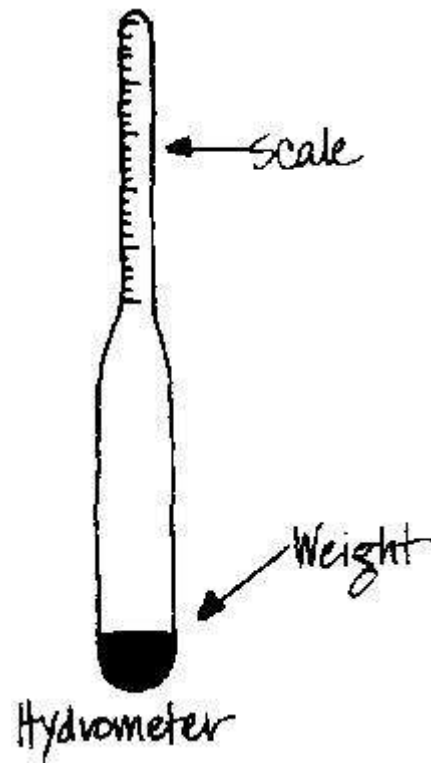

Hydrometer

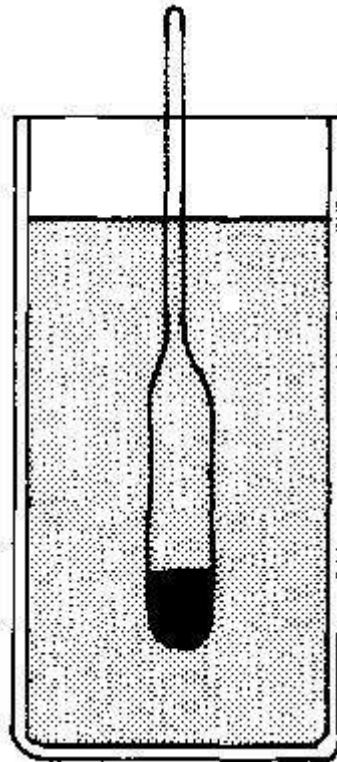

Slurry in glass jar

-Hydrometer floating in slurry; make sure there are no lumps and that the slurry is stirred in order to make an accurate reading.

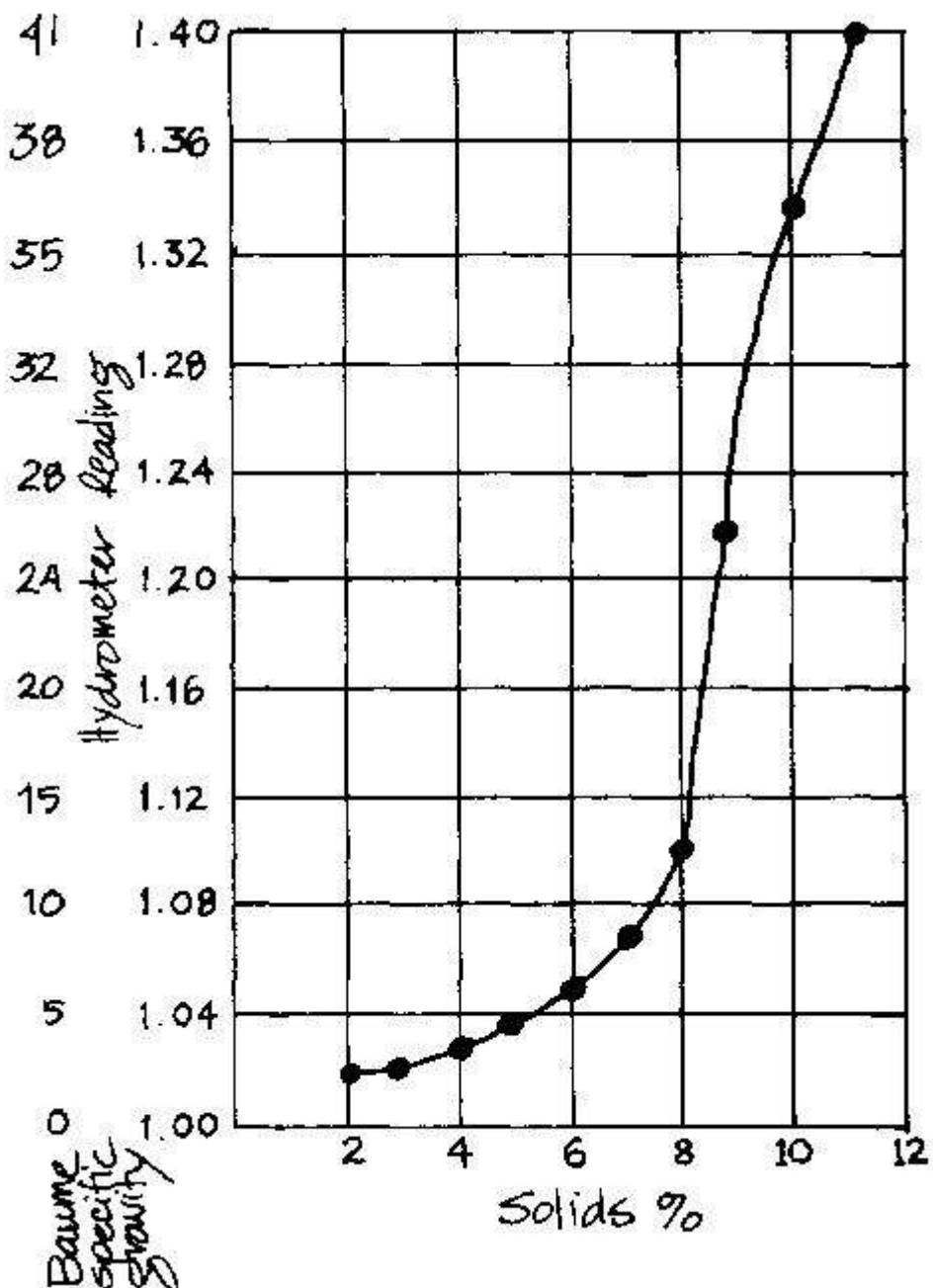

Relationship of percentage of solids to hydrometer readings.

A hydrometer is an instrument that can be used to measure the percentage of solids in a liquid such as digester slurry. There are several different types of hydrometers. A common design is used to measure the strength of car batteries. Do not use that type. Use the type shown in Diagram 35.

Make sure the hydrometer has a scale designed for the range 1.00 to 1.40 specific gravity (1.00 = water) or 0 to 40 Baume (0 = water).

If the hydrometer reading is between 1.10 and 1.34 specific gravity (12.5 and 36.5 Baume), then the percentage of solids in the slurry will be between eight and ten percent, which is what is wanted.

The best way to read a hydrometer is to look straight across at the scale. It is easy to get a false high reading when looking at an angle, because liquid often "rides" up the outside surface of the scale a few millimeters.

The smaller the pieces of organic matter in a slurry are, the more accurate a hydrometer reading will be. Make hydrometer readings on three separate batches of slurry, add the readings together, and divide by three to get an average (and more accurate) reading. Make sure the slurry samples contain the same percentage of solids as the slurry as a whole does, or the readings will not reflect what the solids percentage of the slurry is.

<u>pig weight</u>		<u>manure only</u>	
kg	lb	kg/day	lb/day
18-36	40-80	1.23	2.70
36-55	80-120	2.45	5.40
55-73	120-160	2.95	6.50
73-91	160-200	3.86	8.50

chicken manure per day

0.1 kilogram of manure from a 2.0 kilogram chicken

human (adult) waste per day

urine 1 liter (1 kilo)

feces 0.2 kilogram

cattle (full grown)

10 to 15 kilograms of manure per day

Biogas Facts

BTU stands for a common measurement of heat: British Thermal Unit. One BTU is the amount of heat needed to raise the temperature of one pound of water one degree Fahrenheit. It takes 3,413 BTUs to equal one kilowatt hour of electrical power. Biogas has a BTU per cubic foot of 600-700. After the carbon dioxide has been scrubbed out (removed) and the water vapor is removed, biogas is almost pure methane. Methane has a heat value of approximately 1,050 BTUs per cubic foot. The BTU per cubic foot of butane is 2,900-3,400. The BTU per cubic foot of propane is 2,200-2,600.

Can biogas, scrubbed or unscrubbed, be used for welding purposes? There are reports that unscrubbed biogas can be used for welding. A magazine article on biogas described a farmer's one cubic meter of biogas per day as being "enough to run his welding machinery."

The United Nations Guidebook on Biogas Development says that the temperature of an oxygen-methane flame is 3,000 degrees centigrade, about 250 degrees lower than an oxygen-acetylene flame. The temperature of an oxygen-biogas flame will be lower than the flame of the oxygen-methane combination. The actual temperature depends on the percentage of methane in the biogas. The lower temperature of the oxygen-biogas combination means that it can be used for brazing (hard soldering) purposes but that it should not be used for welding metals containing iron.

Percentage and density (in kilograms per cubic meter) of basic gases in air and in biogas:

air

nitrogen: 78% of air = 1.25

oxygen: 21% of air = 1.43

carbon dioxide: 0.04% = 1.98

biogas

methane: 65% of biogas = 0.72

carbon dioxide: 32% of biogas = 1.98

hydrogen sulfide: 1% of biogas = 1.54

Rates of use for methane and biogas from several sources:

gasoline engine (standard 25 percent efficiency):	
methane	0.30 cu.m. per brake horsepower per hour
biogas	0.43 to 0.56 cu.m. per brake horsepower per hour
methane	0.42 cubic meters per kilowatt hour
biogas	0.60 cubic meters per kilowatt hour
as gasoline alternative:	
methane	0.95 to 1.20 cubic meters per liter of gasoline
biogas	1.30 to 1.80 cubic meters per liter of gasoline
as diesel fuel oil alternative:	
methane	1.10 to 1.40 cubic meters per liter of diesel fuel
biogas	1.50 to 2.10 cubic meters per liter of diesel fuel
as liquid (bottled) butane alternative:	
biogas	1.16 cubic meters per liter of bottled butane

One cubic meter of biogas can:

- 1) keep a 1-horsepower engine working for two hours;**
- 2) do the work of 0.6 liters of gasoline;**
- 3) generate 1.25 to 1.70 kilowatt hours of electricity;**
- 4) fuel a gas refrigerator for almost 24 hours; and**
- 5) keep one gas lamp lit to a brightness equal to a 60-watt electric light bulb for six hours, or seven gas lamps lit for one hour, or twenty-five 60-watt electric light bulbs lit for one hour.**

More examples of biogas rates of use:

- 1) a 1-hp engine used 12 cubic meters of biogas per 24 hours;**
- 2) a 7-hp engine used 85.3 cubic meters of biogas per 24 hours;**
- 3) a 13-hp engine used 170 cubic meters of biogas per 24 hours;**

- 4) a 24-hp engine used 300 cubic meters of biogas per 24 hours;**
- 5) a 1-kw generator used 0.62 to 0.81 cubic meters of biogas per kw hour;**
- 6) a 12-kw generator used 1.5 cubic meters of biogas per kw hour.**

The American consulting firm of Shaeffer and Roland, Inc., found the following to be true about a small biogas system it developed.

A 22.7 cubic meter digester produced: 22.4 cubic meters of biogas per day, 38 kilowatt hours of electricity per day (using a 2-kw engine-generator with an induction motor as the generator). 75.5 million BTUs of heat per year were produced of which 63.6 million BTUs were used to heat the digester and 12.2 million BTUs were used for other heating purposes.

The manure of 25 beef cattle was found to be equal to the manure of 17 dairy cows, or 183 pigs, or 23 horses, or 43,750 laying chickens.

This 22.7 cubic meter biogas system in the United States cost US\$ 6,800 in 1980, produced US\$ 1,800 per year in fuel and fertilizer, had a payback period of 3.8 years. The economic value of the fertilizer was considered to be greater than that of the fuel.

Biofertilizer Facts

The results of five different studies of the chemicals in five different organic fertilizers:

1) Manure from 25 beef cattle (weighing approximately 455 kilograms each) can produce a biogas digester sludge with an annual value of: 1,273 kilograms of nitrogen; 352 kilograms of phosphorus; and 811 kilograms of potassium. That is a N:P:K ratio of 3.6:1.0:2.3. (Shaeffer and Roland, Inc.)

2) Digester sludge is 0.5 to 2.2 percent nitrogen.

3) Compost is 0.75 to 1.0 percent nitrogen.

4) Digester sludge, liquid and solid, compared:

	nitrogen %	phosphorus %	potassium %
liquid	0.03 - 0.08	0.02 - 0.06	0.10 - 0.50
solid	0.08 - 1.50	0.40 0.60	0.60 - 1.20

5) Digester sludge in India and Brazil studies compared:

India		Brazil
2.23%	nitrogen (N)	1.40%
1.29%	phosphorus (P)	1.90%
1.47%	potassium (K)	1.70%

One study found that the sludge from biogas digesters is a fertilizer which can increase crop yields 10 to 20 percent. A 20 cubic meter digester produced enough sludge to fertilize approximately one hectare (2.5 acres) of land at a rate of one cubic meter (1,000 liters) of sludge per 100 square meters of land.

The Guidebook on Biogas Development says that biogas fertilizer increases crop yields for potatoes, tomatoes, melons, guavas, mangoes, onions, sugar cane, rice, and jute; but that cotton and coconut yields did not increase very much when biogas fertilizer was used.

According to another study, when compared with compost, biogas fertilizer resulted in the following increased crop yields: rice 6.5 percent, corn 8.9 percent, wheat 15.2 percent, and cotton 15.7 percent. Biogas fertilizer is also often mentioned as a good fertilizer for coffee crops.

Biogas and Engines

Reading Industrial Engines of Reading, England, adapts engines to run on biogas. What follows are some of the things they have learned about biogas and engines.

When using biogas to fuel spark-ignition (gasoline) engines, use non-rotating valves with stellite-faced and induction hardened valve seats to prevent valve and seat recession.

A Ford six-cylinder water-cooled diesel engine with a 6.2 liter capacity and a 9:1 compression ratio was operated at 2,400 rpm and reduced through a gearbox to 1,500 rpm to drive an AC generator at an electrical output of 56 to 62 kilowatts. The engine had a biogas consumption rate of 24 to 30 cubic meters per hour. When the same engine was run at 1,500 rpm with an electrical output reduced to 25 to 30 kilowatts, biogas consumption dropped to 18 to 24 cubic meters per hour.

Using a Ford four-cylinder 1.6 liter water-cooled engine, operated at an engine speed of 3,000 rpm to drive a 20-kilowatt, 50-cycle, 3-phase AC generator, 16 to 20 kilowatts of electricity were generated with a biogas consumption rate of 9 to 12 cubic meters per hour.

The heat from engine coolant and exhaust systems were used in both cases to heat

biogas digesters. Heat exchangers were used and in both cases this increased efficiency approximately 80 percent.

Important Slurry Carbon/Nitrogen Information

The carbon to nitrogen ratio (C/N) represents the proportions of two very important elements for successful digestion of organic wastes in a biogas digester. An organic material with 15 times more carbon than nitrogen has a C/N of 15 to 1. This ratio is often written as C/N = 15/1, 15:1, or simply 15.

A C/N of 30 will permit digestion to proceed at the highest possible rate. But: the nitrogen and carbon content of plant and animal waste changes greatly, depending on the type, age, and growing conditions of the plant, and the kind, age, diet, and degree of confinement of the animal. The list of ratios for different plant and animal wastes are averages.

The composting of plants is another factor that changes the C/N ratios; it lowers them. This can be very helpful if the digester is to use a plant waste with a high C/N ratio such as cornstalks and leaves. One week of Composting can bring a plant waste with a C/N of 100 down to a C/N of 20, which is a good C/N ratio for biogas digestion.

It is very important that all plant waste be composted before being used in a digester. Four things should be remembered when plants are used:

- **compost for seven to ten days (longer in cold weather below 21 degrees centigrade/70° F);**
- **always shred, grind, or pulp the plants before Composting**
- **let nothing get into the digester than can float; and**
- **plants put into a digester should not look like plants. They should look like a thin soup, a watery mud.**

Animal Waste Carbon/Nitrogen Ratios:	
pig	13-20
cattle	20-25
dairy cow	18-30
water buffalo	23
chicken	7-15
duck	27

pugo	7
sheep	22-29
horse	24
human feces	3-10
urine	1
fish and meat (no fat)	5
Plant and Crop Waste Carbon/Nitrogen Ratios:	
rice straw	50-70
wheat straw	85-150
oat straw	48-83
cornstalks & leaves	50-60
peanut stalks & leaves	19
soy bean stalks	32
nonleguminous vegetables	11-19
sugar cane waste (bagasse)	113-150
green plants	18-30
water lily (hyacinth)	10-21
fallen leaves	40-80
grass and weeds	12-40
kang-kong	8
seaweed	19-80
algae	5
kelp	7-15
newspaper	812

Important Slurry Recipe Information

1) It is not possible to completely predict how any one organic material will respond to biogas digestion just because we know something about the material's

chemical composition; in this case, how much more carbon than nitrogen is in the material? The biogas process is a biological process, and biological processes tend to have many variables that make them hard to predict.

2) As a guide to tell if the digester is getting what it wants to "eat," prepared and served the way it likes its "food," remember this basic rule--if the digester is producing close to one cubic meter of biogas per 24-hour day (in hot weather: 35° C, 96° F), for every cubic meter of digester space, all is well. This is true for unheated digesters that have a capacity of at least five cubic meters. Larger, heated digesters can produce up to two cubic meters of biogas per cubic meter of digester space per 24-hour day.

3) To prepare plant waste for biogas digester, the Guidebook on Biogas Development suggests the following:

(a) Cut, grind, or crush the plants into very small pieces.

(b) Break down the plant fibers so that they will not float by composting for one week with lime or a suitable enzyme such as cellulose. If local agricultural supply stores or septic tank dealers do not sell such enzymes, ask them to see if their suppliers can get them. (Warning: Too much lime in the slurry can make the sludge too alkaline to be a good fertilizer for crops or fish ponds. Too much enzyme in the slurry can make the sludge too dangerous to be a good fertilizer for crops or fish ponds.)

(c) Mix the dissolved plant matter with enough water to make a slurry which is ten percent solids, 90 percent liquids.

4) When plant wastes are used in a digester, high levels of organic acids will be released during digestion and the all-important pH level will fall. Alkaline (base) chemicals such as lime solutions or grass ash mixed in water should be added on a regular basis to slurry that has a high plant content in order to maintain a neutral balance of acids and bases.

Add lime. Some people say yes; some say no. Should it be added occasionally to digesters that are not primarily plant waste digesters? As far as D. House (1978) is concerned, the answer is yes. But all biogas system operators should make their own experiments and decide for themselves. Andrew Barnett (1978) says that sodium bicarbonate, which is commonly called baking soda, is a better buffer than lime.

Lime is one of those words that is not very well defined. Generally speaking, it refers to a group of calcium compounds. Limestone, the common rock, is largely calcium oxide (calcium + oxygen). Here, lime water will refer to calcium hydroxide which is also known as slacked lime (calcium + oxygen + hydrogen). Lime will be used to describe calcium carbonate (calcium + carbon + oxygen). All of these calcium compounds are, in other publications, sometimes referred to as

lime. Lime water and lime can be of help to biogas digestion, but limestone is no help at all.

Responses to lime vary depending on the organic waste used in the digester. Lime also has the interesting characteristic of combining, above pH 5.0 with carbon dioxide, removing it from the slurry, and therefore increasing the percentage of methane in biogas.

The addition of relatively large amounts of lime to the slurry can cause carbon dioxide to be removed from the biogas atmosphere above the slurry. This can create a partial vacuum above the slurry. The danger in this situation is that if there are any leaks in the biogas system, air will be pulled into the digester, killing the biogas-producing bacteria and creating the possibility of an explosion.

If lime is used, not much is needed. 0.2 to 0.3 grams of lime dissolved in water should be mixed with every liter of slurry, or the lime can be added slowly while the pH is checked until the pH rises to between pH 7.0 and 8.0.

If lime is added too fast after the digester becomes stuck (acid pH, no digestion, no biogas production), it may cause foaming to occur. If a digester has a very high acid pH, add a little lime; then wait a day or two before adding more lime. Repeat the treatment until gas production starts; then wait and see if the pH level can correct itself. If it does not, continue small, cautious additions of lime until all is well again.

Lime has a problem. It does not dissolve easily, so it often does not mix evenly throughout the digesting slurry. A measurement of pH, therefore, may not give an accurate picture of the true pH average inside the digester.

Baking soda or ammonia can be used as a substitute for lime. Ammonia (nitrogen + hydrogen) is toxic to the biogas process if used in too great a concentration. Too much will kill the biogas bacteria, but a little prepared in the right way has been found to help correct acid pH conditions. That right way is to mix 1/10 (0.1) of a liter of ammonia in four liters of slurry for every one cubic meter of digester space.

Ammonia can be bought in most drug stores, but it is usually diluted with water. If possible, buy a bottle which lists the concentration of ammonia so that a 1:10,000 ammonia volume to digester volume ratio can be maintained. Do not use ammonia which contains anything else besides ammonia and water.

Usually pH is measured with litmus paper, which can be bought in some drug stores and from chemical supply companies. Litmus paper changes color in response to the pH level. When litmus paper is dipped into a solution, the color it changes to can be compared with a color chart that is sold with the litmus paper. Each color on the chart represents a different pH level.

pH measurements:

pH	<u>indicators</u>	<u>solution</u>	<u>biogas composition</u>
low	gas production is low, gas will not burn, sludge poorly digested	add buffer: lime, baking soda, or ammonia	high in carbon dioxide and hydrogen sulfide, low in methane
good	all is well	smile	high in methane
high	rare situation, no common indicators other than litmus test	wait, raise C/N ratio	low in methane, other gases vary

5) Toxins are poisonous substances produced by living organisms. In many biological processes, the by-products of the life process (in animals: manure and urine) are toxins. Most creatures can be poisoned by their own toxic wastes--if they cannot get rid of them.

Under normal conditions of biogas production, the ecosystem (the world) of the digester prevents the buildup of toxic wastes. An ecosystem is a living system which supports not one, but many different kinds of life, each in some way dependent on the others. In a biogas digester this means that one bacteria's waste is another bacteria's food. The acid forming bacteria, which are the first bacteria to attack fresh slurry, come in many different types, with many different "food" preferences. They break down very complex molecules into simpler molecules.

The by-products of acid forming bacteria are almost all used by the methane forming bacteria. Some of the carbon dioxide passes off with the methane, some stays in the slurry, and some is used as a source of carbon by the methane bacteria when they make methane.

Ammonia, which is not produced in large quantities in a digester which has a balanced carbon/nitrogen ratio, apparently acts as a toxic waste rather than a food when, because of a low C/N ratio, it is produced in large quantities. In a similar way, sugar is an excellent food for bacteria. But honey, which has a very high sugar content, will not support bacterial life.

One biogas expert wrote that the waste from citrus fruits such as oranges, lemons, and grapefruits stops the production of biogas so completely that the digesters in which the citrus fruit slurry was used had to be cleaned out before they could be started again. This toxic reaction may be caused by a substance which is a chemical inhibitor to biogas bacteria called d-limonene, which is found in the peels of citrus fruits.

If soap of any type gets into the digester, it will slow down--maybe even stop--the production of gas and fertilizer. The chemicals in soap can kill biogas bacteria.

This is something to remember when human and/or kitchen waste is used to make a digester slurry.

The antibiotics in human medicine, veterinary medicine, and in medicated animal feed can kill biogas bacteria. Antibiotics have a definite life. In other words, a certain number of days after being used beyond which they can no longer kill bacteria. Antibiotics will try to kill all bacteria, harmful disease-producing bacteria, and helpful biogas-producing bacteria.

Use manure from medicated animals only after the medicine is supposed to be ineffective. If a digester's bacteria are killed by the antibiotics in manure from animals that were fed medicated feed, the digester can usually be restarted only by completely cleaning out the digester and starting over.

Other toxins: Chemical herbicides, chemical pesticides, and heavy metals which are often the result of industrial pollution can kill biogas bacteria. The most dangerous metals are chromium (Cr), copper (Cu), nickel (Ni), zinc (Zn), and mercury (Hg). Of these, copper is often used in pesticides to kill fungus, and zinc is used in galvanized iron (GI) sheets, pipes, water tanks, and buckets.

Zinc will not usually be found in a digester unless a galvanized surface is directly exposed to the slurry, as with digesters made from galvanized iron. If galvanized iron is used to make a digester, it must be painted on the inside to protect the biogas bacteria from being killed by the zinc.

One source believes that red lead paint, which is a possible choice for painting metal digesters, is itself harmful to biogas bacteria. They suggest that tar or plastic paints be used to paint the insides of digesters. Lead is a very real danger to people if plants picked up lead from lead paint contaminated fertilizer.

There are three things that can be done to reduce or eliminate the deadly effects of toxins. For biogas bacteria, the major toxins include antibiotics, soaps, copper, zinc, and too much ammonia.

- **The toxins can be diluted.**
- **They can be chemically changed.**
- **They can be stopped from getting into biogas digesters to begin with.**

If worst comes to worst, do not surrender; just clean out the digester and start over.

⑥ Chicken feathers and hair rot very slowly. Do not let them get inside biogas digesters. Fats and grease will always float and become part of the scum layer. If ground up meat scraps are used, make sure all fat has been removed.

7) There is a belief that storing manure for a few days will increase its biogas-producing capability. Experiments using manure stored for one and three days show that fresh manure is best for biogas production.

8) How can chicken manure be collected for use in biogas digesters? The Compleat Biogas Handbook has two ideas.

- **Let the manure fall through wire bottom cages onto glass plates. Fog the glass with a fine spray of water and use car windshield wipers to scrape the wet manure into a collection gutter.**

- **Another wire cage method is to let the manure fall on concrete and collect it daily by shovel or broom. With this second method, some ammonia nitrogen, a valuable fertilizer, is lost when it is absorbed into the concrete. Both methods must include a way to remove the chicken feathers.**

9) The more plant waste is shredded, ground up, and pulped into a soft, moist mud; the more manure is mixed to break up the lumps; the easier and more successful will be the biogas digestion process. Plant waste will digest rapidly and completely if it is first cut into tiny little pieces and partly composted. What goes into the digester should not look like plants; it should be a watery, dirt-free mud, with nothing floating in it.

10) Water buffalo (carabao): If the manure is collected with the urine, mixed with cut-up and partly composted plants, and digested with a little lime and enough water, an excellent digester food will be the result.

11) Cornstalks: When cornstalks and leaves are shredded and put directly into a digester, a lot of scum will be produced. The scum soon stops biogas production. By soaking the cornstalks and leaves in water for four days after they have been shredded and then bringing the pH level back to neutral before the slurry goes into the digester, there will be a very large increase in biogas production without major scum problems.

12) Kelp or any kind of brown seaweed: Not only was washed kelp used successfully in fresh water digesters, unwashed kelp was used in sea water digesters. The digesters were slowly changed from fresh water to increasing concentrations of salt water. A stable and successful ecosystem was established in one of the digesters that was converted from fresh water to sea water.

13) Leaves: Biogas has been successfully produced from leaves, using urine as the nitrogen source to balance the high carbon content of the leaves. Leaves that will not do well in aerobic compost will probably not do well in anaerobic biogas digesters.

14) Rice straw: When using rice straw, an almost 30 percent increase in biogas production was achieved because the nitrogen content of the slurry was increased.

The normal C/N ratio of rice straw is 50 to 70.

15) Water lilies (water hyacinths): Using water weeds in digesters can reduce transportation problems caused by large numbers of the weeds blocking rivers and lakes. Soaking chopped up water lilies in lime water for four days is one way to prepare the weeds for biogas digestion.

Another method is to grind the water lilies into a pulp, put them in a pile, keep them moist, and let them get moldy--in other words--compost them for a week. The mold fungi will accomplish much the same thing naturally as the lime water can accomplish chemically. Because molds, like biogas bacteria, may need to be cultured, keep a portion of the moldy plants so that fresh batches of the same plant can be infected with the molds best suited for breaking down the fibers of the plant.

16) Algae does not always digest well in digesters because the environment inside biogas digesters does not always kill the algae. One solution is to first dry the algae, so that it is dead when added to the slurry. Algae does not have much plant fiber, so it does not need to be partly composted before it is used in digesters. Another solution is to let animals drink water that is full of algae.

17) Wood: Few studies are available on the digestion of wood, sawdust, and rice hulls. In nature wood is almost never attacked by bacteria. Wood is attacked first by fungi, and only later by bacteria. Fungi are a large group of simple plants that cannot use sunlight, as most plants do, to produce energy. Fungi include molds, mildews, and mushrooms. Some parts of wood such as tannins and turpentine are toxic to bacteria. Wood is designed to resist breakdown because it lives so long. Complete Composting of hard to rot plant wastes that are high in fiber and lignin, such as wood, sawdust, and rice hulls, is probably the best way to use them. Never let wood, sawdust, or rice hulls get inside a biogas digester.

18) Lignin is a common material (a type of carbon) in plants that causes most of the floating scum problems in biogas digesters. Lignin makes plants rigid and stiff. Lignin gives plants the ability to stand up and the ability to float in water and digesters.

Composting, lime, and certain enzymes break down lignin so that it no longer is a scum problem. But not only does composting break down lignin, it also allows aerobic bacteria to use the biogas bacteria's food. So if Composting is used at all, seriously think about complete composting instead of partial Composting. A simple way to prepare plant waste for biogas digesters is to feed the plants to cud-chewing animals such as cattle or sheep and use the manure to fuel the digesters.

Lignin as a percentage of total solids in animal manure and plants (animal manure percentages will change depending on what they eat):

manure	
chicken	1.4%
pig	7.4%
cattle	13-18%
horse	16.2%
dairy cow	17.4%
plants	
grass	4.0%
rice straw	4.9%
wheat straw	6.0%
rice hulls	16.0%
newspaper	19.6%
sawdust	41.5%

Sample recipes for digester slurries: These recipes are estimates, based on carbon/nitrogen ratios, experience, and educated guesses. All of these combinations need some buffering if they use plants. Newspaper that has been wetted and sun dried will be easier to shred and ground into tiny pieces. Remember, newspaper is a plant waste; it will need grinding and partial composting like any plant before it goes into a digester.

The quantities of waste listed below are the amounts needed for one cubic meter of digester space. Notice the difference between amounts of manure and amounts of plant waste needed per cubic meter of digester space. This is due in part because all wastes have different percentages of water in them, while digester slurry should always be about 90 percent water.

1) leaves and cattle manure (1:5.5:7.3):

air dried leaves	1.8 kilograms
fresh cattle manure	10.0 kilograms
water, no less than	13.2 liters/kilograms

2) leaves and kitchen garbage (1:2.4:15.8):

air dried leaves	1.3 kilograms
fat free kitchen garbage	3.1 kilograms
water, no less than	20.6 liters/kilograms

3) newspaper and kitchen garbage (1:1.6:10.5):

shredded newspaper	1.9 kilograms
fat free kitchen garbage	3.1 kilograms
water, no less than	20.0 liters/kilograms

4) young grass and leaves (1:3.9:8.2):

air dried leaves	1.9 kilograms
young grass	7.5 kilograms
water, no less than	15.6 liters/kilograms

The following manure-based slurry recipes come from many different countries and were used in many different types of digesters. Use them as starting points. Experiment with the ratios; improving them will result in higher gas production rates.

Chicken : water

1:1.5-2.5

chicken : grass : water

1:2:9-15

chicken: newspaper: mango + banana + papaya waste (no seeds or stems):water

1:4.5:4.5:40

pig : cornstalks : water

3:1:8-10

pig : fallen leaves : water

2:1:6-8

pig : soy bean stalks : water

1:2:6-8

pig : rice straw : water

4:1:10-15

Cubic feet of biogas produced by volatile solids of combined wastes (Merrill and Fry, 1973):

<u>material</u>	<u>proportion</u>	<u>cubic feet of gas per pound vol. solids</u>	<u>methane content of the biogas</u>
chicken manure	100%	5.0	59.8%
chicken manure	31%		
+ paper pulp	69%	7.8	60.0%
chicken manure	50%		
+ newspaper	50%	4.1	66.1%
chicken manure	50%		
+ grass clippings	50%	5.9	68.1%
cattle manure	100%	1.4	65.2%
cattle manure	50%		
+ grass clippings	50%	4.3	51.1%
pig manure	100%	6.8	67.5%

Notice the trade-off between biogas volume and biogas quality for the different combinations. A standard combination in China is: 10 percent human waste, 30 percent animal waste, 10 percent crop waste, and 50 percent water.

Digester Temperature Information

1) The "greenhouse effect" refers to the fact that a building made of glass or plastic will let sunlight in and out but will keep most of the sun's heat energy from escaping. Greenhouses are used in cold climates to grow plants indoors when the weather outside is too cold.

The more a digester is surrounded with a roof and walls of plastic or glass, the hotter the digester will get, and the more biogas it will produce. Up to a point. Do not let a digester slurry get hotter than 35 degrees centigrade (96° F) on a regular basis or less gas will be produced. A complete greenhouse around a digester is best, but even a plastic or glass roof will help heat the digester.

2) The lower the temperature is below 35 degrees centigrade (96° F), the harder it will be for the bacteria in the digester to digest plant and animal waste. During cold seasons and rainy seasons when the temperature drops below 21 degrees centigrade (70° F), it is a good idea to reduce the daily slurry load by as much as 50 percent (one-half) if the digester is unheated. Any extra waste can be completely composted for use as compost fertilizer.

Doing this will not bring biogas production rates back up to hot weather levels, but it will keep the quality of the fertilizer from dropping. People often eat more in cold weather, but the opposite is true for biogas bacteria.

Finding the Biogas Production Rate

It is very important to know what is happening inside a digester. Checking for changes in the biogas production rate is an easy way to discover problems when they are small, before the digestion process is seriously harmed.

There is a simple math formula for finding the rate at which biogas is produced. It is: $\text{volume} = 3.14 \times \text{radius} \times \text{radius} \times \text{height}$. This is the same formula as the one used for finding the volume of round digesters and gas storage tanks.

V = volume of gas produced in a fixed time period

R = radius of gas tank (half of diameter)

H = height the gas tank rises in that fixed amount of time

h1 = height at start of test

h2 = height at end of test

Time period is one hour in this example.

Measure the height of the floating gas tank from the water seal level to the top of the gas tank (h1). After one hour, during which time no biogas is used, measure the same distance again (h2). If the gas tank reaches the cross bar at the top before the time period is up, or if gas bubbles out from under the water seal for any reason, the result of the test will not be accurate.

An example:

R = 0.75 meters (75 cm)

h1 = 0.08 meters (8 cm)

h2 = 0.65 meters (65 cm)

H = h2 - h1, H = .65 - .08, H = .57

V = 3.14 x .75 x .75 x .57

V = 1.0067

Volume = 1.0 cubic meter of gas per hour or 24 cubic meters per 24 hour day (at a constant pressure such as 6.0 column inches of water)

Sources & Resources

A Bibliography

1) Practical Building of Methane Power Plants for Rural Energy Independence by L. John Fry, 1974. Costs US\$ 14.25 shipping included, from META Publications, P.O. Box 128, Marblemount, Washington 98267, U.S.A. This book was my primary source for biogas theory and design concepts. Mr. Fry has been working with biogas systems since 1958.

2) Methane Digesters for Fuel Gas and Fertilizer by Richard Merrill and John Fry, 1973. This book was available from Volunteers in Technical Assistance (VITA).

3) Biogas and Waste Recycling--The Philippine Experience by Felix D. Maramba, Sr., 1978. This book is available from Maya Farms Division, Liberty Flour Mills, Inc., Pasay Road, Makati, Philippines * telephone 86-50-11 * P.O. Box 459 MCC, Philippines, Cable: LIBFLOUR MANILA, Telex: 7-22490-EEC-PH. The book costs approximately US\$ 4.00. It is an excellent book, especially for businesses which are thinking about starting a large scale biogas system. The book describes what Maya Farms learned in their profitable ten year, one million peso investment in biogas technology. The addresses given here can also be used to write to the Maya Farms Bio-Energy Division.

4) The Compleat Biogas Handbook for Farm and Home by D. House, 1978. This book costs US\$ 9.25 shipping included, from META Publications. It is interesting reading for people who want a lot of technical information.

5) A Chinese Biogas Manual translated by Michael Cook, edited by Ariane van Buren, published by Intermediate Technology Publications Ltd., 1976, and was available from VITA.

6) Construction of Fixed Top Enclosed Biogas Plant prepared by Mien Chu District, Province of Szechuan, China, and was available from VITA.

7) Methane Digesters is the title I gave a large collection of articles on biogas systems, primarily from projects in India and China, which were available from VITA.

8) Biogas Technology in the Third World: A Multidisciplinary Review by Andrew Barnett, Leo Pyle, and S.K. Subramanian, 1978. This book cost US\$ 10.00 from IDRC, Box 8500, Ottawa, Canada K1G 3H9. An informative but very technical book, not for the beginner.

9) An Inexpensive Anaerobic Digester for Small Farms by John Martin and Philip Lichtenberger, May, 1981. Published by the consulting firm of Sheaffer and Roland, Inc., 6308 Buffie Ct., Burke, Virginia 20015, U.S.A.

10) Guidebook on Biogas Development, Energy Resource Series No. 21 of the United Nations Economic and Social Commission for Asia and the Pacific. Published: New York, 1980, ST/ESCAP/96, sales number: E-80-II-F-10, price: US\$ 11.00. A good collection of standard biogas literature based on experience gained from the Indian and Chinese digester designs.

11) Renewable Energy by Daniel Deudney and Christopher Flavin, published by Worldwatch Institute, 1983. In their own words, the "Worldwatch Institute (1776 Massachusetts Avenue, N.W., Washington, D.C. 20036, U.S.A.) is an independent, nonprofit research organization created to analyze and to focus attention on global problems...it is funded by private organizations and the United Nations." Renewable Energy is a well-written, easy-to-read "textbook" on the subject of renewable energy. It is not a "how-to" manual; it is a study of the social issues of energy development. How a technology like biogas fits into a community often has much more to do with its success or failure than the quality of the technology.

12) Chinese Biogas Digester: A Potential Model for Small-Scale, Rural Applications (A Manual for Construction and Operation), prepared by Charles H. Nakagawa with Q.L. Honquilada. A joint project of The Philippine Rural Reconstruction Movement, The U.S. Peace Corps/Philippines, and The German Freedom From Hunger/Agro-Action. Draft: December 1981.

13) "Peace Corps/Philippines," the magazine of the United States Peace Corps in the Philippines. It is available upon request from the U.S. Peace Corps, P.O. Box 7013, M.I.A., Manila, Philippines 3120. The December, 1979, issue had an article on a demonstration model biogas digester built by Peace Corps Volunteers and the Philippines Rural Reconstruction Movement at the PRRM Farm in San Leonardo, Nueva Ecija. It was a digester of that design that I built and operated for a year.

14) "Philippine Farmers' Journal," 113 West Avenue, Quezon City, Philippines. The price is 3.50 pesos (approximately US\$ 0.50) per copy, per month. A good magazine that sometimes has biogas articles.

15) "Tropical Animal Production" is a technical agricultural magazine with editions in English and Spanish, costs US\$ 10.00 per year for 3 issues and is available from: Consejo Estatal de Azucar, DR, Universidad de Yucatan, Escuela de Medicina Veterinaria y Zootecnia, Apdo. 116D, Merida, Yucatan, Mexico.

16) Ferrocement Water Tanks and Their Construction by S.B. Watt, 1978. Published by Intermediate Technology Publications, Ltd., and available from ISBS Inc., P.O. Box 555, Forest Grove, Oregon 97116, U.S.A. This is the best basic book I have found on the ferrocement concrete technique.

17) Solar Water Heater by Dale Fritz, 1979. This book is published by VITA and is available in English for US\$ 2.95 and in French for US\$ 3.95. It describes how to build and operate a simple, low-cost solar collector. For the beginner, those who have a small budget, and those who do not need large quantities of hot water, this is an ideal water heater. The manual includes step-by-step illustrated construction plans.

18) Solar Energy Handbook by Dr. Jan F. Kreider and Dr. Frank Kreith, 1981. This book costs US\$ 50.00 and is published by McGraw-Hill, Inc., which has a bookstore at 14th and Constitution Avenue, N.W., Washington, D.C., U.S.A. This is a very thick book written for experts and engineers. It discusses in great technical detail the many different types of solar energy applications. Rankine engines are the only solar-powered heat engines described in detail because the authors believe Rankine engines are the only currently practical heat engines for temperatures below 300 degrees centigrade. This is an excellent, but expensive and very technical, book.

19) Energy for Rural Development: Renewable Resources and Alternative Technologies for Developing Countries is a two book series. The original book was published in 1976 and the supplement in 1981. The subjects covered include solar collectors, photovoltaics, wind energy, water power, biogas, and pedal power. While the supply lasts, a free copy of each book can be ordered by people affiliated with institutions in government, education, or research. When writing for the books, indicate name, title, and institutional address. The address to write to is: Commission on International Relations (JH 214), National Academy of Science--National Research Council, 2101 Constitution Avenue, Washington, D.C. 20418, U.S.A.

20) Report and Recommendations on Organic Farming , United States Department of Agriculture, Washington, D.C., July, 1980.

21) The Samaka Guide to Homesite Farming by Colin Hoskin, 1973. Published by the Samaka Service Center, P.O. Box 2310, Manila, Philippines. The Samaka

Guide is a good, basic book on family farming practices in the Philippines. It has chapters on water supply, fertilizer, vegetables, fruits, chickens, ducks, pigs, goats, fish ponds, carabao, food preserving, and many other interesting subjects. The book is out of print now, but libraries may have it.

22) "An Insect Control Method--Too Good to Be True," October, 1976; "The Bug Juice Method: How Safe? How Effective?", May, 1977; "More Backyard Blender Sprays," April, 1978; "The Safe Pesticides in Your Own Backyard," July, 1979, all by Jeff Cox, and "Testing Organic Pest Controls," August, 1981, by Michael Lafavore, are from the magazine "Organic Gardening and Farming." The magazine would like to get letters from people who try the bug juice and plant juice biological insect control methods. Good news and bad news; it is all welcomed. The address to write to is: Reader Service, Bug Juice Test, Organic Gardening, Emmaus, Pennsylvania 18049, U.S.A.

In 1979, Rodale Press, the publishers of "Organic Gardening," started a new magazine called, "The New Farm." It looks like an excellent magazine for family farmers who are interested in producing profitable, high-quality crops by working with nature, not against it. The address to write to for subscriptions is: "The New Farm," 33 East Minor St., Emmaus, Pennsylvania 18049, U.S.A. The magazine costs US\$ 11.00 per year in the United States and US\$ 15.00 per year in all other countries.

23) **Lik-lik Buk, a Rural Development Handbook Catalogue for Papua New Guinea.** Published and distributed by: Lik-lik Buk Information Centre, P.O. Box 1920, Lae, Papua New Guinea. The book costs US\$ 5.95 from VITA, or K 5.50 surface mail and K 9.00 air mail from Lik-lik Buk. The book contains hundreds of practical appropriate technology ideas from the South Pacific island nation of Papua New Guinea. The Appropriate Technology Sourcebook highly recommends Lik-lik Buk, and so do I. The first edition was published in 1977 and a revised second edition has Just been published.

24) **Volunteers in Technical Assistance (VITA) is a treasure chest of resources, information, and people.** Their address in the United States is: 1815 North Lynn Street, Arlington, Virginia 22209, U.S.A. (telephone: 703-2761800). VITA also has field representatives in many parts of the world. Their names and addresses are available from VITA's main office. When writing VITA, ask for a copy of their magazine "VITA NEWS." The easiest way to explain what VITA is and what VITA does is to quote from their own literature:

"VITA is a private, nonprofit development organization based in the United States. Since 1960 VITA has supplied information and assistance, primarily by mail, to people seeking help with technical problems in more than 100 developing countries. Providing its services in response to requests from individuals and groups working to improve homes, farms, communities, businesses, and lives, VITA helps select and implement technologies appropriate to the situation. VITA participates with local institutions in problem-solving relationships and in efforts

to design and carry out local solutions to local problems.

"There is no fixed charge for VITA charges; often there is no charge at all. Each type of assistance provided by VITA is handled differently and may or may not involve a fee. Each month VITA handles case requests from individuals and local groups with little or no access to funds for development projects or to foreign currency. VITA is pleased to be able to support these efforts and in such cases provides its services at no cost to the requester. When an organization requires access to VITA's services over an extended length of time, VITA and the organization can make arrangements to suit both their needs. Such arrangements usually include an agreement for payment of a fee.

"VITA's technical experts often provide on-site consulting services as part of VITA's project involvement. Areas of particular interest to VITA are: agriculture and animal husbandry, alternative energy systems (wind-solar-biogas-water), water and sanitation, food processing, small-scale industries, equipment design, project feasibility and evaluation, low-cost housing and construction, crafts production and marketing, and appropriate management technologies.

"(To put VITA to work for you), send VITA a complete description of the situation or problem. Tell what you are trying to do and how you feel VITA can help. Include drawings, diagrams, photographs, if possible. Be as specific as necessary for clear understanding of the situation. Your description should include the following kinds of information if possible: technical details (location-measurements-symptoms), scale (size and capacity of equipment or machinery, planned annual or seasonal output, size, nature and location of markets, amount of funding available), pertinent area background (social structure-climate-terrain, type of leadership, local laws or regulations, labor and energy resources, tools-materials-workshop facilities), status of project or problem (result of previous attempts to implement or solve it), other participating individuals or groups."

25) Two schools that have interests and experience in biogas systems are:

(1) E.J. Kemsley, Vice Principal, Private Bag 0027, Botswana

Agricultural College, Gaborone, Botswana (phone 52381 and 52384).

(2) Reverend Palpito D. Dumanig, Director, Mindanao Institute, UCCP,

Cabadbaran, Agusan del Norte, Philippines.

26) The International Bio-Energy Directory is published by the Bio-Energy Council, Suite 825A, 1625 Eye St., N.W. Washington, D.C. 20006, U.S.A. (telephone 202-833-5656). The directory can be found in some libraries, including the U.S. International Communication (U.S. Information Service) libraries in many countries. The following list was taken from the descriptions of 182 biogas

system projects from around the world that were listed in the 1981 issue of the International Bio-Energy Directory.

(1) Latin American Energy Organization (OLADE), Casilla 119-A, Quito, Ecuador (telephone 544-800). OLADE has held seminars and workshops to train biogas technicians from Guatemala, El Salvador, Honduras, Nicaragua, Haiti, Jamaica, Dominican Republic, Grenada, Guyana, Bolivia, Ecuador, Mexico, and Peru.

(2) Coordenadoria de Energia, Secretaria de Transportes, Energia e Comunicacoes (STEC), Avenida Cruz Cabuga 1419, 50000 Recife, Pernambuco, Brazil (telephone 222-4161). STEC promotes biogas technology, using agricultural wastes to produce fuel and fertilizer in rural areas.

(3) Ogunlade R. Davidson, University of Sierra Leone, Department of Mechanical Engineering, Private Mail Bag, Freetown, Sierra Leone 27390. The school is studying the technical and economic feasibility of biogas systems in rural African villages.

(4) E.R. Ela Evina, Director, Department Energies Renouvelables, CENEEMA, Ministry of Agriculture, Cameroon. Mailing address: B.P. Box 1040, Yaounde, Cameroon (telephone 22-32-50).

(5) Rural Industries Innovation Centre (RIIC), Private Bag 11, Kanye, Botswana (telephone 39213). RIIC is developing biogas systems to run modified diesel engines.

(6) Dr. Richard K. Solly, University of the South Pacific, P.O. Box 1168, Suva, Fiji Islands, South Pacific (telephone: Fiji 313-900, telex: FJ2276). The university is developing biogas systems appropriate to conditions in the islands of the South Pacific.

(7) Ministry of Agriculture, Office of the National Leading Group for Bio-gas Construction, Biejing, China. The Group studies biogas systems in rural villages and the possibilities of future developments in biogas technology.

(8) Department of Science and Technology, Technology Bhawan, New Meherauli Road, New Delhi 110029, India. The Department conducts research on biogas technology.

27) Appropriate Technology Sourcebook by Ken Darrow and Rick Pam. This book has now been published in two volumes, and it can be ordered from: Appropriate Technology Project, Volunteers in Asia, Box 4543, Stanford, California 94305, U.S.A. The regular price is US\$ 5.50 for Volume One (published 1976, revised 1981) and US\$ 6.50 for Volume Two (published 1981). There are discount prices for Third World Groups, and discounts are also available for purchases of ten copies or more.

To quote from the abstract in Volume One, the Appropriate Technology Sourcebook is a "guide to practical plans and books...on alternative sources of energy, farm implements, shop tools, agriculture, low-cost housing, health care, water supply, pedal power, philosophy of appropriate technology...small-scale systems using local skills and resources...entries selected on the basis of low price, clarity of presentation, easily understandable, non-technical language...more than 375 publications listed (with) prices and addresses given for each publication...250 illustrations." Volume Two lists 500 more publications and has 300 more illustrations.

28) A Handbook on Appropriate Technology published in 1979 and costing US\$ 14.50 and its sequel, Experiences in Appropriate Technology published in 1980 and costing US\$ 7.95, are both available from The Canadian Hunger Foundation, 232 Chapel Street, Ottawa, Canada, K1N 7Z2. These two excellent books describe not only the technical aspects of several appropriate technologies but also appropriate technology purposes and results.

To quote from an advertisement for the books, Appropriate technology {AT} "is much more complex than providing blueprints or equipment...the very use of AT questions standard development theories. The case studies (in these books) go beyond this to question the current practice of AT....Unless these communities have some control over the process, access to more resources and markets, power to make decisions, and are supported by government policies which promote community-scale production and services, a large percentage of men and women will remain on the periphery (outside edge) of both development and any new technologies, however appropriate."

29) Paper Heroes: A Review of Appropriate Technology by Witold Rybczynski, 1980. This book is a critical review of appropriate technology and costs US\$ 5.00 in the paperback edition by Anchor Books, Garden City, New York, U.S.A.

30) The Book of Think by Mary Burns and illustrated by Martha Weston, 1976. The Book of Think, which costs US\$ 4.95, is part of a series of school books written by authors who "believe learning only happens when it is wanted; that it can happen anywhere, and does not require fancy tools." Other books in the Brown Paper School Book series include, The I Hate Mathematics! Book and Blood and Guts (about what is inside the human body and how it works). Books in the Brown Paper School Book series can be ordered from the publisher. The address is: Little, Brown and Company, 200 West Street, Waltham, Massachusetts 02154, U.S.A.

31) Economics for a Developing World: an Introduction to Principles, Problems, and Policies for Development by Michael P. Todaro, 1977, and a revised second edition in 1981. The book is available in many, if not most, developing countries for approximately US\$ 3.00. The authorized Philippine edition is published by Phoenix Press, Inc., 927 Quezon Boulevard Ext., Quezon City, Philippines. The

book is available in the United States as a textbook for US\$ 23.00 under the title, Economic Development in the Third World. For information about local editions, write the publisher: Longman Group Ltd., 5 Bentinck Street, London W1, Great Britain. Inquiries about the U.S. textbook edition can be addressed to Longman Inc., 1560 Broadway, New York, New York 10036, U.S.A. Longman Group also has "associated companies, branches, and representatives throughout the world" which could be contacted for information on the book's availability.

The book Economics for a Developing World is not about biogas. But, just as biogas technology is part of appropriate technology, appropriate technology is part of what could be called appropriate economics for a developing world. When reading the following quotes from the book, if you find the ideas and questions interesting, I believe you will find the book interesting and useful. Understanding something about the "forest" makes the study of any one "tree," such as a biogas business, much easier.

"This book has been written for use by first-year economics students at universities throughout Africa, Asia, Latin America and the Middle East. For too many years, students in these developing nations have had to rely on "Western" economics textbooks written primarily for their counterparts in

North America and Western Europe. Although such books may claim to be universal in scope, in reality they are typically oriented towards the unique institutional, social and economic structures of the industrially advanced economies of the West. Students in developing countries are often therefore forced to absorb a broad spectrum of economic concepts, principles and theories and to analyse a wide range of contemporary problems and issues which may have little or no relationship to the institutional and economic realities of their own societies...

"The book is organised into four Parts. Part One focuses on the nature and meaning of underdevelopment and its manifestations in different Third World nations...Parts Two and Three form the core of the book. Part Two focuses on major domestic development problems and policies while Part Three examines the place of Third World nations in the international economy...Finally, Part Four reviews the possibilities and prospects for Third World development...

"In our discussion and analysis of critical development we give the diverse and often conflicting viewpoints of development economists, other social scientists, planners and those actually on the "firing line" in Third World government ministries and/or departments. If we reveal a bias, it is probably in trying always to put forward the viewpoints of Third World social scientists and development practitioners who recently have begun to articulate their shared perceptions of the meaning of development as never before...

"Students, therefore, often choose to study economics in hope of finding answers to vital questions such as the following:

- 1) What do we really mean by "development" and how can economic principles and theories contribute to a better understanding of the development process?**
- 2) What are the sources of national and international economic growth? Who benefits most from such growth and why? Why do some countries and groups of people continue to get richer while others remain poor?**
- 3) Why is there so much unemployment, especially in the cities, and why do people continue to flock into the cities from rural areas even though their chances of finding a job are very slim?**
- 4) Should the rich be taxed more than the poor and how should government tax revenues be spent in order to improve standards of living for all people?**
- 5) What is development planning all about? Why plan at all?**
- 6) Should foreign private corporations be encouraged to invest in the economies of poor nations and, if so, under what conditions?**
- 7) What about "foreign aid" from rich country governments? Should it be sought after, under what conditions, and for what purposes?**
- 8) Should exports of primary products such as agricultural commodities be promoted or should all Less Developed Countries attempt to industrialize by developing their own heavy manufacturing industries as rapidly as possible?**
- 9) What is a "balance of payments" problem? When and under what conditions should the government adopt a policy of exchange control, raise tariffs and/or set quotas on the importation of certain goods in order to improve balance of payments deficits?**
- 10) Is international trade desirable from the point of view of the development of poor nations? Who really gains from trade and how are the advantages distributed among nations?**
- 11) What has been the impact of the rapid rise in international oil prices on the economies of less developed nations? And, what future role might the now wealthy OPEC oil nations play in furthering the development of other Third World nations?**
- 12) What is the best way to promote agricultural and rural development where 80 to 90 percent of most Less Developed Country populations still reside?**
- 13) How does the spread of inflation and unemployment among the economies of rich nations affect the levels of living of people in poor nations? Do poor nations have any recourse, or must they be passive but vulnerable spectators at an**

international economic power game?

14) Are there economic factors influencing levels of fertility (birth rates) in poor nations? What are the economic and social consequences of rapid population growth? Is the population problem simply a question of numbers or is it also related to the impact of rising affluence in developing nations on resource depletion throughout the world?

15) Will there be chronic world food shortages? If so, which nations will be most adversely affected and how much such shortages best be avoided in the future?

16) Do contemporary Third World educational systems really promote economic development or do they simply act as a rationing or screening device by which certain select groups or classes of people are perpetuated in positions of wealth, power and influence?

17) What is the origin and basis of growing Third World demands for a "new international economic order"? Is such a new world order possible, and, if so, what might be its main features?

These and many other similar questions are analyzed and explored in the following chapters of Economics for a Developing World."

Feasibility Studies

This section is adapted from the article "Guidelines for Preparing Feasibility Studies" by Brain Fekety. The article was published in the May, 1981, edition of the magazine, Peace Corps/Philippines. For a biogas business or any kind of business, a feasibility study may be the most important first step.

A feasibility study's main purpose is to prove that the project is worth investing money in, to the people, businesses, banks, private, and government programs that can make grants and loans. Feasibility studies can be used to interest investors and partners.

Writing a feasibility study is a good way to organize ideas and help the prospective owner(s) decide if investing the considerable time and money involved in building and operating a biogas business is worth it, and if the answer is yes, then what design, size of operation, and type of business organization would be best.

A feasibility study is a report outlining a project that a group hopes to undertake. It shows in detail whether or not a project will work. It also shows, step-by-step, plans for the development of a successful project. Lenders, investors, and partners want to know that their money will be well spent. They will be impressed with a detailed and professional feasibility study outlining the proposed project. It must outline the nature of the project, the costs and resources required, the

expected profits and results, and a social-economic evaluation of the project.

Project summary:

- 1) A brief description of the project and its purpose.**
- 2) Summarize the history of the group, cooperative, or company that is proposing the project.**
- 3) Summarize the conclusions and findings of the study regarding the technical, management, marketing, and financial characteristics of the proposed project.**
- 4) The timetable and current status of the project.**
- 5) Say something about why you think the project will be successful and something about the project's social-economic implications.**

Description of project site:

- 1) Location of the project and area served by the project. A map which identifies provinces, municipalities, cities, and towns would be helpful.**
- 2) Climate, land, rivers, and other characteristics of the area as they relate to the project.**
- 3) The area's infrastructure (communication systems, roads, ports, airports, banks, schools, electricity, and so on) and economic conditions as they relate to the project.**

Technical:

- 1) Size, capacity, efficiency, and various processes involved in the project should be outlined.**
- 2) Purpose or service of the project (for biogas: fuel, fertilizer, improved sanitation).**
- 3) Raw material requirements (for biogas: water, plant, and animal waste).**
- 4) Requirements and costs of utilities and fuel in terms of output.**
- 5) Equipment and other fixed asset requirements (for biogas: digester, gas storage tank, and so on). The number, specifications, rated capacities, costs, and life expectancy of newly acquired and existing machinery, land, equipment, buildings, and other assets.**
- 6) Describe the quantity and quality of all labor requirements. Describe sources**

and number of workers according to skill. Indicate whether labor requirements are full-time, part-time, or seasonal. Include wage rates, salaries, fringe benefits, and the details and costs involved for any special training programs.

7) Description of all construction costs.

8) Outline the project timetable and present position of the project including target dates for such items as preparation of special studies, land improvements, and the construction or purchase of equipment, buildings, and the start of operations.

Management:

1) The background and skill requirements of the project manager position should be presented (big-data of the manager should be included in the appendix).

2) The form of organization and an organizational chart.

3) Determine the availability of manpower required to fill the various positions in the project.

Marketing:

1) Supply and demand conditions for the output (products) of the project and the raw material inputs required to produce the product and complete the project.

2) Production costs, price policies, marketing policies and strategies for methods of product distribution.

3) Evaluate the contribution of the proposed project to the national, provincial, and local economy.

4) Estimate the annual volume and value of the proposed sales and/or savings.

5) Identify the guaranteed markets and any existing or proposed contracts for marketing of the project's products.

Financial:

1) Detailed projection of all financing requirements and the use of capital (loans, grants, investments).

2) Sources selected or proposed for short-term financing, long-term financing, and credit from suppliers.

3) The amount and terms of selected or proposed financing according to each source, including security offered, repayment schedules, and interest rates.

4) For equity financing (money that owners invest in their own business), indicate subscriptions made and proposed.

5) Status of financing from each source indicating actual releases already made, applications already approved, pending applications, and proposed applications.

Social-economic justification (very important in grant applications):

1) Government revenues in terms of tax receipts (such as income and sales taxes), if applicable.

2) The benefit to people directly affected by the project (for biogas include the impact of the fertilizer on the businesses of fish pond owners and farmers).

3) The effect on the provincial, municipal, town, and village level economies by the project (for biogas this would include improved sanitation).

4) Identify any short-term and/or long-term benefits to suppliers of raw materials.

5) The amount of employment generated by the project as well as skills and/or training provided to employees.

Appendix A (Attached Enclosures):

1) Bio-data of management and Board of Directors.

2) Certified copies of all sales and supply contracts.

3) Copies of price quotations for machinery, structures, and other inputs.

4) Copies of plans and drawings for structures and for the physical layout of the project site indicating provisions for expansion (use of photographs can be impressive).

5) Any required resolutions from the group's Board of Directors.

6) Latest audited report of the group's financial statements, if applicable.

7) Certified true copy of Articles of Incorporation and bylaws, together with all amendments, if applicable.

Appendix B (The Project's Financial Data Schedules):

1) Projected Income Statement.

2) Projected Balance Sheet.

3) Projected Cash Flow Statement.

4) Projected Costs of Sales Statement.

5) Projected Operating Expenses.

6) Projected Amortization Schedule (paying off of debts).

7) Financial Evaluation:

(a) discounted rate of return on total investment,

(b) profitability ratios (net operating income as a ratio of sales and net operating income for each year and the average amount of net income over the projected operating period,

(c) debt ratios, calculating debt to equity ratios and repayment schedules of loans,

(d) break-even analysis,

(e) internal rate of return, and

(f) payback period.

Problem solving

How do you get a problem? There is not just one answer to that question. Problems come in different ways. There is no telling when one will appear. But there is a moment when you realize there is a problem.

It is not always enough to know you have a problem. Sometimes it helps to see where it came from. That is not always easy; problems sneak up in different ways.

One Way: You notice something is not quite right. Not the way it should be. The fertilizer from the biogas digester has always increased the quantity and quality of your crops in the past. But not now. It is as though you were using no fertilizer at all. Using the biofertilizer has become a waste of time.

Okay, you know there is a problem. Now that you have it, are you sure what it is?

- Is the fertilizer no good?**
- Could it be that you have been using too much fertilizer too often?**
- Is the fertilizer being used at the best time in the plant growth cycle?**

- **Is the digester being overloaded?**
- **Is the digester sludge left in the aging pond long enough? e Has rain diluted the sludge?**

A second way: You open the outlet gate valve on the digester and nothing comes out, even though the digester is full.

- **Is the digester so full of solids that the outlet is blocked? How would you find out if that is the problem? If it is a too high percentage of solids what would you do? How did the percentage of solids in the slurry go over the ten percent in the first place? Is the problem the valve, the solids, or how the slurry is prepared? Or is the real problem something else?**

A third way: Something has been bothering you for a while. Your five cubic meter family digester is working, producing biogas and fertilizer, but you feel it requires more time and more work than the biogas and fertilizer are worth. It costs more to produce your own gas and fertilizer than it does to buy bottles of pressurized gas and bags of chemical fertilizer. Not every consumer should be a producer. Is the digester temperature 20 degrees centigrade? The biogas bacteria would see that as a problem and not produce much gas. Have you sat down and figured out what would be the best combination of available plant and animal wastes to feed the digester? Maybe you should have joined a biogas business or cooperative instead of building a family digester. Where is the problem?

It is not always easy to decide where the problem is. But that is the important first step. No use solving a symptom of the problem and leaving the problem untouched.

Your first idea may not be your best idea. Go comparison shopping for solutions. Take a good look at several ideas before you choose one. If you want 5.0 cubic meters of biogas every day, the solution is to build a 5.0 or 6.0 cubic meter capacity digester, right? Maybe. Maybe you should start a neighborhood biogas cooperative and own a 25 percent share in a 20 cubic meter system. Maybe you should invest in a biogas business and make enough money to buy all the bottled gas you want.

Making lists is one way to study a problem. Lists can be used to help remember things, but they can also be used to help you think. Lists can help you look at things in different ways. You can list your fuel and fertilizer needs. You say you are not a farmer and you do not need fertilizer. Do you have the land or the desire to build a fish pond? You could list the ways you could sell the fertilizer. You could list your resources: money, skills, organic wastes, and so on. You could list possible solutions: family biogas system, business biogas system, or cooperative biogas system; and under each possible solution you could list what your role (active partner, investor, etc.), costs in time and money, and potential profits

might be. Remember that trap of looking at something in only one way.

Be logical. That is a method you have heard about for solving problems. When using logic you pick a direction for your thinking to go in. Then you go step-by-step. You check each step along the way that makes sense. Hopefully you get what you are looking for.

The problem with logic is, in which direction should you go? If you go down the wrong road, logic takes you to the wrong place. If you cannot decide which direction to take, logic will not take you anywhere.

Logically, fresh sludge from a digester looks very watery; you see very little solid matter floating on top of the bucket and very little left in the bucket when you use the sludge to dilute fresh waste going into the digester. Everything is fine until a few months later when biogas production drops off and nothing comes out of the outlet. What your logical eyes did not see was solid matter suspended, floating in the sludge, not much (only about ten percent), but enough to make a difference in time--if the solids are not filtered out of the sludge before it is used to make fresh slurry. Learning to solve problems does not mean learning to be more logical. It means learning to think in different ways. Not always in a straight line.

Sometimes you know where you need to end up. But, it is knowing how to get there that is the problem. Going backwards is sometimes a better way to go. It can save time; it can make a problem a lot easier to solve. Suppose you have two slurry buckets. One holds ten liters. One holds six liters. You need to know where the eight liter line is in the big bucket for when you mix fresh slurry. How can you do it? Do not start by pouring. That may get you going in a useless direction, and you would be wasting a lot of slurry. Picture where you want to end up. Now try to back up one step at a time to see how to get there. (The answer is at the end of this section.)

Sometimes you do not ask a question because it seems stupid, silly, or because you feel it would be embarrassing to ask. Questions such as: Why is biogas bubbling up through the water that the gas storage tank floats in?

Successful problem solvers cannot go around hoping someone else will ask the questions. Asking questions is a good way to find out something. Practice questioning what you read, as well as questioning other people. But before you can ask what you need to know, separate what you know from what you do not know about a situation.

It has been said that two heads are better than one. Then maybe twenty heads are even better. For some problems, it helps to have other people's opinions. Then you can pick and choose among many ideas and maybe even come up with a completely new idea. Before building a biogas system, you might ask all the farmers and fish pond owners you know if they would buy biofertilizer and at what price for both the liquid and the solid kinds.

You would want to know what the local prices of chemical fertilizers are, if they are used much, and if anybody is already using organic fertilizers such as fresh manure (which is a health hazard) or compost. You might find that you have to give the biofertilizer away for free for a few months in order to convince farmers of the fertilizer's quality. But that within one or two growing seasons you can make a profit selling the biofertilizer at a price equal to or less than that of chemical fertilizers of equal value.

You might have questions about biogas system operations that are not answered in this book and cannot be answered even with the help of friends. You could write letters to VITA, Maya Farms, or the groups listed in the International Bio-Energy Directory for their opinions and help. You could ask a nearby Peace Corps Volunteer, if they are working in your country. If they cannot help, they should know where to ask for help.

You want to build a biogas system and you have enough plant and animal waste to feed the size digester you have chosen. The problem is: What is the easiest way to get the waste into the digester? Explain the situation to your friends and see what they suggest. No one friend may have the best solution for your situation. The answer may be a combination of several suggestions. You can pretend to be different people you know and ask imaginary people how they would answer your questions. Whether you are asking real or imaginary people, you will see how different people think differently. The more you do this, the easier it will be to think differently when you need different viewpoints.

There are times when thinking crazy on purpose is a good idea. Not acting crazy, just thinking crazy. Let your mind run wild in different directions. For example: If you decide to go into the biogas business, how could you persuade other people to join you? Whom would you ask? Should the biogas system be a private business or a cooperative? How big should the system be? How should the system be operated? How should the gas and fertilizer be used? How could composting and bioinsecticide be added to a biogas business? Could the waste from a town's market place support a biogas business? How much per kilogram should you pay people to collect water lilies for the digester? Let the possible questions and answers run wild.

Another approach to problems is to find a similar problem to the one you have. It may be a problem you have already solved. It may be a problem that you could solve more easily. In either case, you will get a helpful clue for your thinking, a push in the right direction. Anyone who understands how to build ferrocement water tanks knows how to build strong, inexpensive concrete biogas digesters and the water tanks for gas storage tanks.

In real life, very often the same problem shows up over and over. Sometimes it is disguised so that it does not look the same. If you do not learn from your first solution, you will just keep getting the same problem again and again. That is no

way to live. If you have solved one problem having to do with the biogas pipes, think about what you learned; it may help solve a new gas pipe problem. The same is true no matter what the problem is: liquid fertilizer distribution, scum layers, or waste to water slurry ratios. Sometimes what is a help in solving a new problem is not remembering a similar solved problem but remembering a method of problem solving that worked well for you.

There are some problems that are totally confusing. For example: You want a biogas system but do not know where to start; there are so many decisions to be made. You have no idea what the answers are. Not even wrong answers. One big blank. What you need is inspiration. A brand new way of looking at the problem. A little hope. You need to relax and dream about the problem without worrying about it. Sleep on it. Give the problem a night to just roll around in your head without any pressure to find a solution. You might be surprised. The answers, or at least a few important clues, might just appear at the strangest time.

No matter which way you go about solving a problem, try to do it in such a way that the challenge is enjoyable. Many times there are no clear solutions. There may be several possible answers, not just one. It is not always easy to know when you are right. Thinking about thinking can help you get a good start.

The answer to the two buckets problem: You want eight liters in the 10-liter bucket. So two liters have to be subtracted by pouring it into the 6-liter bucket. That is the last step. To know how much two liters are, you must already have four liters in the 6-liter bucket. You can do that by filling the 6-liter bucket from a full 10-liter bucket, pouring out the six liters, and pouring the four liters that are left in the 10-liter bucket into the 6-liter bucket. To complete the solution, pour two more liters from a full 10-liter bucket into the 6-liter bucket that has four liters in it. Now that you have found the eight-liter level, do not forget to mark it. Working backwards can be fun. (This section was adapted from The Book of Think.)

Vocabulary

ACID: A sour substance. A usually water-soluble chemical compound that has a sour taste, reacts with a base substance to form a salt, and turns litmus paper red. Acids, depending on their strength, can chemically burn or dissolve other substances. Stomach acids help dissolve food.

AERATION: To supply with or mix with air.

AEROBIC : With oxygen. An aerobic organism can live only where there is oxygen.

ANAEROBIC: Without oxygen. An anaerobic organism can live only where there is no oxygen.

BACTERIA: Simple, primitive types of life which reproduce by dividing. Bacteria occur as single cells, groups of cells, chains or strings of cells, and cannot be seen without a microscope because of their small size. Three types of bacteria are: (1) Aerobic bacteria which need oxygen from the air in order to live; (2) anaerobic bacteria that can only live where there is no air with oxygen in it; and (3) pathogenic bacteria, some aerobic, some anaerobic, which can cause disease in plants and animals. Not all, or even most, bacteria can cause diseases.

BASE : A bitter substance. An alkaline chemical compound such as lime or ammonia that can react with acids to form a salt and turns litmus paper blue. Bases, depending on their strength, can chemically burn or dissolve other substances.

BIOFERTILIZER: A fertilizer made from decomposed organic matter. In this book biofertilizer usually refers to the organic waste, called sludge, that has been taken from the outlet of a biogas digester. This sludge is 90 percent liquid. Another biofertilizer mentioned in this book is the traditional organic fertilizer called compost.

BIOGAS: A mixture of gases produced by the actions of living organisms. People produce carbon dioxide; plants produce oxygen; and some types of anaerobic bacteria produce methane, carbon dioxide, a little hydrogen sulfide, and traces of a few other gases. Though technically any gas produced by a living organism is a biogas, it is only the mixture of gases produced by anaerobic bacteria that is commonly called biogas.

CARBON DIOXIDE: A heavy, colorless gas that does not burn. Carbon dioxide can be formed by the burning or decomposition of organic matter.

C/N RATIO: The ratio in organic matter between the amounts of the two basic building blocks of life: the elements carbon and nitrogen.

CONDENSATION TRAP : A trap which collects a gas such as steam (water vapor) and changes it into a liquid such as water.

DECOMPOSE : To reduce from complex to simple. To rot, to break down, to decay--a process in which bacteria often play an important role.

DETENTION TIME: It is the number of days that organic waste is supposed to remain inside a biogas digester from the day it is put into the inlet to the day it comes out of the outlet.

DIGESTER: An airtight, watertight tank in which organic matter is stored for the purpose of permitting anaerobic digestion until the organic matter no longer carries any disease-causing organisms and most of the potential for producing methane gas has been used up.

DIGESTION: The biological breakdown, by living organisms, of organic matter into forms that can be absorbed by living cells. Digestion takes place in the bacteria of biogas digesters and in the stomachs of animals and people.

DUAL-FUEL ENGINES: Engines that have been adapted to operate on a mixture of two kinds of fuel--in this case--diesel fuel and biogas.

ENZYMES: Chemicals which help to break down or form organic molecules.

FERROCEMENT: A type of reinforced concrete made of wire mesh, sand, water, and cement. It is strong and long lasting. In comparison to other types of concrete, ferrocement is flexible. It is usually only 1.0 cm (0.5 inch) to 5.0 cm (2.0 inches) thick. Used for many years to build boats, ferrocement is now being used to build water tanks, grain storage bins, and biogas digesters.

FIBERGLASS: A very strong type of plastic containing hair-like fibers of glass.

GALVANIZED IRON (GI SHEETS): Iron that has been coated with zinc in order to resist rust.

GAS STORAGE TANK: A container with holes in the bottom, floating in an open-top water tank. Lighter-than-air gases such as biogas are trapped in the gas tank by the water. When gas is piped into the gas tank, the tank floats up. When gas is piped out of the tank, the gas tank sinks into the water. In this way, the gas pressure remains fairly constant, making the gas easy and safe to use.

HORSEPOWER: One horsepower is a unit of power equal to 746 watts of electricity. Brake horsepower is very different. It is the power of an engine as calculated from the force exerted on a friction brake or absorption dynamometer applied to the flywheel or shaft or the engine.

HUMUS: Organic matter formed by the decay of dead plants. Humus is essential to the fertility of soil.

METABOLISM: The process of using biological energy. The sum of all physical and chemical changes which take place within an organism. The changing of the chemical energy of food into mechanical energy (your arm moving) and heat (your body's temperature).

METHANE: A compound of the elements carbon and hydrogen. Methane is a colorless, odorless gas that can burn. Methane is 60 to 70 percent of biogas. Methane is also found underground, often with deposits of oil. It is sold by oil companies as a fuel called natural gas.

MOLECULE: The smallest unit into which a substance can be divided without a change in its chemical nature.

NUTRIENT: A substance that has food value to a living organism.

NUTRITION: Nutrition is the process of taking in and using food.

ORGANIC: All plant and animal matter, living and dead. All organic matter is made in large part of the basic elements--carbon, nitrogen, oxygen, and hydrogen.

ORGANISM: Any living thing, such as animal, plant, or bacteria.

OXYGEN : A nonmetallic element occurring free in the air as an odorless, colorless, tasteless gas. Animals breathe air for the oxygen in it. Oxygen in combination with other elements is three-fourths of the animal world by weight, four-fifths of the plant world by weight, one-half of the mineral world by weight, eight-ninths of all water by weight, and one-fifth of the air by volume. **pH**: A measure of how acid or base (alkaline) a solution or substance is. Most all living things prefer a balance of acid and base--a natural pH. Both strong acids and strong bases can chemically burn and destroy living matter.

PRESSURE GAUGE: It is a measure of how tightly packed gas in a system is, including the gas storage tank. It is not a direct measure of how much gas is in the system. The same amount of gas can occupy a large space or a small space. The smaller the space that the same amount of gas occupies, the higher the gas pressure.

RADIATION: The process by which energy is given off by one body (such as the sun), travels through space, water, or something else, and is absorbed by another body (such as the water in a solar collector).

RUST: Rust is the result of iron combining with the oxygen in air and forms a red or orange coating on the surface of iron.

SCRUBBING: Separating and removing unwanted gases from biogas.

SLUDGE: The organic plant and animal slurry when it is removed from a biogas digester after the production of biogas. Sludge is 90 percent liquid, 10 percent solids (mostly humus). Biogas sludge makes an excellent fertilizer.

SLURRY : The plant and animal matter, mixed with water, that is put into a biogas digester. Slurry should be about 90 percent water.

SOLDER: Solder (pronounced sod-er) is a soft metal alloy that joins harder metal objects together without heating them to the melting point. The solder is applied in a melted state.

SPARK-IGNITION ENGINES : Ordinary gasoline-powered engines in which spark plugs are used to ignite the gasoline.

STARTER : Fresh sludge from a working digester which because it is full of biogas-producing bacteria, can be used to speed up the start of biogas production in a new digester.

THERMOSYPHON: Moving liquid from one place to another by changes in heat. The thermosyphon is based on the principle that hot liquids and gases want to rise, while cold liquids and gases want to fall.

WASTE: The word waste is used in this book to refer to organic matter that does not have a purpose more important than being used as "food" for a biogas digester.

[View this page in text format](#)