

AT MICROFICHE
REFERENCE
LIBRARY

A project of Volunteers in Asia

Blacksmithing

by: James M. Drew

Published by:

Webb Book Publishing Company
Saint Paul, Minnesota USA

This publication is out of print in 1983.

Reproduction of this microfiche document in any form is subject to the same restrictions as those of the original document.

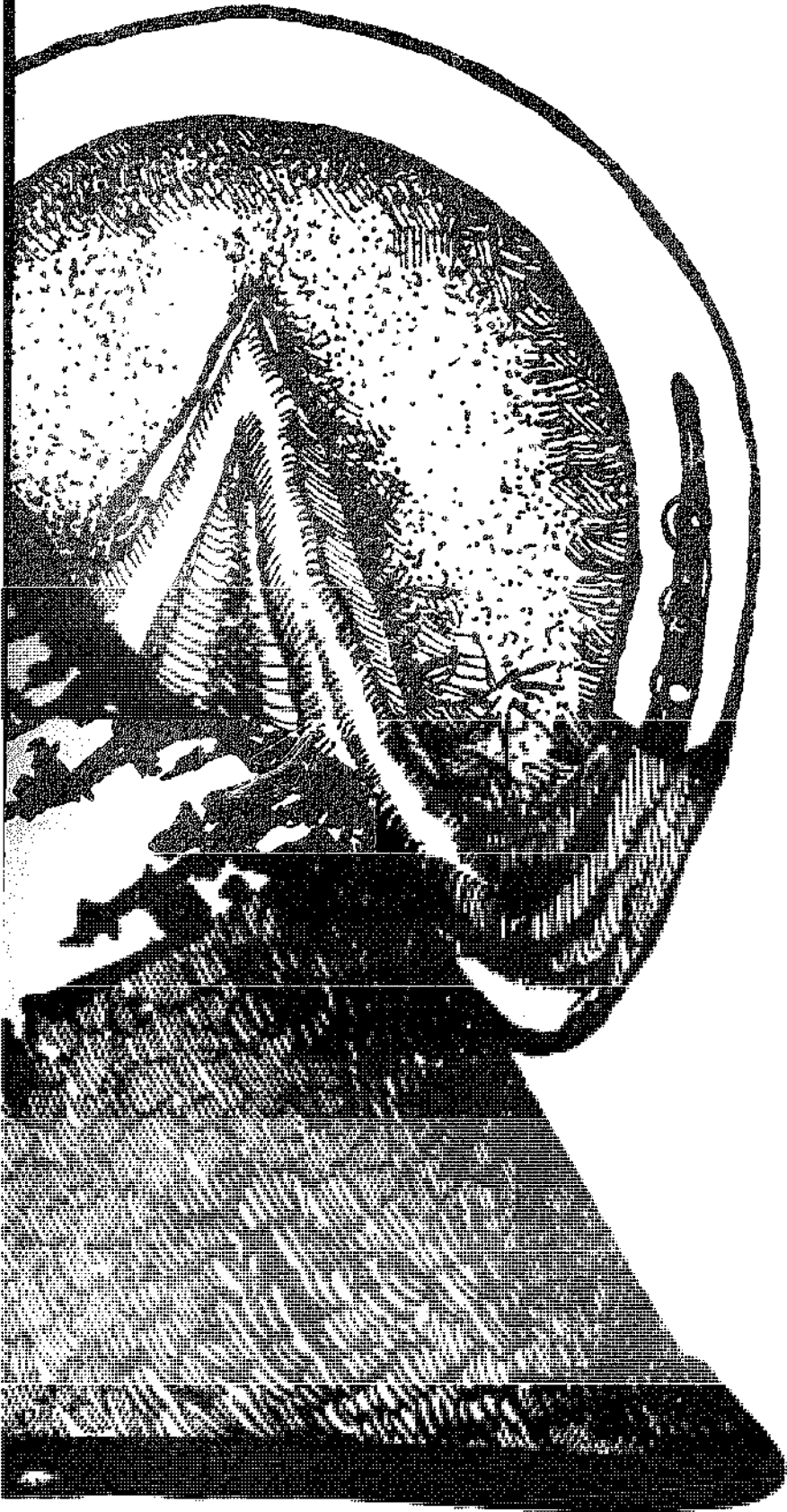

BLACKSMITHING

BLACKSMITHING

BY

JAMES M. DREW

FORMER INSTRUCTOR IN BLACK-
SMITHING, SCHOOL OF AGRICUL-
TURE, UNIVERSITY OF MINNESOTA



Facsimile Reproduction 1975
THE SHOREY BOOK STORE
110 Union Street
Seattle Washington 98101
SJU #37

WEBB BOOK PUBLISHING COMPANY
SAINT PAUL MINNESOTA

1943

COPYRIGHT 1935 BY WEBB BOOK PUBLISHING COMPANY

Second Printing, May 1937

Third Printing, January 1943

**SECOND PRINTING
Of Facsimile Reprint**

**Limited to 500 Copies
November 1975**

ISBN #0-8466-6037-7

PRINTED IN THE UNITED STATES OF AMERICA

PREFACE

SINCE the automobile has taken the place of the horse and buggy, and the tractor has almost supplanted the farm team, there is so little work left for the horseshoer and wagon maker that these tradesmen are fast disappearing from the scene. The village or crossroads blacksmith, once an important factor in the working force of the rural neighborhood, if he has not already retired, is beginning to see the end of any profit in his business; and as no young men are learning his trade, his race bids fair to soon reach the vanishing point.

In the future, whatever blacksmithing is necessary to be done in connection with farm tools and machinery, and the farm teams, must be done by the farmer or his sons.

It is this condition of affairs that has brought about a recent demand for a book on the subject of farm blacksmithing. This book has been written in the attempt to supply that demand. The author, who, during a long term of years, had the pleasure of teaching the elements of forge work to several thousand Minnesota farm boys, hopes that this little book may be of help to those farmers and farmers' sons who wish to, or through force of circumstances are obliged to, do the work which formerly fell to the lot of the village blacksmith.

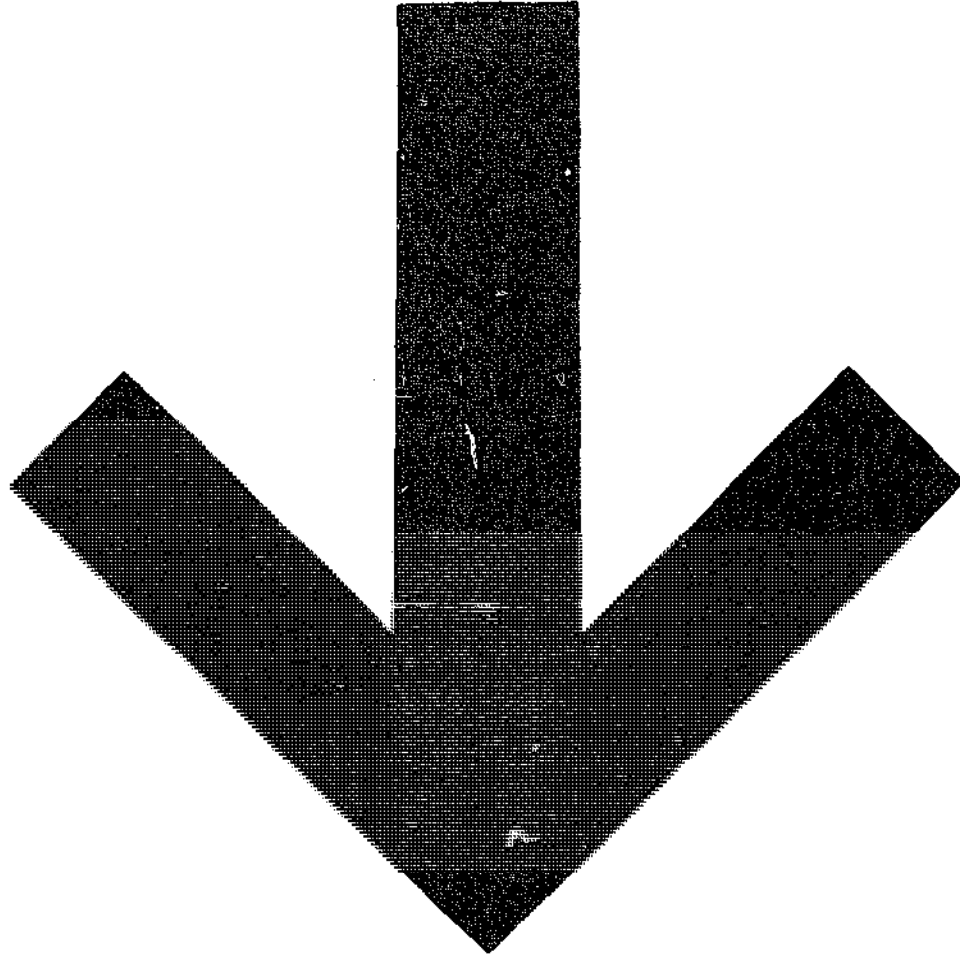

CONTENTS

I. IRON AND STEEL	1
II. THE FARM SHOP	5
Location and Plan; Equipment and Tools: The Forge; The Anvil; The Vise; The Work Bench; The Tool Table; Water Tank; Rack for Iron and Steel; Neces- sary Tools; Other Tools; Two Useful Anvil Tools.	
III. THE FORGE FIRE	19
Smithing Coal; Managing the Fire.	
IV. FORGING IRON AND STEEL	22
Drawing; Upsetting; Bending; Scarfing; Welding; Punching; Riveting.	
V. SIMPLE EXERCISES IN BLACKSMITHING	29
A Fire Poker; Staple Puller; Hook and Staple; Chain Links; Cold Shut Links; Chain Hook; Swivel; Ring; Clevis; Pin or Bolt for Clevis; Heading Tool for Bolts; Bolts and Nuts; Welding Separate Irons; Welding Iron and Steel.	
VI. FORGING AND TEMPERING STEEL TOOLS	54
Making a Cold Chisel; Forging and Tempering Drills; Stone Drills; Knife Blades; Tempering a Hammer; Blacksmith's Tongs; Files.	
VII. PLOW WORK	69
Sharpening Plowshares; New Points; Handy Tools.	

VIII. WAGON WORK	76
Setting Tires; Making New Tires; Whiffletree Irons.	
IX. HORSESHOEING	86
X. SOLDERING AND BRAZING	95
APPENDIX	101
Decimal Equivalents; Rules Relative to the Circle; Circumferences of Circles; Weight of Round Mild Steel; Weight of Square Mild Steel; Weight of Flat Mild Steel; Sizes of Wire.	
INDEX	107

BLACKSMITHING

IRON AND STEEL

IRON and steel are the materials with which the blacksmith works. While most people are familiar with such terms as wrought iron, cast iron and malleable cast iron, Bessemer steel and mild steel, it is necessary for the blacksmith to have a clear idea of just what these metals are, how they are produced, and the uses to which they are put. To describe the different kinds of iron and steel is the purpose of this chapter.

IRON Iron is the most common and useful of all metals. It is found in many parts of the world, never in its pure state except in some meteorites which have fallen to earth from some other region. Iron is found in the form of ore which may be a combination of iron and solid rock, or in the form of a soft red oxide that may be scooped up with steam shovels, as is done in some of the open mines in northern Minnesota.

To get the iron from the ore, it is necessary to heat it to a very high temperature, so that the iron becomes a liquid which flows like water. This process is called smelting. The usual method consists in packing the ore in layers in a tall furnace, with layers of coke and limestone between the layers of ore. The whole is brought to a very high heat and becomes a mass of liquid at the bottom of the furnace. The iron, being heavier than the other material, settles to

BLACKSMITHING

the bottom, where it is drawn off and poured into molds holding about 100 pounds of metal each. The lumps of iron so made are called pig iron.

What we know as cast iron is made by melting pig iron and running it into molds of whatever form we wish to have. Cast iron is very hard and quite brittle. It is not pure iron, but contains several other elements, the most important of which is carbon. It is the carbon in the iron which makes it hard and brittle. If cast iron is kept at a high temperature for a long time the carbon is burned out of it and it becomes softer and tougher. To make what is known as malleable cast iron, the articles to be made are first cast from pig iron, then placed in ovens where they are kept at a white heat for about a week. This high heat burns out most of the carbon, and the castings become tough enough to stand some bending without danger of breaking. Malleable castings can therefore be used for many purposes where ordinary cast iron would be too brittle.

Swedish iron, known also as "Norway iron," is a kind of wrought iron which is still to be found in the market. It is used where very soft and very tough iron is required, as, for example, in the making of rivets and clinch nails. It is so soft that shavings may be cut from it with a good jackknife. It is soft and tough because it is made from the purest iron ore to be found, and in smelting it only charcoal is used. Charcoal contains none of the injurious chemicals found in other coal.

STEEL. Mild steel, also called soft steel or machinery steel, which has almost entirely taken the place of the old-fashioned wrought iron, is made from pig iron by a process which removes almost all the carbon. There are several methods of making mild steel, the most common of

IRON AND STEEL

which is known as the Bessemer process. This consists of melting the pig iron in large furnaces and holding it at a high heat while air is forced through the molten mass to burn out the carbon. From the furnace the molten steel is poured into molds about the size of a man's body, forming what are known as ingots. These ingots are heated to welding heat and rolled out into bars or beams or railroad rails, or into any shape required. One ingot will make two lengths of railroad rail.

Tool steel is simply pure iron to which a very small percentage of carbon has been added. It is one of the wonders of chemistry that the addition of a small part of one per cent of carbon will change soft iron to stiff steel and give it the property known as temper. If we heat a bar of pure iron to a yellow heat, then suddenly cool it in water, no change is made in it. It may be bent the same as before the heating. If we do the same thing with a bar of steel it will break when we try to bend it. Yet the only difference between the two bars is that the steel contains a part of one per cent of carbon.

In making tool steel, rods of pure iron are packed in charcoal in a furnace which may be sealed so that it is practically airtight. The whole mass of iron and charcoal is heated to near a welding heat and kept at that temperature for some time. The iron is not allowed to melt but is kept near the melting point. During this process, a small amount of carbon from the charcoal unites with the iron. A rod is occasionally drawn out of the furnace and tested to determine the amount of carbon absorbed by the iron. When the right percentage of carbon has been absorbed, the furnace is allowed to cool. We now have what is known as blister steel; so called because the surface of the rods is covered with blisters.

BLACKSMITHING

It is easy to understand that rods so treated will have very much less carbon in the middle than toward the outside; and any tool made from such steel would be unsatisfactory. What is known to the trade as shear steel is made by welding together rods of blister steel. This welding together and drawing out of the rods makes a somewhat better grade of steel than the blister steel, and some kinds of cheap tools are made of it.

To get a tool steel which is of even carbon content throughout, blister steel is melted in crucibles and then drawn out into bars of any required size. This is called crucible steel and is the kind of steel from which all the best tools are made.

II

THE FARM SHOP

THE FARM shop and its use should fill an important place in the planning of the farm work and should be given careful thought. The repairs that may be made and the work that may be done year after year in a well-planned, well-lighted, properly equipped workshop, will repay the first cost many times over, in addition to providing pleasant and profitable occupation when the weather or other conditions prevent outside work.

LOCATION AND PLAN

The question of whether the shop is to be a separate building, or is to be combined with a garage or farm machinery building, or other structure, will depend upon what buildings are already in existence on the farm. Each farmstead will have its own problem along this line.

Possible fire hazard should be taken into consideration in connection with combining the forge shop with any other building. In any case it would be desirable to have the shop some little distance from the barns.

The foundation for the shop should be laid deep enough to rest upon solid subsoil, and should extend at least 6 inches above ground level. This will protect the sills from decay, and allow the floor to be far enough above the outside ground surface to insure dryness, in case a gravel or earthen floor is decided upon.

BLACKSMITHING

A concrete floor is to be preferred if it can be afforded; but a very good floor may be made of a mixture of clay and cinders, or clay and fine gravel and sand properly rammed down to make it solid.

In case the forge is to be placed in a shop which is already built, and which has a wooden floor, the space for

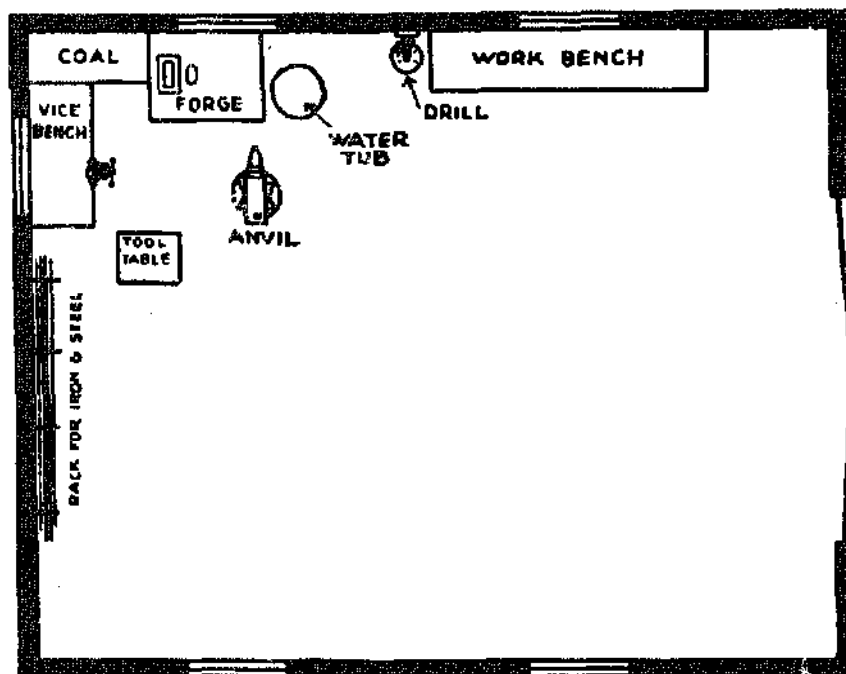

FIG. 1. LAYOUT OF THE FARM SHOP

some distance around the forge and anvil should be covered with sheet iron so as to avoid danger from fire and the annoyance of having to pick up every piece of hot iron that happens to fall on the floor.

The floor space in the shop should be large enough, and the doorway wide enough and high enough so that a wagon, or automobile or tractor or truck in need of repairs could be accommodated. The doorway should be

THE FARM SHOP

at least 8 feet wide and 7 feet 6 inches high, and there should be a ramp, preferably of concrete, leading up to the doorway and over the sill. It is considered better practice to use double doors for so wide a space rather than one wide door. Most sliding doors or doors hung on rollers, especially if very wide, are likely to warp out of shape and cause trouble. Hinged doors are easier to work, and may be closed more tightly.

Figure 1 shows a floor plan and a desirable arrangement of the equipment in a farm shop. Notice the wide doors, floor space for large machines, and the convenient arrangement of forge, anvil, drill, vise and tool table with reference to each other. This plan shows a building of about 18 by 24 feet. The roof should be so constructed that no supporting posts will be necessary: thus leaving the entire floor space free of obstruction.

EQUIPMENT AND TOOLS

THE FORGE The kind of forge to be used in the farm shop will depend somewhat on the amount of money the owner wishes to invest. A good steel forge suitable for farm work can be purchased for about \$20. The only advantage such a forge will have over one that may be built by the farmer is that it is portable, and under some circumstances it may be convenient to move it about from place to place. For a permanent forge, the ideal arrangement would be a brick forge and chimney built in one piece; the forge to be about $2\frac{1}{2}$ by $3\frac{1}{2}$ feet in size and 30 inches high, and the chimney extending up above the comb of the roof at least 2 feet so as to insure a good draft. Figure 2 shows such a brick forge.

A very good forge may be made of ordinary lumber. If such a forge is decided upon, the box should be about

BLACKSMITHING

8 inches deep and of the same size as the brick forge mentioned above. It should be set up on legs of the proper length to bring the top of the box to about 30 inches above the floor. Whether the forge is of brick or of wood, it should have a tuyere iron or air nozzle, that can be cleaned out from the bottom; and an ash pit or some sort of container for the ashes should be provided.

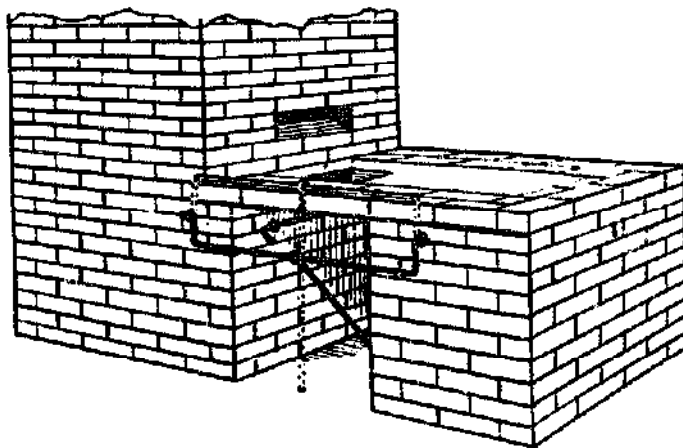

FIG. 2. A BRICK FORGE

Blast for the forge is best provided by a fan blower. A good blower of this type can be had for about \$10. A tuyere iron and the necessary pipe for connection with the blower are included for this price. Figure 3 shows blower and tuyere.

In the case of either the brick or the wooden forge, the tuyere should be so placed that its top is 4 inches below the top of the box; then the box is to be filled with damp clay, well packed, leaving a hollow space around the tuyere about the size and shape of a small hen's nest. The clay should be allowed to dry out slowly to avoid

THE FARM SHOP

cracking, and should be thoroughly dry before a fire is built in the forge.

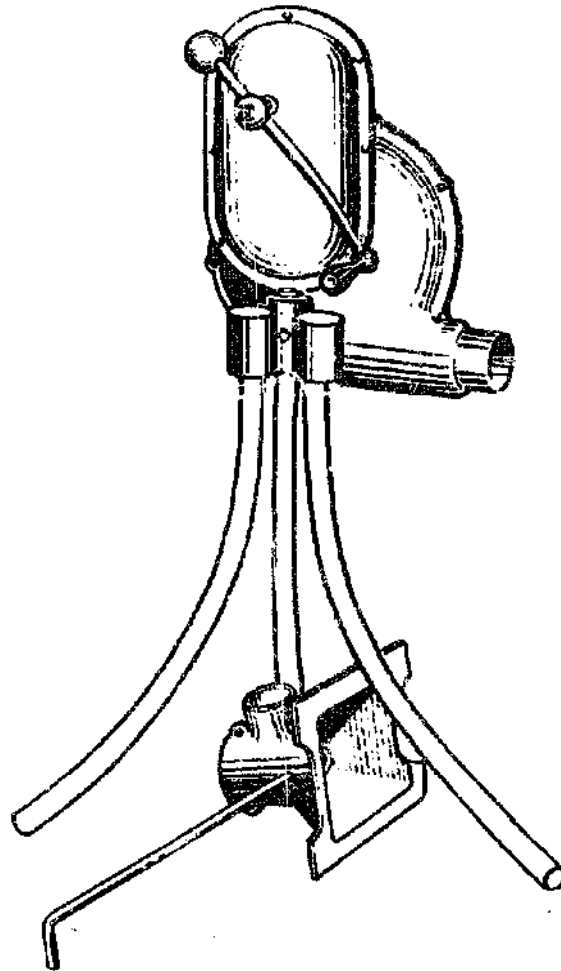

FIG. 3. BLOWER AND TUYERE

In locating the forge it is well to remember that it is sometimes necessary to heat long rods in the fire, and therefore it is not wise to have the forge in a corner of the shop. The writer once knew a smith who was obliged to cut a hole through the outside wall of his shop in order

BLACKSMITHING

to be able to handle some long bridge rods that he was hired to weld.

Some thought must be given to taking care of the smoke which seems to be a necessary product of every blacksmith shop. Do not make the mistake of trying to cover the whole forge with a large hood. Such a hood is a nuisance, for it is in the way for many kinds of work, and it does not carry off the smoke as well as a small hood located back of, and close to the fire. If a chimney or pipe with a large flue, the larger the better, is located just back of the forge, and the opening into it is made as it should be, within a few inches of the height of the fire, it will carry off most of the smoke.

In any chimney flue there is, under ordinary conditions, an upward draft of air. The larger the chimney flue the more air is constantly going upward. If the opening into the chimney is throttled down to a narrow slit there will be a strong current of air entering this slit. If this opening is close to the fire, as shown in Figure 2, the smoke will be drawn into it before it has time to roll out into the air of the room.

THE ANVIL Next in importance to the forge, in the furnishing of the shop, is the anvil. This should be of solid steel, with a hardened face. For the farm shop an anvil weighing 100 pounds will be found none too large. In selecting an anvil one should be sure that the face is level and smooth, and the edges of the face sharp and square, except that 5 or 6 inches of the edge of the face next the horn and on the further side from the smith should be rounding instead of sharp. The reason for this is explained on page 22 under "Drawing." Figure 27 gives a good idea of the proper shape of an anvil.

THE FARM SHOP

The anvil should be located about 6 feet from the fire, and if it is to be used by a right-handed man, should have the horn pointing to the left. It should rest on a block of wood not much larger than its own base, which should be set at least 2 feet into the earth, and be high enough so that the face of the anvil will be of the proper height. This height, for general work, should be on a level with the smith's knuckles as he stands beside the anvil. The anvil block may be a section of timber a foot square, or a section of a tree trunk of the proper size. It should be of seasoned wood, and years may be added to its term of usefulness if the ground end is soaked in creosote before being set in place.

An anvil is so likely to be abused by the amateur smith, that it seems advisable at this point to give a few words of warning.

We are too apt to think of an anvil as simply something to pound on, and it often gets more abuse than is good for it. The face of a good anvil is hardened steel. Any very hard steel is always more or less brittle. The face of a blacksmith's hammer is also of hardened steel and consequently more or less brittle. Remembering these two facts, let us make it a rule always to keep these two brittle things separated by having something between them. This something will generally be a piece of hot iron or steel. No amount of pounding on the iron or steel can harm either anvil or hammer; but the hammer must not hit the anvil. Student blacksmiths often ruin the edge of the anvil by using it to cut off the end of a piece of iron or steel. It is all right to do this if the blows of the hammer are stopped just before the steel is cut in two; but if the hammer reaches the edge of the anvil two brittle things come in contact and something has to happen.

BLACKSMITHING

THE VISE The vise for the farm shop should be what is known as a leg vise, that is, one with a leg extending to the level of the floor. The vise itself is of wrought iron with steel jaws, and should be fastened to a solid post firmly set into the ground. The bottom of the leg should rest on a block which is firmly fastened to the post. This post may be made a part of the work bench, and should be, if possible, located in a good light and near enough to the anvil to allow the smith to reach it without moving more than a step from his place at the fire. Leg vises may now be had with extra jaws for holding pipe or other round objects.

THE WORK BENCH The work bench should be about 3 feet high and should be provided with racks and shelves for all the tools, such as files, chisels, wrenches, etc., that the smith would naturally use at the vise. It should contain drawers and shelves for stocks and dies and such supplies as rivets, small bolts, washers and miscellaneous small hardware. If possible it should be located near a window.

THE TOOL TABLE A tool table, while not an absolute necessity in a farm shop, is a great convenience. It is usually made about 2 feet square, with a rail around the top and a shelf below. The purpose of the table is to hold all the anvil tools, such as top and bottom swages and fullers, hot and cold chisels, extra tongs and extra hammers. It is usually placed near, and at the right hand or tail end of, the anvil.

WATER TANK OR TUB Factory made forges are generally provided with a cast iron water tank or box hung to the side of the fire pan, as shown in Figure

THE FARM SHOP

4. The usual container for water in the ordinary forge shop is a tub made from a barrel. An ordinary wooden kerosene or vinegar barrel with about a third of the top sawed off makes a very good tub. Just why old blacksmiths call this a "slack tub" is not easy to explain. The word is not to be found in the dictionary. This tub should be placed

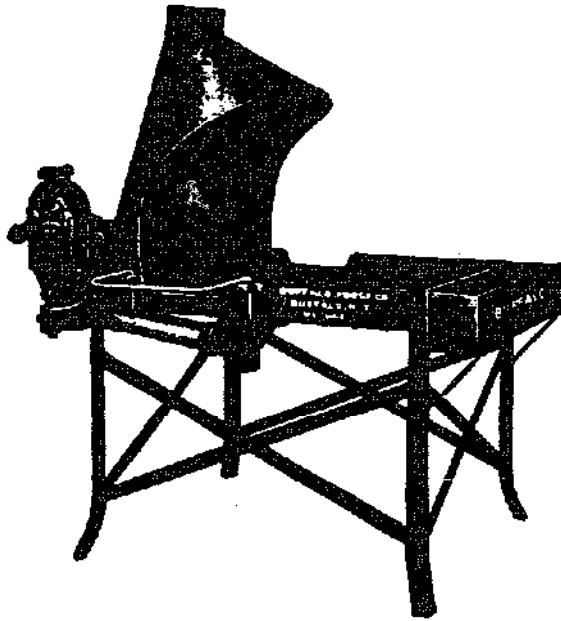

FIG. 4. A FACTORY FORGE WITH BLOWER AND WATER TANK

at the right of the forge within easy reach of the smith as he stands by the fire, and should be filled with water to within a few inches of the top.

RACK FOR IRON AND STEEL Some kind of a rack, so made that rods of iron and steel stock may be laid up on pegs, off the floor, and sorted as to sizes and lengths, is a great convenience. Such a rack may be built close to the wall of the shop and takes up little room.

BLACKSMITHING

NECESSARY TOOLS Having a shop provided with the equipment above described, the only absolutely necessary tools needed to begin work are a fire poker, a hammer, a hardy and 2 pairs of tongs. The hammer should be what is known as a blacksmith's hand hammer of about 2 pounds weight. The tongs should be of the two kinds shown in Figure 5; one for handling flat or round iron, the other for making bolts. All other tongs needed may be made by the smith as described in Chapter VI.

OTHER TOOLS In addition to hammer and tongs, the tools next in order of importance will be a sledge of about 8 pounds in weight, and a set of what English blacksmiths call

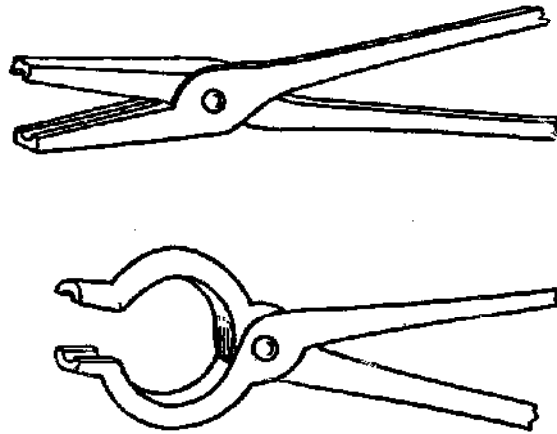

FIG. 5. BLACKSMITH'S TONGS

flogging tools: hot and cold chisels, swages, fullers, set hammer and flatter to be used for heavy work when the smith can have the help of a striker to use the sledge. These tools are shown in Figure 6.

For the work bench there will be needed wrenches, files, punches of different sizes, cold chisels, screw drivers, brace and set of twist drills, stocks and dies for threading bolts and burrs, hack saw and blades. If horseshoeing is to be done, a shoeing hammer, hoof nippers, and horse rasp will be needed.



HOT AND COLD CHISELS

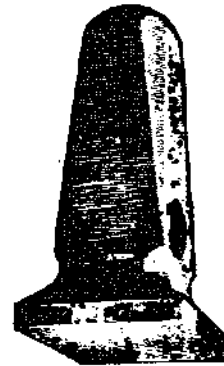

FLATTER

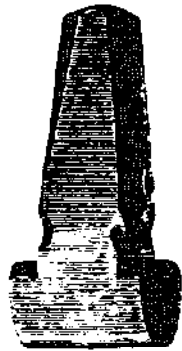

SET HAMMER

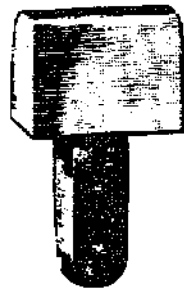
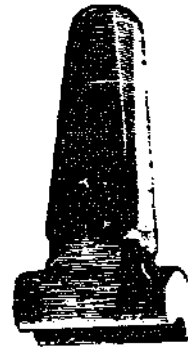

TOP AND BOTTOM FULLERS

FIG. 6.
FLOGGING TOOLS



TOP AND BOTTOM SWAGES

BLACKSMITHING

A post drill is such a convenience that it almost comes under the head of necessary equipment.

Some of the above-named tools can be made by the smith in spare time. Others it may be cheaper to buy.

Let us see what the tools and equipment so far mentioned will cost:

Anvil, (100 pounds).....	\$14.00
Blower	10.00
Vise	5.50
Hardy50
Sledge, (8 pounds).....	1.25
Flogging tools	5.00
Bolt tongs75
Flat tongs75
Hand hammer90
Horseshoeing tools	2.50
Hack saw and blades.....	.85
Stocks and dies.....	5.00
Brace and drills.....	4.00
Total	\$50.00

A word should be said about the hardy shown in Figure 7. This is a tool which is much used, and often abused. It is a chisel with a shank made to fit the square hole in the anvil. It should be made of tool steel of about the same grade as that used in making cold chisels. As it is used to



FIG. 7. HARDY

cut hot metal, there is no use in tempering it, as the temper would be drawn out of it by the hot metal; but in other respects it is like a chisel. It should have a rather thin edge and be kept sharp. This can be easily done if the smith will always remember that its

THE FARM SHOP

edge is never to be hit by the hammer. In cutting off a piece of hot iron or steel on the hardy, the hammer should stop before the iron or steel is cut through.

The shank of the hardy should be fitted to the hole in the anvil so that there will be no wobble or play to the tool when it is used. The shank should be long enough to extend through the tail of the anvil, so that in case it becomes stuck in the hole, the lower end may be tapped with the hammer to loosen it.

If a post drill can be afforded, one which will answer very well for the farm shop may be had for about \$5. This price includes a chuck to hold drills of different sizes. See Figure 8.

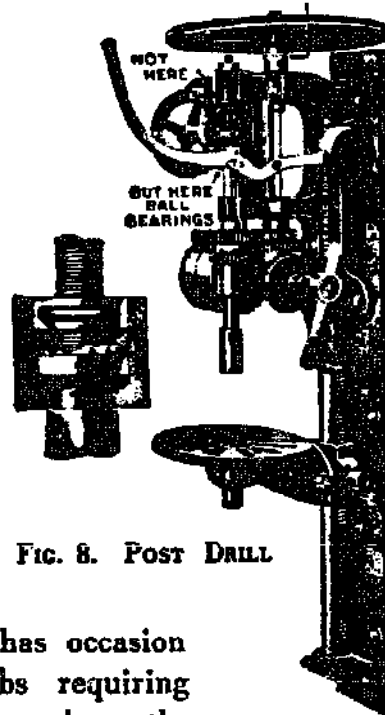

FIG. 8. POST DRILL

TWO USEFUL ANVIL TOOLS The smith often has occasion to do small jobs requiring something smaller than the horn of the anvil for bending or shaping.

In Figure 9 are shown two very convenient tools or pieces of equipment which the farm smith can easily make from a piece of shafting or other iron, or from mild steel which he may salvage from the scrap pile or "machinery graveyard" to be found on almost any farm. One is a straight, round mandrel which will be found handy for bending ferules, small rings, etc. The other is a small horn to be

BLACKSMITHING

used the same as an anvil horn in making small links or doing any kind of bending of small articles. Of course



FIG. 9. MANDREL
AND HORN

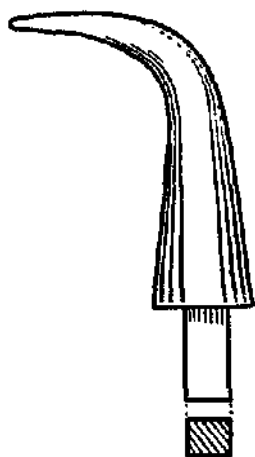

both are to have shanks to fit the square hole in the anvil. In making either one of these tools it is well to begin by first forming the shank and fitting it to its place in the anvil. It should be a tight fit; and in order that it may be easily loosened from the anvil after being used, it should have a shank long enough to extend a little below the tail of the anvil the same as in the case of the hardy above mentioned.

III

THE FORGE FIRE

MUCH of the success of forge work depends upon the care and management of the fire and the proper heating of iron and steel. Therefore it is of great importance that the smith be thoroughly familiar with the different factors that go into making the right kind of fire in order that he may get the results that he wants.

SMITHING COAL The most satisfactory coal for ordinary smithing work is what is known to the trade as Cumberland coal. It contains less sulphur and other impurities than any other mined coal and is easily packed about the forge fire. Coke, when broken up into small pieces, makes a good fire, particularly when a large fire is wanted, but it is not so easily managed as Cumberland coal.

Neither ordinary soft coal such as is used for making steam, nor hard (anthracite) coal is suitable for use in a forge. Both kinds contain impurities which make it impossible to use them in welding.

Charcoal makes a good fire if properly managed, and is very desirable for use in making fine steel tools, as it is wholly free from sulphur and other injurious chemicals; but in most parts of the country it costs more than mineral coal and has almost gone out of use as a smithing coal.

BLACKSMITHING

MANAGING THE FIRE The first and most important thing for the amateur smith to learn is the proper management of his fire so as to get the heat where he wants it, and to do this without too much waste of fuel.

Let us suppose that the beginner has the equipment and the most necessary tools mentioned on the preceding pages, and that he is ready to start a fire in the new forge. The fire is started by using pine shavings or any fuel that would make good kindling for a fire in a kitchen stove. After a good blaze has started, a little coal is packed *around*, *not upon* the kindling, so that it will take fire slowly. After a forge has been in use there will always be coke left over from the former fire to be used in starting a new fire; but for this first time there is only kindling and blacksmith's coal. It must be remembered that coal should never be put *on* the fire but *around* it. After being near the fire a short time the coal is changed to coke because all its sulphur and other impurities are burned out of it. By continually packing the coal about the fire and crowding it toward the center, a supply of coke is kept burning in the middle of the fire, where the most heat is needed. The packing also prevents the fire from spreading out and becoming too flat. It is well to wet the coal about the fire in order to pack it harder and to keep the fire confined to the middle.

The fire will now present the appearance of a mound of coal, the interior of which is a mass of burning coke, with a somewhat loose center through which the blast is coming. The most common mistake of the beginner is to allow this mound to become too low and flat. The coal should be piled up quite high about the fire so there will be considerable depth to the mass of burning coke. Whatever is to be heated in the fire should be held midway between top

THE FORGE FIRE

and bottom, so as to have burning coke both below and above it. If held too low, it will be struck by the blast of air from the blower, and if too high it will be cooled by the air from above.

Experience will soon show how much blast should be given. The stronger the blast the greater will be the heat, up to the point where the coke in the middle of the fire begins to be lifted out of place.

It is sometimes desirable to have a long fire instead of a round one in order to heat an iron for some length instead of in one spot; for example, the edge of a plow share. In such a case it is easy to lengthen the fire by packing coal on two sides instead of all around the middle.

Too much blast will cool the fire. Just enough blast should be given to keep the coke at a white heat but not enough to lift it out of place. Long experience and practice are needed to enable one to manage a forge fire so as to get the best results; although to the onlooker it may appear to be a very simple matter.

A forge fire left to itself will soon die out. The experienced smith, when he leaves his fire for a short period of time, will place a small piece of hard wood in the fire knowing that it will hold the fire until he returns. Thrifty smiths save old wagon spokes and similar pieces of wood for this purpose. Often a forge fire which has apparently died out may be revived by a sprinkling of sawdust. If the old embers are still hot enough to cause sawdust to smoke, a handful of sawdust and a gentle blast will revive the fire and save the time that it would take to build a new fire in the ordinary way.

IV

FORGING IRON AND STEEL

FORGING of iron and steel may be summed up in the following list of operations: *drawing, upsetting, bending, scarfing, welding, punching and riveting.*

DRAWING By drawing, the smith usually means making a piece of iron or steel smaller and longer. This is done by heating, then pounding it over the rounded edge of the anvil, trying at the same time to keep it as nearly square as possible. In the case of a large piece of iron or steel, a pair of fullers would be used (shown in Figure 6), and the helper would be called upon to use the sledge. The beginner will probably have a little trouble with his first trial at drawing because the iron will seem to insist on becoming diamond shaped instead of square. This is because the novice almost always turns the iron, between blows, a little further than through a quarter circle. But he will soon learn to turn it just enough to keep the square shape. No matter what is to be the final shape of the piece, it should be drawn square at first because it can be reduced in size much faster that way than in any other. After it is drawn down to about the desired size it may be made octagonal by pounding down the four corners, or round by flattening out the remaining corners. Finishing is done with light blows of the hammer. All the finishing, after reducing to the proper size in the square shape, is done on

FORGING IRON AND STEEL

the flat face of the anvil, and with a smooth faced hammer.

The heating for drawing should be done slowly enough so that the iron or steel has a chance to become as hot in the middle of the piece as it is on the surface. It is possible, especially with large pieces, to heat the surface to the desired temperature before the middle becomes hot enough to work well. The result will be that the surface will be drawn out faster than the rest of the piece. In the case of tool steel this produces strains in the metal which are troublesome when it comes to tempering the tool so made.

Not only should the metal to be drawn have an even heat throughout, but the hammer used and the blows struck should be heavy enough to affect the whole mass. Light blows would have the same effect as uneven heating; for the surface only would be drawn.

UPSETTING This means enlarging a piece of iron or steel by heating it at the part to be made larger, and driving it together so as to swell the heated part. In case the end of a short piece of iron is to be upset it should be heated to a white heat, the heated end placed on the anvil and the other end struck with the hammer. In the case of a longer piece of iron which is heavier than the hammer, it may be danced on the face of the anvil, letting its own weight do the work of pounding. The ends of long rods, like truss rods, may be upset by heating and butting the ends against the side of the anvil after the manner of a battering ram.

Wagon and carriage tires are shortened or made smaller by being upset by a special machine made for the purpose. A short section of the tire is heated to white heat and placed in the machine which grips the tire at both sides of the heated portion and pushes it together.

BLACKSMITHING

BENDING There are several points in connection with bending iron that should be mentioned. The beginner should be warned against spoiling the shape of the iron he is bending by too much or too hard hammering. If the iron to be bent is made hot enough, it may be bent into almost any desired shape with very little pounding, and if it is a piece with sharp corners that would be marred by hammering, it is a good plan to use a wooden mallet or even a stick of stove wood or any hardwood club if a mallet is not at hand.

SCARFING The term scarfing is used for the shaping of parts to prepare them for welding.

In the case of round irons, the ends are first upset enough to allow for the expected loss in heating and welding, and then are shaped as shown in Figure 10. Steps in the shaping of round irons for welding are shown in Figure 21. This shaping is done by first holding the hot upset iron on the anvil at an angle of about 30 degrees, and striking with the hammer held at a corresponding angle.

When the end of the iron assumes the shape shown at A in Figure 21, it is turned a quarter turn, laid flat on the anvil, as at B, and shaped as shown at C. Both the irons



FIG. 10. ROUND IRONS SCARFED FOR WELDING

to be welded together are, of course, shaped alike. Notice that the faces which are to fit together are slightly convex so that when placed together the middles touch, and space is thus left for any scale to be pushed out when the weld is made.

FORGING IRON AND STEEL

Flat irons to be welded are upset and scarfed as shown in Figure 11. Notice that these faces also are convex instead of flat.



FIG. 11. FLAT IRONS SCARFED FOR WELDING

In preparing chain links for welding, it is not necessary to upset the ends for the reason that the ends are crossed in such a way as to provide plenty of iron at the welding point to take care of any loss in heating and welding. After the iron for a link has been bent in the form of a letter U, the ends are scarfed as shown in Figure 16, by flattening the inside corners of the ends, but leaving the outside of the ends as thick as they were originally.

WELDING By the term welding the smith means the joining of iron or steel parts by heating to the melting point. The metal is not actually melted so as to be in a liquid state, but the surface is hot enough to begin to flow, and when at this temperature is sticky, like a warm piece of molasses candy, and may be pressed or pounded together so as to make perfect joints.

Iron or steel at welding heat is perfectly white, and the surface is beginning to flow. It has the appearance of wet, white ice. If heated beyond this point it will begin to burn and is in danger of being spoiled.

Wrought iron and mild steel may be welded without the use of any welding compound or flux of any kind; but the difference between welding heat and burning heat is so slight, especially in the case of mild steel, that it is often of advantage to use a flux to avoid burning. Clean sand is

BLACKSMITHING

about as good as anything in this case. One should not get the idea that the flux is going to act in any magic way to help the iron to weld. It is used simply as a protection to the iron. Sand or borax will melt at a lower temperature than iron, but after melting it will stand a higher heat without burning than will the iron, and is used because it keeps the air away from the iron, and iron cannot burn without air.

The welding of chain links, rings, and of round and flat separate irons is explained in the following chapter.

PUNCHING Punching is a quick, easy way of making holes in wrought iron. The amateur smith will often find himself debating the question whether to drill or punch holes in a certain job of work. As a help in deciding this question the following story may be worth telling.

In making a certain machine, two pieces of iron one inch wide and a quarter-inch thick, were to have quarter-inch holes in them half an inch apart for nearly their whole length. Two young apprentices decided to have a race. Each took one of the irons; one was to drill the holes in his piece, the other said he could do the job in less time by heating and punching. Which one came out ahead in point of time is a forgotten item. The lesson in the story lies in the fact that the iron that was punched was several inches longer than the other when the job was done. The boy who did the punching did not realize that the hot iron would spread both ways when the holes were punched.

In a job where a little spreading of the iron will make no difference, punching the holes may be a saving of time. To do a neat job of punching, the hot iron should be placed on the anvil, not over a hole, but on the solid face, and the punch should be driven till it feels as though it were solid

FORGING IRON AND STEEL

against the anvil. Then the piece should be turned over, and the place where the punch nearly came through will show as a round dot. The punch should now be placed on this dot, over the round hole in the anvil, and driven through. In this way a very neat hole may be made.

In punching thick iron with a small punch the beginner should be warned of the danger of upsetting the end of the punch in the hot iron if he works too slowly.

RIVETING Riveting may be thought of by the smith as such a simple operation as to need no explanation in a book of this kind. There are, however, a few points in connection with this form of forging that should be mentioned. The best material for rivets which are to be used for cold riveting is Norway iron; the next best is mild steel. If the latter is used to forge rivets for cold riveting, the rivets should be allowed to cool slowly after being formed, and not quenched in water. The reason for this is that most mild steel contains enough carbon to cause it to harden a little upon being suddenly cooled. Any degree of hardening would make the metal too brittle for riveting.

Norway iron rivets of all sizes and lengths are to be found in the hardware stores, and it is a good plan for the farm smith to keep on hand a few sizes which are most often used; for example, those that are used for replacing worn or broken mower sections. But special rivets will often have to be made to be used in repair jobs, and the smith should know how to make them. In many cases simply cutting a section of rod the proper length and using it for a rivet will solve the problem. If a large head is needed, sometimes a bolt of the right size may be found which may be cut the right length. If neither a piece of rod nor a bolt of the right size is at hand, it will be necessary to forge a

BLACKSMITHING

rivet. To do this in the right way the smith should choose a piece of rod the next size larger than the desired rivet, heat it to a yellow heat and draw out the end by holding it against the near edge of the anvil so as to leave a shoulder between the part being drawn out and the part of the original rod which will form the head of the rivet. Just where this shoulder will be calls for the exercise of good judgment. It should be remembered that reducing the diameter of a piece of iron one-half will lengthen it four times. Most beginners start with too long a "bite" and are surprised at the way it stretches out in length before it is drawn down to the right diameter. As described under the head of "Drawing," the iron should be kept square until reduced to about the right size, then rounded. It should be cut from the rod while hot by holding it on the bardsy at the proper place to leave the right sized head. The cutting should be done with light blows so as not to mar the head too much, and the rod should be turned round and round so as to make a smooth, even cut.

The two most common mistakes which beginners make in cold riveting are in having the rivet too long and in hitting it too hard. If, for example, in the case of fastening fish plates to the sides of a cracked wooden pump rod, the rivets used should be too long they would be likely to buckle or bend in the middle and split the wood. In ordinary practice, it is usually a good plan to countersink the holes for rivets, and the rivets should extend through only far enough to allow for the making of a small head. This is usually a little less than one diameter of the rivet. Very light blows should be used in doing the riveting. Heavy blows would be likely to bend the rivet in the middle, especially in the case of a long rivet. Light blows will upset the extreme end and draw the rivet tight.

V

SIMPLE EXERCISES IN BLACKSMITHING

ASSUMING that the beginner has the necessary tools and equipment described in Chapter II, and that he has a fire properly built in the forge, he is ready to begin actual work. The best plan is to start with simple things and to lead by gradual steps to the more difficult jobs that require more practice and experience.

A FIRE POKER As a first exercise, the poker, which has been mentioned as one of the necessary tools, furnishes a good example. It brings into use the three processes of heating, bending and flattening. About 2 feet of round half-inch iron should be used. About 4 inches of one end should be heated to a light yellow

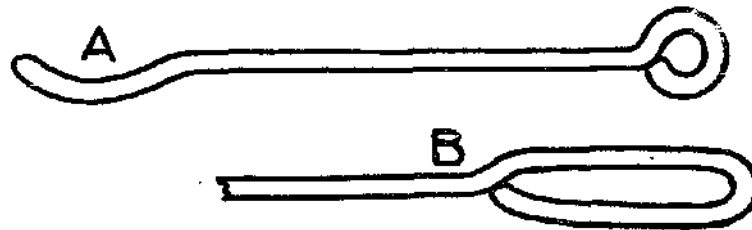

FIG. 12. A FIRE POKER

heat and bent into the shape of a round eye. At his first trial the beginner will have trouble in trying to make the eye round instead of oval unless he has been told that in starting the bend he should make a right angle bend be-

BLACKSMITHING

tween the shank of the poker and the part that is to be the eye; then bend the extreme end before closing up the circle. If the middle of the hot part is bent first, as a beginner is likely to do, there is left no handy way to make the bends in the end and next the shank, and an oval instead of a round eye results. After the eye end has been finished and cooled, the opposite end of the rod is heated and flattened out until it is about $\frac{3}{4}$ of an inch wide, then curved slightly as shown at A in Figure 12.

If a longer handle to the poker is preferred, it is an easy matter to form an oblong eye instead of a round one, as shown at B in the cut, but in this case it will be necessary to start with a rod about 6 inches longer than the one first described.

A STAPLE PULLER In these days of wire fences, one of the handiest tools on the farm is a staple puller such as is pictured in Figure 13. When the writer was a young farm boy he thought he had the champion staple puller. It was simply a long punch with a tapering end drawn to a fine point. This point he would drive under a staple and then pry it out. Sometimes in doing

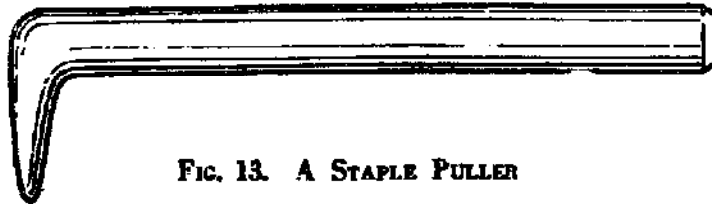

FIG. 13. A STAPLE PULLER

the driving he hit his knuckles with the hammer. When a neighbor showed him one like the tool here pictured, he immediately made one from a piece of old horse-rake tooth, tempered it blue, and liked it better than his old one. The best size stock for making one of these pullers is

SIMPLE EXERCISES IN BLACKSMITHING

$\frac{1}{2}$ -inch tool steel. The point is made rather short and bent at a right angle, and tempered the same as a cold chisel as explained on page 56. The handle end should be about 8 inches long.

HOOKE AND STAPLE Another simple exercise in blacksmithing is the forging of a hook for a gate or a barn door, and the staple with which to fasten it in

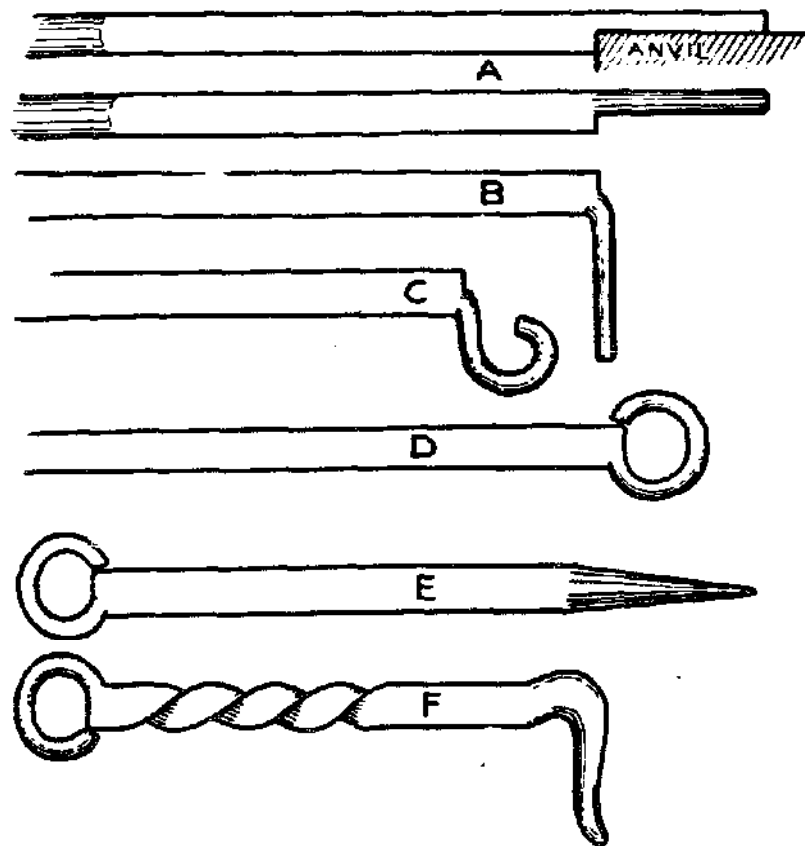

FIG. 14. STEPS IN MAKING A HOOK

place. This exercise involves drawing, squaring, rounding, pointing, turning a round eye, and twisting.

BLACKSMITHING

For an ordinary barn door hook, a piece of $\frac{3}{8}$ -inch round iron is a convenient size to use. One end should be heated to a light yellow and drawn out square so that the corners come out sharp. (See what is said about drawing on page 22.) The end of this square part should next be heated and about $\frac{5}{8}$ inch of it drawn down to half the size of the square part, then made round by hammering down the corners. In starting to draw out this last part, the iron should be held over the edge of the anvil as shown at A in Figure 14, so that when struck a flat blow by the hammer, the edge of the anvil will form a decided shoulder between the large square part and the part that is being drawn smaller. The small end is next to be made round and turned to form a round eye. To do this, it is best to start by bending at a right angle from the main part, as shown at B, then bending the extreme end as much as it needs to be bent in the finished eye (C). It is then a simple matter to close the ring so as to form a perfect circle as shown at D. The hook is now to be cut from the original bar at a point that will make it the right length when the point is drawn out to form the hook end. This end should first be drawn out square, then rounded as shown at E, and the hook formed in the end as shown at F.

The twist shown at F is put in the middle of the hook by first heating to a yellow heat, then grasping with two pairs of tongs and turning through one complete revolution, so that the eye and the hook end are in the same relative position as before.

To make a staple for a hook of the size mentioned above requires a piece of $\frac{1}{4}$ -inch iron. One end should be drawn out and rounded, then bent as shown at A and B in Figure 15. It should then be cut off at a point which will make the second leg the right length after it is drawn

SIMPLE EXERCISES IN BLACKSMITHING

to a point. A pair of chain tongs should be used to hold the piece while the second leg is being drawn out as shown at C. The bend is completed by grasping the middle of the bent part with the chain tongs, as at D, and holding it over

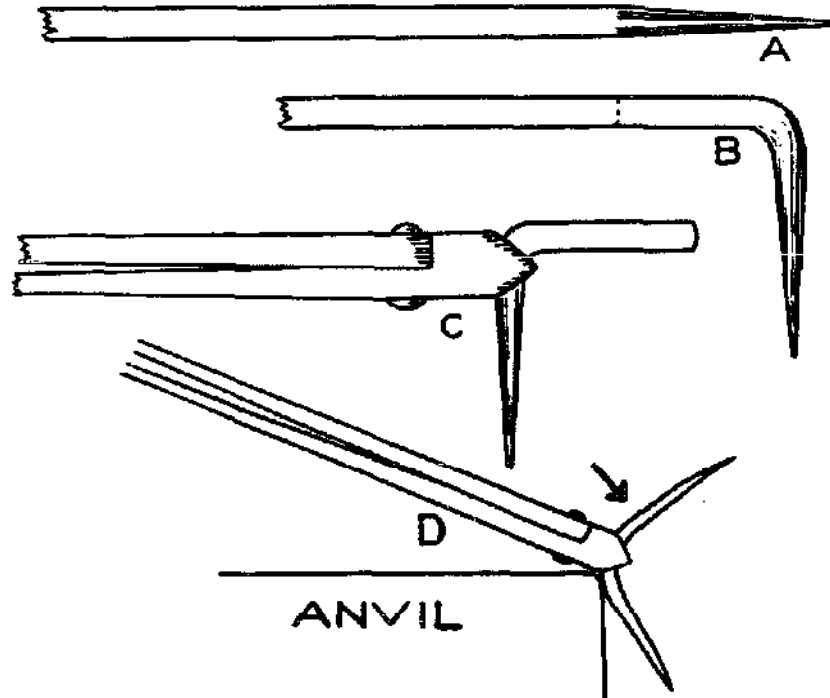

FIG. 15. STEPS IN MAKING A STAPLE

the horn or the rounded corner of the anvil, regulating the bend with light blows of the hammer.

CHAIN LINKS One of the jobs which the farm smith will often be called upon to do is to mend broken chains. The right way to do the job of mending, if time will permit, is to make a new link with which to join the broken parts. For temporary repairs there should be a supply of what are called cold-shut links which may be

BLACKSMITHING

substituted for broken links without any loss of time.

To make a new link, take a piece of round rod of the

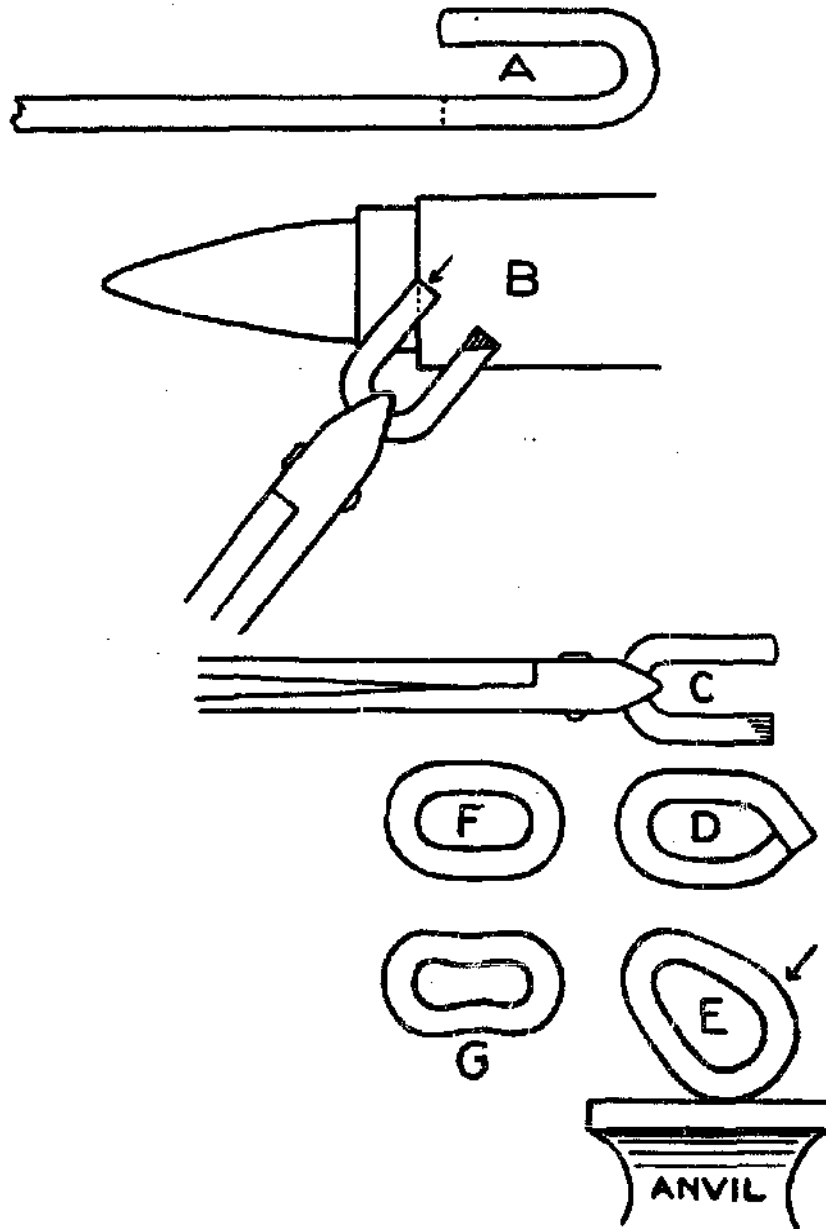

FIG. 16. STEPS IN MAKING A CHAIN LINK

SIMPLE EXERCISES IN BLACKSMITHING

same size as that used in making the chain, and bend it into the form of a capital letter U as shown at A in Figure 16; then, holding the bent part with a pair of chain tongs, heat the two ends to a yellow heat and scarf the inside corner of each end by holding it at an angle on the edge of the anvil. Notice in B and C that only the corners are flattened, not the whole end. The ends are then bent so that the scarfed surfaces fit together as at D, and the joint is ready for welding. The heating for welding should be done in a clean fire and the link should be closely watched to see that one side does not heat faster than the other. It is a good plan to turn it over often, for the lower side is likely to become hot sooner than the upper. When the end to be welded is perfectly white, and the surface is in a fluid condition, it should be quickly placed on the anvil and struck two quick, light blows: one on each side of the weld. The part at the weld should now be worked as nearly round as possible over the horn of the anvil. This will probably widen the link too much at one end, so that it will look more or less like E in the illustration. To shape it properly so it will resemble the link shown at F, it should be held as shown at E and struck where the small arrow is pointing. This will put the bend where it should be, in the end of the link. If it had been held with its side on the anvil and had been struck on the other side, as almost all beginners do in their first attempt, it would resemble the crooked link shown at G.

COLD SHUT LINKS There are two good ways of making cold shut links to use as temporary repairs in log chains. In the one shown at A in Figure 17, a piece of rod the size of the iron in the chain is slightly upset at one end and a hole punched in it large enough to

BLACKSMITHING

fit the other end of the rod which is bent around as shown. In use, this link takes the place of the broken link and is closed together and the end riveted.

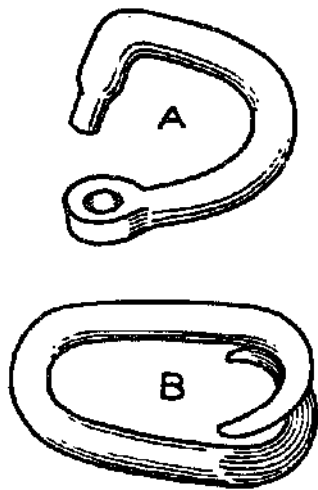

FIG. 17. COLD SHUT LINKS

Another temporary link which is not quite so strong as the one just described, but which can be made in a little less time, is made by drawing out the two ends of a letter U and bending them around as shown at B in Figure 17. When this is hooked into the place of a broken link, a blow of the hammer will close it so it will answer very well as a temporary substitute for a link.

CHAIN HOOK Hooks for log chains are of two

kinds: round hooks large enough for the chain to slide through easily, and grab hooks made narrow with just enough room between the two sides to admit a link edgewise.

There are two common ways of making a chain hook. Where good, tough iron or mild steel of the proper size is at hand, the easiest way to make a hook is to upset the bar where the middle of the hook is to be and the end where the hole is to be punched, as shown at A and B in Figure 18. The hole is then punched, and the iron around the hole is worked as nearly round as possible over the horn of the anvil. The bar is then cut off at the point indicated by the dotted lines, and the end is drawn out and rounded as in B. The hook is next to be bent and beveled so as to have a cross section through the largest part like that shown at C. It should be bent only about halfway

SIMPLE EXERCISES IN BLACKSMITHING

at first as the beveling of the back causes it to bend more. The reason for beveling a hook is that it makes it stronger

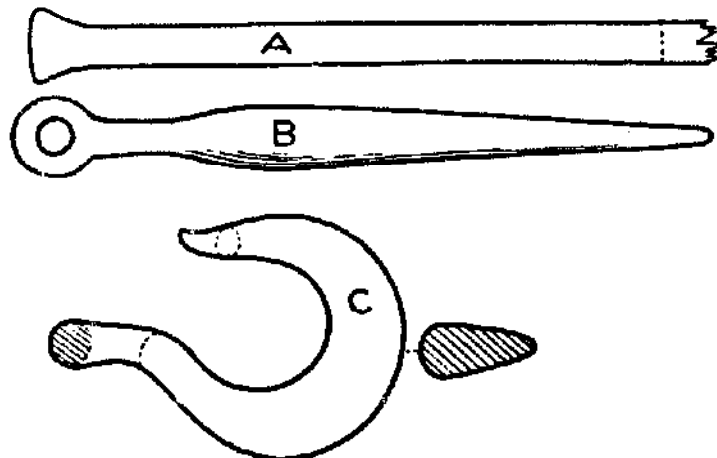

FIG. 18. CHAIN HOOK No. 1

in the line of pull than it would be if left round. The most common weakness in a log chain is the hook which is not strong enough to stand a heavy pull without straightening.

Another way to make a chain hook is shown in Figure 19. By this method iron of smaller size may be used than in the hook just described, for the reason that the iron is

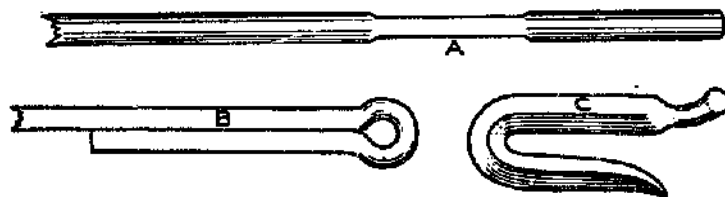

FIG. 19. CHAIN HOOK No. 2

doubled at the place where the strongest part of the hook is to be. In forging a hook by this method a part of the rod, marked A, is drawn down to the proper size to form the eye of the hook; then the end of the rod is doubled

BLACKSMITHING

back and welded as shown at B. The rod is then cut off and the hook shaped as in the case above described; or, if it is to be a grab hook, it should be bent on the corner as shown at C. The novice may have trouble in making the iron bend on the corner; but if he will start the bend by putting the end in the square hole of the anvil, then cool the end while the balance of the piece is left hot, then put the cool end in the vise, he will have no trouble in finishing the bend.

SWIVEL Log chains are often broken because of becoming twisted. This is especially true in logging work. To avoid twisting, every log chain should have a swivel at about its middle point. Making a swivel is a good exercise in forging. To make a swivel it is necessary first to have a mandrel over which to form the middle part of the swivel. For the mandrel it is best to use a piece of $\frac{7}{8}$ -inch round, mild steel. One end of this should be heated and a very short piece of the end, about $\frac{1}{2}$ inch, should be drawn out to about $\frac{1}{2}$ inch in size as shown at A in Figure 20.

The material for the main part of the swivel should be a piece of mild steel 1 inch wide and $\frac{1}{2}$ inch thick. One end of the bar should be drawn out to $\frac{3}{8}$ inch in size and 3 inches long; the middle section about 1 inch long, should be left the original size; and the other end also drawn out to $\frac{3}{8}$ inch the same as the first part, as shown at B. A $\frac{1}{2}$ -inch hole is to be punched through the middle section, and the piece heated to a white heat and placed on the mandrel to be worked into the shape shown at C.

The eye is made by welding the end of a $\frac{7}{16}$ -inch rod back on itself to form the opening, then working the shank down to $\frac{1}{2}$ inch as shown at D. The shank should be just

SIMPLE EXERCISES IN BLACKSMITHING

long enough to go through the main part of the swivel, through a washer, E, with enough space to make a good head when riveted. The riveting should be done while the end

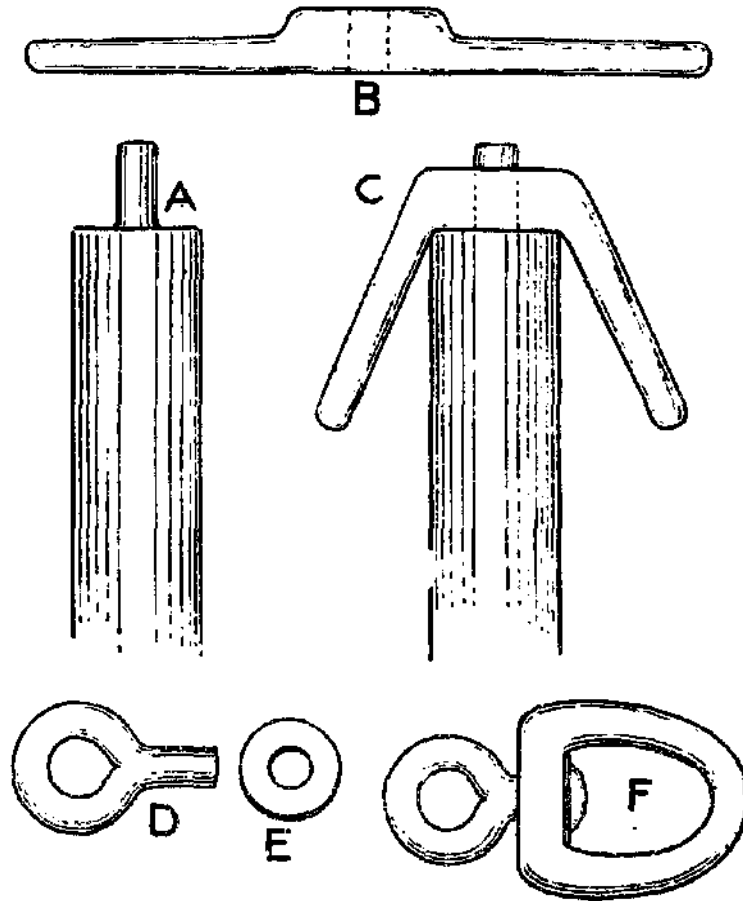

FIG. 20. STEPS IN MAKING A SWIVEL

of the shank is red hot. The two arms of the swivel should then be bent together and welded in the same manner as the chain link described on page 33. The completed swivel is shown at F.

BLACKSMITHING

Riveting the shank in place will probably make it so tight that it will not turn easily. The cure for this condition is to heat the whole swivel to a light red heat and turn the shank around a few times while hot.

RING The proper way to start a ring that will be of even thickness throughout, is to upset both ends of the rod from which the ring is to be made, enough so that there

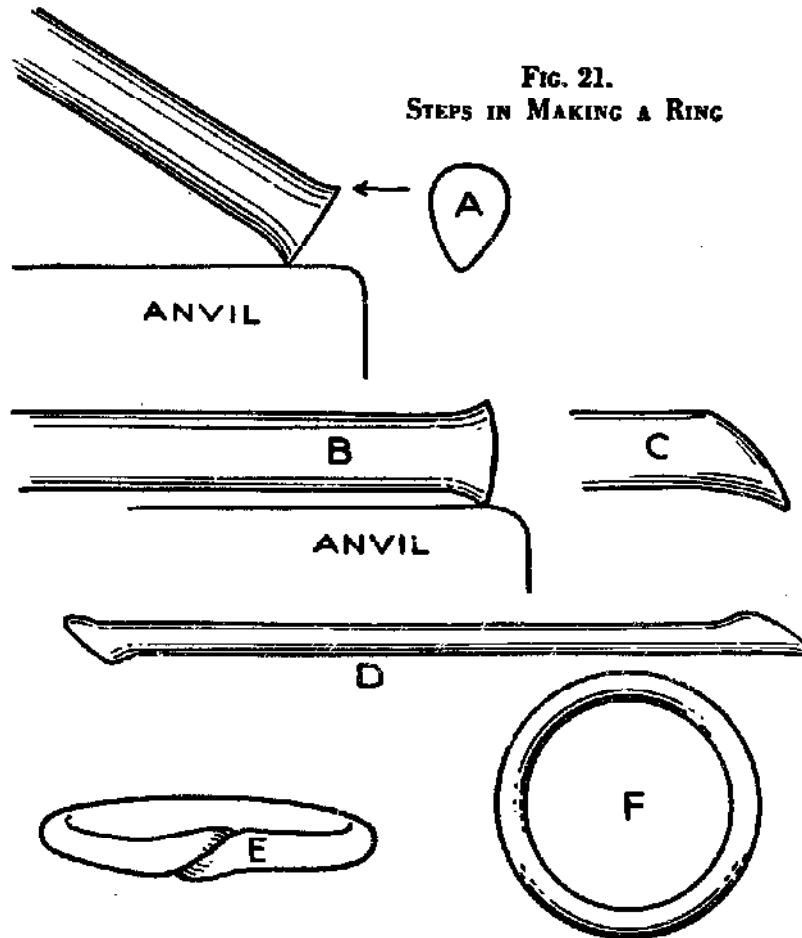

will be no thin spots at the sides of the weld when the job is finished. After the ends are upset each one is to be

SIMPLE EXERCISES IN BLACKSMITHING

heated in turn and scarfed for welding. This process consists in first shaping the end as at A in Figure 21, then holding the rod level on the anvil, as at B, and pounding the end back and rounding it slightly as shown at C. The scarfing of the second end should be made on the side opposite the first, as in D, so that when the iron is bent to form the ring, the two scarfs will fit together and their ends be, not one inside and one outside the ring, but both out where the hammer can get at them, as shown at E.

In heating the ring for welding, the same directions apply as for the chain link, described on page 33. After welding, the iron in the welded place and for a little space on each side will probably be a trifle larger than in other parts of the ring. This can be easily worked down to the proper size by heating to a low red heat, and going over it with light blows of the hammer. The finished ring is shown at F.

Where appearances make little difference, rings are sometimes made like chain links and rounded up afterward.

When a ring is made to go on the end of a chain it should not be bent into the chain before welding, but should be finished as a separate ring, then joined to the chain by another link.

CLEVIS To make an ordinary coupling clevis requires about 13 inches of $\frac{5}{8}$ -inch round, mild steel as shown at A in Figure 22. This bar should be upset in the middle, where the greatest wear will come, and at the ends where the holes are to be punched, as shown at B. The ends should be flattened out and rounded and holes punched in them as shown at C. The holes should be large enough to admit a $\frac{1}{2}$ -inch bolt easily. The clevis is then to be bent into shape so as to leave a space of $2\frac{1}{4}$

BLACKSMITHING

inches between the ends, as shown at D in the illustration.

Another, and a quicker way, of upsetting the ends where the holes are to be punched, is shown in Figure 23. A

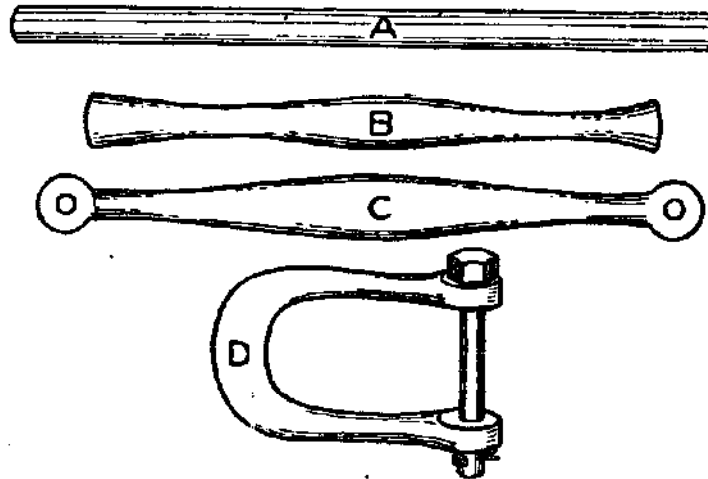

FIG. 22. STEPS IN MAKING A CLEVIS

short piece of the end of the iron is turned up at a right angle, as at A, then heated to a welding heat and pounded straight down so as to form a lump as shown at B. If

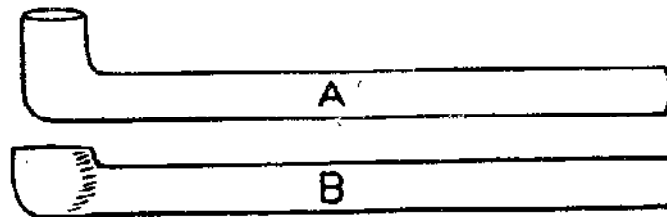

FIG. 23. UPSETTING IRON FOR CLEVIS

carefully done this makes a neat, round end with less labor than is necessary to round out and finish the kind of end shown in Figure 22.

What might be called an emergency clevis may be made

SIMPLE EXERCISES IN BLACKSMITHING

in a few minutes by using about 20 inches of 7/16-inch round, mild steel, welding it in the form of a long link, then closing the sides together as shown in Figure 24, and bending to form the clevis.

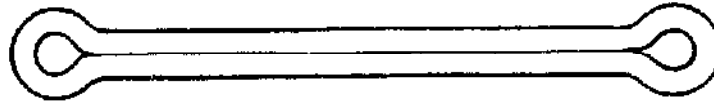

FIG. 24. AN EMERGENCY CLEVIS

PIN OR BOLT FOR CLEVIS The pin or bolt for the clevis should be made of 1/2-inch mild steel. The easiest way to make the head of the bolt is to upset the end a little, then drive the bolt into a heading iron. If the farm smith does not have a set of heading irons, perhaps he can find what he needs in the scrap pile or "machinery graveyard." Almost any heavy piece of cast iron with a 1/2-inch hole in it will answer for a heading tool for the clevis bolt. The upset end should be at welding heat when the bolt is driven into the heading tool, and the smith should be careful to drive it straight down over the hole so that the head may not be one-sided.

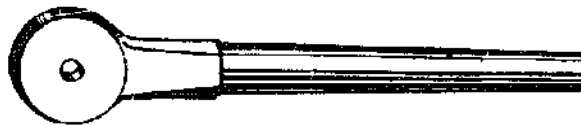

FIG. 25. HEADING TOOL FOR BOLTS

HEADING TOOL FOR BOLTS Heading tools for bolts of the most commonly used sizes should be found in every shop. They are among those tools which the farm smith can make on rainy days. To make a heading tool it is only necessary to upset one end of a large

BLACKSMITHING

piece of mild steel, flatten and round it, as shown in Figure 25, then punch a hole of the proper size. Heading tools for small bolts and rivets are sometimes made with several holes of different sizes in one tool. In this case the head end of the tool is, of course, made long instead of round, and the holes are generally drilled instead of being punched.

BOLTS AND NUTS Small bolt heads are generally made by the upsetting method described in the making of the clevis bolt. This is the method used in mak-

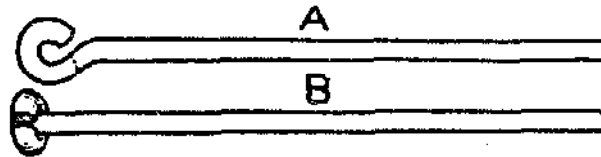

FIG. 26. WELDING HEAD ON BOLT

ing ordinary carriage bolts, although, of course, they are made by machinery.

Heads on large bolts are generally welded on instead of being upset. In making a welded head it is customary to use for the head a piece of rod one size smaller than the bolt itself. An eye is turned in the end of the rod as in Figure 26, A, which is fitted to the bolt. This eye is then cut nearly off on the hardy, but is cut so short that it will reach only about three-fourths of the way around the bolt, as shown at B. The end of the bolt is then heated and upset a trifle in the eye, then the eye is broken from the rod and struck with the hammer in such a way as to pinch it tight to the bolt. The whole is then heated to welding heat and welded. While welding, the piece should be held so that the open place in the smaller iron is at one side where it will be closed when struck by the hammer. The reason

SIMPLE EXERCISES IN BLACKSMITHING

for making it so as to reach only part way around the bolt will now be seen. If it had been so made as to reach all the way around, it would have been too long and would have caused trouble by buckling up and spoiling the weld.

When it is necessary to put a head on a long rod, like a truss rod for a bridge, a short piece of rod the same size as the truss rod is headed, then welded to the long rod.

Nuts for bolts are easily made by simply punching holes of the needed size in iron or mild steel of the proper thickness and width, and then threading them to fit the bolts. On most farms it will seldom be necessary for the farm smith to make any nuts for the reason that nuts of almost all sizes and kinds may be salvaged from the scrapped farm machinery.

Cutting threads on bolts and in nuts is such a simple proceeding that little instruction in this line is necessary. It will be very seldom that the farm smith will be called upon to cut threads on any thing larger than $\frac{3}{4}$ inch in size. Dies that will take care of all threading on iron from $\frac{1}{4}$ inch up to $\frac{3}{4}$ inch may be had for about \$5.

One or two precautions regarding the use of dies may be in order. Dies should never be used on hot metal, as this would spoil the die by removing the temper. Dies should not be expected to cut tool steel. Mild steel sometimes contains enough carbon to cause it to harden when suddenly chilled from a high temperature. It is therefore always wise to anneal (soften) a piece of mild steel by heating to a red heat, then allowing it to cool slowly in the air before attempting to cut threads on it with a die.

An assortment of carriage bolts of the most commonly used sizes and lengths should be found in every farm shop. Such an assortment properly kept where a bolt of any size or length may be found at a moment's notice, will prove

BLACKSMITHING

a great timesaver on any farm. A fairly complete list for such an assortment would be one package each of the following sizes and lengths:

¼ IN. DIAMETER

Length	Price Per Pkg. of 25
1¼	\$0.11
1½	.11
1¾	.13
2	.14
2½	.18
3	.20
3½	.21
4	.25
4½	.27
5	.31
6	.34

⅜ IN. DIAMETER

Length	Price Per Pkg. of 25
1½	\$0.18
2	.21
2½	.28
3	.31
3½	.34
4	.36
4½	.40
5	.43
5½	.46
6	.52

⅝ IN. DIAMETER

Length	Price Per Pkg. of 25
1¼	\$0.23
1½	.24
2	.28
2½	.34
3	.39
3½	.43
4	.45
4½	.46
5	.53
6	.63

½ IN. DIAMETER

Length	Price Per Pkg. of 25
2	\$0.57
2½	.68
3	.76
3½	.83
4	.88
5	.95
4½	.90
5½	1.00
6	1.10

The farm smith should know of the saving which may be made by buying bolts in wholesale lots. A full package of 25 bolts may be had for about the same price as half that number bought at retail.

SIMPLE EXERCISES IN BLACKSMITHING

WELDING SEPARATE IRONS In welding the link and the ring already described, the ends of iron to be welded were naturally held together. Welding separate irons introduces the new problem of placing them together while at welding heat, and getting them to stick together before the heat is lost. Figure 27 shows the proper way to place the two irons on the anvil when ready to weld.

Round irons to be welded together should first be upset and scarfed the same as the two ends of the iron for making a ring. They should be placed in the fire with the scarfed faces down, for the reason that the under part of

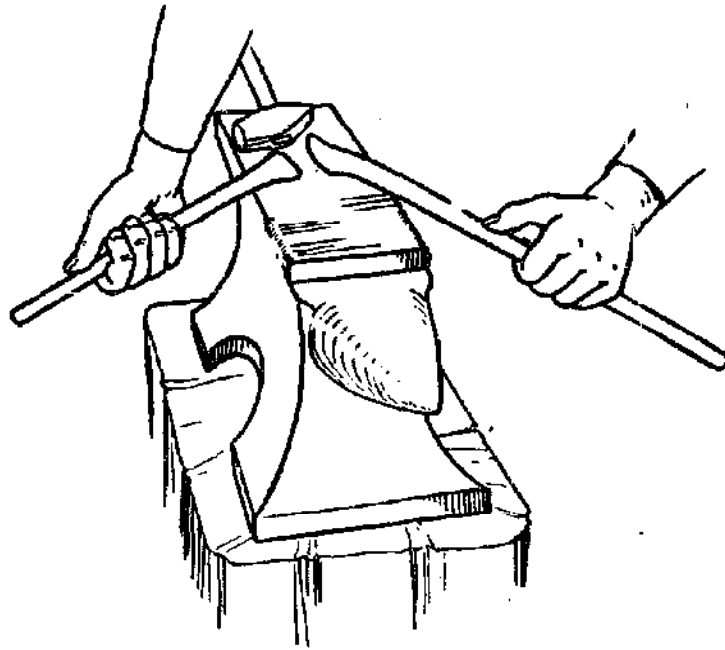

FIG. 27. WELDING SEPARATE IRONS

anything in the forge fire heats faster than the upper side. Particular pains should be taken to get the two irons to heat evenly. If one should appear to be heating faster

BLACKSMITHING

than the other, it should be pulled back a little until the other iron has had a chance to gain the same heat.

Before heating the irons for welding, the beginner should practice getting them from the fire and on the anvil so that when they are ready to weld, he may get them together in the best way and in the shortest possible time. To do this he should grasp the right hand iron with the back of the hand uppermost and the little finger toward the fire. This will naturally bring the iron face side up on the anvil.

Note in the illustration that the hands are holding both irons, not on the face of the anvil, but resting over the edge, so that they can be held steady while the left hand iron is being placed on the other one. If the end of the first iron were to be placed flat on the anvil before coming in contact with the second iron, the anvil, a very good conductor, would absorb enough heat to bring it below the proper welding heat. The result would be a poor weld, if, indeed, the irons chanced to stick at all.

When both irons are at welding heat, that is, when they are perfectly white and the surface is in a melting condition so that it looks as though it were wet, they should be taken quickly from the fire, given a sharp rap against the anvil to shake off any scale or slag that might be sticking to the faces of the scarfed ends, then placed against the edges of the anvil as shown in the cut and the scarfs brought steadily together with the left hand iron on top of and holding the other. The right hand is now free to let go of its iron and pick up the hammer, which should be lying on the end of the anvil. The first blow struck should be light to help stick the irons together, then heavy blows should follow to perfect the weld. In welding large irons it is often possible to make a complete weld and finish it

SIMPLE EXERCISES IN BLACKSMITHING

down to the original size of the iron at one heat; but with small irons, which lose their heat quickly, it is usually necessary to heat several times in order to complete the weld. In welding, the smith should never strike a blow after the iron cools below welding heat, as that would only thin the iron and do the weld no good.

In welding one long and one short piece of iron together, the short piece should be managed with the right hand, using a pair of tongs. This will put the short iron on the under side on the anvil where it may be held by the longer piece while the smith lets the tongs fall to the floor and picks up his hammer.

In the case of irons so small that they would lose their heat while being carried from the fire to the anvil, it is well to protect them with a flux of sand or borax. With larger irons ($\frac{1}{2}$ inch or over), no such protection is necessary.



FIG. 28. WELDING FLAT IRONS AT RIGHT ANGLES

In welding together pieces of flat iron they should be upset and scarfed as shown in Figure 11, page 25. The faces of the scarfs are a trifle convex as in the case of the round irons, and the process of welding is the same; but it is a little more difficult to make a finished, smooth job of welding with flat irons, because the corners and edges lose their heat sooner than the rest of the iron.

When flat irons are to be welded at right angles they

BLACKSMITHING

should be slightly upset and scarfed as shown at A, and put together as shown at B in Figure 28. After welding irons together in this form it is unwise to try to forge a sharp inside angle as this is likely to start a crack. It is considered better practice to leave the inside corner a little rounding, or, if a sharp corner is required, to finish by filing after the iron is cold.

It is often required that flat irons be welded together in the form of a T. In such a case, the iron forming the

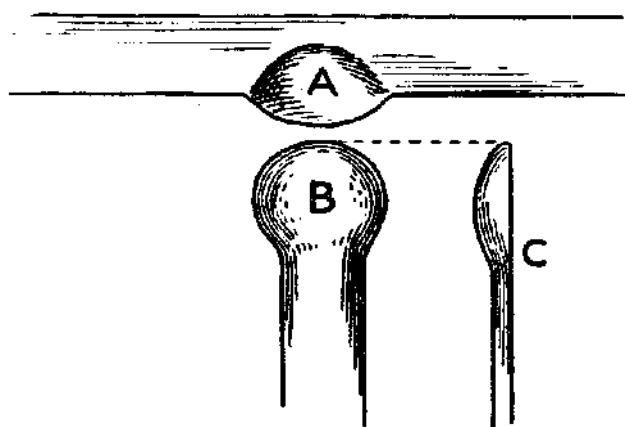

FIG. 29. WELDING A "T"

head of the T should be slightly upset, then scarfed, as shown at A in Figure 29. The part which is to form the shank or upright of the T is upset and shaped as shown in the two views B and C in the cut. Before putting the two parts together for welding, the smith should be very sure that no scale is left in the hollowed scarf at A.

WELDING IRON AND STEEL In the days of our grandfathers, when tool steel was very costly in comparison with the price of iron, many tools were made partly of iron and partly of steel. For example, hand

SIMPLE EXERCISES IN BLACKSMITHING

hammers were made of iron with a face of steel welded on. Iron plow shares had a strip of steel welded, or "laid," as the old smiths expressed it, along the edge. This is what gives the commonly used name of "lay" to that part of a plow.

In these days of comparatively cheap steel, it is cheaper to make a whole tool of steel than to do the welding that formerly was done. There are, however, occasions when it is desirable and practical to weld steel and iron, and the farm smith should be able to do the trick and make a good job of it.

A very good crowbar may be made of a piece of mild steel shafting by welding a piece of tool steel in one end and drawing it down to the proper shape.

A good churning drill for work in rock may be made in the same way.

In making a heavy screw driver, where it would seem a waste of tool steel to make it entirely of that material, mild steel may be used for all but a little wedge of tool steel welded in the end.

The method generally used in welding tool steel to iron or mild steel for the tools just mentioned, is illustrated in Figure 30. The bar of iron or mild steel is first upset at the end as shown at A. It is then split with a thin chisel as at B, spread open as at C, and the two halves flattened out into the form of rather thin, wide lips as at D. A piece of tool steel of the proper size is then drawn out in the form of a wedge, and the two lips of the bar are wrapped around it as shown at E. The whole end is then covered with borax and welded.

Steel, enclosed in a coating of borax, will weld at a yellow heat. Beginners often make the mistake of getting the steel too hot.

BLACKSMITHING

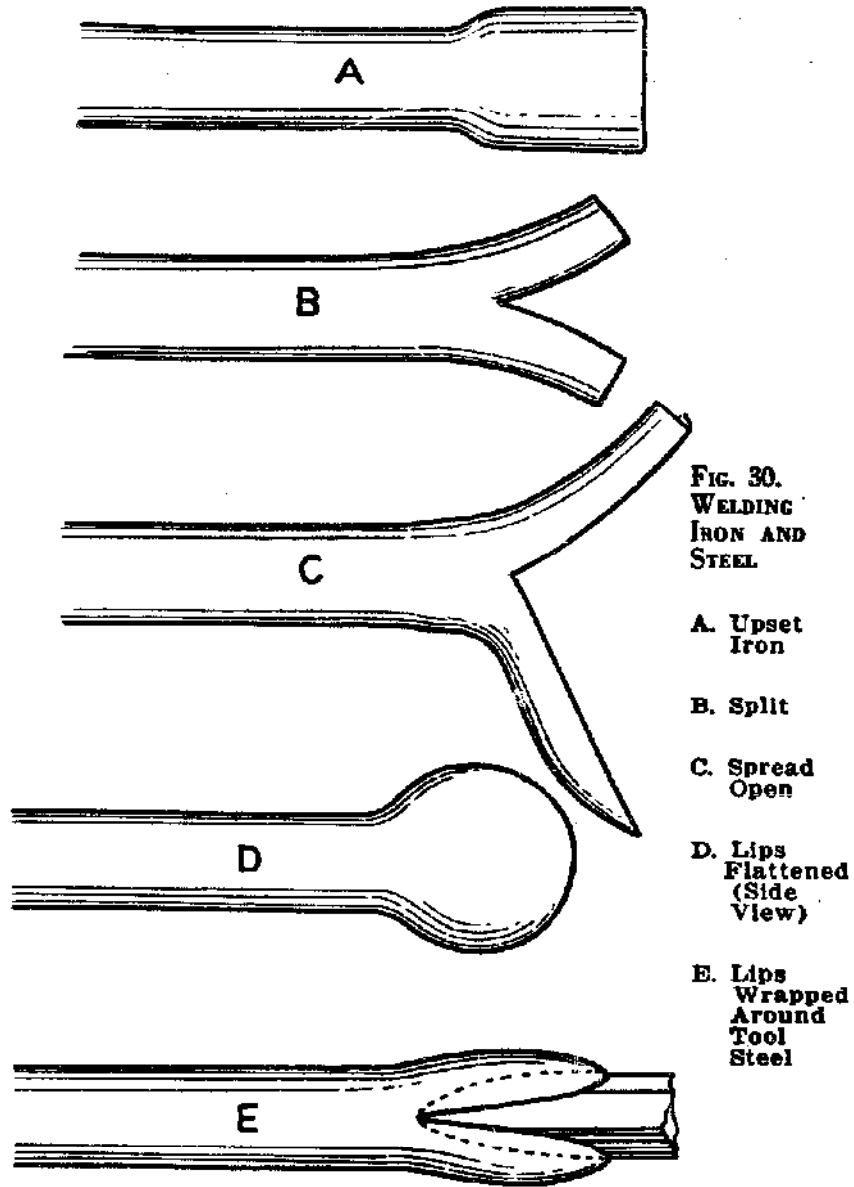

As a first attempt at this kind of welding, the amateur smith might well try to make a screw driver by taking a piece of 7/16-inch mild steel about 16 inches long, and

SIMPLE EXERCISES IN BLACKSMITHING

welding a wedge of $\frac{3}{8}$ -inch tool steel in one end. Then if he will draw the other end to a short point and bend it around and weld it as shown at A in Figure 31, then give

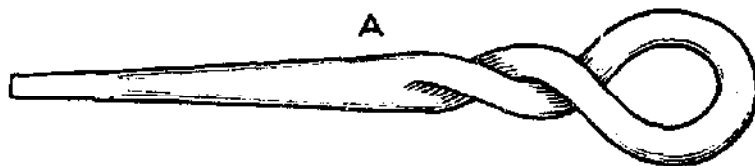

FIG. 31. A SCREW DRIVER OF MILD STEEL AND TOOL STEEL

it a twist as shown, he will have a good-looking screw driver, the handle of which will never come off. The steel in the end may be refined by hammering, as in the case of the cold chisel, (see page 56), and should be tempered a trifle softer than the cold chisel.

VI

FORGING AND TEMPERING STEEL TOOLS

MAKERS of tool steel make many different grades of steel according to the purposes for which they are to be used. This should be understood by the amateur smith, and he should always tell the dealer what he expects to make of the steel that he buys so that he may be sure to get the grade that will be most suitable. The main difference between the different grades of tool steel lies in the amount of carbon contained in each. A piece of steel that would make a good punch or cold chisel would not make the best kind of a rock drill because it would be lacking in the amount of carbon and could not be made to hold the edge that would be possible with a steel of higher carbon content. A spring cannot be made from an old file because the file contains altogether too much carbon, and would be too brittle to stand much bending. Many people harbor the delusion that the best kind of a knife blade can be made from an old file. The idea probably grew from the thought that the file is able to cut iron and steel, and therefore a knife made of the same material ought to cut almost anything. The truth of the matter is that steel suitable for making files contains such a high percentage of carbon that it is too brittle for making the best kind of knives.

A smith who is used to working with tool steel is able to make a good guess at the amount of carbon in a tool

FORGING AND TEMPERING STEEL TOOLS

such as a chisel or punch, which has been used for some time, by the way the head or top end reacts to the blows of the hammer. If the end has spread out and turned down like the petals of a sunflower, it is steel of low carbon content. If, on the other hand, particles of steel have broken off instead of turning down, steel of high carbon content is indicated.

The beginner in blacksmithing, who has had some experience in forging iron, finds that he has some new points to consider when he begins to work with tool steel. In the first place, unless he has been warned and is on his guard, he will almost certainly burn the first piece of steel he attempts to heat in the forge fire. On account of the carbon which it contains, steel is much more easily heated than iron, and the margin between the proper heat for forging and the burning point is very much narrower than in the case of iron. Iron may be heated to the point of melting without any particular damage being done; but tool steel, heated to the same degree, would be totally ruined. It is also true that steel is more easily damaged than iron by being exposed to injurious chemicals. It is, therefore, very important that the fire in which steel is to be heated should be kept clean and free from ashes and cinders; and the coal used should be well coked before coming in contact with the steel.

In heating steel for forging it is very necessary that it be heated slowly so that the center of the piece shall be of the same temperature as the outside; and if the steel is to be drawn out, as in the case of a cold chisel or punch, it is important that the hammer blows be heavy enough to affect the steel to the middle of the bar. If light blows should be used, the outside of the bar would be drawn out faster and farther than the middle, and strains would be set

BLACKSMITHING

up in the metal which would be likely to show up as cracks when the tool so made came to be tempered.

A COLD CHISEL After having had enough experience in the forging of steel so that he can heat his metal without burning it, the farm smith will be able to make better cold chisels than he can buy. But to do this he must use great care in heating, in forging, and in tempering. For forging, the steel should not be heated above a light yellow. For tempering, a cherry red is hot enough.

In forging a cold chisel the steel should be drawn out in a wedge shape and not allowed to spread out, as it will be inclined to do, in the form of a dove's tail. After being drawn out in the form of a long, straight wedge, a little of the edge should be cut off; for, no matter how much care may have been used in the forging, the outside has been drawn out a little faster than the inside, and cutting off the extreme end—perhaps $\frac{1}{2}$ inch or even less—will insure an edge of sound metal. The chisel is now ready to be cut from the bar. This should be done by heating at the right point to a light red, and cutting it round and round on the hardy so as to make an even, smooth job. If the hammer is held at the proper angle while this cutting is being done, it will help to make the slight bevel on the head of the chisel which is shown in the cut of the finished tool. The wedge-shaped part of the tool should next be refined by proper hammering. The right way to do this is to heat to a dull red and pound it well on both flat sides with a heavy hammer, beginning with heavy blows which should become lighter and lighter as the metal cools, and stopping when the red color has disappeared. If this pounding has spread the edge out too wide it would be a mistake to try

FORGING AND TEMPERING STEEL TOOLS

to remedy it by any pounding on the edges, for this would undo what has been done by the hammering on the flat sides. Any necessary trimming of the sides should be done by grinding or filing after the tool is cold.

The above described refining process is what constitutes the main difference between a first class tool and an ordinary one. A tool so made and properly tempered will

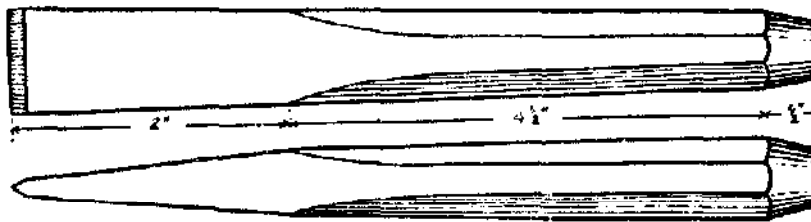

FIG. 32. A COLD CHISEL

stand more hard usage, and even abuse, than one that has simply been shaped and tempered without the refining process.

After the chisel has been filed or ground to the proper shape, as shown in Figure 32, it will be ready for tempering.

What is usually spoken of as tempering is in reality a double process; for the steel is first hardened, then softened to the desired degree to suit a particular need.

In the case of a cold chisel which needs to be hardened only at the edge, the easiest way to do the tempering is to chill the end and then let the heat from the balance of the tool bring it back to the proper temperature. The whole of the tool is first heated to a dull red color. Great care is necessary in heating to avoid getting the thin end too hot. Plenty of time should be taken to get an even heat throughout the whole piece. It is advisable to push the thin end through, beyond the middle of the fire, to

BLACKSMITHING

allow the body of the tool to heat first. When the whole tool is of an even, dull red color, it should be taken from the fire and held in a vertical position over the water and an inch or two of the edge dipped beneath the surface. It should not be held still, but should be danced up and down until, when raised above the surface of the water, it remains wet for a few seconds. The reason for the dipping is that if the tool were to be held still in the water, the great difference in temperature between the two parts would be very likely to cause a crack to form at the water-line.

After the dipping, the chisel should be polished quickly on one flat side by rubbing with a piece of whetstone or brick. There will then appear on the polished surface a band of colors which will be seen to be passing from the hot tool toward the cool end. These colors indicate the degree of hardness of the steel. The first color to be seen is a very pale straw color, then follow in order—pale yellow, yellow, dark yellow, brownish yellow, brown, light purple, dark purple, blue, darker blue, greenish blue. A cold chisel for ordinary work should be quite soft in comparison with other tools, and the proper temper is indicated by the *blue* color in the color band. When this color reaches the edge, the tool should be quickly dipped into the water again to prevent any further softening. If by this time the body of the tool has so far cooled off that no red color is to be seen, it will be safe to cool the whole chisel in the water.

A chisel made and refined and tempered as above described will easily cut a chip from the bar from which it was made. At the same time the edge will not be too hard to be sharpened with a file. A chisel made from the same bar but without the refining process, in order to be able to

FORGING AND TEMPERING STEEL TOOLS

cut steel would have to be tempered harder, and consequently would be more brittle and more likely to break than the one first described.

FORGING AND TEMPERING DRILLS Flat drills for ordinary work may be made of the same kind of steel which is used for cold chisels, and the same rules for heating, drawing, and refining the steel apply as in the case of the chisel. In Figure 33 are shown two kinds of drills; one an ordinary flat drill, the other a drill with a twisted end. The latter will cut faster and easier than a flat drill, and is not so hard to make as one who had never learned the trick of making the twist might suppose.

In making a flat drill the steel is drawn out square to the size wanted for the neck of the drill, then it is rounded and the end flattened, as shown at A in Figure 33, and refined by pounding. The corners are then cut off on the hardy by being held in such a way as to give the proper angle and bevel to

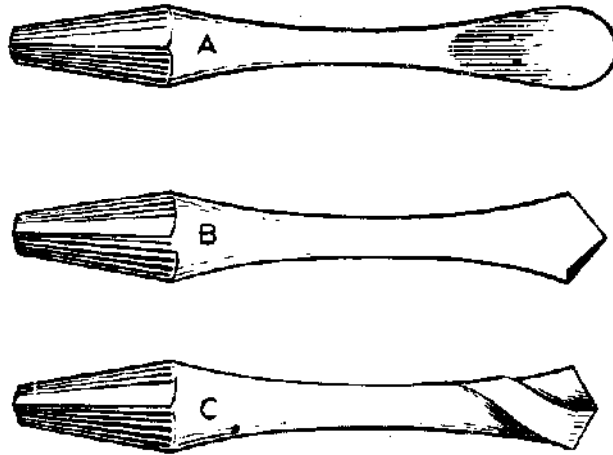

FIG. 33. STEEL DRILLS

the two sides. The proper shape is shown at B. This will save some filing. The drill is allowed to cool slowly; then filed to the proper size and bevel.

BLACKSMITHING

In the case of large drills, the tempering may be done in the same way as in the case of the cold chisel. With small drills, it is better to chill the whole tool, then, after polishing, heat for the tempering by pinching between the jaws of a pair of hot tongs. For ordinary work, drills should be tempered to a purple color.

The drill with the twisted end, shown at C in Figure 33, is started in the same way as the flat drill, then the twist in the end is started by putting the middle of the flat end in the corner of the vise, or holding it with a small pair of tongs and giving it a slight turn to the left. The rest of the twisting is done with a light hammer and by using very light blows. The steel is held in such a way that the blows of the hammer tend to give it more twist; but the blows are so light that the edges of the steel only are upset—leaving the middle thin as in the case of a machine-made twist drill. It is well for the beginner to practice first with a piece of mild steel.

STONE DRILLS Drills for working in stone should be made of steel having a higher percentage of carbon than that used for cold chisels, punches, etc. Because of the higher carbon content this steel is more easily spoiled by overheating, and greater care must be used by the smith.

A drill intended for working in limestone, slatestone or other comparatively soft rock may be finished with a thinner edge than one intended for use in granite. In Figure 34 an attempt has been made to show about the right angle to be given the edge for the different kinds of stone: A for soft stone, B for granite. The edge should be curved about as shown in the side view at C.

The steel in a stone drill may be refined by hard hammering on the sides, just as in the case of the cold chisel.

FORGING AND TEMPERING STEEL TOOLS

In tempering, it should be brought to a dull red and chilled in salt water, following the same directions as for the cold chisel, except that the stone drill must be harder, and

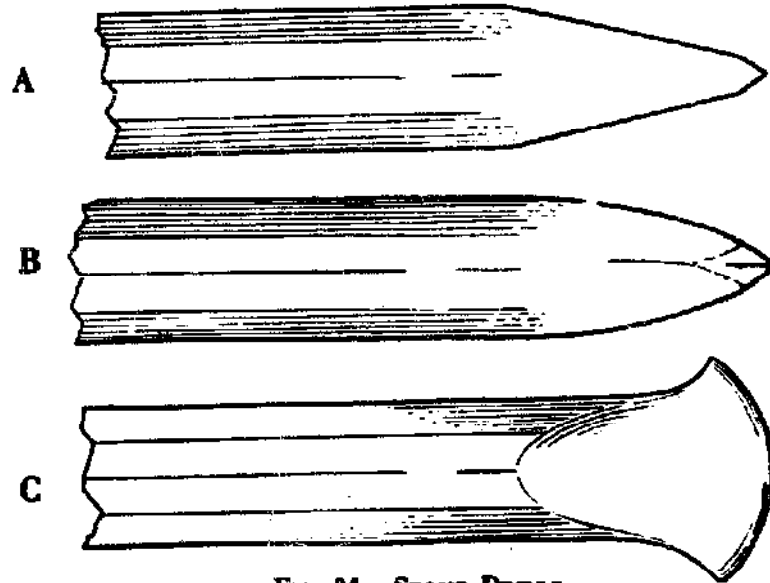

FIG. 34. STONE DRILLS

should be dipped again when the yellow color reaches the edge. Because of the curved edge, the corners become too soft before the middle is of the right temper if the smith does not do something to retard the heat. The usual custom is to touch the corners with a wet rag or sponge as soon as the right color reaches them, then to dip the whole end when the yellow color reaches the end.

KNIFE BLADES Knives are made from steel having a rather low carbon content; about the same as that used for making springs. In forging a blade it is necessary first to bend the steel in a decided curve in the direction of what is to be the edge. See Figure 35. Forging the edge thin will stretch that side of the steel enough

BLACKSMITHING

to take out the curve and make it straight. If the attempt were made to forge it without doing this bending, the result would be a blade with a backward curve which would be difficult to straighten.

The proper way to harden a knife blade is to heat it to a dull red, then dip it in water, back edge first. After polishing, the color should be drawn by pinching the back edge with a pair of red hot tongs, moving them back and forth so as to secure an even heat the whole length of the blade. The right color for the edge is dark purple. Heating from the back, as just described, leaves the body of the blade softer than the edge and it is thus able to stand bending without danger of breaking.

TEMPERING The farm smith will probably never take the time to make a hammer, for he knows that he can buy one cheaper than he could buy the steel to make one. He will, however, probably have occasion to dress up hammers that have been pounded out of shape; and it will be necessary for him to do the tempering afterwards. If he

should attempt to temper a hammer by dipping it into water while hot, in the same way as he would temper a cold chisel, the result would be exactly opposite from what he would like it to be. Dipping in water would chill the outside and leave the middle too soft. When used, the edges of the face would be likely to chip off, and the middle would be dented or sunken.



FIG. 35.
KNIFE
BLADE

FORGING AND TEMPERING STEEL TOOLS

The right way to chill a hammer for tempering is to heat it to a full red heat, then hold it under a faucet where a stream of cold water will strike the middle of the face. It should be held there until entirely cold. If the work must be done where there is no running water, a large sprinkling can from which the sprinkling head has been removed, may be used to pour a stream of water on the face. To draw the temper, a large punch or any large piece of iron that will about fit the handle hole may be heated and driven in the hole. The face should be tempered to a dark purple.

BLACKSMITH'S TONGS For making a pair of ordinary size tongs, the smith uses mild steel, $\frac{3}{4}$ inch for the jaws and $\frac{7}{16}$ inch for the handles. To shape the jaw, the steel is heated to a white heat, and placed on the anvil as shown at A in Figure 36. It is struck with the hammer at the place shown by the arrow, causing the edge of the anvil to cut up into the steel and form a sharp angle, a front view of which is shown at B. The pounding at this point is continued until the end on the anvil is about half its original thickness. At the same time the top line of A is kept straight. The piece is next given a quarter turn, so that what was the under side is now toward the right, and, after being heated again, it is placed across the anvil at an angle of 45 degrees, so that the inside angle made by the first process is exactly over the further edge of the anvil, as at C. The part C is now to be hammered down until it is half its original thickness. This will cause the edge of the anvil to cut a slanting shoulder from the under side. If given another quarter turn to the left the end will look like D in the figure. E shows a side view at the same stage. This part is next to

BLACKSMITHING

be cut off at the dotted line, and the end is to be scarfed for welding on the handle, as shown at F and G. This jaw is

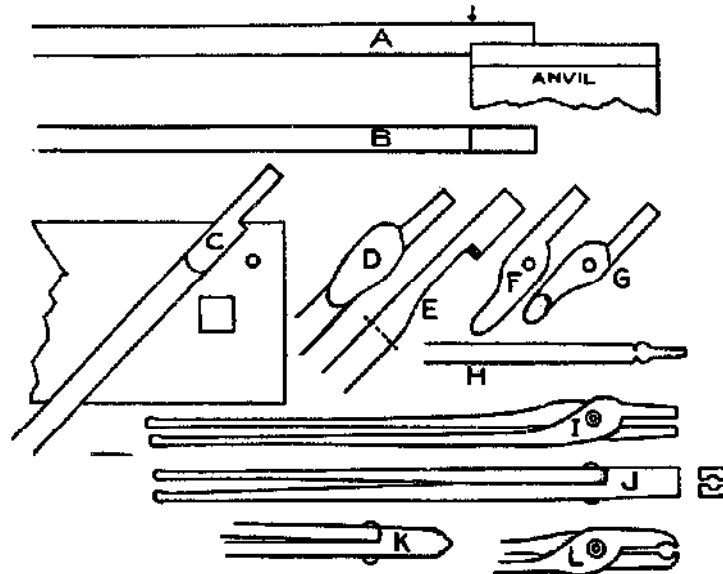

FIG. 36. STEPS IN MAKING BLACKSMITH'S TONGS

now to be laid aside, and another exactly like it is to be made.

The best way to make the handles is to use 2 feet of 7/16-inch rod, upsetting and scarfing each end, and welding a jaw to each end. The two handles are now to be cut apart at the middle point and drawn out a little and the ends finished off. The rivet holes, which should be about 5/16 inch in size, should then be punched and a rivet made to fit them. The handy way to get the rivet in place is to form it on the end of a 1/2-inch rod, and, after getting it the right size and length, to cut it nearly off on the hardy, as shown at H; then, after heating, put it in place, break it off, and rivet. While doing the riveting, the ham-

FORGING AND TEMPERING STEEL TOOLS

mer should be held at a slant so as to give a beveled edge appearance to the rivet head. Riveting the two parts of the tongs together with a hot rivet (I) will probably tighten them so they will be hard to work. This condition may be cured by heating them to a red heat and working them open and shut a few times while hot.

If the tongs are to be used for ordinary work about the shop they may be improved somewhat by making a groove in the jaws as shown in the front view at J. This grooving is done by heating the jaws of the tongs to a light yellow heat, closing them on a short piece of $\frac{3}{8}$ -inch iron, and hammering with a heavy hammer. If they are to be used for welding links of chain the corners should be cut off as shown at K and the ends of the jaws formed as shown at L by closing them while hot over a piece of $\frac{3}{8}$ -inch iron.

Figure 37 illustrates the process of making a pair of bolt tongs. A $\frac{7}{8}$ -inch mild steel is used. A lump about 1 inch long is left at the end, as shown at A, while a short, round neck is drawn down to about $\frac{7}{16}$ inch in size. The part marked B is then flattened down as shown, while the iron is laid across the anvil at a 45 degree angle, the same as in the case of the plain tongs already described. The lump at the end is flattened out as shown at C and shaped like a spout by holding in the angle between the horn and the face of the anvil, striking with the cross pein of the hammer as shown at D. The curve is next formed in the neck as at E, and the completed jaw is cut off at the dotted line and scarfed for the handle. The balance of the process is exactly the same as for the plain tongs.

Tongs of various sizes and shapes will be found convenient for handling the many different kinds of work that will fall to the lot of the farm smith. The two kinds of tongs just described are those that will be used most fre-

BLACKSMITHING

quently, and the smith who has learned to make them will have no trouble in making any others that he will need in his work.

Figure 38 pictures four kinds of tongs that are used for different kinds of work. The first, A, is used in dressing

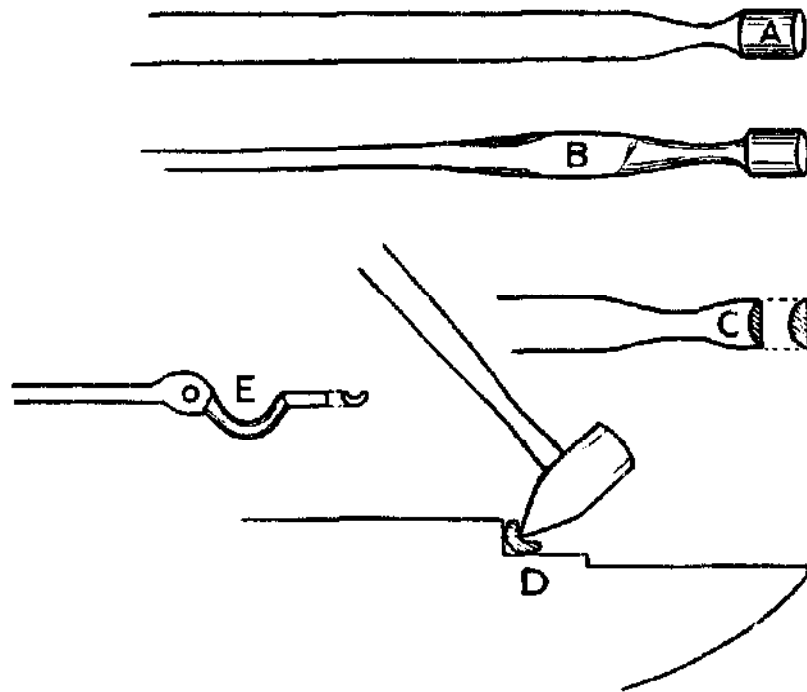

FIG. 37. STEPS IN MAKING BOLT TONGS

hand hammers and all kinds of flogging tools that have eyes for handles. B is shaped for handling ball pein hammers and short bolts. The tongs shown at C, with the jaws set off at a right angle are used in making hoops, hub bands, and whiffletree clips. Horseshoer's tongs, shown at D, are short and light in weight and have jaws that are wide and round and generally cupped so as to give a better grip on the shoe.

FORGING AND TEMPERING STEEL TOOLS

FILES The files in a farm shop are so often misused that it may be well to give space here to a brief discussion of their proper use and care.

A file is a series of very sharp, very hard cold chisels. They have to be tempered very hard to do the work expected of them, and are, therefore, very brittle and easily broken. No mechanic would be guilty of keeping his sharp wood chisels and plane irons where they would come in contact with other metal tools that might dull them. If the smith can be taught that each tooth in his files is a sharp chisel, it may be possible to induce him to have a proper place for the files where they may never be injured by other tools. Each file should have its place on a shelf or on wooden pins, and the smith should train himself always to keep it in that place when it is not in use.

A good file should never be used on hot metal or hardened steel or on hard cast iron. Cast iron nearly

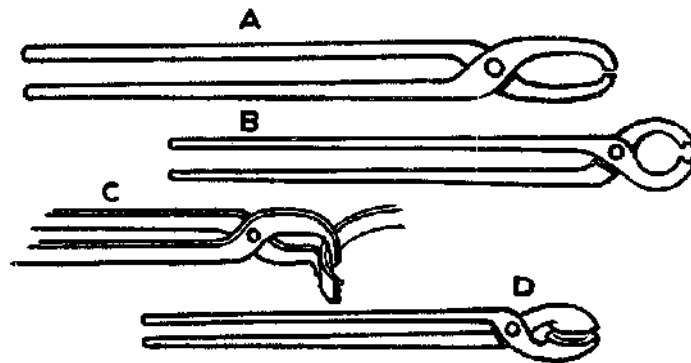

FIG. 38. FOUR TYPES OF BLACKSMITH'S TONGS

always has an outside coating which is very hard, because when the casting was made the surface, coming in contact with the cold, damp molding sand, was chilled enough to harden it. This coating is usually very thin, and if it is

BLACKSMITHING

removed by grinding or by the use of an old, worn file, the iron below the surface may be safely filed with a sharp file.

The teeth of a file are so made that the file cuts in but one direction. It should be lifted from the work on the back stroke. In filing wrought iron or steel, the spaces between the teeth often become clogged with particles of the metal and should be brushed with a wire brush or card. Sometimes soft iron filings become so tightly lodged between the teeth that the wire brush will not remove them. In such a case the smith may make what is called a scorer by flattening out the end of a soft iron rod and making a sort of comb of it by drawing it across the file lengthwise of the teeth. With this tool it is easy to poke out anything that is lodged between the teeth.

The writer once heard an old blacksmith tell his apprentice that the whole of the file he was working with was paid for. The young man took the hint and changed from short, jerky motions to long sweeping strokes which used the whole length of the file.

In order that it may be used properly, every file should have a handle, and the handle should be so attached that it will be in line with the body of the file. It is a good plan to bore a hole in the center of the handle a little smaller than the tang of the file, then heat the tang of an old file of the same size and burn the hole large enough to make a tight fit. The handle should have a tight-fitting, strong ferrule so that it will not split when the tang is driven in tight.

VII

PLOW WORK

WHEREVER steel plows are used the smith will be called upon to sharpen dull plowshares and to apply new points. While these are not particularly difficult tasks they require painstaking care and some knowledge of the proper working of steel.

SHARPENING To sharpen plowshares without aid, the tool **PLOWSHARES** to use is a heavy hand hammer with a rounding face. With such a tool it is possible to draw the share out to a thin edge by pounding on the upper side, at the same time keeping the bottom straight by holding it level on the face of the anvil. Drawing the edge out thin has a tendency to crowd the point around too much "to land." This tendency should be corrected from time to time as the drawing out process progresses, by holding the edge against a hardwood block and driving the point back to its proper position. Of course it would dull the edge to hold it against the anvil while doing this straightening.

During the whole process of sharpening the utmost care should be used to avoid burning the share. When the edge is drawn out much thinner than the rest of the share, it becomes hot so much more quickly than the thicker part that it is almost sure to be overheated unless the smith is very watchful. A light red heat is what is wanted. It is

BLACKSMITHING

a good plan to have the fire rather long in shape and to hold the edge of the share out beyond the hottest part of the fire, especially after it is drawn out thin, so that it will not be in danger of burning before the thicker part back from the edge becomes hot enough to work.

Some plowshares are made from steel containing enough carbon to allow of being hardened like tool steel. Such shares, after being sharpened, should be heated to a dull red, care being used to see that all parts of the share are of an even heat, then plunged into cold water. The thick edge should go into the water first.

Shares made from mild plow steel containing too little carbon for self-hardening may be hardened on the surface—case hardened—by bringing to an even light red heat and sprinkling with prussiate of potash. The potash will melt and flow over the entire surface of the share which should then be plunged into water or brine.

Prussiate of potash is a dangerous poison. The smith when using it for case hardening should carefully avoid breathing any of the fumes which rise from it when heated. It goes without saying that it should be kept out of the reach of children.

NEW POINTS After a plowshare has been sharpened a number of times it will usually be found that the point has become so short that it no longer serves its purpose and a new point must be welded on. The new point should be made of plow steel and not from any high carbon steel such as an old rasp or file, as the latter will cause too much trouble in welding, and may discourage the amateur smith. A suitable piece for a new point may usually be cut from the back or upper part of an old share which has not been worn too thin.

PLOW WORK

Plow steel, or any mild steel, may be easily sheared into any form by heating to just the right heat and shearing it over the edge of the anvil by the use of the set hammer as the upper blade, so to speak, of the shear. The

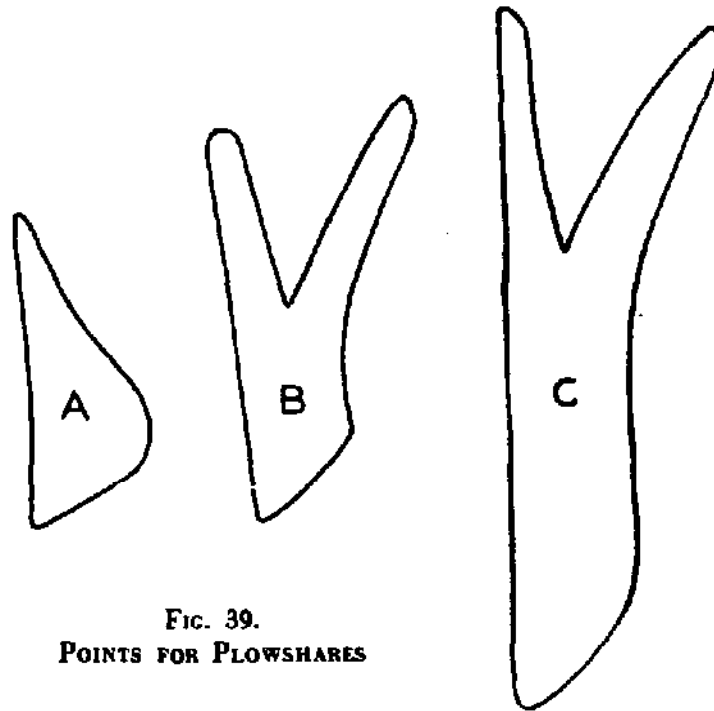

FIG. 39.
POINTS FOR PLOWSHARES

particular heat at which it may be most easily cut is between black and red; that is, when it is just cooling from red heat to black. No one seems to be able to explain why this is true, but such is the fact.

The new piece to be welded to the point should be shaped as shown at A in Figure 39. It is, of course, to be welded to the bottom of the share. In making the weld it will be necessary to use great care to have the parts reach the welding heat at the same time. To do this, it is well to heat slowly so as to give the larger part time to

BLACKSMITHING

get to the welding heat before the small point becomes too hot. Borax and iron filings should be used as a flux, and the first part of the welding should be done in the fire.

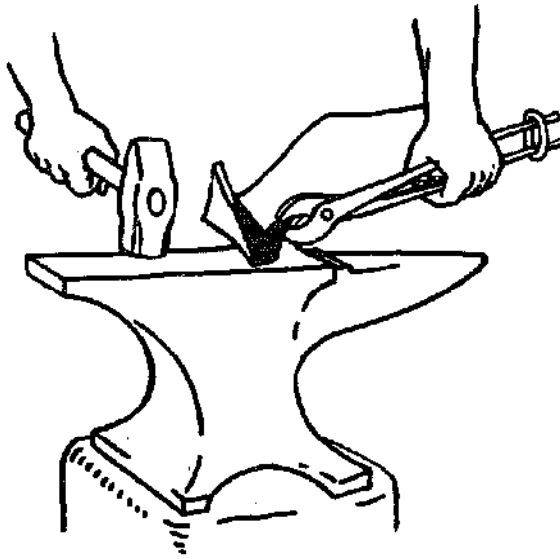

FIG. 40. WELDING A SPLIT POINT TO SHARE AND LANDSIDE

By this method it is easier and more certain to get the parts welded in the right position than by trying to place them together on the anvil after taking from the fire. When the two parts are at welding heat and still in the fire, the point should be placed in the proper position and a few taps given with

a light hammer. This will cause the point to stick fast where it belongs, and the whole may then be taken out on the anvil and the weld finished with a heavier hammer.

If the throat of the old share is worn away, a piece of plow steel shaped as shown at B should be welded on the bottom of the throat. Figure 40 illustrates the position of plowshare and point.

If the old point is worn very short, a piece shaped as shown at C in Figure 39 may be made. It should be long enough to bend over and weld to the top side of the share. The part to be welded to the top of the share should be thinned down to a feather edge before bending. The manner of welding on this type of point is shown in Figure 41.

PLOW WORK

To make a new share for the style of plow using what is known as a slip share, plow steel 9/16 by 3 inches in size should be used. A piece of this steel 9 inches in length will make two landsides if it is cut as shown in Figure 42. The long edge of the short landside should be bent to fit the curve of the share, then it should be fitted to the plow so that the bottom edge will extend below the main landside about 3/16 of an inch, to allow for welding, which will narrow it up somewhat. The bolt hole should then be drilled and the short landside bolted to the plow, and the blank share put in place and marked. It should extend about 1/8 inch beyond the edge of the landside. The short landside and blank share should be clamped together by using a clamp and wedge as shown in Figure 43.

The whole is then to be unbolted from the plow, and a light weld taken at the point to hold it fast. The clamp is then to be moved down to the middle and a weld taken at the upper corner. This plan will avoid the creeping up out of shape which is sure to take place if the welding is followed up from

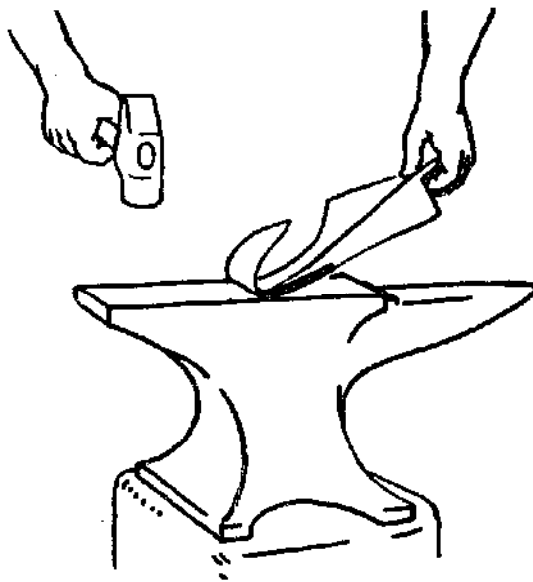

FIG. 41. DOUBLING BACK A LONG POINT

the point as is sometimes done. The whole should then be welded solidly and the point turned down under and welded and trimmed to shape.

BLACKSMITHING

HANDY TOOLS In a shop without power, a very effective tool for shaping plow points after welding may be made from an old horse rasp, fitted with a rather long iron handle. This is to be used while the steel is hot, and is to be followed with the file after the metal cools.

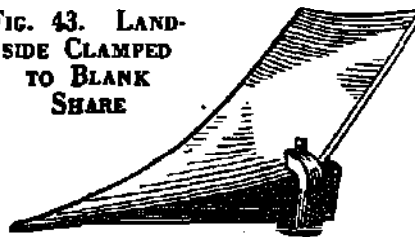

FIG. 42. HOW TWO SHORT LANDSIDES MAY BE CUT FROM A 9-INCH LENGTH OF STEEL

To make a tool which is somewhat handier than ordinary tongs for handling slip shares while sharpening them, the writer once took a piece of $\frac{5}{8}$ -inch round iron $2\frac{1}{2}$ feet long, welded the ends together and shaped it like a long link, with just enough space between the two sides to hold a plow bolt. Another rod of the same length was bent as shown in Figure 44, and the ends welded to the ends of the link. With the share bolted to the link it was easy to handle, and the stiff link had a tendency also to keep the share from warping while it was heated and sharpened.

Trouble is often encountered in removing shares from plows because of rusted bolts which have a provoking way of turning when an attempt is made to screw off the nuts. Many tools

FIG. 43. LANDSIDE CLAMPED TO BLANK SHARE



have been invented to hold such bolts in place. One of the best simple tools of this kind is shown in Figure 45.

PLOW WORK

It consists of two pieces of 7/16-inch round, mild steel united by a hinge joint. One piece has a bit of tool steel welded in its end. The other has an end bent like a hook.

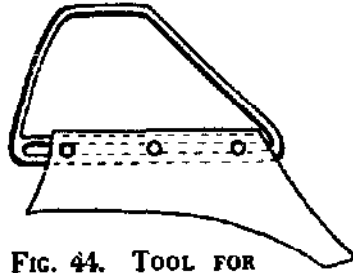

FIG. 44. TOOL FOR HANDLING SLIP SHEARS WHILE SHARPENING

The steel end is sharpened and tempered like a small cold chisel. In use the bent end is hooked over the edge of the moldboard or share, and the chisel end placed against the head of the bolt. This gives a purchase that holds the bolt from turning. The writer once saw such a tool made from the braces of an old buggy top

which was found in a scrap heap. The two braces were joined by their original hinge joint, and all that was

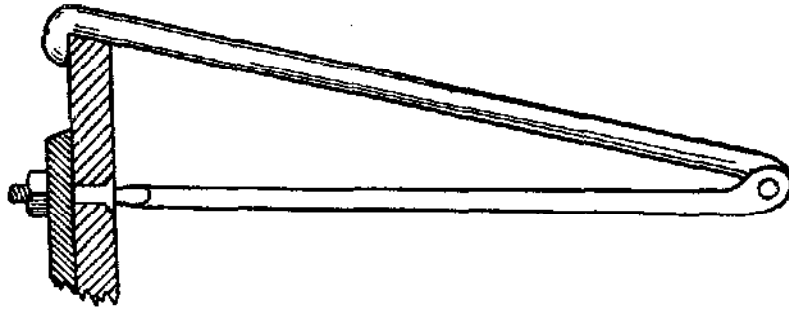

FIG. 45. PLOW BOLT HOLDER

necessary to complete the tool was to finish the two ends as described above.

VIII

WAGON WORK

WAGONS are becoming so scarce in these days of trucks and automobiles, that the old-fashioned wagon-maker has almost passed from the scene. Similarly, there is the danger that the village blacksmith will also disappear for lack of work to do. In this case the farmer who still uses wagons will be obliged to do his own repairing. He should at least know how to do the most important jobs in wagon repairs.

SETTING TIRES The setting of wagon tires is a job which the average farmer would turn over to the village blacksmith, if one could be found, rather than tackle the job himself. However, it is not such a difficult piece of work as might be supposed. Any farmer with natural mechanical ability should be able to master the details of the work without much trouble.

When the tires of a wagon become loose, and are allowed to go for some time without attention, several bad symptoms are almost certain to develop. The spokes will become loose in the felloes, and, if further neglected, will become loose in the hub. The wood of the hub and the spokes may have shrunken so much that the wheel has become "felloe bound"; that is, the felloe has become too long and needs to be shortened as well as the tire. If a wheel is allowed to be used in this condition for any

WAGON WORK

length of time both spokes and felloes will be badly damaged. This is a case which well illustrates the old adage of the stitch in time. Loose wheels may be tightened up by soaking in the river or horse pond; but this is a temporary makeshift, and is only postponing the day of reckoning.

Let us suppose we have a wagon with wheels in the above-mentioned condition. The first thing to do is to mark the wheels and the tires in such a way that after setting the tires we may be sure to get each wheel back in its proper place and wearing its own tire. An old smith whom the writer once worked with always marked the wheels and tires in regular order by beginning with the near, (left), fore wheel, going to the left rear wheel, and so on around the wagon. (He said it meant bad luck to cross over the tongue of the wagon!) To do the marking he used a center punch, and on the inside, (wagon side), of the first wheel he made a single dot on the tire and a corresponding dot on the felloe. The second tire and felloe were marked with two dots, the third with three, and the last with four. He thus did a double job of marking, for his marks enabled him to know on which wheel each tire belonged and also where each wheel belonged on the wagon.

To get the tires off the wheels, the bolts should be removed and the felloes driven from the inside, (wagon side), of the wheel. If light taps with the hammer do not start the tire loose, a block of wood held against the felloe will allow of harder blows without injuring the felloe.

Trouble is often encountered in removing tire bolts. The nuts are found to be rusted fast to the bolts, and the bolts turn around when the attempt is made to unscrew the nuts. This calls for something to hold the bolts in place. One of the best tools for holding bolts is shown in Figure

BLACKSMITHING

46. It is a bar of $\frac{3}{4}$ -inch mild steel with a bend in one end of the proper size to grasp the felloe, and a steel projection shaped like a cold chisel to hold the bolt.

Each wheel should be taken in turn and placed on a table or bench where it may be easily turned about so that

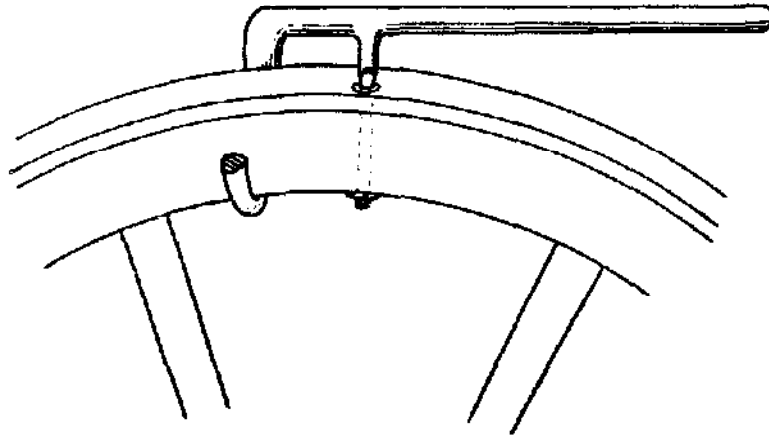

FIG. 46. TOOL FOR HOLDING TIRE BOLTS

all the spokes and the felloes may be examined to find out what they need. If the spokes have been used a long time with a loose tire, and have become badly worn, it may be necessary to replace them with new ones. If the felloes have shrunk so much that some of the tenons of the spokes reach through and rest against the tire, giving us what is called a spoke-bound wheel, the ends of the long spokes should be cut off. If the felloes are too long to fit down to a snug fit on the spokes, a little should be sawed out at the ends of the felloes. In doing this it is necessary to be very careful not to saw out too much. If the wheel is only slightly felloe-bound, the thickness of the handsaw blade will be enough to take out. The spokes should be wedged in the felloe so as to make

WAGON WORK

the whole wheel tight, and a tracing wheel used to get the exact size of the wheel to compare with the size of the tire in order that we may know just how much shrinking will have to be done.

A picture of a tracing wheel is shown in Figure 47. A substitute for a tracing wheel may be made from a sheet of tin or sheet iron cut in the form of a circle, with a small hole drilled in the center and a handle made by sawing a deep kerf in the end of a pine stick about 1 inch square.

In use, the wheel to be measured is placed where it may be easily turned around and a mark is made on the face of the rim. A mark is then made on the tracing wheel, (a slate pencil is a good marker to use) and the mark on the tracing wheel is placed against the mark on the wagon wheel. The tracing wheel is then pressed against the rim of the wagon wheel and the latter is turned around till the mark again comes to the starting place. Another mark is then made on the tracing wheel where it will match with the mark on the rim of the wagon wheel.

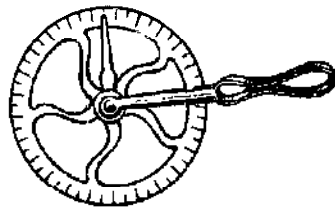

FIG. 47. TRACING WHEEL

The tire is now to be measured with the same tracing wheel. To do this the smith places the tire where it is supported at at least three points, and with himself on the inside of the tire he proceeds to measure by first making a mark with his pencil on the inside of the tire; then placing the first mark of the tracing wheel on the tire mark he runs the tracer around in the same direction that it ran while measuring the wheel. When the complete circle of the tire has been made, a third mark is made on the tracer where it meets the mark on the tire. The space between the second and third marks

BLACKSMITHING

on the tracing wheel will indicate the difference in size between the wheel and the tire.

We have now to shrink the tire to the proper size to fit the wheel. A regular tire shrinker such as is used in wagon shops is a somewhat costly piece of machinery which a

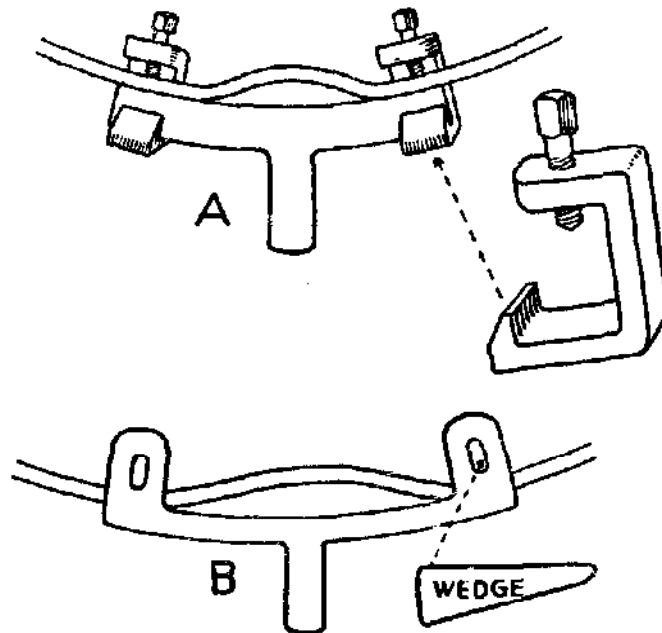

FIG. 48. TWO STYLES OF TIRE SHRINKER

farmer who has but little tire setting to do can hardly afford. A homemade shrinker is something that the farm smith can make for himself. Figure 48, A, shows such a shrinker. It is a bar of iron 1 by 2 inches in size and about 1 foot long. A square piece of iron to fit the hardy hole is welded to the middle of the bottom. Two clamps provided with heavy set screws are fastened to the bottom iron base with plow bolts or rivets. The cut shows the shrinker in use. The tire is heated to a white heat and a

WAGON WORK

bend or hump made in it as shown; then it is clamped so that it is held solidly while the hump in the tire is hammered down to the proper curve of the tire. This process will shrink an ordinary tire something like $\frac{3}{8}$ of an inch at a time. Another homemade tire shrinker is shown at B. It is made in the same way as that shown at A except that wedges are used instead of set screws to hold the tire.

To save time we can avoid using the tracing wheel after the first measurement of the wheel and tire, by employing what is known as the compass or divider method. After tracing the wheel and the tire and determining how much the tire is to be shortened, a dot is made with a center punch on each side of the place which is to be shrunken. The dividers are then set so that they measure the distance between these points. The amount of shrinkage is then carefully marked by another punch mark away from the part to be shrunken. The shrinking is then done and the distance between punch marks measured with the dividers. If the dividers just span the distance between the outside punch marks, the amount of shrinkage is just right. If the marks are still too far apart a little more shrinking will have to be done. If the marks are too near together, the shrunken part can be very easily stretched the proper amount by light hammering on the anvil. Sometimes, in the case of a very loose tire which has to be shortened a good deal, two places instead of one are shrunken. These two places are chosen on opposite sides of the tire. This method is less likely to cause trouble in matching bolt holes in tire and felloe than where all the shrinking is done in one place.

As to the amount that any tire should be shrunken, only this advice can be given: It is safer to shrink too little than too much. Too much shrinking will dish and spoil the

BLACKSMITHING

wheel. For a light buggy wheel, shortening the tire $\frac{1}{8}$ of an inch is enough if the wheel is in fairly good condition. A heavy wagon wheel will stand about $\frac{1}{2}$ inch.

In replacing the tire after shrinking, the wheel should be supported, inside (wagon side) uppermost, on four blocks high enough to lift the hub from the floor. If the tire is not too large and heavy it may be heated in the forge by having a rather long fire and keeping the tire moving around till it is almost red hot. When it is in this condition it ought to drop into position easily and without any trouble. The smith should know where the punch mark is on the felloe, and should put a slender punch in the bolt hole which is next to the punch mark on the tire. Holding the tire by this punch and a pair of tongs he should be able to get the tire in its proper place without any loss of time. He should begin to cool the tire as soon as it is in place by pouring water on it so that the felloe will not be burned. As soon as the tire shrinks enough to be fairly tight, the wheel should be picked up and turned so as to run the tire through the water in the slack tub, which should be level full. Make sure, before the tire is cold, that the felloe and tire are in line all around; correcting it here and there with the hammer if necessary, by holding it level on the anvil.

MAKING NEW TIRES To make a new tire for a wheel is not a hard job for the farm smith if he has mastered the art of welding. The proper way to measure the stock for a new tire is to roll the wheel over the bar from which the tire is to be made, and mark the exact circumference of the wheel. To this add three times the thickness of the tire and cut the bar off at that point. The ends are then to be scarfed the same as for welding flat

WAGON WORK

irons, as has been explained on page 25. The corners of the end which comes on top, when the tire is bent around into shape, should be flared out enough so that they may be bent down a little around the sides of the lower end. This will prevent the ends from sliding sidewise while being heated.

Most of the failures in welding tires are due to faulty placing of the tire on the anvil when the welding is being done. Beginners should be warned against allowing the lower end of the weld to touch the anvil before the smith is ready to strike the first blow. An anvil is a very good conductor of heat, and if the parts to be welded are placed flat upon the face of the anvil when taken from the fire, the chances are that the lower end will have lost heat enough to spoil the weld before the smith is ready to strike. The correct way is to rest that part of the tire which is just beyond the joint against the far edge of the anvil, so that when the tire is rolled toward the anvil the joint will be at the middle of the face. This rolling should be done after the hammer is raised and ready to come down upon the joint the instant that it touches the anvil. It is well to use sand for a flux in making this kind of a weld.

WHIFFLETREE IRONS A good way of ironing whiffletrees is shown in Figure 49. The main advantage claimed for this method over the old-fashioned way



FIG. 49. WHIFFLETREE IRONS

is that the ends do not so easily catch fast to things. For example, in cultivating in the orchard, if the team is driven

BLACKSMITHING

a little too close to a tree, the old-fashioned singletree end with its ferrule is too likely to rip off a piece of bark; whereas the newer kind will simply slip past. The newer style also has the advantage of being easily made and put on by the amateur smith.

The hooks and the irons which hold them to the singletree are made of 7/16-inch round, mild steel, which is flattened somewhat where the rivets hold them to the wood. The manner of making the hooks is shown in Figure 50. A piece of 7/16-inch mild steel is heated and the end bent over upon itself, as shown at A, and welded; then cut off at the dotted line and the end drawn out to a point as shown at B. In bending the hooks, the points are bent back to within a trifle more than 7/16 of an inch from the back of the eye, as drawn at C. This brings the points so close to the irons which hold them to the singletree that it

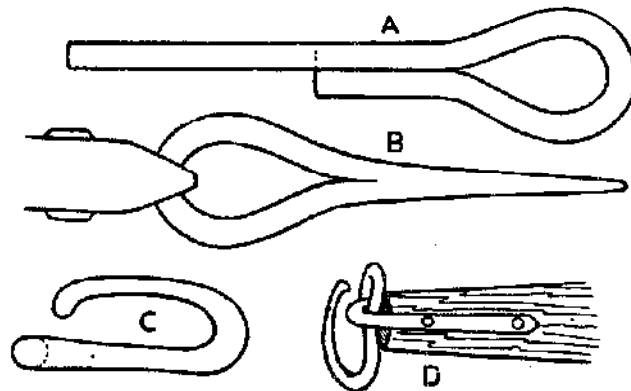

FIG. 50. STEPS IN MAKING WHIFFLETREE HOOK

is impossible for the tugs to become unhooked of themselves. To fasten or to unfasten a tug it is necessary to turn the hook up in the position shown at D.

For heavy work, the kind of singletree shown at A in

WAGON WORK

Figure 51 is recommended. The wooden part is of hickory or white oak, $1\frac{1}{2}$ inches thick and $2\frac{1}{4}$ inches wide at the middle, tapering to $1\frac{1}{2}$ inches at the ends. A band of mild steel $\frac{3}{16}$ inches thick and 1 inch wide is fastened to

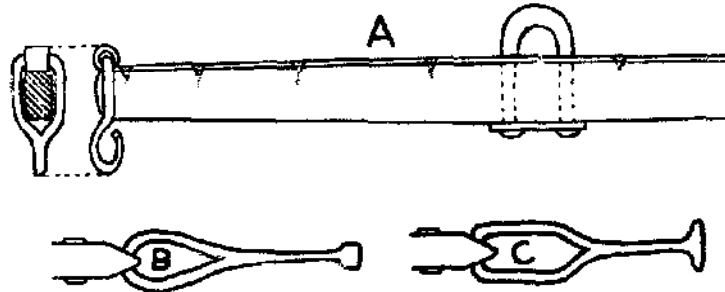

FIG. 51. SINGLETREE IRONED FOR HEAVY WORK

the back of the singletree with short screws. The ends of this band are rolled back to form eyes to hold the hooks. The hooks here shown have bars across their ends to prevent accidental unhooking. To make the cross bar, a lump of steel is left when the hook is drawn out which is flattened first one way in the vise, then the other way on the anvil, as shown at B, then the sides are drawn out round over the edge of the anvil, as shown at C.

IX

HORSESHOEING

IT IS not to be supposed that all farmers, or even all of those who do most of their own blacksmithing and repair work, will care to shoe their own horses. It is true, however, that many farmers with a natural bent for that kind of work have found that they can do a workmanlike job of shoeing their own teams, and get some satisfaction from doing it.

Every horse owner should have a good knowledge of how the shoeing should be done in order to be able to judge a good job when he sees it, and to give sound advice to the man who does the shoeing. There are still some blacksmiths of the old school who might possibly be benefited by a little such advice.

Almost all farm horses, unless they are to be used for road work, would be better off without shoes for the greater part, and possibly all, of the year. Since gasoline motors and trucks now do most of the road work, it is probable that many farm horses will live a life of usefulness without having to submit to the wearing of shoes. This does not mean that the feet of such horses are to be neglected. They should be watched carefully and trimmed whenever there is need for such trimming. This care should begin with the young colt. Colts that get plenty of exercise in rocky pastures will probably wear away their hoofs fast enough to keep them in the shape which nature intended them to have.

HORSESHOEING

But colts reared in stables and on soft ground will be found almost invariably to have overgrown hoofs that will bring about actual deformity of feet and legs if not properly cared for. Such colts should be carefully watched and their hoofs trimmed to the proper size and shape. Most of the trimming may be done with a chisel and mallet by placing the foot on a hardwood plank and having a helper hold up the opposite foot, so as to compel the animal to hold the first foot still. After being trimmed to the proper form with the chisel, the rough edges of the foot should be smoothed off with a rasp.

Time spent in handling young colts and having them get used to having their feet handled will pay good dividends. This kind of training should begin when the colt is but a few days old. Almost all colts will respond to kind treatment, and when very young may be taught many lessons that will be much easier for them to learn than later in life. Colts so trained will give little trouble when it is necessary to trim their feet or to shoe them, or when they are harnessed and put to work.

The writer has known farmers who allowed their colts to grow up to the age when they were wanted for farm work with absolutely no training excepting to wear a halter. These colts, wild as hawks, were taken to the shop, and the blacksmith was expected to shoe them for the same price per shoe that he charged for shoeing Old Dobbin. This is not fair to the smith.

Machine made horseshoes are now so cheap that no farm smith can afford to make his own. They may be had in all sizes and weights, and lately there has come upon the market a shoe that has the toe and heel calks forged in place, so that the smith has only to do a little shaping to fit the shoe to the foot.

BLACKSMITHING

When farm horses must be used for work on hard gravel roads or on icy roads in winter, it becomes necessary for them to wear shoes. For summer wear, when the only purpose of the shoe is to keep the hoof from wearing away too fast, a thin, flat shoe, or even a tip such as is shown in Figure 52, will serve the purpose. For use on icy roads in winter some form of sharp calks will be required. Such calks should be made as short as possible to avoid the straining of tendons which is caused by high calks. To keep the calks sharp, especially when the horses are used on frozen gravel roads, is something of a problem. An improvement on the ordinary calk may be made by splitting the calk and inserting a steel center. This steel center will wear away much more slowly than the iron of the calk, and a constant sharp edge is the result. Pieces of old mower sections are good materials for the centers. The calk, when hot, is split with a thin chisel and the piece of section is inserted and welded. Cooling the calk suddenly in water hardens the center.

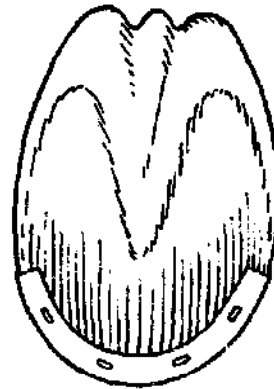

FIG. 52. TIP SUBSTITUTED FOR SHOE

Another way of adding to the length of life of the calks is to give them a coating of cast iron. This is done by heating the calk to a welding heat, and at the same time heating the end of a piece of cast iron to the melting point and smearing the hot calk with the melting cast iron. The cast iron will form a coat over the calk, and on being plunged into water, becomes very hard. Calks treated in this way will outlast ordinary calks many days.

There are now on the market several kinds of patented

HORSESHOEING

calks which may be removed from the shoe without removing the shoe from the foot. These calks serve a good purpose if carefully watched and removed before they become too much worn. If allowed to wear down to the level of the shoe it is impossible to remove them without taking off the shoe.

Whenever it becomes necessary to have horses shod, several points should be borne in mind. In the first place, shoeing is at best a necessary evil. A shoe cannot be nailed to a horse's hoof without doing at least some damage to the hoof. It becomes our business to do as little damage as possible when we fit the shoe and fasten it to the hoof.

Many old-fashioned smiths, and perhaps not all of them are dead yet, had the habit of cutting away the frog of the hoof as the first act in fitting the foot for the shoe. Just why they did this is one of those things that have never been satisfactorily explained. The hoof so treated became dry and contracted, and the horse became more or less lame; but the same old foolish practice went on for years, and, no doubt, still prevails in some places.

The frog is the natural cushion placed by nature where it relieves the foot from jar at every step and gives a springiness of gait which is entirely different from the gait of a horse whose feet have been deprived of this natural buffer.

In fitting the foot to receive the shoe, let us leave the frog in its natural condition. If the outline of the hoof is not what it should be, that is, if it has been allowed to grow out of shape instead of being trimmed as it should have been, this fault may be remedied by the use of hoof nippers. But most of the fitting should be done by rasping the bottom of the foot perfectly level and at the correct angle with the slant of the front of the hoof. See Figure 53.

BLACKSMITHING

If the bottom of the foot is made perfectly level, and the shoe is made perfectly level, there will be no trouble about making a fit without touching the sole with the hot shoe, as is so often done. It should be unnecessary to say that the shoe should be shaped to fit the form of the foot, instead of trimming the foot to conform to the shape of the shoe.

The shoe should be fastened to the hoof with as few and as small nails as will serve to hold it securely in place. The usual practice is to use four nails on each side of the shoe. Horseshoe nails may be had in such a variety of sizes that the proper size and length for any size or weight of shoe may be easily found.

When the bottom of the hoof is rasped level a so-called white line is to be seen following the curve of the hoof just inside the horny wall. When the shoe is properly fitted, the nail holes will all be in such a position that the nails may be driven into this white line. In driving the nails they should be held with the bevel of the point toward the middle of the hoof so that they will tend to go outward through the wall of the hoof. It is a good plan to hold the nail tightly between finger and thumb while the first few blows are given so as to help guide it in the proper direction. It should come to the surface of the hoof between 1 and 1½ inches above the shoe. Driving the nails so that they will come out higher than this endangers the tender part of the hoof; while driving them lower may cause the hoof to break out when the clinching is done. It is a good plan for the novice to practice

FIG. 53. PROPER
ANGLE OF
HORSES HOOF

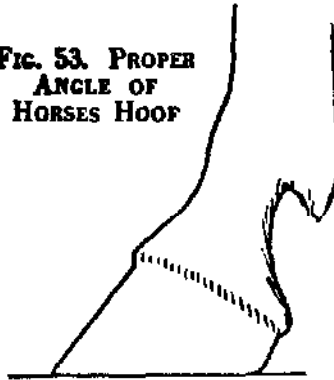

HORSESHOEING

driving nails into a dead hoof held in the vise until he can be reasonably certain of having the points come out where he expects them.

The beginner should be warned against the too common mistake of nailing the shoe on too far back from the toe. The first nails driven have a tendency to draw the shoe back, and unless the smith is careful to watch this point, he is likely to find, after the nails are in, that the toe of the hoof overhangs the shoe a little at the front.

As fast as the nails are driven the points should be bent over toward the shoe so that in case the horse should try to jerk his foot away, the point of the nail could not damage the wrist or hand or trousers of the smith.

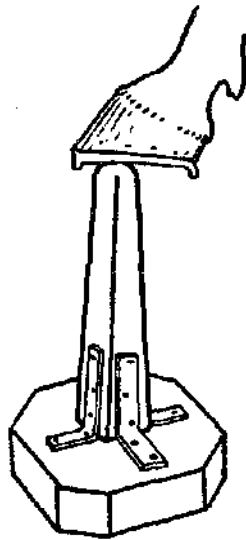

FIG. 54. FOOT REST FOR FINAL OPERATIONS IN HORSE-SHOEING

After all the nails are driven and turned they should be tightened by holding the clinch block, or any square-edged weight, at the bends and tapping on the heads with rather light blows of the shoeing hammer. The nails should then be cut off with the clippers and the stubs slightly thinned by filing. Then the final clinching should be done with clinching iron and hammer, first by tapping the heads of the nails with the hammer while the clinch block is held under the clinches, then reversing the position of these tools, and the horse's foot, and smoothing down the

clinches with the hammer while the clinch block is held under the heads of the nails. For this last operation a foot rest, such as that shown in Figure 54, is a great help. A good workman should be able to do such a good job with

BLACKSMITHING

his shoeing hammer that no roughness of the clinches can be felt with the hand. There will then be no excuse for using the rasp on the outside surface of the hoof. No rasping of the outside of the hoof should ever be necessary excepting possibly to smooth the extreme edge of the hoof where slivers may have been raised when the sole was rasped to make it level. The outside of the hoof is covered with a natural varnish which acts as a protection and a conserver of the moisture of the hoof. It cannot be disturbed without damage to the hoof.

There are two problems that often trouble the horse-shoer. They are found in connection with the proper shoeing of horses that "interfere," and those that "forge," or strike the front shoe with the hind toe.

Some horses will interfere when very tired and at no other time. This is especially true in the case of colts or young horses that are being worked too long at a time, or driven too far. Horses thin in flesh are more likely to interfere than when in good condition. Horses that "toe out" are very apt to interfere. Those that "toe in" seldom or never interfere. This is a point to remember when selecting a horse.

Many cases of simple interfering may be cured by trimming the inside edges of the hoofs to a line which is only a little straighter than the natural curve, and fitting the shoe to this straighter line. It is also a help in most cases to use a shoe with the outside web heavier than the inside, a so-called sideweight shoe.

The writer once knew a blacksmith who thought he had hit upon a brilliant idea in the line of curing a horse of interfering. He claimed that by having the feet trimmed lower on the *outside*, the ankles would be bent outward when the weight was on them so that the opposite foot

HORSESHOEING

would miss instead of striking as it went by. He shod a four-year-old colt after this fashion, not because the colt was interfering, but because he came so near striking at each step that it was thought wise to guard against it. The result was that immediately after being shod the colt began to interfere. The owner brought the colt to the writer, who simply pulled the shoes off and rasped the hoofs to a perfect level and replaced the shoes. The owner afterward said that the colt did not interfere again. If the blacksmith in this case had done exactly the opposite of what he did,—that is, if he had rasped the hoofs so that the outside edges would be a trifle higher than the inside, he would have been nearer right. Why is this so? The following experiment will explain the point. If a horse is allowed to stand at ease on a level floor, and the distance between his fore feet accurately measured, then if the inside walls of his feet are rasped so as to be a little lower, or shorter, than the outside walls, he will be found to stand with his feet a little further apart than the distance first measured. This is because he finds it to be more comfortable to stand on level feet; and to get each foot in a level position after the inside walls are trimmed shorter than the outside, he naturally spreads his feet apart. He will usually be found to travel with his feet further apart also, and thus this method is often found to cure interfering.

The bad habit known as “forging” or “clicking,” which horses often have, is caused by the front foot being a little too slow in getting out of the way of the hind foot when the horse trots. This may be cured in some cases by shoeing in front with what are known as “roller motion shoes,” and the hind feet with shoes with rather long toes.

By “roller motion shoes” is meant shoes with the toe so shaped as to cause the foot to “break over” sooner than

BLACKSMITHING

would be the case with a shoe of ordinary shape. In a shoe without calks, the toe is shaped somewhat like the front of a sled runner. When calks are used the same effect is produced by setting the toe calk back about an inch from the front rim of the toe on the front shoes, and well out to the front on the hind shoes.

X

SOLDERING AND BRAZING

ALTHOUGH soldering and brazing are not, strictly speaking, parts of the blacksmithing trade, they are operations which the farm smith will often be called upon to perform and he should have a knowledge of them in order to make repairs as the need arises. Few tools are required, and the work is easy to do if a few simple rules are followed.

SOLDERING A one-pound soldering copper is about the right size. If much work is to be done it is best to have a pair of coppers, so that one may be heating while its mate is being used. A pair of the size mentioned may be had for 75 cents. Solder, (half tin and half lead is most commonly used), costs about 45 cents a pound. Besides the coppers and the solder there will be needed some resin, some zinc chloride flux, a lump of sal-ammoniac and proper tools for cleaning the parts to be soldered.

The soldering coppers may be heated in the forge, or by a blow torch. A clean fire in the forge is an excellent place for heating. No attempt should ever be made to solder any metal of any kind until the parts to be soldered are cleaned of all rust, paint, grease and foreign matter. Soldering is like welding; and the only way to make a strong job is to have the parts absolutely clean.

The soldering copper should be first heated to a red

BLACKSMITHING

heat, then filed with a rather coarse file on all four of the flat sides. Care should be used to hold the file flat to keep the original bevel. It is then to be heated only just hot enough to melt solder or to cause a little smoke when touched to the sal-ammoniac. The tip of the copper is then to be "tinned" by rubbing it against the sal-ammoniac and solder till about a half-inch of the end is nicely covered with a coat of solder. After this is done the copper should not be heated much beyond this heat or the "tinning" will be burned off.

The chloride of zinc flux is prepared by pouring 3 or 4 ounces of common muriatic acid into an old tumbler or any open glass dish, and putting into it scraps of zinc. This will cause it to boil. Zinc should be added till the boiling stops. Add about $\frac{1}{4}$ in volume of water to the solution in the tumbler, then procure, if possible, a bottle with a glass stopper in which to keep the flux. The tip end of a small feather makes a good swab for applying the flux, but should not be kept in the fluid when not in use. The flux just described is the most satisfactory soldering fluid for most kinds of work, but should not be used where it cannot be thoroughly washed off after the soldering is done, for fear of causing rust. For tin roofing jobs resin makes a safe flux and is generally used.

By watching a tinsmith at work, a person might get the idea that all there is to doing a soldering job is to melt some solder on the place to be mended, and rub it around with the hot soldering copper. The main point, that would be likely to be missed by the observer, is the fact that there can be no real union of the metal to be mended and the solder, unless both are at the same degree of heat. It is necessary to go slowly enough so that the

SOLDERING AND BRAZING

copper will heat the tin or whatever is being worked upon so that it will be as hot as the melted solder.

The beginner is apt to think that a good job of soldering depends upon getting a large quantity of solder to stick to the joint, whereas the right way is to use as little solder as possible. The right way to apply the solder is to touch the bar of solder with the tinned tip of the copper. If the copper is at the right heat a small drop of solder will stick to the tip. This is to be applied to the seam or whatever is to be soldered, and the tip of the copper is to be held against the metal till it is hot enough to make a good union with the solder. If there is any tendency for the metals being soldered to spring apart, it will be necessary to hold them together till the joint has cooled below the melting point of solder.

To sum up, the points to be considered in doing a good job of soldering are:

1. All parts to be soldered must be absolutely clean.
2. Soldering copper must be well tinned and heated to the right heat in a clean fire.
3. A good flux must be used.
4. As little solder as possible should be used.
5. Metals to be soldered must be heated to the melting point of solder, and held together till somewhat cooled.

BRAZING Brazing bears a close relationship to soldering.

the chief difference being that brass is used instead of solder. In certain kinds of jobs, thin iron parts may be more conveniently brazed together than welded. Take for example the case of ferrules for tools. After one becomes accustomed to brazing he can make them easier and faster by this process than by welding.

BLACKSMITHING

For brazing it is necessary to use what is known as soft brass. Cast brass is not suitable for brazing. Old lamp tops, old clock wheels, or any form of sheet brass may be used. Suppose we try to braze a ferrule. The first thing to do is to bevel the ends of the piece of iron on opposite sides, so that when bent into the form of a ring the two beveled parts will fit together. Make sure that these two bevels are clean. If you do not have any pulverized borax, prepare some by heating some lump borax on a fire shovel till it swells up and becomes frothy, then cool it and rub it into the form of powder. Heat the ferrule in a clean fire until it is hot enough to melt borax. Put on a little of the powdered borax, then lay a little strip of the sheet brass on the joint and heat the iron until the brass melts, when it will run into and fill up the joint. Do not heat any more, but take it from the fire and allow to cool.

APPENDIX:
USEFUL TABLES

APPENDIX

TABLE I

DECIMAL EQUIVALENTS
Equalling Parts of an Inch

$\frac{1}{64}$0156	$\frac{23}{64}$5156
$\frac{2}{64}$0313	$\frac{24}{64}$5313
$\frac{3}{64}$0469	$\frac{25}{64}$5469
1-16.....	.0625	9-16.....	.5625
$\frac{5}{64}$0781	$\frac{27}{64}$5781
$\frac{6}{64}$0938	$\frac{28}{64}$5938
$\frac{7}{64}$1094	$\frac{29}{64}$6094
1-8.....	.1250	5-8.....	.6250
$\frac{9}{64}$1406	$\frac{31}{64}$6406
$\frac{10}{64}$1563	$\frac{32}{64}$6563
$\frac{11}{64}$1719	$\frac{33}{64}$6719
3-16.....	.1875	11-16.....	.6875
$\frac{13}{64}$2031	$\frac{35}{64}$7031
$\frac{14}{64}$2188	$\frac{36}{64}$7188
$\frac{15}{64}$2344	$\frac{37}{64}$7344
1-4.....	.2500	3-4.....	.7500
$\frac{17}{64}$2656	$\frac{39}{64}$7656
$\frac{18}{64}$2813	$\frac{40}{64}$7813
$\frac{19}{64}$2969	$\frac{41}{64}$7969
5-16.....	.3125	13-16.....	.8125
$\frac{21}{64}$3281	$\frac{43}{64}$8281
$\frac{22}{64}$3438	$\frac{44}{64}$8438
$\frac{23}{64}$3594	$\frac{45}{64}$8594
3-8.....	.3750	7-8.....	.8750
$\frac{25}{64}$3906	$\frac{47}{64}$8906
$\frac{26}{64}$4063	$\frac{48}{64}$9063
$\frac{27}{64}$4219	$\frac{49}{64}$9219
7-16.....	.4375	15-16.....	.9375
$\frac{29}{64}$4531	$\frac{51}{64}$9531
$\frac{30}{64}$4688	$\frac{52}{64}$9688
$\frac{31}{64}$4844	$\frac{53}{64}$9844
1-2.....	.5000	1.....	1.

APPENDIX

TABLE II

RULES RELATIVE TO THE CIRCLE

<i>To Find Circumference:</i>	
Multiply diameter by	3.1416,
or divide " "	0.3183.
<i>To Find Diameter:</i>	
Multiply circumference by	0.3183,
or divide " "	3.1416.
<i>To Find Radius:</i>	
Multiply circumference by	0.15915,
or divide " "	6.28318.
<i>To Find Side of an Inscribed Square:</i>	
Multiply diameter by	0.7071,
or multiply circumference by	0.2251,
" divide " "	4.4428.
<i>To Find Side of an Equal Square:</i>	
Multiply diameter by	0.8862,
or divide " "	1.284,
" multiply circumference by	0.2821,
" divide " "	3.545.
<i>To Find the Area of a Circle:</i>	
Multiply circumference by one-quarter of the diameter,	
or multiply the square of diameter by	0.7854,
" " " " " circumference by	0.07958,
" " " " " $\frac{1}{2}$ diameter "	3.1416.
<i>To Find the Surface of a Sphere or Globe:</i>	
Multiply the diameter by the circumference,	
or multiply the square of diameter by	3.1416,
" " four times the square of radius by	3.1416.
<i>To Find the Weight of Brass and Copper Sheets, Rods and Bars:</i>	
Ascertain the number of cubic inches in piece and multiply same by weight per cubic inch—	
Copper, 0.3212.	
Brass, 0.2972.	
Or multiply the length by the breadth (in feet) and product by weight in pounds per square foot.	

APPENDIX

TABLE III
CIRCUMFERENCES OF CIRCLES
In Inches

Diameter	Circumference	Diameter	Circumference
$\frac{1}{4}$.7854	18	56.54
$\frac{1}{2}$	1.570	$18\frac{1}{2}$	58.11
$\frac{3}{4}$	2.356	19	59.69
1	3.141	$19\frac{1}{2}$	61.26
$1\frac{1}{2}$	4.712	20	62.83
2	6.283	$20\frac{1}{2}$	64.40
$2\frac{1}{2}$	7.854	21	65.97
3	9.424	$21\frac{1}{2}$	67.54
$3\frac{1}{2}$	10.99	22	69.11
4	12.56	$22\frac{1}{2}$	70.68
$4\frac{1}{2}$	14.13	23	72.25
5	15.70	$23\frac{1}{2}$	73.82
$5\frac{1}{2}$	17.27	24	75.39
6	18.84	$24\frac{1}{2}$	76.96
$6\frac{1}{2}$	20.42	25	78.54
7	21.99	$25\frac{1}{2}$	80.10
$7\frac{1}{2}$	23.56	26	81.68
8	25.13	$26\frac{1}{2}$	83.25
$8\frac{1}{2}$	26.70	27	84.82
9	28.27	$27\frac{1}{2}$	86.39
$9\frac{1}{2}$	29.84	28	87.96
10	31.41	$28\frac{1}{2}$	89.53
$10\frac{1}{2}$	32.98	29	91.10
11	34.55	$29\frac{1}{2}$	92.67
$11\frac{1}{2}$	36.12	30	94.24
12	37.69	$30\frac{1}{2}$	95.81
$12\frac{1}{2}$	39.27	31	97.38
13	40.84	$31\frac{1}{2}$	98.96
$13\frac{1}{2}$	42.41	32	100.5
14	43.98	$32\frac{1}{2}$	102.1
$14\frac{1}{2}$	45.55	33	103.6
15	47.12	$33\frac{1}{2}$	105.2
$15\frac{1}{2}$	48.69	34	106.8
16	50.26	$34\frac{1}{2}$	108.3
$16\frac{1}{2}$	51.83	35	109.9
17	53.40	$35\frac{1}{2}$	111.5
$17\frac{1}{2}$	54.97	36	113.0

APPENDIX

TABLE IV

**WEIGHT OF ROUND AND SQUARE MILD STEEL
Per Lineal Foot**

Size	Pounds per Lineal Foot	
	Round	Square
$\frac{3}{16}$	0.094	0.120
$\frac{1}{4}$	0.167	0.213
$\frac{5}{16}$	0.261	0.332
$\frac{3}{8}$	0.375	0.478
$\frac{7}{16}$	0.511	0.651
$\frac{1}{2}$	0.668	0.850
$\frac{9}{16}$	0.845	1.08
$\frac{5}{8}$	1.040	1.330
$\frac{3}{4}$	1.500	1.910
$\frac{7}{8}$	2.040	2.600
1	2.670	3.400
$1\frac{1}{8}$	3.380	4.300
$1\frac{1}{4}$	4.170	5.310
$1\frac{3}{8}$	5.050	6.39
$1\frac{1}{2}$	6.010	7.650
$1\frac{5}{8}$	7.050	8.93
$1\frac{3}{4}$	8.180	10.410
$1\frac{7}{8}$	9.390	11.88
2	10.680	13.600

APPENDIX

TABLE V WEIGHT OF FLAT MILD STEEL Per Lineal Foot

Width in Inches	$\frac{1}{4}$	$\frac{5}{16}$	$\frac{3}{8}$	$\frac{7}{16}$	$\frac{1}{2}$	$\frac{5}{8}$	$\frac{3}{4}$	$\frac{7}{8}$	1
	Weight								
$\frac{1}{8}$425	.53	.638	.742	.850	1.062	1.275	1.488	1.700
$\frac{5}{16}$531	.66	.797	.924	1.056	1.320	1.593	1.855	2.124
$\frac{3}{4}$638	.797	.956	1.113	1.280	1.600	1.914	2.233	2.560
$\frac{7}{8}$744	.929	1.120	1.302	1.490	1.862	2.232	2.604	2.980
1.....	.850	1.060	1.280	1.490	1.700	2.130	2.550	2.975	3.400
$1\frac{1}{8}$956	1.195	1.430	1.670	1.910	2.380	2.860	3.330	3.820
$1\frac{1}{4}$	1.060	1.330	1.590	1.860	2.130	2.680	3.190	3.570	4.250
$1\frac{3}{8}$	1.170	1.460	1.750	2.040	2.340	2.925	3.510	3.940	4.680
$1\frac{1}{2}$	1.280	1.590	1.910	2.230	2.550	3.190	3.830	4.480	5.100
$1\frac{3}{4}$	1.490	1.860	2.230	2.600	2.980	3.720	4.460	5.215	5.950
2.....	1.700	2.130	2.550	2.980	3.400	4.250	5.100	5.950	6.800

TABLE VI SIZES OF WIRE In Fractions of an Inch

No.	Inch	No.	Inch
000	is equal to $\frac{3}{16}$	6	is equal to $\frac{7}{16}$
00	is equal to $\frac{1}{4}$	8	is equal to $\frac{1}{2}$
0	is equal to $\frac{5}{16}$	11	is equal to $\frac{1}{2}$
1	is equal to $\frac{3}{8}$	12	is equal to $\frac{1}{2}$
3	is equal to $\frac{1}{2}$	14	is equal to $\frac{5}{8}$
$4\frac{1}{2}$	is equal to $\frac{3}{4}$	16	is equal to $\frac{1}{2}$

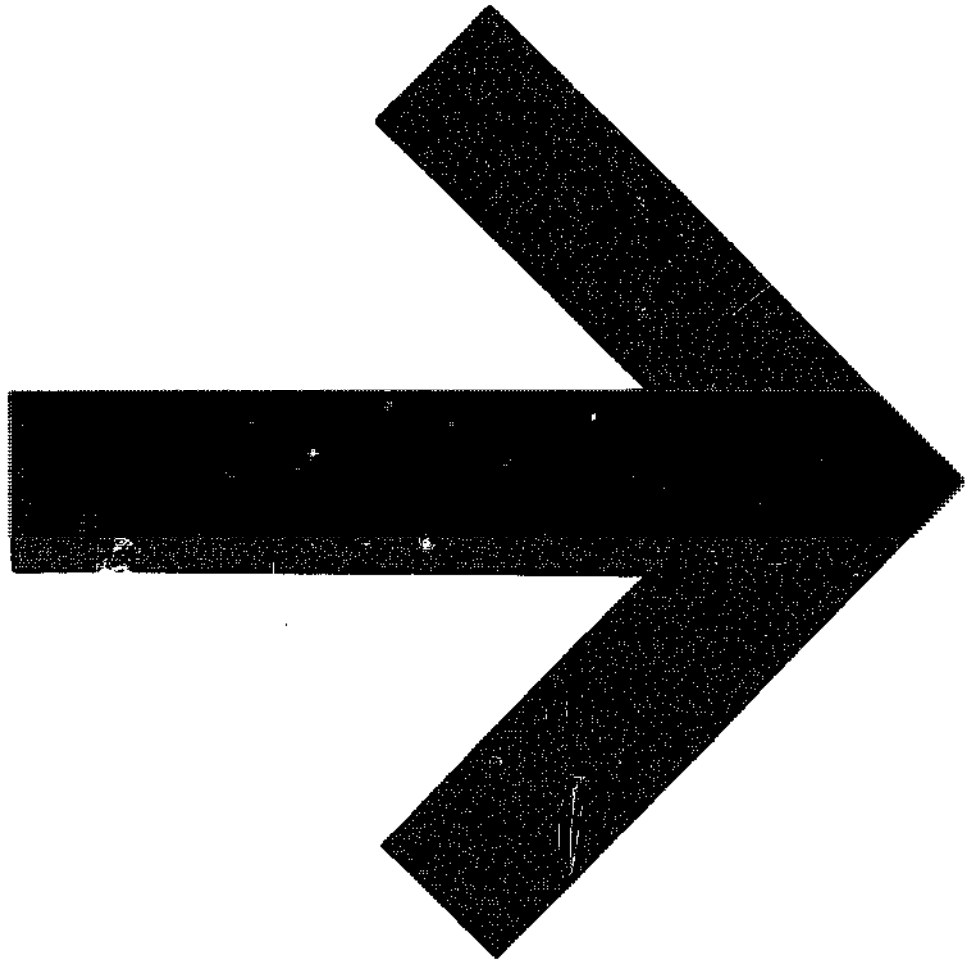

INDEX

A

Annealing mild steel, 45
Anvil, 10-11, 47

B

Bending iron, 24
Bessemer process, 3
Blacksmith's tongs, 14, 63-66
Blister steel, 3
Blower, 8
Bolts and nuts, 44-46
Bolt tongs, 65-66
Brazing, 97-98
Brick forge, 7

C

Calks for horseshoes, 88-89, 94
Cast iron, 2
Chain hook, 36-38
Chain links, 33-35
Charcoal, 19
Chisels, 14, 15, 56-59
Churning drill, 51
Circle, rules relative to, 102
Circumferences of circles, 103
Clevis, 41-43
Clevis bolt, 43
Clicking of horses' hoofs, treatment for, 93-94

C—Cont'd

Clinching horseshoe nails, 91-92
Coal, smithing, 19
Cold chisel, making, 56-59
Cold shut links, 35-36
Cost of equipment, 16
Crow bar, 51
Crucible steel, 4

D

Decimal equivalents, table of, 10
Drawing iron and steel 22-23
Drills, making, 59-61

E

Equipment, 7-18
Equipment, cost of, 16

F

Files, care of, 67-63
Fire poker, 14, 29-30
Flat drill, 59
Flat mild steel, table of weights, 105
Flatter, 14, 15
Flogging tools, 14-15
Flux for soldering, 96
Flux for welding, 25, 72
Forge, 7-10
Forge fire, 19-21, 51
Forging steel, 55-56

INDEX

F—Cont'd

"Forging" of horses' hoofs, treatment. 92-94
Frog of horses' hoofs not to be cut, 89
Fullers. 14, 15

H

Hammer, tempering. 62-63
Hardy, 16
Heading tool for bolts, 43-44
Hook and staple, 31-33
Horn, extra, for anvil, 17, 18
Horseshoe, tip substituted for, 88
Horseshoe nails, clinching, 91-92
Horseshoeing. 86-94
Horseshoers' tongs, 66
Horseshoes, machine made, 87
Horseshoes, nailing, 90-92
Horseshoes, roller motion to prevent clicking, 93-94
Horseshoes, sideweight to prevent interfering, 92
Horse's hoof, footrest for, 91
Horse's hoof, proper angle, 90
Horse's hoof, trimming, 86-87, 89-90

I

"Interfering" of horse's hoofs, treatment for, 92-93
Iron, 1

K

Knife blades, forging and tempering, 61-62

M

Mandrel, 17, 18
Mild steel, 2
Mild steel, annealing, 45
Mild steel, shearing, 71
Mild steel, weights per lineal foot, flat, 105
Mild steel, weights per lineal foot, round and square, 104

N

Nailing horseshoes, 90-92
Norway iron, 2
Nuts and bolts, 44-46

P

Pig iron, 2
Plow bolt holder, 74-75
Plow point shaping tool, 74
Plow points, 70-73
Plowshares, sharpening, 69-70
Post drill, 16, 17
Punching iron, 26-27

R

Rack for iron and steel, 13
Refining steel, 56-57
Ring, making, 40-41
Riveting, 27-28
Roller motion shoes to prevent interfering, 93-94
Round mild steel, table of weights, 104

INDEX

S

Scarfig, 24-25, 41
Screw driver of mild steel and tool steel, 52-53
Set hammer, 14, 15
Setting tires, 76-82
Shear steel, 4
Shop equipment and tools, 7-18
Shop, plan of, 5-7
Shrinking tires, 80-82
Singletrees, 84-85
Slack tub, 13
Slip share holder, 74, 75
Slip shares, 73
Smelting, 1
Smithing coal, 19
Soldering, 95-97
Square mild steel, table of weights, 104
Staple, making, 32-33
Staple puller, 30-31
Steel, 2, 54-55
Steel drills, 59-60
Steel, heating for forging, 55
Stone drills, 60-61
Swages, 14, 15
Swedish iron, 2
Swivel, making, 38-40

T

Tempering knife blades, 62
Tempering steel, 57-58, 61
Tempering steel hammer, 62-63
Tinning soldering copper, 96
Tip substituted for horseshoe, 88
Tire bolts, tool for holding, 77-78
Tire shrinkers, 80-81
Tires, making new, 82-83
Tires, setting, 76-82

T—Cont'd

Tongs, making, 63-66
Tool steel, 3, 54
Tool table, 12
Tools needed, 14-18
Tracing wheel for measuring tires, 79
Trimming horses' hoofs, 86-87, 89-90
Tuyere iron, 8
Twisted drill, 60

U

Upsetting iron and steel, 23

V

Visc. 12

W

Wagon tires, making, 82-83
Wagon tires, setting, 76-82
Water tank, 12
Weights of flat mild steel, 105
Weights of round and square mild steel, 104
Welding, 25-26
Welding head on bolt, 44-45
Welding iron and steel, 50-53
Welding iron at right angles, 49-50
Welding separate irons, 47-49
Welding a "T," 50
Welding tires, 83
Whiffletree irons, 83-85
Wire, table of sizes, 105
Work bench, 12



SHOREY

Publications Catalog

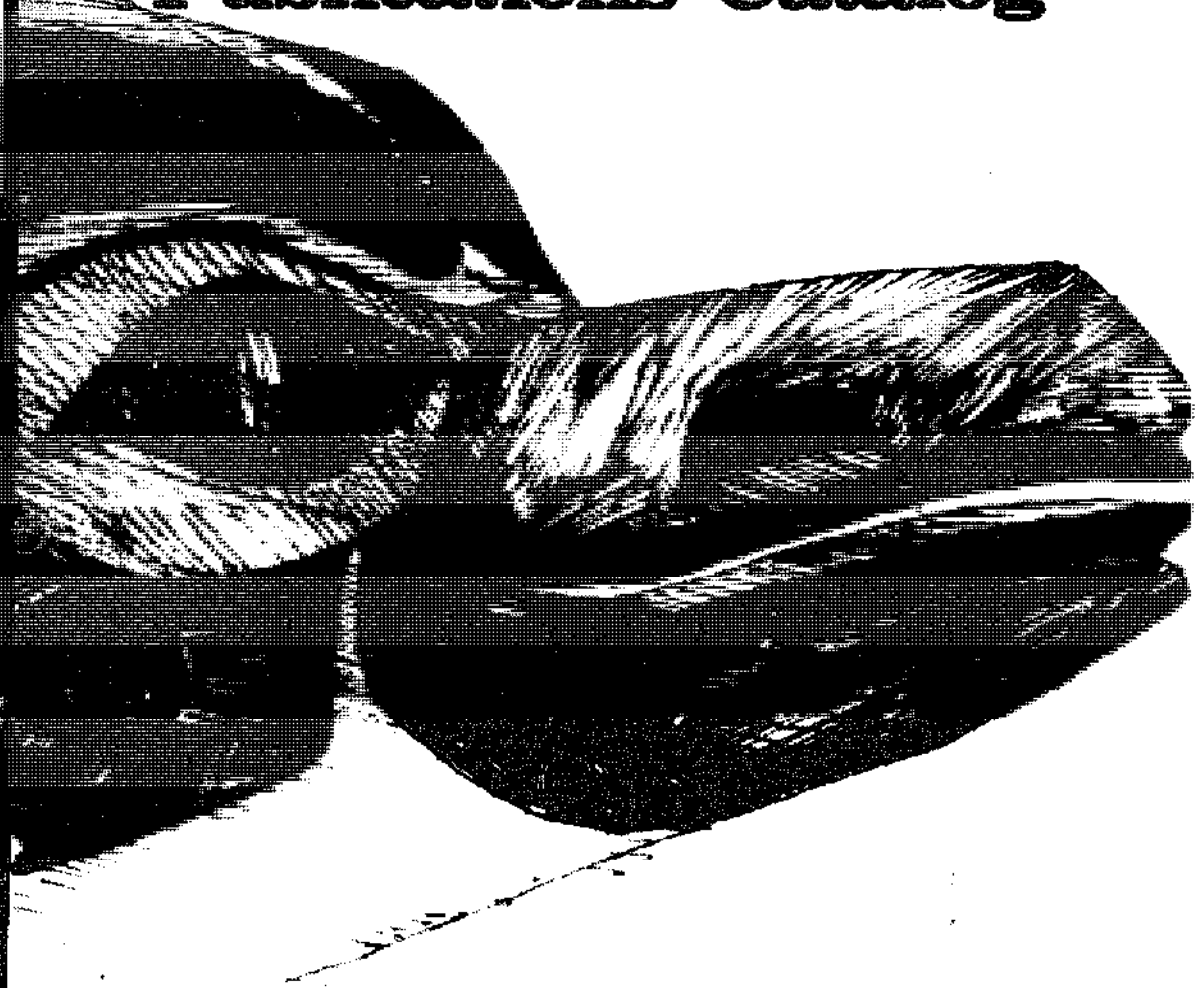

SHOREY PUBLICATIONS IN PRINT

1. Glover, S.L. ORIGIN & OCCURENCE OF GEM STONES IN WASHINGTON. 1949	1.00
2. Mooney, Jas. GHOST DANCE RELIGION: SMOHALLA & HIS DOCTRINE. 1896	1.50
3. Mooney. GHOST DANCE RELIGION: SHAKERS OF PUGET SOUND. 1896	1.50
4. Farrand, Liv. TRADITIONS OF THE QUINAULT INDIANS. 1902	4.00
5. DICTIONARY OF THE CHINOOK JARGON. nd	2.00
6. ALASKA RAILROAD TIME TABLES. 1922	.50
7. Wells, E.H. UP AND DOWN THE YUKON. 1900	1.50
8. Williams, J.G. REPORT OF THE ATTORNEY GENERAL, Territory of Alaska, 1949-51	1.50
9. Gruening, Ernest. MESSAGE OF THE GOVERNOR OF ALASKA, 1946	2.00
10. Gruening. THIRD MESSAGE TO THE PEOPLE OF ALASKA, 1946	1.50
11. Kohlstedt, E.D. A GLIMPSE OF ALASKA. 1930	1.00
12. Gruening. MESSAGE OF THE GOVERNOR OF ALASKA, 1945	2.50
13. Leehey, M.D. PUBLIC LAND POLICY OF THE U.S. IN ALASKA. 1912	1.50
14. NOME TELEPHONE DIRECTORY. 1905	3.00
15. ESTABLISHMENT OF MT. MCKINLEY NATIONAL PARK. 1914	1.50
16. Hooper, Capt. C.L. CRUISE OF THE U.S. REVENUE STEAMER CORWIN IN ARCTIC OCEAN, November 1, 1880	7.50
17. Gruening. MESSAGE TO THE PEOPLE OF ALASKA. 1945	2.00
18. Gruening. MESSAGES OF THE GOVERNOR OF ALASKA. 1949	2.50
19. Davis, Geo. T. METLAKAHTLA. 1904	3.50
20. WORK OF THE BUREAU OF EDUCATION FOR NATIVES OF ALASKA. 1913	5.00
21. MacDowell, L.W. ALASKA INDIAN FASKETRY.	1.00
22. Eells, Rev. Myron. THE TWANA, CHEMAKUM & KLALLAM INDIANS OF WASHINGTON TERRITORY. 1887	4.00
23. Grinnell, Joseph. GOLD HUNTING IN ALASKA.	4.00
24. Swan, James G. INDIANS OF CAPE FLATTERY.	7.50
25. CUSTER'S LAST BATTLE. 1892	2.00
26. Gruening, Sen. INDEPENDENCE DAY ADDRESS. 1959	1.75
27. Cadell, H. M. THE KLONDIKE & YUKON GOLDFIELD IN 1913. 1914	2.50
28. Shiels, Archie W. EARLY VOYAGES OF THE PACIFIC. 1930	3.00
29. Fickett, E.D. METEOROLOGY. From EXPLORATIONS IN ALASKA. 1900	1.50
30. Richardson, W.P. & others. YUKON RIVER EXPLORING EXPEDITION. From EXPLORATIONS IN ALASKA. 1900	2.00
31. Ray, P.H., W.P. Richardson. RELIEF OF THE DESTITUTE IN THE GOLDFIELDS. 1900	1.75
32. Shiels, Archie W. LITTLE JOURNEYS INTO THE HISTORY OF RUSSIAN AMERICA AND THE PURCHASE OF ALASKA. 1949	7.50
33. Shiels. STORY OF TWO DREAMS. 1957	4.00
34. Swan, J.G. HAIDAH INDIANS OF QUEEN CHARLOTTE'S ISLAND, B.C. 1874	5.00
35. Butler, Gen. B.V. & the Marquis of Lorne. THE BEHRING SEA CONTROVERSY. 1892	1.50
36. Crawford, Lewis F. THE MEDORA-DEADWOOD STAGE LINE. 1925	1.50
37. Anderson, Eskil. ASBESTOS & JADE OCCURENCES IN KOBUK RIVER RECTON, ALASKA. 1945	2.00
38. Stewart, B.D. PROSPECTING IN ALASKA. 1949	1.50
39. Geoghegan, Richard H. THE ALEUT LANGUAGE.	5.00
40. SEATTLE'S FIRST BUSINESS DIRECTORY. 1876	7.50
41. THE WASHBURN YELLOWSTONE EXPEDITION. 1871	1.25
42. Subreports from EXPLORATIONS IN ALASKA. 7 reports: The Tanana, Chickaloon Sushitna, etc. 1900	2.00
43. Glenn, Capt. E.F. TANANA RIVER EXPLORING EXPEDITION. 1900	2.50
44. Glenn. COOK'S INLET EXPLORING EXPEDITION. 1900	1.75
45. WILKESON'S NOTES ON PUGET SOUND (1870)?	2.50
46. (Perry) JOURNAL OF A VOYAGE TO THE ARCTIC REGIONS IN H.M.S. ALEXANDER 1818 (1819)?	6.00
47. BIENNIAL MESSAGE OF WM. M. BUNN, Governor of Idaho. 1884	2.00
48. MACKENZIE'S ROCK. Exploration of Sir Alexander Mackenzie. 1905	2.50
49. Williams, L.R. OUR PACIFIC COUNTY. (Wash)	5.00
50. AARON LADNER LINDSLEY. Founder of Alaska Missions.	1.00
51. Evans, Elwood. PUGET SOUND: Its Past, Present and Future. 1869	2.50
52. Campbell, Robt. TWO JOURNALS, 1808-1853	15.00
53. Bernhardt, Madame Charlotte. MEMOIR OF THE CELEBRATED ADM. JOHN DE KRUSENSTERN. 1856	5.00
54. McWhorter, Lucullus V. CRIME AGAINST THE YAKIMAS. 1931	4.50
55. Lupton, Chas. T. OIL AND GAS IN THE OLYMPIC PENINSULA. 1913	4.00
56. Seward, Wm. H. THE ADMISSION OF KANSAS. A Speech. 1860	1.50
57. Stevens, Isaac I. PROCLAMATION OF MARTIAL LAW. 1856	.50
58. THE GLACIER - Tlinkit Training Academy, Vol II. 1887	.75
59. Hills, Rev. E.P. REV AARON L. LINDSLEY.	.50
60. SWANTON'S HANDBOOK OF NORTH AMERICAN INDIANS, Pt. C: Indians of Alaska & Canada. 1952	5.00
61. Ward, D.B. ACROSS THE PLAINS IN 1853. 1911	3.50

62.	MacDowell, Lloyd W. ALASKA TOTSM POLES.	1.25
63.	MacDowell. A TRIP TO WONDERFUL ALASKA.	2.00
64.	MacDowell. ALASKA GLACIERS & ICE FIELDS.	1.25
65.	Shaw, Geo. C. THE CHINOOK JARGON & HOW TO USE IT. 1909	4.00
66.	PUGET SOUND COOPERATIVE COLONY. 1890s	2.00
67.	THE HEROES OF BATTLE ROCK, or The Miners' Reward. 1904	1.50
68.	Lampman, Ben Hur. CENTRALIA TRAGEDY AND TRIAL. 1920	4.00
69.	SEAL FISHERY IN THE NORTH PACIFIC. (Correspondence with Russia) 1895	7.50
70.	Coolican, J.D. (ed) PORT ANGELES. 1898	4.00
71.	Jordan, D.S. TROUT & SALMON OF THE PACIFIC COAST. 1906	1.25
72.	COOPERATIVE PLAN FOR SECURING HOMES AT PORT ANGELES, Wash. 1893	1.00
73.	Hidden, Maria L.T. OREGON PIONEERY. 1910	1.00
74.	Stevens, Hazard. FIRST ASCENT OF TAKHOMA. Ext., 1876	1.50
75.	DEMOCRATIC & REPUBLICAN Ticket for Washington State & King County. 1889	.50
76.	THIRD ANNUAL COMMENCEMENT OF SEATTLE HIGH SCHOOL. 1888	.35
77.	ASSASSINATION OF PRESIDENT GARFIELD. Newspaper Extra. 1881?	.50
78.	PUGET SOUND CATECHISM. 1889	1.00
79.	SEATTLE, KING COUNTY, WASHINGTON TERRITORY. 1884	1.50
80.	THE GREAT SEATTLE FIRE of June 7, 1889.	2.50
81.	USGS Bull. 442-D. MINING IN THE CHITINA DIST., etc. 1910	2.50
82.	Swanton, John R. INDIAN TRIBES OF THE PACIFIC NORTHWEST. Ext., 1952	6.00
83.	Sayre, Alex N. PUGET SOUND: Poem. 1883	1.50
84.	Bell, W.S. OLD FORT BENTON. 1909	2.50
85.	Meany, Edmund S. INDIAN GEOGRAPHIC NAMES OF WASHINGTON. 1908	1.00
86.	Swanton, J. R. INDIAN TRIBES OF AMERICAN SOUTHWEST. 1952	6.00
87.	Swanton. INDIANS OF MEXICO, CENTRAL AMERICA & WEST INDIES. 1952	2.50
88.	USGS Bull. 836. SELECTED LIST OF USGS PUBS. ON ALASKA. 1930	1.00
89.	Lewis, Wm S. EARLY DAYS IN THE BIG BEND COUNTRY. 1926	3.50
90.	Stoney, Geo. M. EXPLORATIONS IN ALASKA. 1899, Ext. from US Naval In.	6.00
91.	Lindsley, A.L. SKETCHES OF AN EXCURSION TO SOUTHERN ALASKA. 1881	5.00
92.	Collins, H.B. ARCHEOLOGY OF THE BEPRING SEA REGION. Ext. 1933	1.50
93.	Ray & Murdoch. A VOCABULARY OF THE ESKIMOS OF POINT BARROW. 1885	1.25
94.	Andrews, C.L. STORY OF SITKA. 1922	5.00
95.	Matthews, Washington. NAVAJO WEAVERS. 1884	2.50
96.	Dawson, Geo. M. THE HAYDAS. 1882	1.00
97.	McClintock, Walter. FOUR DAYS IN A MEDICINE LODGE. 1900	1.00
98.	Barbeau, M. MODERN GROWTH OF THE TOTEM POLE ON THE NW COAST. 1939	1.00
99.	SCRIPTURE SELECTIONS & HYMNS IN HIDATSA or GROS VENTURE LANGUAGE. 1906	1.50
100.	Baker, Marcus. GEOGRAPHIC DICTIONARY OF ALASKA. 1906	3.00
101.	Lee, Charles A. ALEUTIAN INDIAN & ENGLISH DICTIONARY. 1896	1.00
102.	Shaw, Geo. C. VANCOUVER'S DISCOVERY OF PUGET SOUND IN 1792. 1933	1.00
103.	Seward, Wm H. SPEECHES in Alaska, Vancouver & Oregon, 1869.	2.50
104.	Rees, J.E. IDAHO: Chronology, Nomenclature, Biblio. 1918	5.00
105.	Smith, W.C. THE EVERETT MASSACRE. 1916	8.00
106.	PLACER MINING. 1897	4.50
107.	Ross, Clyde P. THE VALDEZ CREEK MINING DISTRICT IN ALASKA. 1933	5.00
108.	Stevens, Isaac. TREATY BETWEEN THE U.S. & THE DWAMISH, SUQUAMISH & ALLIED & SUBORDINATE TRIBES OF INDIANS IN WASHINGTON TERRITORY. 1855	2.00
109.	Stevens. TREATY BETWEEN THE US & NISQUALLY & OTHER BANDS OF INDIANS. 1855	2.00
110.	Stevens. TREATY BETWEEN THE US & YAKIMA NATION OF INDIANS. 1855	2.00
111.	Stevens. TREATY BETWEEN THE US & THE MAKAH TRIBE OF INDIANS. 1855	2.00
112.	Stevens. TREATY BETWEEN THE US & INDIANS OF WILLAMETTE VALLEY. 1855	2.00
113.	Densmore, F. STUDY OF INDIAN MUSIC. 1941	1.50
114.	Harriman, Job. THE CLASS WAR IN IDAHO.	3.00
115.	Ranck, G. PICTURES FROM NORTHWEST HISTORY.	2.00
116.	Whitaker, R. OVERLAND TO OREGON. 1906	4.00
117.	Krieger, H. INDIAN VILLAGES OF SOUTHEAST ALASKA.	2.50
118.	Gatschet, A. THE KLAMATH INDIANS OF SOUTHWEST OREGON. 1890	4.50
119.	Crane, W. TOTEM TALES. 1952	4.00
120.	Bate, J. THE SECOND BOOKE TEACHING MOST PLAINLY & COMPOSING OF ALL MANNER OF FIREWORKS FOR TRYUMPH & RECREATION. 1635	3.00
121.	James, G. PRACTICAL BASKET MAKING. 1917	5.00
122.	Nhorf, B. MAYA HIEROGLYPHS. 1941	1.25
123.	Dall, Wm. MASKS, LABRETS, & CERTAIN ABORIGINAL CUSTOMS. 1884	8.50
124.	McCurdy, J. CAPE FLATTERY & ITS LIGHT.	1.00
125.	Wilhelm, Homer. THE SAN JUAN ISLANDS. 1901	5.00
126.	Gaerity, Jack. BREAD & ROSES FROM STONE.	4.00
127.	Smith, W.C. WAS IT MURDER? (Centralia) 1922	3.50
128.	HISTORY OF ONYHEE COUNTY. (Idaho)	8.50
129.	Evans, Elwood. WASHINGTON TERRITORY. 1877	3.00
130.	Delaney, Matilda Sagar. THE WHITMAN MASSACRE. 1920	3.00
131.	Hubback, T.W. TEN THOUSAND MILES TO ALASKA FOR MOOSE & SHEEP. 1921	4.00
132.	Wilson, Katherine. COPPER TINTS. 1923	3.00
133.	Coleman, Edmund T. FIRST ASCENT OF MT. BAKER. Ext. from Harper's Monthly. 1869	2.50
134.	Hodge, L.K. (ed) MINING IN THE PACIFIC NORTHWEST. 1897	30.00

134a.	Hodge. MINING IN WESTERN WASHINGTON. Ext. from #134	10.00
134b.	Hodge. MINING IN CENTRAL & EASTERN WASHINGTON. Ext. from #134	10.00
134c.	Hodge. MINING IN SOUTHERN BRITISH COLUMBIA. Ext. from #134	10.00
135.	Stallard, Bruce. ARCHEOLOGY IN WASHINGTON. 1958	5.00
136.	Lockley, Fred. ALASKA'S FIRST FREE MAIL DELIVERY IN 1900	1.25
137.	Strange. James Strange's JOURNAL & NARRATIVE OF THE COMMERCIAL EXPEDITION FROM BOMBAY TO THE NORTHWEST COAST OF AMERICA. 1928	5.00
138.	Hathaway, Ella C. BATTLE OF BIG HOLE.	2.00
139.	Haller, Granville. SAN JUAN & SECESSION	1.50
140.	THE KLONDIKE NEWS. Vol 1 #1, Dawson Newspaper. 1898 (Alaska's Rarest Newspaper)	10.00
141.	JOURNAL OF MEDOREM CRAWFORD. 1897	2.00
142.	OCOSTA! The Ocean Terminus of the Northern Pacific RR and the Coast City of Washington.	2.50
143.	Sutherland, T.A. HOWARD'S CAMPAIGN AGAINST THE NEZ PERCE INDIANS, 1877. 1878	3.50
144.	Matthews, Matthew. THE CATLIN COLLECTION OF INDIAN PAINTINGS. 1890	3.00
145.	Lockley, Fred. TO OREGON BY OX TEAM IN '47.	1.25
146.	Lockley, F. VIGILANTE DAYS IN VIRGINIA CITY.	1.50
147.	Judson, Katherine. MYTHS & LEGENDS OF THE PACIFIC NORTHWEST. 1910	7.50
148.	Whiting, Dr. F.B. GRIT, GRIEF & GOLD.	10.00
149.	Amundsen, Capt. R. TO THE NORTH MAGNETIC POLE & THRU THE NW PASSAGE.	3.00
150.	Butte Businessmen's Assn. BUTTE, MONTANA.	2.00
151.	Immigration Aid Society of Washington Terr. NORTHWESTERN WASH. 1880	3.50
152.	Denig, Edwin T. INDIAN TRIBES OF THE UPPER MISSOURI. 1930	10.00
153.	Buckley, Rev. J.M. TWO WEEKS IN THE YOSEMITE & VICINITY. 1888	2.50
154.	SPEECH OF THE HON. R.C. WINTHROP OF MASS. ON THE PRESIDENT'S MESSAGE (on admission of California) 1850	2.00
155.	Marshall, M. A PRONOUNCING DICTIONARY OF CALIFORNIA NAMES IN ENGLISH & SPANISH	2.50
156.	Mercer, A.S. BIG HORN COUNTY, WYOMING.	7.50
157.	Moorehead, Warren K. PREHISTORIC RELICS.	7.50
158.	Merrill, Geo. P. NOTES ON THE GEOLOGY & NATURAL HISTORY OF THE PENINSULA OF LOWER CALIFORNIA. 1895	2.00
159.	Georgeson, C.C. REINDEER & CARIBOU. 1904	1.50
160.	Hewett, Edgar L. GENERAL VIEW OF THE ARCHEOLOGY OF THE PUEBLO REGION. 1904	2.00
161.	Bennett, Wm P. THE FIRST BABY IN CAMP.	3.50
162.	Coffman, Noah B. OLD LEWIS COUNTY, Oregon Territory. 1926	3.50
163.	Bebbe, Mrs. Iola. THE TRUE STORY OF SWIFTWATER BILL GATES. 1908	7.50
164.	Costello. THE SIMWASH - THEIR LIFE, LEGENDS & TALES. 1895	10.00
165.	Murie, Olaus J. ALASKA -YUKON CARIBOU.	10.00
166.	Meeker, Ezra. STORY OF THE LOST TRAIL TO OREGON, No 2. 1916	2.50
167.	Hanna, Rev. J.A. DR. WHITMAN & HIS RIDE TO SAVE OREGON. 1903	1.25
168.	Hadwen, S. & Palmer, Laurence. REINDEER IN ALASKA. 1922	5.00
169.	Geer, T.T. THE ROMANCE OF ASTORIA. 1911	1.75
170.	Williams, Lewis. CHINOOK BY THE SEA.	7.50
171.	SAN FERNANDO VALLEY. 1938	2.00
172.	PASADENA. 1938	2.00
173.	Ingalls, Maj. J.W. HISTORY OF WASHOE COUNTY, NEVADA. 1913	5.00
174.	Reid, J.T. & J.R. Hunter. HUMBOLDT COUNTY. 1913	4.50
175.	Aston. ESMERALDA COUNTY. 1913	4.50
176.	London, Jack. THE GOLD HUNTERS OF THE NORTH. Ext., 1903	1.25
177.	Wartman-Arland, Flora E. THE STORY OF MONTESANO. 1933	4.00
178.	London, J. THE ECONOMICS OF THE KLONDIKE.	1.50
179.	Bishop, Robert Sr. LAND IN THE SKY TOTEM.	1.50
180.	Webb, John & Ed Curtis. THE RIVER TRIP TO THE KLONDIKE & THE RUSH TO THE KLONDIKE OVER THE MOUNTAIN PASS. 1898	2.50
181.	Librn. of Bellingham Public Libr. HISTORY OF BELLINGHAM. 1926	6.00
182.	VOYAGE OF THE ALEXANDER MACKENZIE.	2.50
183.	Chaplin, Ralph. CENTRALIA CONSPIRACY.	4.50
184.	Haswell, Robt. ROBERT HASWELL'S JOURNALS. 1788-89	4.50
185.	Minto, John. RHYME OF EARLY LIFE IN OREGON. (1915)?	4.00
186.	Collins, Henry B., A.H. Clarke & E.H. Walker. THE ALEUTIAN ISLANDS: Their People & Natural History. 1945	7.50
187.	Simpson, Brevet Brig. Gen. J.H. CORONADO'S MARCH IN SEARCH OF THE "SEVEN CITIES OF CIBOLA". 1871	2.50
188.	Riddle, Geo. W. EARLY DAYS IN OREGON.	5.00
189.	VILHJALMUR STEFANSON. 1925	2.50
190.	Lockley, F. ACROSS THE PLAINS BY PRAIRIE SCHOONER.	1.50
191.	MacArthur, Walter. LAST DAYS OF SAIL ON THE WEST COAST. 1929	7.50
192.	Stuck, Hudson. THE ALASKAN MISSIONS OF THE EPISCOPAL CHURCH. 1920	10.00
193.	Steffa, Don. TALES OF NOTED FRONTIER CHARACTERS, SOAPY SMITH. 1908	1.75
194.	Meeker, E. WASHINGTON TERRITORY. 1870	3.00
195.	Denny, Arthur A. PIONEER DAYS ON THE PUGET SOUND. 1888	5.00

196.	Rowan, James. THE I.N.W. IN THE LUMBER INDUSTRY.	4.00
199.	Dayre, J. Willis. THE EARLY WATERFRONT OF SEATTLE, 1957	2.50
200.	Thwaites, Reben G. NEWLY DISCOVERED PERSONAL RECORDS OF LEWIS & CLARK. 1904	1.50
204.	Pelly, T. M. DR. MINOR-A SKETCH OF HIS BACKGROUND & LIFE. 1933	7.50
205.	Rothrock, J.T. SKETCH OF THE FLORA OF ALASKA. 1868	2.50
208.	Jackson, Sheldon. THE NORTH STAR, Sitka, Alaska. 1887	35.00
209.	Flandrau, Grace. FRONTIER DAYS ALONG THE UPPER MISSOURI.	3.00
210.	Flandrau. THE LEWIS & CLARK EXPEDITION.	5.00
211.	Flandrau. A GLANCE AT THE LEWIS & CLARK EXPEDITION.	3.00
212.	Flandrau. THE STORY OF MARIAS PASS. nd	2.00
213.	Flandrau. THE VERENDRYE OVERLAND QUEST OF THE PACIFIC.	3.50
216.	Harper, Frank B. FORT UNION & ITS NEIGHBORS ON THE UPPER MISSOURI.	2.50
220.	Burdick, Usher L. MARQUIS DE MORES AT WAR IN THE BADLANDS. 1929	2.50
227.	General Strike Committee. THE SEATTLE GENERAL STRIKE. 1919	5.00
228.	Eells, Rev. M. TEN YEARS OF MISSIONARY WORK AMONG THE INDIANS AT SKOKOMISH. 1881	12.50
229.	THE PACIFIC NORTHWEST. 1883	3.00
230.	Steele, Richard F. THE STORY OF LINCOLN COUNTY, WASHINGTON 1909	2.50
231.	Sayre, J.W. THE ROMANCE OF SECOND AVENUE.	1.50
233.	Van Dusen, W.W. BLAZING THE WAY. 1905	10.00
234.	Drumheller, "Uncle Dan". "UNCLE DAN" DRUMHELLER TELLS THRILLS OF WESTERN TRAILS IN 1854. 1925	7.50
235.	DEDICATION & OPENING OF THE NEW CASCADE TUNNEL. 1929	2.00
237.	Rathburn. HISTORY OF THURSTON COUNTY, WASH. FROM 1845-1895. nd	7.50
239.	Van Olinda, O.S. HISTORY OF VASHON-MAURY ISLAND. 1935	6.00
241.	Hanford, C.H. SAN JUAN DISPUTE. 1900	2.00
242.	Wecker, Ezra. UNCLE EZRA'S SHORT STORIES FOR CHILDREN. nd	5.00
244.	Blankenship, Geo. E. LIGHTS & SHADES OF PIONEER LIFE ON PUGET SOUND.	5.00
246.	Walgamott, C.S. REMINISCENCES OF EARLY DAYS. 1926	7.50
248.	THE UTAH PIONEERS. 1880	3.00
249.	Calhoun, W.C. HISTORY OF CRIPPLE CREEK. 1896	3.00
250.	Wardner, J. JIM WARDNER, OF WARDNER, IDAHO. 1900	8.00
251.	Brown, Col. W.C. THE SHEEPEATER CAMPAIGN, Idaho-1879. 1926	2.50
259.	Hornaday, Wm. T. EXTERMINATION OF THE AMERICAN BISON. 1887?	10.00
262.	Wilhelm, H. THE PORT ORCHARD INDEPENDENT-KITSAP COUNTY BUSINESS REVIEW. 1901	4.50
263.	Wilhelm. PAN AMERICAN EXPOSITION SUP. TO MASON COUNTY JOURNAL-Shelton, Washington. 1901	5.00
264.	Slauson, Morda C. ONE HUNDRED YEARS ON THE CEDAR.	10.00
265.	Jones, S.C. & Casady, M.F. FROM CABIN TO CUPOLA. County Courthouses in Washington.	10.00
266.	Estes, Geo. THE RAMHIDE RAILROAD. 1916	3.00
267.	Andrews, Clarence L. WRANGELL & GOLD OF THE CASSIAR. 1937	3.50
268.	Andrews. THE PIONEERS & NUGGETS OF VERSE. 1937	3.00
280.	PORT TOWNSEND. 1890	5.00
281.	Gilbert, Kenneth. ALASKAN POKER STORIES. 1958	2.50
282.	Moore, James Bernard. SKAGWAY IN DAYS PRIMEVAL.	4.00
283.	Chase, Cora. UNTO THE LEAST-A Biographic Sketch of Mother Ryther. 1972	6.00
284.	Blankenship, Geo. E. EARLY HISTORY OF THURSTON COUNTY. 1914	20.00
285.	Fish, Harriet U. PAST AT PRESENT In Issaquah, WN. 1967	12.50
286.	Allen, Edward W. THE ROLLICKING PACIFIC: A Selection of Poems. 1972	3.00
287.	Allen. DANCING TALES & OTHER FISHY JINGLES. 1951	4.00
289.	Chin, Doug & Art. UPHILL-The Settlement & Diffusion of the Chinese in Seattle.	6.00
290.	Wilkie, Rosemary. A BROAD BOLD LEDGE OF GOLD.	3.50
291.	Riedesel, G.A. ARID ACRES-A History of the Kimana-Minidoka Homestead.	6.00
292.	Harpham, Josephine E. DOORWAYS INTO HISTORY-Early Houses & Public Buildings of Oregon.	5.00
302.	Cleland, Lucile H. TRAILS & TRIALS OF THE PIONEERS OF THE OLYMPIC PENINSULA, STATE OF WASHINGTON. 1959	10.00
307.	Higman, Harry W. & Larrison, Earl J. PILCHUCK-The Life of a Mountain.	10.00
308.	Cleveland High School. THE DUWAMISH DIARY. 1949	5.00
309.	Veblen, Marthanna. GIANT STRIDES SINCE ANDREW CARNEGIE-Creative Architecture in King County Library System. 1974	6.00
SJU 1.	Farlow, Dr. W.G. SOME EDIBLE & POISONOUS FUNGI. 1897	2.50
SJU 2.	Gurdji, V. ORIENTAL RUG WEAVING. 1901	5.00
SJU 3.	D'Avennes, E. Prisse & Dr. J.C. Ewart. EGYPTIAN & ARABIAN HORSES & ORIGIN OF HORSES & PONIES. 1904	2.50
SJU 4.	Freshfield, Douglas W. ON MOUNTAINS & MANKIND. 1904	1.50
SJU 5.	Davenport, Cyril. CAMEOS. 1904	1.50
SJU 6.	Maire, Albert. MATERIALS USED TO WRITE UPON BEFORE THE INVENTION OF PRINTING.	1.50
SJU 7.	Liberty, Arthur L. PEWSTER & THE REVIVAL OF ITS USE. 1904	1.50
SJU 8.	Hammell, Wm. PINE NEEDLE BASKETRY IN SCHOOLS.	1.50

SJU 9. Frey, Clark. HOME TANNING. 1936	1.50
SJU 10. Browning, Frank. STEAM PLANT ERRORS.	2.00
SJU 11. Oakes, W.W. REVIEW OF ANCIENT & MODERN VIOLIN MAKING. 1899	6.00
SJU 12. Brockhous, Albert. NETSUKES. 1924	10.00
SJU 13. Langton, Mary Beach. HOW TO KNOW ORIENTAL RUGS. 1904	12.50
SJU 14. Browne, Bellmore H. GUNS & GUNNING. 1908	6.00
SJU 15. Rockhill, Wm. Woodville. NOTES ON THE ETHNOLOGY OF TIBET. 1893	8.00
SJU 16. Stejneger, Leonhard. THE POISONOUS SNAKES OF NORTH AMERICA. 1893	9.00
SJU 17. Culin, Stewart. CHINESE GAMES WITH DICE & DOMINOES. 1893	3.00
SJU 18. Burdick, Arthur J. THE PROSPECTOR'S MANUAL. 1905	7.50
SJU 19. WOODS DUAL POWER. (1902)?	1.50
SJU 20. Hayward, Charles B. DIRIGIBLE BALLOONS. 1921	5.00
SJU 21. Osborn, Henry F. THE ELEPHANTS & MASTADONTS ARRIVE IN AMERICA.	1.50
SJU 22. Todd, Mattie Phipps. HAND LOOM WEAVING. 1902	7.00
SJU 23. Wilbur, C. Martin. HISTORY OF THE CROSSBOW. 1936	1.50
SJU 24. Alexander, A.S. HORSE SECRETS. 1913	2.50
SJU 26. Clute, Willard Nelson. THE FERN COLLECTOR'S GUIDE. 1901	3.00
SJU 27. Meeker, E. HOP CULTURE IN THE U.S. 1883	10.00
SJU 28. Dearborn, Ned. TRAPPING ON THE FARM.	2.00
SJU 29. Holmstrom, J.G. SCIENTIFIC HORSE, MULE & OX SHOEING. 1902	4.00
SJU 30. Fickes, Clyde P. & W.Ellis Groben. BUILDING WITH LOGS. 1945	2.50
SJU 33. Pursell, John & N. Reese. KAYAK PADDLING STROKES. 1962	1.50
SJU 34. Moody, Charles Stuart M.D. BACKWOODS SURGERY & MEDICINE. 1910	4.00
SJU 35. Hunting, Marshall T. GOLD IN WASHINGTON. 1955	6.00
SJI 1. Krause, F. SLING CONTRIVANCES. 1904	2.00
SJI 2. Murdoch, John. A STUDY OF THE ESKIMO BOWS IN THE U.S. NATIONAL MUSEUM. 1884	1.50
SJI 3. Mason, Otis T. THROWING STICKS IN THE NATIONAL MUSEUM. 1884	2.50
SJI 4. CHIEF JOSEPH'S OWN STORY. 1879	2.50
SJI 5. Mason, Otis. BASKET WORK OF THE ABORIGINES. 1884	5.00
SJI 6. Llwyd, Rev. Dr. J.P.D. MESSAGE OF AN INDIAN RELIC: Seattle's Totem Pole.	2.00
SJI 7. Mason. TRAPS OF THE AMERICAN INDIANS.	1.25
SJI 8. Meeker, Louis L. OGALALA GAMES. 1901	1.50
SJI 9. Collins, H.B. PREHISTORIC ART OF THE ALASKAN ESKIMO. 1929	3.50
SJI 10. Eells, Rev. M. JUSTICE TO THE INDIAN.	1.00
SJI 11. Willoughby, C. INDIANS OF THE QUINAIELT AGENCY, Washington Terr. 1886	1.50
SJI 12. Leon & Holmes. STUDIES ON THE ARCHAEOLOGY OF MICHUACAN MEXICO 1886.	2.00
SJI 13. Beckwith, Paul. NOTES ON THE CUSTOMS OF THE DAKOTAS. 1886	1.25
SJI 14. Eells. THE STONE AGE. 1886	1.50
SJI 15. Allen, Lt. Henry T. ATNATANAS NATIVES OF COPPER RIVER, ALASKA. 1886	1.00
SJI 16. Yates, Dr. L.G. CHARM STONES. 1886	1.50
SJI 17. Boas, Franz. THE CENTRAL ESKIMO. 1884	12.50
SJI 18. Gibbs, Geo. TRIBES OF THE EXTREME NORTHWEST, ALASKA, THE ALEUTIANS, & ADJACENT TERRITORIES. 1877	15.00
SJI 19. Gibbs. LANGUAGES OF THE TRIBES OF THE EXTREME NORTHWEST, ALASKA, THE ALEUTIANS & ADJACENT TERRITORIES. 1877	6.00
SJI 20. Gibbs, Geo.; Dr. Wm. F. Tolmie, & Father G. Mengarini. TRIBES OF WESTERN WASHINGTON & NORTHWESTERN OREGON	20.00
SJI 21. Gibbs & others. COMPARATIVE VOCABULARIES OF THE TRIBES OF WESTERN WASHINGTON & NORTHWESTERN OREGON. part of SJI #20.	5.00
SJI 22. Gibbs. A DICTIONARY OF THE NISQUALLY INDIAN LANGUAGE.	10.00
SJI 23. Boas, F. INTRODUCTION TO HANDBK OF AMERICAN INDIAN LANGUAGES. Ext 1911	5.00
SJI 24. Swanton, J. R. THE TLINGIT INDIAN LANGUAGE. From Hndbk of American Indian Languages.	3.00
SJI 25. Swanton. THE HAIDA INDIAN LANGUAGE.	5.00
SJI 26. Boas. THE TSIMSHIAN INDIAN LANGUAGE.	8.00
SJI 27. Boas. THE KWAKIUTL INDIAN LANGUAGE.	7.50
SJI 28. Boas. THE CHINOOK INDIAN LANGUAGE.	5.00
SJI 29. Boas & Swanton. THE SIOUAN, DAKOTA INDIAN LANGUAGE.	6.00
SJI 30. Talbitzer, Wm THE ESKIMO LANGUAGE.	6.50
SJI 31. Ewers, J.C. EARLY WHITE INFLUENCE UPON PLAINS INDIAN PAINTING.	2.00
SJI 32. Fenton, Wm. CONTACTS BETWEEN IROQUOIS HERBALISM & COL. MEDICINE. 1941	2.00
SJI 33. Mason, O.T. CRADLES OF THE AMERICAN ABORIGINES. 1889	5.00
SJI 35. Steedman, Elsie V. & James Teit. ETHNOBOTANY OF THE THOMPSON INDIANS OF BRITISH COLUMBIA. nd	4.50
SJI 36. Teit. TATTOOING & FACE & BODY PAINTING OF THE THOMPSON INDIANS OF BC	4.50
SJI 37. Merrit, Gen Wesley. THREE INDIAN CAMPAIGNS. 1890	1.50
SJI 38. Remington, Fred. ARTIS WANDERINGS AMONG THE CHEYENNES. 1889	1.50
SJI 40. Pilling, James C. BIBLIOGRAPHY OF THE CHINOOKAN LANGUAGES. 1893	6.00
SJI 41. Bagley, Clarence. INDIAN MYTHS OF THE NORTHWEST. 1930	3.50
SJI 43. Mason. ABORIGIANL SKIN DRESSING.	5.00
SJI 45. Kelly, Wm A. & Francis H. Willard. GRAMMAR & VOCABULARY OF THE TLINGIT LANGUAGES OF SOUTHEAST ALASKA. 1905	3.50
SJI 46. Thorne, J. Frederic. IN THE TIME THAT WAS. 1909	2.50

SJI 48. Hough, Walter. THE HOPI INDIANS. 1915	12.50
SJI 49. DeSmet, Rev. P.J. NEW INDIAN SKETCHES.	8.50
SJI 51. Mason, O. THE MAN'S KNIFE AMONG THE NORTH AMERICAN INDIANS. 1899	2.00
SJI 53. Holmes, Wm. H. POTTERY OF THE ANCIENT PUEBLOS. 1886	6.00
SJI 55. Dorsey, James O. A STUDY OF SIOUAN CULTS. 1894	10.00
SJI 57. Mason. POINTED BARK CANOES OF THE KUTENAI & AMUR. 1901	2.00
SJI 58. Mason. ABORIGINAL AMERICAN HARPOONS. 1902	7.50
SJI 59. Hough, W. THE LAMP OF THE ESKIMO. 1898	5.00
SJI 60. Hrdlicka, Alex. ANTHROPOLOGICAL SURVEY OF ALASKA. nd	20.00
SJI 61. Drucker, P. ARCHEOLOGICAL SURVEY OF THE NORTHERN NW COAST. 1943	7.00
SJI 62. INDIANS IN WASHINGTON.	3.00
SJI 64. Steward, J.H. PETROGLYPHS OF THE U.S. Ext. 1936	2.00
SJI 67. Shallcross, V.W. AMERICAN LANGUAGE IN THE KIRILLIC ALPHABET.	5.00
SJI 68. Fletcher, Alice C. HOME LIFE AMONG THE INDIANS. 1897	1.50
SJI 70. Teit, J & F. Boas. SALISHAN TRIBES OF THE WESTERN PLATEAUS. 1930	15.00
SJI 70a Teit & Boas. COEUR D'ALENE INDIANS. Ext from BAE #45 1930	9.00
SJI 70b Teit & Boas. THE OKANAGAN INDIANS. Ext from BAE #45 1930	7.50
SJI 70c Teit & Boas. THE FLATHEAD GROUP. Ext from BAE #45 1930	7.50
SJI 72. Hoffman, Walter J. GRAPHIC ART OF THE ESKIMOS. 1897	20.00
SJI 73. Durham, Bill. CANOES & KAYAKS OF WESTERN AMERICA. 1960	7.50
SJI 75. Mason, O. A PRIMITIVE FRAME FOR WEAVING NARROW FABRICS. 1901	2.50
SJI 76. Millikin, Linna Lochr. PINE NEEDLE BASKETRY. 1920	3.00
SJI 77. PURPLE-DYEING - Ancient & Modern. 1840's	1.50
SJI 78. Austin-Walker Sales Co. APACHE BEADWORK-Instructions & Designs.	2.50
SJI 86. Krieger, Herbert W. AMERICAN INDIAN COSTUMES in the U.S. National Museum. 1928	3.00

NOTE TO STUDENTS AND COLLECTORS

Many scarce items turn up in antiquarian book stores only once. And while such works are in great demand, the high prices usually commanded by the older, scarcer items put them beyond the reach of the average student, library and small collector. Nor is there sufficient interest in such works to support the publication of a large edition. To meet this need we are bringing back into print in limited editions a diversity of Pacific Northwest and Alaskan historical materials which are selling at moderate prices. In their original form these bring prices ranging from \$5.00 to \$500.00; some even higher.

We limit most reproductions to 100 to 300 copies and reprint as the demand warrants. The books have heavy paper covers that are attractively designed and usually are bound with velo plastic binders. They show both original and reprinting dates. Regular library and dealer discounts are granted. For detailed descriptions of these titles send for Shorey's free complete checklist of publications or the more comprehensive COMPLETE CATALOG OF SHOREY PUBLICATIONS at a cost of \$2.50. They both list some future Shorey Publications.

An increasing number of West Coast libraries are coming to regard our line as absolutely indispensable to their programs of promoting interest in our western history. A full set of the originals of our publications would cost between \$15,000 & \$20,000 even if they could be found. Our publications would cost but a small fraction of that. Many libraries regard our publications as so important that they are carrying our entire line as well as leaving standing orders for all titles to come. May we be of service.

- The management -