

AT MICROFICHE
REFERENCE
LIBRARY

A project of Volunteers in Asia

Hardening and Tempering Engineers' Tools

by: George Gentry, revised by E. Westbury

Published by:

Model and Allied Publications
Argus Books Limited
P.O. Box 35, Wolsey House
Wolsey Rd., Hemel Hempstead
Hertfordshire HP2 4SS England

Paper copies are \$ 3.75.

Available from:

META Publications
P.O. Box 128
Marblemount, WA 98267 USA

Reproduced by permission of Model and Allied
Publications.

Reproduction of this microfiche document in any
form is subject to the same restrictions as those
of the original document.

Hardening and Tempering ENGINEERS' TOOLS

Hardening and Tempering Engineers' Tools

GEORGE GENTRY

REVISED BY

EDGAR T. WESTBURY

MODEL & ALLIED PUBLICATIONS
ARGUS BOOKS LIMITED
14 St James Road, Watford, Hertfordshire, England

First Published 1950
Second Edition 1960
Third Edition 1966
Second Impression 1971
Third Impression 1973
Fourth Impression 1975
Fifth Impression 1977
Sixth Impression 1978
Seventh Impression 1980

© Argus Books Ltd 1977

ISBN 0 85344 054 9

No part of this publication may be reproduced in any form or by any means without the permission of Argus Books Ltd.

Model and Allied Publications
Argus Books Limited
14 St James Road, Watford,
Hertfordshire, England

Printed in Great Britain
By Unwin Brothers Limited
The Gresham Press, Old Woking, Surrey, England
A member of the Staples Printing Group

PREFACE TO THIRD EDITION

The efficiency of cutting tools employed in engineering and other crafts depends very largely on their correct heat treatment. The use of carbon steels is still predominant and, although the methods of hardening and tempering such tools is relatively simple and straightforward, there are many users of these tools who run into difficulties when attempting to harden and temper them.

In the past, the methods employed in these processes have often been governed mainly by rule of thumb, and experienced tool makers have often evolved individual methods which have been in some cases closely guarded as trade secrets. Reliable practical information on the subject has been difficult to obtain. There is, however, no reason why even the novice should not be able to harden and temper tools quite successfully by adopting simple methods which can be applied without the need for elaborate equipment.

Since the original edition of this book by George Gentry was published over 30 years ago, several later editions have included information on current trends in tool technique and metallurgy to keep it fully up to date with modern practice, while still concentrating on basic requirements of the small workshop. In the present edition the chapter on case-hardening has been completely re-written, with more fully detailed description of the latest processes, materials and equipment; also new information on gas hardening, nitriding and flame hardening. Other additions include reference to methods of measuring hardness, and details of gas and electric furnaces of a type suited to the small workshop, technical school, laboratory or factory. Although tool bits and welded tips have largely superseded forged tools for lathes and other machines, the chapter on forging has been retained, because it is very useful for every toolmaker to know how to shape steel by hot working under the hammer. It simplifies the production of many tools which do not conform with orthodox shape, and often effects considerable economy in costly tool steel. But the heat treatment of modern high-speed steel tools, and tipping of tools with super hard metals such as tungsten carbide, has not been neglected. In view of the increasing use of the Centigrade temperature scale, this has been used, together with equivalent Fahrenheit figures in most heating statistics.

Although the principles of hardening and tempering do not change, except in respect of such new materials as are introduced in the course of metallurgical progress, these processes may be simplified, and success is rendered more certain, by taking full advantage of the modern appliances for heat treatment.

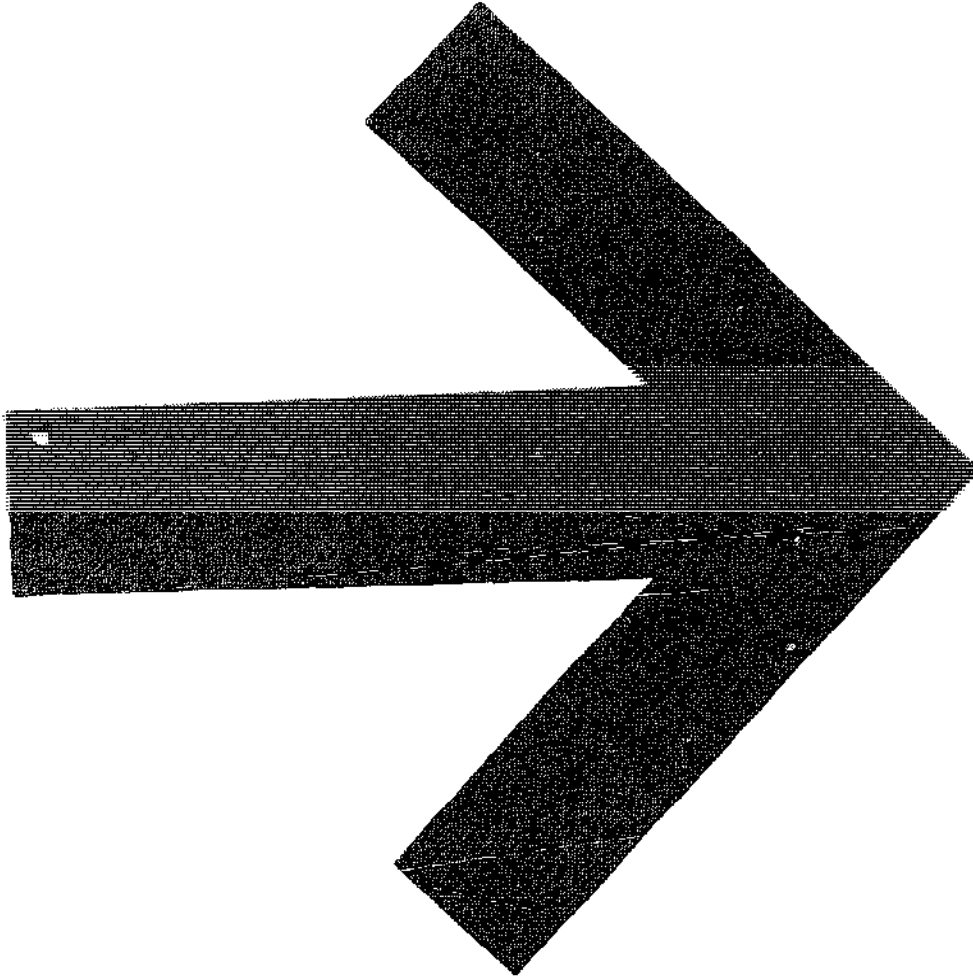

CONTENTS

	PAGE
PREFACE	
CHAPTER I. THE PRINCIPLES OF HARDENING	1
II. ANNEALING BEFORE RE-HARDENING	15
III. METHODS OF HARDENING	21
IV. TEMPERING PROCESSES	26
V. HARDENING AND TEMPERING SPECIAL TOOLS	39
VI. FORGING LIGHT TOOLS	51
VII. TREATMENT FOR SPECIAL STEELS	63
VIII. CASEHARDENING	69
IX. TUNGSTEN CARBIDE AND SIMILAR HARD ALLOYS	78
X. SMALL GAS AND ELECTRIC FURNACES	81

CHAPTER I

THE PRINCIPLES OF HARDENING

It is difficult to define an absolute standard of hardness, because it is a purely relative property. The dairyman cuts butter with a wooden knife, therefore, relatively to the material cut, wood is hard; but relatively to soft steel, wood (even so-called hardwood) is soft. Again, the hardest known material, diamond, will easily scratch dead-hard steel without any abrasion of its points; therefore the latter, relatively to the diamond, is soft.

Taking a few materials in rough order of hardness, which are used in mechanics for cutting, we have diamond, other crystalline minerals (of which sand is an example in a pulverised form), corundum, emery, glass, hardened steel, chilled cast iron, hardened and tempered steel, and so on. We find that quite a lot of things are harder than hard steel, yet they are not suitable for cutting, because they are neither tough enough nor sufficiently strong. In a certain direction a diamond is easily sheared or cleaved into layers, and therefore, leaving alone the trouble in shaping it for cutting, it could not be used satisfactorily. Corundum, emery, and similar materials are used for a certain kind of cutting called "abrasion" or "grinding," wherein grains of the material presenting a multitude of cutting points scratch away the material; but these, if shaped and presented to objects as a cutting tool, would not hold up for a minute. The weakness and instability in the matter of

strength of glass is so well known that it needs no comment, except to point out that glass cannot be used directly to cut even soft wood, and for general shaping purposes is only used to grind wood, mounted in small grains by glue on paper (so-called "sand" or "glass" paper). Steel in its dead-hard form somewhat resembles the above materials, in that its strength is much impaired by its hardness, but in another respect it stands alone in the property it possesses of being tempered over a large range of hardness, wherein the extreme hardness is reduced in order to bring about a corresponding toughness and consequent return to strength. Apart from this, steel in its annealed state (or soft state) is the strongest of the general materials used in manufacturing processes in the matter of tensile strength; and its capacity for being shaped by hammering when red hot places it practically alone as a material suitable for cutting nearly all others.

Suitable Steels

The great majority of craftsmen's tools are made of high carbon steel, commonly known as "cast" steel, though this term is indefinite and may apply also to certain types of steel which are not suitable for tools. The term "cast" steel, however, as used in this book will apply to carbon tool steel. The steels which contain not more than about 0.4 per cent. of carbon are termed mild or low-carbon steels; they are useful for a wide range of constructional and mechanical work, but cannot be hardened by normal heat treatment, except superficially by a "case-hardening" process.

Tool steels capable of being hardened by heating to redness and quenching rapidly in water or other coolant usually contain from 0.5 to 1.5 per cent. of carbon, with additional small traces of other elements such as silicon, manganese, phosphorus, etc., either as impurities or deliberately added for specific purposes. The hardening and tempering processes may, therefore, be subject to some

variation, according to composition and quality. A very popular grade of carbon steel, known in America as "kill rod" and in this country as "silver steel" (though it contains no silver), is very useful for making small tools of all kinds and is one of the simplest steels to harden and temper successfully.

Nearly all edge tools are still made of carbon steel, though the use of this for metal-cutting tools, such as lathe tools, drills, etc., is now limited to light duties where little heat is generated in the course of cutting action. For heavy duties, metal cutting tools are much more commonly made of special high-speed steel or have hard metal tips, brazed or welded to mild steel shanks.

Hardening Cast Steel

The first process in making a hardened steel tool is to make it dead hard, because it is only from that state that the hardness can be let down to a degree suitable for the work required. When ordinary cast steel is heated to about 1350° F. (750° C.), and is kept at that heat for a short period of time, it changes to a hardenable state. If it be allowed to cool in the ordinary way, it will have time to change back to its original condition, and will do so at a little lower temperature. If, however, it be cooled quickly from above the hardening temperature, it will remain hardened even when cold. The heating must be as even as possible all over the part to be hardened, and should shade off gradually to the black-hot portion.

The most usual cooling method is by quenching in clean cold water, but thin oil, high-flash paraffin, and other oils will in some cases answer better. The various kinds of heavy grease, as lard, and waxes (as paraffin wax and sealing-wax), are sometimes used. Mercury can also be used, but is a drastic quenching medium. The presence of ordinary salt (sodium chloride) in the quenching water will increase the rate of cooling to such an extent that good-quality steel

will very likely crack badly. On the other hand, soap in the water will delay the quenching, and thus either modify the cold hardness or even allow the steel to soften again. The hardening heat stated corresponds to a bright cherry-red heat viewed in shadow (but by daylight) and it can be carried up to about 1480°F. (800°C.) or bright-red heat, viewed under the same conditions. On no account carry it higher, as at yellow-red heat the steel is more likely to crack when quenched, and at anything approaching white heat it will be spoiled, or "burned" as the smith calls it.

Methods of Heating

The most general method is by the smith's forge. A man who can use a smith's forge at all can readily follow the heating hints already given, but if he is inexperienced, other methods will serve him better. Bunsen gas burners with

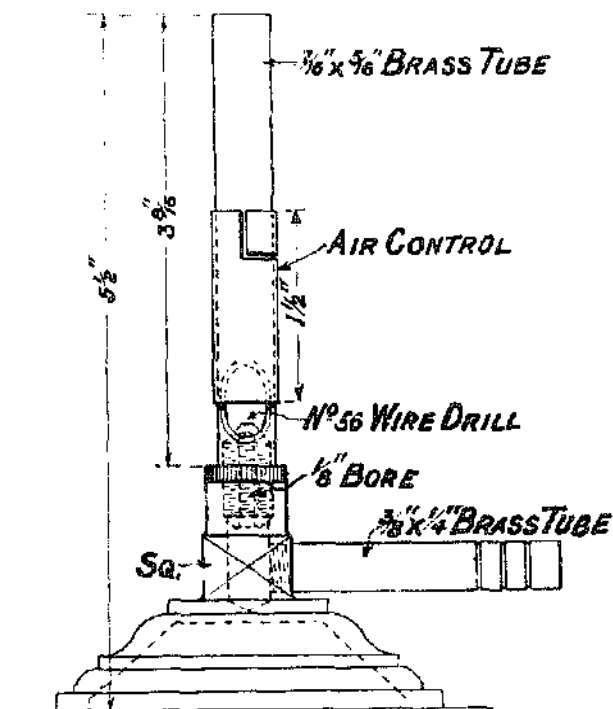

Fig. 1.—An easily made Bunsen burner for hardening and tempering small tools

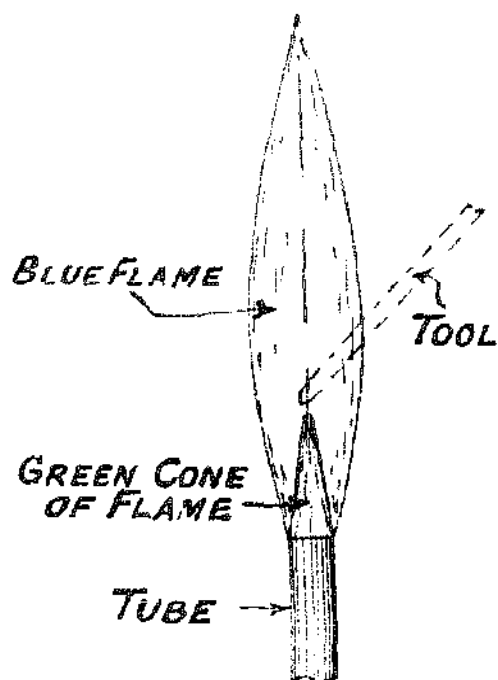

Fig. 2.—Type of flame from Bunsen burner

either natural or forced draught are convenient heating appliances. For small tools hardened only locally about the cutting edge the upright type of natural draught Bunsen burner (Fig. 1) is best. This is all brass except the base-piece of cast iron. The gas nipple is $\frac{7}{8}$ in. long, screwed $\frac{3}{8}$ in. \times 26 t.p.i. at both ends. It screws into a tapped hole in the base, and into a similar tapped hole in $\frac{5}{16}$ ths in. tube, and is drilled through as shown, the larger bore being $\frac{3}{4}$ in. long. Air-control tube is of thin brass and slides over the $\frac{7}{16}$ ths in. diameter on the outside of the $\frac{5}{16}$ ths in. tube. It is saw cut down one side and half across, to spring in at top and grip the tube a friction sliding fit. The airhole is on both sides of the tube, and is oval, $\frac{9}{16}$ ths in. \times $\frac{5}{16}$ ths in.; it can be entirely closed by the air-control tube. The base-piece may be made much less ornamental if desired. Fig. 2 shows the kind of flame and the point where the greatest heat is obtained—that is, at the top of the inner green cone of flame. If the

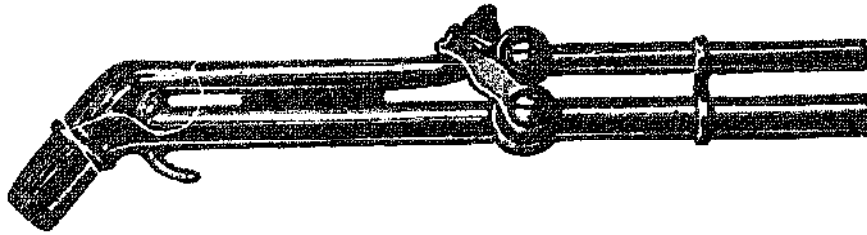

Fig. 3.—A Fletcher-Russell forced draught gas blowpipe

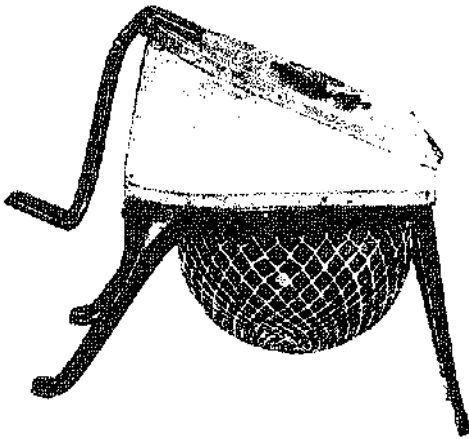
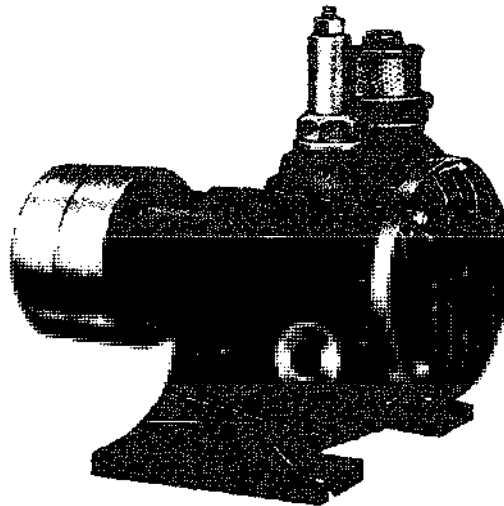

Fig. 4.—Foot bellows for use with blowpipe

Fig. 1a. — Power - driven rotary blower for use with blowpipe



tool be sloped as shown, it will be heated up a greater length than if held horizontally.

For larger tools the hand-operated forced draught blowpipe, as in Figs. 3 and 4, is quite efficient. This shows Messrs. Fletcher, Russell and Co.'s Foot Blower and air/gas Blowpipe. The first has a rubber disc reservoir on the under side, and is recommended for even pressure, but the rubber should be protected from flying pieces of hot metal. The blowpipe is supplied with taps on the air and gas pipes; but although a gas regulator is handy, the air is quite easily adjusted by the control of the bellows, and a gas control cock can be fitted to the gas supply pipe. The forced draught is usually obtained by foot bellows, but a steadier flame is maintained by laying on draught from a fan or blower. The work to be heated may, with advantage, be supported on a firebrick hearth or upon a bed of broken firebrick "cubes." The most useful kind of appliance used in this connection is the light pattern brazing forge.

Self-blowing Blowpipes

The so-called self-blowing blowpipe is generally a form of Bunsen burner in which the design is so arranged as to obtain the best possible injector effect and thereby increase the intensity of the flame. The efficiency will, however, depend very largely upon the quality and pressure of the local gas supply, and in the latter respect they may be found inadequate when the demand on the gas mains is high. Of the proprietary types of burners in this class, one of the best known is the Davi-Jet, which has multiple gas jets, each with its individual air mixing tube.

Some types of blowpipes are fitted with an air supply adjustment, but for maximum efficiency they should be designed to work with the air jet wide open. In any type of Bunsen burner, the proportion of air to gas affects the temperature of the flame. If no air at all is in the mixing tube, a long yellow flame is produced, having relatively low

heating effect. Its intensity will depend on the gas pressure, and it will burn fairly silently. With moderate air supply, a long purple-blue flame is produced; but, with full air supply, a noisy flame, having a base cone of pale green burning within the larger purple-blue flame, is produced. Excess of air results in a pulsating and very noisy flame, which is less efficient, and there may be a risk of the flame striking back to the gas jet, making considerable noise, but producing very little heat. The highest temperature in a burner of this type is obtained at the apex of the inner cone of flame. The work to be heated should be held fairly close to this cone, but not within it, as this results in impingement of free oxygen on the metal, which reduces its temperature and tends to cause oxidisation.

With all open methods of heating, care should be taken to subject the work to the most efficient part of the flame, and avoid direct action of the air supply or draught.

Forced-draught Blowpipes

The supply of air under pressure to a gas burner increases the intensity of the flame and allows a greater quantity of gas to be burnt efficiently. The gas-air type of blowpipe is one of the most useful appliances for rapid heating for either tool hardening or other processes. A specialised design of burner is employed and the air is supplied at a relatively low pressure by means of bellows or some form of power-driven fan or blower. It is most conveniently applied in conjunction with a light forge or brazing hearth, consisting of a shallow sheet-iron trough on a stand, containing refractory material, such as coke, asbestos, or broken fire bricks, to conserve the heat and also screen the work to some extent from the oxidising effect of the surrounding air. This material becomes incandescent, but is not consumed, and it may be employed to assist diffusion of heat and thus acquire a more uniform heat throughout the body of the work.

and types of jets to suit the class of work. It is also capable of being adapted to use liquid or "bottled" gas. The latter type of gas is now becoming increasingly popular, mainly by reason of its convenience. In cases where mains gas is not readily available, the gases employed are usually propane or butane, compressed and liquefied in metal cylinders, which

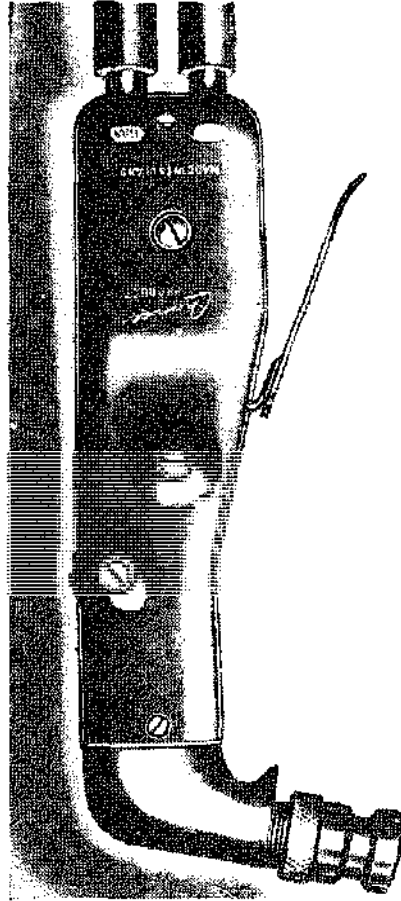

Fig. 5.—The Flame-
master high - pres-
sure gas blowpipe

The Fletcher-Russell type of blowpipe is a well-established appliance, which can be relied upon for efficiency. Another very efficient type of forced-draught blow-pipe, which has been introduced in recent years, is the Chance Flamemaster (Fig. 5). This is capable of working either with low or high pressure, and can be supplied with a number of different sizes

are portable and can be used either with or without forced air supply. Fig. 6 shows the Sievert torch for propane gas, fitted as a blowpipe, and 7 shows the same burner fitted as a bench burner. A self-contained blowlamp, with gas bottle, by Dex Industries, is shown in Fig. 8.

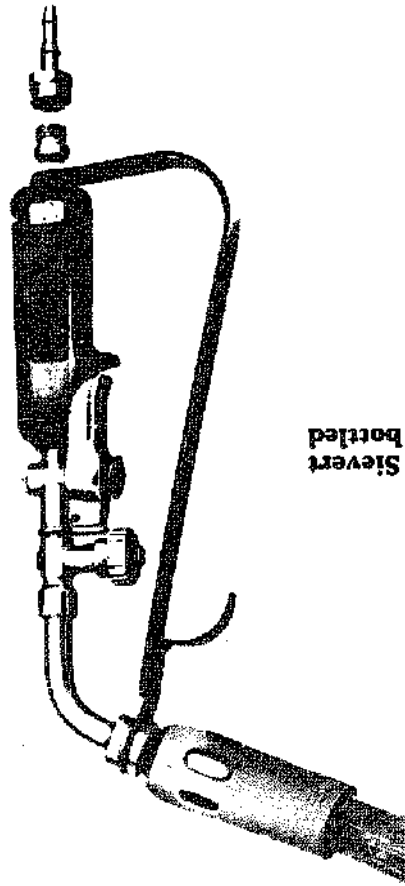

Fig. 6. — The Sievert
blowpipe for bottled
gas

In the absence of either facility, a good paraffin blowlamp is capable of doing quite useful work in hardening and tempering, but it is most essential that the burner should be kept in efficient condition so that it produces a clean and intense flame. Imperfect combustion in these burners results in a smoky flame which tends to oxidise the work and may not produce a sufficiently high temperature.

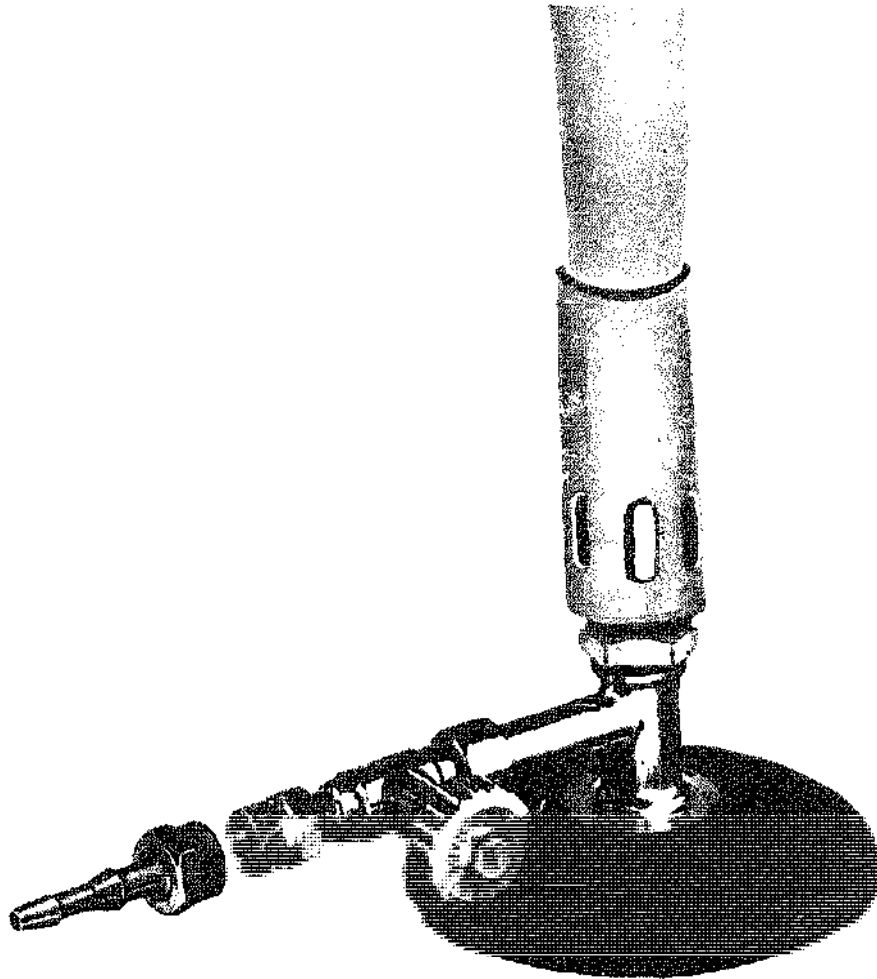

Fig. 7.—The Sievert burner adapted as a bench Bunsen burner

The oxy-acetylene type of blowpipe can be employed for hardening and tempering in skilled hands, but it is less suited to producing the more diffused type of flame such as can be obtained with Bunsen burners or blowlamps, and, in the hands of a beginner, it may do more harm than good until its proper adjustment and use can be mastered.

Such tools as screw-taps, reamers, milling cutters, screw-plates and dies, and others that require to be heated evenly over their whole bulk and hardened without warping, are not

easily dealt with by any form of blowpipe. In order that they shall not change form in hardening, it is essential that they be heated evenly. This is best done in a gas-heated muffle furnace. Several types of muffle furnace are specially made for hardening purposes, but these are generally intended for heating large numbers of small tools at one operation. Fig. 9 shows a section of a small muffle furnace. The muffle or oven is a tunnel-shaped fireclay box like Fig. 10.



Fig. 8.—A Self-contained bottled gas blowlamp by Dex Industries Ltd.

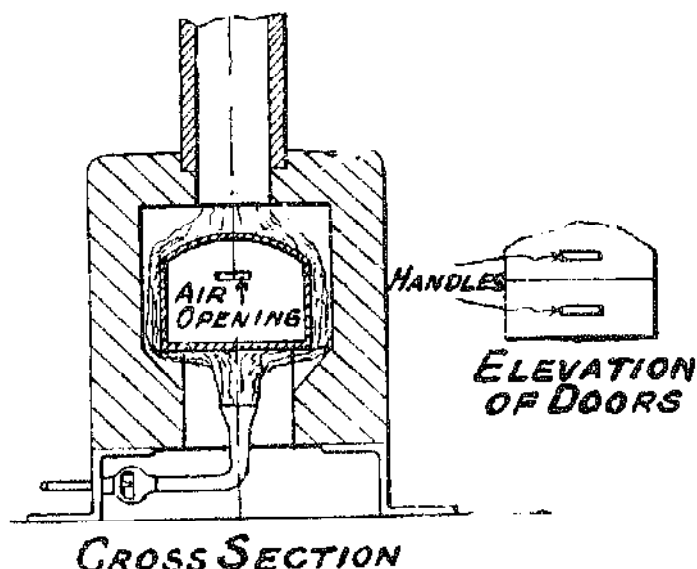

Fig. 9.—A small gas-heated muffle furnace

open at one end, and sometimes pierced with a small airhole at the other or closed end. For heating for hardening, the airhole is unnecessary, but for tempering, in some cases, it is useful, as will be described. If such a furnace be fitted with a pyrometer (or high-reading thermometer), the effort of judgment ordinarily exerted to determine the right heat obtained is not required, the furnace being fired and kept at the necessary temperature. Tools put in the muffle for heating should be supported upon the edges of metal or firebrick bars, so that the heat plays evenly all round under them, and such as are slender and liable in the heated state to bend are thus supported all along. Larger types of gas and electric furnaces, as employed in small industrial workshops, are described in the concluding chapter.

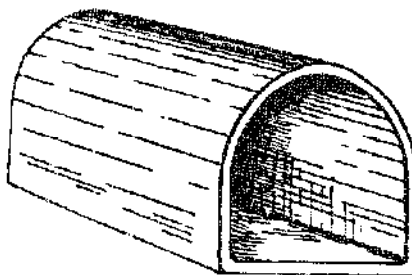

Fig. 10.—A small fireclay muffle for use in gas furnace

Having so far briefly described the process of hardening ordinary cast steel dead hard, with a view to enlarging on the subject in later chapters, it is as well to point out the inadvisability of rehardening already hardened steel, without first annealing it. This is found to be one fruitful cause of hardening cracks, which in some cases render a tool, upon which much time may have been spent, useless for cutting purposes.

It should be clear also that dead-hard steel is seldom (practically never) used with cutting tools, on account of its extreme weakness. Indeed, steel is only left dead hard with tools that scrape but do not cut. This opens up the principal art in preparing hardened tools, that of tempering, to which passing reference only has been made. This will be discussed in detail later.

CHAPTER II

ANNEALING BEFORE RE-HARDENING

WHEN hardening cast steel in the manner described, during the heating process, and when the heat is being constantly applied, the temperature rises in proportion to the rate of heating up to the point where the steel changes to the hardened state. This point is called the "absorption" point. Here, for a definite, though short time, although the heat is being just as constantly applied, a halt takes place in the rise of temperature, showing that in the change a certain quantity of heat becomes latent (that is, hidden) because it goes into the metal to effect the change in its nature without in any way altering its temperature.

The rate at which the heat is applied does not appear, however, to alter much the nature of the hardness, although it may perhaps affect the ultimate strength of the hardened material. On the other hand, when cooling down from above the absorption point, the corresponding giving-out of the hardness accounts for a similar halt in the temperature drop, because the steel gives up the latent heat when effecting the change. This release of latent heat causes a slight rise of temperature in the immediate neighbourhood. The rate at which this change takes place does affect the ultimate softness. On the one hand, if we quench it suddenly, as in water, there is not time for the change, and the steel is locked up, as it were, in the hardened state. On the other, if it be allowed to cool at about the same rate as it was

heated, it will of course be soft, but not as soft as if it were cooled very much more slowly.

If therefore it be desired to bring the steel to a condition suitable for being machined, or cut in some manner, with hard steel tools so that the tools will retain their edges to the best advantage, cooling must be prolonged. This is called "annealing." The steel should be raised slowly to a bright cherry-red heat and, while in that state, buried eight or nine inches deep in slaked lime, which is better if first heated. This material, being a slow conductor of heat, allows the red-hot steel to retain its heat for a long time, and then to effect thoroughly the change back to the softened state.

Methods of Annealing Steel

To anneal steel, so that it can be readily filed, without more ill effect to the file than that due to ordinary wear, the annealing can be achieved by heating as before described, and allowing the steel to cool, buried in ashes, or to cool upon the hot hearth. Another method, not often used, is to bury the hot steel in dry sawdust, but this is probably not advisable with tool steel. If time is important, and it is only required to file up a tool slightly, it may be sufficiently annealed if, after heating, it be allowed to cool to black hot lying on the cold ashes. Then that portion upon which it is not intended to operate with the file may be quenched in cold water, thus extracting the heat by conduction more quickly from the other portion. A method of so quenching a tool with tongs is shown in Fig. 11.

Steel which has been raised in temperature above the absorption point and then cooled, reaches its point of least density when it changes back to the softened state. That is to say that at the temperature of the change it expands to its maximum. This is one of the principal causes of hardening cracks in the steel. When tools that have comparatively thin and thick parts are being quenched, this expansion as

it takes place during the quenching, occurs first over the thin parts, and the surface of the thick, the inner portions of the latter not being affected in this manner until slightly later. The result of this, if fracture does not take place, is that internal stresses are set up in the hardened steel, which naturally render it unstable and likely to fracture under extraordinary pressure or when subjected to blows—as of a hammer. Therefore, when rehardening a tool that is already hard, but is not considered hard enough, or is hard in the

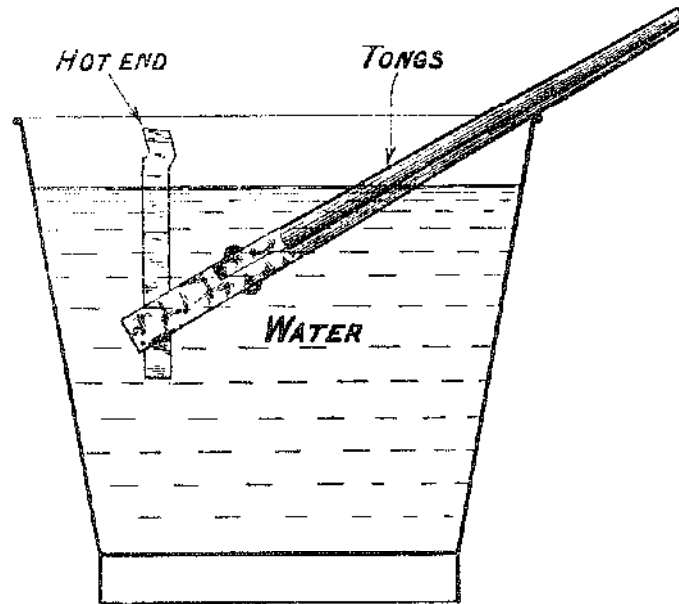

Fig. 11.—A method of quenching "black hot" steel to ensure softness

wrong place, it is found best to anneal it first. In annealing, the stresses mentioned above are, for the most part, taken out, and the steel brought into a state less likely to fracture in rehardening, which will again of course put in a new set of stresses.

A method of annealing where a considerable amount of cold cutting is to be done, and one used for such as air-hardening and self-hardening steels, is to enclose the tools or other articles in an airtight metal box, say of thin sheet steel, buried therein in lime. This is heated in a furnace and kept at a good red heat for a short time, and allowed to

cool with the furnace, being neither opened nor removed therefrom till quite cold. In the case of special steel, however, the heat to which the box and its contents are raised is very much above a good red heat, approximating white heat in fact; but the treatment of special steel, referred to later, will explain this.

A modification of the above, which may be used for small articles, is to enclose them in a piece of wrought-iron or steel barrel (*i.e.* wrought-iron pipe) which is filled also with lime, the ends of the tube being stopped either with screwed plugs screwed to internal threads, or screwed caps screwed on external threads. Failing such fitments, which are regular accessories in wrought-iron pipe work, the ends may be stopped with clay plugged in tightly. This can be heated within the heart of an ordinary kitchen-range fire, or of a similar cooking stove, although care must be taken not to let the tube and contents get to anything approaching white heat if the enclosed material is ordinary carbon steel. It is generally best, however, to allow the tube to die down with the fire as it goes out.

A very good luting material—that is, a kind of refractory mortar useful for sealing boxes and tubes airtight during heating—is made by mixing powdered fireclay with sodium silicate. The latter is what is commonly known as water-glass, a compound of glass (silica) in solution, which can be thinned with water.

Avoiding Superficial Oxide

A method of fine annealing, which is also an oxide-reducing process, can be used when it is required thoroughly to anneal steel without forming any oxide superficially. Fig. 12 shows the idea in diagrammatic form. A thin steel box A, nicely fitted to be gastight, and having suitable joints for luting with a mortar, is equipped with a feed tube B for gas supply, placed near the bottom at one end, and with a gas overflow C at the top at the other end. Within this box the articles are

stood upon thin edges, to allow the surfaces to be well exposed to the action of a gas. The box is placed in a cold muffle furnace, and a hydrogen supply connected up to B; thus the box is heated with the articles surrounded by an atmosphere of hydrogen. Before heating, the gas is run through until all explosive mixture is expelled; the escaping gas is then ignited at the outer end of C, which must be carried away clear of the heat of the furnace. This forms a pilot light to indicate that the hydrogen is present, but the gas supply may be turned down to give only a small flame at the orifice. It cannot light back, as there is no oxygen in the box. The furnace is now lighted, and the heat brought up to a suitable temperature for annealing the material, as

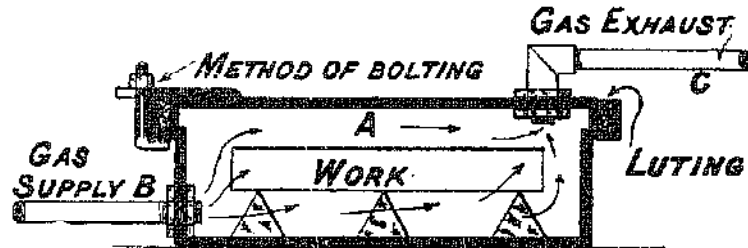

Fig. 12.—Method of fine annealing and reducing oxide

shown by pyrometer (a high-reading thermometer). This temperature is maintained for a greater or less time according to the superficial area of the contents of the box, to effect the reduction of any oxide thereon. When finished, the furnace is turned off, and the box and contents allowed to cool, the gas and pilot light being on until all is cold. A most beautiful silvery surface results from this, and a degree of annealing quite remarkable. The method works better with pure hydrogen than with ordinary coal gas. It is essential that great care be taken to ensure that the box is gastight, and remains so, or a dangerous explosion may result upon lighting back.

The presence of oxides (such as carbon monoxide) in such gas is however a hindrance to the reducing action. For de-oxidising a number of articles, a box with baffle plates, as

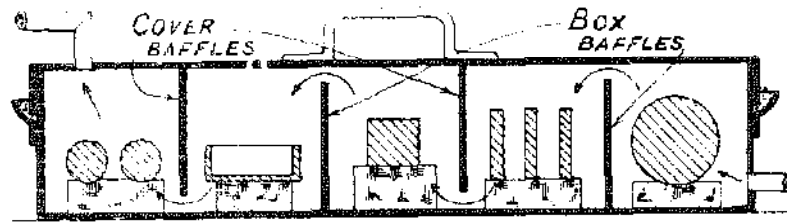

Fig. 13.—Annealing and reducing box with baffle plates to increase effective length

in Fig. 13, gives a long tunnel for the circulation of the gas, and hence increases the efficiency of the space in the box.

It should be clear from the foregoing remarks that the thorough annealing of steel is best effected by dead-slow cooling from above the hardening or absorption point, together with some effective means of preventing oxidation of the surface. The latter, however, is not absolutely necessary in a general way.

Particularly when heating cast steel, either for annealing or hardening, one has to avoid as far as possible free oxygen, as in the air blast, impinging on the steel. Free oxygen causes excessive oxidation of the surface and aids surface decarbonisation of the steel. Using too short a blowpipe flame is bad practice. When working with an open fire, either by a smith's fire or with a blowpipe, the work should be housed in, to avoid, as far as possible, currents of air playing round the hot work with the same ill effect. This does not apply so much to lathe and hand tools, which are subject to having their edges ground, but to exact-size tools, such as milling cutters, dies, and reamers, unless it is intended that their cutting edges should be ground to size or profile after hardening.

CHAPTER III

METHODS OF HARDENING

THE hardening of tools or other steel components should always start from the annealed state and the heat should be applied gradually.

It is better when steel is cold to bring it up over the initial or black-hot stages comparatively slowly, so that it can adapt itself to change of form. Once it begins to show luminous heat the heating may be applied more vigorously. Such a precaution has some effect in keeping down the ultimate stresses (which are the result of the hardening) and may help to prevent hardening cracks. Also ensure that the heating is constant over the whole bulk where it is to be hardened. To effect this when a hearth is used, turn the work over and about, so as to present all sides evenly to the heating flame, or to the bottom heat of the fire where a smith's hearth is used. Endeavour to heat it without a sharp line of demarcation between the red-hot part and the black-hot.

In other words, so dispose the heating flame as gradually to change from black to red heat. At the same time arrange this position so that the resultant change from hard to soft, which occurs about where the luminosity varies from bright to dull red, is at the best position for such a change. This last, of course, refers to such tools as lathe tools and chisels, which only need to be hardened at and about their cutting edges, with a sufficient margin to allow for grinding away,

and to provide a spring tempered hardness to the overhanging portion of a lathe or shaper tool.

Whatever the medium for quenching, one particular point must always be observed—that is, when the liquid is not in motion, plunge the red-hot article well down, and move it rapidly about in the liquid, both around and up and down. The reason for this is that with anything of a fair bulk in proportion to the mass of the liquid, the generation of vapour (in the case of water, steam) is so rapid that vapour cavities are formed around the metal which protect it from the quenching action. The rapid movement breaks up these bubbles, and at the same time brings the hot metal continually in contact with the colder portions of the liquid, and therefore enhances the rapidity of quenching. Do not remove the job permanently from the quenching medium until it is practically cold, or cold enough to handle comfortably.

Temperatures

It is not wise to carry carbon steel or ordinary cast steel up to a yellow-red heat (about 1650° F. or 900° C.), because it is found that, although it does not burn at this, with water hardening it loses its toughness and becomes brittle and is more likely to develop cracks due to uneven quenching. On the other hand, carbon steels poorer in carbon may be carried to this heat (but not above) and water quenched. It is possible, however, to carry good cast steel to this heat and quench in oil. In any case, heating above this point results in burning almost any kind of cast steel with the exception of special steels. The best heat is the bright red (1480° F. or 800° C.) when quenching in water, and to maintain the work at that temperature for perhaps a half-minute before quenching, to allow a thorough change. By this, and by further drawing the temper fairly far up to the cutting edges, the best results are obtained for tools which require strength. For tools to attain and maintain keenness, cherry-red heat, or a little above (about 1380° F. or 750° C.), is recognised as

the best procedure, the quenching being done in water, and tempering in a general manner as described in the next chapter.

If any considerable bulk requires heating all over, the fire, in the case of a smith's forge, should be built to a cavity around it, which acts as a small furnace. If a brazing hearth and blowpipe be used, the cubes of fireclay on the hearth should be reinforced by some fairly large pieces, say about 2 in. cube, of broken firebrick. The last can be grouped round the back and ends of the work and well above it, so that the flame in heating them acts by reflection on the back; and aids the extra heating required. In this matter the foot bellows require careful management to get the best results. They should be filled rapidly and discharged steadily, so as to keep a constant pressure in the reservoir. By this means the blow-flame is kept at a constant length, and the highest heating point can be steadily kept right on to the work. If the blowing be spasmodic, the flame lengthens and shortens, so that, for a considerable time, the hot part of the flame is off the work. As a matter of fact the action should be that natural to the foot, which gives a rapid upstroke to the full extent, to fill the bellows without losing pressure in the reservoir, and a slower steady downstroke to maintain the reservoir at constant discharge, neither overblowing nor losing pressure. In all good blowing, the idea is not to increase pressure of wind, but to maintain quantity at a reasonable pressure. By increasing pressure, and making the blowpipe "cough," as it were, the tendency is to blow the work cold rather than heat it, and to oxidise the surface if it is at luminous heat.

More will be said about using a blow-flame under Tempering, but there is a special point on heating tools having sharp cutting edges which should be observed always. Take care not to direct the hot portion of the flame on to cutting edges and, particularly, on to sharp points for any length of time. It is much better for these parts to derive

their heat by conduction from the heavier parts of a tool than directly from the heating medium. Long before the main body of the tool is hot enough, these sharp edges and points may be far overheated and burnt, so that the finished edge, after hardening and tempering, is so brittle, due to "shortness," that quite a lot must be ground away before they will hold up against the cut without crumbling, as it were. No amount of rehardening and tempering will set right a tool that has been overheated at the thin edges and points.

Immediately the correct temperature for hardening has been reached, it should be quickly quenched in water or other cooling medium, as described elsewhere, and the object should be cooled the steel rapidly and evenly, avoiding the possibility of steam bubbles being formed locally on the surface or trapped in cavities and thus possibly cause irregular hardness, internal stresses, or even cracks.

Where the nature of the work permits, it is a good policy to plunge it vertically endwise into the coolant; and preliminary stirring vigorously enough to form a vortex in the liquid, will help to ensure that it reaches the entire surface of the steel simultaneously. In some cases considerable distortion of the steel is liable to occur through uneven cooling, apart from other disadvantages.

The portion of the steel which has been heated to hardening temperature should now be dead hard and definitely on the brittle side. This may be verified by attempting to scratch the metal with a file. A tentative pressure of the file is all that is necessary, and there should be no tendency for it to bite at all. More exact methods of testing hardness are available to engineers, the best known being the Brinell method, in which a hardened steel ball is employed with a calibrated loading pressure to cause greater or less indentation of the surface. This is then measured visually by a graticuled microscope.

Although these methods are essential in industry, they are rather difficult to apply on the work envisaged within the

scope of this book, and the file test is generally satisfactory.

Hardened steel also has a characteristic appearance which will be recognised by the experienced worker. The hardened part of the steel should appear a mottled grey and, generally speaking, the finer the mottling, the harder the steel is. If it shows a more or less uniform dark grey or bluish-oxide surface, it may be that it was insufficiently heated before quenching, but more often it indicates that the steel is too low in carbon to be suitable for cutting tools.

CHAPTER IV

TEMPERING PROCESSES

STEEL which has not been hardened does not undergo any physical change when heated, until it approaches red heat. On the other hand, reheating steel which has been hardened will produce considerable changes in its hardness at relatively low temperatures. It is, however, possible to modify or "temper" the hardness of steel to any desired extent from dead hard to soft by suitable heat treatment. Generally speaking, it is impossible to use dead hard steel for cutting tools, owing to its extreme brittleness and lack of tenacity, which causes the edge to chip even on quite light duty.

It is only possible to keep a satisfactory cutting edge on tools for any appreciable length of time by subjecting it to the secondary tempering process, so as to produce the state of hardness best suited to the class of work for which it is intended.

The change of hardness caused by reheating hardened steel begins at a temperature of about 430° F. (220° C.) and, from there on upwards to 570° F. (300° C.), the steel is rendered progressively softer. Beyond this point the steel will generally be rendered too soft for use in cutting tools, though for other purposes such as springs, tempering may be carried out to temperatures of 600° F. or over.

Tempering Colours

Tools manufactured in quantities are usually tempered by special methods in which temperatures are indicated by

a high-reading thermometer or pyrometer and are, in many cases, automatically controlled.

These facilities are not, however, generally available in the small workshop, and it is usually necessary to adopt methods which depend on individual observation and control, but are equally effective when properly used. In this respect a very useful property of steel is the alteration in its colour when heated, due to the formation of a microscopically thin film of oxide on the surface. This presents varying shades of colour, ranging from very pale yellow to brilliant dark blue through shades of brown, brown red and purple, according to the temperature reached. These colours may be used as an indicator to assess the hardness of the steel when tempered.

Some idea of the relation between colours and temperature may be obtained as follows: pale yellow corresponds to 430° F. (220° C.) succeeded by a deeper yellow with a tinge of red, and a shade darker giving pale straw colour. Thus, middle straw colour = 475° F. (250° C.); dark straw or dark red brown = 500° F. (260° C.). Higher temperatures will eliminate the yellow, blue taking its place, which, with the red, forms purple at 535° F. (280° C.) and the red in turn dies off leaving the blue at 570° F. (300° C.). Further heating produces blue with a tinge of green, succeeded by green grey up to 620° F.

These colours can only be relied upon if the hardened steel has a perfectly clean, bright surface, entirely free from grease or moisture, and, therefore, hardened steel should either be ground on a dry grinding wheel or thoroughly scoured with emery cloth or other dry abrasive.

The tempering should be done, not by raising the temperature of the actual cutting edge by any direct heat, but entirely by conduction, the heating being applied to the shank. If a blow-flame is used, turn it down to a comparatively fine flame, and direct this on to the shank, meanwhile turning the tool round to effect even heating. The actual direction of the flame should be backward, away from

the edge, the reason being that there is a good deal of diffused heat at the outer end of a blowflame, and it is better that this be kept away from the point of the tool, as it would very likely temper the point right out long before the main body of the cutting portion had reached the temper stage at all. A tool of this sort is stronger if the temper shades off hardest at the point, and gradually softer backward towards the shank. The brightened shank aids the operator in watching the colour bands.

Before dealing further with the actual process of the tempering of tools, there is a good deal to be said about the various temper temperatures for different kinds of tools.

It should be clearly understood that, although the colour test is universally employed by engineers and toolsmiths in ordinary workshop practice, the colours are merely superficial and can easily be ground or polished off the surface. Furthermore, they are only indicators and not a definite gauge of temper. In other words, assuming that a tool has been tempered to a dark straw, and the surface repolished, heating it again to a dark straw will not produce the temper which would normally be indicated, but will produce a further softening above and beyond that indicated. Nevertheless, when properly used, the colours give a good approximate indication of the temperature, and therefore the hardness, of the work. As soon as the correct temper colour is reached, the work should be immediately quenched out in cold water.

Blacksmiths often succeed in hardening and tempering tools at one heat by quenching only the tip of the tool, leaving the main body still at black heat. The edge is then cleaned up with a stone or abrasive stick and, as the heat is conducted back to the cutting edge, the colour indications are produced progressively, the tool then being requenched when the correct temper is reached.

Generally speaking, however, the method previously described enables the steel to be more thoroughly cleaned,

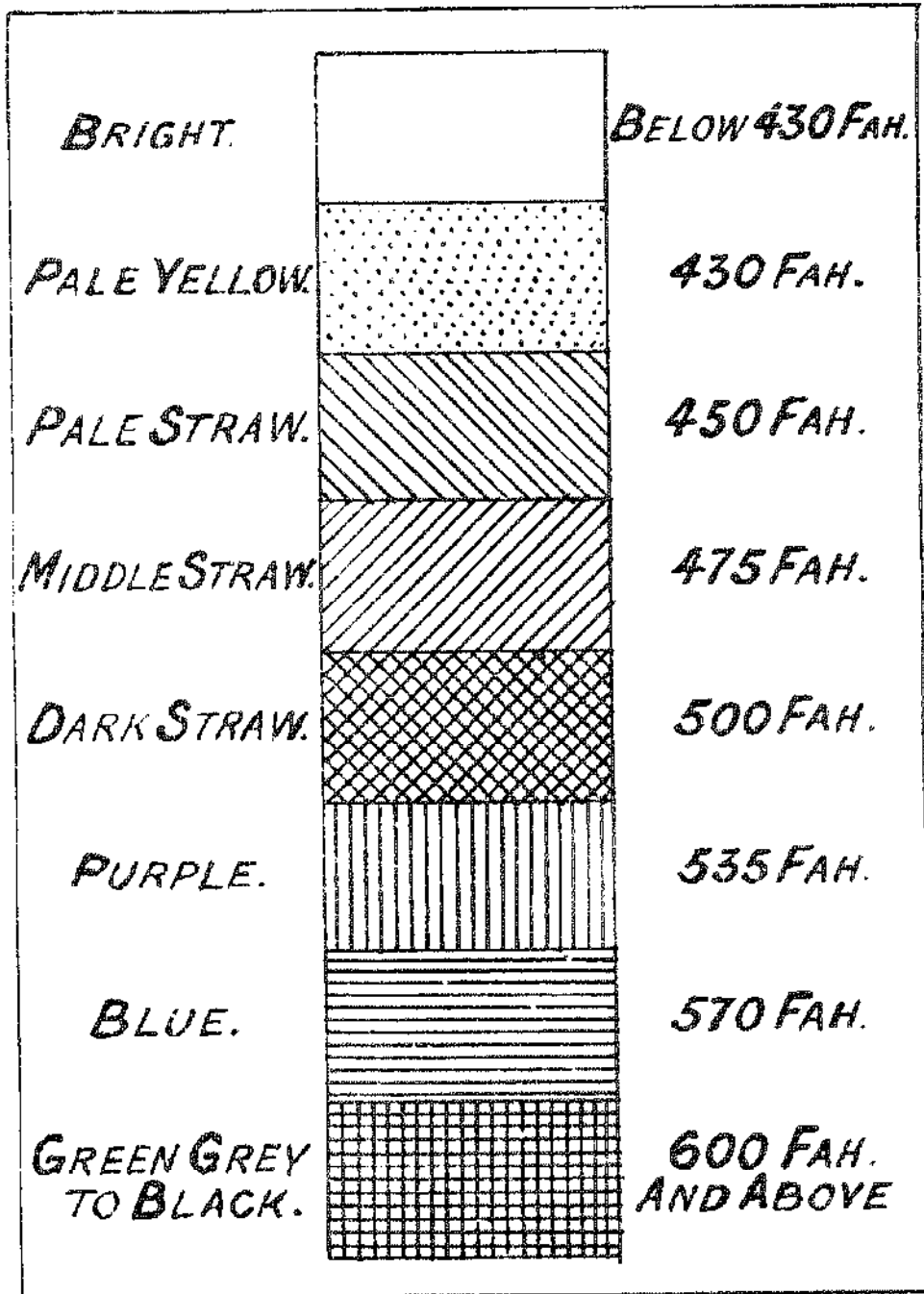

Fig. 14.—Diagram of shading tints indicating various tempering colours

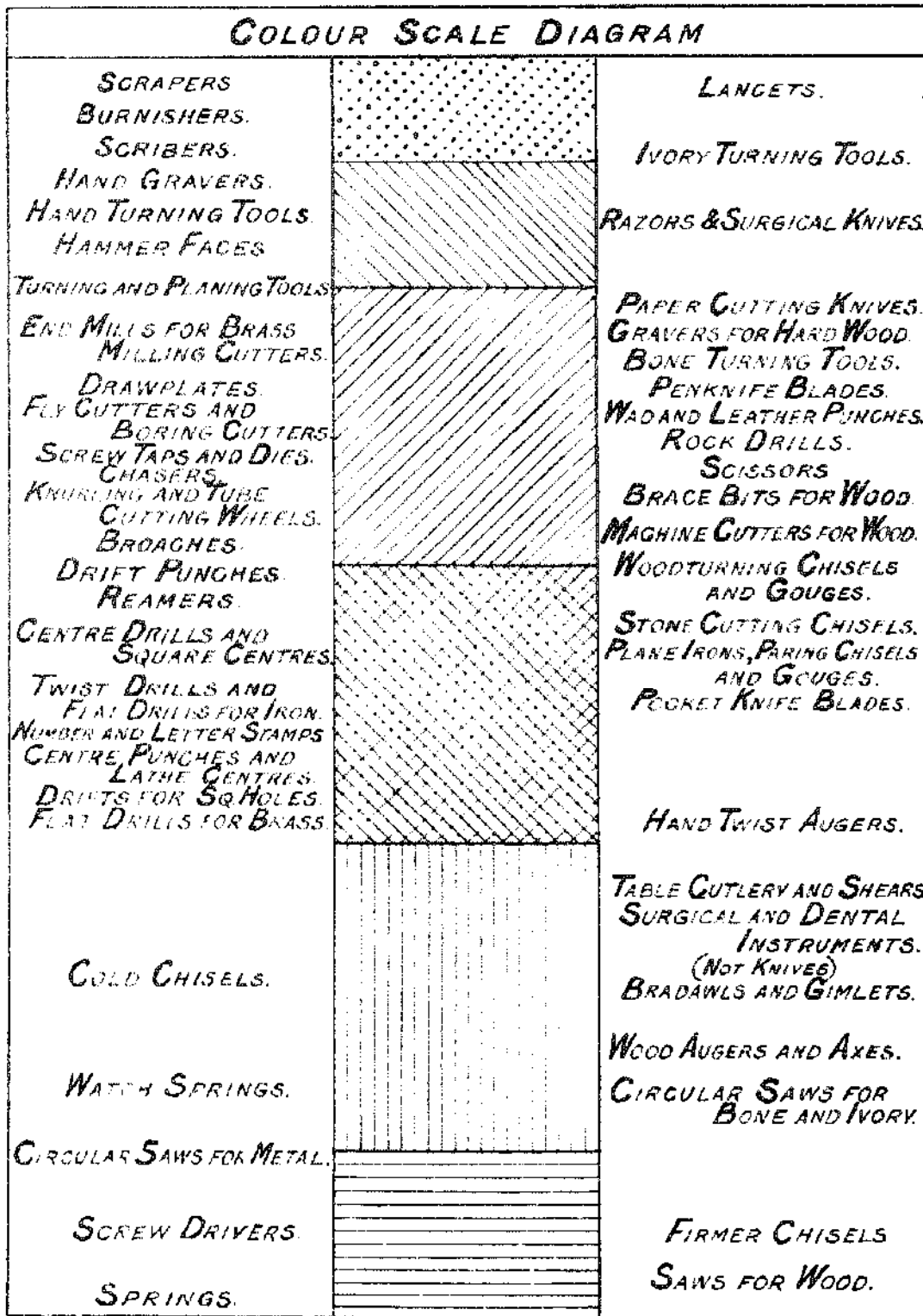

Fig. 15.—Tempering diagram for various types of tools

and control more evenly exercised, and is recommended to workers with limited experience.

The frontispiece, a colour diagram, gives a good idea of the colour range, together with a list of the various tools, which are printed approximately opposite their appropriate temper colours. Those to the left are mostly engineers' tools, and to the right wood- and stone-working tools, various knives, and general cutlery, ivory, and bone-turning tools, etc. The top of the diagram gives the colour which appears first, corresponding to the lowest temperature, and which if not carried further leaves the tool the hardest.

Temper of Various Tools

In the several examples of temper for tools now to be given, it is not practicable to reproduce them in actual colour; it is therefore proposed to represent each colour by means of different shading. Fig. 14 is a diagram showing the various shadings used, and Fig. 15 shows these shadings applied to the colour diagram. Fig. 16 illustrates the temper colour disposition for a cranked roughing-out lathe tool as used for steel and iron turning. Here the colours are preferably so disposed that while blue and purple respectively occur on the cranked portion of the tool, the various straws are on the cutting portion, the actual cutting edge being left

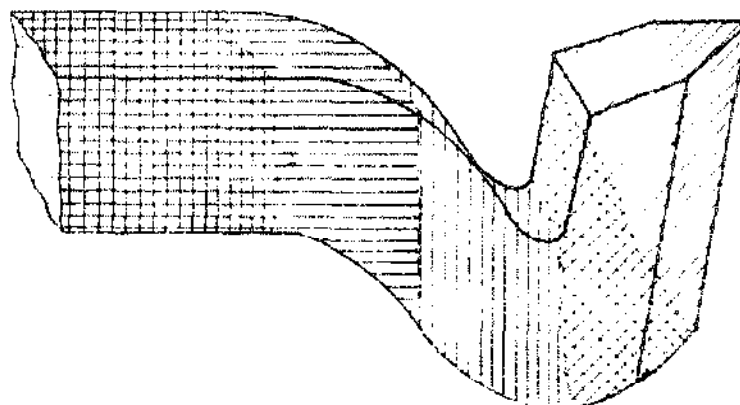

Fig. 16.—Graded temper for a cranked lathe tool

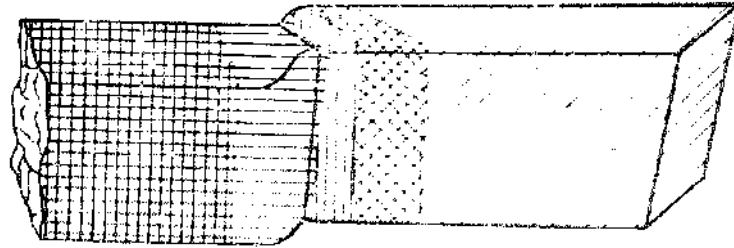

Fig. 17.—Most suitable temper for a side-cutting or “knife tool”

at about the commencement of middle straw. Remember, however, that the various lines of colour have no sharp line of division as we are obliged to show in the shaded diagram, but shade off into each other almost imperceptibly.

Referring again to the colour diagram, it should be particularly noted that the general run of cutting tools have their temper drawn to one of the shades of straw colour, whereas those tools which are subjected to blows have their temper drawn more towards purple.

Fig. 17 shows the disposition of the temper on a side-cutting or knife tool used for steel and iron. Here the middle straw is carried as far along the side-cutting edge as possible, while the particular temper aimed at where the knife portion is shouldered down from the shank is blue. This tool often has to take a fairly broad shaving with the front end of the side edge, which puts a considerable strain on the weakest point at the shoulder. If this portion, then, is left too hard it may quite easily snap off, and if too soft (either by carrying tempering too far, or by not hardening the tool far enough

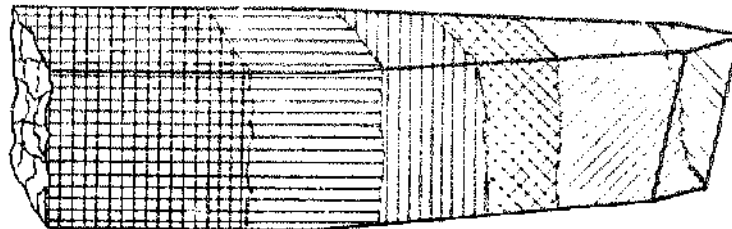

Fig. 18.—Most suitable temper for a brass-turning tool

along in the first place) it is likely to get a permanent set down, *i.e.* bent down. Being hardened, however, in the first place, and having the temper drawn to that which is usual for most springs, gives it the best chance of standing against the stress.

Fig. 18 shows a typical brass-turning tool. Here the particular thing to aim at is the temper of the cutting point. This is left harder than if it were to be used for cutting steel, although brass is softer than steel. The reason is that all tools should be tempered out to the hardest that can be left, consistent with the edge standing the stress of parting the tough material. A brass-cutting tool is stronger in this respect than one for steel, because it is normally made with practically no top rake and clearance; hence the angle of the cutting edge is greater. In addition, brass is not so tough, and puts less strain on the tool. The colour for the edges of general brass tools can be pale straw, almost yellow, and in the case of planishing tools and scrapers can be just tinted yellow.

The only brass-turning tool that is tempered at or near as low as one for iron is a parting tool, which is subjected to a good deal of strain, and is better tempered to middle straw and left blue at the shoulder; indeed, it only differs from one made for iron and steel in the fact that it is used with no top rake, whereas a parting tool for iron will not work satisfactorily without a fairly considerable top rake.

In dealing with hand-turning tools, a point shown in Fig. 19 is worth noting. Here the part where the tool is in contact with the hand rest is brought to blue tinged with purple, a temper best adapted to resist concussion and yet stand against abrasion. From this to the cutting edge it shades evenly to the cutting temper at the edge, *viz.* yellow. Behind the line of the hand rest it is left blue.

The principal hand turning tools used now are planishers (square and angled), round-nose planishers, and gravers. A square planisher is similar to a scraper. The information

given above relating to hand tools applies to all these except a graver for steel, which should be tempered to middle straw.

Tempering Cold Chisels

Fig. 20 shows a cold chisel temper. There are few tools where the temper can be varied to such an extent as is necessary in dealing with cold chisels. It is practically impossible to harden and temper a cold chisel for doing fairly heavy chipping in steel, so that it will both keep a keen edge

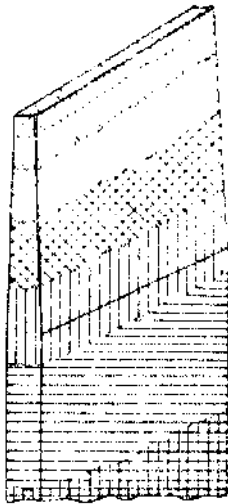

Fig. 19.—Hand-turning tool or planisher as used for brass

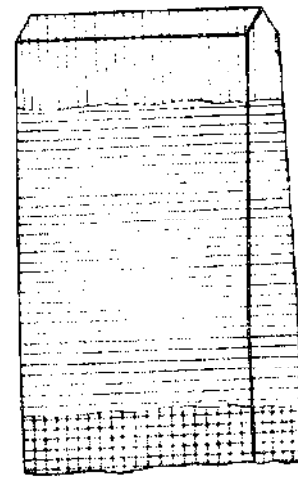

Fig. 20.—Cold chisel temper for fairly heavy work

and stand up to the work. In this case the best thing to do is to temper the chisel edge out to purple tinged with blue, when it will be found to stand up so far as strength is concerned; but as it will not keep a keen edge for any length of time, will require fairly frequent grinding. A cold chisel for fine chipping in gun-metal can be hardened in thin oil, and tempered to dark straw tinged with purple, but this will not do heavy work without pieces breaking out of the edge, although it keeps a keen edge for a considerable time if applied to light chipping. The life of a fairly highly-tempered chisel depends a good deal upon the thickness and angle

of the cutting edges, because if the edge is ground thin it is almost sure to break.

In hardening and tempering flat cold chisels, the blacksmith's, or one-heat, method of hardening can be adopted. Toolsmiths who are expert in the use of the forge choose this method because it saves time, and apply it successfully to the hardening and tempering of lathe tools. It is, however, easier for the inexperienced smith to use two heats, one for hardening and one for tempering, as previously stated.

The tool is heated to above absorption for a greater length up than is required for the final hardening. It is then dipped out, and quenched cold over the portion to be hardened, and the heat remaining in the shank is allowed to do the tempering by conduction. To deal with a chisel on these lines, suppose the hard part is required to extend up about $\frac{1}{2}$ in. Heat it to bright red for say $1\frac{1}{2}$ in. or more up from the point, and, having provided yourself with a small piece of gritstone (such as a fragment broken from a small fairly coarse grindstone, or from one of those stones used for sharpening scythes) dip out the point of the chisel in water. This must be just dipped and moved up and down slightly to avoid a sharp line of demarcation between the hard and soft, which may, if it occurs, cause the hard end to shell off bodily when the chisel is put to use. As soon as the actual edge is quenched to cold, the chisel is removed rapidly to the anvil, laid with its hard end across the edge to support it, and the gritstone applied by rubbing both sides. This brightens it sufficiently for the operator to see the temper colours as they appear progressively along the shank. When the colours appear, stop polishing, as the colours, once they appear, must not be erased.

Laying the edge of the chisel across the sharp edge of the cold anvil acts as a check to the tempering, because such heat as travels up rapidly is given away to the anvil. As soon, therefore, as the edges are brightened and the smith can see what is happening, he lifts the job from the anvil

and allows the conducted heat from the shank to have full play. A beginner at hardening would have to practise this method before using it in the ordinary way, as it requires judgment first to heat it far enough up, next to dip out in the manner described with the assurance that the edge is cold and in a hardened state before removing from the water, and at the same time to leave enough heat in the shank to perform the tempering neither too quickly nor too slowly. When the right temper colour reaches the actual edge, the whole tool is dipped and quenched to cold to avoid over-tempering. It is not uncommon, however, for an experienced smith to make so sure of the initial hardening as to use up too much of the shank heat, and so have to help the tempering by applying the tool point to the fire—but not right into it.

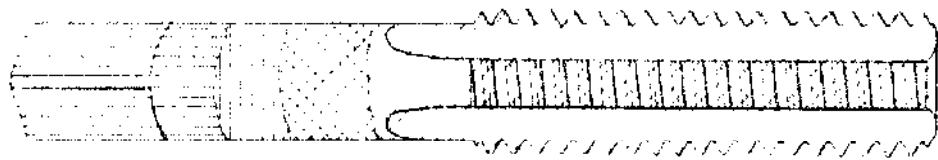

Fig. 21. —Suitable temper for a screw tap

Punches are generally tempered to dark straw, but centre punches, to prevent losing the point by fracture, should have a shade of purple in them. Lathe dead-centres are tempered to the same as a centre punch. Screw-taps are tempered as shown in Fig. 21: that is to say, the whole of the thread portion is at a constant temper of middle straw colour. The best method of dealing with taps is to harden the tap evenly throughout, then to temper the cutting portion to middle, straw evenly right to above the ends of the flutes, and finally to draw the squared end down to blue or blue tinted with purple. If the squared end is too soft, it is likely to twist off, especially in the smaller taps, and if left too hard it is likely to snap off. When bluing the square, the temper of the cutting edges can be preserved by applying damp waste

wound round it, or by sticking it into a raw potato, the moisture in which will protect it from further tempering.

A screwdriver is tempered to blue. This being one of the non-cutting tools, in order that it may not bend at the edge, and yet stand up to more or less rough use, a spring temper is found to be the best all round. A screwdriver edge should be so soft that it can easily be filed, and does not tend to mar the screw slots, yet it is hard enough to resist bending without fracture.

Drills

Drills require tempering down somewhat further than lathe and similar cutting tools. Drills are subject to percussion, especially when breaking through the under side of a surface. This is due to the fact that they have then lost the support of the guiding provided by their points. Twist drills must be hardened along the whole length of their flutes, as, apart from the fact that they are fairly rapidly ground away, they very easily untwist in the spiral of their flutes if any part of such be left soft. Contrary to the relationship of hardness in lathe tools, flat drills for brass are found to work better somewhat softer than if used in iron or steel. Indeed, a flat drill used in gun-metal at quite a high temper will stand up well until it breaks through, when, unless the speed be high, and the feed rigid, it is quite likely to lose an entire edge by fracture. Much depends upon the speed and relative feed, and whether the drills are going to be used in a hand- or machine-fed drilling machine. Drills are subjected to a live load (*i.e.* a moving force subject to variation); and as they convey both the force of rotation and of feed entirely through their own bodies, it follows that apart from actual cutting they must be tempered to resist all sorts of stresses.

A hammer head is hardened in such a manner that the hardness takes the form of a thin shell covering the whole of the peans and their sides. Beyond this it should be left soft as far as possible. The single-heat method is very good

CHAPTER V

HARDENING AND TEMPERING SPECIAL TOOLS

So far, detailed reference has been made only to hardening and tempering such as lathe tools, and similar tools that are only locally hardened. Space prevents similar treatment on all tools that can be hardened evenly throughout, but the following notes will be useful. Such tools and apparatus include screw-dies, knurling wheels, milling cutters, tube-cutter wheels, circular and hand saws, knife blades, draw plates, springs, broaches and reamers, double-ended centre drills and so forth.

Thin Reamers or Broaches

The trouble with these tools is that, being so long, uneven heating plus uneven quenching nearly always results in warping them out of the straight. Obviously a reamer or broach, to be of much use for accurately sizing holes, must be true. The following method was successfully applied in hardening and tempering a 3-16ths in. \times 5 in. 5-fluted reamer throughout. It was first decided to dip it out in oil, and a thin oil was chosen (whale oil, a product from blubber of the whale, but not sperm oil). The job was heated evenly in a small gas-fired muffle, being put right into the centre of the furnace, supported all along upon thin bricks of fireclay. The oil was contained in a long round tin about 10 in. long, and not more than 4 in. in diameter, filled nearly with the oil when stood upright. Just before dipping, the

oil was stirred so that at the moment of dipping it was revolving at a fair rate. While the furnace was heating, a pair of light tongs were heated at the jaws. These tongs were used to lift the job out when it had attained a bright red heat, the idea being to avoid cooling the work with cold tongs; nevertheless the job was held by the squared shank end. It was plunged vertically in the centre of the revolving oil, moved up and down several times, and finally dropped, the tongs being withdrawn to prevent them overheating the oil. The reamer was found dead hard and as straight as when turned, because it ran dead true between centres after the hardening. The tempering was actually done in the muffle, as it cooled. The job was held right in the centre of the muffle by means of the tongs, so that it was about equidistant from all the hot sides, being revolved and occasionally withdrawn to watch the colour, which ultimately came out an even mid-straw colour throughout. It was again dipped out in the swirling oil, and found ultimately quite true.

Another irregular-shaped long job—a half-round scraper—would insist upon warping however it was dipped, and warping considerably. Ultimately the warp, which was always the same way and nearly went out again on annealing, was carefully measured, and while in an annealed state the job was purposely curved to about the same extent in the opposite direction, which had the effect of bringing it back to the straight after hardening.

A modification of the muffle for the purpose of evenly drawing the temper in longish and thin objects as well as plates, blades, and similar flat objects, is shown in section in Fig. 22. It consists of an arrangement of two plates of red-hot metal, which must be somewhat longer from back to front than the longest job to be heated by them. They are kept apart by distance pieces which may be of firebrick, and the whole arrangement when in the hot state is stood upon a firebrick or on thick asbestos, covering stone or ordinary brick. This forms a sort of muffle, and will answer

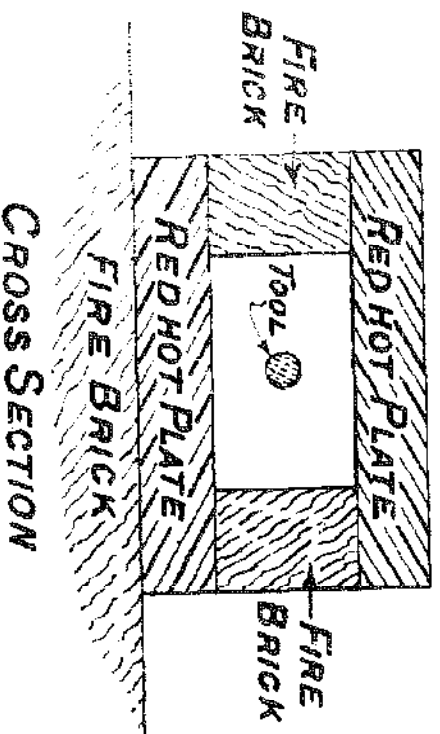

Fig. 22. A tempering oven for long, thin tools

well for tempering long straight tools. The tool is held by tongs, and must be constantly revolved and withdrawn from between the plates to enable the operator to watch the colour effect.

A single red-hot plate is very useful for uniformly tempering small long or flat tools. Such a piece can be heated in an ordinary firegrate, and when red hot, transferred to an anvil, or, better still, on to firebrick. The hardened tool may be held over but not touching it, in a more or less parallel position relatively to the hot surface according to its shape, so that the heat radiated from the surface will result in an even temper temperature. Suppose a tool to be thick at the shank end, and thinner at the point, it would be held somewhat as in Fig. 23, so that the thinner point would be delayed in receiving the heat. If it were shaped the other way round, or it were more convenient to hold it the other way round, it would then be sloped as in Fig. 24. Where the

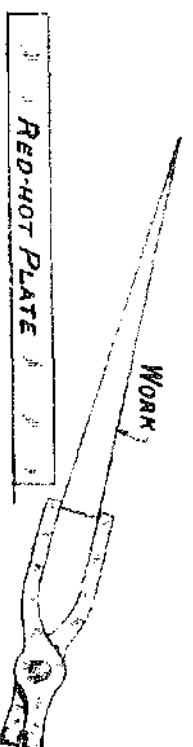

Fig. 23.—Tempering tools over a hotplate

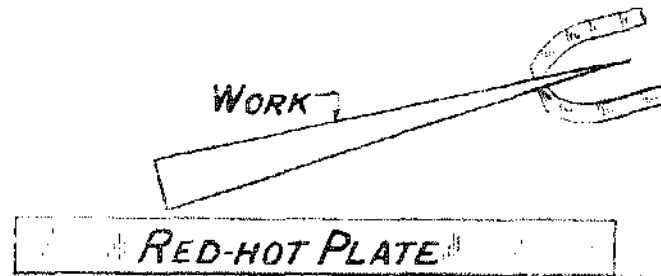

Fig. 24.—Another method of tempering work over a hotplate

tongs touch the object the tempering will be delayed, and this may be counteracted by using the lightest tongs possible. Touching the jaws against the hot plate will help considerably, as then the jaws more rapidly receive conducted heat, and are therefore less likely to withdraw the radiated temper heat from the tool. This must be watched, however, and judged according to the way the colour shows up, because it may be advisable soon to lift the tongs away from the plate, as the conducted heat may too rapidly draw the temper from the work at the point of contact with the tongs.

This last-described method is quite good for tempering small screw-plates, such as have a large number of cutting holes in them, and require particularly even tempering.

Screw Dies

In Fig. 25 is shown a method of protecting the corners of a square die. This is apt to crack at the corners, due to the more rapid action of the quenching at those thinner parts. Here, thin tin-plate strips are threaded through the clearances and hammered over, so that when the whole is hot and being quenched the quenching action is rather delayed at these points than accelerated, with the result that the liability to crack is much reduced. The same idea can be applied to circular dies. Dies are best quenched in a suitable oil, and ordinary engineers' lubricating oil is quite good enough for the purpose. Dies can quite easily be tempered evenly over an ordinary gas ring. Hold the die with light tongs by

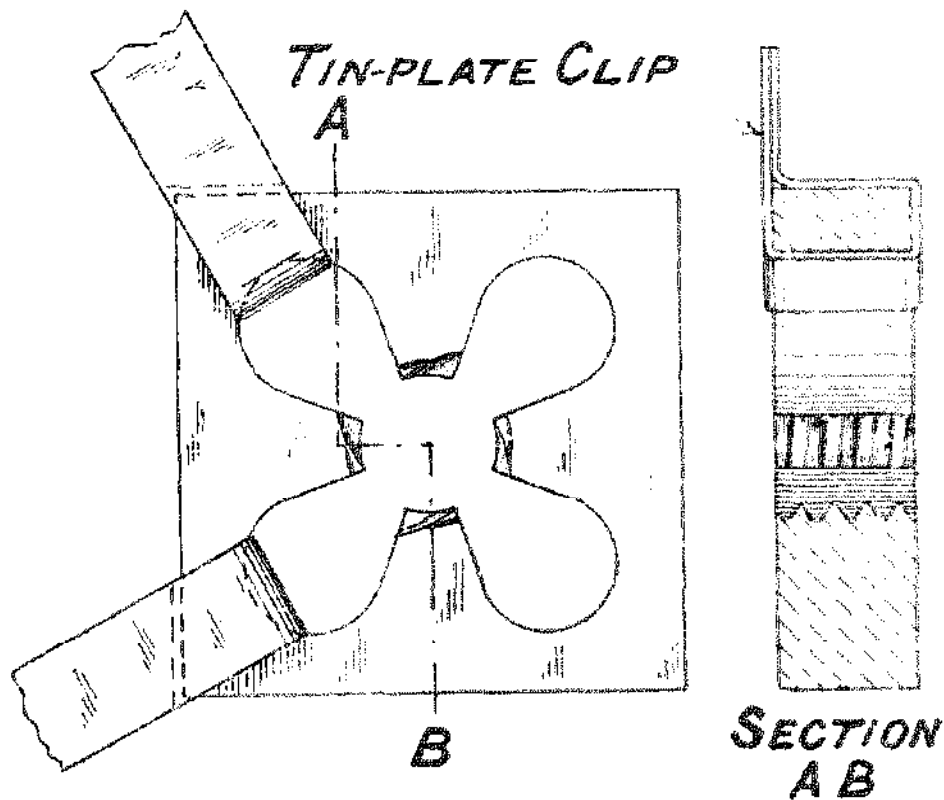

ALL CORNERS PROTECTED

Fig. 25.—A method of protecting parts of a die against too rapid quenching

the extreme corner of the jaws. Do not use pliers unless you keep them for the purpose, because the jaw temper of good pliers will be drawn, with a detrimental effect to them for their general usage. Turn the gas ring fairly low and, keeping the die horizontal and well up in the diffused heat of the burner, move it round and over and over. Watch particularly the temper effect at the cutting edges, which must not be drawn beyond middle straw colour.

In heating dies for hardening, keep the direct flame off the cutting points, as they may easily burn; and if the die is being heated in conjunction with a red-hot plate, do not lay the dies for any length of time directly on the plate, as the cutting points in contact again may be easily overheated and spoiled. In the case of spring dies, it is regular practice

to draw the temper of the thin spring portions of the die to spring temper, or a good blue colour, avoiding the same colour travelling to the cutting edges. A small pointed blow-flame is suitable for this, directed sideways on to the spring portion, and rather outward to avoid diffused heat reaching the edges, which may be further protected by wedging a piece of raw potato in the screw portion. When the blue shows up, and before it can travel, dip the die out. This fairly tricky proceeding is supplementary to the general tempering for the cutting edges. Fig. 26 shows the disposition of the blue on a three-clearance spring die. Another method

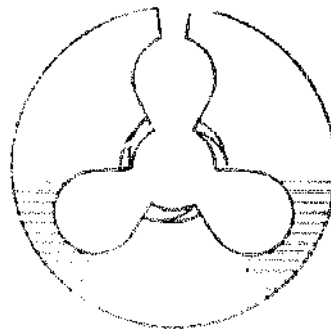

Fig. 26.—Circular die, showing portions to be let down to a blue temper

of local tempering is to apply the tip of a red-hot bar to the point required.

Springs

Springs have to be heated very evenly for hardening, and in all cases should be dipped out in a moderately heavy oil. They are most conveniently hardened by being dropped into a good body of oil rather than held by tongs and moved about in it. Springs are relatively light as compared with tongs, and the quenching is likely to be delayed at the holding point and the resultant hardness varied. In heating them, a muffle furnace is by far the best thing to use, but here of course it is cheaper and less trouble to work in

quantities. A small muffle heated in the body of a smith's forge, however, will do well for evenly heating one spring.

Spiral springs may be similarly heated in a cave or hole in the fire; but in using a blow-flame under such conditions, care must be taken not to keep the flame constantly blowing into the hollow, as the nearer slender portions of the spring may easily be burnt thereby, while its general bulk is not even hot enough for hardening. Flat springs which are fairly short can be evenly heated on a red-hot plate with a blow-flame not concentrated but moved well about over it. When hot enough lift the plate bodily and tip the spring into the oil. Lifting it with tongs, unless they also are red hot, will not do. One way of lifting both springs and dies for dipping is to wire them with light steel wire or enclose them in a cage of wire. By lifting this with a length of wire appended, the whole can be transferred to the oil and swished around in it. Burning such wire (not melting it) does not matter, except that it will not do again, as it will likely be too brittle to bend after the dipping.

Temper of springs is rather important. Light, delicate springs may be tempered to purple tinged with blue, but if they are subjected to much movement they must be tempered further to full blue. Springs for clocks as a rule are tempered to a full blue. Springs for heavy work, such as carriage, motor, and locomotive springs, are tempered beyond the blue and are carried even as high as 620° F., the temper colour sometimes going as far as green-grey opaque, which corresponds to a fairly thick coating of oxide. A furnace of some sort is always used for heavy spring work, and all the hardening and tempering quenching is done in oil.

There is no doubt that a pyrometer-fitted muffle is far the best for tempering small springs of almost any kind; a common method of tempering springs is by "blazing off." Here the question of colour is not studied, but the hardened spring is dipped in ordinary engine oil, and is

gradually lowered into the diffused heat of a Bunsen till the oil not only flashes but ignites. There it is held and turned about until all the oil is burnt off. It is immediately plunged into the oil again, and the process repeated three or four times. Much depends here upon the flash-point of the oil. A safe mineral oil for lubricating has a flash-point of 340°-400° F., and the firing-point, being above the flash-point, carries the work up to well over 400° F. before the oil is fired. In addition, the heat generated by the firing increases the temperature of the spring.

It should be obvious that the spring must not be held over the flame when the oil is consumed, as the temperature will then rise to far too high a point. So long as the spring is covered with burning oil it cannot rise to a temperature destructive to its hardness; but, on the other hand, the more rapidly the blazing processes follow each other, the higher the final temper temperature. Generally speaking, in blazing off springs the knowledge obtained of the behaviour of any one size of spring when blazed off rapidly, four, five, six, or more times is the best guide as to the temper obtained by any particular oil and method of heating in conjunction with a spring of any one size. With ordinary high flash-point engine oil acting with a fine coiled spring, and heating over an ordinary gas ring, four times of blazing in rapid succession is said to be about correct. It should be clear, however, in this connection, that in using a low flash-point oil the process of blazing off would probably be effective only over a large number of repetitions, whereas with a high flash-point grease, say a tallow, once would probably be enough.

Thin Articles

In hardening and tempering thin articles, such as fine circular saws, hack saws, and slitting cutters, trouble often occurs in the metal buckling. A good deal of this buckling can be modified by even heating and even quenching in well stirred water, and quenching in warm or hot water, or oil.

Sometimes it is possible to harden thin steel and keep it true almost by accident. The general method of preventing buckling is to clamp the work between two flat surfaces of thicker metal plate, which add to the bulk of the job as a whole to be quenched, because the clamping plates are also heated. It should be clear that when quenching, say, a thick disc of metal, the unequal action of the quenching which would tend to deform it takes place over the surface, whereas the more even effect produced in the heart of the metal would leave that portion free from distortion. If then, say, an unhardened thin slitting cutter be clamped between two thick plates on a spindle, as indicated in Fig. 27, and the whole evenly heated to above absorption and dipped out, the position of the cutter is such that it gets the most chance of even treatment and will be less likely to buckle. If there is no set to the cutting points, the thin disc can be overlapped by the thicker discs, so that the cutting points are protected from the open fire or flame, and also from the more drastic effect of the quenching. For a saw having a "set" to the points, the protecting discs are better made of larger diameter, but should have a slight rebate turned away so as just to clear the set of the teeth, as indicated in the enlarged section, Fig. 28. It is advisable in this clamping to keep the heating

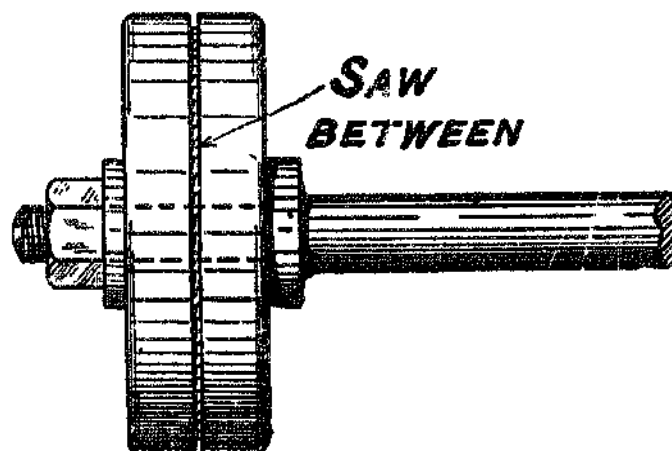

Fig. 27.—Thin saw or cutter mounted between plates to avoid distortion

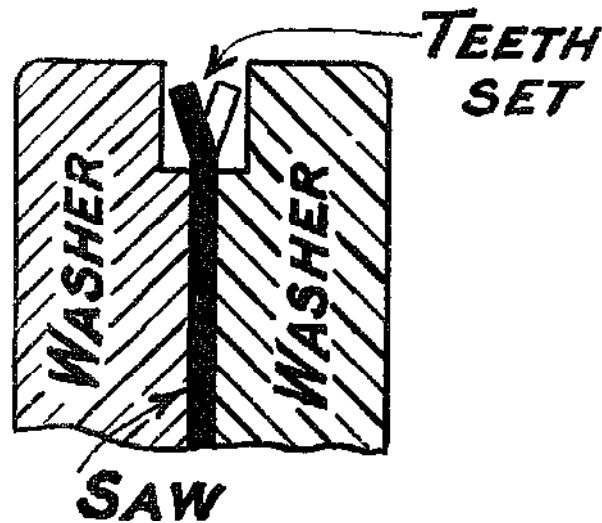

Fig. 28.—Protection of saw teeth by rebated discs

flame or fire from concentrating on the groove where the teeth are, to avoid the risk of burning them. If the discs are made smaller than the root diameter of the saw, so that the teeth are outside, special care must be taken to avoid burning, and the protection against buckling is not nearly so effective. The discs and spindle can be of mild steel, and the discs should be faced truly flat on the inner surfaces.

Where the temper of a saw should be constant throughout, which is better to avoid distortion, the same appliance can be used for tempering, and the temper colour as it shows on the polished surfaces of the outer discs is quite a good guide, but the heating must be constant throughout. Circular saws and cutters, however, can be very well tempered by mounting them, polished after hardening, on an arbor, exactly in the same manner as they will be used, and heating the arbor at both ends and avoiding the saw. Rings of colour then go outward on the saw and a quite good result can be obtained, but the temper is not quite constant, the middle temper being softer. If care is taken, the temper can be checked by rapidly quenching both ends of the arbor first, leaving the saw until it is cooler, and thus avoiding possible distortion. Circular and comparatively thin objects

are better dipped edge-on than flat, but the immersing should not be delayed.

A method by which milling cutters and circular saws can be very well tempered on a hot plate is to interpose a disc of fairly thick steel (which may preferably be rather less in diameter than the cutter or saw) between the tool and the plate. The disc is put on the plate, and the work concentrically on the disc. The plate should not be too hot, or the excess of radiated heat may blue the tooth points before the cutter begins to temper. The idea is that the tempering heat should be conveyed by conduction through the disc to the centre parts of the cutter first, before going directly to the cutting points. The cutter should now and again be turned over. A suitable heated plate for this purpose is a sheet of metal laid on the trivet points of a gas ring, the gas being so regulated, or the plate so large, that it is impossible for the flame to curl round the edges. Should the flame hug the plate in this manner and even directly lick the work on top, the latter will be both unevenly and too quickly tempered. A sheet of copper would obviously answer this purpose—with minimum gas consumption—better than any other metal, but a thick sheet of steel will do well. Tinplate is hardly useful, as, being thin, it is likely to buckle and become unsteady.

There are several methods of tempering tools evenly, examples of which are the oil, lead, and sand baths. Of these the one most likely to be useful to the reader is the sand bath. Here an appreciable depth of dry clean sand is heated in a metal vessel over a fire or gas ring, with the article, previously polished, either on the top of the sand or buried in it. Much depends upon its mass and bulk, but if laid on top it will require turning about frequently. Also, if buried in the sand it can be uncovered now and again in order to study the colour change. In a way this method is very good for even heating, but for a single article it takes a comparatively large amount of heat and time to effect a temper. As

in the case of a furnace, it is better suited for a number of tools, or for a fairly large or important tool like a milling cutter or nicely finished screw-tap, upon which perhaps a good period of time has been spent in the making.

Bluing Screws and Pins

In closing this chapter it would be as well to refer to a method of bluing small steel screws and pins. This is the blue oxide colour aimed at in tempering some articles, but the object of the colour, which may be applied to mild steel articles, is ornament, and also as a protection from rust. The most familiar examples in practice are the blued screws in watches and some clocks. The articles should be finely polished (the finer and cleaner the polish, the better the result), and freed from grease, say by rubbing them thoroughly in a dry cloth with powdered quicklime; they should not be touched by hand. They are then put in a deep fine wire sieve with a handle or, better, in a closed cage, and shaken thoroughly over a gas ring in the diffused heat portion till the right colour shows up. They are then immersed, cage and all, in paraffin, or some thin oil, to stop the oxidation. The more they are shaken and moved relatively, and the cage turned over, the more general or even is the oxide colour. Single screws may be similarly coloured upon a shovel or scoop held over the flame, but the colouring is less likely to be as even as when the screw is enclosed in a cage.

A chemical method is to boil the articles in a solution of hyposulphite of soda, 1 part by weight in $7\frac{1}{2}$ of water, to which is added, in a proportion of 1 in 17, a 100 per cent. solution of acetate of lead.

CHAPTER VI

FORGING LIGHT TOOLS

IN modern workshop practice, hand forging seems rapidly to be becoming a lost art. Whereas such tools as those used in lathe shapers and planers were, at one time, almost exclusively produced by forging, many of these tools are manufactured in a preformed condition, such as the small tool bits and taper-formed parting tool blades, used in specially designed holders.

The ability to carry out light forging operations, however, is a great asset to the individual engineer, whether amateur or professional. There are many machine tool operations which cannot be carried out satisfactorily by the conventional shapes of ready-made tools, and there are also many cases where forging may be employed to produce tools more efficiently and economically than grinding or machining them from stock materials. When a forge or similar means of heating the steel is readily available, it is literally a waste of much of its potential value to use it only for hardening purposes. Most of the forging operations likely to be required can be carried out with a small forge or brazing hearth, such as described in previous chapters. It is recommended that in the case of a brazing hearth it should not be smaller than 12 in. wide by 10 in. back to front inside measurement and, if used on the bench, it should be of sufficient depth to avoid any risk of excessive heat reaching the bench itself. Firebrick cubes or fireclay compound made into cubes about the

Fig. 29.—A simple all-metal forge for tool hardening, and similar light duties

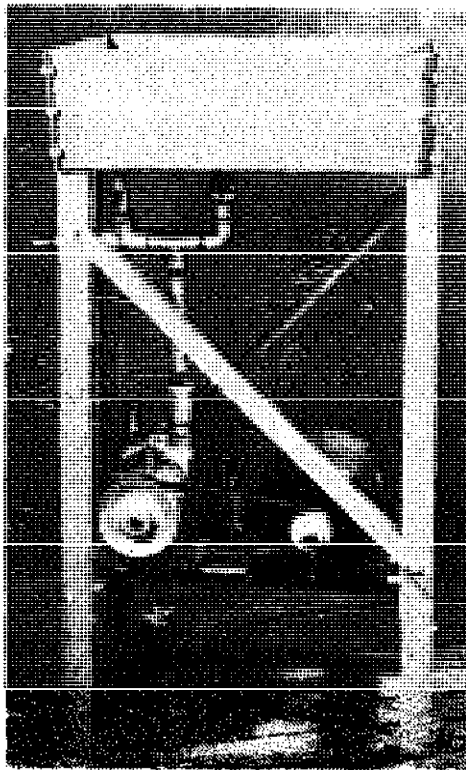
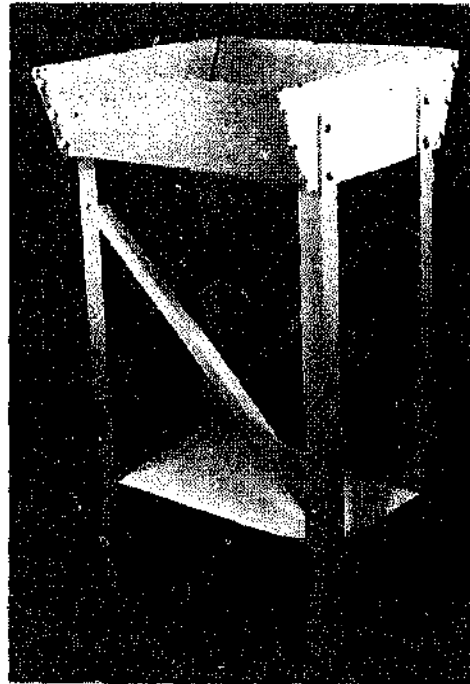

Fig. 30.—Forge fitted with motor - driven blower, and two-way delivery, for use with gas blowpipe or solid fuel (made in the M.E. Workshop)

size of a lump of sugar may be reinforced by broken fire bricks of larger size, sufficient to half fill the pan. Some means of holding the blowpipe or other burner in position and enabling it to be adjusted will be found useful.

For either a forge fire or a blowpipe, a foot bellows or rotary blower can be used, as already described, and it is recommended that flexible metallic tubing should be used to carry both air and gas to the blowpipe.

The only other equipment required for forging is an anvil of a suitable size (a 56-lb. anvil will be quite large enough for the work required); hammers, tongs and hot and cold setts. Hammers are made in various sizes and shapes and for most tool forging, a $2\frac{1}{2}$ -lb. hammer is sufficiently large, except in cases where the assistance of a striker is required. Where available, hammers having ball, cross, and straight peans can be utilised, but a great deal depends on individual preference in the method of handling of these tools. For some light forging operations, hammers as small as $\frac{1}{2}$ lb. may be found useful. Tongs should preferably have handles not less than 14 in. long, and the jaws may with advantage be made of suitable shape to hold the particular sections of metal being forged. For square or rectangular sections, the jaws illustrated in Fig. 31 may be used, while flat materials

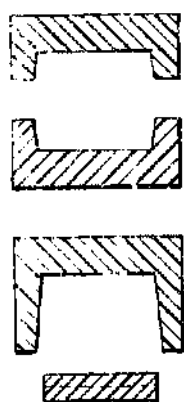

Fig. 31.—Sections of jaws for tongs to hold square or rectangular steel

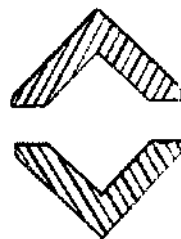

Fig. 32.—Vee jaws for square or round stock

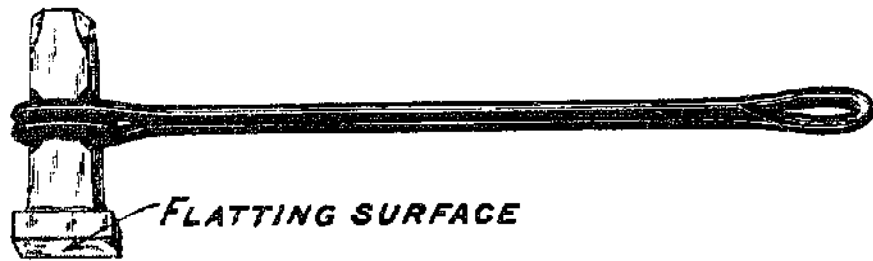

Fig. 33.—Flatter for smoothing surfaces and drawing out

may be best dealt with by using flat or finger jaws. A useful shape of tong jaws for holding either round or square stock is that shown in Fig. 32. The sett hammer or flatter is used for reducing the thickness of work or what is known as halving by blacksmiths, and it can also be used for producing a smooth and even finish on work which has already been hammered to shape. It will obviously require the services of a striker, as the smith must hold the work with tongs in the left hand and the flatter in the right.

Setts and chisels are usually held in handles of light material bent round the grooved portion of the tool. This gives a certain amount of resilience, preventing shocks being conveyed to the hand, and obviously wooden handles directly attached to the tools would not be practicable (Fig. 33).

Cutting setts or chisels are made for cutting either hot or cold metal and are ground with normal chisel points (Fig. 34). In some cases a form of sett made with a rounded end, commonly known as a fuller, is employed for grooving or local reduction of the metal. Setts and chisels should be kept cool as much as possible by being immersed in water, as continual use on hot metal will draw the temper. A wet edge on a chisel also acts to some extent as a lubricant to assist cutting.

Carbon steel should be worked at a bright red heat, but never so hot that a scale forms on the surface. If over-heated, the steel may tend to become crystalline and lose its most valuable properties. Unnecessarily long heating of tool steel will also tend to reduce its carbon content. The work should

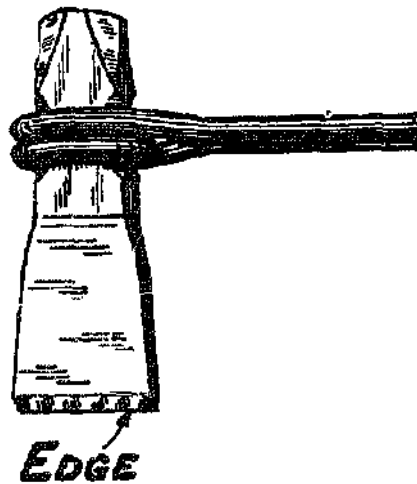

Fig. 34.—Sett or chisel for cutting metal either hot or cold

be transferred quickly from the forge to the anvil so that as little heat is lost as possible.

Tempering modifies the properties of the steel to some extent, tending to increase its toughness or density, but the steel should never be allowed to cool below dull red while forging.

Never on any account hit the metal when only black hot. Many a tool cracked in the hardening owes its faulty nature to the fact that it has been hammered too cold, and the actual instability of the metal is due to its receiving shattering blows after it has lost its red heat. In dealing with cast steel there is not much latitude in respect of heat in which it can be safely forged without risking fracture in the ultimate hardening.

Roughing-out Tool

In dealing with a straight roughing-out tool like Fig. 35, cut a piece from the bar first. This should be done hot with the chisel. Mark it for cutting off with a file nick, heat it to a good red heat around the mark, and transfer it to the anvil, upon which, for safety's sake (when using the chisel) should be placed a piece of sheet scrap copper about $\frac{1}{8}$ in. thick. Then hold the chisel in the nick, and having taken

one blow of the heavy hammer, turn the job round and follow with nicks each side, thus forming a neck. Some smiths would now break it off, although black hot, but it is best to avoid breaking steel at or near black hot, or cold. Reheat it and carry on the cutting, the work being held and rolled to present the different sides until it is about half cut through or a little more. It is not advisable to cut right through, although the chisel edge is protected by the inter-



Fig. 35.—Ordinary roughing-out tool with tapered and rounded point

position of the copper plate from striking the anvil, because the piece will fly off, with a risk of causing fire, or of burning the striker or his clothes. If it is still red hot, it can be knocked off by laying it over the edge of the anvil with the neck just over, and using the hand hammer to knock down, then reversing it and knocking down again, and thus backwards and forwards until it falls off. If black hot, it is better to reheat it before doing this. Of course a tool can be forged from the bar, and cut off after, but the smith is likely to get his wrist jarred badly if, by chance, the work is not fairly on the anvil when hit, whereas with the piece cut off and in tongs the tendency to jar is much reduced.

The first thing to do is to draw the tool down, which can be begun with the hand hammer, and finished with the flatter, the copper plate having been removed. The idea of this is indicated in Fig. 36, where the whole job is being done by the flatter. Slope the sett or flatter, as shown, toward the point, and slightly toward what will be the bottom of the tool, first one side and then the other. The merit of drawing down by the hand hammer is that no striker is required, and a good smith is so expert with the

hammer that he will get a nice flat side. This requires practice, however, and the unskilled smith will get a much better result with the seat-hammer.

The effect of drawing down increases the width of the tool, which should be corrected now and then by using the flatter on them, which will have the effect of drawing the tool out longer. Sometimes, however, where there is room on a slide-rest top, it is better to leave the top set up to reach the lathe centres. Setting up should not be left if in consequence the tool has to be sloped down in use to the level of the lathe centre.

The point of the tool is formed by using the chisel held at an angle, and cutting first one side and then the other. Put the tool, top face downward, on the copper plate, as in Fig. 37, and with the chisel held nearly upright, the cut will

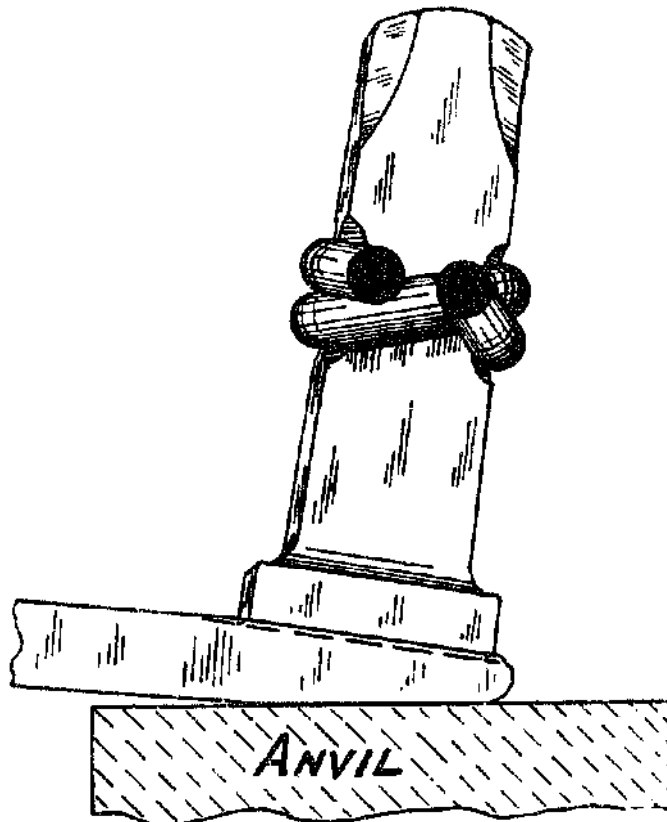

Fig. 36.—Use of the flatter for tapering the point of the tool

go down sloping, thus forming the front clearance. When finally cutting off the chip, take care that it does not fly over the shop, and get lost, as it may easily set fire to something.

After this anneal the tool, and when cold, file it fairly to shape, as to the cutting edges and top rake. It is then hardened and ground to a finished shape while dead hard, and the tempering is the final job.

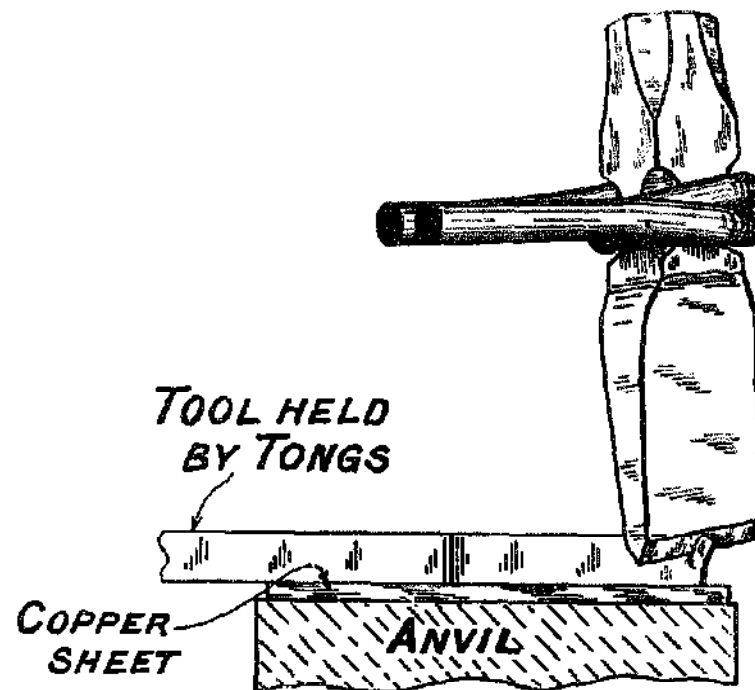

Fig. 37.—Cutting a triangular piece from each corner of the tool

Knife Tool

To make a knife tool, the first operation is to halve the end right off one way—according to whether it is a right- or left-hand cutting tool. This can be done by the flatter, using as high a heat as possible, and giving heavy blows. It is much more rapidly done by a fullering tool, however. A fullering tool is a handled tool like a chisel, but in place of the sharp edge of the chisel, which is along the tool, a blunt rounded edge is used similar to the straight pean

of a hammer. This tool is principally used in drawing down heavy work, and will draw down one side or draw out by working on both sides; but it leaves, of course, a number of ridges, which have to be smoothed out by the flatter. It is moved in parallel lines along the place to be set down, being held across the tool and struck by the heavy hammer.

When this is finished the side-cutting face is offset, slightly towards the top of tool, which has to be done carefully, as in Fig. 38. The flatter will do this, held as shown, but care must be taken not to cut through, and the striker must modify his blows. The effect will be to bend the blade

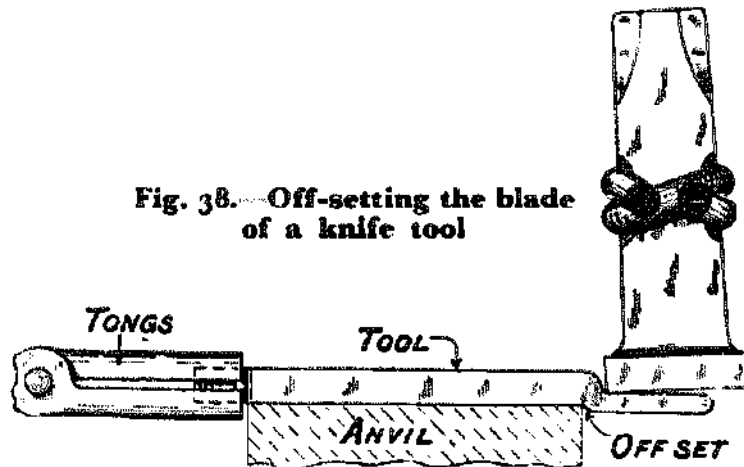

Fig. 38.—Off-setting the blade of a knife tool

of the tool downward, which must be corrected. All this is done with red heat at the shoulder. If allowed to get black hot, and straightened, it will very likely break off. The point face or angular front face of the tool is cut off by the chisel from the back, with the front of the blade down on the copper plate. After this it is annealed, rough filed to shape (including top and side rake angles), hardened, ground, and tempered.

To make a parting tool the same operation is used as for the knife tool. These are usually set over to one side, the left-hand, in order to get close up to faces of chucks. It is not offset, however, and requires rather more filing at the finish, because it is not advisable to draw it down quite so

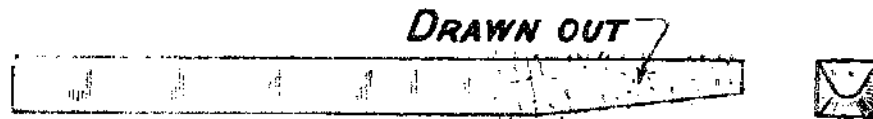

Fig. 39.—Drawing out the bar to form the cranked tool

thin as it should ultimately be. When as thin as this, in the stress of continually heating and hammering, it may easily get overheated. In fact, forming thin work on the anvil is a long job, because when thin it loses its forging heat very quickly, and needs continually heating. In flattening the sides of a parting tool, remember to slope the sides away to the bottom, and also inward towards each other; practically all the clearance can be given by filing.

Cranked Tool

To make a cranked tool, the series of operations shown in Figs. 39 to 42 should be followed. First draw out all four faces at the point, sloping as much as possible the sides towards the bottom, so as to form approximately a triangle with the apex at the bottom. Now make hot a little way back, and bend the tool as shown in Fig. 40—that is, near the point of the beak iron (the beak or horn-shaped projection of the anvil), hitting the work as indicated by the arrows. Next form the reverse bend parallel with the shank, and turn up the end on the extreme point of the beak, as in Fig. 41. The front may be set back by putting it down on the anvil, end on, and striking the top, back end of the shank.

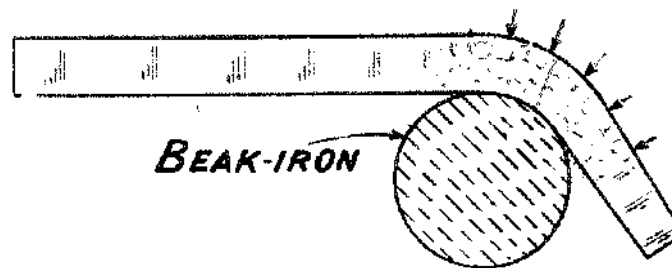

Fig. 40.—Bending down the cranked end

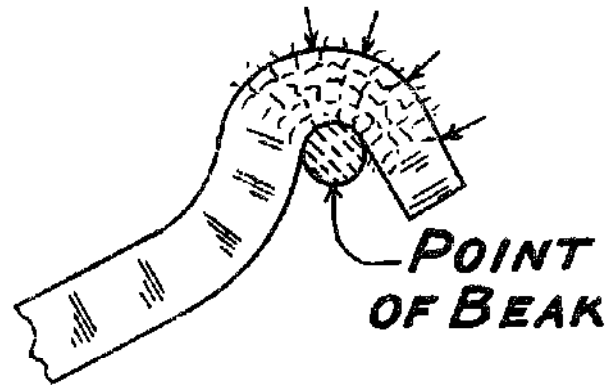

Fig. 41.—Turning up the front to form cutting edge

When making a boring or inside-turning tool, a good deal of skill is required to thin down the front shank of the tool, so as to get it accurate for boring in fairly long and small holes. This front shank is generally cylindrical, not concentric with the square shank, but made eccentric, being flush with the front and top sides and shouldered down from the bottom and back. The easiest thing to do, and probably the quickest for those not experienced in tool forging, is, having decided which is to be the bottom and back, and the length of front shank required, to set the bottom and back faces down approximately the required length and distance. Then round the corners a little, and centre-drill the tool along the front shank axis for turning. The front shank can now be turned between centres either parallel or slightly tapered, larger at the square shank end. If the front shank is not very long, the turning can be done with the square shank in an independent chuck, set eccentric so that the front shank runs as truly as possible. The latter is then turned. Where the chuck turning scores is that there is no centre drilled in it. If a centre is left in the front end, it must be cut right away, as it interferes with the finishing of the tool. To finish the tool, make the point a good red heat, and set it round in the right direction for the cutting edge, by holding it projecting slightly over the back edge of the anvil and knocking it down with the light hand

hammer, using quick, sharp blows. The actual finishing of the edges is done by filing, and, as these tools are comparatively light, this is practically the only way to ensure all proper clearances being put in. In hardening these tools, carry the heat well along the front or round shank, then in tempering, bring this shank mostly to blue when the cutting edge is mid-straw. If this is not done, and the front shank is mostly left soft, it will very likely get set downward when in use. The hardening and blue temper provide a springiness which gives it strength to resist a permanent set.

To draw out cast steel, the use of the hand hammer comes in—using, say, a 1½-lb. hammer upon a bar of ½ in. round steel, for the purpose of drawing down the point to make, say, a centre punch. Heat the steel evenly to a good red along the whole length to be drawn out and a little beyond. Then rapid blows (by the smith himself) upon the root end of the taper, going gradually out to the point and revolving the job on the anvil meanwhile, will draw the steel out quite rapidly. But it must be repeatedly heated, as the drawing down will be very slow at dull red and the steel will most assuredly be shattered if struck continually at black heat.

CHAPTER VII

TREATMENT FOR SPECIAL STEELS

MODERN machine tools in engineering production now use high-speed steels almost exclusively for production work, and these tools may be said to have completely superseded carbon steel for any work on lathes, drills, milling machines, etc., where there is a liability to generate heat in the cutting process.

The term "high speed" steel is generally applied to steels which are capable of being worked at high temperature without becoming softened, and thereby failing to maintain their cutting edge.

The origin of this steel dates back to 1868 when Robert Mushett discovered that by alloying steel with a certain proportion of tungsten, it could be used for specially high duty for which normal carbon steels were unsuitable. The modern forms of high-speed steels contain tungsten, though other elements such as cobalt, vanadium, chromium and titanium are also used in such steels. The proportions of alloying constituents vary to a great extent and, for some classes of work, an intermediate form of tool steel between carbon and high-speed steel, known as low tungsten steel, is sometimes employed.

In view of the wide variations in these steels, the processes involved in forging and hardening them may also vary. In nearly all cases, both forging and hardening require higher temperatures than are used with carbon steel, and they can

be heated almost to white heat without losing their physical properties; but, for hardening, oil quenching is recommended in some cases, while other steels are cooled in an air blast. Where tools have to be dealt with in this way, it is advisable to follow the instructions issued by the makers. High-speed steels are nowadays sold under various trade names, which give no clue as to their composition, and many of them are not intended to be forged or hardened by the user, being supplied in a suitably hardened and tempered condition, and only needing to be ground to the required shape. For reasons of economy, they are generally employed in the form of relatively small and short tool bits, intended to be used in suitable holders. In other cases, short pieces of high-speed steel are welded to shanks of low-carbon steel and these are supplied already forged and ground to shape by the makers.

These examples are of course outside the scope of this book, as it is not at all desirable to attempt any subsequent heat treatment of the tools.

Hardening Procedure

Assuming, however, that it becomes necessary to forge high-speed tools from the stock bar and harden them, the general procedure for doing so is as follows: forging is in all cases far more difficult than in the case of carbon steel owing to the extreme toughness of the metal, and it must be worked at much higher temperatures. Pre-annealing before hardening is also difficult, as the only certain way to anneal it sufficiently for filing or machining purposes is to enclose it in an air-tight box buried in non-conducting material such as asbestos or dry fire clay, making the whole white hot and allowing it to cool in the furnace right down to minimum temperature before removing it from its air-tight enclosure. In hardening, the steel should first be heated slowly through the black hot stage and then more quickly through the incandescent stages until it is almost white hot and the surface scale appears to

be molten. It must now be rapidly cooled either in the air blast or in a cold oil bath. The oils usually employed for quenching are linseed, sperm, or whale oil, but, in modern practice, special mineral or blended oils have been evolved by the oil companies for quenching, and in case of any doubt, their advice should be sought on the most suitable quenching oil for your particular purpose.

Low tungsten steels do not need so high a temperature for hardening and they may be quenched in water, either cold or heated to about 150° F. Hot water is less liable to cause cracking than cold. When heating special steels with an open flame, there is the risk of cold air currents reaching the metal, and these should be avoided as much as possible by surrounding it with a refractory material and excluding draughts. Oxygen may set up superficial oxidation which causes a form of erosion on the cutting edges and may impair their shape. This is obviously very undesirable in such tools as taps, reamers and milling cutters, though it is not usually serious in lathe tools which can readily be reground to shape. However, an enclosed furnace is to be preferred to an open fire or flame in these cases.

Some forms of low or medium tungsten steels may be capable of being tempered by reheating, but, in this case, it is difficult to rely on tempering colours, and it would be necessary to measure the temperatures by a pyrometer, as they may range almost up to dull red. In appropriate cases, tempering may be applied to increase the toughness of the steel enormously.

To determine whether a steel is on the high-speed side, the colour and nature of the sparking which occurs on grinding it is quite a good test. If carbon steel, either hard or soft, be applied to a dry emery-wheel, the sparking is a full red with brilliant scintillations of white-hot intensity. The similar application of high-speed steel produces an even stream of fine sparks of a dull cherry-red, in some strong lights almost imperceptible. Generally speaking, the bright

bluing of a special steel tool in a hardened state, when applied to a dry grinding wheel, has no appreciable ill effect; but, obviously, a greater pressure, producing a pale green, blue, or grey tint, will affect dead-hard special steel, and incandescent heat will indicate that the temper may have altered considerably.

Modern high-speed steels are capable of cutting at extremely high rates and at temperatures up to dull red heat. Surface speeds and feeds can be increased to such an extent that even copious application of a cutting lubricant will not keep down the temperature, and swarf disposal may become quite a problem. There is no doubt that, when used in specially designed machine tools which can stand up to the extra work involved, these steels have a cutting capacity beyond the wildest dreams of the pioneer steel makers, including Bessemer and Mushett. Despite the great advantages of high-speed steel for rapid work, there are some classes of work for which carbon steels can still be recommended.

Machine operators will be quite safe in using high-speed tool bits for operations within their capability, but, for tool making which involves hardening and tempering processes, the beginner will be better advised to stick to carbon steel unless there are very urgent reasons for adopting the special materials.

Cutting Special Steel

One of the most useful forms in which special steel is to be obtained is in light square or rectangular and round bars, ready hardened, such as from 3-16ths in. to 5-16ths in. diameter, or across the flats. In this form it is particularly handy for the general turner, who uses short lengths as cutters in lathe cutter bars, the actual tool edges being shaped by grinding only. The trouble attached to any special heat treatment is therefore obviated, but the question of cutting the bars presents a difficulty rather hard to get over,

because it is obviously unwise to heat the bars for hot-cutting and thus upset their quality of hardness. The general practice is to nick the bar on the corner of an emery-wheel so far through the body of the material as to enable the user to snap it off, either by a blow or by holding the end in the vice and using the bar as a lever. There are three reasons why this is not good practice. First, it is not good for the grinding wheel, because the wheel is more useful with the sharp corners maintained. Secondly, on account of the blunt shape of the wheel corner, quite a broad nick results, thus setting up, in some cases, a wastage of material. Thirdly, and most important, if you do not grind right through, and thus waste more material and wheel shape, you have to snap it cold, which is bad for the working structure of any cast steel, let alone such steel as is already in a highly hardened state.

Fig. 42 shows a little machine expressly designed for cutting off hardened bar steel with minimum waste and

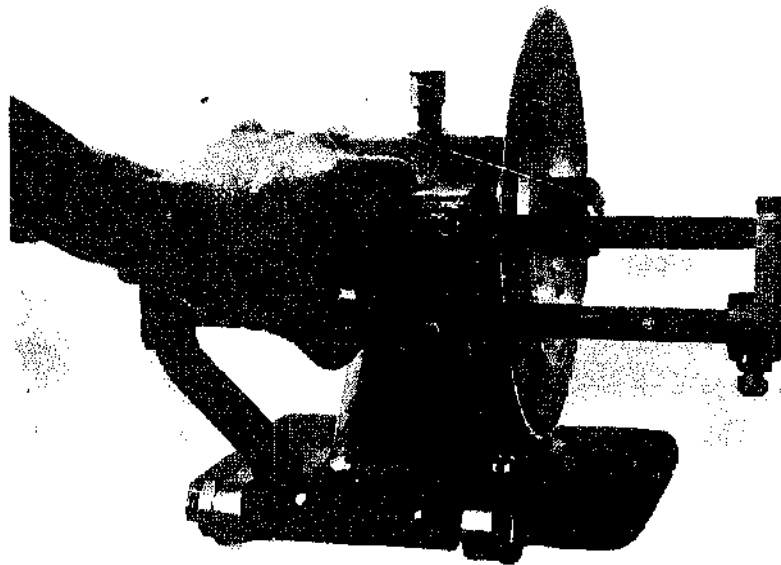

Fig. 42.—Special grinder for cutting off tool steel with a thin elastic-bonded wheel

without in any way altering the nature of the material, provided it is allowed a reasonable time to get through. This machine runs at 3 to 4 thousand revolutions per minute, with a special wheel 8 in. in diameter by 1-32nd in. thick, and will cut through $\frac{3}{8}$ in. square in about a quarter of a minute. The steel is held in a special holder, fed by hand, the holder having an adjustable length gauge for keeping constant length for a number of pieces. The wheel is a high-cutting abrasive of special construction carried by a matrix of rubber compound. Large washers are used on both sides to support the wheel, but the high speed, at which it must run, keeps the wheel edge stiff by centrifugal action. In cutting off tiny pieces, these become rapidly heated, but in dealing with an ordinary length, as of a cutter, the body of the metal dissipates the heat generated. As mentioned before, by easing off the rapid feed, the tendency to overheat can be avoided. The only drawback is that the wheels wear fairly rapidly ; even then the convenience and usefulness of the appliance as a whole more than compensate for the wear.

CHAPTER VIII

CASEHARDENING

As stated in Chapter I, mild steels, that is, those which contain only a very low percentage of carbon or other alloying elements, cannot be hardened by the methods which have been described so far, by quenching or rapid cooling from a red heat. It is, however, possible to produce a superficial hard outer layer on these steels by the process generally known as casehardening or surface carburising. This may be defined as a means of converting the surface layer of the mild steel (or even cast or wrought iron) into carbon steel, so that it can be hardened by quenching, while leaving the inner body of the metal soft and tough. In some respects this is an advantage over solid high carbon steel for making components which have to withstand high stress and fatigue, besides heavy wear or abrasion. The hard surface layer gives the utmost resistance to wear, without the body becoming brittle, and these conditions are favourable for many kinds of mechanical components such as shaft journals, crankpins and other pivot pins, die blocks, gear wheels, etc.

On the other hand, casehardening is not well suited to making cutting tools which have to be sharpened by grinding away. It has, however, been used to a limited extent for special tools which are not designed to be reground, and a combination of high and low carbon steel, known as composite steel, is produced by steel founders for making axes, scythes and similar cutting implements. The process involved in

casehardening may sometimes alter the shape or dimensions of material, so that it is not well suited for use on parts which have been exactly shaped and sized, unless they are left slightly oversize and subsequently be finished by lapping or grinding.

The basic principle involved in casehardening is the absorption of carbon by the action of carbon monoxide formed in the heating of the steel for a more or less prolonged period in contact with substances rich in carbon, such as animal or vegetable charcoal, and protected from the oxidising effect of air. This can be done by packing the metal in a sealed crucible or metal box, containing the carburising material and heating it in a muffle or other furnace which can be controlled to maintain it at red heat for the required time. The metal thus absorbs carbon on the surface, to a depth depending on the time the heating is kept up. It can then be hardened directly by taking it from the box to a quenching tank, or allowed to cool and subsequently re-heated and quenched. The latter is generally preferred, as slow cooling is conducive to releasing internal stresses which may cause distortion or cracking. In other words, it helps to "normalise" the steel.

Box hardening

In industrial practice, box hardening, or pack carburising as it is called, is commonly employed because it is well suited to dealing with articles in quantity and the carburising materials are inexpensive. Cast or wrought iron or fabricated mild or alloy steel boxes of sizes convenient for single articles or batches of them, are used, with lids which can be clamped on and luted with clay. Such materials as charred leather, hoofs, bone dust, freed from grease and moisture, are used to surround the articles, but greater efficiency and uniformity of action is obtained by using specially made carburising compounds. To check the depth of hard layer produced, a common practice is to include in each box a small test piece

which, after hardening, is broken and examined to determine both the penetration of the carbon and the structure of both this and the body of the material. Too low a carburising temperature results in imperfect and irregular penetration, while too high a temperature is liable to produce a coarse structure, with possible surface cracks, and a liability to distortion. There should be no sharp line of demarcation between case and core. A suitable carburising temperature is 900° C., which will give a penetration of approximately 0.0125 in. per hour in ordinary commercial mild steel. Low alloy steels, such as those containing small percentages of nickel, chromium, molybdenum or vanadium, are generally slower in penetration, but have a finer structure and greater toughness of both case and core.

The packing of boxes should be very carefully carried out so that there is a layer of compound about 1 in. deep at top and bottom, and a space of at least $\frac{1}{8}$ in. to $\frac{1}{2}$ in. between each separate metal piece, which must be completely surrounded by and immersed in the compound. Box hardening is quite well suited to use in the small workshop when proper heating facilities are available, but there are simpler methods of producing a hard case of limited depth, which are generally preferred when only a few small articles have to be dealt with.

The "open hearth" method, as its name implies, can be carried out with the aid of an open forge, brazing hearth or blowlamp. They depend on chemical action produced by inorganic substances such as cyanide of potassium or sodium, and yellow prussiate of potash (potassium ferrocyanide). Common salt, sal-ammoniac and bichromate of potash will also produce a thin hard layer, though hardly sufficient to withstand much wear. The cyanides are undoubtedly the most effective, but their use is attended with some risk. They are deadly and rapid poisons if taken internally or be in contact with an open wound or abrasion and when heated, produce fumes which may be harmful if inhaled. Good

ventilation supplemented, by fume extraction equipment where possible, is advised where this chemical is used. As it is of a hygroscopic nature (liable to absorb moisture from the atmosphere) it should be stored in airtight sealed drums, cans or other vessels. The operator should wear protective gloves and a face mask when using it. These precautions cannot be too highly emphasised, and the use of cyanide should only be entrusted to careful, responsible and prudent operators.

The convenience of the cyanide process, however, is often calculated to outweigh the risks for many industrial purposes. It can be heated in a crucible or iron pot over a smith's forge or any other suitable fire, until it fuses at red heat, and the article to be treated is then immersed in it for a sufficient length of time to effect the required depth of penetration. In most cases this does not need to be more than about five minutes. The article is then removed with tongs and quenched in cold water or a special quenching oil. One advantage of the cyanide process is that any scale or oxide formed on the metal strips away on quenching, leaving a clean surface of pleasing appearance. Many proprietary case hardening compounds contain a certain percentage of cyanide. The amount should always be stated on the label of the container, together with the recommended safety precautions. The action of cyanide results in absorption of both carbon and nitrogen in the surface of the steel, giving a high degree of hardness, but its rapid chemical action can, in circumstances, erode the surface, taking off sharp corners and blurring fine details.

The risks attendant on the use of cyanide compounds can be avoided by the use of non-toxic compounds such as Kasenit (Nos. 1 and 2) compounds, manufactured by Kasenit Ltd., Holyrood Street, London, S.E.1. These are also applicable to the open-hearth process, the work being heated to bright red and dipped or rolled in the powdered compound, which will adhere to the surface and form a shell around it

to prevent scaling or oxidation. The article is then re-heated to bright red, and quenched in cold water. If a deeper case is required, the application of powder, and re-heating can be repeated, more than once if required, before quenching. Alternatively, the work may be "soaked" for a more prolonged period, in a tray or box filled with the compound and kept at red heat. The metal must, of course, be handled with tongs or other suitable holding appliances, which must be kept clean and dry. Malleable or cast iron needs to be treated at higher temperature than mild steel. Cast carbon of silver steel may also be treated with Kasenit to give the highest possible hardness and reduce risk of cracking. It should be heated to light yellow and left in the powder till its correct tempering heat is reached, when it is quenched in water. Any articles, after treatment with Kasenit and quenching, may be scoured to remove adherent traces of compound while still wet, leaving a uniform matt grey finish.

There are several other preparations and processes for surface hardening, both by the enclosed furnace and open-hearth methods. The Cassel process, developed by a subsidiary company of Imperial Chemical Industries, is an improved form of cyanide process which gives rapid and uniform penetration. At a temperature of 950°C . the thickness of case produced is 0.05 in. in five minutes, 0.015 in. in 15 minutes and 0.030 in. in 30 minutes. All cavities and crevices are evenly and equally penetrated, and corners or details are not eroded. Another Cassel product, known as "Rapideep," produces a case nearly 0.100 in. deep in a few minutes.

Some of the other special compounds for both box and open-hearth case-hardening entail the need for close temperature control, and do not work equally well with all grades of mild steel. Gas carburising in which the work is heated in an enveloping chamber filled with carbon monoxide, methane, ethane or propane, has advantages over the use of solid or liquid compounds in certain cases, and is being increasingly developed. The gases are usually diluted with nitrogen or

hydrogen to retard breakdown into solid carbon in the form of soot. Penetration of 0.040 in. to 0.050 in. can be obtained in four hours at 980° C., with good control of surface carbon content and gradient.

Nitriding

An important form of gas hardening is that known as nitriding, in which nitrogen is introduced into the surface of steel by heating it to a barely visible red heat (about 530° C.) in a chamber through which a stream of ammonia gas is passed. The treatment is kept up for a relatively long period, 50 to 90 hours according to the grade of steel and the depth of penetration required. Due to the relatively low temperature of the treatment—below the thermal critical range and usual tempering heat—the mechanical properties of the core are not affected and little or no distortion occurs. The case is self-hardening and no quenching is necessary; it will also withstand temperatures at which carbon case-hardening would temper or soften.

Ordinary mild steel reacts to some extent to nitriding, but the best results are obtained with a series of special steels known as Nitralloy. These are low alloy steels containing from 0.9 to 1 per cent of aluminium, besides smaller amounts of carbon and other elements. In addition to hardness after the nitriding process, these steels also resist corrosion to some extent. The advantages of nitriding are somewhat offset by the need for special equipment, time involved in operation, and skilled attention required. It is hardly practicable to carry out this process in a small workshop and it is generally undertaken only by specialists in heat treatment.

Selective Casehardening

Sometimes it is necessary to caseharden the working surfaces of a component while leaving other parts soft. For instance, the main and crankpin journals of a crankshaft should be hard, but the webs are not improved by hardening,

and the liability to distortion and difficulty of re-straightening, may be increased if the component is hardened all over. The thread on the end of a shaft will be too brittle if hardened. Various methods are employed to confine the hardening to the parts of the surface where they are definitely required. These include coating the parts to be left soft with semi-liquid clay paste or packing them in a fireclay sheath. Electro-deposition of copper on these parts is sometimes recommended but this calls not only for special equipment, but also the double process of selective protection, first from electro plating of some surfaces, and then carburising of others.

The method of selective hardening generally favoured in industrial practice for parts which can readily be machined all over is to leave the portions to be left soft well oversize, to an extent greater than the carburising depth. After carburising, but before quenching, these parts are re-machined to remove the outer layer; the component is then re-heated and quenched. While this method may appear wasteful in both time and material, it has the advantage of being entirely positive and reliable. But in work which has already been finished to size, other methods may need to be employed. A plain shaft may be kept out of contact with the carburising compound by means of a tube or sleeve, and a thread may have a nut fitted to it for the same purpose.

A protective material known as Anti Cementite is supplied by Kasenit Ltd., for application to surfaces not required to be carburised. It is applied in the form of a paste and, though it is readily adherent to the steel, is easily removed afterwards; it contains no poisonous ingredients or acids. This preparation is not recommended for use in conjunction with cyanide hardening.

One application of selective hardening is in the internal carburising of sleeves or cylinder liners. In this case, the ends of the component are closed by covers or discs held on by clamps or by a single bolt through the centre. It is then

packed with the carburising compound, and when closed, and luted with clay if required, it is heated for the time required for carburising. In this way the bore surface can be hardened while the outer part is left soft.

It may be observed here that apart from producing a high degree of hardness, carburising can be employed to improve the surface quality of steel and alter its structure in such a way as to increase its resistance to wear, while leaving it soft enough to be machined with normal cutting tools. In this case, quenching from red heat may be omitted entirely, or if carried out, the work may then be tempered or partly annealed by re-heating to appropriate temperature. The propensity of mild steel to "scuff" or score under conditions of heavy load or inadequate lubrication can be considerably reduced in this way; the wearing surface is literally converted to a layer of high carbon steel, which may be of any required hardness to suit the particular conditions of service.

Flame Hardening

This is a method of localised or superficial hardening applicable to large structures or components which cannot readily be heated all over in a furnace or oven. One or more air-gas or oxy-gas burners are applied progressively along the surface of the work, by regulated movement of either the work or the heating unit, to raise the temperature of the metal locally to above the critical hardening point. The heating is immediately followed by quenching by water jets, also applied progressively at the same rate. The process can be adapted to forgings, rolled sections, or castings such as machine tool beds and slides, also to wheel treads, cams, gear teeth, etc. Distortion of the work is kept to the minimum if the process is properly applied but sometimes a follow-up tempering process at about 200° C. is necessary to relieve stresses.

The cast iron or steel to which flame hardening is applied should have a carbon content of 0.35 to 0.70 per cent; with

higher proportion of carbon, special care is necessary to prevent surface cracking. A hard layer varying from $\frac{1}{16}$ in. to $\frac{1}{4}$ in. can be obtained in this way, but it does not constitute casehardening in the accepted sense of the term.

Similar results to flame hardening can be obtained by induction or high frequency electrical heating of the work. These processes call for the use of specialised equipment, but in the long run of quantity production, they not only simplify the hardening operations, but also enable them to be much more controlled than by any other methods.

CHAPTER IX

TUNGSTEN CARBIDE AND SIMILAR HARD ALLOYS

EVEN the hardest high-speed steel is not capable of standing up to some of the extreme duties called for in modern engineering production, and special hard alloys have been evolved which are second only to a diamond in hardness. The best known of these is tungsten carbide which, as its name implies, is an alloy of tungsten and carbon, and this material is manufactured under various trade names, such as *Wimet*, *Ardoloy*, *Cutanit*, etc., and in a variety of grades to suit cutting operations on various materials.

A somewhat similar material, known as *Stellite*, consists primarily of cobalt with the addition of tungsten and chromium. These and other "synthetic" alloys are generally used in the form of small tips attached by brazing or welding to carbon steel shanks. The reason for this is that, in addition to being very expensive, they have a low tensile strength which makes it necessary to support them and back them up with softer but tougher material. The tips are available in a wide variety of shapes and sizes which could be applied to tools for all kinds of operations, including milling cutters, drills, and counterbores.

The method most commonly employed to attach tungsten carbide and *Stellite* tips to the shanks is by copper brazing, though the latter material can also be welded or built up in molten form on the supporting metal by means of the oxy-acetylene blowpipe. The brazing method, however, is

most suitable for use in the small workshop and is carried out as follows: having selected the tip most suitable for the particular tool to be made, a seating is filed or machined to fit it fairly closely in the shank of low or medium carbon steel. At the same time it is advisable to shape the end of the support to the same profile as the tip and to back it off at the appropriate angle. The shank is then laid on a flat firebrick or a sheet of asbestos and a thin copper shaving or strip of copper foil interposed between the tip and the seating, together with a pinch of borax or other brazing flux. The assembly is then heated by a blowpipe until the copper fuses, when the tip may be pressed firmly into its seating by a steel rod and moved slightly sideways with another rod to ensure that the molten copper is evenly spread and the excess squeezed out. It is then allowed to cool naturally, preferably covered with powdered carbon or ashes to protect it from oxidation.

To facilitate the brazing operation, special strips of corrugated copper foil are supplied by the makers of the tips. It is also possible to braze them with a special grade of Sifbronze which is used with a special flux. An alternative method recommended for fixing Stellite tips is to pre-coat or "tin" both the tip and the seating with Stellite bronze, and apply the tip as described before, while this is in the molten state.

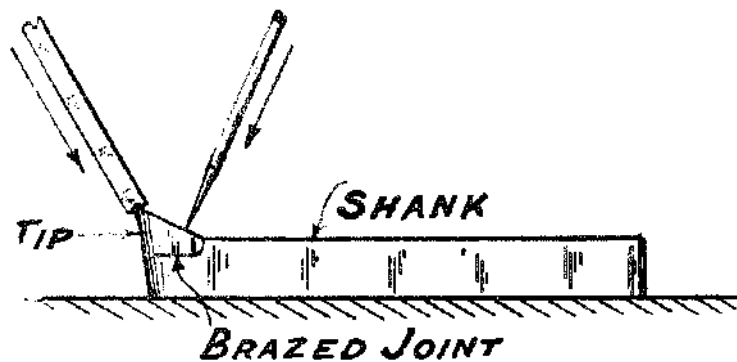

Fig. 43.—Method of inseting and brazing in a tungsten carbide tip

When cold, the excess brazing metal and flux are trimmed off by filing and the tool ground to shape. It is possible to grind Stellite, though not very easily, on an ordinary carborundum or aloxite wheel, but tungsten carbide demands a special wheel, and, for maximum cutting efficiency, these tools should finally be lapped on a cast-iron wheel charged with diamond dust to produce the highest possible finish.

On account of their low tensile strength, hard alloy tools should not be ground with excessive clearance angles, as this weakens them and increases the liability to crumbling and chipping. For the same reasons, large top rake angles should be avoided and for heavy production, negative rake is often recommended. This, however, is only practicable on very rigid and powerful machine tools. For general purposes in the small workshop, tools having about 5° or 6° front clearance and not more than 5° top rake will be found suitable.

Even harder materials than tungsten carbide are sometimes called for, such as ceramic tips (the basis of which is silicon, or oxides of aluminium or magnesium) and synthetic sapphires or diamonds. These, however, are outside the scope of this book and largely outside that of the jobbing workshop as well. In fact, none of the "super" cutting alloys can be utilised to their full advantage in small individual workshops, but they can be very useful in certain cases, such as taking the skin off hard castings or dealing with chilled spots. They do not take kindly to shock or impact, and care should be taken when using them on interrupted cuts for this reason.

Overloading or shock with tipped tools may cause fracture, local chipping or cratering, any of which will destroy the cutting edge, and if the fault cannot be ground away, will call for re-tipping. In common with other tools, they will only do their work efficiently when kept keen, but, so long as they are used within their capacity, they will maintain their edge many times longer than any other kind of tool.

CHAPTER X

SMALL GAS AND ELECTRIC FURNACES

ALTHOUGH, as explained in previous chapters, most of the work in hardening and tempering can be carried out by means of the forge or open flame heating, the advantages of small gas or electric furnaces should not be overlooked, even for use in the small workshop, and, in any kind of industrial work, they are almost a necessity. They enable temperatures to be accurately controlled and, in addition, their enclosure helps to protect the steel against draughts and oxidation.

Several firms specialize in the production of these furnaces, which are made in a wide variety of types and sizes, but, for the purposes of this book, only the smaller sizes are described.

Gas furnaces for town mains gas, using both natural and forced air supply, are manufactured by Brayshaw Furnaces Ltd., Belle Vue Works, Manchester 12. The size No. 1241, illustrated in Fig. 44, is supplied either with or without stand. It operates from $\frac{1}{2}$ in. gas mains and has a maximum gas consumption rating of 100 cu. ft. per hour, though normal consumption when working steadily at 650° to 950° C. is from 30 to 65 ft. per hour. The maximum dimensions are 1 ft. $7\frac{1}{2}$ in. from back to front, 2 ft. $5\frac{1}{4}$ in. overall height and 1 ft. $9\frac{1}{2}$ in. overall width.

The size 51 furnace for forced draught is shown in Fig. 45, complete with the motor-driven fan unit. The working air

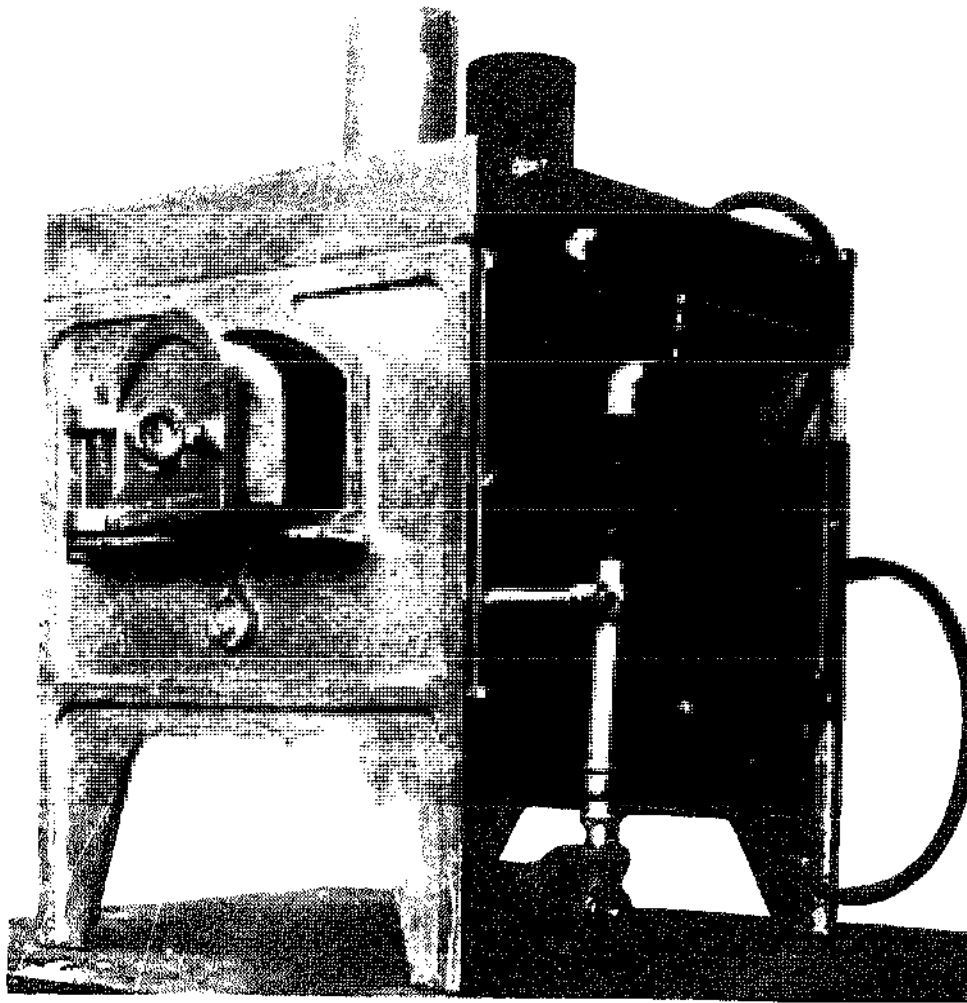

Fig. 44. A natural draught gas furnace by Brayshaw Furnaces Ltd.

pressure is 18 in. water gauge and it is capable of operating in the temperature range of 1,200-1,400° C. Two chambers are contained in this furnace for pre-heating and high temperature; the internal dimensions of each being 7 in. wide by 4 in. high by 5 in. depth from back to front.

The same firm manufactures hot plates for tempering small tools, dies, springs, etc. The size 1, illustrated in Fig. 46, is 6 in. wide by 18 in. long and is fired by three gas burners, each capable of individual control. They may be used either singly or in combination, according to the temperature required.

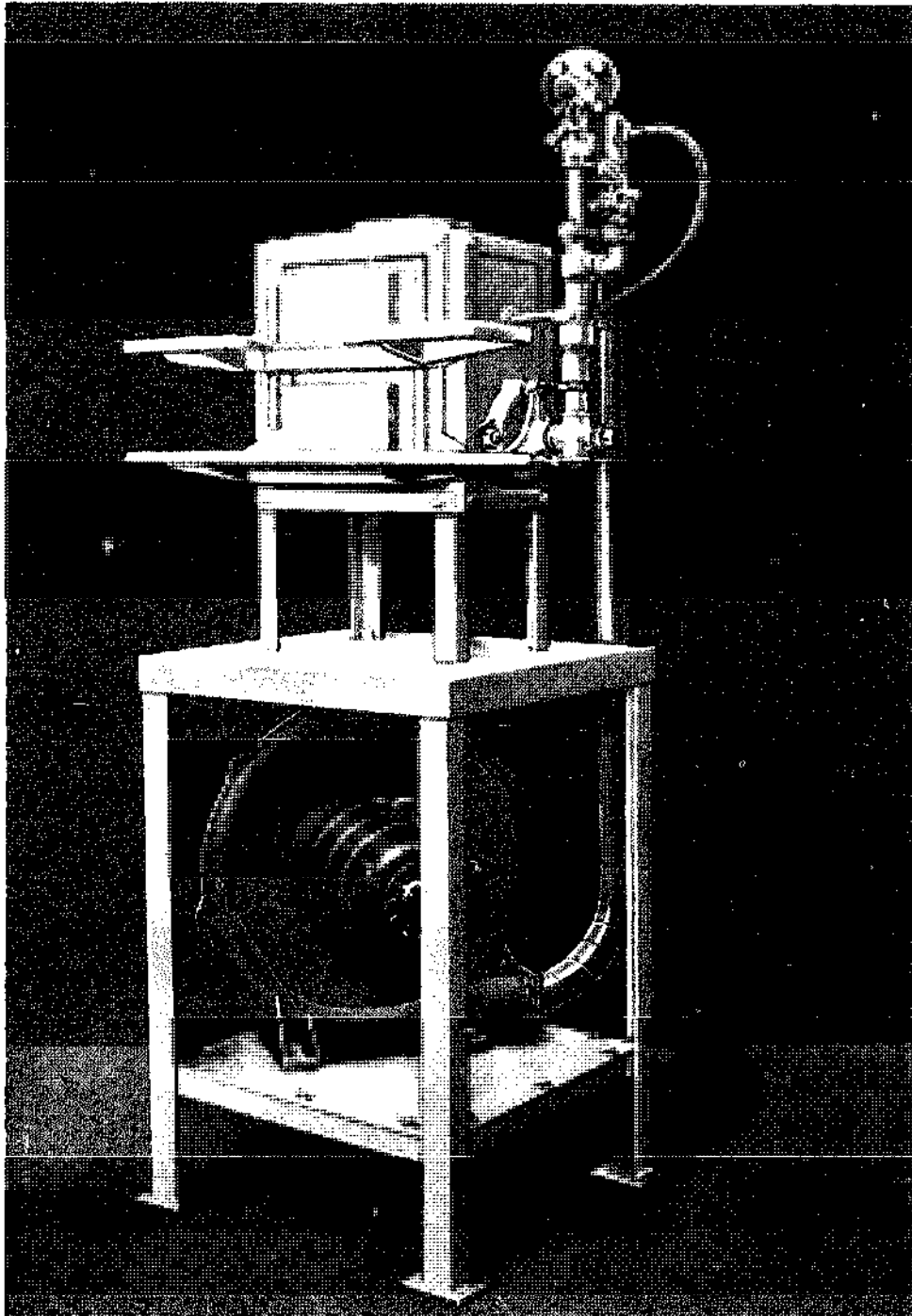

Fig. 45. Furnace for gas heating with forced draught, complete with motor-driven fan unit

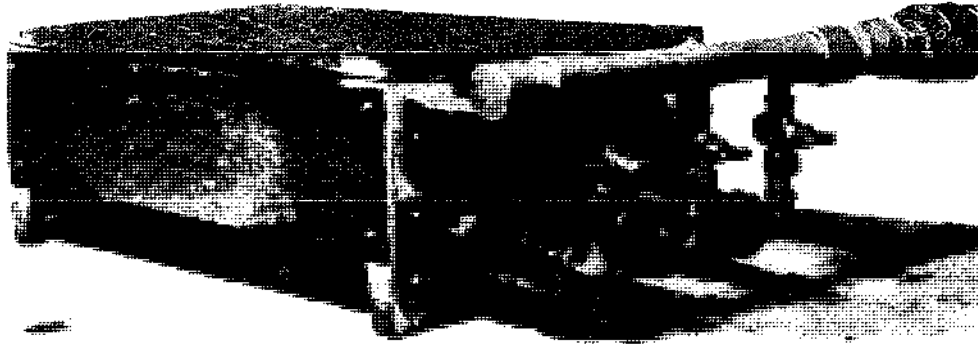

Fig. 46.—Gas heated hotplate for tempering by Brayshaw Furnaces Ltd.

A.E.W. Ltd., Walworth Industrial Estate, Andover, Hants. manufacture electric furnaces for workshop use, and the smallest of these, model L.1, is illustrated in Fig. 47. This has an electrical loading of 1.5 kw. and produces a maximum working temperature of 1,000° C., which it reaches in one hour from cold. The chamber size is 6 in. wide \times 2 in. high \times 6 in. deep, and overall dimensions are 1 ft. 4½ in. wide \times 1 ft. 4½ in. high \times 1 ft. 6 in. deep from back to front. It is supplied complete with switch and temperature regulator as shown, and a pyrometer may be supplied as an extra fitting.

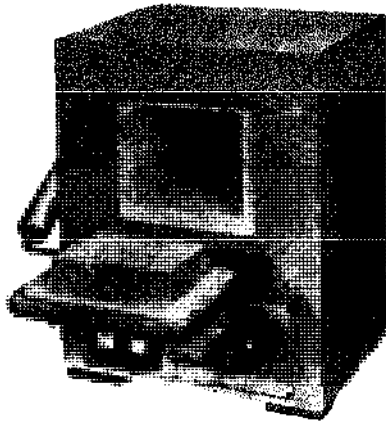

Fig. 48.—A Galenkamp 1.5 kw. electric furnace

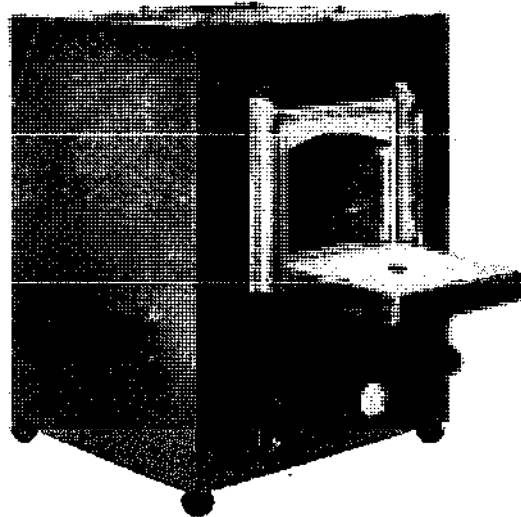

Fig. 47.—A.E.W. 1.5 kw. electric furnace

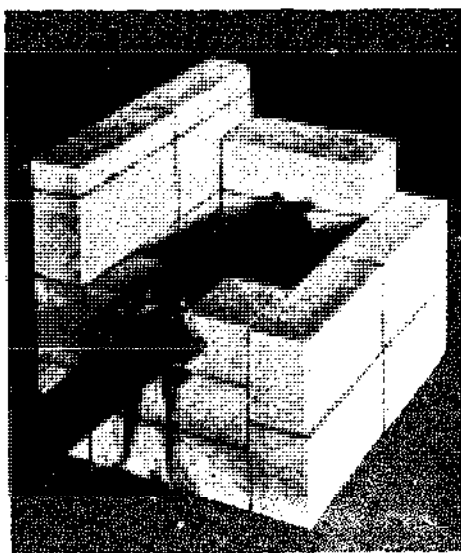

Fig. 49.—A partly constructed electric furnace made from components by Morganite Crucible and utilising Crusilite heating elements

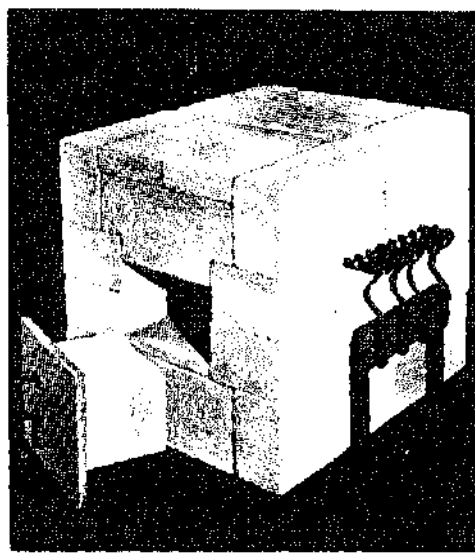

Fig. 50.—A larger furnace built from Morganite components

The "Super Hotspot" furnace by Gallenkamp & Co. Ltd., Technico House, Christopher Street, London, E.C.2, has a maximum power rating of 1,500 watts and produces a maximum temperature of 1,100° C. Its overall size is 15½ in. high × 14 in. wide × 12 in. deep, and internal dimensions are 4 in. high × 5 in. wide × 6 in. deep. This furnace is supplied complete with temperature regulator and thermo-pyrometer of the thermocouple type; also an indicator lamp and a fuse to protect the winding against accidental overheating (Fig. 48).

For those who wish to construct an electrical furnace for themselves, it is possible to obtain the necessary components for the purpose at relatively low cost, and one advantage of this method is that it is possible to construct the shape and size of furnace most suitable for the work to be undertaken.

An example of an experimental tube furnace, made from components supplied by the Morganite Crucible Ltd., Woodbury Lane, Norton, Worcs., is illustrated in Fig. 49, and a larger chamber furnace, having a wall space of 9 in. ×

6 in. \times 4 in., is shown in Fig. 50. The smaller furnace is suitable for dealing with single tools and may be found adequate for many purposes in the small workshop. In both cases, temperatures up to 1,400° C. are obtainable, and the heat is produced by Morganite Crucilite elements, four in number in the former case, and eight in the latter.

It is, however, possible to vary the size of furnace and the number of elements as required for particular purposes.

The refractory bricks in the furnace casing are also supplied by the Morganite Crucible Ltd. and they can be cut and drilled as required. Crucilite elements are made in the form of silicon carbide tubes in one piece, slotted to form a double spiral and, in this way, they eliminate relatively fragile wires

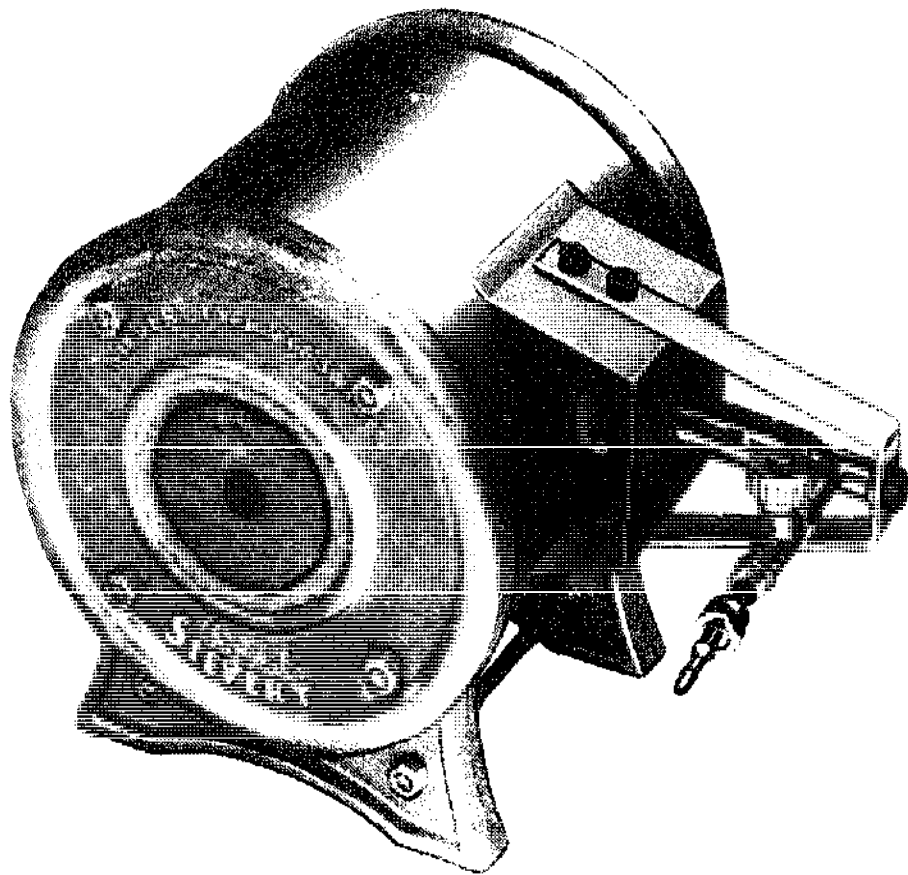

Fig. 51.—A small furnace by Sievert, heated by bottled gas

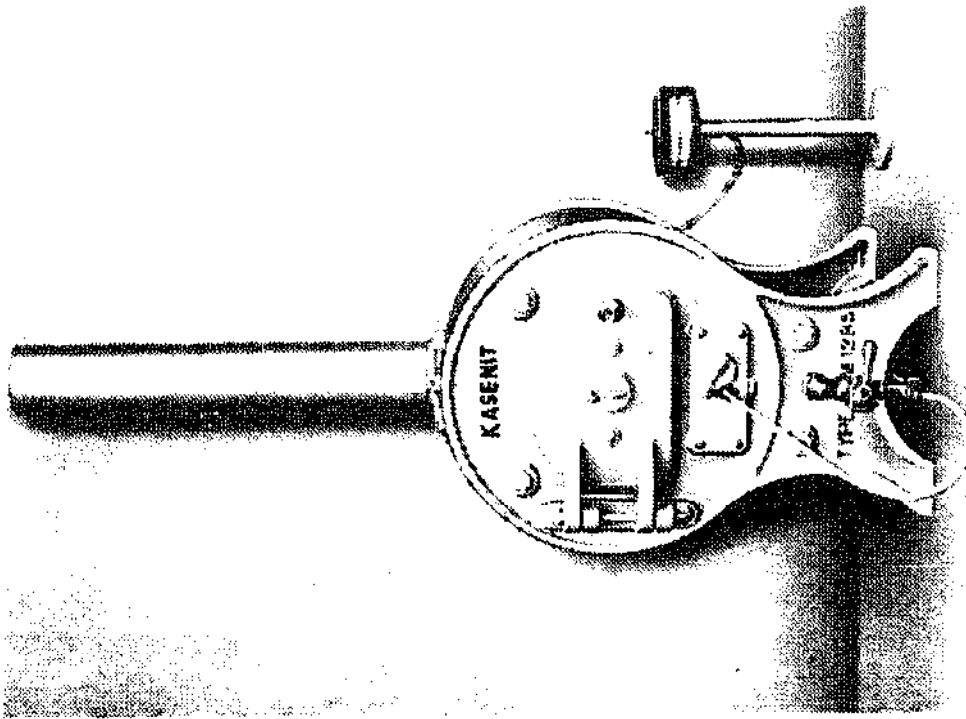

Fig. 52. Kasenit natural-draught gas-fired muffle furnace.

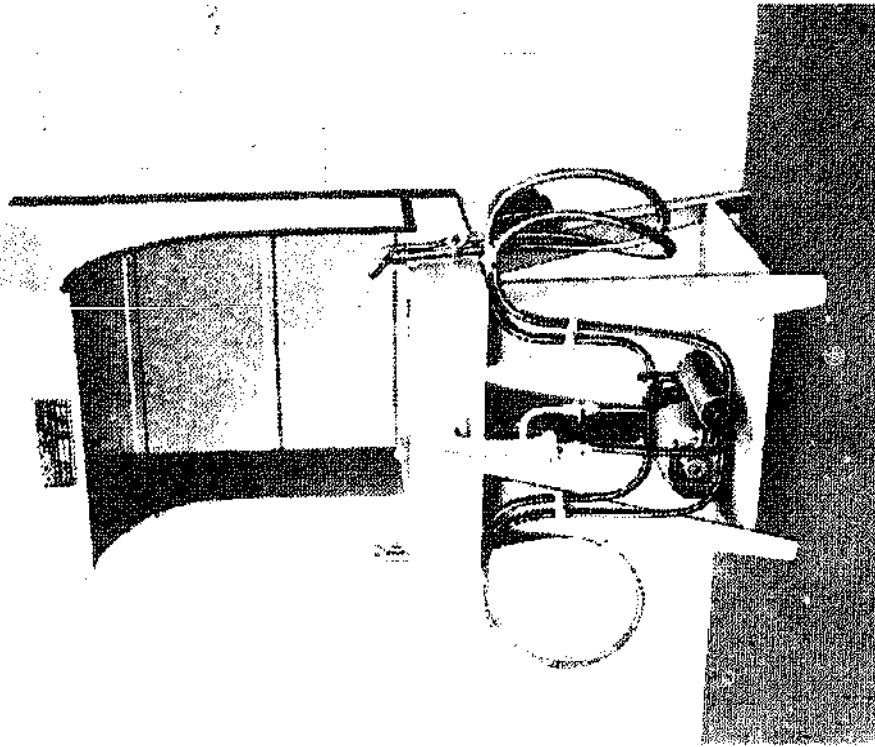

Fig. 53. Kasenit combined forge and brazing hearth.
Photos Kasenit Ltd

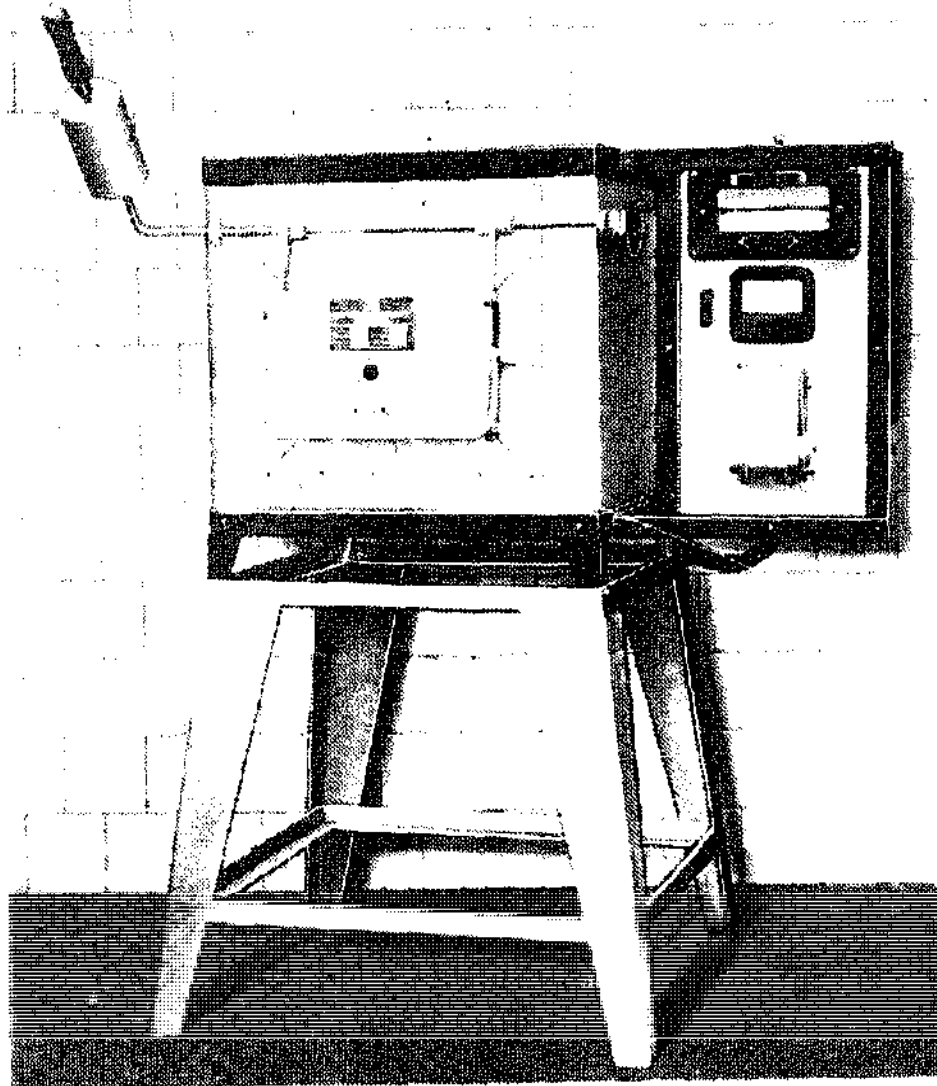

Fig. 54. Kasenit electric oven furnace.
(Photo Kasenit Ltd.)

and the difficulties involved in connecting them to the external conductors, as the terminals or caps are permanently attached to the tubes. Normally the terminals are at opposite ends of the tube, but, where required, they can be made with the two terminals located at the same end.

A hardening and melting furnace for use with bottled gas is manufactured by Sievert and supplied by Wm. A. Meyer Ltd., 9-11, Gleneldon Road, London, S.W.16. This is illustrated in Fig. 51.

It is also possible to heat small muffle furnaces by means of paraffin blowlamps or other forms of oil burners, but, so far as is known, no ready-made furnaces of this type are available in a size suited to the small workshop.

ELECTRO-PLATING FOR THE AMATEUR

L. Warburton

The subject is adequately covered and deals with equipment needed for home working, current supply, plating tank, preparation of the base, electrolytes, chromium plating, plating of non-conductors and electro forming, anodising.

7½ × 4½ in. (184 × 121 mm.) 106 pages.

Paperback. 26 line drawings.

0 85344 056 5

WELDING AND CUTTING

J. A. Oates

A practical handbook describing the welding and cutting of metals by the oxy-acetylene and metallic arc processes. Chapters include: Prevention of Distortion; Gas Welding Equipment; Gas Welding techniques; Gas Welding Various Metals; Flame cutting methods; Types of Electric Arc Welding; Equipment for Metallic Arc Welding; Procedure and Techniques.

7½ × 4½ in. (184 × 121 mm.) Paperback.

44 line drawings.

0 85344 074 8

FOUNDRYWORK FOR THE AMATEUR

B. T. Aspin

A really exhaustive book on mould and pattern making, and pouring metals to produce castings for model making or other purposes. Author's easy style and drawings take the novice easily through all stages. Today when small casting and moulding works are hard to find, a degree of independence is highly desirable.

7½ × 4½ in. (184 × 121 mm.) 108 pages.

Paperback. 12 photo-illustrations.

94 line drawings.

0 85344 105 7

ISBN 0 85344 0549

Argus Books Ltd.

£1.95 Nett

U.K. only