

AT MICROFICHE
REFERENCE
LIBRARY

A project of Volunteers in Asia

Soil Block Presses

by Kiran Mukerji

Published by:

German Appropriate Technology Exchange (GATE)
Dag-Hammarskjöld-Weq 1
6236 Eschborn
FEDERAL REPUBLIC OF GERMANY

Available from:

same as above

Reproduced by permission.

Reproduction of this microfiche document in any form is subject to the same restrictions as those of the original document.

Kiran Mukerji

Soil Block Presses



SOIL BLOCK PRESSES

Report on a Global Survey

Prepared on behalf of



German Appropriate Technology Exchange
Dag-Hammarskjöld-Weg 1, 6236 Eschborn
Tel: 06196-79-2443 Tx: 41523-0 gtz d

by:

Dipl.Ing. Kiran Mukerji
Planning and Building in the Tropics
Wittelsbacherstraße 14
8130 Starnberg
Tel. 08151 / 14684

CONTENTS

1.	INTRODUCTION	1
2.	PREPARING THIS REPORT	2
2.1	Bibliographical Research	2
2.2	Correspondence	2
2.3	Personal Contacts	2
2.4	General	2
3.	RESULTS OF THE STUDY	5
3.1	Notes on Some Institutions	5
3.1.1	GATE, Eschborn	5
3.1.2	IRB, Stuttgart	5
3.1.3	DESWOS, Köln	6
3.1.4	Gesamthochschule Kassel	6
3.1.5	Institut Lehmbau, Weil-Beuerbach	6
3.1.6	AVM, Rüsselsheim	6
3.1.7	ITDG, London and Rugby	6
3.1.8	Building Research Station, Garston	9
3.1.9	GRET, Paris	9
3.1.10	CRATerre, Eybens (Grenoble)	9
3.1.11	Centre de Terre, Lavalette (Toulouse)	10
3.1.12	SKAT, St. Gall	11
3.1.13	ETH-Hönggerberg, Zürich	11
3.1.14	IFEC, Washington, D.C.	11
3.1.15	AT International, Washington, D.C.	11
3.1.16	CTA, Asunción	12
3.1.17	ADAUA, Ouagadougou	12
3.1.18	UST, Kumasi	12
3.1.19	HRDU, Nairobi	12
3.1.20	CBRI, Roorkee	14
3.1.21	ASTRA, Bangalore	14
3.2	Summary of Soil Block Presses	15
3.2.1	Currently available presses, with details in Annex A.	16
3.2.2	Currently available presses, without further details	20
3.2.3	Industrial - factory based - plants	21
3.2.4	Soil block presses, which are not being produced anymore	21
3.3	Soil Block Presses - Past and Present	37
3.3.1	Building with earth	37
3.3.2	Development of soil block presses	37
3.3.3	General aspects of producing compressed soil blocks	38
	ANNEXES	41
	A. Soil Block Presses	41
	B. Addresses	121
	C. Bibliography	127
	D. Reply Form	129

INTRODUCTION

During the past 5 - 10 years, there has been a rapid increase of interest in soil construction technologies in most parts of the world - particularly in developing countries. Consequently, the various appropriate technology (AT) information centres, including GATE, have been receiving a growing number of requests for information on this subject. Within this field, an area of special interest has been the production of compressed soil blocks, directly on the building site.

Most AT organizations and research institutions dealing with soil technologies have a collection of information on soil block presses, but it appears that no comprehensive study on these machines exists so far. Thus, it is largely a matter of chance, whether or not the required information on soil block presses can be provided by the institution asked.

In order to achieve more clarity on this issue, GATE decided to conduct a global survey of easily transportable or mobile soil block presses. The aim is to prepare a document, which will be distributed to AT and research institutions around the world, or sent upon request to interested parties in developing countries and all those involved in development activities.

This report represents a first stage of the survey. It was prepared by evaluating all the literature in the GATE library and those of a few other institutions in Europe. Additional material was accumulated through extensive correspondence with institutions and manufacturers of block presses, in various countries. The result of this work, documented in this report, constitutes the basis for the final publication, which, hopefully, will be more complete and up-to-date. This document is, therefore, being circulated to all the addresses listed in Annex B (and to a limited number of institutions on request), with a view to receiving comments and further information, which could be of use in preparing the final publication. In connection with this, GATE kindly requests all correspondence to be conducted directly with the author, whose address is given on the title page.

It is hoped that the information given in this study, will help to activate further interest in soil construction technology and provide potential builders with the means of finding the most appropriate blockmaking machine. As far as possible, all sources of information and addresses have been given, and cross-references have been made in the text and charts, wherever appropriate, so that anyone can carry out further investigations, if necessary.

Several recipients of this report have either directly or indirectly contributed literature, illustrative material, comments and the like, for which the author wishes to express his sincere thanks. Without this interchange of information and ideas, no reasonable work can be done on a project of this kind. The preparation of this document must, therefore, be viewed as a joint international effort, from which, hopefully, a great many people will benefit - most of all, the local house-builder, who is thus able to find the most appropriate soil block press.



Town hall on the Isle of Mayotte, built with stabilized soil blocks,
by CRATerre, Grenoble.

Photo : Jürgen Schneider (Bibl. 54)

PREPARING THIS REPORT

The main object of this study was to collect information. This was implemented by three means:

- bibliographical research,
- extensive correspondence,
- personal visits to institutions, block press manufacturers and experts in Germany, England and Switzerland.

The work was carried out in the course of four months, which is a relatively short period for a global survey. Nevertheless, with the encouraging response, that was received from all sides, it was possible to collect a great deal more material, than was originally expected.

2.1 Bibliographical Research

A fairly intensive study of all available literature on soil construction and related appropriate technologies was necessary, in order to find out, where requests for information would be most effective. This required visits to the libraries of universities, information centres, research and development organizations, as well as to AT institutions. As was expected, this last group had the most useful literature to offer. Visits to bookshops and the author's own collection of literature provided further sources of information.

Studying the better-known standard literature on soil construction, one tends to get the impression that there are only about 15 - 20 types of soil block presses. However, conference proceedings, AT journals, bulletins from research institutions, and similar publications, which are not usually easy to get, brought to light quite a few more types of machines. But, in most cases, the information on them was insufficient, so that contacts with the developer or manufacturer were necessary, in order to obtain more details.

2.2 Correspondence

Well over 100 letters, requesting information, were sent out to AT institutions, research and development organizations and manufacturers of soil block presses, throughout the world. The addresses were mainly selected on the basis of references found in the literature studied. Further addresses ensued from several replies, so that writing letters became a major feature of the project and is still continuing, while this report is being written.

Two requirements needed to be fulfilled: firstly, to achieve a high rate of response, and secondly, to receive the replies in time to incorporate them into the report.

In order to generate a greater interest in the survey, and consequently more readiness to reply, the letters were written on the following basis:

- As far as possible, each letter was written individually, taking into account the spe-

cial activities, experiences, publications, products of the addressee. Many years of experience have shown that circular letters or general questionnaires usually tend to remain unanswered - for understandable reasons.

- Each request for information was accompanied by a short explanatory note from GATE, in order to underline the official nature of the survey.

- Since no help should be expected without an adequate reciprocation, the author offered to be of assistance, in any way desired, in return for information and comments received. The refund of any costs incurred, was also offered. And, in various cases, these offers were accepted.

The problem of receiving replies in time to evaluate the information and use it for the report, was not solved, although the requests indicated the urgency. The overall response was about 50 %, while replies from European countries exceeded 60 %, those from North and South America were in the region of 40 %, and those from Africa, Asia and Oceania remained below 30 %. Nevertheless, most of the replies contained valuable information and have thus helped to complete this fairly comprehensive study.

Correspondence will hopefully continue on account of the interest that this document is expected to generate. Readers are requested to send any appropriate information, comments or criticisms to the author's address, as these will help to compile a more complete and useful study in the final stage.

2.3 Personal Contacts

As far as the financial resources and limited time permitted, every opportunity was taken to speak to experts, either by telephone calls or personal visits. No other means of communication can be more effective, as it not only helps to break the barriers of anonymity, which allows a freer exchange of views, but also saves a great deal of time, since it avoids lengthy correspondence, by receiving answers to questions immediately. In the case of personal visits, processes and equipment can be demonstrated, photographs can be taken and useful literature or samples of material can be handed over.

2.4 General

Since the collection of material largely depended on what happened to be available in libraries, or what was sent in response to the author's requests, as also on manufacturer's pamphlets and personal views of experts, a value judgement of the soil block presses, mentioned in this study, was not permissible. Thus, the summary of soil block presses (Section 3.2) contains all the types of machines, that were identified so far, even if great similarities may be noted amongst some of them. However, in most cases, it is just the technical principle that is the same, while the technical details can

differ substantially, according to certain specific local requirements and individual ideas of the respective designers.

It is, therefore, extremely useful to include machines that resemble each other, and to point out, in which way they actually differ. This gives those, who propose to buy or construct a press of their own, a means to find the most appropriate design for their particular needs. It also helps them to find the supplier located closest to them, so that the costs of transportation can be kept as low as possible.

In the proposed final GATE document on soil block presses, which will incorporate all the responses generated by this report, the aim will be to provide the information and technical data, according to a uniform system, such that comparisons will be possible, to a certain extent, and a reasonable value judgement can be made, according to the reader's own criteria.

Prior to this final study, however, GATE is considering preparing information leaflets (called "Product Information : Soil Block Presses", an example of which is shown on pages 42-43) on a few selected machines that have been tested in the field and found worthy of further recommendation. Therefore, personal opinions, positive or negative experiences in the use of soil block presses will be greatly valued. The reply form at the end of this report can be used for this purpose, or any other appropriate form of communication.

RESULTS OF THE STUDY

3

3.1 Notes on Some Institutions

As mentioned in the previous section, several institutions throughout the world were identified and contacted, although not all of them responded, or were able to contribute towards the preparation of this report. Some of them, however, are of special interest in the context of this study, which is why a few comments and general information on them are given below.

3.1.1 GATE, Eschborn

The activities of GATE in the field of soil technology mainly include housing and research projects in some developing countries, as well as the publication of relevant literature and dissemination of experiences of the GATE staff and of information, which has been collected in the GATE documentation department. Housing projects, that involve soil technologies have been implemented in some Latin American countries, of which one example, namely in El Salvador, is described in a GATE publication (Bibl. 21). Research projects, in which soil techniques were investigated, were undertaken, for example, in Guatemala, in connection with low-cost, earthquake resistant roofing (Bibl. 41), and in Kenya, with a view to applying the local lateritic soils for low cost housing. A detailed manual on the construction of a

soil block press (CINVA-Ram type), used in Cameroon, was also published by GATE (Bibl. 23), and is included in Section 3.2: Summary of Soil Block Presses (CENEEMA-Press).

On account of its extensive international contacts, the GATE "Question and Answer Service" had accumulated a pile of information on various known soil block presses. This material constituted the "starting capital", which helped the author to save a good deal of time and effort for preliminary investigations.

Further useful information was gathered in the GATE project documentation section, which has a large collection of standard literature, various journals, project working papers and confidential reports, on all aspects of appropriate technologies for developing countries. However, a computer search through the various data banks, to which GATE has access, disappointingly brought forward only few insignificant references.

3.1.2 IRB, Stuttgart

The "Informationszentrum RAUM und-BAU", which is one of 25 institutions of the Fraunhofer-Gesellschaft, a semi-governmental organization, is perhaps the biggest German documentation centre on all regional planning and architectural issues. Apart from a large



Aus der
Arbeit von



NEHMALEHWEISEN
BREMEN
WOHNUNGSBAU IN
EL SALVADOR

DEUTSCHE ZENTRUM FÜR
TECHNISCHE ZUSAMMENARBEITUNG
MIT DEN LÄNDERN DER
DRETTWELT

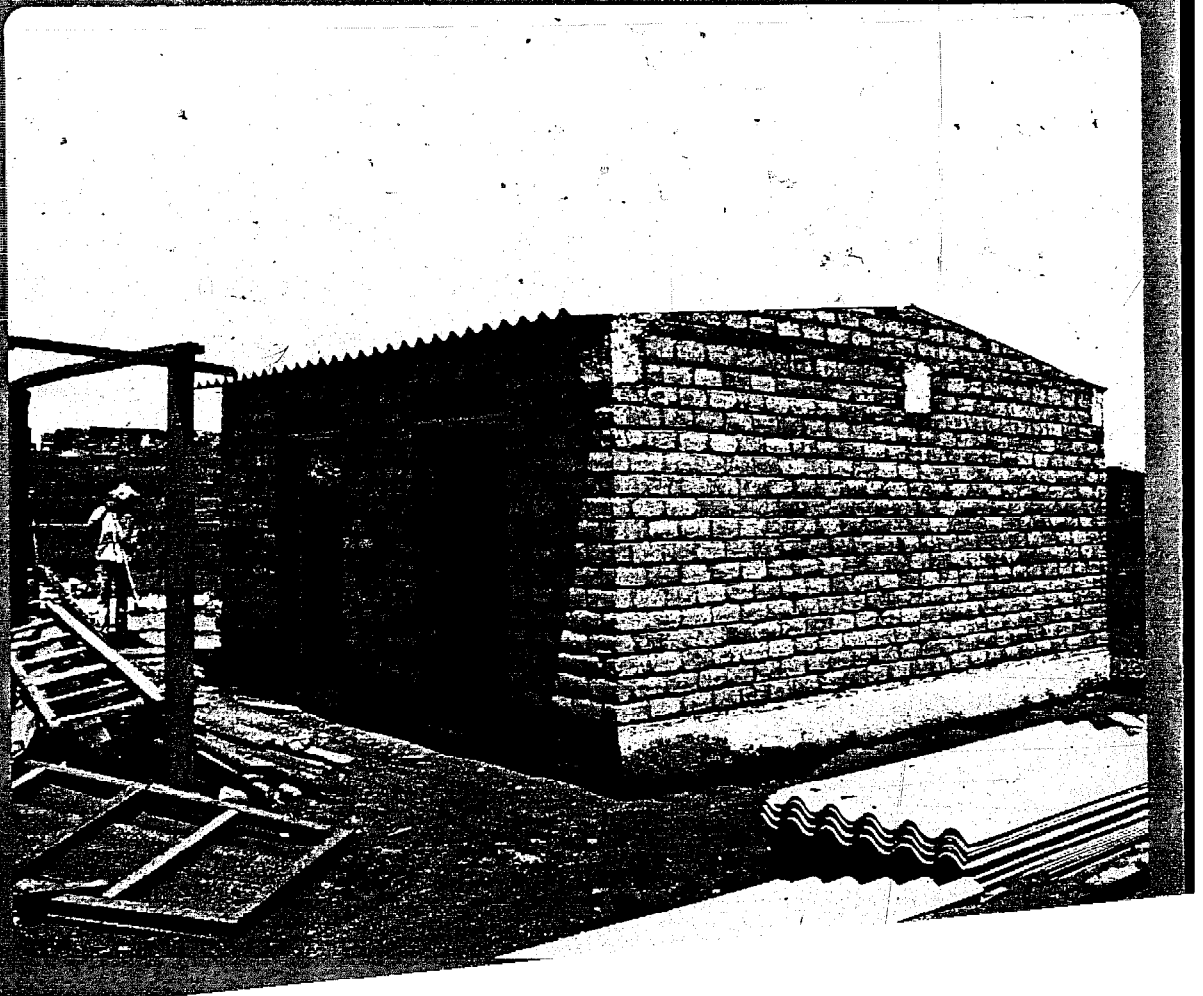

library and microfilm archive, IRB has access to several international data banks, which enables it to publish annotated bibliographies on all kinds of special subjects. All IRB services are chargeable and available to everyone.

The author requested a list of publications on all related aspects of soil construction technology in general, and on soil block presses in particular, but without any result. It seems that information on developing countries, and particularly those related to appropriate technologies, are very weakly represented at IRB, although this may change as interest grows, and more requests of this kind, but also literature and information, are received by the institution.

3.1.3 DESWOS, Köln

This organization is active in the international development of housing co-operatives, and offers advice on setting up and running co-operatives in many developing countries, though with an emphasis on Latin America and India.

The author wanted to know from Raimund Wegener, who is mainly responsible for the Latin American projects, whether soil block presses were being used in their housing schemes, and what their experiences were. Surprisingly, the answer was no, since soil constructions have an extremely poor reputation amongst the house-builders, as well as the authorities. Also, on account of regular maintenance requirements and repairs, the buildings tend to become as expensive as conventional structures made of burnt bricks or concrete blocks. Furthermore, Mr. Wegener mentioned that the soil block houses, which were built in El Salvador (1978 - 79) as part of a GATE project, have caused considerable dissatisfaction amongst the dwellers.

(Author's note: This attitude can be observed quite frequently, but need not apply to all situations. There are sufficient examples of successful soil construction projects in all parts of the world. In some parts of the USA and Europe, earth buildings are valued for their living comfort and environmental appropriateness. As this awareness spreads to other regions, and construction techniques are improved, the poorer population of the Third World will be more inclined to accept soil buildings.)

3.1.4 Gesamthochschule Kassel

The Research Laboratory for Experimental Building, at Kassel University, which is headed by Dr. Ing. Gernot Minke, has been conducting intensive research on soil technologies since the mid-1970s. A number of prototype structures, employing a variety of old as well as newly developed techniques, have been built in Germany and overseas, all of which are well documented, though unfortunately (with very few exceptions) only in German. Professor Minke also publishes a kind of journal (which appears irregularly, roughly twice a year), called "Bauen mit Lehm" (Building with Soil), which features new developments and project reports on soil constructions, mainly in Germany.

On account of the long experience in soil technologies at Kassel University, practical courses (usually of 6 days duration) are held regularly, which are always well attended by

architects, masons, students, even from other faculties. But apart from research and training, building with soil has found its way into a large housing scheme in Kassel (about 50 houses), for which Professor Minke is mainly responsible.

3.1.5 Institut Lehmbau, Weil-Beuerbach

The non-profit Soil Building Institute was founded in 1982 by Roger Krötz, a sculptor, soil building specialist and lecturer at Hanover University, after about 5 years of active research and development work on the various uses of soil. The institute moved to an old farm house in Weil-Beuerbach in 1983. The members are a group of independent experts, mainly architects, and their aims include the promotion of soil technologies in Germany, provision of advisory services and project implementation. These activities will shortly be extended to overseas development aid projects. A great deal of experimental work is being undertaken, some specialities being soil ovens and furniture, as well as interior decorations and renovations with soil.

Short training courses on various themes, eg wall, domes, ovens, are held very frequently and constitute the main activity of the institute. These are sometimes held outside Germany, so that inspirations can be derived from other environments and cultural influences. The regular exchange of information, experiences and views with other experts in Europe and overseas is another major function of the institute, which organizes annual meetings of soil experts, in a different place each time.

3.1.6 AVM, Rüsselsheim

The Metalwork Training Centre (Ausbildungsverbund Metall), in Rüsselsheim, has little to do with developing countries, but was recently asked by GATE to produce four CINVA-Ram type soil block presses, according to the GATE manual of the CENEEMA Press from Cameroon (Bibl. 23). Two of them are now being used on some overseas projects. These are probably the first CINVA-Ram type presses to be built in Germany, and some modifications were made to satisfy official German DIN standards. It is pleasing to note, that this exercise for trainees had a very direct practical use for a development project in the Third World - a model that could be incorporated in many other training programs.

3.1.7 ITDG, London and Rugby

The Intermediate Technology Development Group, whose head-office for a long time was in London, is now based in Rugby (since 1 January 1985). Only IT Publications and the Bookshop, together with three smaller units, have remained in the London office.

Soil technologies are presently not a special area of activity of ITDG, but information is being collected, as far as possible. The author was able to meet Michael Parkes, who is in charge of the building materials section, and Tony Bullard, for a discussion. With a few reorganizations within ITDG, new ideas and strategies are likely to emerge soon. A lot of useful information was found in the ITDG documentation files. Further information was purchased at the ITDG Bookshop in London, but the choice of books dealing with soil construction is rather limited.



5 Versuchsbau der Gesamthochschule Kassel (der vordere Teil wurde mit der Lehmstrang-
-prüftechnik errichtet).



6 Nubisches Gewölbe

Das nubische Gewölbe, das bereits in dem Tempelbezirk Ramses II in Oberägypten vor 3000 Jahren verwendet wurde, läßt sich mit einer speziellen Mauertechnik ohne Schalung oder Lehren herstellen. Die Bögen, deren Formen einer umgekehrten Kettenlinie entspricht, werden aus 20x20x6 cm großen, luftgetrockneten Lehmsteinen gemauert. Dabei ist es wichtig, daß die Bögen um ca. 20° geneigt sind und die Lehmsteine sich an den Stoßfugen berühren (sonst rutschen die Steine in dem feuchten Lehm-
mörtelbett ab und der Bogen stürzt ein).

Bauen mit Lehm 1



28



8

7 Aufbringen eines Lehmputzes

Ein Lehmputz für Innenwände läßt sich relativ einfach herstellen, wenn der Lehm stark mit Sand gemagert, mit Faserstoffen versehen und in dünnen Schichten aufgebracht wird. Außenputze aus Lehm sind in unserem Klima problematisch. Das Einreiben von Kalk verbessert die Haltbarkeit. Unbedingt notwendig ist jedoch ein zusätzlicher wasserdichter Anstrich mit niedrigem Wasserdampfdiffusionswiderstand.

8,9 Errichtung einer Lehmstampfwand

Zur Errichtung einer massiven Lehmstampfwand dient eine Kletterschalung aus Holz, in der der krümelige, schwach erdfeuchte Lehm von einem elektrisch betriebenen Rüttler verdichtet wird. Wenn die Lehmischung in ca. 7 cm Dicke eingeschüttet wird, läuft der Rüttler selbstständig in der Schalung hin und her und verdichtet den Lehm auf 55-60 % des Ausgangsvolumens. Durch den minimalen Wassergehalt, die starke mechanische Verdichtung und durch vertikale Elementfugen werden Schrumpfrisse in der Wand nahezu vermieden. Der lineare Schrumpf beträgt lediglich 0,4 % (gegenüber 2 % bei der traditionellen Stampftechnik).

Bauen mit Lehm 1

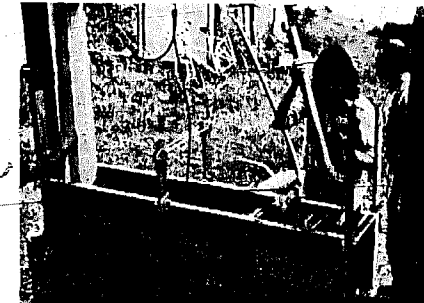

Bildnachweis: alle Photos vom Autor

Anmerkungen

- (1) Leitung der Kurse und theoretische Einführung: Prof. Dr.-Ing. Gernot Minke
Fachliche Betreuung: Dipl.-Ing. Günter zur Nieden
Organisation: Dipl.-Ing. Ulrich Merz
Sekretariat: Hiltrud Lüders
- (2) Anmeldung und Anfragen: Hiltrud Lüders
Menzelstr. 13, 3500 Kassel
Tel.: 0561/804 5312

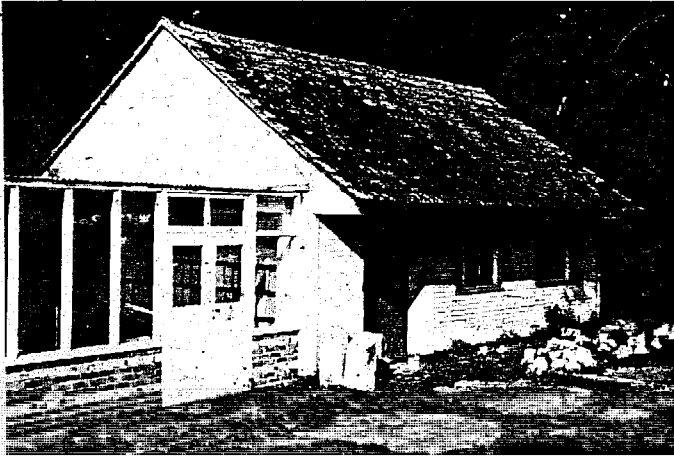

The experimental building which was constructed in 1950. The photograph was taken in October 1985.

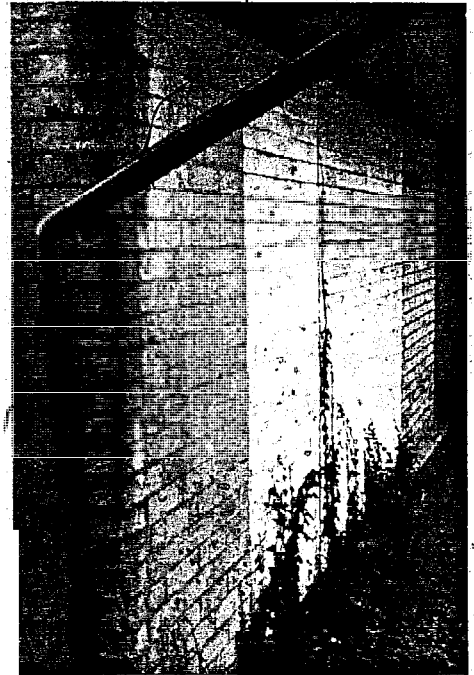

Detail view of the experimental soil-cement building, showing different surface treatments. The front corner was left untreated, but soil is in relatively good condition after 35 years of exposure.



Current exposure tests with stabilized soil blocks which were made with the BREPAK machine. Each block sample has a different combination of soil and binder. (In the picture: John Noonan, who is in charge of these tests).



David Webb demonstrating the BREPAK Block Clamp, with which heavy blocks can be easily carried with one hand and placed accurately in masonry construction, producing perfectly uniform joints. (see page 82)

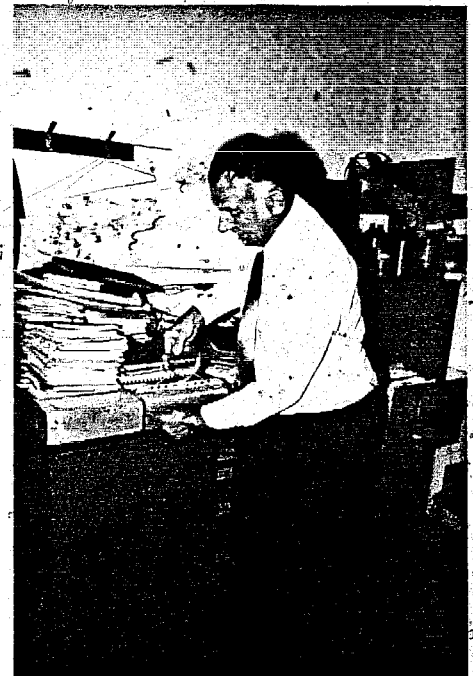

3.1.8 Building Research Station, Garston

This research institute, which was founded in 1921, probably has the longest experience in tropical building research. It is interesting to note that, as early as 1950, an experimental building constructed of soil-cement bricks was erected on the BRS premises. It is still in use as a store, and has satisfactorily withstood the cold-humid English climate, without special care. However, the first layers of bricks up to damp-proof course level consisted of fired clay bricks, giving the walls good moisture protection. The walls were divided into sections, partly solid and partly cavity brickwork, with a variety of surface finishes and renderings, for testing - with encouraging results.

Stabilized soil constructions are being investigated and developed more intensively over the past decade, mainly under the responsibility of David Webb, internationally one of the leading experts in the field. He also designed the BREPAK soil block press and other useful devices. Together with his colleague, Ray Smith, he has just completed a monograph on the production of stabilized soil blocks, which will be published by the International Labour Office, Geneva, as one of three technical memoranda on building materials for low-cost housing within their Technology Series. The assistance, that these two experts gave the author, was invaluable.

It is also worth mentioning that Mr. Webb is a member of the working party on Laterite Based Materials (LBM), which was initiated by Rilem (International Union of Testing and Research Laboratories for Materials and Structures), Paris, in January 1983, to prepare international guidelines on laterite technology. Furthermore, he is involved in the updating of the British Standard (BS 1924) on "Methods of Testing Stabilized Soils".

3.1.9 GRET, Paris

The Technological Research and Exchange Group, which was established in 1976, aims to collect available documentation on different technologies and to promote the diffusion of information through its Question/Answer Service. GRET's publications include several hundred technical development leaflets; books, studies and technical files covering a variety of disciplines; and a bimonthly bulletin "RESEAUX - la lettre du GRET".

In August 1985, GRET published a "Dossier Presses à Briques", which contained information on 16 soil block presses. This was probably the most comprehensive and up-to-date compilation done by an appropriate technology institution. It had to rely mainly on photocopied material from other sources, such that some illustrations are not easily distinguishable. Nevertheless, it contained information on 6 block presses - and happily also the manufacturer's addresses - which the author had not come across before. This was a good example of how valuable the work of an AT institution can be for a study of this kind.

3.1.10 CRATerre, Eybens (Grenoble)

The members of the Centre for Research and Application of Earth Construction Technology are among the most experienced soil experts. Apart from research and training courses, which are conducted at the Grenoble School of Architecture (UPAG), the group has implemented numerous soil building projects and studies, not only in France, but also in many French-speaking African countries, as well as Mexico and Peru. They are presently the technical advisors of the largest single soil building project in Europe, comprising 64 houses, located at Isle d'Abeau (between Lyon and Grenoble).



The Grenoble School of Architecture (UPAG) is the only academic institution that offers a degree course in soil construction, which is conducted by CRATerre. Photo : Jürgen Schneider (Bibl. 54)



The members of CRAterre have designed and constructed two soil block presses ("La Palafitte" and "CRAterre Perou Block Press") and published several monographs, handbooks and articles on soil technologies. One of these, "Construire en Terre" (Building with Earth) is certainly one of the most attractive and complete publications on the subject, but unfortunately only available in French. The lack of funds has been the main obstacle in getting the book translated into English.

Judging from this book, CRAterre seems to possess the most comprehensive documentation on soil technologies. The book also contains the largest number of references to soil block presses, but without details and addresses. It was, however, disappointing that a direct request for these was not complied with by CRAterre.

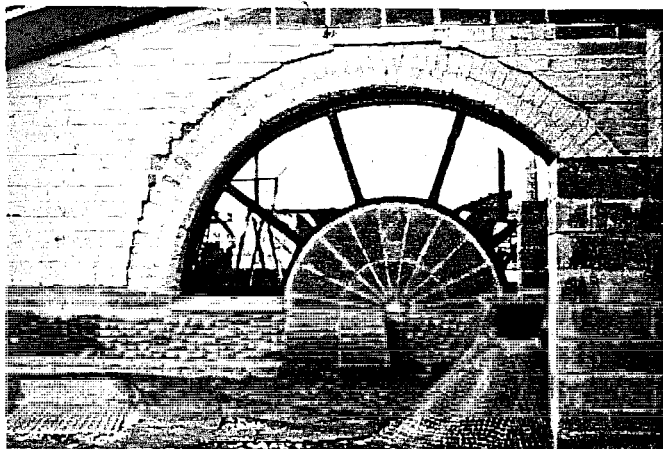

3.1.11 Centre de Terre, Lavalette (Toulouse).

This centre for research, demonstration and documentation of soil building techniques was founded in 1978 as a private initiative, by Joseph Colzani, an architect and soil building enthusiast. One of his specialities is to introduce artistic forms in soil-cement masonry structures, and to carve out ornamental shapes in finished walls. The architectural firm, called ARCHECO, is responsible for the design and construction of over 100 soil buildings in Southern France.

The Centre de Terre also incorporates a firm, called SOUEN, which develops soil block presses (TOB-System, GEO 50, GEO 500) to produce the soil-cement blocks for ARCHECO's projects.

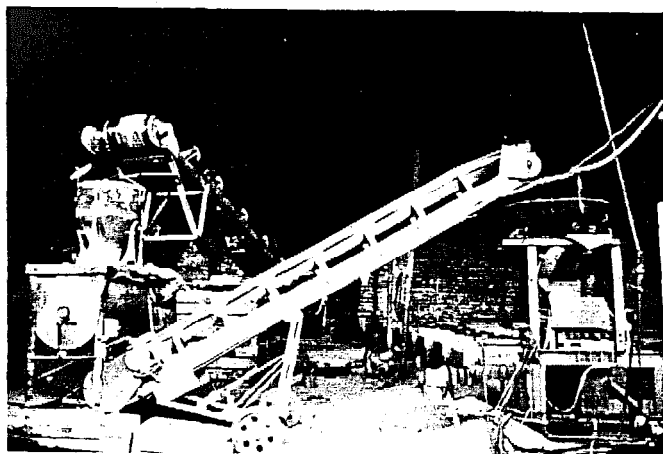

Photos from ARCHECO, Centre de Terre

Top : View of the centre in Lavalette, with some 'unconventional' details of the façade and courtyard.

Left : Soil brick production unit ("Presse tunnel"), with which the centre makes its own building material.

Below : Examples of ARCHECO's projects : two "bioclimatic" houses built in and around Toulouse, Southern France.



3.1.12 SKAT, St. Gall

As a sub-section of the Institute for Latin-American Research and Development Cooperation at the University of St. Gall, the Swiss Centre for Appropriate Technology was established in 1978. However, it does not deal only with Latin America, but with the entire Third World. The activities of SKAT are many-fold: consultancy, project implementation, feasibility studies, question/answer service, documentation, publication of monographs, working papers etc., book-sales, conferences, seminars and cooperation with other AT organizations.

Of all the information centres visited by the author, the SKAT documentation was found to be the most complete, and consequently, most useful. It is also of great advantage, that many of the books in the library can be purchased directly from SKAT.

Various issues of mutual interest were also discussed with Dr. Urs Heierli, Managing Director of SKAT. Since a few soil block presses are also being manufactured in Switzerland, SKAT has been involved in their assessment, on behalf of the Swiss government. They also prepared a working paper on "Soil block Making Equipment" (Bibl. 57). Dr. Heierli agreed that a comprehensive study of these machines would be very valuable, in view of the growing demand in all parts of the world, and the increasing choice of equipment. He also feels that it would be especially beneficial for all those involved in low-cost housing, if a number of AT, development and research institutions, would coordinate their activities, in testing as many machines and systems as possible under field conditions, and exchanging test results and experiences. There is no doubt that this suggestion deserves further consideration, especially amongst development aid organizations.

3.1.13 ETH-Hönggerberg; Zürich

At the Institute for Building Technology of the Swiss Technical University, intensive research is being undertaken on soil based materials. In charge of these investigations is Hans D. Sulzer, assistant professor and technical consultant, who designed and built a manually-operated soil block press (SATURNIA), which greatly simplifies handling and produces uniform, good quality bricks at a faster rate than other manual presses.

It is interesting to note that Mr. Sulzer originally planned to construct three more types of presses, to satisfy a variety of differing requirements, but has now given up the idea, on account of extensive laboratory tests with his machine and the bricks it produces. The reason is not that the press is less efficient than other known types, but that he has come to the conclusion that the physical properties of traditional adobe blocks are superior to those of compressed soil-cement blocks. Although this is difficult to believe, as it contradicts generally accepted views, this has been proved by laboratory test results, for which Mr. Sulzer even has a scientific explanation. Details of his investigations will be published shortly, and there can be no doubt that they will generate a great deal of discussion, and possibly lead to a new approach to soil building technologies.

Mr. Sulzer has also developed a chemical pro-

duct, called "Protectearth", for the impregnation of compacted dry earth. The diluted solution, which can be applied by a brush or spraying device, penetrates the surface 2 - 6 mm deep, creating a molecular film between the soil particles, which prevents water absorption, but allows vapour movements. This product can be a viable alternative to soil stabilization and is of special interest for the conservation of historical monuments.

3.1.14 IFEC, Washington, D.C.

The International Foundation for Earth Construction was established in 1983, in close collaboration with the Cooperative Housing Foundation in Washington, D.C., which has over thirty years of international experience in planning and developing low income housing programs.

IFEC is a non-profit organization dedicated to helping people create better shelter by using earth construction techniques. This is achieved by providing advice and technical assistance; coordinating financial assistance from government and private sponsors, on selected demonstration and training projects in the Third World; preparation and dissemination of literature on stabilized earth and related technologies, as well as on the improvement of unstabilized adobe and on rain-water collection and storage; cooperation with academic and industrial organizations and coordination of research activities; and finally, organization of international symposia and ad hoc group meetings. In November 1985, IFEC served as co-sponsor of the International Symposium on Earth Architecture held in Beijing, People's Republic of China, in cooperation with the Architectural Society of China.

IFEC's Board of Trustees and Advisory Council comprises the most well-known and experienced soil construction and housing experts.

3.1.15 AT International, Washington, D.C.

Appropriate Technology International is a private, non-profit corporation, created in 1977 in response to a mandate from the U.S. Congress to "promote the development and dissemination of technologies appropriate for developing countries". Although funded by the U.S. Agency for International Development, ATI is ensured flexibility and independence, in order that it may operate primarily in the private sector. Its governing body is a board of Trustees, whose members are drawn from private companies, the banking sector, research sector and American and international NGOs.

Within ATI, the Technology and Enterprise Development Group seeks to identify and appraise technology and enterprise opportunities for ATI's development program. A member of this group, Carlos R. Lola (Minerals Development Specialist), has conducted studies on soil cement constructions, especially with regard to seismic resistance and low-cost housing programs in Nicaragua, and on ADAUA's soil building techniques (Bibl. 29, 30). ATI is currently considering a brick project in Tanzania, where the working performance of several soil block presses will be assessed. If this materializes, it would already be a big step towards the realization of Dr. Heierli's proposal (ref. section 3.1.12: SKAT).

3.1.16 CTA, Asunción

In 1981, the Centre for Appropriate Technology was established at the Catholic University, under the direction of Dr. Ing. Thomas Gieth, an integrated expert of CIM (Migrations Centre for Intergovernmental Development), Frankfurt, Germany. CTA's activities are oriented towards the development of low-cost housing technologies and utilization of non-conventional energy sources in Paraguay. Within these objectives, soil building techniques represent a major area of research.

Of special interest, is the development of a soil block press, which is similar to the CINVA-Ram, but produces three blocks at a time, thus achieving an extremely high rate of production. A demonstration building ("Prototype A") was built with these soil blocks, at only 30 - 40 % of the cost of conventional constructions with burnt bricks (Bibl. 19, 20). A current 2-year project deals with the improvement of housing in rural areas of Paraguay, with a view to eliminating infestation by a vector, the triatomino, which transmits the dangerous Chagas disease. The results of this work will be of great interest to all the tropical and subtropical countries of Latin America.

Several technical bulletins and audio-visual material (slides and cassettes) are available from CTA.

3.1.17 ADAUA, Ouagadougou

With its headquarters in the capital of Burkina Faso (formerly Upper Volta), ADAUA is probably the most active group of soil building specialists in Africa. This non-profit Association for the Development of Traditional African Urbanism and Architecture was founded in 1974 in Geneva, Switzerland, but is now entirely run by Africans, and operates mainly in West Africa. The staff includes architects, engineers and social workers, as well as brick-makers and masons. Their main functions are to revive traditional soil building techniques, develop improved systems, train and support local artisans and implement building projects, often encouraging and guiding low-income families to build their houses themselves.

The principal material used are soil-cement bricks, which are produced on a press, that was invented as far back as 1904, and is still being manufactured in Belgium. ADAUA has perfected the techniques of building vaults and domes, which were rediscovered by Hassan Fathy in Egypt.

3.1.18 UST, Kumasi

The Building and Road Research Institute, at the University of Science and Technology in Kumasi, Ghana, is well-known for its extensive research work and many technical publications on various aspects of soil construction, particularly with lateritic soils. Especially famous is the TEK-Block Press, which was developed in 1970 by the Department of Housing and Planning Research, Faculty of Architecture (Bibl. 13, 45). This development resulted from experiments undertaken to determine the suitability of the CINVA-Ram for use in Ghana. Since the CINVA-Ram was found to have a few deficiencies, a new block press was designed to overcome them. Until then, not many soil block presses were known, but it seems that the development of the TEK



PROTOTYPE "A" : CTA's demonstration low-cost house of soil-cement blocks, built on the campus of the Catholic University, Asunción.

Soil-cement building for a church project in Paraguay, with a CTA-Press in the foreground.

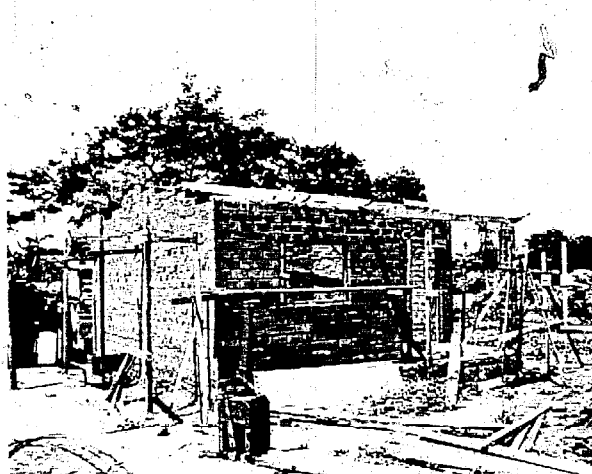

Block Press inspired many other groups to construct similar devices. A powered version of the press (POWER TEK BLOCK hydraulic press) was designed later on, but was evidently soon given up.

3.1.19 HRDU, Nairobi

As a quasi-independent department within the University of Nairobi, the Housing Research and Development Unit is, since long, the most active and experienced institution in East Africa, dealing with all aspects of housing and low-cost constructions. It has produced a series of extremely useful publications, which are not only of interest within East Africa, but in all tropical developing countries.

Investigations into the use of soil as a building material have gained importance at HRDU, during the last few years. The first field trial of the BREPAC block press, developed at the Building Research Station, UK, was undertaken in cooperation with HRDU, in 1981, on a site near Nairobi (Bibl. 67). The potentials of Kenyan lateritic soils as a low-cost construction material are currently being investigated, as part of a GATE/HRDU research and development project, which is jointly funded by the Kenyan and German governments.



Settlement in Bamako, Mali

Some impressions of ADAUA's work. Photos: Jürgen Schneider (Bfbl. 54)

The Panafrikan Institute in Ouagadougou, Burkina Faso (Upper Volta)

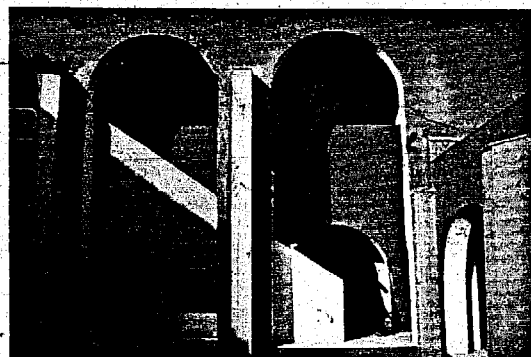
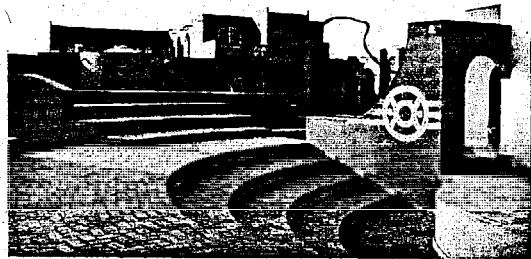

3.1.20 CBRI, Roorkee

The Central Building Research Institute grew out of a small research unit, established in 1947, by the Indian Council of Scientific and Industrial Research. CBRI is now the largest building research institute on the sub-continent and has a high international reputation. It deals with practically all aspects of housing, building and planning in the context of tropical developing countries, and most of the work is documented in the institute's reports, articles and conference papers.

Soil engineering is one of the institute's main areas of research. Several innovative materials, building components and techniques have resulted from this, eg the "sarvatogriha" (house for all), with a vaulted roof, based on the Egyptian technique used by Hassan Fathy. Also hand-operated as well as automatic brick presses have been developed, primarily to produce clay and sand-

lime bricks for firing, but which probably are also suitable for making soil-cement bricks.

3.1.21 ASTRA, Bangalore

As a centre for the Application of Science and Technology to Rural Areas, at the Indian Institute of Science, Bangalore, ASTRA has conducted extensive studies on rural building techniques in Southern India, of which soil constructions are, for obvious reasons, the most widespread. Studies of locally available soil block presses revealed deficiencies, which could be eliminated by a modified machine. Such a machine, named ASTRAM, was developed by K.S. Jagadish and B.V. Venkatarama Reddy in 1980 (Bibli 25). After more than four years of field testing, commercial production began in 1985, by the end of which year, 60 machines have been operating in India.

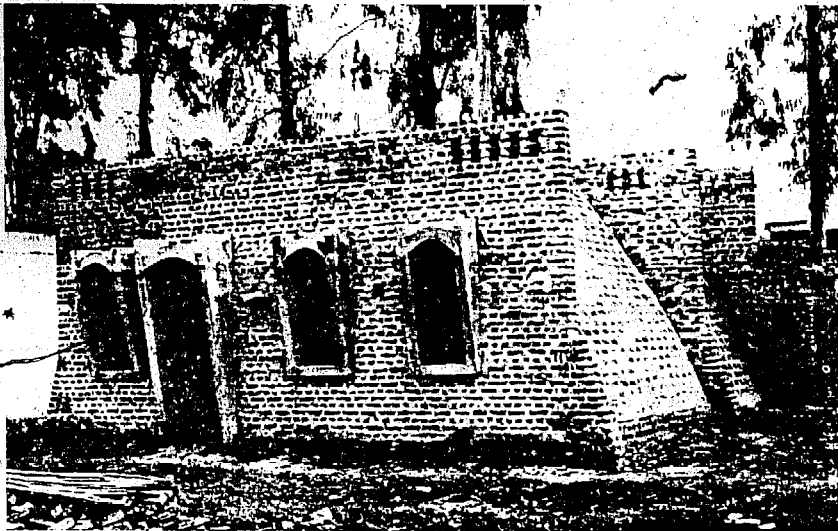

"Sarvatogriha" : An experimental low-cost vaulted house built without cement or steel and using no formwork

Developments of the Central Building Research Institute

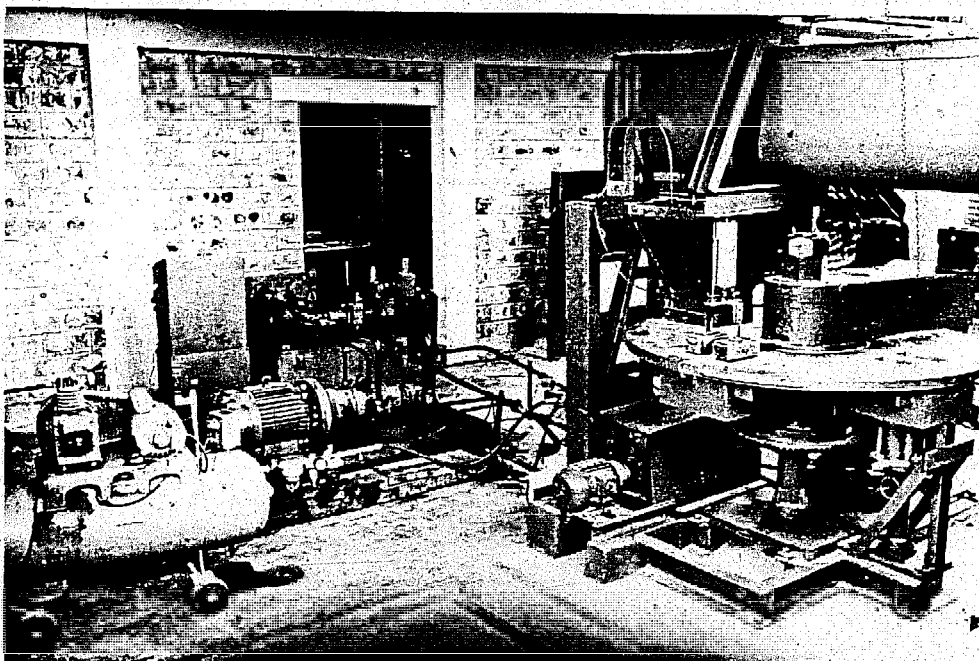

CBRI Sand Lime Brick Press, with hydraulically operated rotary table

3.2 Summary of Soil Block Presses

This section contains all the soil block presses that were identified in the course of the study. They are divided into four groups:

- 3.2.1 Currently available presses, with details in Annex A
- 3.2.2 Currently available presses, without further details
- 3.2.3 Industrial - factory based - plants
- 3.2.4 Soil block presses, which are not being produced anymore

As this is the most important part of the study and probably the section that will be consulted most often, pains were taken to make it as accurate, up-to-date and comprehensive as possible. However, no claims are made to completeness, and the correctness of the information depended on the material available when completing the report, some of which being too vague, or possibly outdated.

A few words need to be said about the column on "Average rate of production": The figures do not always correspond to the values given by the manufacturers, who either mention minimum or maximum production rates. Furthermore, each machine has its own (range of)

block size(s), which usually differs from others. On account of the large number of machines listed here, similar devices could be compared with one another, showing that some producers tended to give rather optimistic figures (probably achieved under ideal workshop conditions over short periods), while others estimate the output more modestly. The figures given in the following summary, therefore, represent an attempt to even out these differences, although admittedly, these have been worked out on a purely theoretical estimation. The users of this inventory are, therefore, requested to view the column on production rates merely as a guideline.

Truly comparable output rates can only be established by extensive field tests of all the machines under the same conditions. As regards the number of workers mentioned in the list, they generally include one person to prepare the soil mix, in addition to those needed to charge, unload and operate the press. Some manufacturers, however, prefer to include more people for these operations, which is indeed more realistic and appropriate for developing countries.

It is hoped, that the expected response to this study will bring forward more accurate and comparable data, and that the section 3.2.2 (on presses without further details) can be eliminated in the final document.



CINVA-Ram manual block presses in operation.

3.2.1 Currently available presses, with details in Annex A

SOIL BLOCK PRESSES	ADDRESSES:	SOURCE OF INFORMATION	BRIEF DESCRIPTION	AVERAGE RATE OF PRODUCTION Blocks/hour (Number of workers)
Year of Development (if known) (P) = Prototype	a Developer b Manufacturer	C=Correspondence L=Leaflet B=Bibliography		
CINVA - Ram 1952	a Inter-American Housing and Planning Centre COLOMBIA b 1 Metalibec Ltda COLOMBIA 2 Industria e Comercio de Maquinas BRAZIL 3 Schrader-Bellows USA 4 Fraser Eng. Co. NEW ZEALAND	B 51, 58, 60, 62, 64, 68	Steel mould box with a piston at the bottom and a lid which is opened for filling. A long metal handle is manually operat- ed, moves the compression piston via a toggle link- age. All connections weld- ed. Production of one block per cycle.	40 - 60 (3)
TEK Block Press 1970	a/b Department of Housing and Planning Research Faculty of Architecture UST, Kumasi GHANA	B 13, 45, 60	Sturdier version of CINVA- Ram, with simplified hand- ling, wooden lever and larger block size	30 - 40 (3)
La Palafitte 1975 (P)	a ADETEN 1'Unité Pédagogique d'Architecture de Grenoble; CRATerre Les Rivaux, Haut-Brié, 38320 Eybens FRANCE b -	B 01, 06	Modified TEK Block Press	40 - 60 (3)
CETA-Ram 1977	a/b CETA 15 Ave. 14-61, Zona 10 Guatemala City GUATEMALA	B 31	Modified CINVA-Ram to pro- duce hollow blocks (for placement of reinforcing rods in aseismic wall construction)	40 - 60 (3)
CENEEMA Earth and Loam Block Press 1979	a/b CENEEMA B.P. 1040 Yaoundé. CAMEROON	B 23	Modified CINVA-Ram	40 - 60 (3)
AVM Block Press 1984	a/b Ausbildungsverband Metall (AVM) Bernhard-Adelung-Str. 42 6090 Rüsselsheim FED. REP. OF GERMANY	C	CENEEMA Press modified such that only German DIN standard parts are used.	40 - 60 (3)
SISD Dirt-Cement Brick Press	a/b Southern Institute for Skill Development Thai-German Project PO Box 5, Kao Seng Songkhla 90001 THAILAND	B 56	Modified CINVA-Ram	40 - 60 (3)
Meili - 60 Manual Sbil Brick Press	a/b Meili Engineering Gewerbe-Center Rothaus 8635 Dürnten SWITZERLAND	C L	Modified CINVA-Ram	40 - 60 (3)
MARO Block Press	a/b MARO Enterprise 95 bis route de Suisse 1290 Versoix SWITZERLAND	C L	Modified CINVA-Ram, assembled only with screws and bolts.	40 - 60 (3)

SOIL BLOCK PRESS	ADDRESSES:	SOURCE OF INFORMATION	BRIEF DESCRIPTION	AVERAGE RATE OF PRODUCTION Blocks/hour (number of workers)
Year of development (if known) (P) = Prototype	a Developer b Manufacturer	C=Correspondence L=Leaflet B=Bibliography		
CTBI Block Press	a/b C.T.B.I. Zone Industrielle 51140 Muizon FRANCE	C B 33	Similar to MARO Block Press	40 - 60 (3)
UNATA	b GVD Heuvelstraat 131 3140 Ramsel-Herselt BELGIUM	C L	Copy of CINVA-Ram	40 - 50 (3)
JESSON Brick Press	a/b Jesson Industries PO Box 664 Port Elizabeth 6000 SOUTH AFRICA	C	Modified CINVA-Ram with attached-filler hopper.	40 - 60 (3)
A.B.I. Block Press	a/b Abidjan-Industrie B.P. 343 45 Rue P.et M. Curie Zone 4 C Abidjan IVORY COAST	L	Same principle as CINVA-Ram, with interchangeable moulds for hollow blocks	40 - 60 (3)
CTA Block Press	a/b CTA Facultad de Ciencias y Tecnologia Universidad Católica Asunción PARAGUAY	C L	Modified CINVA-Ram, producing 3 blocks per cycle	150 - 180 (4)
GEO 50	a/b SOUEN Centre de Terre Lavalette 31590 Verfeil FRANCE	C L	Same principle as CINVA-Ram, but easier to handle, with lever action only on one side.	20 - 50 (2)
SATURNIA 1983 (P)	a ETH-Hönggerberg Inst. für Hochbautechnik 8093 Zürich SWITZERLAND b -	C	Same principle as CINVA-Ram, but easier to handle, with one-sided lever action and mechanism for accurate filling of mould.	100 - 150 (3)
RIFFON Block Press	a/b J. Riffon Rue J. Wilgot 6 5220 Andenne BELGIUM	C	Pedal and lever operated press, with piston suspended over 1 m high moulding table, designed such that operator stands upright.	100 - 120 (3)
ELLSON Blockmaster (S, D, SB 1, SB 2) 1950	a Ellson Equipments (Pty)Ltd. PO Box 261 532 Excom 2023 SOUTH AFRICA b Kathiawar Metal and Tin Works Pvt. Ltd. 9 Lati Plot Rajkot (Gujarat) INDIA	C B 01, 06. 57	Similar to CINVA-Ram, in principle, but larger, heavier, with interchangeable moulds. Compression effected by "jumping-pull", thus better compaction than CINVA-Ram.	60 - 80 (4)
ASTRAM 1980	a ASTRA Indian Institute of Science Bangalore 560012 INDIA b Aeroweld Industries B9, HAL Industrial Estate Bangalore INDIA	C B 25, 63	Lighter and improved version of ELLSON Blockmaster	60 - 80 (3)

SOIL BLOCK PRESS	ADDRESSES:	SOURCE OF INFORMATION	BRIEF DESCRIPTION	AVERAGE RATE OF PRODUCTION Blocks/hour (number of workers)
Year of development (if known) (P) = Prototype	a Developer b Manufacturer	C=Correspondence L=Leaflet B=Bibliography		
CRATerre Perou Block Press 1982	a/b CRATerre Perou Apajardo Postal 399 Huancayo PERU	B 06, 35	In principle, similar to ELLSON Blockmaster, but with wheels and larger block size. Side tables for soil mix and finished blocks facilitate handling.	100 - 120 (5)
Multibloc BREPAK Block Press 1981	a Building Research Station Overseas Division Garston, Watford WD2 7JR ENGLAND b Welding Industries Ltd. Crews Hole Road off Blackswarth Road, Bristol BS5 8AX ENGLAND	C L B 67	Sturdier version of CINVA-Ram, with manually operated hydraulic pump, achieving five times higher compaction than CINVA-Ram.	35 - 40 (5)
ZORA Brickmaking Machine	a/b Zora Company Ltd. 112 Power Road London W4 5PY ENGLAND	C L	Motor-driven hydraulic block press with extremely high compaction	120 - 150 (3)
TERSTARAM Block Press 1904	a Les Ateliers de Villers-Perwin 1-3 rue E. Gossiaux 6311 Villers-Perwin BELGIUM b Fernand Platbrood 20 rue de la Rieze 6404 Cul-des-Sarts Couvin BELGIUM	C L B 01, 06, 57, 60	Manually operated press for making blocks and tiles, producing 2 blocks per cycle (Original names: SUPER MADELON, later STABIBLOC, also well-known as LANDCRETE).	150 - 200 (4)
CERAMAN Manual Press 1904	a same as TERSTARAM b CERATEC 228 rue du Touquet 7792 Ploegsteert BELGIUM	C L B 57	Same as TERSTARAM, but with automatic ejection of blocks	200 - 300 (4)
SEMI-TERSTAMATIC 1993	a and b: same as for TERSTARAM	C L B 01, 06, 57	Motor-driven version of TERSTARAM (Original name LA MAJO)	400 - 600 (4)
CERAMATIC Automatic Brick Press 1953	a and b: same as for CERAMAN	C L B 57	Motor-driven mechanical block press with rotating 3 station table, for filling, moulding and ejection of 2 bricks a time (original name: LA MAJO-MATIQUE).	1000 - 1500 (3)
LESCHA SBM 1976/1984	a Lescha/Augsburg and Consolid/SWITZERLAND b Lescha Maschinenfabrik Ulmer Str. 249/251 8900 Augsburg FED. REP. OF GERMANY	C L	Complete production unit on wheels, incorporating mixer, hopper and 4 station rotating table with hydraulic press for 2 bricks a time (improved version of CLU 2000)	500 - 700 (4)
CLU 3000 1980	a/b CONSOLID AG Aechelistr. 18 9435 Heerbrugg SWITZERLAND	C L B 60	Further development of CLU 2000 with higher compaction of bricks, but 1 brick each time.	300 - 500 (4)

SOIL BLOCK PRESS	ADDRESSES:	SOURCE OF INFORMATION	BRIEF DESCRIPTION	AVERAGE RATE OF PRODUCTION Blocks/hour (number of workers)
Year of development (if known) (P) = Prototype	a Developer b Manufacturer	C=Correspondence L=Leaflet B=Bibliography		
ECOBRIK 1000 1984	a/b Dieter Schmidheini Weinbergstr. 29 9436 Balgach SWITZERLAND	C L	Simplified version of CLU 3000, semiautomatic operation, 1 brick per cycle (rotating table omitted)	100 - 120 (2)
MEILI Mechanpress	a/b Meili Engineering Gewerbe-Center Rothaus 8635 Dürnten SWITZERLAND	C L B 57	Same operating principle as CLU 3000	700 - 900 (4)
TERRE 2000 Presse TMR 6750-40 1984	a/b RGF TERRE 2000 Système Constructif B.P. 98 13160 Chateaufrenard FRANCE	C L B 33	New type of hydraulic press with separate mixer and conveyor pipe for soil mix, 1 block per cycle	200 - 300 (4)
PACT 500 Block Press (previous model PACT 315)	a/b ALTECH Rue des Cordeliers, 05200 Embrun FRANCE	C L B 33	Compact motor-driven mechanical press, with 4 station rotating table compacting 1 block at a time, interchangeable moulds	300 - 350 (4)
CTBI Hydraulic Press	a/b C.T.B.I. Zone Industrielle 51140 Mutzon FRANCE	C B 33	Semi-automatic, electrically driven hydraulic press, complete with hopper for uniform, accurate filling of mould	80 - 110 (2)
GEO 500 Semi-Bloc, Unité Atelier	a/b SOUEN Centre de Terre Lavalette 31590 Verfeil FRANCE	C L	Semi-automatic, diesel powered press, operated in conjunction with a separate mixer, all equipment being charged and unloaded manually	200 - 250 (6)
GROUPE UNIPRESS	a/b HALLUMECA 37 rue des Ecoles 59780 Baisieux FRANCE	L B 06, 33	Complete production unit on wheels, with mixer, hopper and rotating table for mechanical compaction	1500 - 2000 (4)
ULTRABLOC IMPACT 1/2	a/b ULTRABLOC PO Box 1363 Corrales, NM 87048 USA	C L	Mobile hydraulic press, with manual (Impact 1) or automatic (Impact 2) operation; extremely high compaction	200 - 300 (4)
TERRABLOCK Duplex	a/b Earth Technology Corp. 175 Drennen Road Orlando, FL 32806 USA	C L	Fully automatic, computer controlled, self-contained mobile production unit; extremely large blocks with highest known compaction	360 - 600 (4)
HANS SUMPFF Brick Machine 1946	a/b Hans Sumpf Adobe Co. Fresno, California via: IFEC 3282 Theresa Lane Lafayette, CA 94549 USA	B 16, 34	Mobile production unit, which lays 35 blocks per cycle on clean, flat ground, no pressure moulding, hence strictly not a block press	many 1000 (3 - 4)
EARTH BRICK MACHINE	a/b Australian Adobe Industries Suite 4, "Ormond House" 109 Yarra Street Geelong, Vic. 3220 AUSTRALIA	C	Fully automatic, self-contained production unit on wheels, producing blocks of all sizes, with extremely high compaction	1000 - 1500 (2)

3.2.2 Currently available presses, without further details

BLOCK PRESS	SOURCE OF INFORMATION / COMMENTS
Adobemaster hand-powered adobe maker	Bibl. 06 Address of producer: Design Services, Box 2334, Ruidoso, NM 88345/USA
AIT Brick making machine	From publication list received from Asian Institute of Technology, Bangkok/Thailand: HSD working paper on "Interlocking Soil Cement Bricks: A Modified Cinva-Ram Brickmaking Machine", by A.B.Etherington, 1983, 9p.
Apex manual and hydraulic operated brick moulding machines	Information received from UNIDO, Vienna. Manufacturer: Apex Engineering & Construction Co., PO Box 57067, Nairobi/Kenya
Bernat - Saulière, output 300 - 400 bricks/hour	Bibl. 06, but without further details. Manufacturer: M. Teseyre, 74 rue de Pey, 81100 Castres/France
BG.2S, output 300 - 400 bricks/hour	Bibl. 06, but without further details
CBRI manual (100 bricks/hour) and mechanically operated brick presses (250 bricks/hour), with compaction pressures of 10 and 20 N/mm ² respectively	Bibl. 61: Paper on "Appropriate Technologies and Materials for Housing and Building in India" by staff members of Central Building Research Institute (CBRI), Roorkee/India. These presses were developed for the production of clay bricks and sand-lime bricks for firing; probably also suitable for soil-cement bricks.
Earth Ram	Bibl. 06, but without further details. Manufactured in Mesa, Arizona/USA
HALLUMECA B 75, B 100, B 150, B 200, mechanical presses	Bibl. 06, but without further details. Machine produced by Hallumeca, 37 rue des Ecoles, 59780 Baisieux/France
Han Suk Sang brick plant for non-fired clay bricks, compacted at 20 N/mm ²	Article in Asia-Pacific Tech Monitor (May/June 1985), Bangalore/India. Address of producer: Han Suk Sang SA Co.Ltd, 1157-7, Chorang-Dong, Dong-ku. Pusan/Korea
Latoblock manual (60 blocks/hour) and automatic (600 blocks/hour) block making machines	Bibl. 04: Paper on "A New Low Energy-Intensive Building Material based on Lateritic Soil for Low Cost Housing in Developing Nations". Machines developed by Structural Engineering Research Centre (SERC), Madras, and Mechanical Engineering Research and Development Organization, New Delhi/India
Lorev	Personal communication from David Webb, Building Research Station, Garston/England. The machine is produced in Italy.
Mechanized, mobile brick press, driven by animal or hydro-power or simple one-cylinder combustion engine, with an output of at least 125 bricks/hour on a 4 step rotating table	Bibl. 33 and article in Asia-Pacific Tech Monitor (May/June 1985), Bangalore/India. The machine was developed by Dirk Janssen of Delft University of Technology, Centre for Appropriate Technology (CAT), PO Box 5048, 2600 GA Delft/Netherlands
RAFFIN	Bibl. 06, but without further details
Ram Tech, automated, hydraulically-powered rotating turret machine	Same news letter as above. Manufactured in Santa Fe, New Mexico/USA
Soil Crete, automated CINVA-Ram producing about 100 blocks/hour	Earth System Reporter (newsletter of Earth Systems Dev.Inst., PO Box 1217, Corrales, NM 87048). Manufactured in Southern Colorado
VALRAM	Communication from Aromar Revi of Development Alternatives, Shelter Group, 22 Palam Marg, Vasant Vihar, New Delhi 110057. No details known, except that field testing of prototype is nearing completion and commercial production will commence in February 1986. Family of machines planned.

3.2.3 Industrial - factory based - plants

PRODUCTION UNIT	SOURCE OF INFORMATION / COMMENTS
Latorex L 3 brick plant, producing laterite-based bricks	Bibl. 33, 40. Manufacturer: Drostholm Products A/S, 2950 Vedbaek/Denmark. Plants built in Philippines and Africa
Krupp Atlas brick plant, conceived to produce laterite-based bricks	Bibl. 40. Manufacturer: Krupp-Polysius AG, Graf-Galen-Str. 17, 4720 Beckum/FR Germany. The plant was supposed to be built in West Africa, but never passed the planning stage
Supertor hydraulically powered brick plant, with output of 2500 bricks/hour	Bibl. 32. Manufacturer: Torsa Maquinas et Equipamentos Ltda, Sao Paulo/Brazil
Tecmor HCR3, HCR5	Bibl. 06. Manufacturer: Tecmor Equipamentos, Mecanicos Ltda, Rua da Imprensa, 331, Sao Carlos/Brazil
T.E.G. Equipment block press, evidently the same plant as Tecmor	Information from manufacturer: E. Goffaux, 1-3 rue Emile Gossiaux, 6311 Villers-Perwin/Belgium
Aebi ASP 350 automatic hydraulic press, output 1440 bricks/hour	Bibl. 01. Manufacturer: Robert Aebi SA, 8023 Zürich/Switzerland
Duplex Emperor mechanical brick-making press, output 2600 bricks/hour	Bibl. 01. Manufacturer: Sutcliffe Speakman & Co.Ltd., Leigh, Lancashire/England
ACCETTA. Presse "DYNATERRE"	Bibl. 06. Manufacturer: André Accetta, 1'Ecole d'Architecture de St. Etienne, 1 rue Buisson, 42000 St. Etienne/France
Teroc T 14 (1 block/cycle) and T 4 (4 blocks/cycle)	Bibl. 33. Manufacturer: Saret, B.P. 102, Route de Carpentras, 84130 Le Pontet/France
CTBI Automatique (L.P.F. 500) output 350 - 400 bricks/hour	Bibl. 33. Manufacturer: CTBI; Zone Industrielle, 51140 Muizon/France
GEO 500 Auto-Bloc electrically powered automatic press, output 300 bricks/hour	Information from manufacturer: SOUEN, Centre de Terre, Lavalette, 31590 Verfeil/France. The press (also called "Tunnel") was constructed to produce bricks for the centre's own use

3.2.4 Soil block presses, which are not being produced anymore

BLOCK PRESS	SOURCE OF INFORMATION / COMMENTS
MACHINE A BRAS No. 1	Bibl. 06, see Illustration "Le Musée des Presses"
PRESSE PM A BRAS	- ditto -
PRESSE RAPIDE No. 5	- ditto -
MACHINE HOUDRA TYPE C	- ditto -
DAMETTE No. 1	- ditto -

BLOCK PRESS	SOURCE OF INFORMATION / COMMENTS
MACHINE PNEUMATIQUE TYPE 810	Bibl. 06, see Illustration "Le Musée des Presses"
PILONNEUSE A BRAS TYPE PBB	- ditto -
PILON GUIDE SYSTEME D	- ditto -
PILON GUIDE CANADA	- ditto -
PRESSE EN BOIS	- ditto -
HERCULEENNE	- ditto -
PRESSE CURER	- ditto -
LA MADELON	Information from manufacturer: E. Goffaux, Les Ateliers de Villers-Perwin, 1-3 rue E. Gossiaux, 6311 Villers-Perwin/Belgium. Patented in the year 1904, designed for use in the Belgian Congo (Zaire).
SUPER MADELON/STABIBLOC	Improved version of LA MADELON
LANDCRETE	Same as SUPER MADELON, but produced by Landsborough Findlay Ltd., Johannesburg/South Africa
FIB-SM	Same as SUPER MADELON, but produced by Le Four Industriel Belge, 14 rue des 3 Arbres, 1180 Brussels/Belgium
LA MAJO	Developed by Les Ateliers de Villers-Perwin in 1933, as a motor-driven version of SUPER MADELON, now built with minor modifications under the name SEMI-TESTAMATIC
LA MAJO MATIC	Developed by above firm in 1953, now produced with slight changes under the name CERAMATIC
FIB-MM	Same as la MAJO-MATIC, produced by Le Four Industriel Belge
WINGET Rotary Hydraulic Block Press	Details obtained from D. Webb, Building Research Station, Garston. Machine developed and produced by Winget Ltd., Rochester, Kent/England
10 P / 11 P	Bibl. 01, 06. Modification of WINGET Block Press, manufactured as prototypes by Guilhon Barthelemy, 18 rue de Mont Favet, 84 Avignon/France
MMH 2000 (rotary hydraulic press with single block moulds) / MMH 4000 (same machine with double block moulds)	Bibl. 01, 06, also information from M. Platbrood. The machine is basically the PRESSE MAJO-MATIC HYDRAULIQUE developed in 1976 by Les Ateliers de Villers-Perwin. Also produced by Fernand Platbrood, 20 rue de la Rieze, 6404 Cul-des-Sarts, Couvin/Belgium
POWER TEK BLOCK hydraulic press with 4 rotating mould boxes, producing 300 blocks/hour with compaction pressure of 7 N/mm ² .	Bibl. 01, 06. Prototype developed at Dept. of Housing and Planning Research, UST Kumasi/Ghana, to achieve higher output, cheaper and stronger bricks than the manually operated TEK BLOCK press
CLU 2000, self-contained, hydraulic block press on wheels, with 4 step rotating table, output 360 - 500 blocks/hour	Bibl. 01, 06, 33. Jointly designed by Consolid AG, Aechelistr. 18, 9434 Heerbrugg/Switzerland, and Lescha KG, Ulmer Str. 249/251, 8900 Augsburg/FR Germany
TOB-System/Soterep self-contained hydraulic press on wheels, with 3 step rotating table, output 350 - 400 blocks/hour	Bibl. 33 and information from SOUEN/ARCHECO, Centre de Terre; Lavalette, 31590 Verfeil/France. Although the press functioned well, mounting it on a wheeled chassis was found to make it unnecessarily cramped, complicated and expensive. Thus it was succeeded by the GEO 500 Semi-Bloc.

FIGURE 235

LE MUSEE DES PRESSES

MACHINE A BRAS N° 1

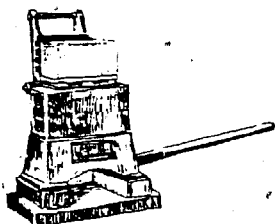

Le mélange est tassé par pilonnage à l'aide d'un couvercle lourd qui évite ainsi une partie du pilonnage à la pilette. Démoulage par fond de moule montant. Permet la fabrication d'un parpaing à la fois.

Matériel Bonnet.

PRESSE PM A BRAS

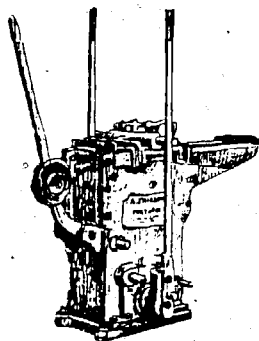

Presse à simple compression directe donnée par un arbre coudé et une bielle qui soulève le piston de compression. Deux leviers transmettent le mouvement à l'arbre coudé. Un levier de démoulage permet l'éjection du parpaing. Deux ouvriers, un parpaing à la fois. Pression: 10 à 15 Kg/cm². Moule: 20 x 20 x 40.

Matériel Thiebault.

PRESSE RAPIDE N° 5

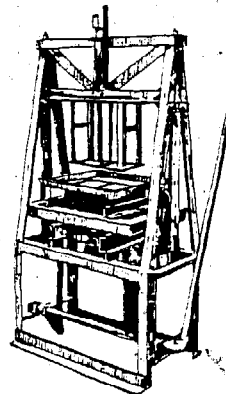

Pilonneuse à bras avec ressorts de rappel. Main d'œuvre: 1 ou 2 ouvriers. Poids de la presse équipée d'un ou deux moules et pilon, en caisse 345 Kg.

Matériel société franco-alsacienne.

MACHINE HOURDA TYPE C

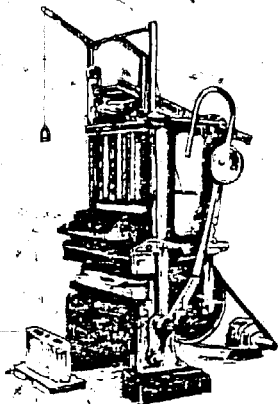

Pilonneuse à moteur. La frappe est basée sur le principe du petit marteau pilon (courroie de friction et volant d'inertie). Cette frappe est sèche. Remplissage des moules en deux ou trois fois, et pilonnages successifs. Démoulage par montée des moules. Dimension maxima des produits 70x30x25. Puissance nécessaire 2cv 1/2. Poids sous emballage maritime 1050kg.

Matériel Bonnet.

DAMETTE N°1

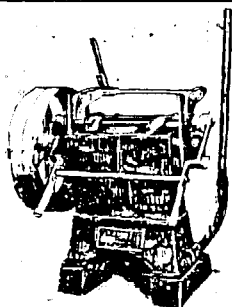

Machine à agglomérer, à moteur. Compactage assuré par un pilon de 90kg actionné par came; un parpaing à la fois. Puissance nécessaire 2cv. Poids sous emballage maritime 1000kg.

Matériel Bonnet.

Voici des exemples de presses qui n'existent plus sur le marché... mais qui peuvent donner quelques idées...!!



MACHINE PNEUMATIQUE TYPE 810

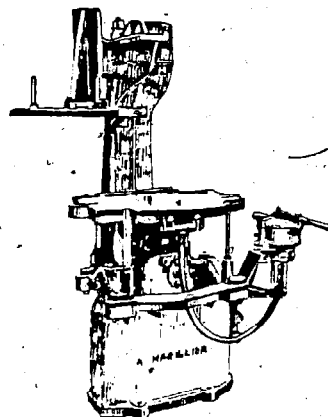

Ce genre de machines, utilisé pour la fabrication de moule de fondrie, doit convenir pour le compactage de la terre, si l'on dispose d'un compresseur. La table fait corps avec un piston de 16 cm de diamètre, actionné à l'air comprimé à 6-7 Kg. A l'intérieur du piston, une masse mobile peut compléter l'action de ce dernier en frappant le dessous de la table à une cadence réglable à 800 coups minutes. En haut, le pontre-plâteau est fixe dans le sens vertical et éclipse latéralement. Puissance absorbée au compresseur: 3cv. Poids: 400 Kg.

Matériel Marillier.

FIGURE 236

PILONNEUSE A BRAS TYPÉ PBB

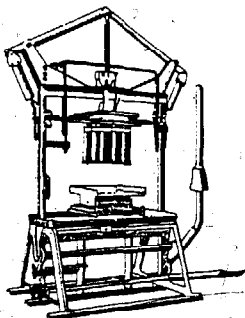

Pilonneuse à bras avec ressorts de rappel
Main d'oeuvre 1 ou 2 ouvriers
Poids net 500 Kg
Matériel Bonnet

PILON GUIDE SYSTEME D



La frappe est basée sur le principe du marteau pilon guidé entre deux cornières
Moule 30 x 15 x 25
Extrait des Sélections du Système D n° 23

PILON GUIDE CANADA

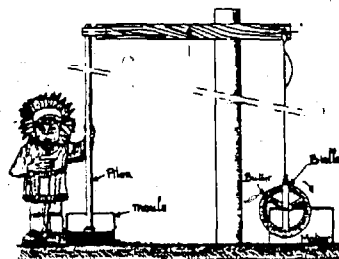

L'opérateur guide le pilon pour parcourir toute la surface du moule rempli de terre. Le pilon frappe 15 coups par minute. Il faut environ 4 minutes pour réaliser un bloc.
University of Saskatchewan, Saskatoon, Saskatchewan.

PRESSE EN BOIS

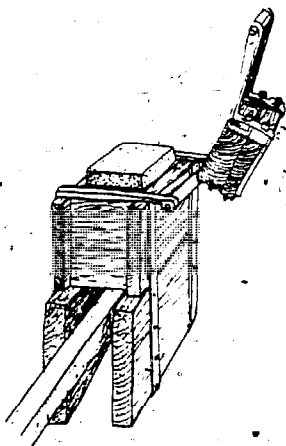

Conçue par le BIT de Dakar et employée en Afrique occidentale.

HERCULEENNE

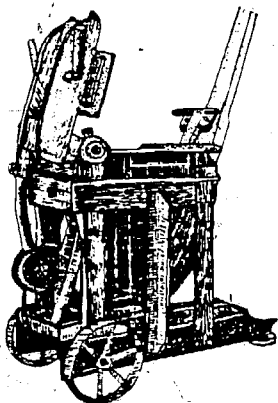

Presse à bras en acier soudé qui était livrée avec des moules permettant de fabriquer des briques de 220 x 102 x 70 mm, d'autres formats étaient disponibles et il existait également des moules permettant de fabriquer des carreaux, des tuiles, des demi-tuyaux... C'est l'ancêtre de la S.H. Landreth, Terstaram... Villers Perwin.

PRESSE CURER

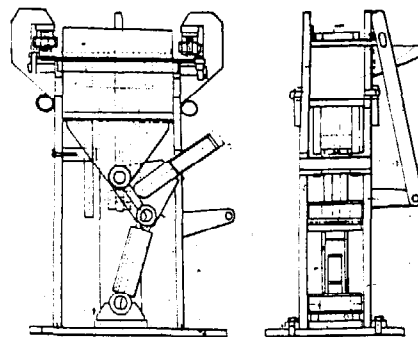

Presse Curer conçue à l'Université de Constantine, Algérie.
Prototype Dimension (Lxlxh) 38x25x50 cm
Poids net : 700 Kg - Pression en Kg/cm² 10 à 20
Taux de compression : 1,25 - Profondeur mini du moule : 120 mm - Course maxi du plateau : 30 mm - Dimension des briques 25 x 12 x 9,8 - Production par jour : 300
Nombre d'ouvrier : 2

FIGURE 237

LA MAJO

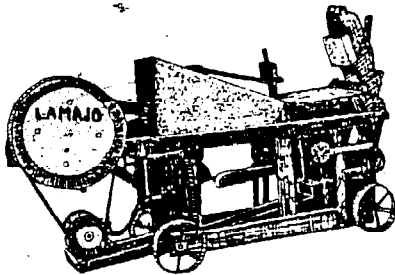

Presse mécanique à moteur effectuant l'opération pressage et démoulage en 2,5 secondes, la production est donc en rapport avec le temps mis pour le remplissage des moules et l'enlèvement des briques. Dimension (L x L x H) 66 x 200 x 108 cm. Poids net 720 Kg. Moteur à Essence ou électrique. Taux de compression 1,65. Briques 29,5 x 14 x 88 cm. Production par jour 3600. Profondeur max du moule 145 mm. Course max du plateau 58 mm. Matériel Villers Perwin.

LA MAJOMATIC

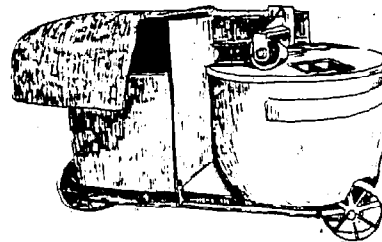

Presse mécanique à plateau tournant avec remplissage, compression et éjection synchronisés. Dimension (L x L x H) 66 x 200 x 120 cm. Poids net 1500 Kg. Moteur Essence 3 cv 10/h. Diesel 5 cv 15/h. Taux de compression 1,6. Briques 30 x 23,5 x 88 cm. Production par jour 4000. Profondeur maxi du moule 128 mm. Course maxi du plateau 48 mm. Nombre d'ouvriers 3. Matériel Villers Perwin. Similaire à la presse HALLUMKA.

WINGET

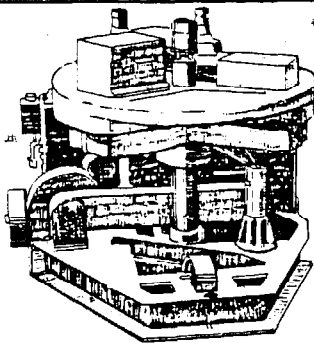

Presse hydraulique à plateau tournant avec remplissage, compression et démoulage synchronisés. Poids net 1000 Kg. Moteur à essence. Pression en Kg F/cm² 75. Dimension des briques 30 x 15 x 10 cm. Nombre de briques par jour 1120. Matériel Winget works, Rochester, ne 24AA, 3-3.

10 P 11 P

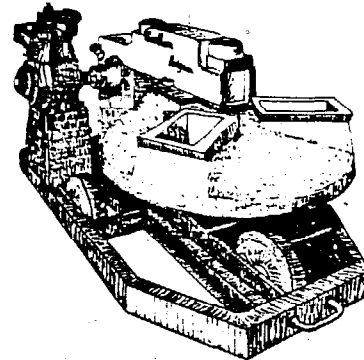

Presse hydraulique à plateau tournant avec remplissage, compression et démoulage synchronisés. Poids net 1000 Kg. Moteur à Essence. Pression en Kg F/cm² 75. Dimension des briques 30 x 15 x 10 cm. Nombre de briques par jour 1120. Matériel Guilhaon Barthelemy 10 AN de Montfort St Amand le même type que la presse Winget. Un seul exemplaire construit.

POWER TEK BLOCK

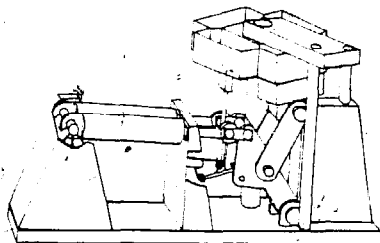

Presse hydraulique à plateau tournant avec remplissage, compression et démoulage synchronisé. Dimension (L x L x H) 56 x 113 x 56 cm. Pression en Kg F/cm² 24. Dimension des briques 30 x 22 x 15 cm. Production 2000 jour. Prototype de la Faculté d'Architecture UST KUMAS.

MMH 4000

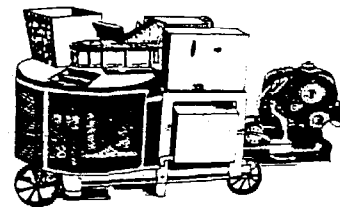

Presse hydraulique à plateau tournant avec remplissage, compression et démoulage synchronisés. Dimension (L x L x H) 100 x 230 x 150 cm. Poids net 1200 Kg. Moteur diesel Bernard 20 cv. Taux de compression 2,8. Profondeur max du moule 225 mm. Course maxi du plateau 120 mm. Dimension des briques 29,5 x 14 x 88 cm. Production 4000 par. Matériel Villers Perwin. 1 seul prototype construit.

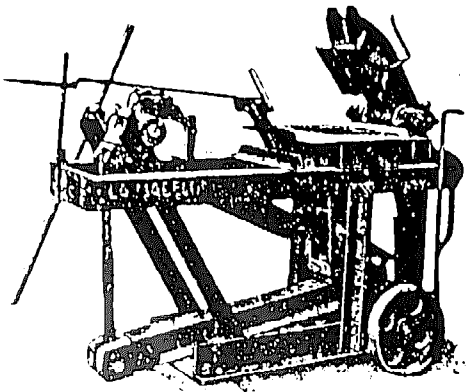

PRESSE A BRIQUES LA MADELON

(Système GOSSIAUX, breveté S. O. D. G.)

Ateliers de Construction

Belgique - VILLERS-PERWIN (Hainaut)
France - Route de Marcourt AVION (P. de C.)

VENTE : Franco gare belge
Franco gare française
E. O. B. Anvers, emballage compris
C. I. F. toutes destinations

La Meilleure Presse à Briques

Rendement Maximum

La première presse à menotte fut inventée par nous en 1904 et brevetée sous les n° 176.015 et 176.093

« LA MADELON » est le dernier modèle de presse à menotte. C'est le fruit de 20 ans d'expérience dans la construction de ce genre de presse, elle nous a valu de nombreuses marques de satisfaction de la part de nos clients, tout le monde ne dit pas que « La Madelon » est la meilleure presse à briques, il y aura toujours des gens qui voudront avoir des idées contraires aux autres, mais la généralité admet que c'est une bonne machine.

Ce n'est pas une machine miraculeuse qui triomphe de tout, qui permet des productions et des pressions folles sans effort, mais avec une « Madelon », de la terre convenable et des ouvriers de métier l'on est tranquille pour faire sa campagne, on ne peut pas toujours en dire autant avec ces machines qui doivent aller toutes seules et tout révolutionner.

USAGE. — La « Madelon » est employée pour la fabrication des briques en terre franche. Nous pouvons placer sur « La Madelon » des moules pour briques creuses, briques moulurées, tuiles, carreaux, tuyaux, bordures et tous autres produits pouvant se mouler par compression.

PRESSIION. — Le levier de « La Madelon » est différentiel, sa puissance augmente au fur et à mesure que la terre se compacte et que la résistance augmente; l'effort de l'ouvrier est ainsi transmis aux produits avec le maximum d'efficacité, la combinaison de levier étant très simple il y a peu de perte par frottement.

FONCTIONNEMENT. — L'ouvrier ne doit, ni se déplacer, ni sauter, ni se baisser, le travail pénible et la gymnastique fatigante nécessaire avec les anciennes machines à bras sont supprimés; il lui est ainsi épargné un déplacement de 18 kilomètres par 10,000 briques fabriquées.

Nous donnons ci-dessus la façon de se servir de « La Madelon », sans déplacement et sans contorsions aucunes, contorsions que certains ouvriers croient indispensables.

PRODUCTION. — Nous avons des centaines d'équipes qui font couramment 10,000 briques par jour; on nous a cité certaines équipes d'élite arrivant à 14,000 briques par jour.

Toutes les machines à briques ont à peu près la même production suivant la terre employée, l'habileté et la voléité des ouvriers, les facilités du chantier, etc. il n'y a jamais en effet que la façon d'agir sur le levier qui diffère et sauf pour les anciens systèmes qui obligent à des déplacements conséquents, cela ne peut avoir beaucoup d'influence sur la production.

C'est ainsi qu'il est toujours possible de montrer une équipe qui fait 1,000 briques à l'heure avec une machine quelconque, mais si après quelques temps la machine mal conçue ou mal construite commence à se dilocker et à occasionner des pertes de temps, la production devient vite irrégulière.

C'est ce que l'on évite avec la « La Madelon », tous ceux qui s'en servent sont d'accord pour dire qu'elle est d'un entretien facile, simple et de bonne construction, ce sont ces qualités qui ont fait sa renommée.

CONSTRUCTION. — Notre construction est entièrement métallique, nos pièces rigoureusement interchangeables, les axes sujets à usure tournent dans des coussinets munis de bagues remplaçables, ce qui permet de remettre la machine à neuf sur place à peu de frais.

Nous pouvons dire que c'est une presse à briques de construction parfaite.

MOULES. — Nos moules sont garnis en acier extra dur ou en cuivre au gré du client et aux dimensions demandées par celui-ci.

Nos moules peuvent être retournés en quelques minutes, ce qui permet d'en doubler la durée.

AVANTAGES. — La fabrication avec la presse « Madelon » demande beaucoup moins d'eau, moins de place et moins de sable que pour l'ancien procédé à la main, les briques sont de plus belle apparence, moins rugueuses et à arêtes plus vives.

Nous remettons avec chaque machine un tableau des pièces de rechange avec leur numéro. L'on peut toujours se procurer des pièces en nos ateliers à Villers-Perwin, en nos bureaux de Bruxelles et chez de nombreux dépositaires dans tout le pays et aux colonies.

IMPORTANT. — « La Madelon » est d'un fonctionnement parfait. Elle a fait ses preuves et toute modification apportée ne peut que nuire à la machine. Si « La Madelon » ne vous donnait pas un résultat satisfaisant, soyez persuadé que cela ne peut provenir que d'un manque d'expérience ou d'une terre mal préparée ou ne convenant pas. Présentez-nous et nous ferons tout notre possible pour vous aider. Mais ne modifiez jamais.

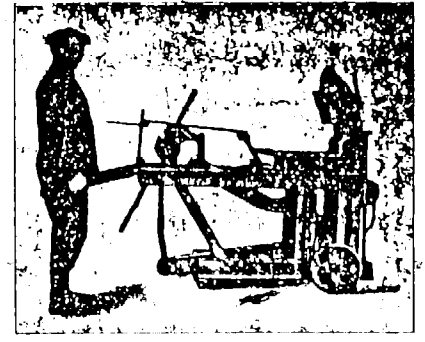

LA MADELON se déplace facilement, pas de perte de temps.

Pour se servir avantageusement de la Presse à Briques LA MADELON

« La Madelon » est certainement la presse la plus répandue. Avec « La Madelon » l'ouvrier ne doit ni se baisser, ni courir, ni sauter. — Certains ouvriers s'en servent encore de façon défectueuse, soit qu'ils se baissent pour aller prendre la manette au commencement de la pression ou qu'ils appuient trop profondément et inutilement pour finir la pression. — Les six figures ci-dessous montrent la façon de se servir de « La Madelon » sans mouvement inutile et sans aucune contorsion. — Nous conseillons aux débutants et même à ceux qui s'en servent déjà de s'appliquer à travailler comme indique ci-dessous, ils éviteront tout mouvement inutile, donc de se fatiguer inutilement tout en faisant de la bonne besogne, ils travailleront aussi sans brutalité et fatigueront aussi moins la machine.

REMARQUE. — Pour achever la pression l'ouvrier dispose de tous ses moyens et il peut agir de tout son poids.

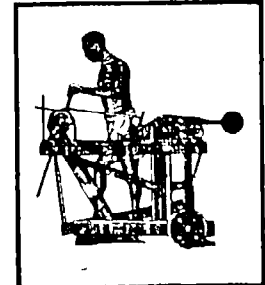

Fig. 1
Pour PRESSER — Saisir de la main gauche le petit bout de la manette et l'amener horizontalement.



Fig. 2
Saisir le long bout de la manette de la main droite et l'amener perpendiculairement.

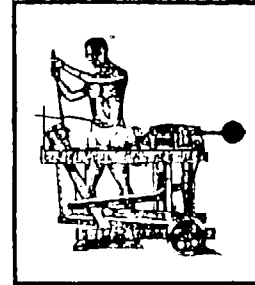

Fig. 3
Se servir de ses deux mains.

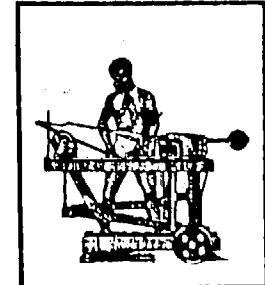

Fig. 4
Achever la pression sans se baisser, sans pousser.



Fig. 5
Pour DÉMOURER — Laisser retourner la manette d'elle-même à la vitesse de la main droite.



Fig. 6
Achever le démoulage comme indiqué ci-dessus.

Tuiles genre "MARSEILLE"

LA SUPER MADELON COLONIALE

SANS CHAÎNE

La Super Madelon Coloniale sans chaîne fonctionne comme la Madelon ordinaire, mais avec plus de facilité étant montée sur roulements lisses. Une seconde menotte permet à celui qui enlève les briques d'aider le presseur, avantage très apprécié des indigènes; en même temps la pression étant exercée par les efforts conjugués des deux hommes, est fortement augmentée.

Sur la Super Madelon pour briques, on peut placer des moules pour la fabrication des tuiles, carreaux, tuyaux, briques trouées, moulurées, etc., il n'est donc pas nécessaire de demander une machine spéciale si à l'avenir on veut faire ces différents produits. Les moules et accessoires nécessaires peuvent toujours être obtenus et placés sur la presse sans modification.

La Super Madelon est employée par de nombreux colons qui ont constaté après essai que la production est généralement 20 % plus forte qu'avec les presses à bras.

La Super Madelon Coloniale emballée en une caisse en planches de 25 mm. ne cube que 7.50 dm³ et ne pèse que 450 kgs.

C'est une Madelon renforcée et perfectionnée, son poids et son volume sont restés sensiblement de même parce que les renforcements consistent en l'emploi de fer au lieu de fonte et d'acier de forte résistance.

Les quelques caractéristiques qui précèdent justifient bien son surnom de **Coloniale**.

Outre les nombreux avantages de la Madelon facilités de fonctionnement, d'entretien et de déplacement, nous avons par les perfectionnements suivants fait de la Super Madelon une machine idéale à tous points de vue.

Le coude de pression, auparavant en fonte, est en acier forgé, la chaîne de pression est remplacée par une bielle articulée. Ces organes essentiels, peuvent faire un million de briques sans graissage et sont pratiquement indégradables et inusables.

Le levier de démoulage placé au centre de la machine, est approprié de façon à pouvoir fabriquer des briques ayant jusque 8 cm. d'épaisseur.

Les organes de pression, coude, bielle, etc., sont protégés par un carter en tôle qui les met à l'abri des projections de terre et de sable, ce qui leur assure une longue durée.

Le couvercle est équilibré de façon qu'il s'ouvre et se ferme avec une aisance parfaite.

Le nouveau système de fermeture, dont les pièces sujettes à usure sont facilement remplaçables et à peu de frais, y est appliqué.

Les moules se retournent avec une facilité que l'on ne trouve dans aucune autre machine.

Le sommier de pression est monté de telle sorte que la terre ne reste jamais sur ses articulations et, de ce fait, l'usure est pratiquement nulle.

Montée sur roues, et munie de menottes pour la conduire, elle se déplace très aisément sur le chantier.

Les principales pièces de la Super Madelon, telles que couvercle, sommier de pression, fermeture, etc., sont les mêmes que celles employées dans la Madelon au moteur et qui ont été étudiées pour un travail beaucoup plus dur que dans les presses à main.

Les pièces étant parfaitement interchangeables, son entretien est facile et les réparations peu coûteuses.

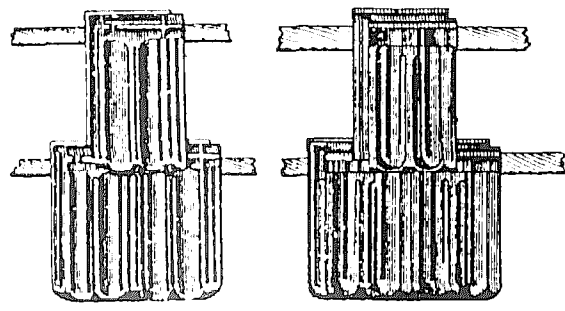

Genre "FLAMAND"

Genre "POLLICHEN"

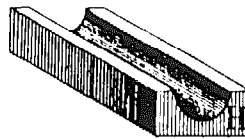
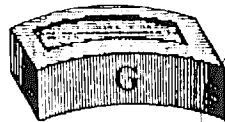
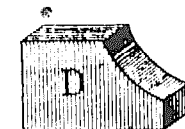
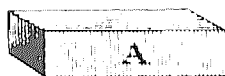
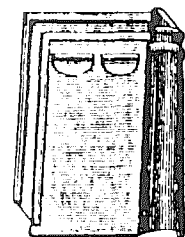
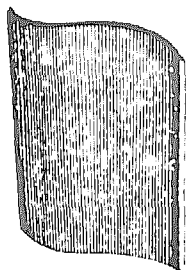

PRESSES A BRIQUES
E. GOSSIAUX

Ateliers de Construction :
Villers - Perwin (Hainaut)
Tel. Mellcet 29

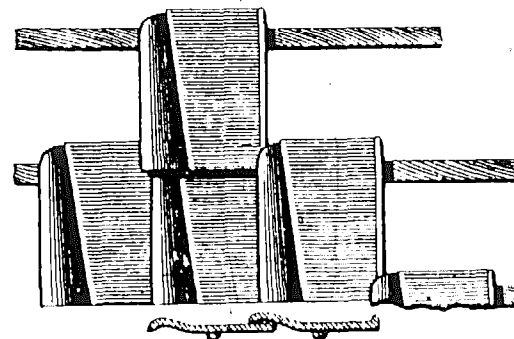
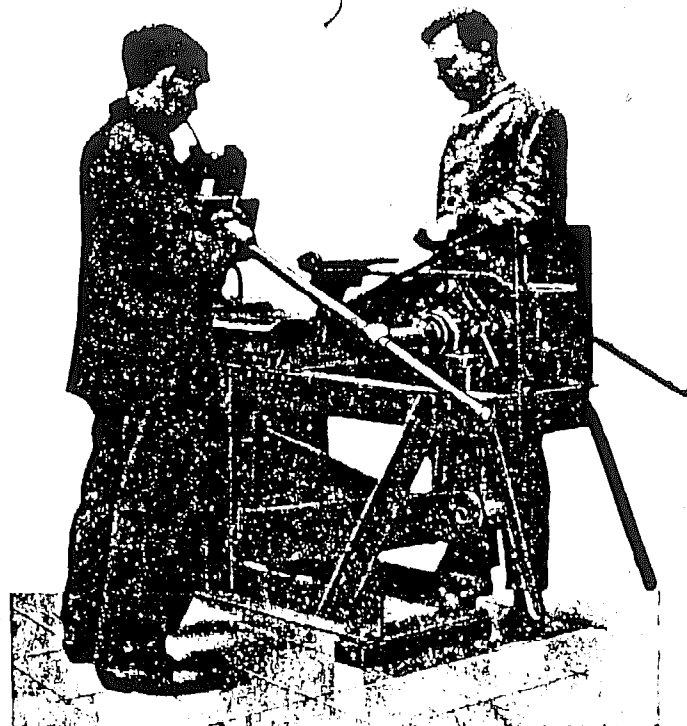

Rien n'a été négligé pour faire de la Super Madelon une machine nettement supérieure, son prix un peu plus élevé que celui des machines concurrentes, est amplement justifié par les nombreux avantages qu'elle réunit.

La Super Madelon Coloniale est une machine dont on dit : Je l'ai payée un peu plus cher, mais au moins j'ai une bonne machine qui finalement est plus économique qu'une autre « à bon marché » surtout aux colonies pour où les frais d'emballage et de transport sont très élevés, qu'il s'agisse d'une machine médiocre ou d'une Madelon.

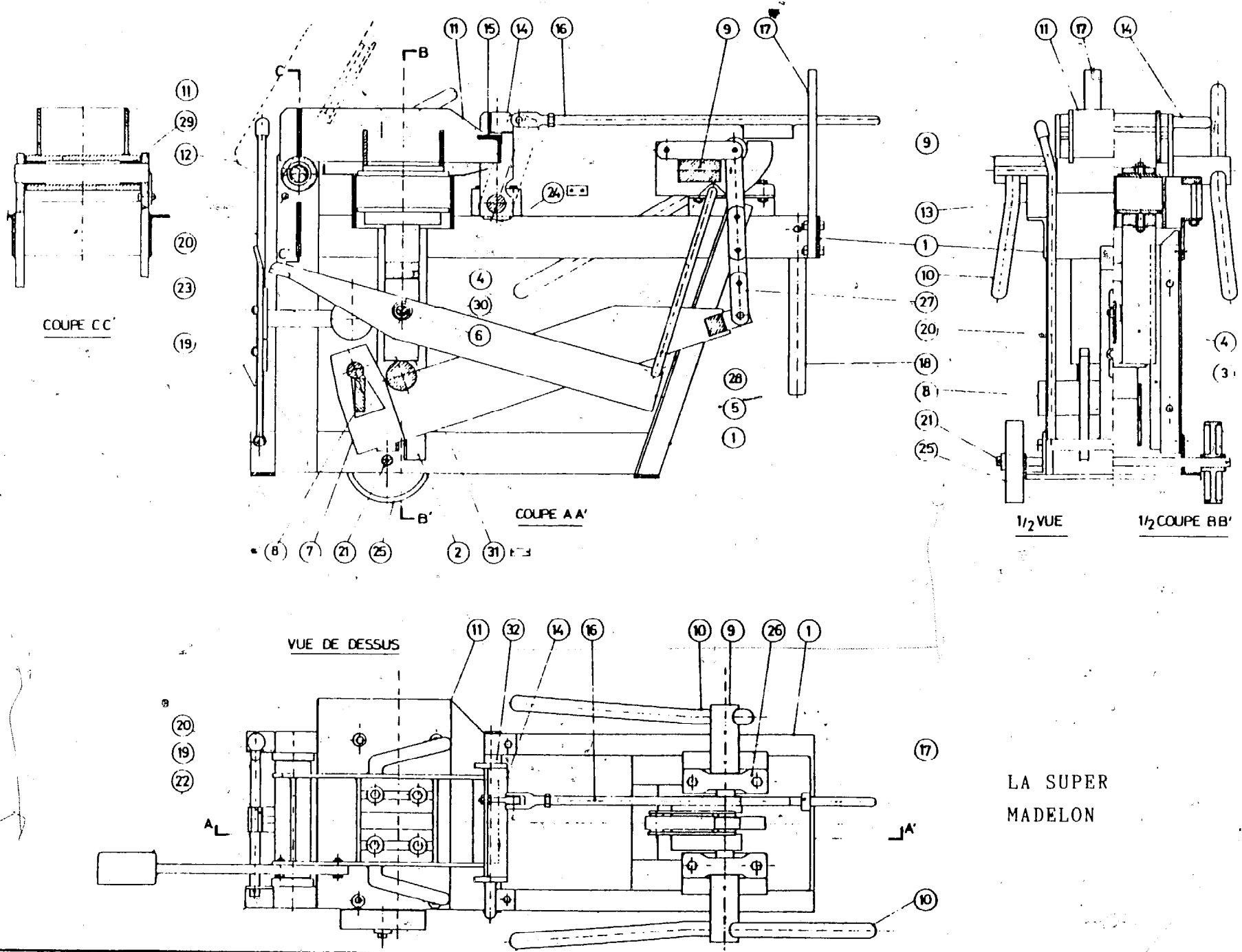

LA SUPER
MADELON

Village
Ortekwaofro

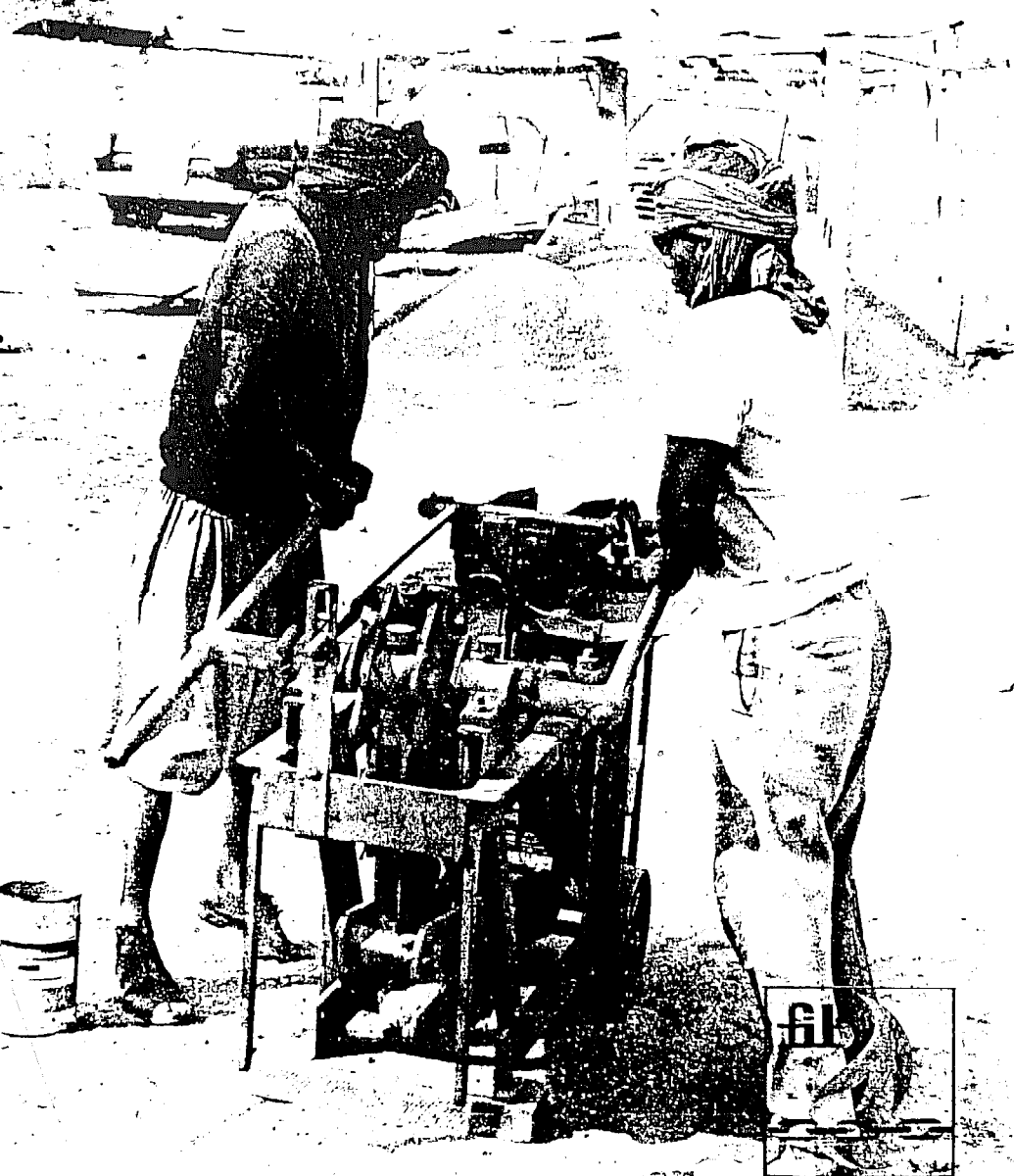

Rep	Nombre pièces	Désignation	N° Pièces
1	1	bâti de la machine	3101010
2	2	support du guide piston	3101020
3	2	guide du piston	3101030
4	1	piston	3101040
5	1	levier de démoulage	3101050
6	1	axe du levier de démoulage	3101060
7	1	sommier de pression	3101070a
8	1	support du sommier de pression	3101080
9	1	coudé de pression	3101090
10	2	menotte de manoeuvre	3101100
11	1	couvercle	3101110
12	1	axe de couvercle	3101120
13	2	palier de la fermeture du couvercle	3101130
14	1	fermeture du couvercle	3101140
15	2	pièce d'usure de la fermeture	3101150
16	1	tringle de fermeture	3101160
17	1	support tringle	3101170
18	2	menotte pour conduire	3101180
19	1	support de démoulage	3101190
20	1	levier de déclenchement	3101200
21	1	axe des roues	3101210
22	1	contrepois du couvercle	3101220
23	1	contrepois du levier de déclenchement	3101230
24	1	plaques de réglage	3101240
25	2	roues Ø 200	série 87 n° 100-870-200
26	2	paliers	type UCIP 208
27	1	chaîne de compression - type M112 DIN 8167	3101250
28	1	chaîne de démoulage 1" x 19 maillons	DIN 8187
29	2	coussinet du couvercle EG Ø 45/55 x 40	DIN 1498
30	1	coussinet du levier de démoulage EG Ø 25/32 x 40	DIN 1498
31	-	plaques de réglage	3101260
32	2	entretoises - moule - table - plateau du piston - plateau du couvercle	3101270

HAND AND MOTOR PRESSES FOR BRICKS AND TILES - - OIL PRESSES

E. GOSSIAUX ● Workshops : Villers-Perwin (Hainaut) Belgium

Offices: VILLERS-PERWIN (Hainaut-Belgium) tel. Mellet 29 and 55, rue de Suède, BRUSSELS (Belgium) tel. 38.29.81

"LA MAJO" MOTOR BRICK PRESS

« LA MAJO » having proved itself in Belgium, we have no hesitation in recommending it for other countries.

Moulds for tiles, holed bricks, moulded bricks, etc. can all be placed on the « LA MAJO » brick press. There is therefore no need to order a special machine if at some future date it is desired to manufacture these articles. The necessary moulds and accessories can always be obtained and placed on the press without making any alteration.

MANUFACTURING WITH « LA MAJO » : The work is exactly the same as with hand presses, but the bricks are pressed and turned out of the mould automatically in 2 1/2 seconds, without any effort on the part of the workman; he merely has to pull down the clutch lever.

This is an appreciable advantage when the labour available is of limited ability and disinclined to make the necessary effort to press properly.

PRESSURE : The « LA MAJO » is designed to give a pressure comparable to that which a man weighing 22 stone, and never tired, could apply with a hand press. One may therefore count on obtaining properly pressed bricks.

THE « LA MAJO » MAY BE ENTRUSTED WITHOUT APPREHENSION TO EVEN THE LEAST SKILLED WORKMAN. — We are unaware of any mistake, imprudence or faulty handling which could cause any sort of damage whatsoever. Provided that the operator works more or less reasonably, the « LA MAJO » will never give any trouble.

The machine is built to press as would a man weighing 22 stone. If for any reason it is called upon to make a greater effort, it stops. Pebbles or bits of iron may find their way into the moulds (or even be placed there purposely) without causing the slightest accident. The clutch hook merely has to be lifted for work to be continued.

UPKEEP. — Since the machine stops if an abnormal demand is made upon it, any breakage or forcing is avoided, as is, of course, premature wear. As the « LA MAJO » works smoothly and effortlessly, upkeep is often less than for a hand press.

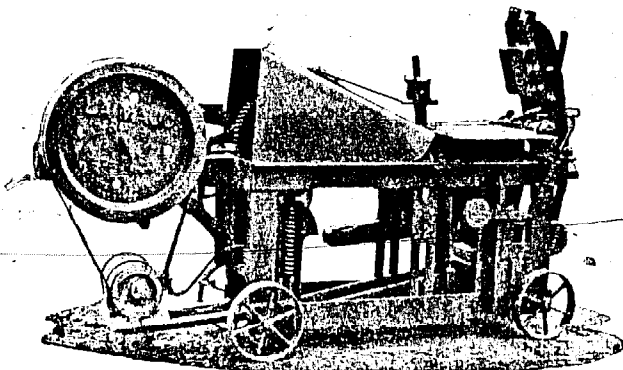

Improved, simplified and **THE RESULT OF LONG EXPERIENCE**, the « LA MAJO » is perfect down to the smallest detail. All parts are changeable and can be replaced on the spot without calling in an experienced workman; no parts are wedged. The two gears are of steel cut in the casting and no case is known of one of these beaking on the « LA MAJO ».

PRODUCTION. — The « LA MAJO » presses and turns out in 2 1/2 seconds; production is therefore in relation to the time taken to fill the moulds and take out the bricks.

In Belgium the average production is 1,000 to 1,200 bricks per hour; some shifts even manage 1,500 per hour. The moulds are designed to take two bricks at a time. The following table shows the time taken for each operation.

The first column shows the number of bricks per hour; the second column gives the time taken per pair of bricks made; the third column the time taken for filling the mould and taking out the bricks.

Per hour.	Time per pair.	Filling and taking out.	Per hour.	Time per pair.	Filling and taking out.
1,500	4 8/10"	2 3/10"	900	8"	5 5/10"
1,400	5 1/10"	2 6/10"	800	9"	6 5/10"
1,300	5 5/10"	3"	700	10 3/10"	7 8/10"
1,200	6"	3 5/10"	600	12"	9 5/10"
1,100	6 5/10"	4"	600	14 4/10"	11 9/10"
1,000	7 2/10"	4 7/10"			

The figures are based on 2 1/2" for pressing and turning out. In practice this is the best time for a motor press.

Naturally, with a motor the pressing and turning out could be done more quickly but not only would there not be much point in that, since the workman is picking up the earth and conveying it to the press during this time, but also it is injurious to the quality of the bricks.

Automatic presses seldom make good bricks, not only because one often has to work with earth that is too dry, but also because the pressing is nearly always done too hurriedly.

The pressure being quite sufficient and always taking 2 1/2 seconds, irrespective of the workman, it is simply a matter of organizing properly the preparation of the earth and the evacuation of the manufactured article, to obtain well-made bricks and good production.

Our Belgian workmen generally fill the moulds and take out the bricks in 4 seconds, so that however limited may be the ability of an unskilled worker he can easily do the same work in double the time and turn out 700 well-pressed bricks an hour.

The extra trouble taken to moisten and prepare the earth properly causes time to be saved in moulding, and careful preparation is in the manufacturer's own interest.

We stress this point, for some people consider that time spent in preparing the earth is partly time wasted, whereas lack of preparation is often the source of all the troubles.

There are also those who imagine that a stronger pressure can make up for a lack of preparation. By heavily pressing badly prepared earth, bricks can be made which are of good appearance when turned out of the moulds, but if the earth has not been mixed sufficiently the drying and firing is not so regular and the bricks are less homogeneous. The result is an expenditure in motive force and upkeep of material, far greater than the economy made in preparing the earth, while at the same time the article produced is of poorer quality.

We have prepared a booklet giving advice regarding the choice of earth, its preparation, and the organization of work for manufacturing bricks with a press. This booklet is supplied with all our presses and is freely at your disposal.

MOTIVE FORCE NECESSARY. — The « LA MAJO » is fitted with a 1.35 HP electric motor or a 1.5 HP petrol motor. Both types of motor are supplied complete with appropriate support and pulley. The fly-wheel of the press must run at a speed of 300 to 320 revolutions per minute; an arrow indicates the direction of rotation. The kinetic energy of the fly-wheel makes the pressure obtained comparable to that of a press without fly-wheel driven by a 6 HP motor.

PACKING. — The « LA MAJO » is packed completely assembled, in a 4/4 wooden case, reinforced, braced and hooped and measuring 2 metres in length, 0.655 metres wide and 1.08 metres in height; gross weight 725 kilos, net weight 590 kilos.

The necessary electric motor can be placed in the same case without any increase in size.

30

Presses à Briques, à Tuiles, etc., à Main et au Moteur

MACHINES POUR BLOCS EN TERRE, EN BÉTON, ETC. - MALAXEURS - PRESSES A HUILE A MAIN

Ateliers de Constructions de Villers-Perwin

E. GOSSIAUX

Téléphone MELLET (07) 74.10.29

Compte Chèques Postaux Bruxelles 943.80

(de Madame M. L. GOSSIAUX)

Télégrammes :

GOSSIAUX-PRESSES VILLERS-PERWIN

Code A.B.C. 5th Edition

R. C. Charleroi 22864

PRESSE A BRIQUES A MOTEUR " LA MAJO-MATIC "

Messieurs,

Veillez trouver ci-jointes, les références que quelques clients ont eu l'amabilité de nous envoyer.

Ces témoignages sont la plus sûre garantie de la qualité de notre matériel et de l'intérêt qu'offre notre "MAJO-MATIC".

Nous vous prions d'agréer, Messieurs, l'expression de nos sentiments distingués.

Ateliers GOSSIAUX



Mijne Heren,

Gelieve hierbij de referenties te vinden die enige klanten de vriendschap hadden ons te zenden.

Deze getuigenissen, zijn de zekerste waarborg der kwaliteit van ons materieel en het belang welke de "MAJO-MATIC" aanbiedt.

Wij bidde u, Mijne Heren, de verzekering onzer oprechte groeten te aanvaarden.

Met hoogachting,

Werkhuizen GOSSIAUX.



Better, cheaper
and
faster construction
with
stabilised soilblocks

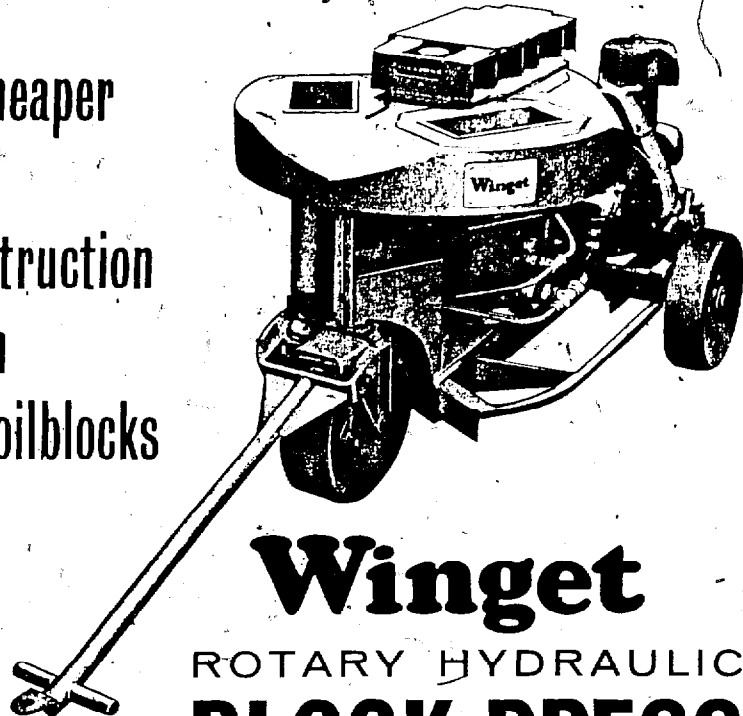

Winget

ROTARY HYDRAULIC BLOCK PRESS

A HIGHLY EFFICIENT MACHINE PRODUCING BLOCKS OF
EXCEPTIONAL STRENGTH



THE WINGET ROTARY HYDRAULIC BLOCK PRESS

BRIEF SPECIFICATION

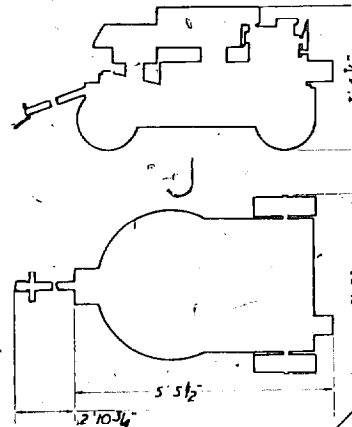

The machine incorporates hydraulic pressing of the material and hydraulic ejection of the finished block together with manual rotation of the mould table. The power unit of the standard machine is an air-cooled diesel engine, coupled to a hydraulic pump. An electric motor can be fitted as an alternative power unit if required.

The rotary mould table contains three mould boxes and there are three operating stations; for charging the mould box, compressing the material and ejecting the finished block. All three stations are in use together and thus three blocks are in course of production at one time. The cycle of operations being continuous.

Two levers control the operation of the machine; one raises and lowers the rams and the other locks the mould table in its correct position.

These two controls are mechanically interlocked, thus ensuring that the three mould boxes are correctly positioned before pressure is applied. This mechanism is simple, rapid in operation and completely foolproof.

Both pressing and ejecting rams are double acting and are protected against fine dust. The pressing ram works to a definite stop, ensuring that all blocks are of equal thickness. The load applied by the pressing ram is 45 tons, 1,390 lbs. p.s.i. on a 12 in. x 6 in. block, and when this pressure is attained a tell-tale gives the operator a visible signal.

The whole machine is robustly constructed and is mounted on metal wheels.

Volume measuring boxes are supplied; these permit the accurate measurement of material and rapid charging of the mould boxes.

The standard machine will make plain blocks 12 x 6 x 4 in. but the following variations are available:—

- (a) Block with central longitudinal groove on each 12 x 6-in. face.
- (b) Block with deep frog giving a reduction in weight of about fifteen per cent.

With four operators, one on the mixer and three on the block machine a minimum production rate of 180 blocks per hour can be maintained steadily and this can be increased to 200 blocks per hour with an experienced team of operators.

APPROXIMATE SHIPPING SPECIFICATION

No. 1 Crate—Rotary Hydraulic Block Press.
67 x 44 x 43 in. high (170 x 112 x 109 cm.)
Gross weight 1 ton 4 cwt. 3 qrs.
(1257 kilograms)
Net weight 1 ton 0 cwt. 2 qrs.
(1041 kilograms)

No. 2 Crate—Type D4 Trough Mixer
77 x 73 x 52 in. high (196 x 186 x 132 cm.)
Gross Weight 1 ton 10 cwt.
(1624 kilograms)
Net weight 1 ton 5 cwt. 2 qrs.
(1295 kilograms)

The Winget Research and Development Staff are constantly making advances in design and incorporating improved materials. It is in the interest of users that improvements are applied without delay, consequently the details given in this catalogue may be altered without notice.

Winget

WINGET LTD · ROCHESTER · KENT · ENGLAND
Tel: Strood, Kent 78641 (8 lines) Telegrams: Wingetism Rochester
LONDON OFFICE: 1-5 New Bond Street, W.1
Tel: HY De Park 0721-2-1 Telegrams: Wingetism, Phone, London

THE WINGET STABILISED SOIL BLOCK PROCESS

what it is and what it does

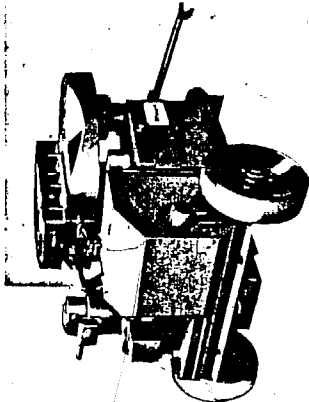

Stabilised Soil Blocks Why? There has always been a great need throughout the world for good cheap buildings. For centuries soil has been used to produce them, usually in one of these ways

- Raw de toric rammed earth
Hand-made, sun-dried bricks
Mud daubed walls

but under these methods certain drawbacks were always present. With raw construction was slow and considerable thickness of wall was necessary to provide sufficient strength. Neither hand-made bricks nor daubed walls were proof against weather and termites.

There are no such disadvantages with stabilised soil blocks produced on the Winget Block Press. Output is swift and the blocks are of exact dimensions with high load-bearing qualities and resistance to weather and termites.

After a long and careful investigation both in the field and the laboratory, Winget have evolved the unique design of their stabilised soil press in the form of the Winget Rotary Hydraulic Block Press which, incorporated in a properly organised layout, will produce in one hour up to 200 blocks of correct size and density with considerable strength.

The organisation of the site and layout of plant is discussed on another page

The Winget Equipment. The Winget Rotary Hydraulic Press is a self-contained unit which will produce blocks from a mixture of soil and cement. Since only a very small quantity of cement is used, it is essential that this is thoroughly intermixed with the soil to ensure uniform results. The Winget

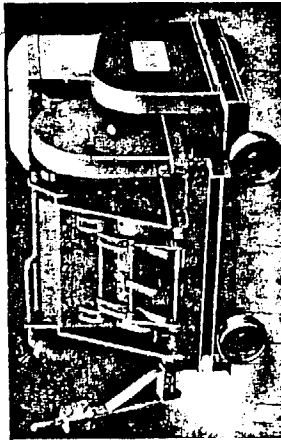

moderate rainfall, however, sufficient extra protection can be given to the walls with bitumen or by treating them with a lime or sand-cement wash which may be coloured to give the house a brighter appearance.

The Properties of Winget Stabilised Soil Blocks. The strength of the finished blocks depends principally on the actual soil used, but a fair average is 400 600 lb. per sq. in. crushing strength, and with good laterite soils up to 1,000 lb. per sq. in. has been achieved. The blocks are proof against termites and weather to a very high degree. The normal size of block is 12 x 6 x 4 in., which is self-bonding at corners, no cutting being necessary, and its unfrogeed weight is about 22 1/2 lbs. With frothing, the weight is about 19 lbs.

The Cost of Winget Stabilised Soil Blocks. There are obviously variable factors such as the cost of labour and of cement, which affect the cost of production. Blocks have been made for less than 2d each, including the cost of depreciation of the machine over a period of five years. Two-roomed hungalows teach room 10 x 10 ft.) complete with roof, open shuttered windows and doors, exclusive of foundations and services have been built for as little as £80 each.

Transportation of Winget Equipment. Both the block machine and its mixer are mounted on metal-wheels, allowing handling on site. If long distances must be covered, other means must be provided and we suggest that the 3-ton Winget Loblode Transporter Trailer Unit will be found the easiest way of transporting the machines. It is fitted with steel ramps and has a 20-cwt. hand winch to allow rapid loading and unloading.

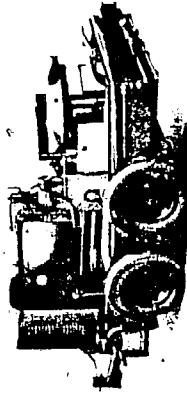

The Standard of Winget Equipment. All Winget products are designed and built to the highest standards, resulting in a trouble-free life of many years. To ensure that they continue to work at their highest efficiency it is obvious that regular cleaning and lubrication must be provided, and the block machine and trough mixer are easy to service in both these respects. Spare parts are always available from stock.

Yourself and Winget. Although in this leaflet we have tried to answer the questions which we think will first come to your mind, there may be some point about which you would like more information. In this case, please do not hesitate to ask us; our experience is at your service.

SOME TECHNICAL DATA

The essence of the Winget high-pressure process of making stabilised soil blocks, is the high density and crushing strength

of the finished block. This is in part due to the high degree of compaction and in part to the control of moisture content. Natural cohesion of the constituent parts of the soil is a vital factor in the strength and quality of the finished block. Normally, grading of a sample will indicate whether the soil will come within the cohesive category, and for this purpose it is frequently convenient to plot a graph showing the characteristics of a dry sample of soil passed through various sieves and in this way determine whether the addition of extra fine or coarse material would improve the quality of the block.

A typical graph of this nature is illustrated and our Research Department carry out a full test and prepare a report on all soil samples sent to Winget works for testing.

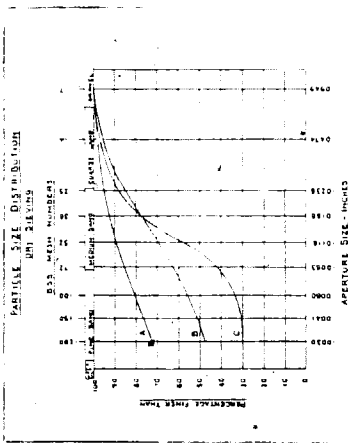

The following are three typical analyses of soil samples which we have received at various times:

Table with 4 columns: Soil Location, Per cent Optimum Moisture Content, Maximum Dry Density (lb. cu ft.), and Crushing Strength (lb. sq. in.) after 27 days in 84 in. The rows correspond to Central S. America, West Africa, and England.

In extreme climatic conditions it may be advisable to render the soil blocks completely waterproof. This can be done either by applying a wash or spray to the outside of the finished walls or by introducing commercial waterproofing agents into the soil mix before the blocks are made. Due to the high degree of compaction, frost has little effect on the block.

Soil blocks, with various stabilisers, have been exposed to sub-zero temperatures for considerable periods with no marked effect. Coated or otherwise proofed blocks are capable of even greater resistance to extremes of climate and temperature.

The advice of our technical and research departments on the various problems connected with the production of stabilised soil blocks is always available.



CONSOLID AG, CH-9435 Heerbrugg SG, Aechelstrasse 18 Switzerland

34

**TECHNICAL
BULLETIN**

No. 601.001, Ed. 77

CONSOLID 444 + CONSERVEX

New low-cost soil brick plant "CLU 2000" produces water-resistant soil bricks.

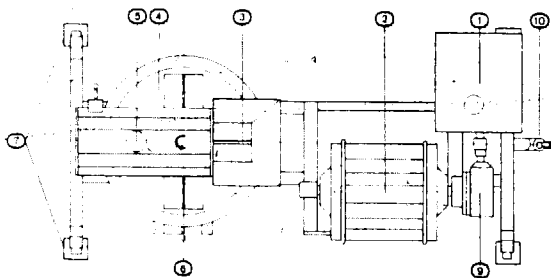
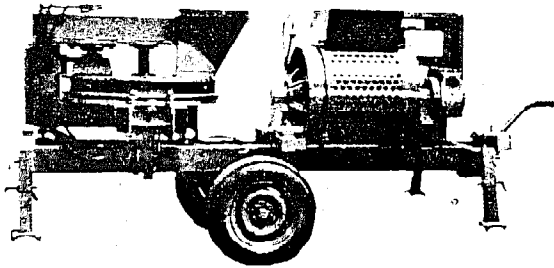

Technical specification

Mixer: 140 litre paddle mixer, model Z4, mechanically geared.
 Press: Hydraulically operated, valve controlled press and extruder. Total pressure 12,000 kg.
 Power: 11 HP HATZ diesel engine, model E785, air-cooled, hand starter, fuel consumption 2 litres per hour, equipped with Bosch hydraulic pump, mechanical clutch and gear.
 Transport: 2 wheel axle with 700 x 14 8 PR tires allows to be drawn or carried by medium-size truck at up to 25 km per hour.
 Site installation: Firm positioning on 4 telescopic legs after removal of wheel axle with lifting jack.
 Accessories: Starter crank, lubricating tools and some spare parts.
 Total weight: Approx. 1550 kg., with package approx. 1750 kg., dimensions: 325 x 162 x 150 cm.
 Production: 200 to 300 soil bricks per hour.
 Brick dimension: 25 x 12 x 7.5 cm. Other dimensions available upon request.
 (Pictures and specifications may be subject to changes. Rights applied for.)

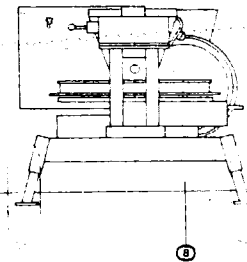

- ① Diesel engine
- ② Paddle mixer
- ③ Hopper
- ④ Rotary table
- ⑤ Hydraulic press
- ⑥ Hydraulic extrusion
- ⑦ Telescope legs
- ⑧ 2 tire wheels
- ⑨ Gear
- ⑩ Shaft bar



CONSOLID AG, CH-9435 Heerbrugg SG, Aechelstrasse 18 Switzerland

**TECHNICAL
BULLETIN**

No. 601.002, Ed. 77

CONSOLID 444 + CONSERVEX

**SOIL BRICK PLANT „CLU 2000”
Manufacturing process of soil bricks**



The soil brick plant „CLU 2000” allows the simple manufacture of high-quality soil bricks, which will be an excellent construction material for low cost housing, erosion protection walls, linings for irrigation and drainage channels, dams, embankments, etc.

For soil bricks, any type of soil, having a semi-cohesive or cohesive character, can be used because this natural cohesion is necessary to get the required compressive strength. The treatment with CONSOLID 444 and CONSERVEX is protecting the brick against softening by water and loss of strength.

The compressive strength of such treated bricks will be between 25 to 60 kg/cm², in this range sufficient for single-storey houses. If higher compressive strength is required, already the addition of 1 to 3 % cement to the treated soil will increase the compressive strength to values of about 100 kg/cm².

The commonly used landcrete and sandcrete blocks may as well be produced with the soil brick plant „CLU 2000”. It is recommended to use a combination of cement and CONSOLID 444 or lime hydrate and CONSOLID 444 to get best stability results.

Most soils qualified for high-quality bricks are in the range of the optimum moisture content between 10 and 20 %. Highly cohesive soils (heavy clays) can be cut down to this OMC by adding sandy material. Non-cohesive soils (sand) will require the addition of up to 20 % of clayish material to get enough natural cohesion for stable soil bricks.

For water-resistant soil bricks, the required average quantity of CONSOLID 444 and CONSERVEX, per one cubic metre of soil, is one litre of CONSOLID 444 and 10 litres of CONSERVEX, to be properly mixed with the soil in the paddle mixer of the soil brick plant.

A crew of 4 to 5 workers can produce per working day 2000 to 3000 bricks with one plant. The bricks are stored for air-drying in the shadow and achieve their full strength after drying out. However, they may be used already one to two days after production. During the drying period, the bricks must be protected against heavy rains.

This manual is valid as an order only. Technical data are intended only for your information and instruction and no liability for us can be derived therefrom.

Hall of our world population lives in housings, mainly erected by the use of soil as building material. Therefore any quality improvement of soil for building purposes is of vital interest for millions of people. For building purposes soil is excellent, as long as its dry stability is maintained. Loss of such stability, primarily by water influence, is causing problems and may lead to total destruction of such houses. Weathering, erosion by rains and softening of the soil material by soaking water damage heavily soil buildings. The treatment of in-place cohesive soil with CONSOLID 444 and CONSERVEX helps to stop the destructive influence of water to a high degree by waterproofing soil effectively. Such water-resistant soil offers excellent opportunities for the manufacture of water-resistant soil-bricks for better housing. Should the natural dry strength of soil not already satisfy, additional improvement is possible in combination with small quantities of binders (lime or cement) to achieve first-class soil bricks. High-quality soil buildings require CONSOLID 444 CONSERVEX treated soil-bricks, simultaneously, an adequately advanced production facility, providing optimal sieving of the soil, thorough mixing with CONSOLID 444 and CONSERVEX and eventually other additives as well as high pressure for the soil brick production, granting constantly precise dimensional tolerances.

The joint efforts of Consolid AG, Switzerland and the world-known firm Lescha, Leonhard Schmid KG, Augsburg, Germany, have led to the development of this unique low-cost soil brick plant. This mobile plant integrates the two mechanised production units - paddle mixer and brick press. The entire plant is rigid, service-friendly, simple to operate at low running costs.

1 Filling the moulds



Soil, having been thoroughly mixed with CONSOLID 444 and CONSERVEX in the paddle mixer, is shovelled by hand in the filling gauge, which automatically unloads the soil into the empty turn-table forms, locating precisely underneath after every quarter turn. The special design of the gauge allows automatic filling, provided that the moisture content of the material is sufficiently observed. Another quarter turn allows hand inspection of filling volume of the forms to control constant thickness.

2 Brick-pressing by hydraulics

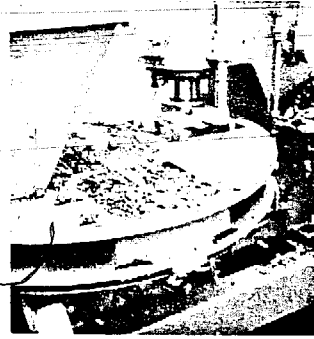

The next quarter turn of the turn-table transports and locates the carefully levelled forms underneath the hydraulic press. The edge of the press is removing any surplus soil during the table's turn motion, controlling additionally constant filling level. Safety means are provided to prevent press casualties to a very high degree. The entire press is controlled by a manually operated hydraulic valve, releasing simultaneously the pressing of the new and the extrusion of the already pressed bricks.

3 Extruding of the bricks

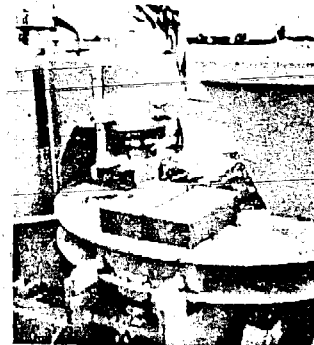

The next quarter turn of the turn-table transports and locates the compacted bricks above the hydraulic extruder-plate, being simultaneously activated when the next brick is being compacted. Both extruded and openly presented bricks are now being taken away by hand and carefully deposited on drying boards or racks, etc. It is understood that such "green" bricks are still fairly soft and therefore have to be handled carefully to avoid breakage. Breakage can be recycled. The entire turn-table process can be handled very efficiently by a team of unskilled help. The ready-made "green" bricks are now being slowly air-dried (rain-protected and in the shade) and then they are ready for construction or additional finishing.

JOB DESCRIPTION OF WORKERS

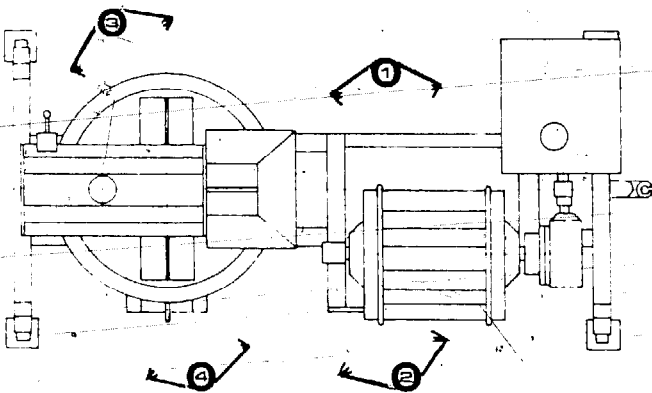

1 Man No. 1 fills the paddle mixer for each mix with 100 litres of soil and adds during mixing the proper quantity of CONSOLID 444 and CONSERVEX, diluted in enough water to get the optimum moisture content of the soil for best compaction.

2 Man No. 2 unloads the paddle mixer and fills the treated soil into the hopper on the soil brick press. He also supervises the diesel engine.

3 Man No. 3 operates the press by rotating the table to its next position, levels the freshly filled forms and starts the hydraulics, which compact the bricks.

4 Man No. 4 (or, if available, one help) assists No. 3 to rotate the table into its next position and is taking away the freshly extruded bricks for storage and drying on pallettes or racks in the shade.

The quality of the finished bricks can be improved by repairing voids or uneven corners of the bricks as long as they are moist. If the bricks are manufactured properly, such "cosmetic" work will not be necessary or is restricted to a very small proportion.

When dry, the bricks may be used for masonry work with the same technique as burnt bricks or concrete blocks. The mortar, which glues the bricks together, can be a mixture of sand and cement as well as sand with cement and lime. But also a mixture of the same cohesive soil with CONSOLID 444 and CONSERVEX, which is mixed with the plant to a slurry by adding enough water, will be a suitable soil mortar with the advantage that the entire wall is built of uniform material.

If the bricks are used for purposes with extreme heavy water exposure or on the weathered surfaces of houses and walls, it is recommended to apply a top-coat with CONSIL soil brick coat, a silicone-copolymer resin solution, which is creating highly effective waterproofing of the exposed surface. This coating is always applied as last step. Therefore, if a building is plastered and painted, the CONSIL top-coating will be the last process applied. Depending upon the local conditions, one or two coatings with CONSIL are applied by brush or roller. Bricks which will be used under water have to be coated with CONSIL on all sides by dipping the dry brick fully into the CONSIL solution. The protective coating will become fully effective after evaporation of the solvents.



“ TOB SYSTEM ”

Grande Mobile de Production de Briques en Terre Crue Compressée

Transportable unit for the manufacture of bricks from compressed unbaked clay

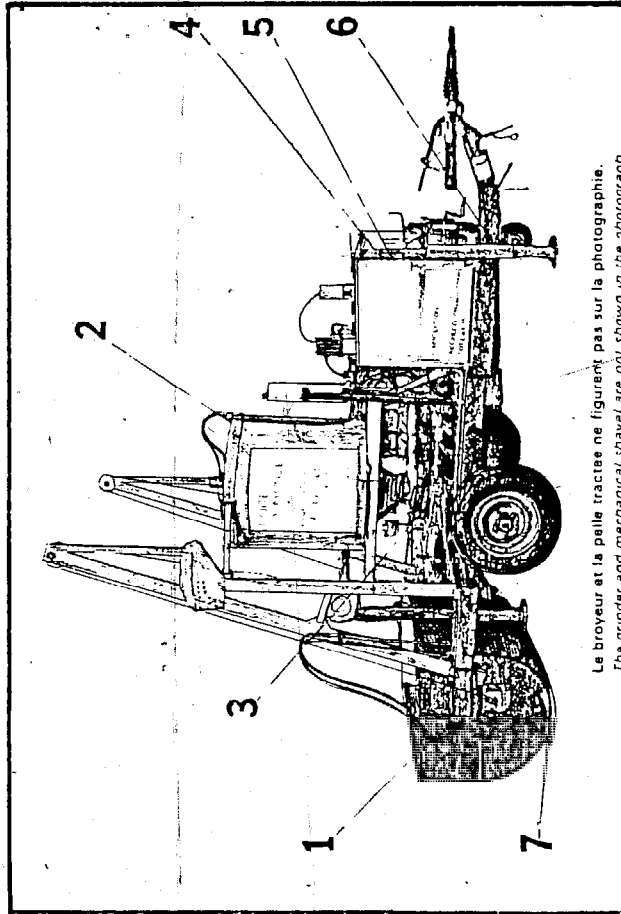

Le broyeur et la pelle tractées ne figurent pas sur la photographie.
The grinder and mechanical shovel are not shown in the photograph

- 1 Malaxeur Mixer
- 2 Tremie de remplissage Filling hopper
- 3 Carrousel à trois postes Rotative mould block with three positions
- 4 Moteur Diesel Diesel Engine
- 5 Réservoir du circuit hydraulique Hydraulic system reservoir
- 6 Châssis tracté Trailer
- 7 Trappe de vidage pour utilisation en bétonnière Sliding door for use as cement mixer

Diffuse par:

Issued by:

SOÛEM
La Fount
31130 Balma
FRANCE

(Excerpt from Bibl. 33)

TOB-System

Soûem
La Fount
31130 Balma
France

PRICE	11.765-14.380 U.S.\$
TIME OF DELIVERY	2 Months
DIMENSIONS OF MACHINE	470x180x220cm
WEIGHT	1970kg
TYPE OF ENGINE	Lombardini L40 Diesel
TYPE OF FUEL	Diesel
ENERGY CONSUMPTION	6,7l/h
STATIONARY, PORTABLE OR MOBILE	Mobile
TYPE OF MIXER	TOB mixer 5001
MANUFACTURING PRESSURE	57kp/cm ²
COMPRESSION VOLUME	2
SIZE OF BLOCKS	29x14x8,5cm (Interchangeable moulds)
DIMENSION OF MOULD IN OPEN STATE	29x14x17cm (Standard-mould)
NUMBER OF BLOCKS PRODUCED PER DAY (8 HOURS)	3000
NUMBER OF EMPLOYEES WORKING THE MACHINE	3
PRODUCTION VOLUME PER DAY	10m ³

COMMENTS:

It is possible to use the machine as a cement mixer on site.

3.3 Soil Block Presses - Past and Present

3.3.1 Building with Earth

Soil is today, as it was thousands of years ago, the most widely used building material, and will surely always remain so. But, despite this fact, building with earth is looked upon, in many regions of the world, with disrepute - as being the construction system of the poor. And yet, soil is one of the most appropriate materials, in terms of environmental and health aspects.

The reasons for the widespread negative attitude towards such constructions are manifold. Some principal ones are:

- Soil is available almost everywhere and usually at no-cost. (What does not cost anything, is not valued!)
- Earth constructions require regular maintenance and repairs, even under moderate climatic conditions. Negligence could otherwise lead to rapid dilapidation. (But repairs mean a great deal of extra work and, quite often, extra expenses.)
- Keeping earth buildings clean can be difficult; rough and unclean surfaces, or cracks in the soil floor, wall or ceiling can harbour vermin, and parasites, which carry dangerous diseases, such as the "Chagas" disease, which affects at least 20 million people in Latin America.

However, as long as the use of soil as a building material is rejected for purely technical reasons, there are several remedies, such as proper building design (with sufficient weather-proofing and precautionary measures), careful and correct preparation of the soil mix (grain size distribution, addition of stabilizing agent, mixing, water content), and, equally important, good compaction, irrespective of the type of construction.

3.3.2 Development of Soil Block Presses

Experience in soil construction has shown that manual compaction of the damp earth (by throwing or ramming) generally cannot achieve the high compressive strengths and durability of burnt clay bricks or concrete (blocks), with which soil structures are invariably compared. In order to achieve higher compaction, mechanical devices were developed, both in the form of tampers, as well as in the form of block presses (first made out of wood, later out of iron or steel). The first documented block press was invented by François Cointeraux in 1789, which the Frenchman named "La Cresise". A variety of presses have been developed since then, and many are not being produced or used since long. However, the oldest soil block press, which is still being manufactured today, was invented in 1904 (see page 26).

The machine was designed by a Belgian engineer, E. Gossiaux, of Villers-Perwin, together with Belgian missionaries, who were beginning to explore and develop the Congo (today Zaire). The popular French marching song of those days gave the press the name: LA MADELON. The improved version of the machine was called SUPER MADELON. Many years later the machine was manufactured in South Africa, called "LANDCRETE", and became well-known throughout the world. In 1933, the in-

ventor of the SUPER MADELON developed a semi-automatic, motor-driven version of it, and called it LA MAJO. About 20 years later, Gossiaux designed and built an automatic, mechanical block press, with a rotary mould table, naming it LA MAJO-MATIC. A machine, based on the same principle, but with a hydraulic press, was manufactured in England and called WINGET Rotary Hydraulic Block Press.

In the 1970s, the Ateliers de Villers-Perwin ceased production of the SUPER MADELON, which was also called STABIBLOC. The same machine was, however, still being manufactured, although by other Belgian firms, and carried the names FIB-SM, TERSTARAM and CERAMAN. The last two are still being produced. Also LA MAJO is still available, with slight modifications, and called SEMI-TERSTAMATIQUE, just as LA MAJO-MATIC was available for some time as FIB-MM, and is now being produced, with a few changes, as CERAMATIC.

A number of other block presses, both manual and motor-driven, have vanished from the market. Some illustrations of these are shown on pages 23 - 25, entitled "Le Musée des Presses" (taken from "Construire en Terre" by CRATerre, Bibl. 06).

All these machines were relatively large, heavy and expensive, so that their use was limited. What was needed, was a small, light, easy-to-operate and cheap block press, which could be used on the remotest building sites in the Third World.

According to these requirements, the Chilean engineer, Raúl Ramírez, developed such a machine in 1952. He was then working with CINVA, the Inter-American Housing Center in Bogotá, Colombia. The press was, therefore, called CINVA-Ram, whereby "Ram" was derived either from Ramírez, or from the English word for a compacting device.

The CINVA-Ram is now by far the best-known and most widely used block press. Numerous variations of it have been manufactured in many countries, but, in its original form, it still is the lightest and least expensive block press available - every improvement, in terms of handling, output and sturdiness, invariably means an increase in price. Another well-known, manually operated block press is the ELLSON BLOCKMASTER, which was originally produced in South Africa, but is now being manufactured in India (since 1959). However, despite its versatility and efficiency, it is not as widely used as the CINVA-Ram, probably due to its greater size, weight and cost.

In the 1950s and 60s, interest in soil constructions was generally low. In the 1970s, research work and implementation of soil technologies in development projects steadily increased, largely on account of the worldwide energy crisis. Apart from several other publications, Hassan Fathy's "Architecture for the Poor" (Bibl. 15), which was published in 1973, did a great deal in reviving interest in soil construction systems. Of importance was also the TEK-Block Press (Ghana, 1970), and the CETA-Ram (Guatemala, 1977). Since the beginning of the 1980s, this tendency has gained additional momentum.

In the course of these developments, a new generation of soil block presses came into existence in the 1970s, namely complete production units on wheels. The equipment generally required for blockmaking, apart from the press, are a sieve, a mixer and a measur-

ing scoop for charging the mould, although quite often these are substituted by manual operations and estimation. The new, partially or fully automatic machines accomplished all these tasks in quickly repeating operation cycles, thus achieving higher outputs of uniform, superior quality bricks. Machines that belong to this category are CLU 2000 and CLU 3000 (Switzerland/Germany), Ecobrick 1000 and Meili (Switzerland), TOB-System and Hallumeca Unipress (France), and Terrablock (USA).

3.3.3 General Aspects of Producing Compressed Soil Blocks

The list of soil block presses in section 3.2 gives a vivid impression of the diversity of the machines available today. There are machines for almost any given situation and desired performance, accordingly also at all prices, between 200 and 75000 US Dollars.

It is self-evident that the cheaper and more expensive machines cannot be compared with each other in any way, even though they principally serve the same purpose. The following (extremely generalized) compilation of the respective advantages and disadvantages clearly shows, that each system caters for a certain range of needs and thus has a valid place to fill. Grossly simplified, the cheaper devices are taken to be manually operated, while the expensive machines are referred to as motor-driven and automated.

Advantages of manually operated presses

- Low capital and operational costs.
- Quick delivery.
- Low weight (devices like the CINVA-Ram can, if necessary, be taken along as unaccompanied flight luggage; easy to transport on wheel-barrows or bullock-carts).
- Small in size, thus little storage space required.
- Simple to handle, even for unskilled workers.
- Apart from cleaning the mould and lubrication of moving parts, low maintenance requirements.
- Possibility of repairs in local workshops, no special spare parts required.
- Usable at any location, since only muscle power is required.
- No additional costs of energy.
- No time loss due to failure of energy supply.

Disadvantages of manually operated presses

- Low rate of production per machine (on average between 40 and 150 blocks per hour), thus requiring a number of machines to achieve a reasonable output.
- Low compaction pressure (averaging 0,5 to 2,5 N/mm²), hence poor quality of soil blocks (ie lower compressive strength, higher moisture absorption, susceptibility to disintegration).
- Tendency to produce irregular block sizes

or compaction, depending on compressing system, if filling the mould is done manually.

- Extremely tiring operation; thus, in the course of a series production, tendency of gradual drop in quality and uniformity of blocks produced, if the pressure is continuously exerted by the same person.
- On account of the lower compaction pressure, necessity of adding larger proportions of binder (consequently increasing the costs), in order to achieve sufficient ultimate strength and water resistance.

Advantages of automatic, motor-driven presses

- High rate of production (on average between 200 and 1500 blocks per hour).
- High compaction pressure (between 4 and 24 N/mm²), hence good quality of soil blocks (optimum dimensional uniformity, stability of edges and high compressive strength, low moisture absorption, longevity, saving of costly and tedious surface treatment, appropriateness for multi-storeyed buildings).
- Continuously uniform quality of blocks, since no muscle power is applied.
- Requirement of only small proportions of binder (thus saving costs), on account of the high compaction pressure.
- Reduction of manual work, thus saving costs, where wages are high.

Disadvantages of automatic, motor-driven presses

- High capital and operational costs.
- Relatively long delivery time.
- Usually very heavy, requiring powerful lifting gear and vehicles for transportation, transports are troublesome and expensive.
- Large size, requiring large working area, making safe storage under lock and key difficult.
- Requirement of high insurance cover.
- Necessity of skilled labour for operation of machines.
- Maintenance requirements comparable with those of motor vehicles.
- Requirement of specialists for repairs; spare parts possibly expensive and difficult to get, or only after long delivery time.
- Dependency on local energy supply.

Summary

The above list of advantages and disadvantages of the different categories of soil block presses lead to the following conclusions:

Small, manually operated machines are best suited:

- in case of limited capital resources;
- for projects in remote areas, or those that lack the necessary infrastructure;

- on small building sites, with limited working space;
- in areas of low precipitation, thus excluding the danger of excessive water absorption;
- for small building projects with single-storeyed structures, for which the quality of soil blocks is of less importance;
- in places, where the potential for self-help inputs is high;
- or where entrepreneurs, with a small capital base and a team of unskilled workers, produce soil blocks for the local market.

Powered, high capacity machines are advantageous:

- where sufficient financial resources are available;
- in cases where high production rates are needed and there is a high demand over a long period;
- for projects, that specify better qualities of soil blocks;
- in working environments with sufficient energy supply, as well as maintenance and repair facilities;
- in cases, where labour is expensive or not easily available;
- or in case of disaster aid operations, which necessitate efficient and quick help, and good, cheap material in large quantities. (Quite often, tents and other temporary accommodations are provided at high costs, requiring more permanent substitutes later on. It is wiser to help the disaster victims to build stable, permanent houses straight away. Thus it could be a far better bargain, to invest the money, which usually is spent on provisional measures, in the procurement of a high capacity soil block press.)

In view of the vast choice of machines available, it seems difficult to decide which one should be bought. If there is not enough money to buy expensive equipment, the choice is smaller and the decision much easier. But generally, the following points need to be considered, especially when the available resources allow for the purchase of higher priced equipment.

Ancillary devices: Does the soil block press incorporate all the functions required for block production, or does additional equipment (crushing machine, sieve, mixer, measuring scoop, etc.) have to be procured? Consideration should not only be given to the costs, but also to the required storage and working space, as well as transports.

Material quality: Even though the compressive strength of blocks, in most cases, need not be high - the quality of CINVA-Ram blocks is structurally quite adequate - it is important to note, that weakly compacted blocks are porous and easily absorb moisture, the course surface is difficult to keep clean and can be abraded easily, while cracks and cavities are likely to harbour vermin. Such surfaces usually need some protective coating, which naturally incurs additional costs. Denser blocks, which have been compacted with pressures upwards of about 7 or 8 N/mm²,

can remain untreated, offer no refuge to insects, and can do with only small quantities of binder (ie cement or lime). Alternatively, in case of low compaction pressures, a chemical additive (eg asphalt-based) can provide the necessary moisture resistance. However, such additives do not increase the compressive strength of the block, and it should also be remembered, that these substances invariably have to be imported, thus making the production of blocks more expensive and dependent on supplies.

Block format: Small sizes require a greater number of blocks per cubic metre than larger ones, so the overall effort needed to produce small blocks is greater than that of making large ones. Furthermore, masonry constructions with small bricks require more mortar, since the proportion of joints is higher. Therefore, the best block format is determined by the maximum weight and size that can be easily handled by a single person.

Manual work: It is generally accepted that 8 hours represent a working day. Considering that a manually operated press requires the person, who pulls or pushes down the lever, to exert a great force, up to about twice every minute, it becomes clear that gradual exhaustion causes diminishing performance and lower quality blocks. In development projects, this work is frequently done by unskilled workers, who commonly are not blessed with regular or nourishing meals, and thus possess less strength and stamina. In view of this, every means of facilitating manual operations should be given priority, if the financial resources permit. If a motor-driven machine is chosen, it would be advantageous to also be able to operate it manually, in case of short supply of energy, or failure of the motor.

Soil Block Presses

ANNEX A

The soil block presses, of which detailed information and illustrations (from manufacturers' pamphlets, publications and other sources) are given in this annex, correspond to those listed in section 3.2.1. The selection of material presented here was determined by the choice of available documents and their suitability for reproduction. Some machines are well documented, while the information on others is, in some cases, totally inadequate. Thus, the number of pages of information on the respective machines only indicates the availability of suitable material, but has nothing to do with the quality or appropriateness of the machines.

The aim of this compilation is to enhance the usefulness of the document, by helping the user to understand the rather abstract list in section 3.2 better. Also, as a kind of catalogue, potential soil block builders may obtain sufficient information from a single source, rather than having to conduct costly and time-consuming correspondence with various manufacturers. Although a final document is planned later, it is hoped that this study can be put to immediate use, in spreading the information on soil block presses, especially through the question and answer services of the respective appropriate technology centres. The binding of this document was thus chosen to facilitate photocopying.

The machines included here are:

Type of Press	Page
CINVA-Ram	42
TEK Block Press	44
La Palafitte	46
CETA-Ram	47
CENEEMA Earth and Loam Block Press	49
AVM Block Press	53
SISD Dirt-Cement Brick Press	56
Meili - 60 Manual Soil Brick Press	59
MARO Block Press	60
CTBI Block Press	62
UNATA	65
JESSON Brick Press	68
A.B.I. Block Press	69
CTA Block Press	70
GEO 50	72
SATURNIA	74
RIFFON Block Press	75
ELLSON Blockmaster	76
ASTRAM	79
CRATerre Perou Block Press	82
Multibloc BREPAK Block Press	84
ZORA Brickmaking Machine	88
TERSTARAM Block Press	90
CERAMAN Manual Press	92
SEMI-TERSTAMATIC	94
CERAMATIC	96
LESCHA SBM	98
CLU 3000	100
ECOBRIK 1000	102
MEILI Mechanpress	105
TERRE 2000	106
PACT 500 Block Press	108
CTBI Hydraulic Press	110
GEO 500 Semi-Bloc, Unité Atelier	112
GROUPE UNIPRESS	113
ULTRABLOC IMPACT 1/2	114
TERRABLOCK Duplex	115
HANS SUMPF Brick Machine	118
EARTH BRICK MACHINE	120

Product Information : Soil Block Presses

CINVA - Ram Manual Block Press

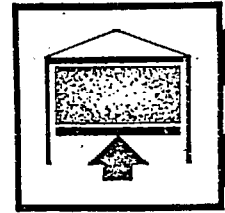

DESCRIPTION

The CINVA-Ram Block Press is a simple, low-cost portable machine for making building blocks and tiles from common soil. The press, made entirely of steel, has a mould box in which a hand-operated piston compresses a slightly moistened mixture of soil and cement or lime.

The press was developed as a tool for small individual or mutual self-help programs. It was designed by Raúl Ramirez, an engineer, at the Inter-American Housing Center (CINVA) of the Organization of American States in Bogota, Colombia, in 1952. It is still the cheapest and lightest machine available and has been copied and modified several thousand times in all parts of the world.

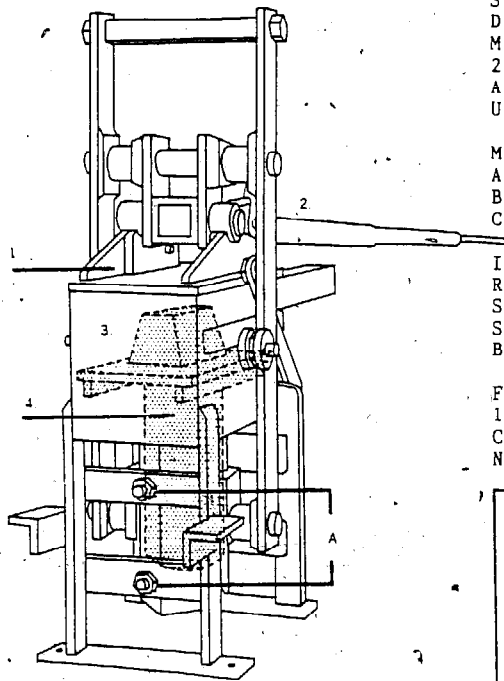

DISTRIBUTORS:

Schrader - Bellows
Division of Scoville
Manufacturing Co.
200 W. Exchange Street
Akron, Ohio 44309
USA

Metalibec Ltda.
Apartado Aereo 233, Na 1 157
Bucaramanga
Colombia

Industria e Comercio de Maquinas
Rua 3 de Dezembro, 33-50
Sala 55
Sao Paulo
Brazil

Fraser Engineering Company
116 Tuam Street
Christchurch
New Zealand

TECHNICAL DETAILS

Weight:	63 kg (140 lbs.)
Height and base width:	24x37x64cm (10"x16"x26")
Application force of lever:	36 kg (80 lbs.)
Bearing Strength (Fully cured blocks)	1.4-3.5 N/mm ² (200-500 psi)
Size of block:	9x14x29cm (3.5x5.5x11.5")
lays up:	10x15x30cm 4x6x12"
Size of tile:	5x14x29 (1.5x5.5x11.5")
lays up:	5x15x30cm (1.5x6x12")
Average number of blocks or tiles can be made by two people per day:	300-500
Average number of blocks needed for a two-room house:	2500
Average number of blocks per 50kg of cement:	150

Inserts: Four different moulds for producing different kinds of blocks and tiles.

Cost in United States: \$175 FOB Warehouse Tallmadge, Ohio

1. The COVER. A rectangle of metal, joined to the box by two movable rods at the side to allow it to slide open and to close. Above it are two brackets to house one of the upper shafts of the lever's connecting rods.

2. The LEVER. Consists of a set of connecting rods, operated by hand, which set the piston in motion.

3. The BOX. A metal mould supported by four angular iron legs, constituting the frame of the whole mechanism.

4. The PISTON. Consists of a cylinder, guided between two adjustable angles and ending in a rectangular plate which serves as a compression plunger. To this plate is screwed a piece of wood, the function of which is to stamp the blocks. If solid blocks are wanted, the wooden piece can be taken off by removing the screws and filling the hole's left in the plate with small screws.

A. SCREWS FOR LOOSENING THE PISTON GUIDES. Are used to loosen the piston if it fits too tightly between the guides, or vice versa.

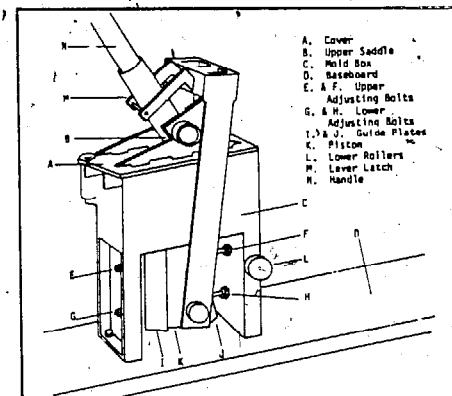

- A. Cover
- B. Upper Saddle
- C. Mold Box
- D. Baseboard
- E. A.F. Upper Adjusting Bolts
- G. & H. Lower Adjusting Bolts
- I. & J. Guide Plates
- K. Piston
- L. Lower Rollers
- M. Lower Latch
- N. Handle

REFERENCES

Department of Housing and Urban Development: Earth for Homes, HUD, Washington, D.C., 1955.

Spence, Robin: Making Soil-Cement Blocks, The Technical Services Branch, Commission for Technical Education and Vocational Training, University of Zambia, Private Bag RW 16.

VITA: Making Building Blocks with the CINVA-Ram Block Press, Volunteers in Technical Assistance, Mt. Rainier, 1977.

United Nations: Soil Cement - Its Use in Building (compiled by Rafael Mora-Rubio), United Nations, New York, 1964.

Wolfskill, L.A.; Dunlap, W.A.; Gallaway, B.M.: Earthen Home Construction, A field and library compilation with an annotated bibliography, Texas Transportation Institute, College Station, 1962.

OPERATING THE PRESS

In order to make good compressed earth blocks and tiles, enough earth mix must be loaded into the mold box to require a hard pull on the handle. Make a few test blocks and tiles to determine the quantity of your earth mix which must be loaded into the press to give you this adequate, hard pull.

There are three basic operations in making the compressed earth blocks or tiles:

1. Loading the mold box.
2. Compressing the mix.
3. Ejecting the finished product.

DETAILED MOVEMENTS

1. Place the handle in the rest position and open the mold box by swinging the cover horizontally until its stop is reached; then fill the mold box with the prepared earth.
2. Close the mold box, skimming off excess earth, and bring the handle to the vertical position, then release the latch.
3. Pull down the handle until it is parallel with the ground. This applies the necessary pressure to form the block. If the mold box is properly filled, this should require a "hard pull".
4. Return the handle to the original rest position, swing cover back and open the mold box.
5. Pull down on the handle in the opposite direction until it is parallel with the ground. This ejects the block.

6a. Removing blocks from the press: Place hands flat at the ends of the block, being careful not to damage the corners or edges and then gently lift the block from the mold box. Place on edge at the curing site.

6b. Removing tiles from the press: Place one flat hand on top of the tile. Keeping the tile and wooden insert together, slide both off the mold box until the other hand can be placed beneath the insert. Place both on edge at the curing site and then gently separate the insert from the tile.

ADJUSTING THE PISTON

In full ejection position the piston head should be level with top of mold box. Continued use of the press or accidental jarring may loosen the two guide angles or force them out of vertical alignment, producing blocks having unequal end dimensions. To correct this, move guide angles by regulating adjustment bolts.

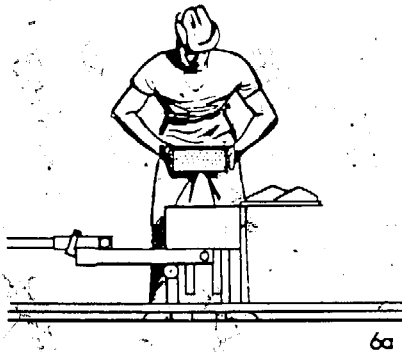
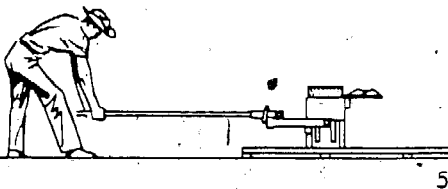
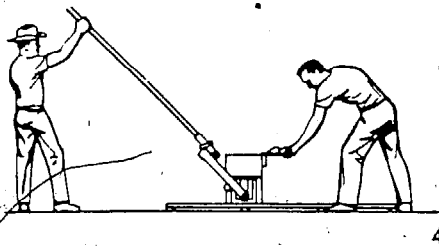
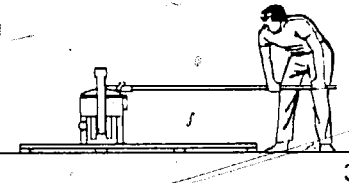
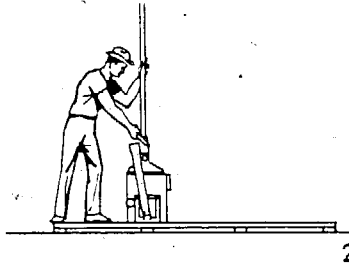
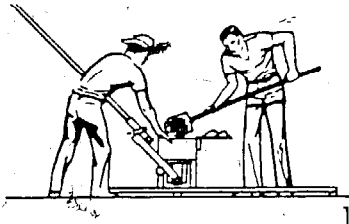

MAINTENANCE AND REPAIRS

The machine must not be overloaded. This happens when too much soil is placed in the mould, and another man is asked to "give a hand" with compacting. Never allow two men on the handle, either for compacting or ejecting the block.

All moving parts and wearing parts (rollers, pins, pressure plate, guide plates, piston cylinder, bearings and supports of axles) should be well lubricated every four to eight hours with smooth oil or grease to insure smooth operation and cut down on wear.

The pins which secure the pivot shafts, compression yoke and rollers should be replaced when broken by the largest nails available, because they will last longer than the average cotter pin. If C-ring replacements are not available, broken C-rings can be replaced by wrapping a piece of wire in the groove.

The inside of the box and the under surface of the cover must be kept clean.

Breaks and cracks are caused by loose or incorrectly adjusted guide plates.

Tapering is caused by incorrectly adjusted guide plates.

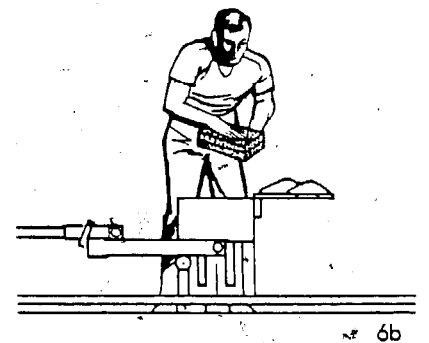

Published by:

German Appropriate Technology Exchange - GATE
in: German Agency for Technical Cooperation (GTZ)
Postfach 5180
D - 6236 Eschborn 1
Federal Republic of Germany
Tel.: (06196) 79-0,
Telex: 41523-0 gtz d

Compiled by:

Kiran Mukerji, Consultant Architect
Starnberg/FRG
January 1986

Meili manual soil brick press

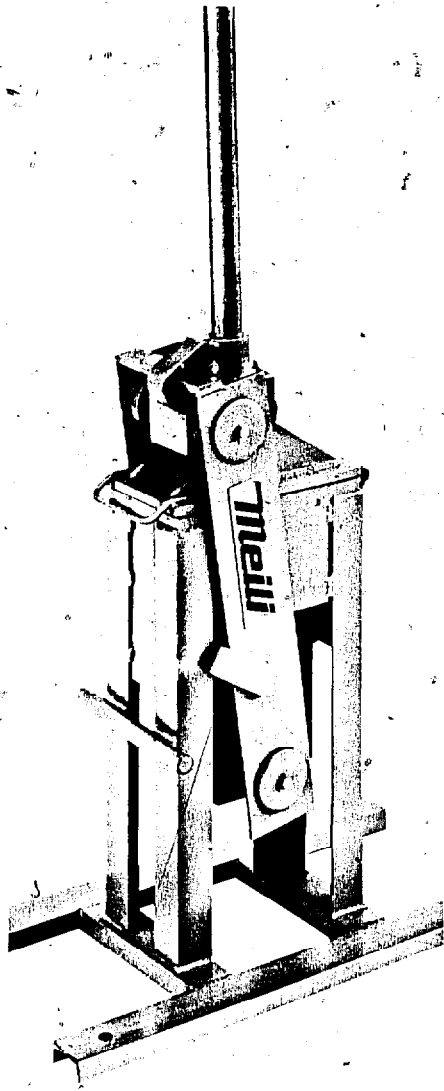

People in both industrialized and developing countries have long been waiting for an improved version of the "Cinva Ram" brick press to come onto the market. That product has arrived with the introduction of the "Meili-60" manual soil brick/block press.

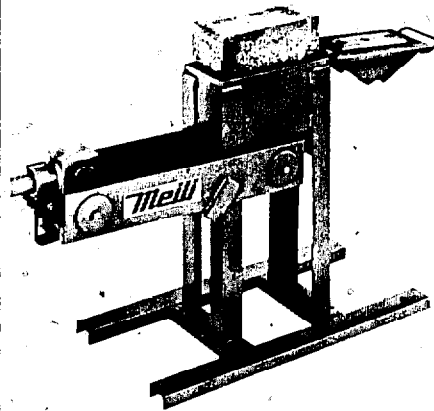
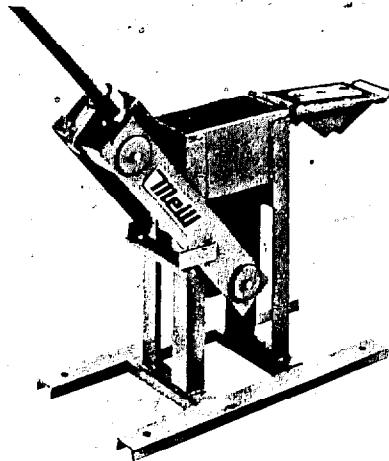

Meili manual soil brick press

The 20 tons manual press for the economic production of earth building bricks and blocks of any size offers:

- Rugged design
- Troublefree operation
- Unsurpassed economy
- High performance
- Minimum investment
- Maintenance free

The "Meili-60" press operates according to the principle of the off-center press. Utilizing the maximum leverage effect possible in the final phase of the pressing process. The machine easily achieves a pressing power of 20 tons, corresponding to a pressure of more than 50 kg/cm² - sufficient to achieve the desired brick density.

The optimum building brick or block is achieved

- At a specific pressure of about 50 kg/cm²
- By using ordinary earth
- By adding the desired amount of water
- By adding some cement, chalk or any other additive readily on the market, or even by using straw or other like material.

Technical information

soil brick dimension	250 x 125 x 80 mm
pushing power on lever	ca 50 kg
pushing power on brick	ca 20 tons
specific pressure	ca 50 kg/cm ²
density degree	1:1.8
output per hour	60 to 120 bricks plus

Other size bricks can be manufactured according to your specifications. Manufacturer reserves right to change technical specifications.

Offers for manufacturing the "Meili-60" manual soil brick/block press under license in various countries will be considered.

Manufacturer reserves the right to change technical specifications.

Agent:

Meili

Engineering Practical and affordable technologies for developing countries

Gewerbe-Center Rothaus
8635 Dürnten/Switzerland
Telex 875 750
Telefon 055/31 39 21

Meili

Engineering Practical and affordable technologies for developing countries

Gewerbe-Center Rothaus
8635 Dürnten/Switzerland
Telex 875 750
Telefon 055/31 39 21



maro entreprise
 route de suisse 95/B
 ch - 1290 versoix switzerland
 tel. (022) 55 41 46
 telex TXC CH-427130

60

mark klein

planning design and supply
 of light steel framed modular
 buildings and components

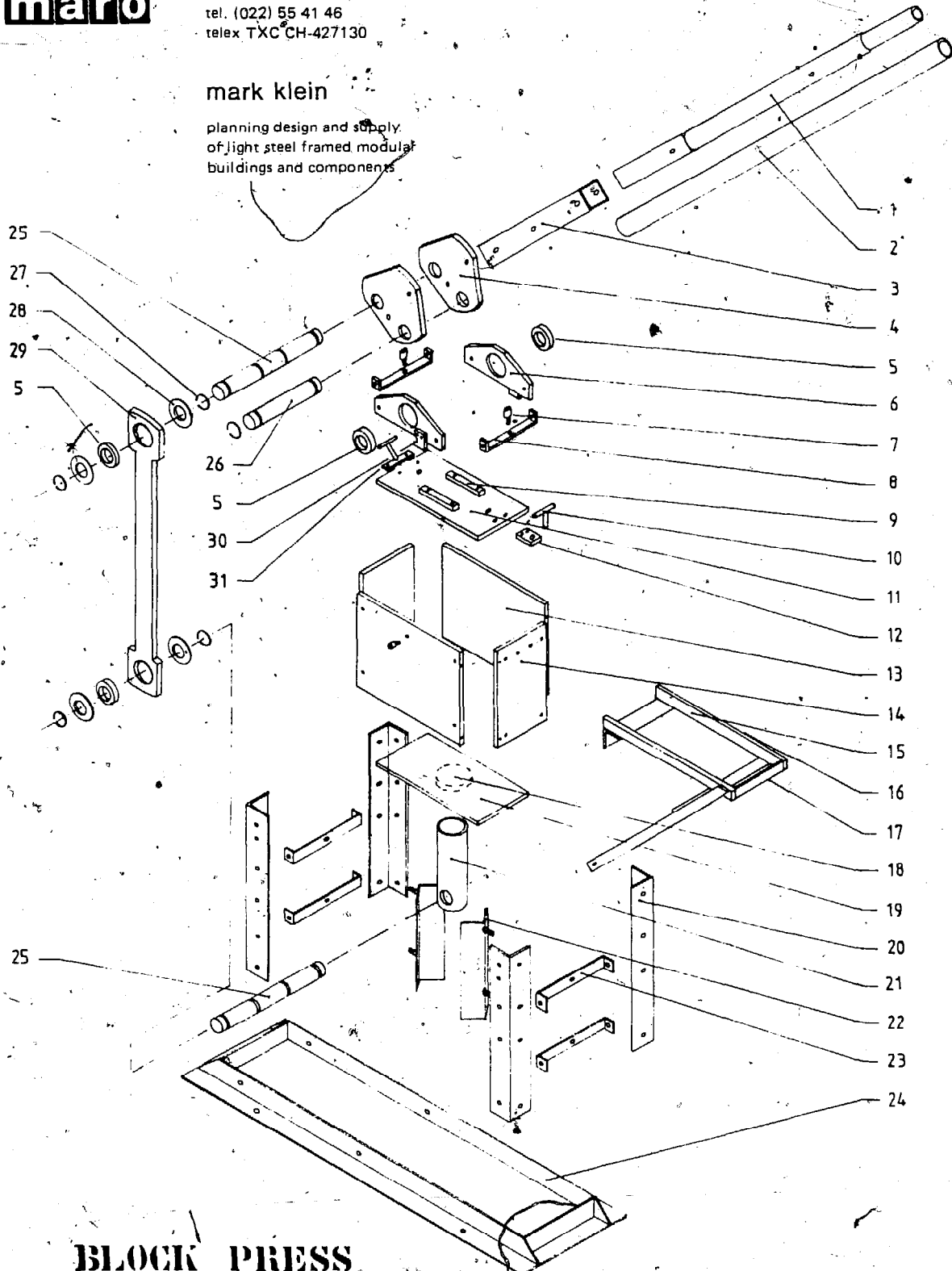

BLOCK PRESS

ref. no.	description	q. ty required	ref. no.	description	q. ty required
1	HANDLE	1	18	RETAINING PLATE (PISTON)	1
2	HANDLE EXTENSION	1	19	PRESSURE PLATE (BOTTOM)	1
3	HANDLE SLEEVE	1	20	LEG	4
4	CAM	2	21	PISTON	1
5	BALL BEARING	6	22	GUIDE	2
6	HOUSING	2	23	BRACKET	4
7	SCREW	2	24	FOOT	1
8	BRACKET	2	25	SHAFT	2
9	SKID	2	26	SHAFT	1
10	PIN HANDLE	1	27	CLIP	10
11	PRESSURE PLATE (TOP)	1	28	WASHER	8
12	PIN RETAINER	1	29	CON ROD	2
13	HOUSING SIDE PLATE (LARGE)	2	30	LOCK	2
14	HOUSING SIDE PLATE (SMALL)	2	31	HANDLE	1
15	RAIL	2			
16	SUPPORT	2			
17	BRACKET	2			

Block Production Sequence with the MARO Block Press

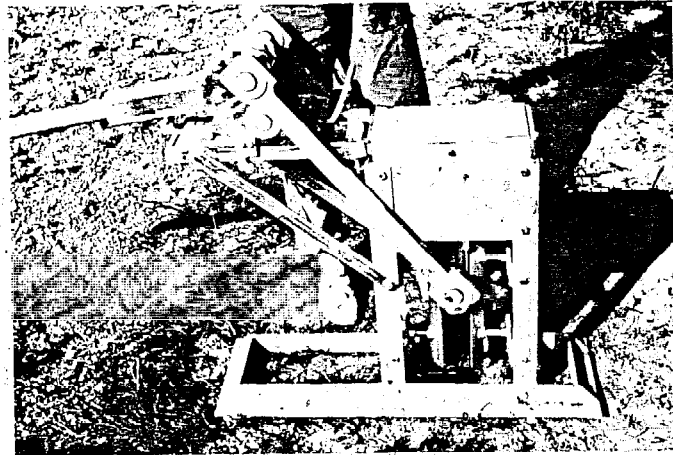
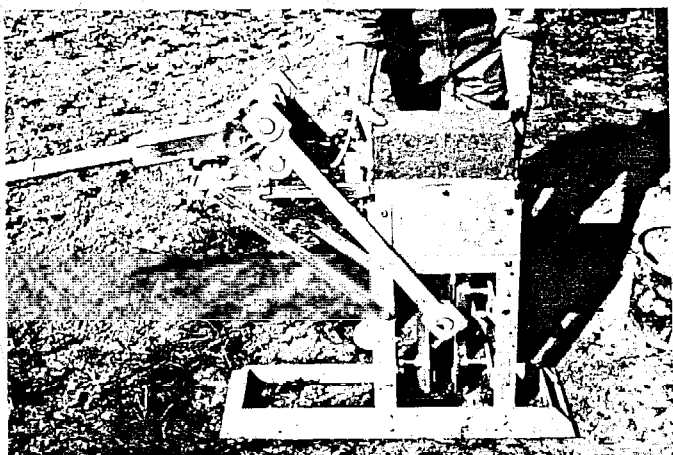
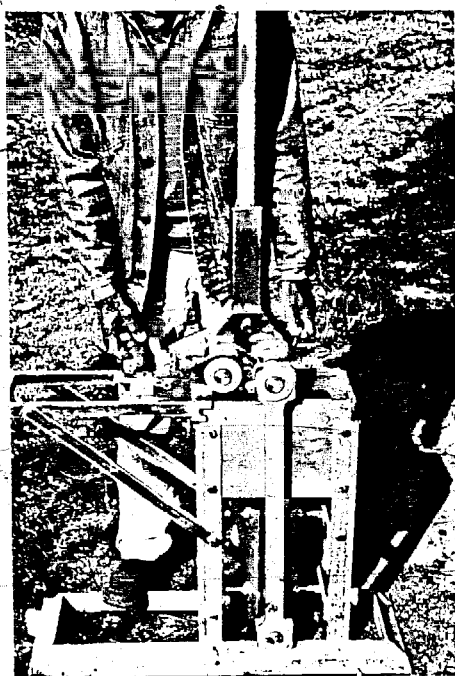
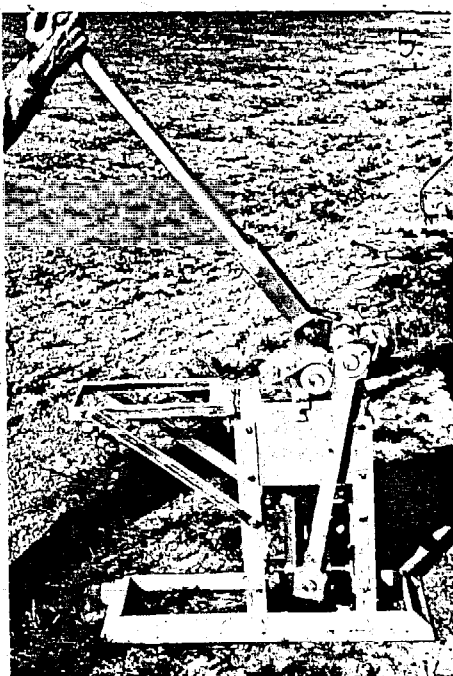
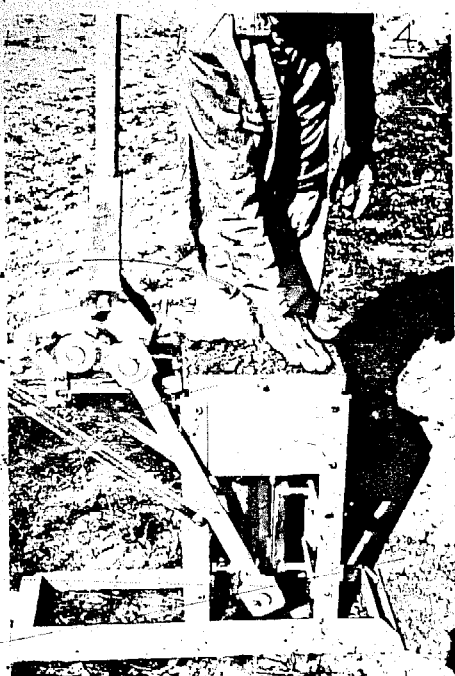
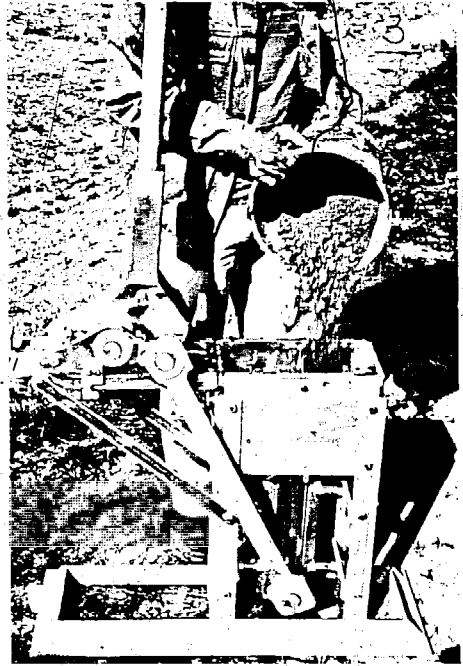
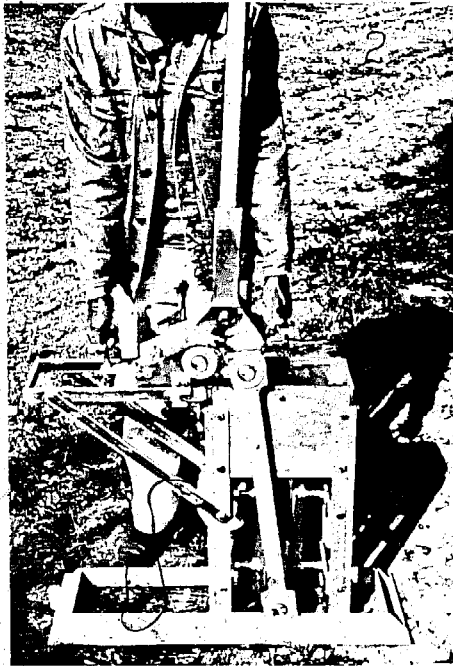
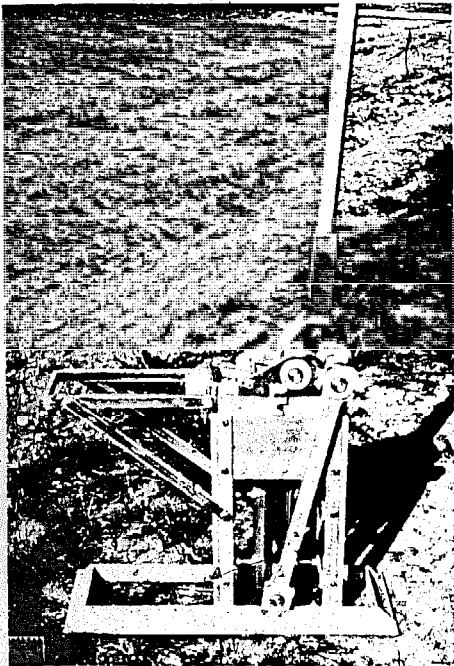

PRESSE MANUELLE C.T.B.I.

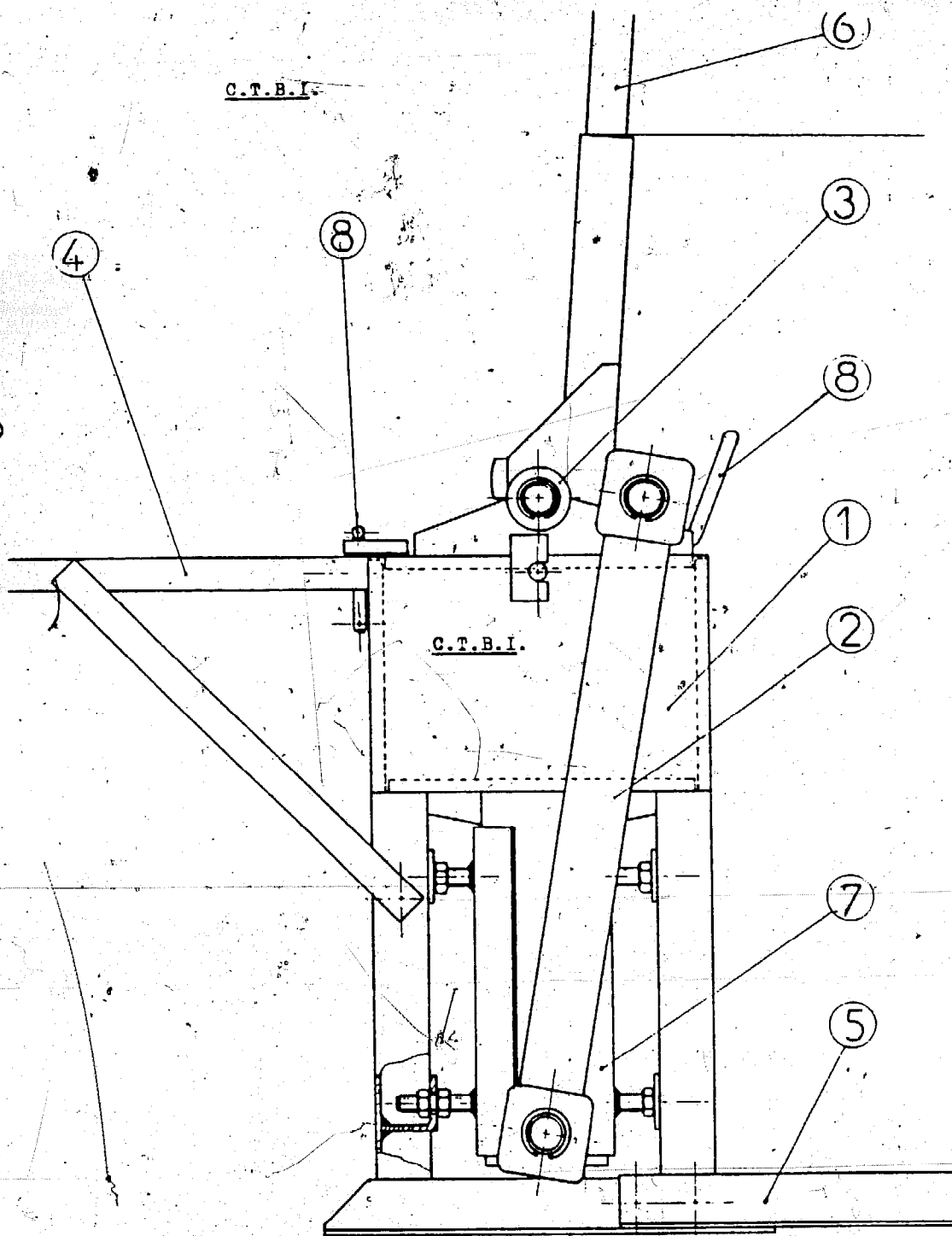

- (1) - MOULE EN ACIER SPECIAL POLI
- (2) - BIELLES EN ACIER MONTÉES SUR BAGUES "GLYCODUR" SANS GRAISSAGE
- (3) - MECANISME DE PASSAGE ET D'ÉVACUATION + COUVERCLE EN ACIER 1/2 DUR
- (4) - SUPPORT DE COUVERCLE EN FER PLAT
- (5) - STABILISATEUR EN FER CORNIÈRE DE 50 MM DEMONTABLE PAR 4 VIS
- (6) - LEVIER EN TUBE RENFORCÉ Ø 40 MM
- (7) - GUIDAGE PLATEAU INFÉRIEUR EN TUBE CARRE DE 80 MM DE CÔTE
- (8) - POIGNÉES DE MANUTENTION COUVERCLE EN ACIER ROND Ø 18 MM

PRESSE MANUELLE A TERRE DOUBLE SYSTEME

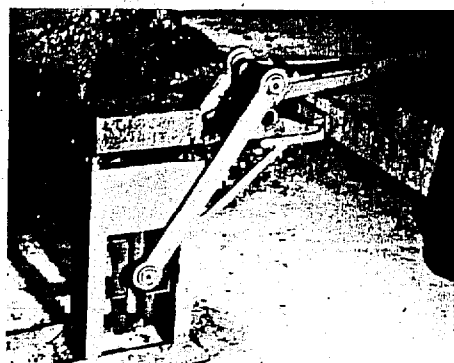
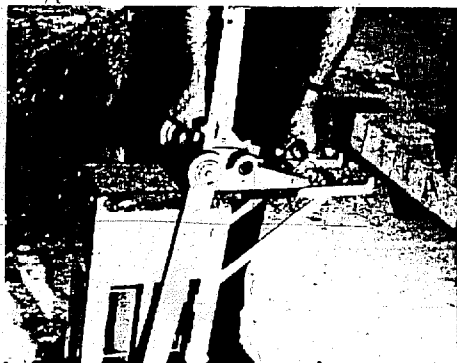
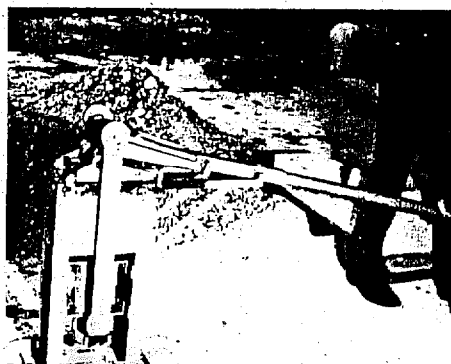
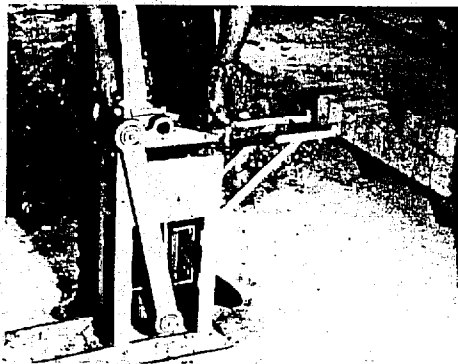

MANUAL EARTH PRESS DOUBLE SYSTEM

CONCEPTION BASED ON RESEARCH INTO THE PAST
+ EXPERIMENTATION IN THE PRESENT

- Simple and resistant mechanism,
- Minimal of physical effort,
- Compact design, Case size $0,95 \times 0,52 \times 0,33 = 0,170 \text{ m}^3$.
Weight (ready for use) : 85 Kg.
- Double (surplus) compression
Earth + 2% cement = 25 Kg./cm².
- Output (loading and unloading excluded) : 15 seconds for
a block of $29 \times 14,5 \times 11 \text{ cm}$.
- Full range of technical services : assistance, analyse,
climatic protection, etc...

63

CTBI MANUAL PRESS

. Double manual system (DSM)

a) DESCRIPTION :

Simple & resistant equipment made of current metallurgical raw materials.

Simple : in its original conception

- 1 stand
- 1 magazine press
- moveable floor for ejection
- one lever for both pressing and ejection

Simple : to assemble

- strain borne by soldered parts
- bolting, and mechanical soldering, for removable parts

Resistant : by the quality of materials used,
in its basic working principle.

b) OPERATING :

. Stage 1 - Filling of Frame :

The frame is filled by hand using a shovel or bucket. The quantity of earth required is indicated by the at rest position of the adjustable cover plate.

. Stage 2 - Closing of Frame :

To close frame, simply slide the cover plate forward over the opening.

. Stage 3 - Pressing by Lower Plate :

Pressure is applied in two stages. First the lower part is raised by bringing the lever from a vertical into a horizontal position. This requires very little effort.

. Stage 4 - Pressing by Upper Plate :

As soon as the lower plate stops rising, the upper plate is automatically lowered a short way, thus multiplying satisfactorily the final pressure exerted.

. Stage 5 - Opening of Frame :

The frame is opened by sliding the cover plate back across the opening.

. Stage 6 - Ejection :

The earth block is ejected by lowering the lever from a vertical to a horizontal position. This is a simple operation that requires no change in the position of the worker in relation to the machine.

Then back to Stage 1 by bringing the lever back into the vertical position.

c) PHYSICAL CHARACTERISTICS :

- . Weight : 85 Kg.,
- . Height : 1,02 m without lever/2.25 m with removable lever,
- . Length : 0,45 m without cover rest or stabilizer,
1,15 m with cover rest and stabilizer.
- . Breadth : 0,28 m
- . Average strain perpendicular to lever during pressing operation : 30 daN
- . Force exerted on block at end of pressing operation : 15 T.

d) TECHNICAL CHARACTERISTICS :

- . Simple and resistant mechanism.

e) OUTPUT :

- . Blocks of 29 X 14.5 X 10.5,
- . Weight : 10 Kg.,
- . Output varying with :
 - the product required,
 - the number of workers involved
 - the preparation for different types of earth

Average output 50 - 90 earth blocks/hour, with 3 workers. (preparation 1, press 1, ejection 1).

f) PACKAGING - TRANSPORT - WEIGHT :

Stand, lever and sliding cover plate are removable for easy transport.

All items are packed in a wooden box suitable for different types of transport as required.

Size of packing : 0,95 X 0,53 X 0,33, i.e. 0,170 m³; weight of 105 Kgs.

All types of transport are possible : plane, ship, truck (even small van, or boat of private vehicle); animal transport for African countries.

g) COSTS :

Depend on destination. An estimate will be given based on distance and importance of order.

This equipment is mainly designed for developing countries.

G.V.D. Heuvelstraat 131
3140 RAMSEL - HERSELT
België
Tel. : (016) 56 10 22
Bank : A.S.L.K. 001-1074596-09
BTW nr. 418718217

BRICK-PRESS



Packing, transport and prices :

The dimensions of a brick-press are as followed :

seaworth packed : 940 x 500 x 300 mm

unpacked : 700 x 450 x 260 mm

For daily prices you can better consult the price-list, which is freely available at UNATA secretariat.

For general transport-modalities : look at the last page of this catalogue.

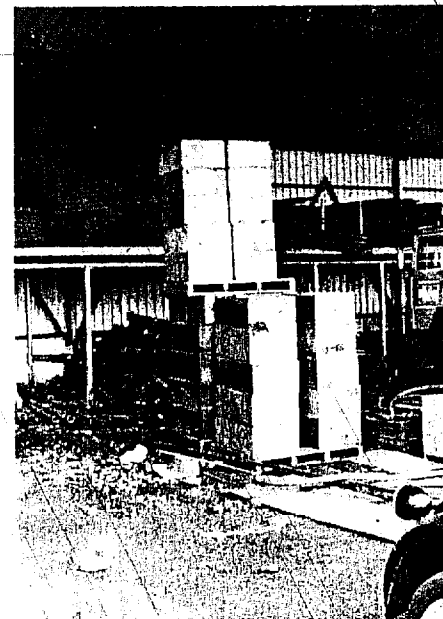

Which are the advantages of the UNATA brick-press ?

With the UNATA brick-press, it is possible to make building-bricks with the local earth. Such stones were already made in former times. They were called "adobes". The fundamental difference between the adobes and our building-stones, is that the adobes had to be pressed down by hand in wooden forms, while in our brick-press, a metal form is used, so that our stones are pressed under high pression.

Using pressed stones of earth has following advantages. :

You can press the stones at the same place wherever you want to build. The structure of the local earth is often suitable to make building-stones. The volume of water is minimal, so it is possible to build during the season. These circumstances give you the possibility to reduce production-costs and time considerably.

Working with the brick-press does not require special qualifications. When it is carefully used, it can be passed on to other people and communities (for instance by a sort of rentingsystem). So individuals as well as communities can use the brick-press without high expenses. Houses can be constructed more easily because of the regular form of the stones. These stones also better resist the tropical circumstances than the traditional adobes.

Advantages of the more perfectionated presses.

The UNATA brick-press has a low weight : 80 kg. It is easily transportable from one place to another, even when no carriages are available. Provided with the fastening-beam, which makes the press more stable, it can be moved over long distance by four people without a problem. The low price makes it purchasable for persons, communities, cooperations and little undertakings, who don't have much financial means. The UNATA brick-press is suitable for building dwellings, buildings for agriculture and buildings for public use.

After you have pressed, the power-arm has to be removed in opposite direction of the press, as far as possible, and the stone comes out.

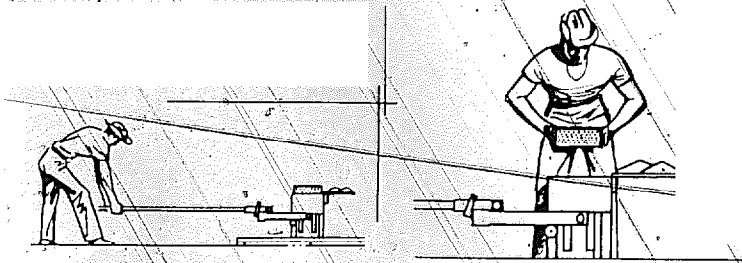

Here you can see the result. A stone that is very compact and regular of form, ready to dry for some days.



Production capacity.

How to use the brick-press ?

It is a simple machine, operated by hand. Maybe it's good to make a team, that's responsible for digging, pulverizing and pressing the stones. If necessary one can add a stabilizer (cement or mortar or a decoction of banana-leaves).

The brick-press has to be placed on a fastening-beam and a flat underground. One opens the cover and fills the form with earth, which is pulverized and sifted. One can add a stabilizer (5% mortar, cement or a decoction of banana-leaves), but this is not indispensable.

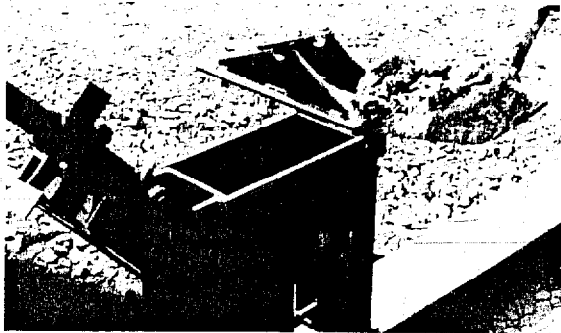

Close the cover and the stone is pressed by one person.



Depending on the number of workers, for instance 2 to 6, it is possible to press 20 to 60 bricks an hour.

The dimensions of the brick are : 29 x 14 x 9 cm.

Reckoning with these dimensions, one needs about 33 bricks a square meter to build for instance a dividing-wall.

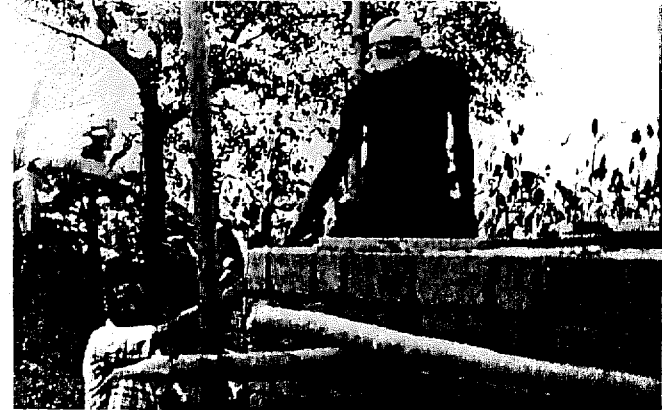

The building of a little house in Rwanda



A water-level, a rectangle and a string were sufficient.

DIRT-CHEAP BUILDING BRICKS

by NIC SNYMAN

A NEW concept in hand-operated brick presses has been developed by Mr Harold Jesson, of Port Elizabeth. The beauty of this press is that it uses mainly soil that is available anywhere at virtually no cost, and most subsoils, beneath the layer containing organic material, are suitable for providing the bulk aggregate.

The press is designed to bring what is believed to be a greater degree of pressure on to the mixture by manual means than has been possible before.

A production rate of about 1 200 bricks a day could be expected from three inexperienced operators from each machine. Much more could be expected by paying a production bonus.

The machine:

- Is very mobile and completely self-stabilised on most any surface without needing elevated rigging.
- Incorporates a filler hopper hinged to the machine which flips on and off the pressure box in two seconds. This is an important feature because it prevents waste by over-spilling.
- The lid opens and closes automatically at precisely the right moment.
- Converts about 70 kg, of muscle power on the two metre handle to about 1 600 kg or more on to the brick mixture.
- A "stop" on the machine ensures that all bricks are 73 mm thick — brick size 220 x 104 x 73 mm.
- One man operating the handle can compress and

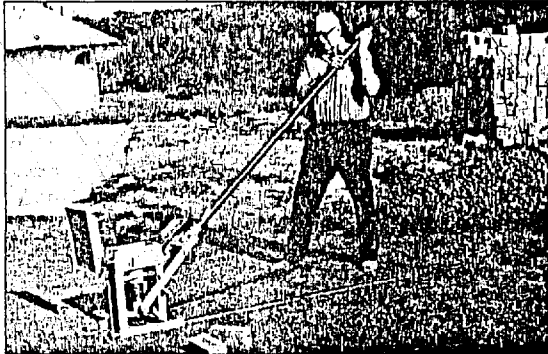

Mr Jesson demonstrating his soil-cement brick-making machine with a capacity of 1 200 bricks a day.

extract the brick in about six seconds, a second man removes the brick and refills in not much longer, the third keeps the mix in constant supply.

To reap maximum benefit from this ingenious press, a filler-gauge box should be made to ensure the same amount of mix is tipped into the box every time. This will increase production speed.

To do this simply make a satisfactory trail brick, extract it, tip it into a small empty paint tin (or similar container) break down and level off, then cut off the top of the paint tin level with the top of the mixture. You now have a gauge box suitable for that particular mixture.

Farmers should find no difficulty in producing economically bricks with a

With this machine, soil excavated on a building site can be used to make the bricks you're going to need to erect the building

DIRT-CHEAP BUILDING BRICKS

swing the hopper off the top of the box.

Without removing the chain, bring the handle to the vertical position and the lid will automatically close. Separate the handle from the stile by moving the coupling ring off the top of the stile to the shoulder and let the main pivot rest in the fulcrum vee on the lid. Compress to fullest extent. The pressure on the aggregate is now 1 800 kg with only 70 kg on the lever.

To extract the brick lift the handle to the vertical position and couple it with the stile with the loose ring and bring it to rest on the lower fulcrum. This automatically opens the lid by the chain. Press the handle to the lowest position and the brick is pushed out of the box top where it is removed with the angle plate provided.

When the handle is released the springs will pull the pressure plate down to the bottom of the brick-box ready for the next brick to be made.

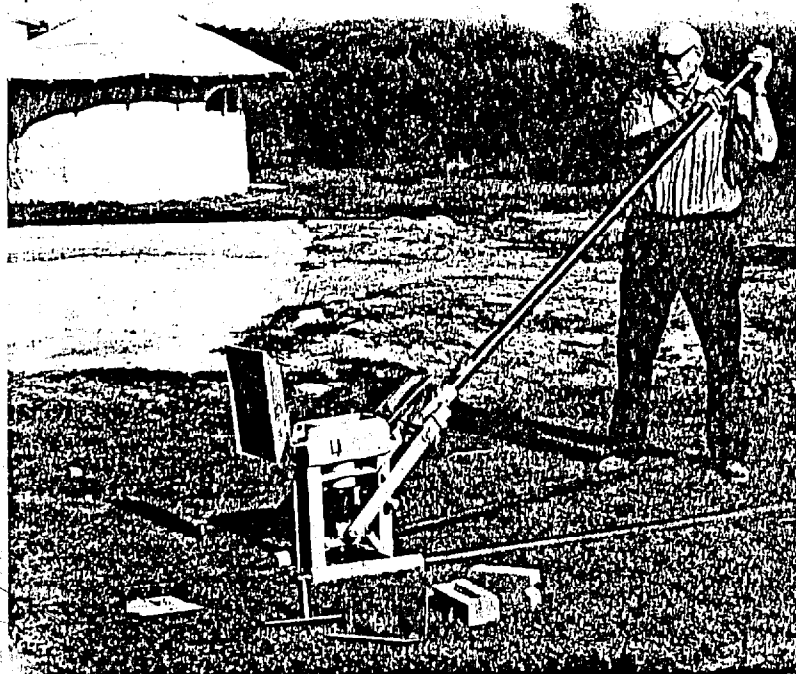
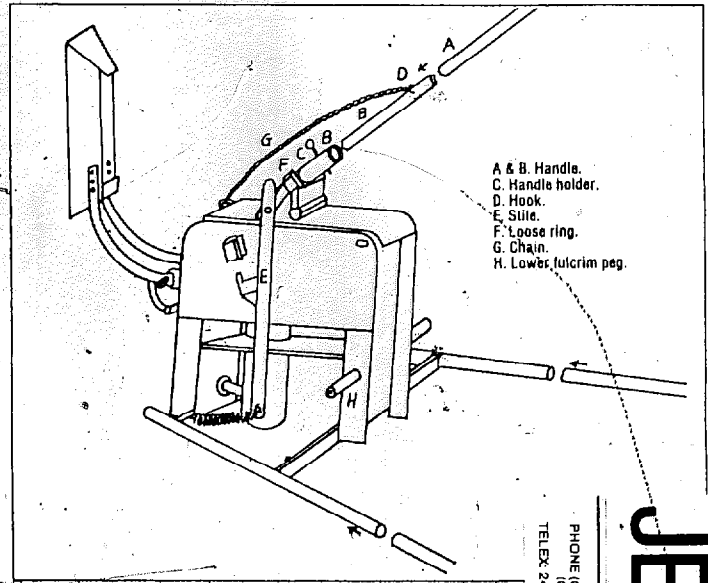

WITH the exception of soils that consist almost entirely of clay, turf soils and soils in humus, almost all soils can be stabilised with cement.

As a guide it can be taken that ordinary soils not containing appreciable amounts of gravel, should preferably contain rather less than 15 per cent of clay and between 20 and 45 per cent of silt and clay together (ie the sand (loam) should be between 55 - 80 per cent.

The stability is built up by a lattice work of cement grains dispersed through the material, no attempt being made to coat individual grains with cement as in the case of concrete. The cement reinforces and stabilises the natural binders in the soil.

There are three important factors — cement content, moisture content and degree of density.

These three factors vary with the type of soil and can be determined only by experiment. Enough cement must be added to produce satisfactory hardening. Start with say 10 parts soil to one part cement with enough moisture to pack the grains of soil as closely together as possible, the mix must be given the maximum density — Portland Cement Institute.

PHONE (041) 32-5438
(041) 32-4833
TELEX 24-3182

111 CIRCULAR DRIVE
FAIRVIEW
PORT ELIZABETH

P.O. BOX 684
PORT ELIZABETH 6000
SOUTH AFRICA

INCORPORATING JESSON BLOCK MOULDERS
JESSON INDUSTRIES

ABIDJAN - INDUSTRIE

A.B.I.

Boîte Postale 343 Abidjan - Téléphone: 553-60 et 564-60
45 Rue Pierre et Marie - Curie Zone 4 C

PRESSE A PARPAINGS DE TERRE BREVETÉE - S.G.D.G.

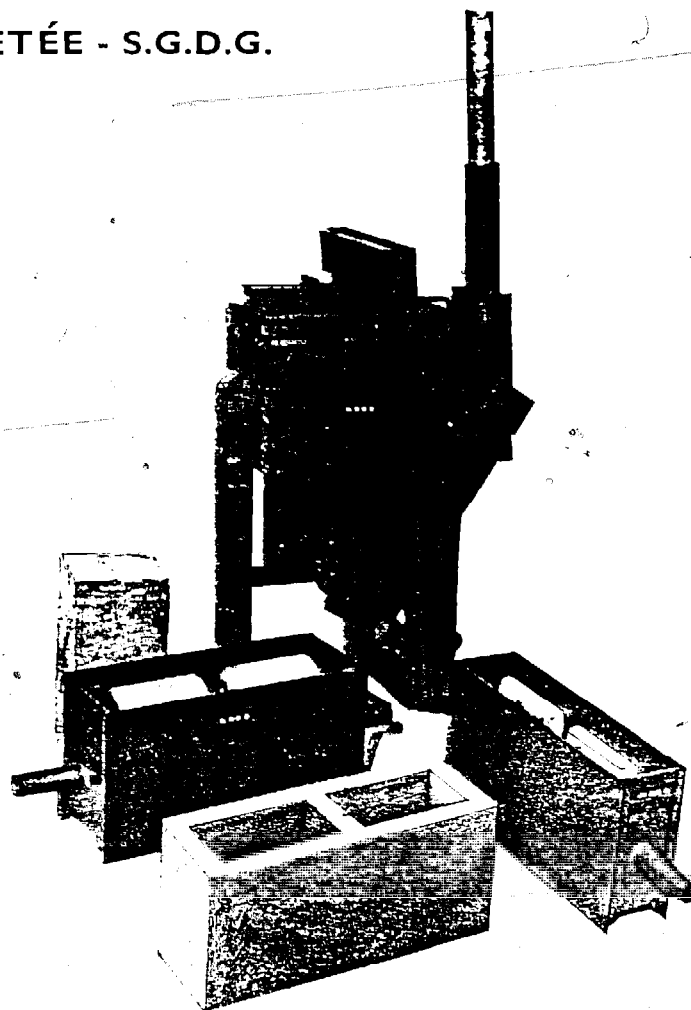

Notre presse à parpaing permet d'obtenir des parpaings de terre extrêmement compactés de 5 cm, 10 cm ou 15 cm d'épaisseur. Cette petite machine, étudiée et réalisée dans nos ateliers présente l'avantage d'être très maniable; sa robustesse lui garantit un long usage sans aucun entretien.

RENDEMENT DE LA PRESSE : deux employés peuvent mouler facilement 500 blocs de terre dans une journée normale de travail.

MOULES A MAIN : nous fabriquons des moules à mains pour parpaings de ciment.

Moules de 20 cm pleins

» 15 cm creux

» 10 cm creux

ainsi que des moules « claustrats » dit « boîte aux lettres ».

MÉCANIQUE - FONDERIE - FROID

Production Ivoirienne

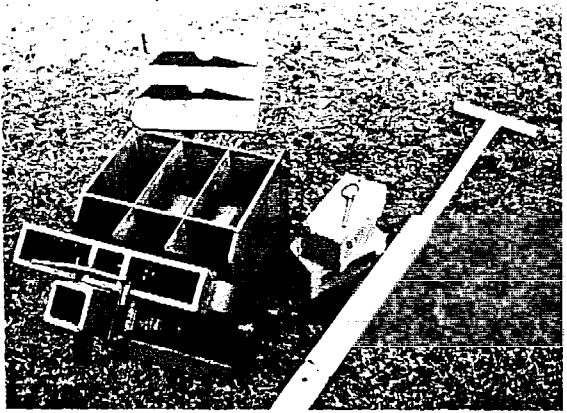
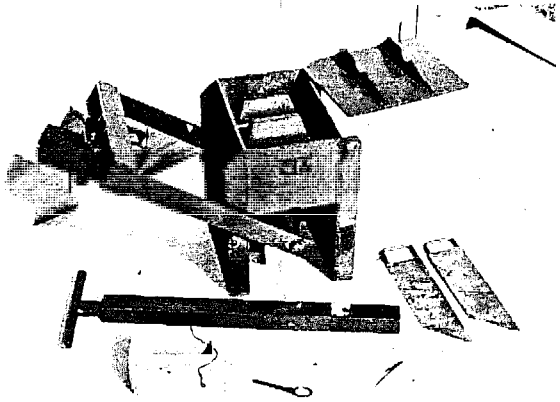

CTA Block Press



Placing the dividers before filling the moulds.



Position of lever just before compaction phase.

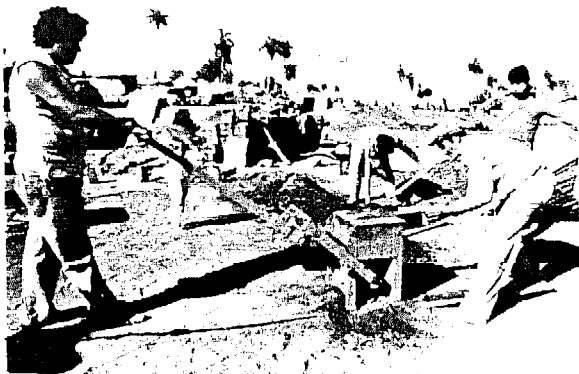

Pulling out the dividers after compaction.

On-site brick production with the CTA Press, for a church project in Paraguay.



Removal of the ejected bricks.



Laying out the fresh bricks for drying.

FABRIQUEZ VOUS-MÊME VOS BRIQUES EN TERRE COMPRESSÉE

(Produce yourself compressed soil blocks)

- Investissement minimum. *(Low cost).*
- Manipulation simple et rapide. *(Easy and quick to handle).*
- Bonne qualité des briques. *(Prime quality blocks).*

Une équipe pluridisciplinaire, une expérience de plusieurs années, plus de cinquante réalisations de terre : le CENTRE DE TERRE vous aide à construire

UTILISATION (USE)

- Utiliser une terre argilo-sableuse légèrement humidifiée et additionnée éventuellement de ciment ou de chaux (4 à 5 %) bien malaxée. *(Use clayed sand soil lightly moistured and eventually add lime or cement 4-5 % well mixed).*
- Fixer la presse horizontalement sur une longue pièce de bois. *(Fix tightly the press on a long beam).*
- Le levier est manipulé par une seule personne. *(The lever is handled by one person of the same time).*
- Les briques sont stockées à l'abri pendant 15 jours avant leur utilisation. *(Shelter the blocks during 15 days before use).*
- Nettoyer et graisser la presse après chaque utilisation. *(Clean and oil the press after every use).*

 **géo 50**

PRESSE A TERRE MANUELLE (MANUAL PRESS)



 sarl **SOUËN**

CENTRE DE TERRE
LAVALLETTE 31590 VERFEIL
 **61.84.73.98**

CARACTERISTIQUES

- Compression à double effet *(Dual compaction action)*
- Force maximale : 8 tonnes *(Maximal strength)*
- Pression moyenne : 15 à 20 bars *(Mean pressure)*
- Production : 20 à 50 briques/heure *(Output)*
- Poids de la presse : 100 kgs *(Press weight)*
- Dimensions minimales : *(Minimal dimensions meters)*
L 0,40 x l 0,35 x h 1,00 (m)
- Caractéristiques des briques : *(Blocks characteristics)*
 - longueur (length) : 29 cm
 - largeur (width) : 14 cm
 - Epaisseur (Thickness) : 9 cm
 - Poids (Weight) = 7 kgs.

FONCTIONNEMENT (WORKING PROCESS)

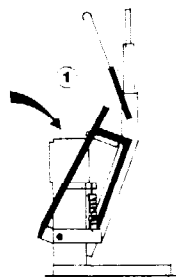

- Remplir le moule *(Fill up the mould)*

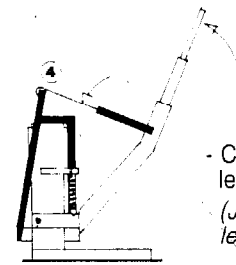

- Couplage levier-couvercle *(Join the cover to the lever)*

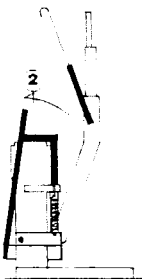

- Rabattre le couvercle *(Shut down the cover)*

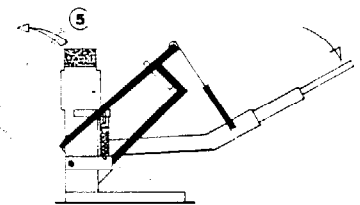

- Ejecter le bloc *(Block ejection)*



- Compression *(Compaction)*



- Retour en position de remplissage *(Return to the filling position)*

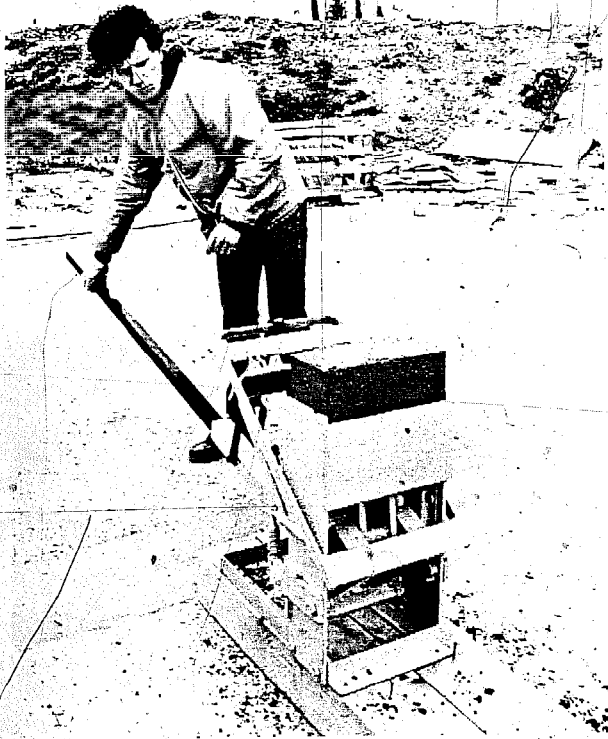

GEO 50

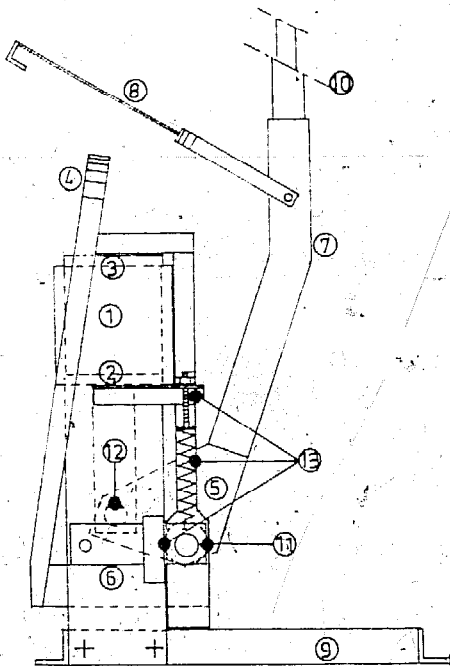

- 1- Moule en plaques d'acier épais soudées.
- 2- Plateau inférieur: plaque d'acier épais renforcé, fixé sur support tube potelet 60 mm et guidé par roulements étanches sur profilés cornières intérieux.
- 3- Couvercle: plaque d'acier épais renforcé et lié à -6- par tirant fer plat.
- 4- Arceau en fer plat cintré.
- 5- Sabot de transmission des efforts: plaque d'acier épais.
- 6- Chemin de roulement acier fer plat articulé par arbres \varnothing 30 sur palier.
- 7- Levier tube potelet 60mm.
- 8- Crochet de couplage articulé, fixé par bouton-écrou, fer plat plié.
- 9- Support stabilisateur amovible cornière 50/90mm fixé par 4 boulons écrous.
- 10- Rallonges levier amovibles, tubes acier emmanchés.
- 11- Roulements d'appui, étanches double face sur arbre acier comprimé \varnothing 30mm.
- 12- Articulation sabot - plateau inférieur arbre acier comprimé \varnothing 30mm sur palier graissé.
- 13- Système de suspension de l'ensemble couvercle - chemin de roulement à articulation et ressorts de rappel.

La PRESSE GEO 50 est entièrement démontable.
 L'entretien et la maintenance peuvent être ainsi facilement assurés avec un outillage simple.

The **SATURNIA** Press - developed at ETH-Hönggerberg, Zürich by H D Sulzer

AIM

Improvement of :

- Productivity of hand press, compared with that of the CINVA-Ram.
- Quality of end product:
 - a. Better consistency of compressive strength values through more accurate filling of mould (1% difference in filling can lead to 5% variation in strength)
 - b. Pressing on both sides, in order to achieve better, homogenous compaction on both faces of the block.

CONCEPT

- Hand press.
- Mobility on wheels.
- Compaction through toggle lever (like the CINVA-Ram)
- Mechanism under the mould (unlike CINVA-Ram)
- Lid attached to cam (unlike the CINVA-Ram), such that it is pulled down during compression, making the top surface compacter.
- Filling and measurement of the soil mix in a separate unit, which is adjustable to get optimum quantities, depending on the type of soil used.
- Possibility of making perforated blocks by means of inserts. (Sulzer: This proved to be a fallacy!)
- Compression and extraction following each other in the same movement of lever.

DISADVANTAGES (according to H D Sulzer)

- Price approx. 2000.- sFr, if manufactured in Switzerland (approx. 1200.-sFr, if made in a low-wage country).
- Weight approx. 200 kg (3 x CINVA-Ram).
- Hand press : difficult to motorize.
- Higher productivity (4 blocks/min) is illusory, since a team of 2-3 men cannot stand the effort for an 8-hour day.
- Pressing is not the best way to produce blocks; adobe is superior. However, right solution for soil-cement, or other pulverulent stabilizer. Especially suitable when the area for drying is small (pressed blocks can be stacked immediately on removal from the press).

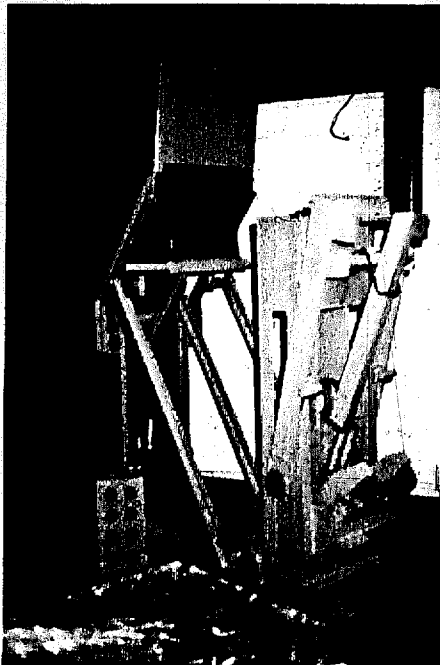

FILLING SYSTEM

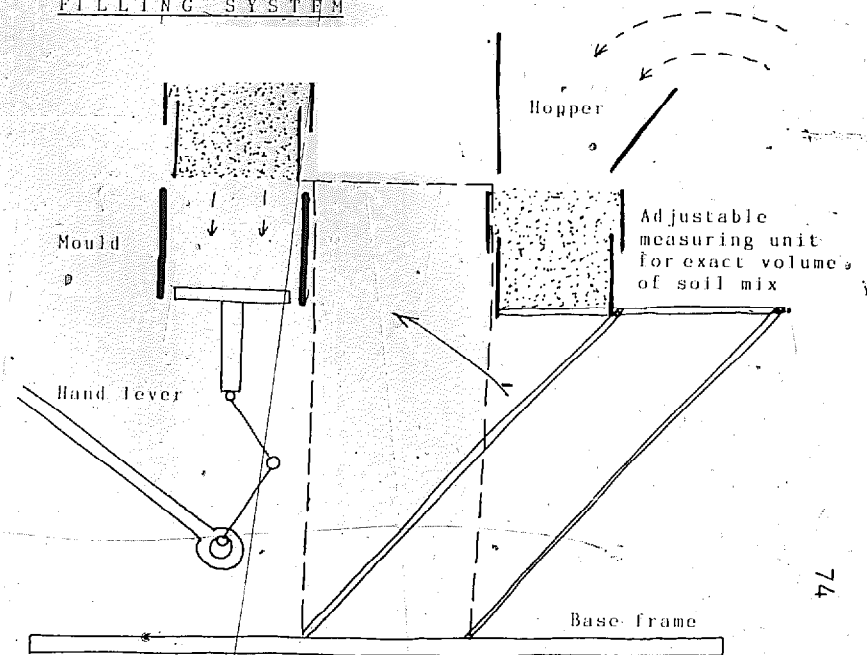

COMPRESSION ON UPPER FACE OF BLOCK

COMPRESSION PRINCIPLE

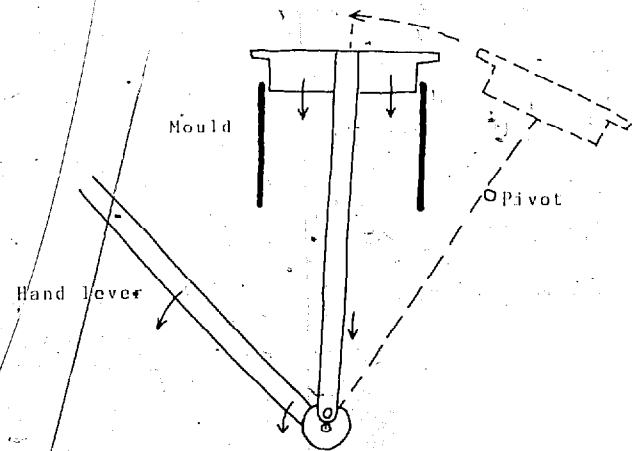
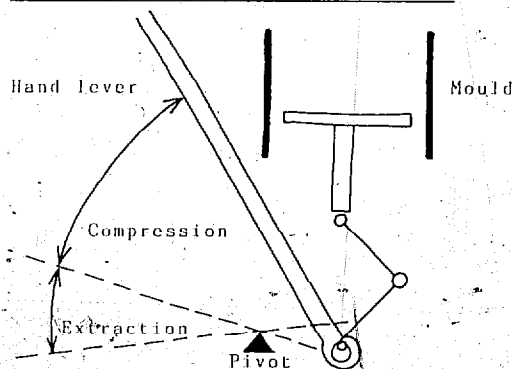

RIFFON Block Press

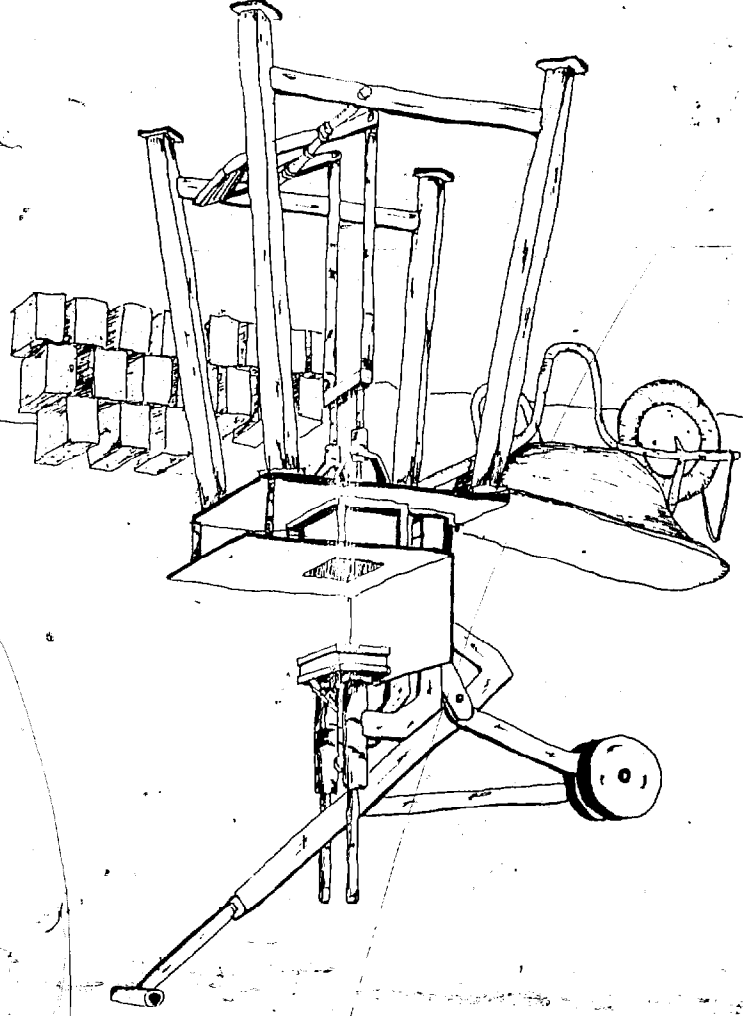

PRINCIPE.

Un bras de levier avec balancier, simple effet, permet la compression uniforme du matériau dans le moule situé sur la table. Le contre-poids permet, outre une compression élevée pour un effort normal, le retour automatique du bras de levier en position haute, sans lâcher. La table permet l'installation de différents moules suivant l'usage du matériau compressé : briques, tuiles, carrelages divers en terre crue.

CARACTÉRISTIQUES.

- Système complet, robuste, et sans entretien particulier des pièces mobiles (joints en Extralon)
Poids : environ 150 kgs.

Dimensions : hauteur du bras de compression en position haute : 2 m
hauteur de la table : 1 m
plateau : 550 mm x 415 mm.

Pression dynamique : taux : 1,78 pour une course du piston de 200 mm.
Dimensions des briques du moule standard : 220 mm x 105 mm x 60 mm.

- Le démoulage s'effectue par pression du pied sur une pédale amenant le fond du moule au niveau de la table.
- Système ergonomique : la position du bras de compression et de la pédale de démoulage permet un travail aisé en station debout, sans mouvement de grande amplitude.

USAGE.

Permet la confection de briques, tuiles ou carrelages en terre crue. Le poste de travail idéal complet, par système, un opérateur à la presse (remplit le moule, presse et démoule) et un ou deux préparés à la préparation de la terre (soignée 18 h de travail : environ 1,3 m³ de terre brute soit 2,2 m³ de terre soignée) et au rangement des briques (± 1000 briques/jour).

CONDITIONNEMENT.

Équipement annexe ou non standard (moule) : étudié en fonction de chaque cas.

Manufacturer : ELLSON BLOCKMASTER
 Kathiawar Metal & Tin Works Pvt.Ltd.
 9 Lati Plot, Rajkot (Gujarat), India

Distributors : JOSHI INDUSTRIES
 Rajkot Nagarik Sahakari Bank Building
 Room No. 4, First Floor
 Dhebar Road, Rajkot 360 001 (Gujarat)

Blockmaster

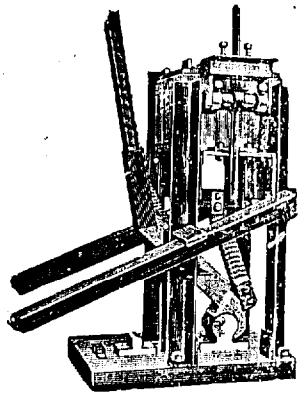

- No foundation required.
- The machine can be transported by bullock cart to the remotest village.
- Hand operated. No engine, no motor.
- Simple to operate. Employs unskilled labour.
- With "Soil on Site" there will be no transport delays, no breakage, no waste and with stabilised-soil no burning.



- All steel welded assembly.
- Base : 28" x 17"
- Height : 36"
- Inclined legs extend to 5 feet from rear of base.
- Total weight 456 lbs.
- Inclined legs and operating lever fully detachable.



The "pull-down" completed, the clamp released, out comes a "true-to-shape" home-building block 12"x5 1/2"x4" with built in Ellson high compression. The block is picked off right away.

Consistent charging of the mould is the very key to efficient operation of the Blockmaster. A specially designed triangular scoop is overfilled with a "ready-for-use" mix. The mix is struck off with a preset adjustable striker. The scoop now contains just the right amount of mix to be emptied into the mould. Proper charging of the mould ensures blocks of uniform weight and density. Note the two men on the operating lever standing on the inclined legs, ready for the "pull-down". These men must experience an evident effort in completing the compression stroke.

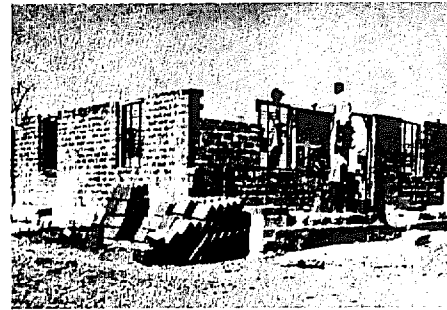

BLOCK BY BLOCK ... AT NAVAGAM

INTERCHANGEABLE MOULDS FOR MAKING
 BLOCKS ON THE SAME MACHINE.

Standard equipment : Machine complete with any one of the following moulds.

- Mould for Block size 12" x 9" x 4"
- or 12" x 5 1/2" x 4"
- or 29 x 19 x 9 cms.
- or 29 x 14 x 9 cms.

together with a pair of triangular scoops corresponding to mould size, a striker and a scraper.

Additional moulds may be ordered together with the machine or separately.



HOME BUILDING ... IN KERALA

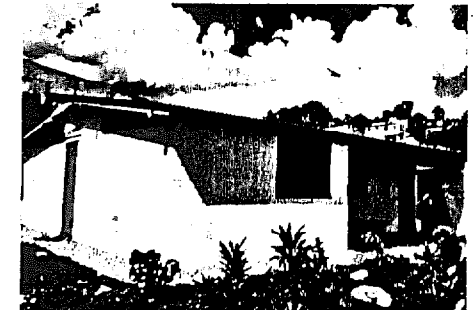

A neat cottage built with stabilised soil-cement blocks
 Labour for Block making

Block size	Operators Lever/Clamp	Total force	Output per day
12x9 x4"	2+1-3	10	750
12x5 1/2 x4" / 29x19x9cms / 29x14x9cms			
	2+1-3	8	1000

Note : Total force includes operators and labour for sieving soil, mixing, charging mould and carrying away pressed blocks for stacking. Output will be low in the beginning but the men will pick up as they familiarise themselves with the working of the machine, and the technique involved.

Block size	Dry sieved Soil per 1000 units	Dry Wt. of Block	Required per 100cft. walling
12"x9" x4"	Av. 315 cft.	26 to 30 lbs.	360
12"x5 1/2"x4"	Av. 250 cft.	16 to 21 lbs.	540
29x19x9cms	Av. 262 cft.	18 to 22 lbs.	515
29x14x9cms	Av. 228 cft.	12 1/2 to 17 1/2 lbs.	700

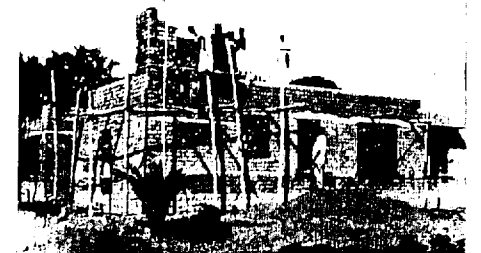

A bungalow coming up with cement-stabilised lateritic soil blocks, on the outskirts of Trivandrum.

The Ellison Lesson - - -

- Use of local material : One of the cheapest and most readily available building material is common earth. It has been used for thousands of years for floors and walls in all parts of the world. In India earth is widely used as a building material even to-day, especially in areas having dry climates. Adobe building blocks, stones set in mud, sundried bricks and the pisé-de-terre methods persist to this day.

- The problem : Traditionally used, earth constructions suffer from serious defects, viz. poor durability when exposed to weathering, movement of walls due to moisture and temperature changes, impermeance of protective coatings such as country plaster and soft, unhygienic dusty floors.

- Stabilisation : Many of the above drawbacks can be overcome by adding a small quantity of cement (or other stabilisers such as lime, bitumen cutback etc.) to selected soil and by applying mechanical pressure to produce well pressed, true-to-shape building blocks. Cement is a binder of the highest efficiency and betters by far the straw and animal wastes used in conventional rural mud houses.

- Type of soil : Nearly 80% of the earth's soil is suitable for use with Ellison machines. Soils containing an excessive amount of clay are objectionable from the shrinkage point of view. Clayey soils such as Black cotton soil, swamp soils, peats and fatty clays are hard to dig when dry, the clods and lumps are stiff and it is difficult to break them down to a uniform size. Wet mixing is cumbersome as the mix tends to "ball" and considerable effort is required to disperse the added moisture, uniformly throughout the entire mass.

Whilst excess of plastic characteristic is to be guarded against, soils containing a larger percentage of sandy particles than the combine percentage of silt and clay are more suitable for stabilisation with smaller percentage of cement admixture. Well graded sandy soils (i.e. the sand portion of such a soil can be differentiated into particle sizes varying from coarse to medium changing to fine) with a reasonable amount of clay content to impart packing or lump forming ability, are the best. The clay content in the soil does play a vital part in imparting to the wet soil an ability to form a well compact lump. This inherent cohesion allows the block to be carried away bodily by picking off with bare hands, without any support on its underside.

An ultra sandy soil or pure sand lacks this cohesion and can retain its moulded shape only if initially supported on the sides and underside in the form of 'boxing'. Red loams, decomposed granitic and lateritic soils are excellent. Best results are obtained with soils containing 60 to 75 percent sand. The selected soil must be free from organic matter.

- Preparing the soil : If the soil is damp when dug up, it should be spread out in the sun for drying. When it has dried out sufficiently, all lumps and clods in the soil should be broken down and pulverised and the soil screened through a standard $\frac{1}{2}$ " mesh sieve. The sieved soil is dumped under a shed or cover to protect it from wind and rain. To keep the blockmaking operation uninterrupted, there must always be sufficient stocks of ready sieved soil on hand.

- Dry Mixing : Mixing is carried out on a volume basis. It is convenient to make a small wooden box so as to have an equal measure for the soil and cement. (Note one bag of cement corresponds to approx. $1\frac{1}{2}$ cubic ft.) The dry sieved soil and the determined quantity of cement are then intimately mixed by the ordinary shovelling process until the cement is uniformly distributed throughout the entire soil mass and the resulting admixture is of uniform colour and texture.

- Wet Mixing : To obtain best results the soil should be moistened at its optimum moisture content. This figure can be determined in a soil Testing Laboratory. A practical field method is suggested here. The heap of dry soil-cement admixture, is spread out and water is sprinkled all over with a fine rose watering can. The mix is continually turned over and any resulting wet lumps are broken down and rubbed with the drier surrounding mix to obtain uniform dispersion of the added moisture. A handful of the mix is now tightly pressed in the hand to check if a good compact lump can so be formed. Again the wet mix is spread out, more moisture sprinkled and the mix thoroughly turned over as before. The lump forming test is again carried out. The moisture content should sparingly but confidently be increased until the mix when tightly squeezed in the hand retains its lump or 'balled' form, without soiling the hand and without crumbling. On no account should mud be formed. Once such a mix of uniform consistency is obtained it must be immediately used up. A wet ready-for-use mix should not be left unutilised for more than an hour.

- Blockmaking : To obtain blocks of uniform quality and resistance, special care must be taken to fill the machine mould each time, with the same quantity of mix. A pair of triangular scoops are provided for each corresponding mould size. The scoop is overfilled with the ready-for-use mix and the material above the inclined plane of the scoop is given a strike with an adjustable striker. The quantity now remaining in the scoop is deposited into the mould. (Alternatively weigh batching of the ready-mix using a simple spring dial scale with a suspended metal scoop is most accurate) The lid is slammed and the clamp applied. The operators on the lever now swing back to complete the "pull-down". The box must be filled with a quantity of mix sufficient to require an evident effort by the operators when they pull down on the lever. It is improperly filled if the lever offers no resistance and overfilled if the operators cannot bring the lever down even with some extra effort. In the latter case the mould must be refilled, as any undue jerking effort on the lever to accomplish the pull-down will damage the machine's mechanism and tire out the operators. Once the pull-down is completed, the clamp is released and on further pressing down of the lever the block is ejected clear off the top of the mould. The block is picked off and carried to the stacking and curing place.

Lubrication of the mould walls with an occasional wipe of an oily rag will help.

- Curing : The curing process is of great importance and if not done correctly it may ruin the results of the previous work. The dampness of the blocks must be eliminated slowly and regularly, after their manufacture. This process must be carried out under cover protected from the direct incidence of sun and rain. Special care must be taken to see that freshly made blocks are not exposed to hot blasts of wind. Curing can be done under a shed or in its absence, the rows of blocks can be covered with large leaves, wet gunny bags etc., As soon as the blocks have sufficiently hardened to prevent damage to their corners and surface, (say three to four hours after moulding) water should be lightly sprinkled over these with a watering can fitted with a fine rose. Twenty four hours after making the blocks, by which time the blocks will have hardened sufficiently to permit handling, these may be moved for close stacking. Stacked blocks must be covered with wet gunny bags or hay and watered at intervals to keep the entire stack in cool dampness for the first seven

days. During these days, care must be taken to see that the blocks do not dry in between the waterings as otherwise their strength will be affected.

After the wet curing period of seven days, the blocks should be allowed to dry out gradually for about eight days. It is essential to dry the blocks fully and allow their initial shrinkage to be completed prior to placing in the wall.

STABILISED BLOCKS REQUIRE NO BURNING

- Cement : The amount of cement to be used as stabiliser will depend upon the type of soil and the end use of the block. Generally with a good sandy soil blocks containing as little as 5% cement (i.e. 20 : 1 mix) are adequate for constructing single storey buildings. The proportion can be increased to 8%.

Rain bearing and external walls can be of a richer proportion of cement compared to internal partition walls. Walls upto the general working height in a house may have a higher admixture of cement thereabove changing to a lower proportion. Plasters : must be thin and not too rich in cement. Sand-lime-cement plasters applied thinly will work much better. Generally the blocks need no other finish than two coats of white wash. Mortar : For mortar joints the same soil used in the manufacture of the blocks is recommended, but mixed with cement and lime. A good proportion is one cement : two lime : nine earth.

- Use of Lime as STABILISER : Good results can also be obtained with lime when working with soils of high clay content. Lime used in conjunction with cement (thereby also reducing the total quantity of cement required) affords better impermeability to the resulting blocks. The advice of a soil testing laboratory in such cases is worth all the effort. Curing time is longer.

- Floor tiles of size 12"x6 1/2"x2" can also be produced on the Blockmaster, but using a soil cement mix of richer proportion. The objective of this is to make the tiles more resistant to the wear to which they are subjected. Still better results can be obtained, if a fine layer of sand and cement (2:1) is spread on the bottom of the mould box before filling it with the soil-cement mix. This layer can also be mixed with mineral colours.

FIGURE 22

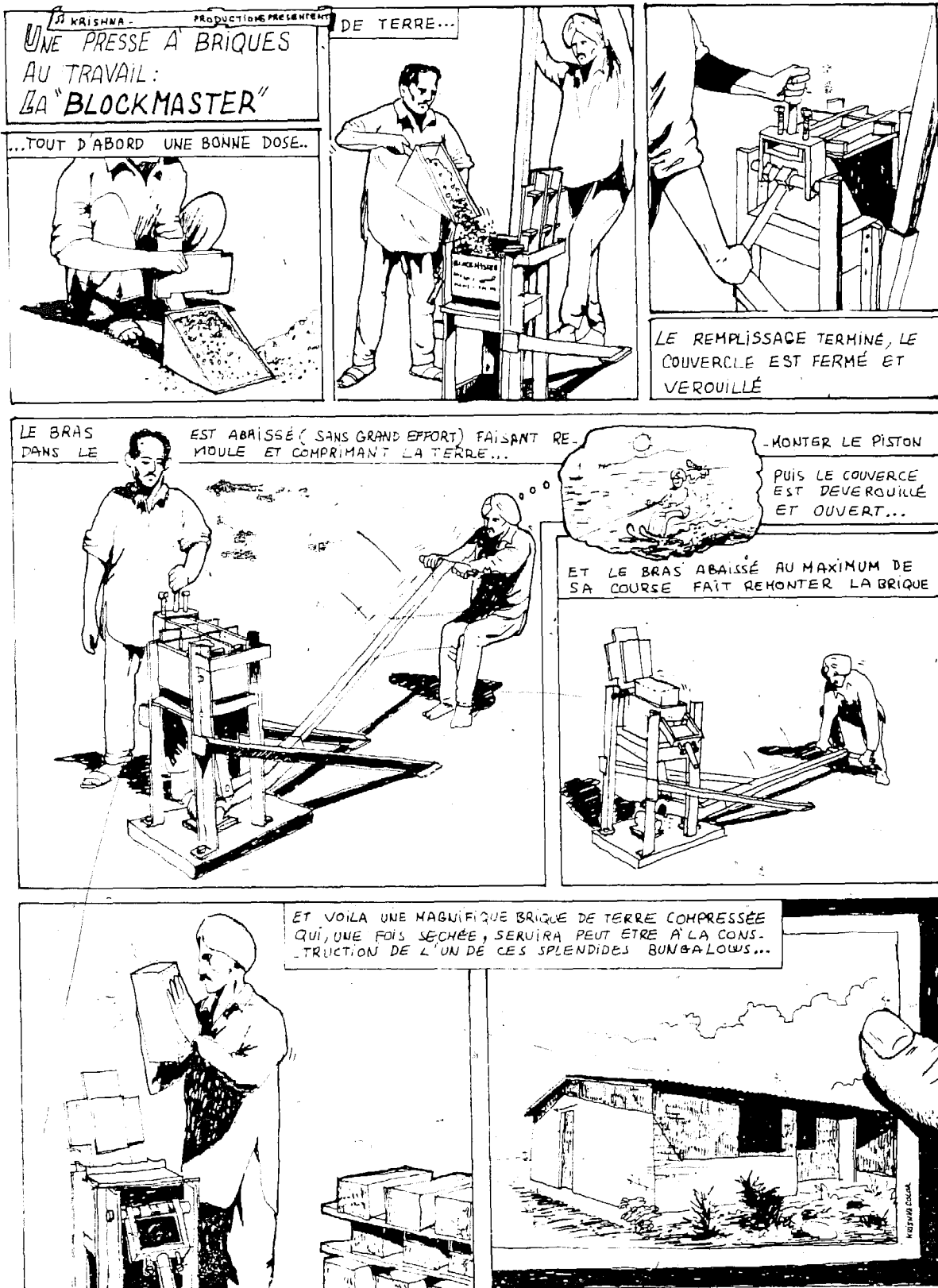

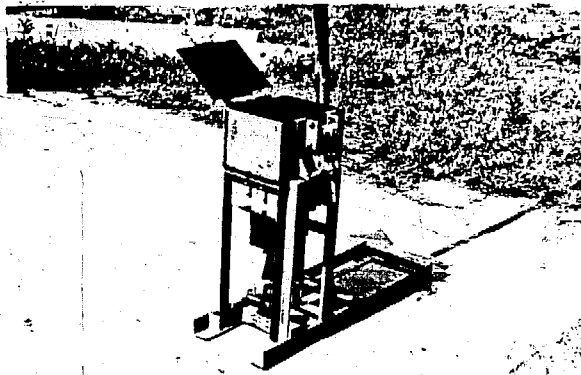

Plate-1. The Astram



Plate-2. Filling the Astram mould with soil

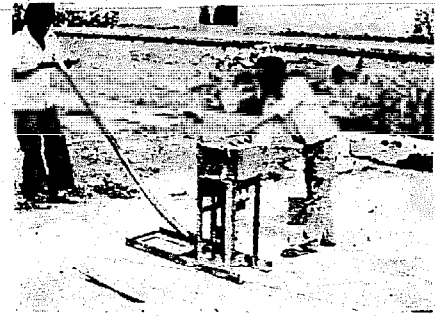

Plate-3. Soil Block Compaction.

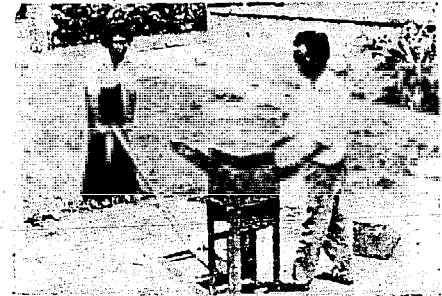
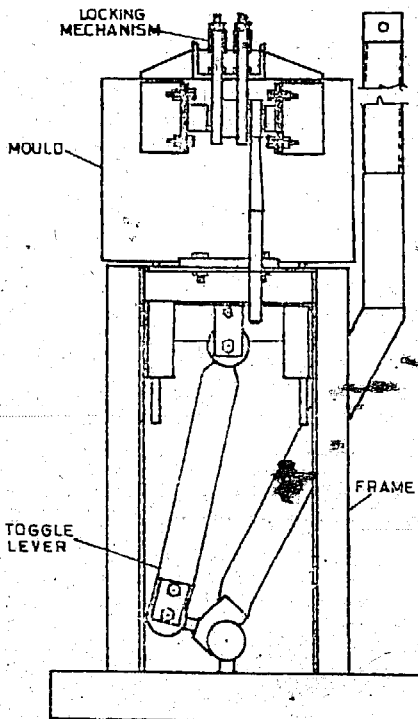
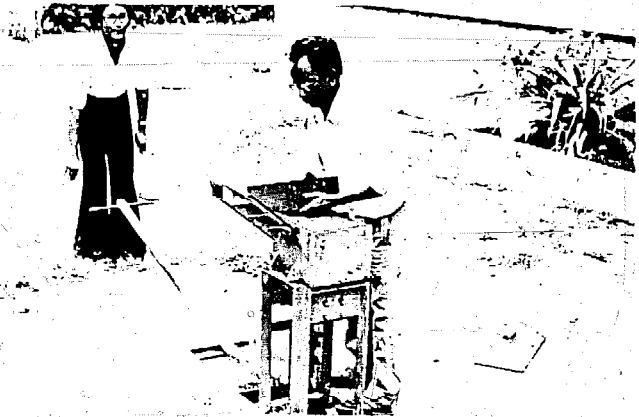

Plate-4. Ejection of soil block.

Developed at ASTRA
Centre for the Application of Science
and Technology to Rural Areas
Indian Institute of Science
Bangalore 560 012 / INDIA



(a) ENG. ELEVATION

FIG.1. ASTRAM

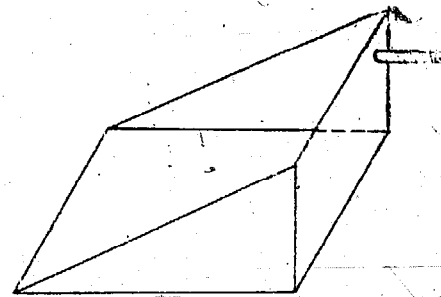

(b) SCOOP.

Manufacturer :
M/s AEROWELD INDUSTRIES
B9, HAL Industrial Estate
Bangalore / INDIA

often on the type of clay mineral in the soil. A direct attempt at block compaction in a machine will reveal the feasibility or otherwise of the block manufacture. A soil with high clay content will lead to a block with lots of cracks on drying. On the other hand, block making with highly sandy soil becomes virtually impossible due to the very large forces needed by sandy soils during compaction.

The presence of clay in a soil can be easily recognised by its tendency to form lumps in the dry condition. A good amount of clay is indicated when a dry soil lump cannot be easily crushed in the hand. The presence of coarse sand particles can be ascertained by squeezing the wet soil in the hand. If the soil is too clayey it can be improved by mixing sand or sandy soil. However, highly clayey soils can pose problems while mixing. The red loams and lateritic soils of South India are generally suitable for compacted soil blocks.

It would be ideal if the soil at the site of the building can be used for the making of the blocks. This would completely eliminate the need to transport the blocks. In the event of the local soil not being satisfactory for block making, one could consider mixing it with a better soil transported from a different spot. As a rough guide to the quantities of soil needed, it may be assumed that a 25 square metre (plinth area) house will need about 19 cubic metres of loose soil. This much of soil can be obtained by digging to a depth of 15 cms. over a 10 m x 13 m site.

3. THE ASTRAM (Plate-1)

Figure 1a shows the end elevation of the ASTRAM. The machine consists essentially of (1) a mould to receive the soil, (2) a toggle lever mechanism to compact the soil and (3) a frame to support the mould and the toggle lever. The mould is provided with a stiffened plate lid which can be locked down after closing with an eccentric locking mechanism. The mould is interchangeable and currently moulds of two sizes are being used with the ASTRAM. The two moulds can produce blocks of sizes 30 cms. x 14.5 cms. x 10 cms. and 30 cms x 23 cms. x 10 cms. respectively. The frame of the ram can also easily accept moulds of other sizes, if needed. Figure

1b shows the scoop which is to be used in measuring out the right amount of soil. Moulds of different sizes must be used with corresponding scoops. The ram with the smaller mould weighs 107 kg.

4. SOIL BLOCK COMPACTION IN THE ASTRAM

The following steps are to be followed in compacting soil blocks in the ASTRAM.

(i) Preparation of the soil:

It is desirable to remove roots and large pieces of stones (> 1 cm. in size) from the soil before producing the block. The compaction of the soil in the machine must be carried out at a moisture content which is as close to the optimum moisture content as possible. It is not essential to carry out an 'optimum moisture content measurement' for every block making operation. A simple field test can be used to determine whether the moisture content is right or not. When the moisture content is optimum, the soil can be easily pressed into a ball in the hand and it hardly sticks to the palm in the process. For a majority of the soils, this moisture content varies between 12% to 16%. The requisite amount of water is to be added to the soil with a fine sprinkler and the soil is to be thoroughly mixed by hand.

(ii) Soil block making in the ram:

(a) The lid of the mould is first opened completely and the compaction lever raised to a vertical position (Plate-2). The lever must be held as close to the mould as possible. The interior of the mould may be initially smeared with used lubricating oil or any other cheap oil (This may be repeated once after 5 or 6 blocks are made). The thin base plate of the ram is now placed at the bottom of the mould. The prepared soil is now measured out in the scoop and poured into the mould. The sharp end of the scoop must be pushed deep into the mould and the soil emptied by an up and down motion.

(b) The lid of the mould is now closed with a slight impact and is held down by the eccentric locking arrangement.

(c) The compaction is now carried out by pressing the lever down till it reaches the stopper (Plate-3). During this operation, the base of the mould moves up by 6 cms.

(d) The lid is now opened by lifting the block lever. The compaction lever is pushed further down through an angle of about 20°, forcing the compacted mud block out of the mould (Plate-4). The block may now be removed by sliding it horizontally along with the base plate. The lever must be held down while the block is removed from the machine.

(e) The block is now kept for drying/curing on its side and the base plate brought back to the mould for the next block. The compaction lever is now raised up and the base plate inserted in the mould. The machine is now ready for the second block.

(iii) The stacking of blocks:

The blocks are to be stacked for drying/curing in a shaded area on level ground. The area used for stacking must also be as close to the machine as possible. The blocks may be stacked one above the other upto five layers.

(iv) Hints for trouble-shooting in compaction:

(a) In a satisfactory compaction, some resistance will be felt towards the completion of the stroke. In case, the compaction is too easy, it is possible that too little soil was used and the resulting density and strength will be on the low side. A little extra soil may be fed into the mould so that increased density and strength will be achieved.

(b) Sometimes the compaction stroke cannot be completed due to high resistance. It is possible that one of the following is happening:

1. Too much soil has been fed into the mould.
2. The amount of moisture in the soil is inadequate.
3. The soil is too sandy.

The situation in cases 1 and 2 can be remedied by using lesser soil and more moisture respectively. Situation 3 needs a mixing of more clayey soil to reduce compactive effort.

(c) The weight or the density of the block is generally a good index of its quality. The 30 x 14.5 x 10 cms. block will generally weigh 8½ kg or more when it is just out of the machine. Similarly the 30 x 23 x 10 cms. block will weigh 13 kg. or more. A block which is very much lighter must be rejected. The block with low density can often be usually recognised by its rough and porous surface texture.

(d) If the moisture is too much the soil will tend to stick to the sides of the mould. The corners will appear to be out of shape.

(e) The locking lever of the lid can sometimes get jammed. This can happen especially if excess soil has been fed into the mould. The lid should not be forced open in such cases. The locking bolt of the lid must be loosened with a spanner to release the locking pressure. The bolt must be brought back to the original position before the next block is made.

5. STABILISED SOIL BLOCKS

It is generally preferable to make compacted blocks out of stabilised soils for exterior use. This is not to discredit the fine performance of mud walls which is often observed in many rural areas. The soil properties which contribute to the durability of mud walls have not yet been clearly understood. It is hence desirable to be more circumspect about the performance of unstabilised soil blocks, until more detailed information about soil behaviour under varying climatic situations is available.

EL BLOQUE DE TIERRA PENSADO

El bloque de tierra pensada es una técnica intermedia entre el adobe y el tapial, es:

- parecido al adobe porque utilizamos un molde
- parecido al tapial porque tratamos de compactar tierra húmeda y no barro.

Se necesita una máquina especial: una prensa para bloques de tierra (las bloqueteras para cemento no sirven).

Existen varios modelos de prensas. CRATERRE ha diseñado y construido en 1980 en los talleres del observatorio de Huayao (Instituto Geofísico del Perú) un primer prototipo de prensa fabricada con materiales comprados en el mercado local.

Una de las ventajas es que se puede hacer bloques en época de lluvia, porque los podemos almacenar inmediatamente dentro de un local, colocando hasta en dos hileras los bloques frescos.

Estos bloques secan en una semana, al sol y afuera, y en un mes, dentro de una casa. Tienen que estar completamente secos antes de usarlos.

Actualmente, CRATERRE está construyendo varias prensas en talleres de Huancayo, que se prestarán a comunidades que van a realizar construcciones comunales.



Un bloque recién salido de la prensa ya se puede poner de canto.

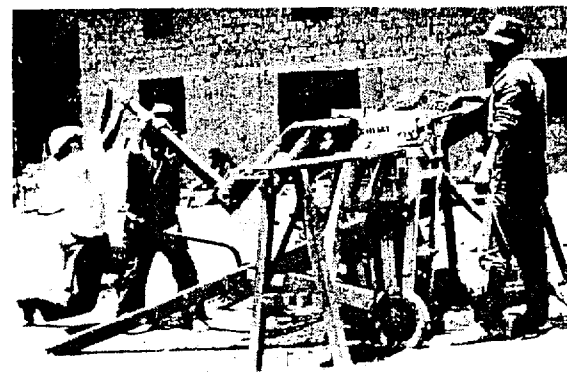

Fabricación de 5,500 bloques durante la época de lluvias por los comuneros de Colpar, 1981.

Los bloques pueden tener formas diferentes según el uso a que se los destine.

Por ejemplo, hay una forma especial de bloques para reforzar el muro con madera. (ver albañilería armada)

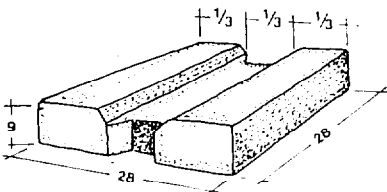

Bloque entero

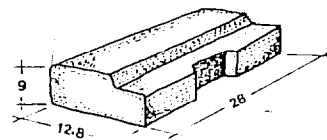

Medio bloque

Esta técnica permite estabilizar la tierra con cal o cemento, sobre todo de los bloques que deben resistir más a la humedad. (ver mejoramiento de la tierra)

CRATERRE Perou Block Press

Como producir los bloques con la prensa CRATERRE

- o **Preparación de la tierra:** Es tan fácil como en el tapial. Pero, hay que desmenuzar la tierra y sacar las piedras. Mejor todavía es cernir la tierra con una malla de media pulgada.
- o **Verificación de la humedad de la tierra:** la cantidad de agua en la tierra debe ser muy exacta, debe ser un poco húmeda. El control preciso de la humedad está descrito en la página del tapial.
- o **Moldeo:**
 - Se lleva la tierra a la mesa de la prensa por montones, para que el hombre que moldea tenga siempre tierra a la mano.
 - En el fondo del molde se coloca una planchita de triplay.
 - Se llena el molde con tierra húmeda
 - Se cierra la tapa
 - Un trabajador baja la palanca con fuerza y prensa la tierra. El volumen de la tierra se reduce a la mitad (la presión es de 10 a 20 Kg/cm²)
 - Terminando la presión, se abre la tapa por sí sola.
 - Se sigue bajando la palanca y sale el bloque del molde.
 - Se pone el bloque con la planchita en la segunda mesa, de donde es llevado al lugar de secado.



Con este sistema se puede producir 120 bloques de 28 x 28 x 9 cm. cada hora. El bloque de tierra pensada es tanduro al salir de la prensa, que se puede agarrar sin problemas. Se pone de canto y se recupera la planchita de triplay para el siguiente bloque.

- o Transporta los bloques hacia el lugar de almacenamiento (1 bloque = 12 Kgr.)

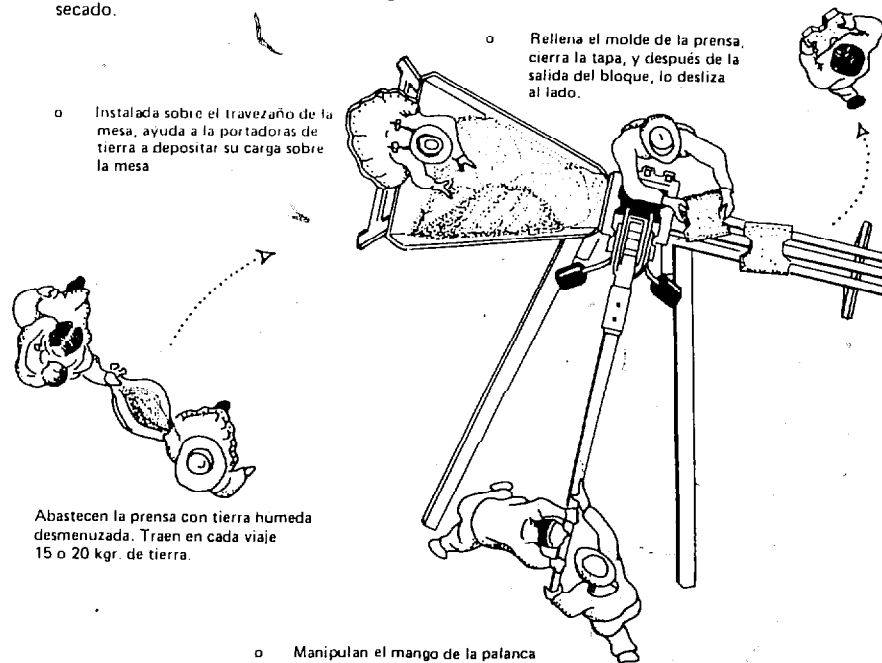

- o Instalada sobre el travezaño de la mesa, ayuda a la portadoras de tierra a depositar su carga sobre la mesa
- o Abastecen la prensa con tierra húmeda desmenuzada. Traen en cada viaje 15 o 20 kgr. de tierra.

- o Manipulan el mango de la palanca para el relleno del molde, la compresión, la abertura de la tapa, y la salida del bloque

(Excerpt from Bibl. 35)

FICHE DESCRIPTIVE DE LA PRESSE « CRATERRE »

CRATERRE Pérou

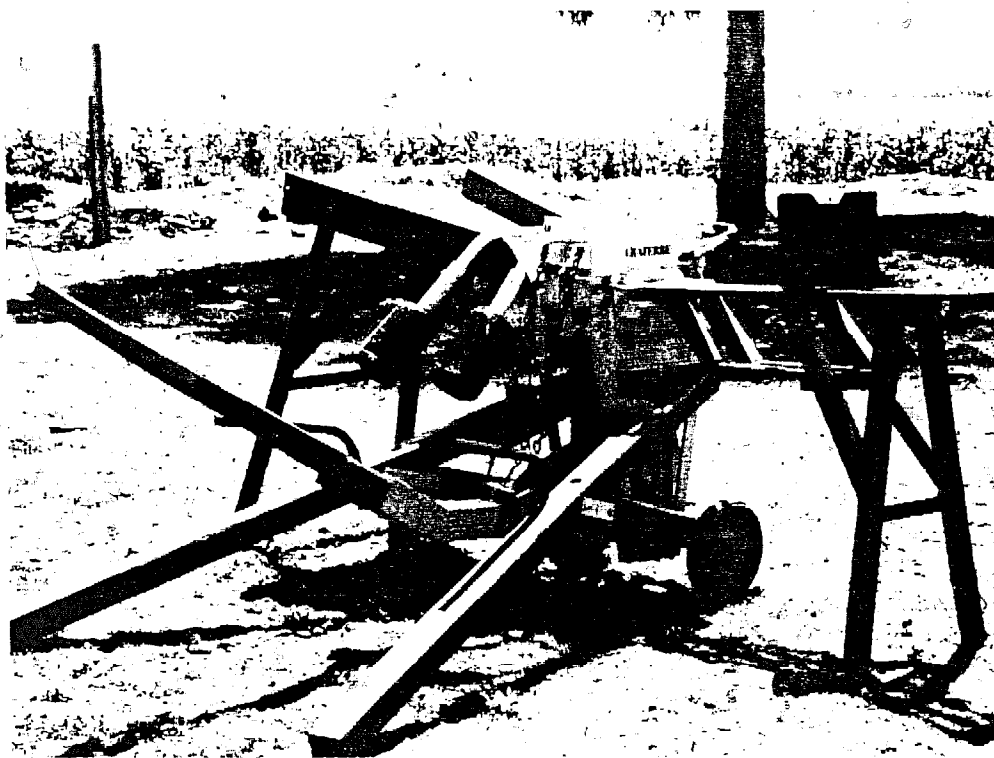

- Presse manuelle à pression statique.

- Moulage, ouverture automatique du couvercle et démoulage obtenu par abaissement du levier d'un mouvement continu et uniforme.

- Dimensions : presse seule : $L = 230$, $l = 163$, $h = 124$. Presse toute équipée : $L = 230$, $l = 280$, $h = 124$.

- Poids : presse seule : 230 kg, presse toute équipée : 280 kg.

- Pression de compactage : 15 à 20 kg/cm^2 .

- Taux de compression : 1,67.

- Profondeur max. du moule : 160 mm.

- Course max. du plat : 70 mm.

- Dimensions des blocs : variables - système de moules interchangeables : 1 bloc de $28 \times 28 \times 8$ cm ; 1

- 1 bloc de $28 \times 28 \times 8$ cm à encoches latérales ; 2 blocs de $28 \times 12,8 \times 8$ cm ; 2 blocs de $28 \times 12,8 \times 8$ cm à encoches latérales.

- Nombre de blocs/heure : 120 blocs de $28 \times 28 \times 8$ cm.

- Volume possible compacté par jour : 4,23 m^3 .

- Nombre de personnes : minimum 2 à 3.

- Entretien : par graisseurs à coupelle.

- Accessoires : 1 table destinée au stockage de 60 kg de terre, 1 table destinée au dégagement des blocs, 10 plaquettes de contreplaqué pour le transport des blocs frais par type de moule.

Cette presse a reçu un brevet d'invention en 1982.

Soil Selection

Not all soil types are suitable for block production however 'Lateritic' soils with a clay content as found in the tropical and semi-tropical regions of the world will generally be acceptable. It is the clay content of a soil that is most susceptible to the action of weathering and which will shrink and swell with the addition of water.

This type of soil may be stabilised by the addition of a suitable agent and where the clay content is less than 30% cement would be satisfactory, for higher clay contents stabilisation with hydrated lime would be more appropriate. The addition of the stabilising agent will aid the compressive strength of the block and improve durability under weathering actions.

Compaction of a stabilised material in the BrePak with a pressure approaching 10 MN/m^2 allows the full advantage of the stabilising agent to be realised.

Mixing

Mixing of the soil should be carried out after the excavated soil has been dried (under the sun), crushed and sieved (5mm) at which time the lime or cement may be added (approx. 6% - 10%). The necessary water is required to 'bind' the mix and aid production and also to work with the stabilising agent, the amount of water is approximately 12% by weight.

In general 0.3 cu. m. of mixed material will be required per hour to keep the press working equivalent to approximately 8-10 Kgs per block.

Final mix proportions and amount required per block is ultimately found by on-site trials in actual working conditions.

Technical Statistics

1. Overall length (excluding lever arm)	790 mm
2. Overall width (excluding ejector ram lever)	510 mm
3. Overall height	760 mm
4. Lever arm extension	1500 mm
5. Press weight	159 Kgs
6. Lever arm weight	11 Kgs
7. Ejector ram lever weight	2 Kgs
8. Effective thrust on mould base plate	44 Tonnes
9. Effective thrust from ejector ram	6.5 Tonnes
10. Effective compaction pressure	10 MN/m^2
11. Average production rate	35/40 blocks/hour
12. Labour force required	5/6 men
13. Standard block size	$29 \times 14 \times 10 \text{ cms}$

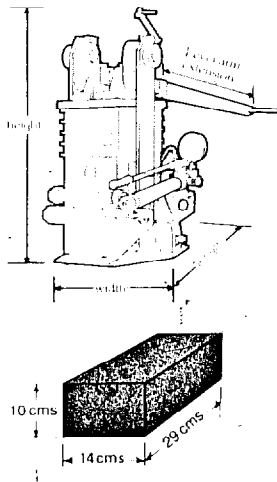

SHIPPING SPECIFICATIONS

Length	840 mm
Width	620 mm
Height	920 mm
Approx weight	180 Kgs

THE MULTIBLOC BREPAK BLOCK PRESS



Producing low cost quality building blocks from stabilised soil.



Simple to operate with minimal maintenance required.



Compact and easy to move from site to site.



Ideal for use in remote areas. No power required.



MULTIBLOC

WELDING INDUSTRIES LTD

Crows Hole Road, off Blackswarth Road, Bristol BS5 8AX
Tel Bristol (0272) 551951. Telegrams: Weldwolv, Bristol. Telex: 34716

MULTIBLOC



MOULDING AROUND THE WORLD

THE MULTIBLOC BREPAK BLOCK PRESS

The Multibloc Brepak machine comprises a moulding area of fixed size which, together with the supporting structural frame, forms an integral unit of an all-steel construction. The complete unit should be mounted to a permanent foundation or may be used on a rigid timber baseboard.

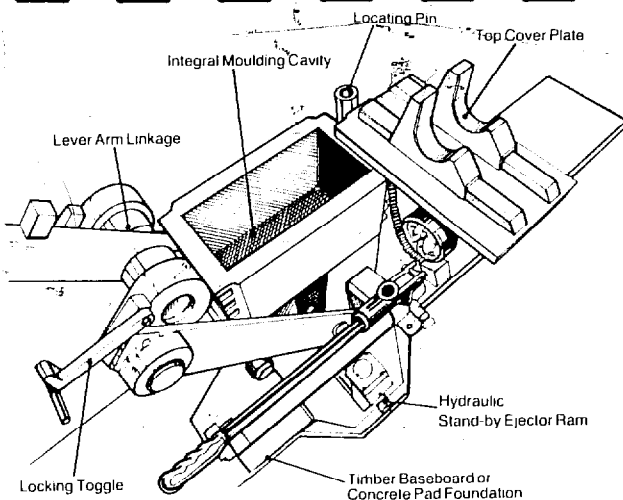

Access to the mould area is via a top cover plate pivoting about a corner mounted locating pin, the cover plate may be moved to one side away from the mould opening. The compact design of the unit allows for ease of installation at site and may be used from site to site when mounted to the timber base.

The machine design and manufacture is specifically in keeping with the requirements for long service life with a minimum of spare parts usage and maintenance making the unit particularly suitable for use in areas where rural development is of primary importance.

The press is fitted with a lever arm extension and mechanical linkage which provides a means of locking the top cover plate onto the mould and also allows for initial compaction of the block material within the mould area.

The Brepak block press was developed by the Overseas Division of the UK Building Research Establishment and is being manufactured under licence granted by this Establishment.

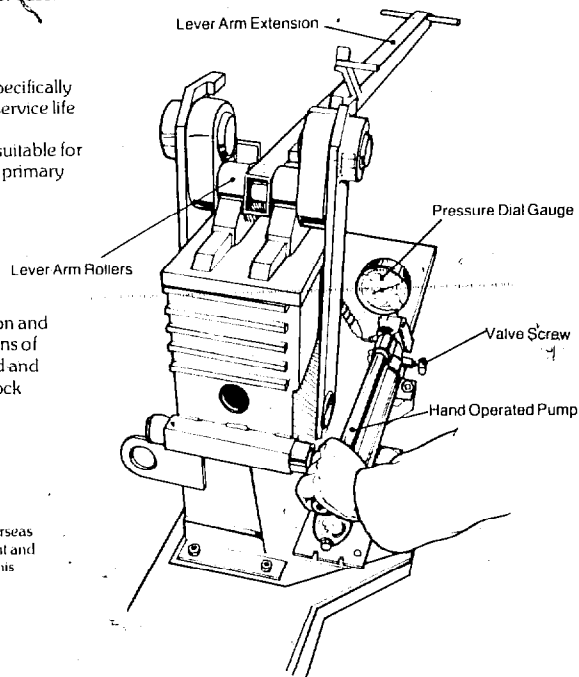

Once the lever arm and cover plate are secured the second stage of block compaction, up to a pressure of 10 MN/m² is applied by use of the hand operated hydraulic pump acting through a piston beneath the base plate of the mould.

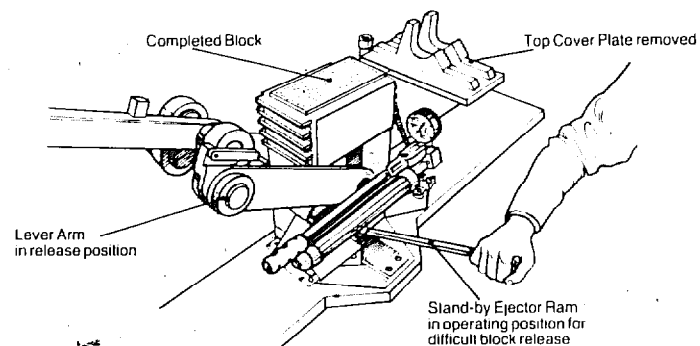

Production Sequence

1. The top cover plate is moved to one side on the locating pivot to gain access to the moulding cavity, it should be ensured that the ejector ram is clear from beneath the base plate of the mould.
2. With the base plate in its lowest position within the mould the screw valve of the hydraulic pump is unscrewed by one turn. The internal surfaces of the mould area should be lightly oiled to aid the release of new blocks.
3. The mould is then manually filled with a measured quantity of the soil mixture and hand pressure is used to ensure complete filling of the mould corners. Once completely filled the top cover plate is moved across the top to its closed position.
4. The lever arm is fitted with a locking toggle which now placed in the locking position, the lever arm assembly may now be raised by approximately 90 degrees until the centre rollers enter the guide locations on the top of the mould cover. At this point the lock toggle is returned to its original position and the lever arm is pulled downward through a further 90 degrees to a horizontal.
5. The screw valve is tightened by hand pressure so that the pump may be manually operated and the mould base plate pushed up into the mould cavity by the piston. The pump is operated until a dial gauge reading of 8,000 lbs./sq. ins. is reached, this ensures complete compaction of the block.
6. By release of the screw valve the hydraulic pressure on the piston is released so that the lever arm may be returned through a full arc back to its original position.
7. The newly pressed block is exposed by sliding the top cover plate to one side and downward pressure on the lever arm will eject the block for removal. If significant resistance is felt the stand-by ejector ram is put beneath the mould base plate and operated until the block is free.

THE MULTIBLOC BREPAK BLOCK CLAMP

When securely gripped between rubber pads this simple, hand-held clamp permits the easy movement and accurate placing of cured blocks.

Block handling around the site and during laying is reduced to a single-handed operation and results in fewer breakage losses with improved productivity.

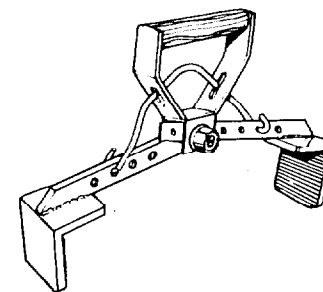

Field Trial

Overseas Development Administration (ODA) supported the first overseas field trial in Kenya of the BREPAK block making machine, the object being to evaluate this new machine under actual site working conditions. A joint research project was started in 1981 between BRE and The Housing Research and Development Unit (HRDU) of the University of Nairobi, Kenya.

The joint BRE/HRDU soil stabilisation research project consisted of three main aspects:

- (i) Scientific laboratory tests to establish the proportions of materials to be used.
- (ii) The on-site field trial preparation of soil mixes and production of stabilised soil blocks using the BREPAK machine.
- (iii) The erection of a 50 m² demonstration structure (eventually to be used as a medical clinic) using the blocks made on-site by village labour.

The medical clinic under construction with stabilized soil blocks



The site selected for this field trial was located at Kabiro village within the Kawangware district of Nairobi and is some 10 km from Nairobi city centre. Its location, near the headquarters of HRDU made it possible for HRDU staff to regularly visit the site and monitor the progress.

The local soil at Kawangware is called Murram and contains about 15% clay. Because hydrated lime is more expensive than cement in Nairobi it was decided to stabilise the Murram soil with 4% cement and good quality blocks were produced.

The first aspect dealt with laboratory tests to identify suitable local soils for stabilisation and to determine the optimum moisture contents for these soils. The most economic proportion of different stabilisers for the various soils was then selected. Sample blocks were tested to obtain wet compressive strengths, resistance to moisture absorption and durability.

The field trial made use of the results of the laboratory tests. These results had to be put in a simplified form for the use of people in the field. The people were able to prepare the soil, measure the required quantities by volume, prepare the mixes by hand and produce blocks on a large scale using the BREPAK block making machine.

The cost of stabilised soil-cement blocks produced by the BREPAK machine compared favourably with conventional concrete blocks of 140 mm thickness. For example, a square metre of walling built with cement stabilised soil blocks resulted in a cost saving of about 46% of the cost of a concrete block wall.

About 3000 stabilised soil-cement blocks produced by the people were used to erect the demonstration structure of over 46 square metre floor area.

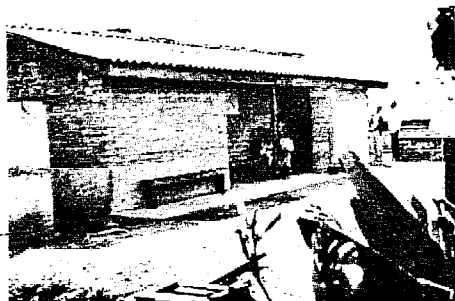

The completed medical clinic at Kabiro

Block Production Sequence with the BREFAK Block Press

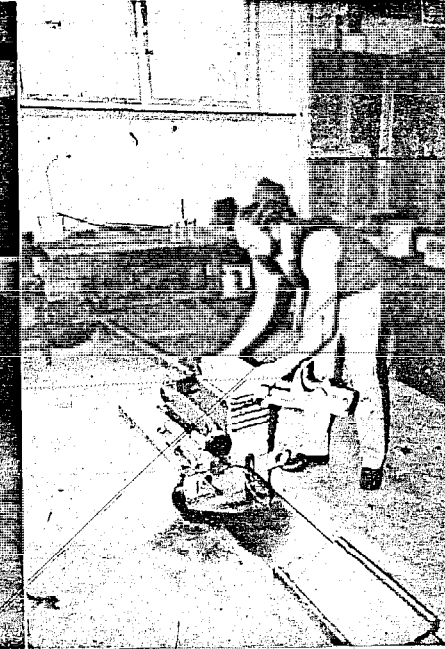
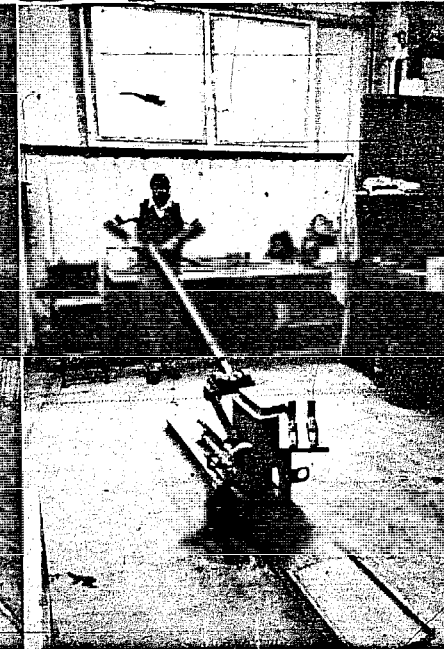
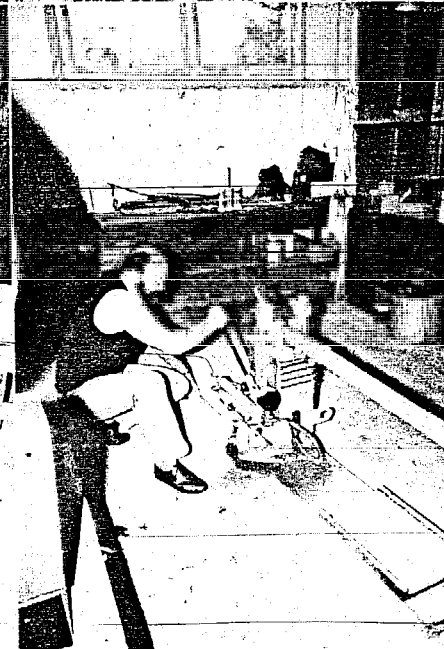

Best of Both Worlds

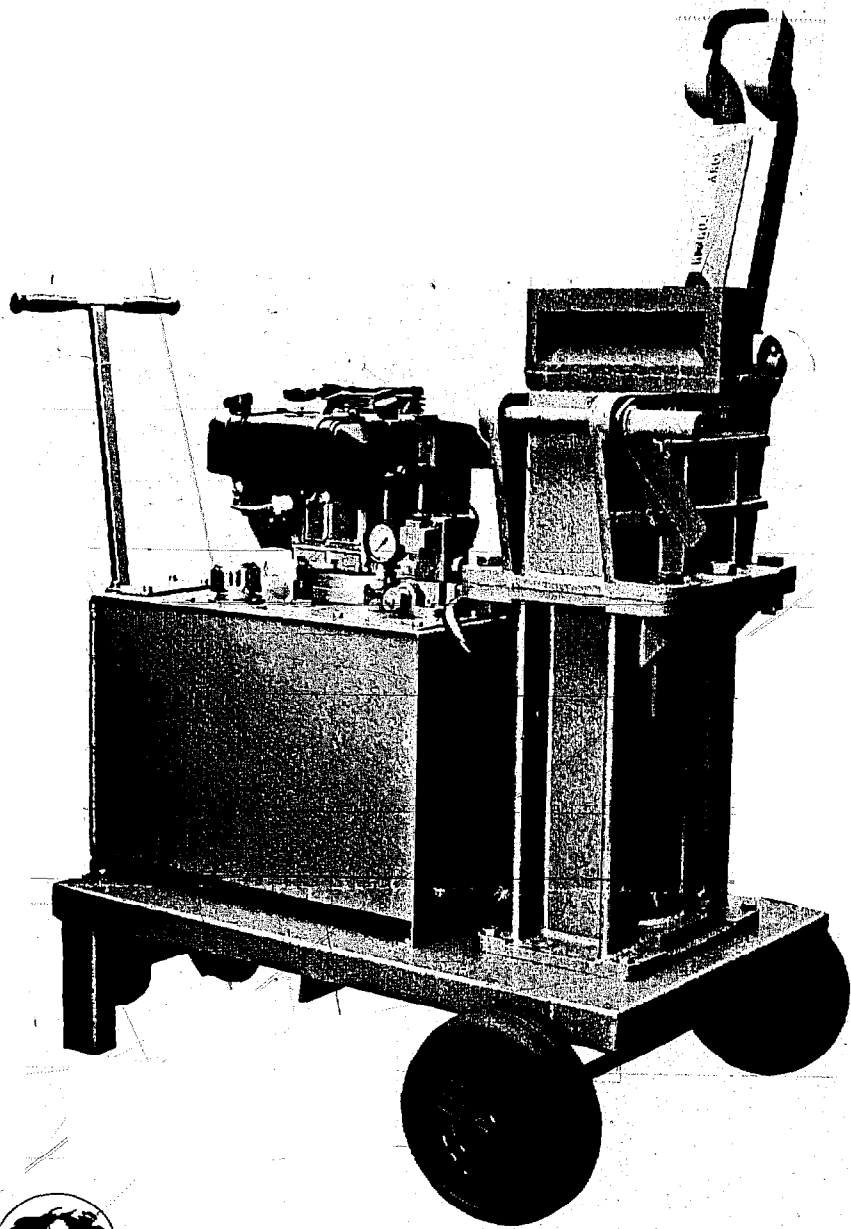

ZORA BRICK MAKING MACHINE

The advanced patented design of the "Zora" brick making machine enables the operator to transform common soil into building bricks in a few seconds.

This readily mobile unit incorporates a unique double hydraulic ram, which provides the very high pressures to form perfect bricks every time.

The simple "Zora" hydraulic brick making machine offered by our company produces durable building bricks and floor tiles from common soil for the construction of a wide variety of low cost housing units and farm buildings. Using this machine eliminates the need for much more conventional building materials such as fire bricks or concrete blocks and avoids the additional cost of transporting them to site. But if the bricks produced on this machine are fired then they would be far superior to ordinary fire bricks, because of their density and could be used for building foundations and pillars, thus eliminating the need for concrete.

The machine can be used by unskilled personnel and is sturdily built to withstand rigorous outdoor operating conditions with little maintenance. It is supplied in three versions—with its hydraulic system powered by an electric motor, a petrol or diesel engine or with a manually operated hydraulic pump. Apart from the source of power all three models are fitted with the same basic components and mounted on identical chassis trolleys for easy movement on site.

One outstanding feature of this machine is the high pressure of 190 bar (2,800 psi) at which bricks are compressed, giving them wet strength of 3.5 MN/m² which exceeds the minimum strength requirement of 2.8 MN/m² for precast concrete blocks specified in B.S. 2028, resulting in a highly compact durable product with hardly any wastage during manufacture due to breakages or malformation. After the spray test, there was no erosion and hence the durability of bricks formed at these pressures appears high. Bricks emerge from the mould box with sharp surfaces ready for plastering or painting if required and unlike concrete blocks can be manually removed immediately after being formed and then stacked for curing without the use of a pallet. They are ready for use after curing period of about eight days and continue to cure and gain full strength for a further three weeks.

The standard mould box provided with each machine produces blocks measuring 290mm long x 140mm wide x 100mm deep or tiles of the same length and width but with a varying depth. For example, three tiles each 30mm deep can be made at one time, using two 5mm thick separating boards in the mould box. Semi-hollow bricks are formed by a detachable wedge shaped form (frog plate) located on the top plate of the mould box.

With a powered machine, normal operating speeds of up to 180 bricks or 450 tiles (each 30mm thick) per hour are achievable with two operators, one to fill the press mould box with earth, the other to handle the hydraulic control. These rates are approx 80% less, when using the manually operated machine.

Not all soils are suitable for brick production, however, common "LATERITIC" soils with a clay content as found in most parts of the world will generally be acceptable. However, the clay content in the soil which is most susceptible to the action of weathering and which will shrink and swell with the addition of water. This type of soil may be stabilised by the addition of a suitable agent, and where the clay content is less than 30%, 5% of cement would be satisfactory. For higher clay contents 5%-10% of hydrated lime would be more appropriate. These additions of stabilising agents will aid the compressive strength of the brick and improve durability under weathering actions.

The amount of moisture in the earth is one of the most important considerations and should be 12%-15% by weight. A simple test to determine the correct amount of moisture is to squeeze a ball of the soil mix in your hand, if the ball can be broken in two without crumbling and without leaving any water on your hand, the moisture content is correct. Should the mix be too dry, small amounts of water should be added and

evenly and thoroughly will ensure the right consistency. As with most disciplines "practice makes perfect" and it has been found that just as an operator's speed increases as he gains experience of the machine, so does his understanding of how to mix the earth (if this is indeed necessary) to achieve the best results.

Operating the machine is very simple, the exact quantity of moist soil required to make one brick is sieved and loaded into the machine's mould box with a scoop. The hinged mould box lid is then closed and locked with a pin and a hydraulic control lever pushed forward, causing an internal plunger to rise and compress the mix against the mould box lid to form the brick. Pressure is released by pulling the lever back, after which the mould box can be opened. To eject the block from the mould box the plunger is raised to the limit of its travel, enabling the block to be lifted off and placed in the curing area. To form the next block the plunger is lowered to the bottom of its stroke and the cycle repeated. The procedure is the same for the power models and the manually operated model, except that in the latter case the pressure is produced by a manual pumping action.

The idea of a press for making pure soil blocks has been around for a long time but we believe that the "Zora" press has been developed to a stage far in advance of any other machine currently on the market. Under most climate and soil conditions pure soil blocks are sufficiently strong to be used for erecting single storey buildings of any type. However, with concrete foundations, multi-storey buildings can also be built but such structures require, in addition, supporting pillars and concrete staircases. It is estimated that with proper drainage and, if necessary, surface protection against erosion, abrasion and moisture absorption, buildings made of pure soil blocks should have a life expectancy of over fifty years.

The package offered by Zora Co. Ltd. includes the basic press and either the manual hydraulic pump, petrol engine, diesel engine or electric motor. Also included in the package is a sieve with appropriate mesh size and a scoop which, when full, contains the exact quantity of moist soil required to produce the same size brick every time.

As the brick forming chamber is detachable it may be possible to provide additional chambers yielding different size/shape bricks in the future. As all the presses are standard they may all be powered electrically, manually or by the petrol engine and therefore we can supply whichever power units are not specified in your main order as an optional extra. The manual pump may be attached to a power press without detaching the power unit and as the fitting for both the petrol engine and the electric motor is the same, these are easily interchanged by replacing one with the other.

The machine is covered by the manufacturer's standard twelve months guarantee and is shipped in a suitable export packing. Research into improvements is constantly in progress and we reserve the right to up-grade the performance of this machine.

Shipping Specification	
Length	1000mm
Width	800mm
Height	1150mm
Nett Weight	350kg
Gross Weight	400kg

The brick making machine is the subject of worldwide patent protection. ZORA is a trade mark of Zora Company Limited. All rights reserved © Zora Company Limited 1988.



ZORA COMPANY LTD.

112 Tower Road, London W4 5PY

Telephones: 01-994 8568
01-994 8569
01-994 8560
Telex: 048 E G
Ref: 5489

Block Production Sequence with the ZORA Brickmaking Machine

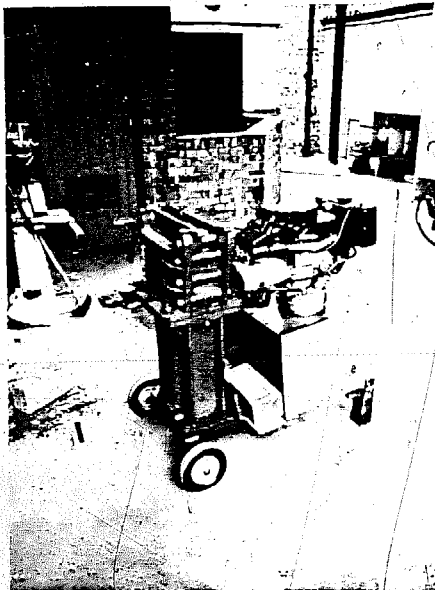

The ZORA Machine



Winding the starter rope



Starting the engine

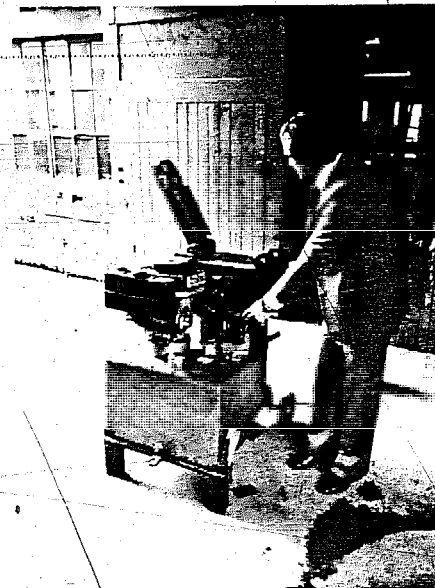

Lowering the piston



Filling the mould



Compressing the block

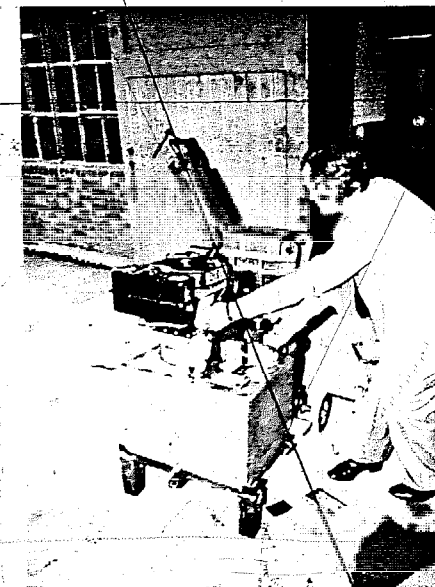

Ejecting the block



Impact test by throwing



Some finished interlocking blocks

PRESSE

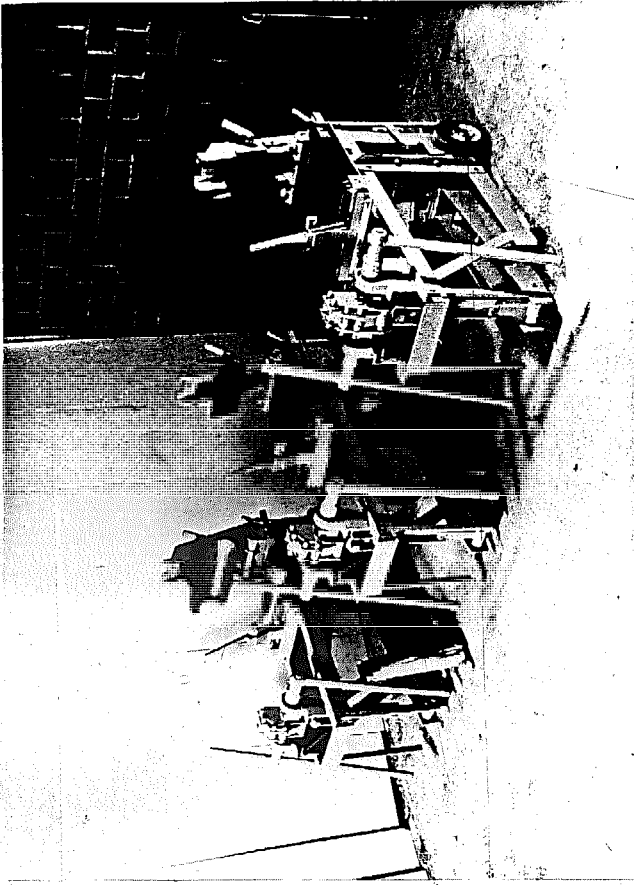
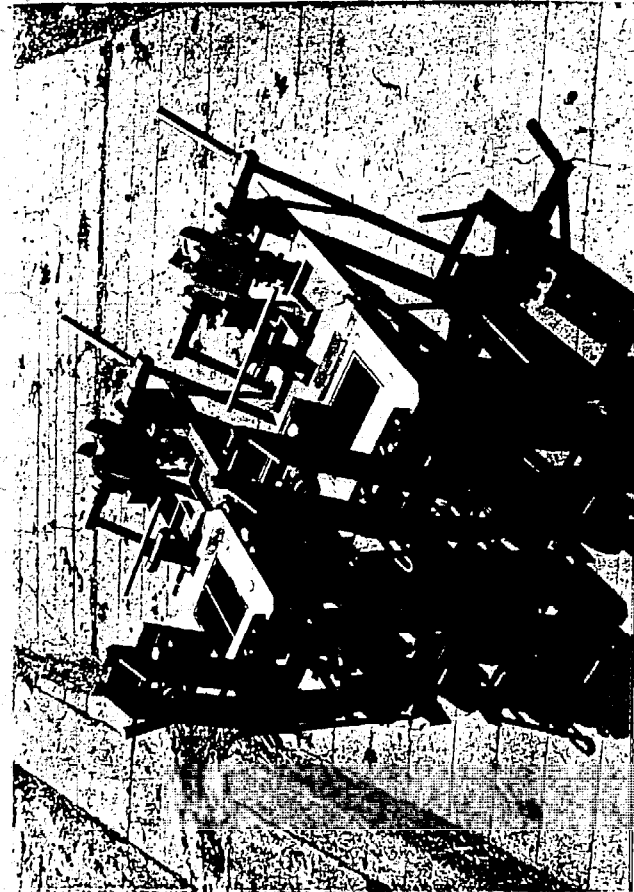

TERSTARAM

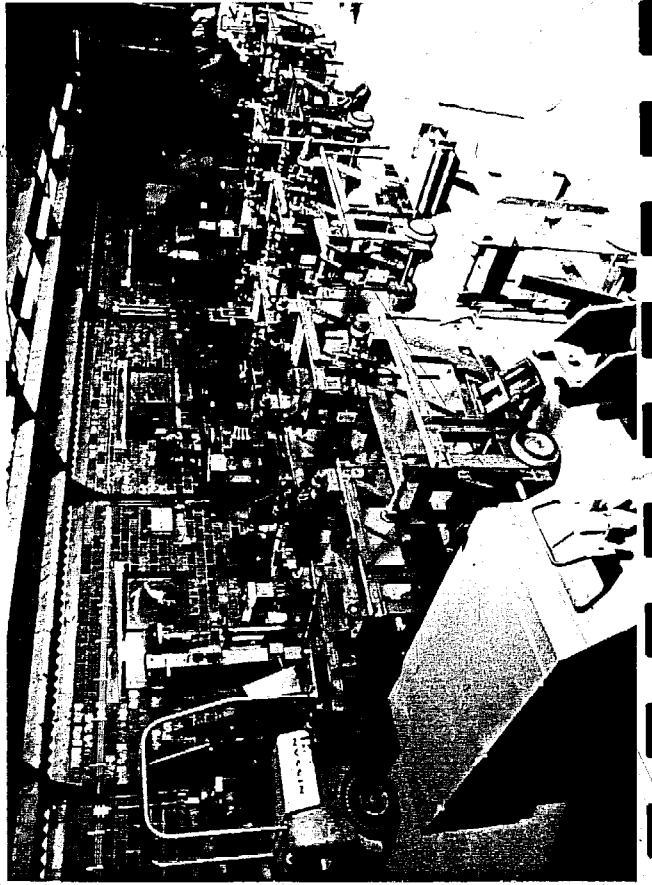

PRESSE TERSTARAM

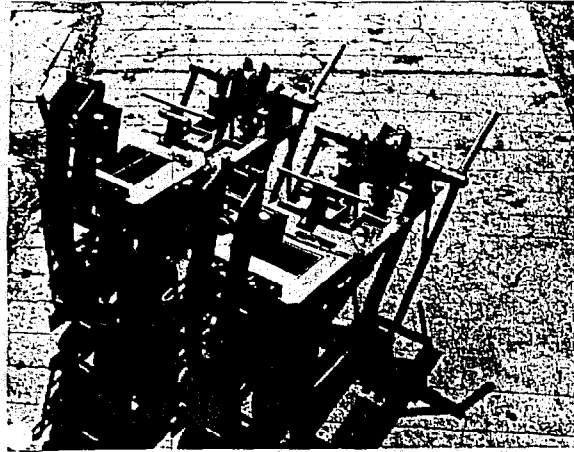

Machine manuelle pour le moulage de terre par compression.

Idéale pour la fabrication de briques en terre stabilisée et pour le moulage des briques de terre cuite.

Elle accepte des moules aux dimensions du client avec un maximum de 295 x 295 mm.

Le changement de moule se fait en 15 minutes.

Sa conception et sa robustesse a été étudiée spécialement pour les pays tropicaux.

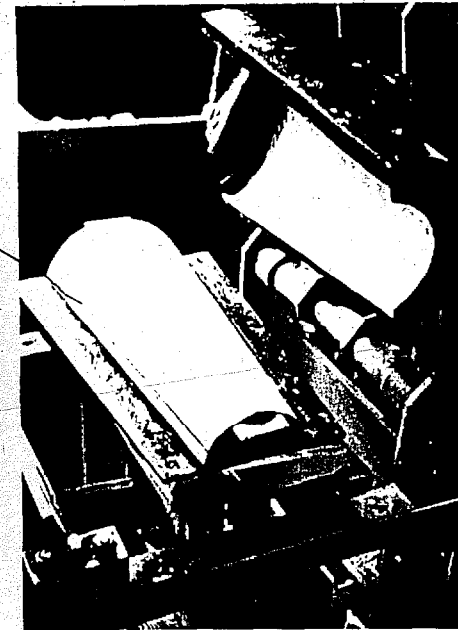
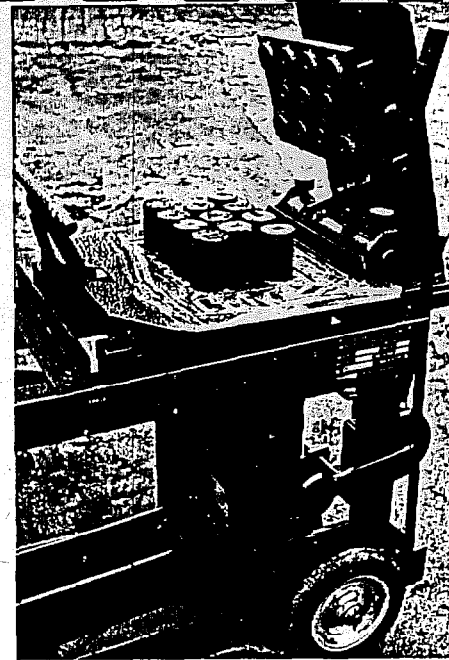

Fernand PLATBROOD

ETUDE ET CONSTRUCTION DE MACHINES POUR LA FABRICATION DES PRODUITS EN TERRE STABILISÉE

CARACTERISTIQUES TECHNIQUES :

Course fixe du piston inférieur : 38 mm.
Rabattement du couvercle dans le moule : 15 mm.

Réglage de l'épaisseur du produit par des cales de différentes dimensions livrées avec la machine.

Poussée théorique maximum : 20 tonnes

Production journalière :

800 blocs de 295 x 140 mm.
1600 briques de 220 x 110 mm.
(2 briques à chaque opération)



PLATBROOD
20 RUE DE LA RIEZE
B 6404 CUL-DES-SARTS — COUVIN
BELGIQUE

MOULE A 11 BRIQUETTES DE
COMBUSTIBLE

MOULE A TUILE ROMAINE



UTILISATION
DE LA PRESSE
TERSTARAM.



Other brickmaking machines and equipment:

CERAMASTER integrated and autonomous production unit for the production of (stabilised) hollow blocks consisting of a grid-mill, a double shaft mixer and a hydraulic press with rotating table.

CERAMATIC high production mechanical or hydraulic press consisting of a 3-station rotary table powered by electrical or thermal motor.

CERAMEX cost effective vertical extrusion unit (without vacuum) for quantity production of bricks. (water-lubricated wooden die)

CERADES impact disintegrator consisting of two counterrotating hollow drums driven by two electrical motors, specially developed for use with CERAMAN and CERAMATIC presses.

CERAMAX double or single shaft mixers, horizontal or vertical.

CERAMILL grid-mill for the grinding of dry clay.

CERACUT multi-wire manual or electrical cutter.

RGS 200 firing equipment for solid fuels on Hoffmann or tunnel kilns.

and more in general all machines for the production of bricks from the simple to the most automated installations.

CERATEC presents not only machinery but also a complete range of services to its customers.

We take care of the complete engineering and lay-out of your brickmaking plant.

The year long know how of our staff in operating brick plants and in developing brickmaking machines can be used to your advantage in developing and implementing your complete brick plant.

On demand our services perform-qualified expertise and engineering for existing or planned brickmaking projects.

CERATEC also frequently organises complete training courses in brickmaking for future production and maintenance personnel.

Aerial view of the main site of the Phlegreest Brickworks and its division CERAMATIC.



CERATEC

rue de l'Industrie, 228
B-7703 PLOEGSTERT Belgium
tel. 00732 56 58 8033 (6 l.)
telex: 57834 PLOEGER B

our dealer:



Brickmaking machines

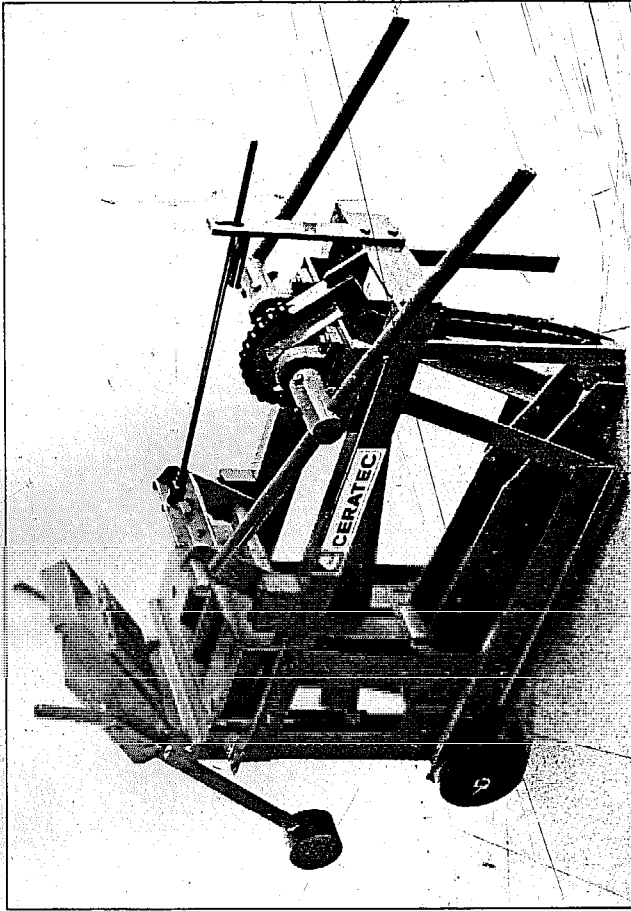

CERAMAN

Manual press



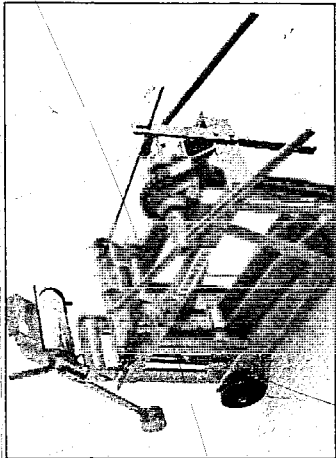
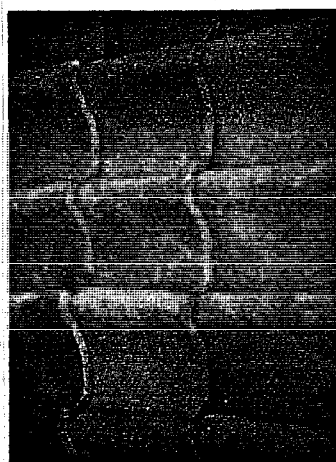
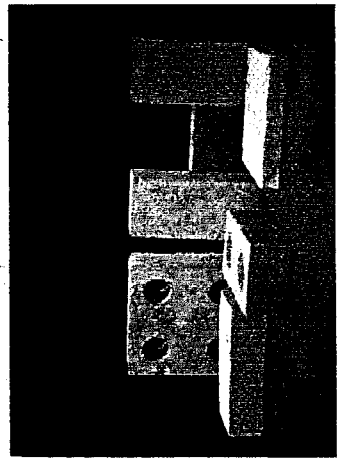
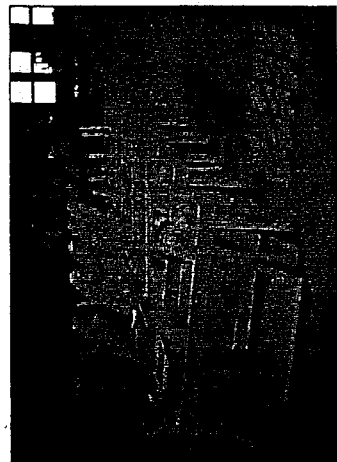

1	2
3	4

1. Quantity production at our factory in Ploegsteert, Belgium.
2. A sample of plain and perforated bricks made by the CERAMAN press.
3. Flemish tiles produced by the CERAMAN.
4. A CERAMAN press fired with a tile mould.

the CERAMAN

The reliable and versatile low cost brickmaking machine you need.

The CERAMAN is a truly low cost press operated by two persons. Its main characteristics are its robustness and reliability, its extreme simplicity in use, its efficient performance and its polyvalence. By just changing moulds (a few minutes work), you can produce either plain or perforated bricks (of practically all sizes), paving tiles of every wanted design and even roofing tiles.

The CERAMAN press is one of the most widespread hand-operated mechanical presses. Brick producing with the CERAMAN requires no special skills: the clay, which is put in the mould by a shovel, is precompacted by closing the cover. Bricks are pressed and automatically ejected by using the two levers. The production method used is "dry" or "cold" pressing. The CERAMAN can produce either clay bricks to be fired or compressed earth blocks stabilised with cement or another binder (information on request).

the CERAMAN exists in two versions:

Type S and Type H. Type S can produce bricks with a height up to 70 mm.

Type H permits, through only a minor adjustment, to produce either products with a maximal height of 70 mm or a maximal height of 90 mm. (See table)

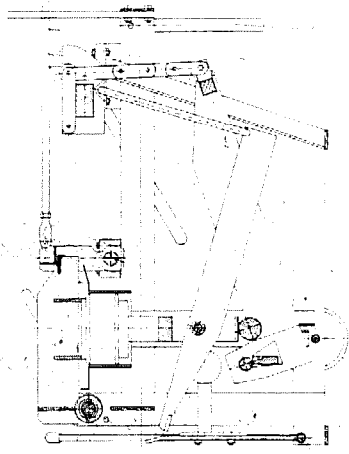

Technical data sheet:

Type	S	H
Stroke length of the piston	37	37 or 45
Maximum filling height of the mould	112	112 or 110
Height of finished products	20-70	20-70 or 20-90
Maximum nominal compaction force	10000	10000 or 8500
Nominal compaction pressure (standard sized bricks 220 x 107)	21	21 or 18
Hourly production (standard sized bricks 220 x 107)	300-400	300-400
Number of operators	2	2
Net weight (without mould)	330	330
Net weight of a standard sized double brick mould	21	21
Size	140 x 50 x 100	140 x 50 x 100

the CERAMAN

A large choice of moulds:

The CERAMAN can be delivered with a large variety of moulds:
 - brick moulds: can either be a double brick or a simple brick mould, can be ordered for plain, lightened or perforated bricks.
 - These moulds can be covered with an elastic layer to permit an easy unloading.

- roofing tiles: 3 types are available: roman, marseille and flemish tiles.
 - paving tiles: rectangular, square or any other design on request.
 - Most of these moulds are held in stock. Each mould can also be delivered with the mark of your firm on it!



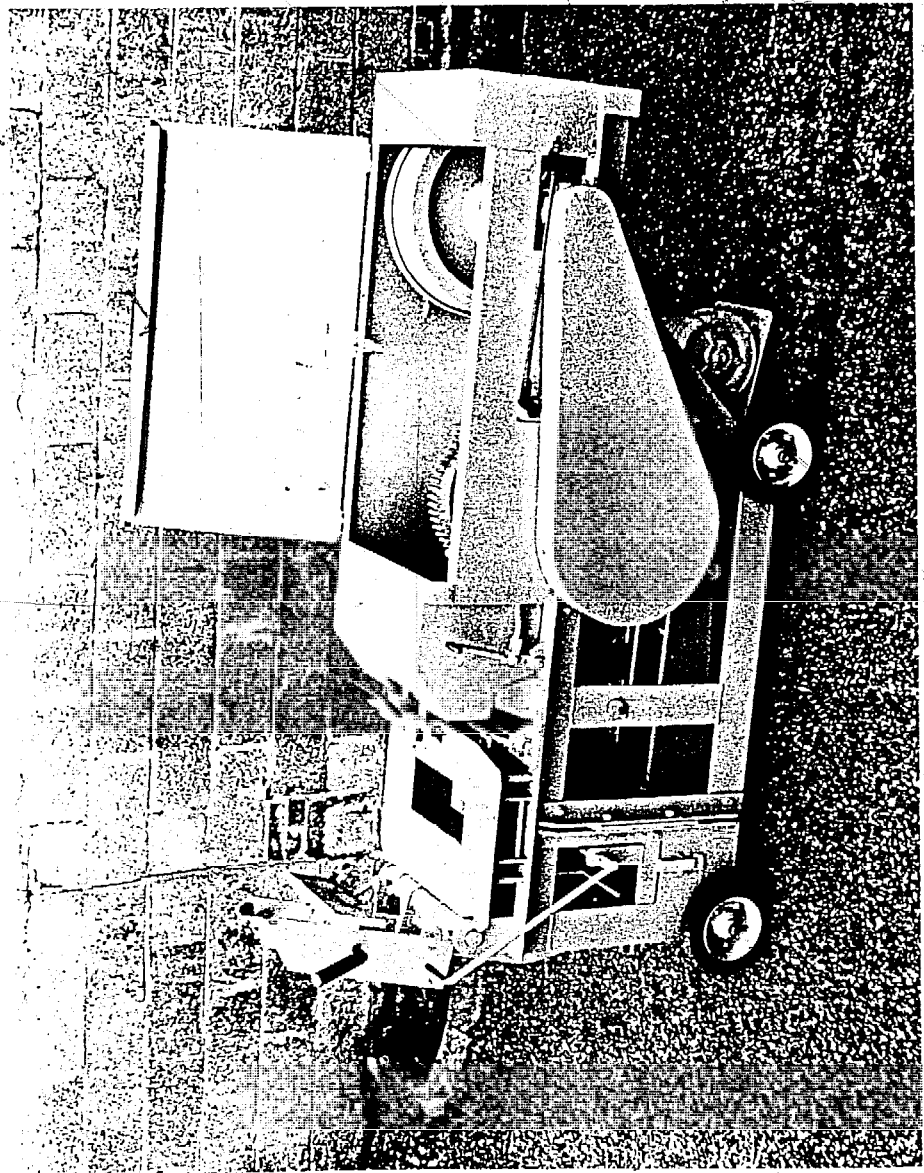

PRESSE SEMI-AUTOMATIQUE

VERSION MOTEUR ELECTRIQUE
 SYSTEME BREVETE
 PATENT PENDING

PLATBROOD - BERGER
 20 RUE DE LA RIEZE
 B6404 CUL-DES-SARTS - COUVIN
 BELGIQUE

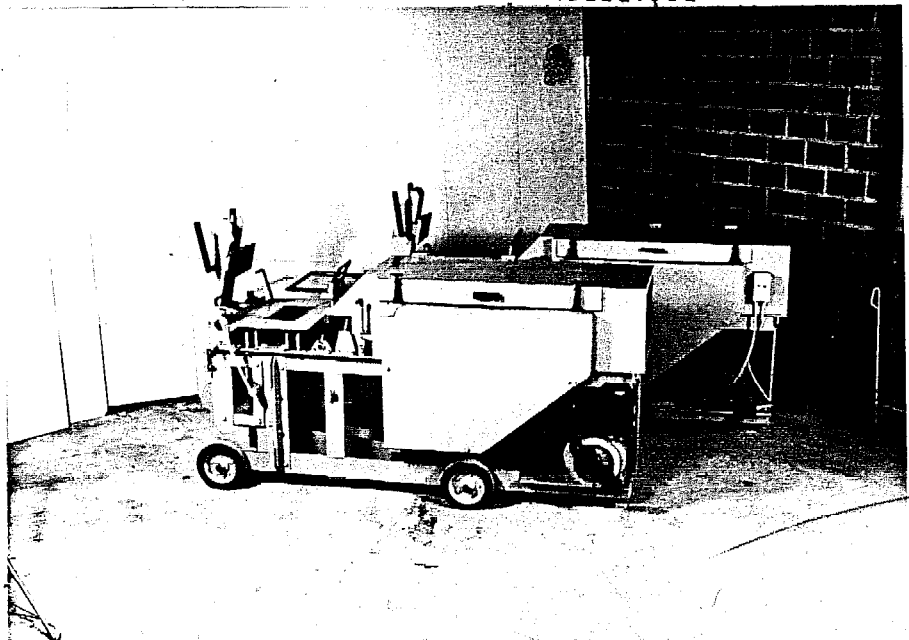

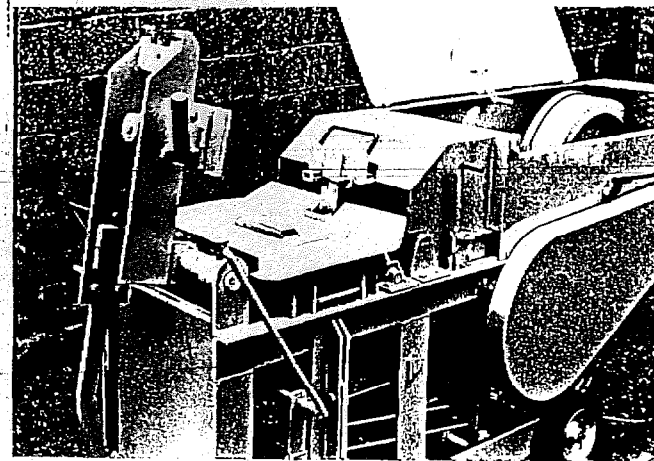

Cette presse accepte les moules dont les dimensions ne dépassent pas 40 x 30 cm (moules identiques à la Terstaram manuelle)

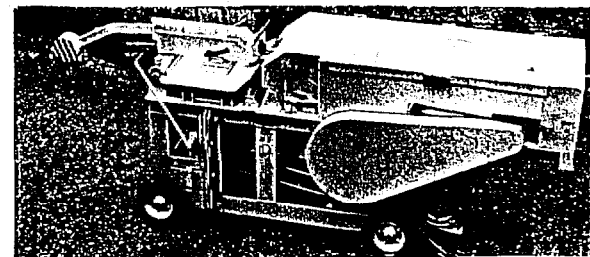

La production journalière est de 5.000 briques de 22 x 10,5 x 6 cm (2 briques à la fois) ou 2.500 blocs de 29,5 x 14 x 9 cm.

Version moteur essence ou diesel sur demande.

Caisse maritime de 2,22 m x 0,70 m x 1,14 m de hauteur.

Poids M : 765 Kgs

Poids B : 925 Kgs.

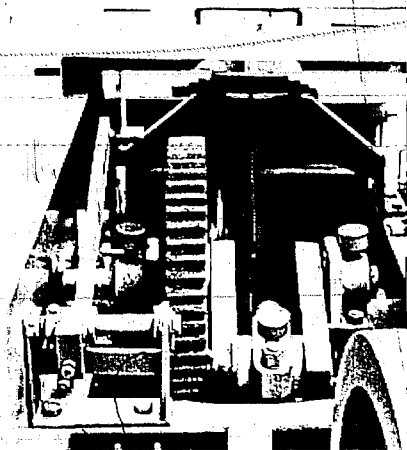

La construction et la conception permet une utilisation de main-d'oeuvre peu qualifiée et d'entretien aisé par des artisans locaux peu outillés.

Ce matériel répond à un usage intensif, à une utilisation maladroite, aux contraintes climatiques (chaleur, humidité et vents de sable)

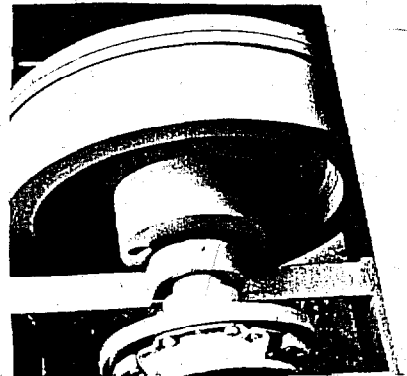

Le volant d'inertie permet d'obtenir une poussée de 20 tonnes avec seulement 1 moteur électrique de 1,5 Ch.

La régulation et la commande de la presse sont obtenues par un embrayage de voiture Renault sur-dimensionné.

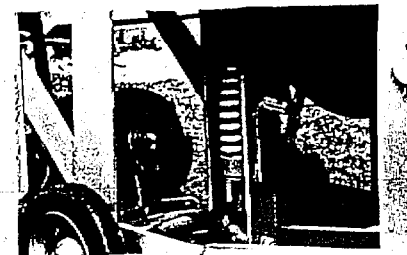

Un ressort puissant dans le système de poussée évite les accidents suivants : trop de terre
corps durs dans la terre.



Other brickmaking machines and equipment:

CERAMASTER integrated and autonomous production unit for the production of (stabilised) hollow blocks consisting of a grid-mill, a double shaft mixer and a hydraulic press with rotating table.

CERAMAN versatile, low cost manual brick press for the production of plain or perforated bricks, paving tiles and roofing tiles.

CERAMEX cost effective vertical extrusion unit (without vacuum) for quantity production of bricks. (water-lubricated wooden die)

CERADES impact disintegrator consisting of two counterrotating hollow drums driven by two electrical motors, specially developed for use with CERAMAN and CERAMATIC presses.

CERAMAX double or single shaft mixers, horizontal or vertical.

CERAMILL grid-mill for the grinding of dry clay.

CERACUT multi-wire manual or electrical cutter.

RGS 200 firing equipment for solid fuels on Hoffman or tunnel kilns.

and more in general all machines for the production of bricks from the simple to the most automated installations.

CERATEC

presents not only machinery but also a complete range of services to its customers.

We take care of the complete engineering and lay-out of your brickmaking plant. The year long know-how of our staff in operating brick plants and in developing brickmaking machines can be used to your advantage in developing and implementing your complete brick plant.

On demand our services perform qualified expertise and engineering for existing or planned brickmaking projects. CERATEC also frequently organises complete training courses in brickmaking for future production and maintenance personnel.

Aerial view of the plant site of the Ploegsteert Brickworks and its division CERATEC.

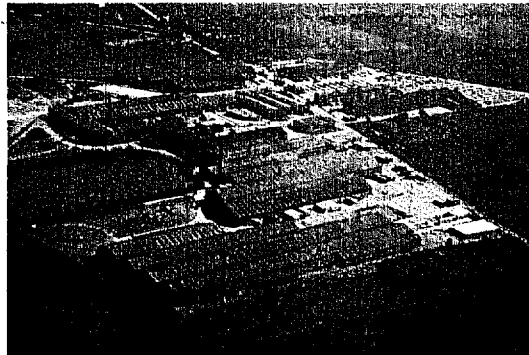

CERATEC

ru de Touquet, 228
B-7293 PLOEGSTERT Belgium
tel. 0032-50-588643 (6-1)
telex: 57853 PLOCEB

our dealer



Brickmaking machines

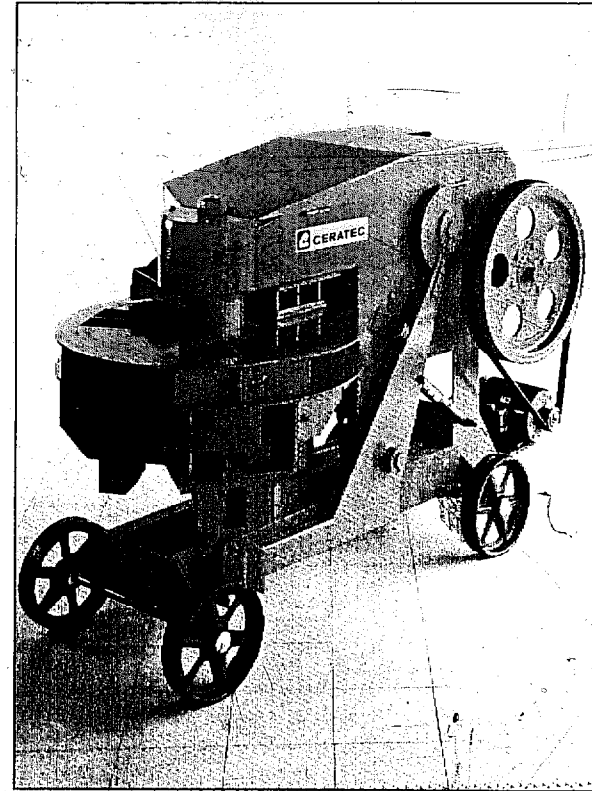

CERAMATIC

Automatic brick press



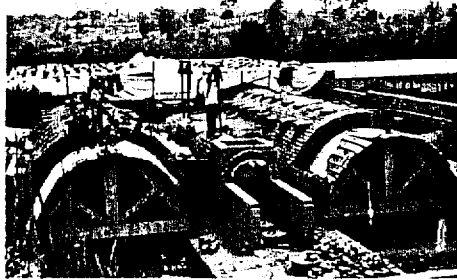
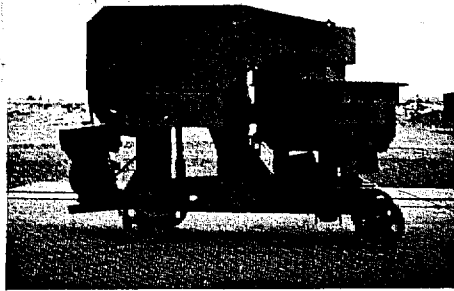
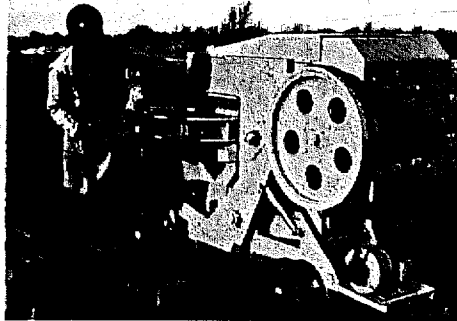

the CERAMATIC

The renowned automatic brick press with the rotating 3-station table

The CERAMATIC is an all-mechanical automatic brick press with a favourable production to total cost ratio.

Its main characteristics are its robustness and reliability, its simplicity in use, its efficient and autonomous performance and its mobility.

The CERAMATIC has an automatic rotating 3-station table: a filling station, a moulding station and a de-moulding or ejection station.

the CERAMATIC

A movable and autonomous production unit

The CERAMATIC is originally fitted with four wheels so that it can easily be moved on the clay site or the production yard.

1. CERAMATIC press in use.
2. CERAMATIC press powered by a petrol engine.
3. Construction of a Hoffmann kiln made possible by CERAMATIC bricks.

Motor power is used for the automatic pressing and ejecting of the bricks and for the rotation of the table.

Bricks are produced on a continuous basis. Through "dry pressing" of the raw material: a simple and appropriate technology for the production of quality bricks.

The CERAMATIC can produce either clay bricks to be fired in a kiln or compressed earth blocks stabilised with cement or another binder.

The CERAMATIC requires no installation costs and is immediately ready for production.

It can be made autonomous through the use of the small petrol or diesel engine. The engines are easily removable.

the CERAMATIC

exists in three versions:

Type ME: powered by an electrical motor of 4 h. p. (1500 rev./min. voltage on choice).

Type MD: powered by a diesel engine of 5 h. p. (1500 rev./min. - average consumption of 0,6 liter/hour).

Type MP: powered by a petrol engine of 5 h. p. (1500 rev./min. - average consumption of 0,8 liter/hour).

With the CERAMATIC type M, bricks are pressed at high compaction pressures through a mechanical lever system.

The production level is imposed mechanically, but can be determined in advance through the choice of a larger or smaller fly-wheel.

There exists also a hydraulic version of the standard CERAMATIC press, namely type H, especially developed for the production of bricks of greater heights at even higher compaction pressures.

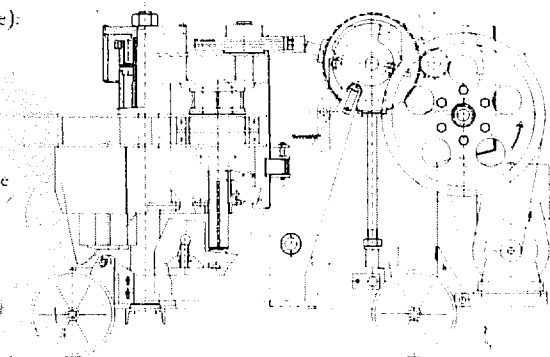

Technical data sheet

Type		M
Nominal compression force	kg	up to 30.000
Nominal compaction pressure (standard sized bricks)	kg/cm ²	up to 65
Stroke length of piston		adjustable
Maximum stroke length of piston	mm	60
Maximum filling height of mould	mm	130
Maximum height of bricks	mm	70
Compression ratio (product of 70 mm)		1,86
Hourly production rate (depending on fly-wheel and engine)	bricks/hour	1.400 - 2.000
Standard size of bricks	mm	220 × 107 × 70
Number of operators		2
Net weight without motor	kg	1.650
Size (l × b × h)	cm	200 × 100 × 140

the CERAMATIC

Simplicity in use and robustness for a guaranteed production of quality bricks.

Brick producing with the CERAMATIC is easy and requires only two unskilled operators: one to fill the moulds and one to take the pressed bricks from the table and put them on a wheelbarrow.

The clay, which is put in the moulds with a shovel (filling station), is first automatically precompacted by a cone-shaped roll, then bricks are mechanically pressed (moulding station) and automatically ejected (de-moulding station).

In order to make the CERAMATIC a reliable production machine, all mechanical parts have been largely dimensioned, a number of securities have been provided for and all transmission gear has been concentrated

in a closed casing. Each CERAMATIC press is supplied with a set of first necessity tools and small spare parts.



Lescha

Erdziegelmaschine

TECHNISCHE INFORMATION *Sept 87*

Die neue Erdziegelmaschine LESCHA SBM bietet moderne Problemlösungen zur Herstellung von hochwertigen Mauersteinen aus Erden (Lehm, Laterit) ohne oder mit stabilisierenden Zusatzmitteln.

Drei spezielle Vorteile bestimmen die hohe Qualität der Lehmsteine:

1. Beste Aufbereitung, d.h. Zerkleinern und Sieben des Rohlehm durch separaten motorgetriebenen Catapulter.
2. Intensive Mischung des Lehm mit Zugabewasser und Zusatzstoffen im Spezialzwangsmischer.
3. Beste Verdichtung, Kantenstabilität und Festigkeit der Lehmsteine durch hohen hydraulischen Preßdruck.

Dadurch ist die LESCHA SBM universell und wirtschaftlich einsetzbar. Ein breites Spektrum von Erden - tonreich bis sandreich - kann mit allen zur Stabilisierung geeigneten Zusatzmitteln verarbeitet werden und ergibt in jedem Falle Steine von bestmöglicher Qualität. Die Druckfestigkeit kann durch Zementzugabe gesteuert werden. Dadurch sind auch hohe Werte für den mehrgeschossigen Hochbau erreichbar. So wurde zum Beispiel mit nur 3 % Zement auf des Lehmgewicht eine Druckfestigkeit nach 28 Tagen von

8 N/mm² nach DIN, entsprechend 8 MPa oder 1160 psi nach ASTM erreicht. Durch den Zusatz von nur 1 % des Additivs LESCHA FL 1 würde nach dreitägiger voller Wasserlagerung, was in der Baupraxis kaum vorkommt, an diesen Steinen noch eine Festigkeit von 3 N/mm² gemessen.

Die Wirtschaftlichkeit der Maschine ergibt sich aus der möglichen Einsparung von Zusatzstoffen, durch deren hochgradig homogene Einnischung und die hohe Verdichtung. Qualität und Preise der Lehmsteine werden in erster Linie durch die Qualität der Maschine bestimmt.

Besonders wirtschaftlich ist auch, daß die Maschine sowohl stationär in einem Fabrikationsbetrieb als auch mobil an ständig wechselnden Baustellen eingesetzt werden kann. Die mögliche Leistung von bis zu 700 Steinen pro Stunde mit 4 Arbeitern ist ebenfalls außerordentlich kostengünstig.

Der Preis der LESCHA SBM wird bei ca. DM 60.000,-,- liegen.

Um sehr gute Wasserstabilität der Lehmsteine - selbst bei niedrigerem Zementein-
satz - zu erreichen, wird ein Zusatz von LESCHA FL 1 empfohlen. Eine günstige
Dosierung für Lehme mit mittlerem Tongehalt ist zum Beispiel 3 % Zement und
1 % FL 1, jeweils vom Lehmgewicht. FL 1 ist stark wasserabweisend, mindert
jedoch weder Festigkeit noch Austrocknung oder Atmungs-fähigkeit der Wand und
ist beständig gegen UV-Licht und mikrobielle Zersetzung. FL 1 sollte in Verbin-
dung mit Zement oder Kalk verwendet werden.

Die Kosten für einen Erdziegel der Größe 25 x 13 x 7,5 cm können wie folgt
kalkuliert werden:

Zement DM 120,-/to	pro Stein	DM 0,02
LESCHA FL 1 DM 350,-/to	pro Stein	DM 0,02
Kraftstoffverbrauch 9 l/h	pro Stein	DM 0,02
Lohnkosten bei 700 Steinen pro Stunde, 4 Arbeitern und DM 22,- Lohn- kosten pro Stunde		DM 0,12
Abschreibung der Maschine auf 4 Jahre bei 5600 Steinen pro Tag und 250 Arbeitstagen/Jahr		DM 0,01
Gesamtkosten pro Stein		DM 0,19
Dagegen kostet:		
1 gebrannter Ziegelstein		DM 0,50
1 Zementstein (Beton)		DM 0,70

Technische Daten

Die Maschine besteht aus

- (1) Kipptrogzwangsmischer
- (2) Materialaufzug für Lehm
- (3) Materialvorratsbehälter
- (4) Steinpresse mit Drehtisch
- (5) Motorgehäuse

Steinformat:	25 x 13 x 7,5 cm, zwei Steine pro Pressung
Leistung:	Bis 700 Steine pro Stunde bei 4 Arbeitern
Mischer:	Hydraulischer Preßstempel mit 110 to Maximalpreßdruck auf 2 Steine
Motor:	3 Zylinder-Viertakt-Dieselmotor "Deutz", mit 40 kW (54 PS) Leistung
Fahrwerk:	ungefedert bis zu 40 km/h, auf Wunsch mit Federachse und 80 km/h

LESCHA MASCHINENFABRIK GMBH
Postfach 10 25 40, D 8900 Augsburg 1, Tel. (0821) 40 82 00, telex 53 860 lescha d

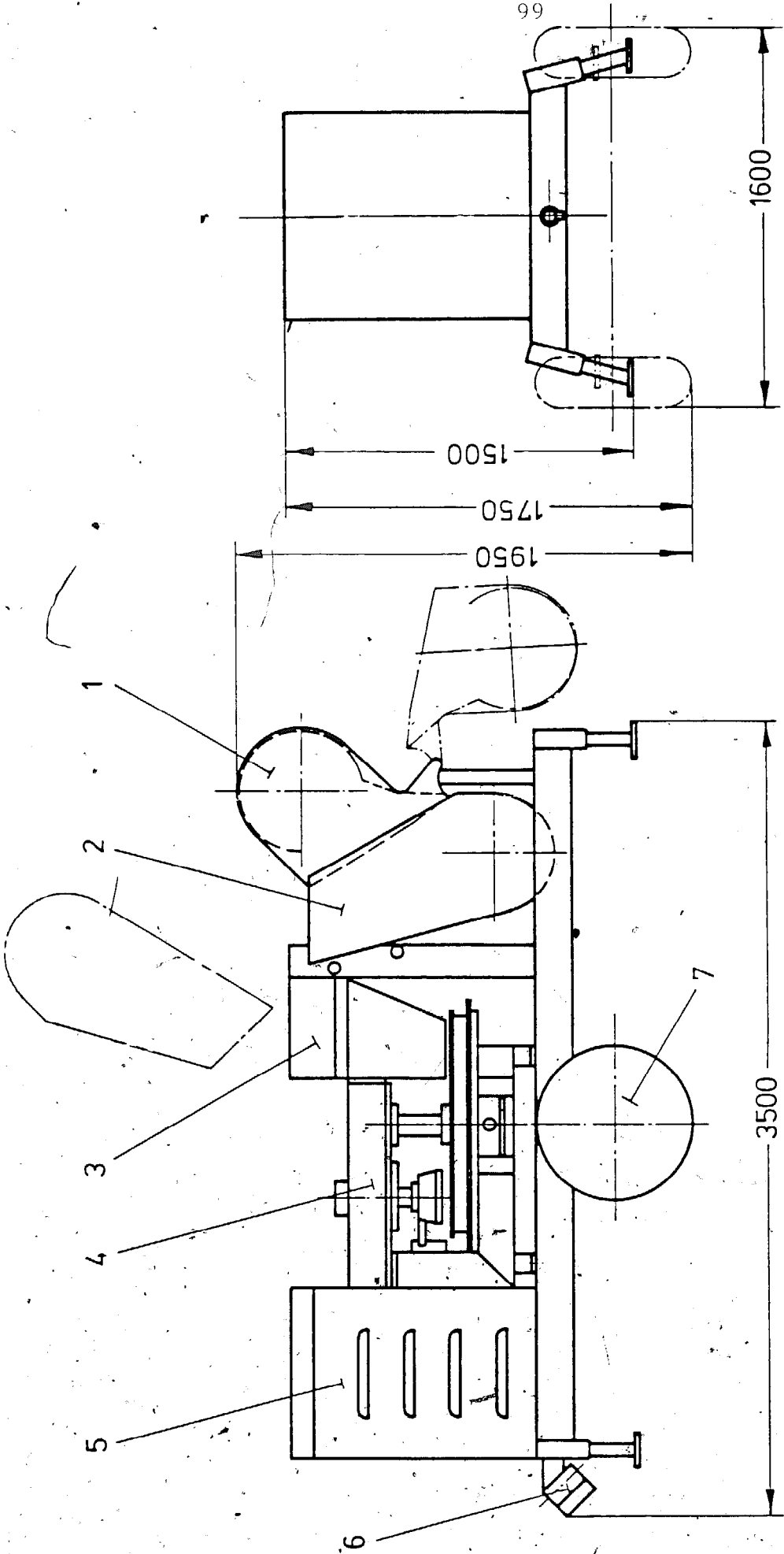

Lescha - Steinpresse Typ SBM

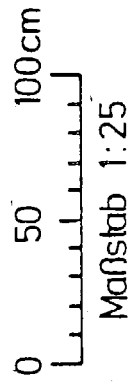

Gewicht: ~ 2000 - 2500 kg

SOIL BRICK PLANT CLU 3000

with



produces
durable
weather resistant
soil bricks

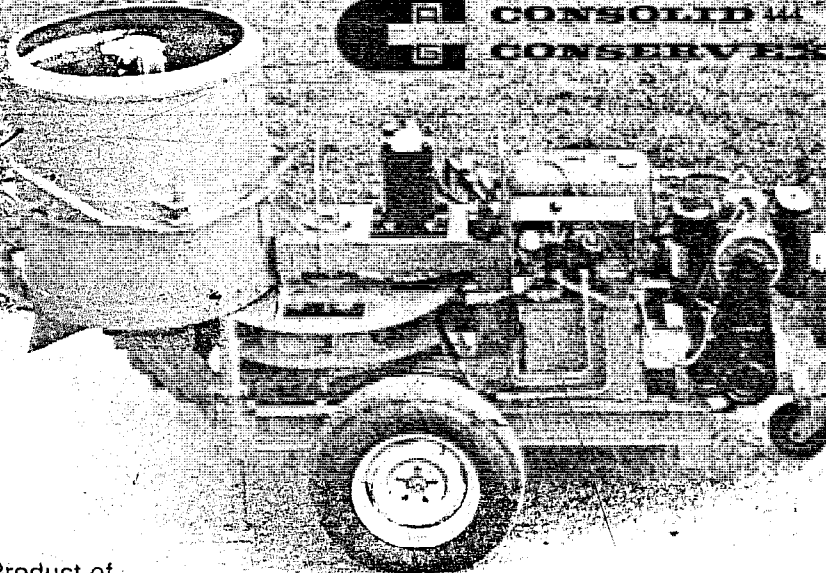

adobe
briques en terre
ladrillos de barro

A Product of

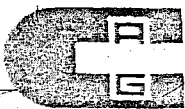

CONSOLID AG, CH-9435 Heerbrugg SG, Aechelstrasse 18 Switzerland

**TECHNICAL
BULLETIN**

No. 601.001, Ed.80

CONSOLID 44 - CONSERVEX

SOIL BRICK PLANT "CLU 3000" and CATAPULTER Sieve Machine
for the manufacture of weather-resistant soil bricks

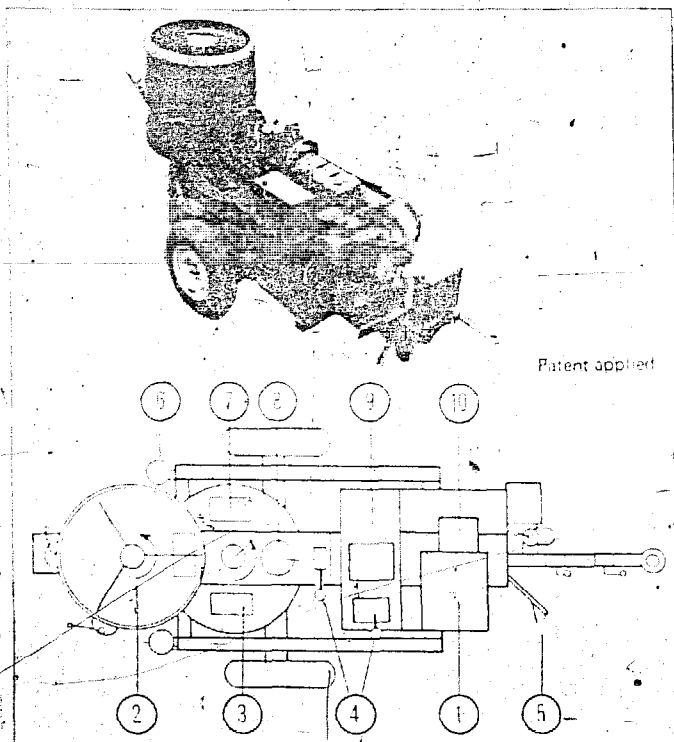

Patent applied

Technical specification:

Power: 13 HP diesel engine "HATZ Type E 950" air-cooled, hand starter, fuel consumption approx. 2,5 litres/hour;

directly coupled hydraulic pump, generating the power for all hydraulic components (mixer, rotation of press table, compaction, extrusion)

Mixer and feeder unit: A double mixer unit with horizontal mixing at appr 50 RPM. The upper mixer is used for mixing the chemical compounds into the soil; the lower mixer continues mixing and feeds the rotating moulds simultaneously with the ready-mixed soil. Each mixer has a mixing and storage volume of 100 litres loose soil.

Rotary moulds: The press table with 4 moulds is hydraulically turned one quarter after each press / extrusion step.

Press / Extruder: The pressing of the brick is manually initiated by the operator. Simultaneously the forging pressed brick is extruded. The compaction force is 15 000 kgs, corresponding with 50 kg / cm².

Transportation: The whole plant is placed on a special one-axle trailer with spring-suspended 7.00 x 14 tires, an adjustable shaft bar, a height adjustable front wheel and hand brake. Maximum speed according local regulations, not exceeding 50 km/h.

Dimensions: Length 300 cm; width 145 cm; height 152 cm.
Net weight approx. 1600 kg.

- | | |
|-----------------------------------|--|
| ① Diesel engine | ⑥ Telescope legs |
| ② Mixer and feeder unit | ⑦ Moulds for single brick (Extrusion-position) |
| ③ Press table (rotary mould) | ⑧ Hydraulic press cylinder |
| ④ Mixer and press/extrusion lever | ⑨ Tank for hydraulic oil |
| ⑤ Handbrake | ⑩ Hydraulic pump |

This Bulletin as well as all our other technical data are intended only for your information and no liability for us can be derived therefrom.

Half of our world population lives in housings mainly erected by the use of soil as building material. Therefore any quality improvement of soil for building purposes is of vital interest for millions of people. For building purposes soil is excellent, as long as its dry stability is maintained. Loss of such stability, primarily by water influence, is causing problems and may lead to total destruction of such houses. Weathering erosion by rains and softening of the soil material by soaking water damage heavily soil buildings. The treatment of in-place, cohesive soil with CONSOLID 444 and CONSERVEX allows to stop the destructive influence of water to a high degree by waterproofing soil effectively. Such water-resistant soil offers excellent opportunities for the manufacture of water-resistant soil bricks for better housings. Should the natural dry strength of soil not already satisfy, additional improvement is possible in combination with small quantities of binders. High-quality soil buildings require CONSOLID 444/CONSERVEX treated soil bricks, simultaneously an adequately advanced production facility, providing optimal sieving of the soil, thorough mixing with CONSOLID 444 and CONSERVEX and eventually other additives as well as high pressure for the soil brick production, granting constantly precise dimensional tolerances. These suppositions are fulfilled with the soil brick plant "CLU 3000" and the CATAPULTER sieve machine.

1 Filling the moulds

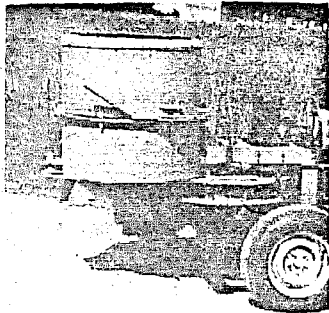

The "CLU 3000" is equipped with a double mixer unit. The upper mixer is mixing the soil with the chemicals CONSOLID and CONSERVEX. After mixing the batch is discharged into the lower mixer, where mixing is continued, and simultaneously the moulds of the press table are automatically filled through a hole in the bottom. In this way the moulds are always filled with the same quantity of soil which gives a constant thickness of the bricks.

2 Brick-pressing by hydraulics

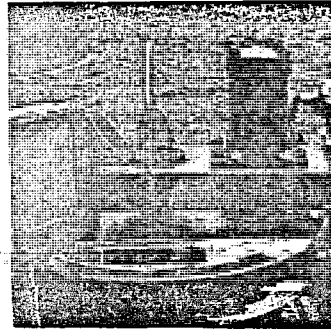

When the mould filled under the feeder mixer turns one quarter, the filled mould is freely visible for inspection. A further turning of a quarter brings the filled mould under the hydraulic press, which compacts the loose soil with a pressure of 15'000 kg or 50 kg/cm².

3 Extruding of the bricks

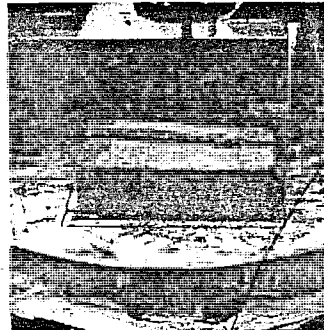

The next quarter turn of the rotary mould is the extrusion station, where at the same time when the brick is pressed the formerly pressed brick will be extruded to be removed for stock-piling. With the next quarter turn the now empty mould returns again under the feeder mixer to be filled again. The compressive strength of the green bricks is already high enough to allow stock-piling in high staples. Drying time for the bricks is approx. 2 to 3 days in the shadow.

JOB DESCRIPTION OF WORKERS

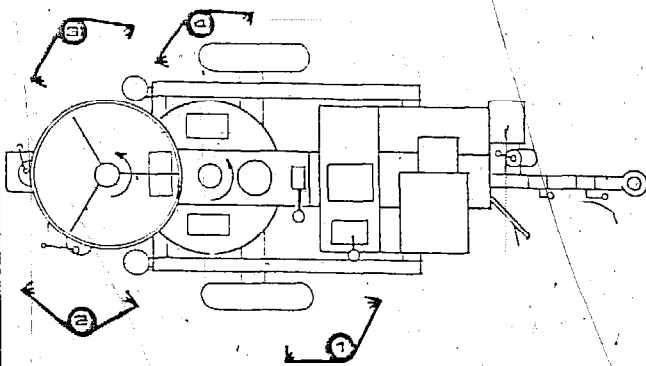

Worker No.1 - the operator - is responsible for the engine and operates the rotary mould and press / extrusion step with the respective lever.



Worker No.2 and 3 are filling the mixer with 100 litres of loose soil for each batch and add during mixing to each batch the proper quantities of CONSOLID 444 and CONSERVEX diluted in enough water to get the optimum moisture content in the soil for best compaction.



Worker No.4 removes the extruded bricks for storage and drying, placing them on the ground, pallettes or racks in the shadow for several days.

The quality of the finished bricks can be improved by repairing voids or uneven corners of the bricks as long as they are moist. If the bricks are manufactured properly, such "cosmetic" work will not be necessary or is restricted to a very small proportion.

When dry, the bricks may be used for masonry work with the same technique as burnt bricks or concrete blocks. The mortar, which glues the bricks together, can be a mixture of sand and cement as well as sand with cement and lime. But also a mixture of the same cohesive soil with CONSOLID 444 and CONSERVEX, which is mixed with the plant to a mortar by adding enough water, will be a suitable soil mortar with the advantage that the entire wall is built of uniform material.

If the bricks are used for purposes with extreme heavy water exposure or on the weathered surfaces of houses and walls, it is recommended to apply a top-coat with CONSIL soil-brick coating, a silicone-copolymer resin solution, which is creating highly effective waterproofing of the exposed surface. This coating is always applied as last step. Therefore, if a building is plastered and painted, the CONSIL top-coating will be the last process applied. Depending upon the local conditions, one or two coatings with CONSIL are applied by brush or roller. Bricks which will be used under water have to be coated with CONSIL on all sides by dipping the dry brick fully into the CONSIL solution. The protective coating will become fully effective after evaporation of the solvents.

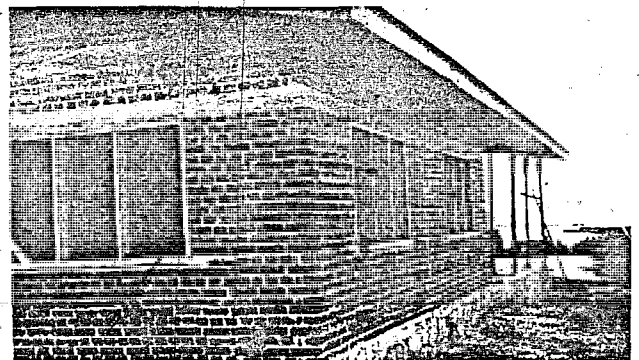

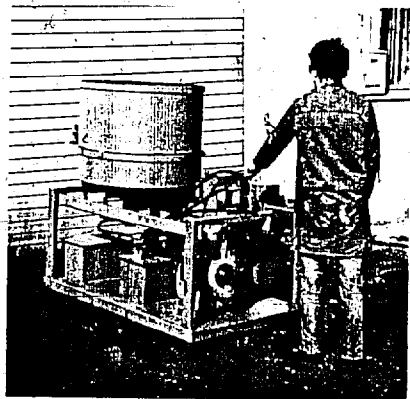

Stationary Execution 1002 and 1006

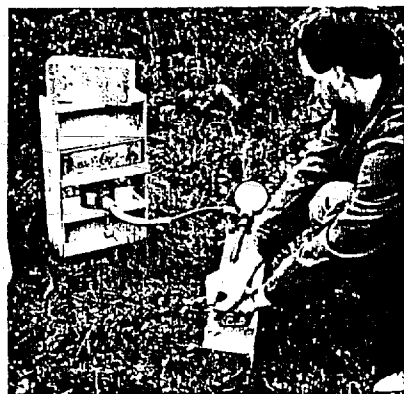

Testpress

ECOBRIK 1000

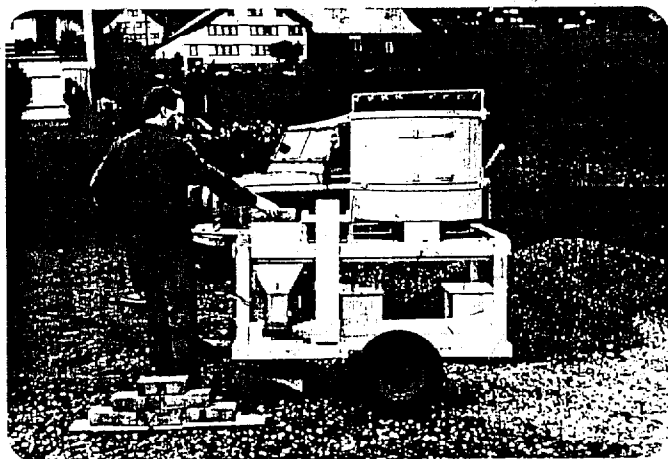

Mobile Execution 1002 with trailer and 1008

DIETER SCHMIDHEINI, Dipl.Ing. ETH, ENGINEERING
Weinbergstrasse 29, CH-9436 BALGACH, SWITZERLAND

Telephone: Office (071) 725272

Private (071) 722712

Telex: 719142 coag ch

NEW LOW-COST SOIL BRICK MACHINE "ECOBRIK 1000"

The new economical "ECOBRIK 1000" is a complete and universal soil brick manufacturing plant for producing quality but low-cost building bricks with almost any natural soil material.

The "ECOBRIK 1000" represents the result of more than 10 years of research, design and practical experience in soil brick manufacturing.

Its modern appropriate technology, its costs and efficiency are well qualified to satisfy the demand for good low-cost housing at an extremely attractive self-reliance/import ratio due to optimum use of local resources (materials and unskilled labour) and substantial elimination of transport problems.

The unique little giant "ECOBRIK 1000" is the key to create or boost decentralised family or small industry brick-making and therefore bound to counter efficiently the huge and growing need of a large part of the world's population for low-cost, but decent housing.

TECHNOLOGY: Modern, appropriate, economic, efficient and unique. Various patents.

MATERIALS: All natural in-place mineral soils (except salt-contaminated and black-cotton soils).

Any binding materials, such as clay, cement, lime, bitumen emulsions, chemicals, etc. at surprisingly low quantities.

LABOUR: After one day training, two unskilled male or female workers produce already 100 bricks per hour, corresponding to a 12 cm wall of 2 sq.metres.

BRICKS: Size 25 x 12 x 7.5 cm
Weight 4 to 4.7 kg
Compressive strength 30 to 100 kg/cm². Density 1.8 to 2.1.
(Indicated ranges depend upon chosen process).

No firing process; 2 to 4 days air-curing. Flat and/or dented faces, uniform; precise shape, original colour of soil.

Excellent room climate properties due to very low heat and noise transmission.

Walls may be plastered or painted.

Immediate piling of "green bricks" for air-curing; easy and quick handling by masons, causing no back troubles.

FLEXIBILITY: Mobile or stationary models as "ready to produce" or "do it yourself assembly kit" available.

Module design allows quick and simple disassembling and reassembling.

Diesel or electrically powered (upon request).

Very large range of suitable soils from sandy to clayish material. The unique soil processing unit performs also blending of different soils, if desired. Also very handy for mortar mixing.

Simple but accurate field compressive strength testing device available.

SOIL PROCESSING: The unique "three-step" hydraulically powered processing performs soil sieving and pulverising; mixing and mould feeding or mortar discharge.

COMPACTION: Double-action hydraulic compaction at 15'000 kg (50 kg/cm²) grants uni-form compaction, independent of soil type and its granular density.

MAINTENANCE AND SERVICE: No greasing, simple daily cleaning, normal engine service. Very rugged, long-life and simple "screw-off, repair or replace" design. No special skill or special tools required. Tool box contains all kit assembly and service tools.

COSTS: Small foreign currency investment. Appropriate design for licensing. Extremely competitive brick costs due to unusually small quantities of binding additives required (e.g. 50 to 100 kg cement per one cubic metre (2000 kg) equal to 445 bricks). 1.6 litres diesel fuel per hour for 100 bricks. Low overhead, labour and maintenance costs. No transport costs for bricks manufactured on building site. The favourable manufacturing costs offer very attractive profits at very competitive sales prices "delivered on building site".

PROSPECTIVES: TECHNICAL SPECIFICATIONS: "ECOBRIK 1000" (stationary) Weight 600 kg - length 160 cm - width 90 cm - max.height 140 cm "ECOBRIK 1000" (mobile) Weight 650 kg - length 120 cm - width 120 cm - max.height 165 cm The entire machine represents a fully modular design which allows simple service access, requiring primitive garage know-how only. Adjustable shaft bar for truck or Landrover. Spring suspended commercial air tire wheels, max.speed 25 km/h.

INSTALLATION: For installation of the mobile version it is convenient to sink the two wheels into dug-out holes to reduce the fill height of the soil processor.

MANUFACTURING PROCESS: The soil mix operator fills approx. 50 litres soil into soil processor - opens during sieving, stone discharge door, whenever required - adds binding additive - adds compaction water - discharges soil mix into feeder drum - repeats above continuously. - The "brick-maker" operator pushes control valve to "soil processing" and rolls mould to "fill" position - rolls mould to "compact" position - rolls valve to "compaction" position (cylinder retreats) - pushes valve to "soil processing" position (cylinder retreats) - rolls mould to "extrusion" position - rolls valve to "compaction" position (the brick is extruded) - removes and deposits brick - repeats above continuously.

LOW-COST TESTING DEVICE FOR "ECOBRIK 1000"

This complete and rugged hand-operated hydraulic press allows an unskilled person to measure accurately in the field the compressive strength of bricks produced with the "ECOBRIK 1000".

Its pressure indicator dial allows easy readings of the compressive strength up to 100 kg/cm², which equals a total pressure of 30'000 kg on the brick's 12 x 25 cm flat surface.

Dimensions: 46 x 30 x 15 cm
Weight: 68 kg.

DESIGN DETAILS: The "ECOBRIK 1000" is powered by the reliable hand-starting 7 HP Hatz diesel engine model E5 79 or an electric motor according to the customer's voltage, cycles and phase specifications.

The hydraulic gear pump supplied from the 20 litre fluid tank is directly coupled to the engine or motor and activates the hydrostatic gear motor of the soil processing unit and the compaction/extrusion cylinder. The manual control valve has three positions: "compact", "neutral" and "soil processing".

All features of the simple hydraulic system are reusable and allow replacement of hoses in the field without special tools. Maximum hydraulic pressure 190 bar.

The soil processing unit is driven by a single main shaft only, directly coupled to the hydrostatic gear motor, and carries all rugged but simple soil agitating components. By loosening one screw only, it may be completely disassembled for service.

Compaction and extrusion is performed by the same rugged hydraulic cylinder which is integrated in the mould carriage module. This clever design grants permanent tight closure of the mould during compaction, eliminates any future adjustments and mechanical deformations, despite of the high pressure of 15'000 kg, resulting in excellent long-term product quality. The tool box to be locked and removable for safety purposes contains all necessary tools for kit assembly and machine service.

The production capacity of the "ECOBRIK 1000" is 100 bricks per hour, corresponding to one cubic metre or 445 bricks in 4.5 hours.

The favourable investment/production output ratio could only be achieved by combining a batch mixing process with a feeder reservoir for continuous production.

Meili mechanical soil brick press

Meili mechanical soil brick press

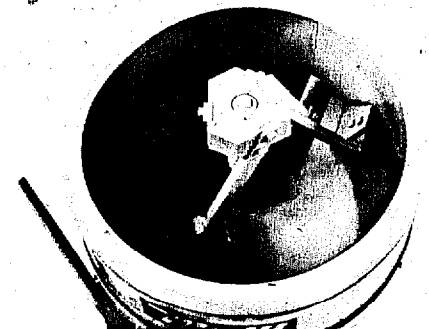
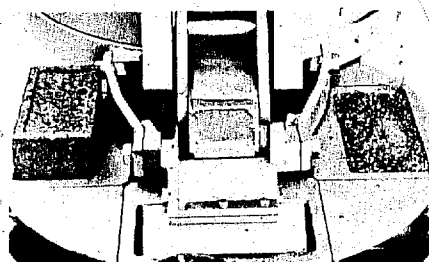
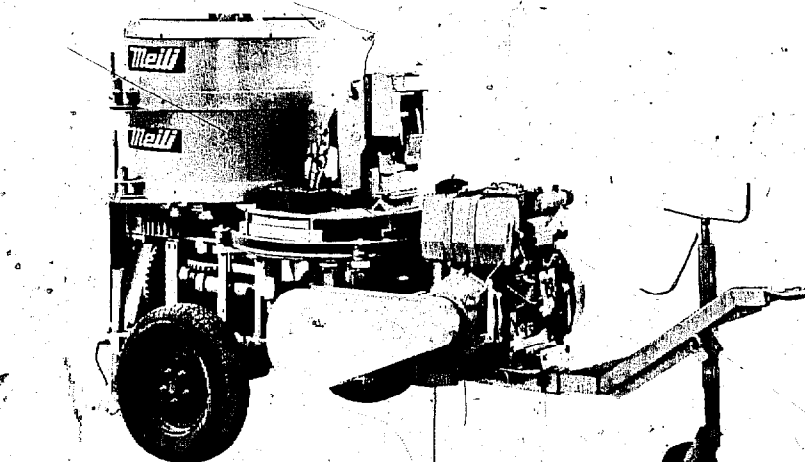

As a result of the tremendous success achieved by the "Meili-60" manual brick/block press in countries like Guinea, Nigeria and India, etc., and in recognition of the overwhelming need for large quantities of cheap, durable building materials in all of the developing countries, the Meili technology development group now offers its new and versatile:

Meili "Mechanpress"

The automatic soil brick and block making machine. Using the same basic idea and operating principles of the famous "Meili-60" manual brick/block pressing machine, Meili has now developed a motor-driven mechanical 20 tons soil brick and block making machine capable of producing upwards of 1000 top-quality soil bricks and blocks per hour.

The Meili mechanpress offers:

- Simple design
- Sturdiness
- High performance
- Easy maintenance
- Reliability
- Economy

Technical specifications of this low-cost high performance machine

Engine

kind of engine 2-cyl. diesel-engine
cooling system air
performance 18.5 HP DIN at 2700 r.p.m.

range of revolutions 1800-2700 r.p.m.
max. torque 6.25 mkg
consumption 195 gr/hph
starting mechanism hand-accelerator

Drive

engine dry friction clutch-type engine
1. stage flat-belt drive ca. 3:1
2. stage v-belt-drive ca. 3:1
mixer total reduction 30:1
off-center press the lever is separated from the mixer by a mechanical clutch
function

Soil material mixer

diameter 800 mm
height 320 mm
content 150 liters
revolutions 60-70 r.p.m.
number of shovels 3

Moulds and press table

diameter of the table 1060 mm
height of the table 120 mm
moulds standard: 250 x 125 mm
max. 300 x 150 mm
turning rhythm every 4 sec. from 90 to 90 degrees.

Steering device

revolutions of steering disc 15-20 r.p.m.
type of steering mechanical
enforced movements pressing, turning, pushing out, filling

Chassis

number of axles 2
axle weight limit 800 kg
suspension rigid
tire equipment 155 SR-12
coupling device pole with a support

Dimensions and weights

total length without pole 2300 mm
total width 1250 mm
total height 1650 mm
packing volume 4.75 m³
total weight ca. 1700 kg

Offers for manufacturing the Meili "Mechanpress" under license in various countries will be considered.

Manufacturer reserves the right to change technical specifications.

Agent:

Meili

Engineering Practical and affordable technologies for developing countries

Gewerbe-Center Rothaus
8635 Dürnten/Switzerland

Telex 875 750
Telefon 055/31 39 21

Meili

Engineering Practical and affordable technologies for developing countries

Gewerbe-Center Rothaus
8635 Dürnten/Switzerland

Telex 875 750
Telefon 055/31 39 21

le bloc en terre : TERRE 2000

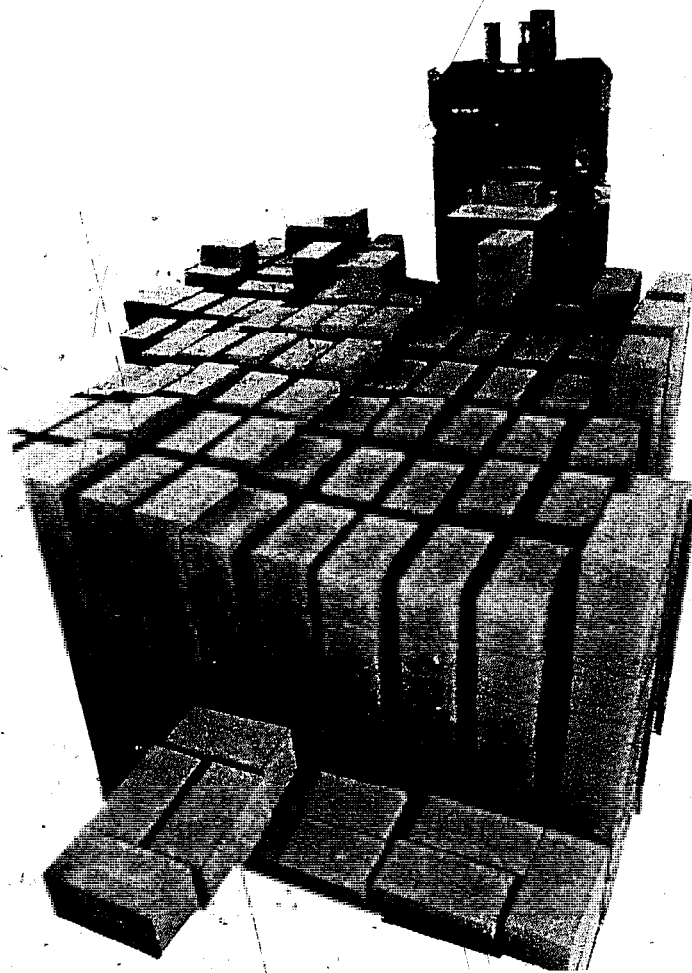

RGF TERRE 2000 Système Constructif -
Siège Social : Les Lauzes quartier Jenteln - B.P. 98 - 13160 CHATEAURENARD - Tel. 90 94 04 86 - FRANCE - Telex 431 919 FCI AV ROBIN
Usine : 411, Av. Pierre de Coubertin - 84310 MORIERES - Tel. 90 22 35 18 - FRANCE - R.C. B 331 013 094 - SARL au capital de 140 000 F

TERRE 2000

FICHE DESCRIPTIVE

Objet : BLOCS DE TERRE COMPRESSE - PROCEDE RG-TERRE 2000

1.- DESCRIPTION DES PRODUITS

Blocs pleins de dimensions :

L = 30 cm l = 15 cm h = 15 cm

(la hauteur (h) est réglable et peut varier de 7 à 15 cm)

Tolérance : inférieure à 1 mm

Poids : 12 à 14 Kg

Densité moyenne : 1,9 kg/dm³

Résistance à la compression : 80 à 130 bars

2.- UTILISATION DES PRODUITS

Les blocs sont utilisables en murs porteurs de 15 cm d'épaisseur pour des constructions en rez-de-chaussée ou avec un étage.

Suivant les traitements et le mode de construction, l'enduit peut être supprimé. Sinon, un enduit de terre et ciment est le plus courant ou encore, un simple badigeon d'un produit hydrofuge (silicone, gel plastique, huile de lin, peinture, ...)

Comme dans toutes constructions en parpaings, des chaînages d'angles et de liaisons sont recommandés. Ceux-ci peuvent être réalisés en béton ou par des feuillards en acier ou par des éléments en bois.

3.- MATIERES PREMIERES

Tous les types de terre sont en principe utilisables avec plus ou moins d'intervention, excepté les couches de terre arable.

Les caractéristiques optimales seraient les suivantes :

- exempt de matériau végétal
- granulométrie : max. 15 mm
- teneur en argile : 20 %
- teneur en limon : 30 %
- teneur en sable : 50 %

La latérite est parfaitement utilisable.

Les stabilisants les plus courants sont le ciment, la chaux, le bitume, la résine, avec une teneur moyenne de 3 %. Dans certains cas aucun adjuvant n'est nécessaire.

4.- PROCEDE DE FABRICATION

Après l'extraction et la préparation la terre est passée dans un malaxeur, puis dans la presse par un transporteur à vis.

Les blocs sont comprimés à 90 bars, évacués manuellement et mis à sécher pendant 2 à 7 jours.

Pour chaque projet d'implantation, il est indispensable de faire les analyses des sols du chantier et de recenser les ressources locales pour le traitement (blocs et enduits).

Les analyses peuvent être réalisées par des laboratoires locaux (LABORATOIRES DES TRAVAUX PUBLICS par exemple).

Des essais en FRANCE sont possibles et nécessitent au minimum 30 kg pour des essais sur éprouvettes et jusqu'à 300 kg pour des essais réels.

5.- EQUIPEMENT DE BASE

Il s'agit d'une unité autonome comprenant : un malaxeur de 250 l, un transporteur à vis, une presse hydraulique de 40 t et un moteur Diesel de 13 cv à démarrage électrique ou manuel.

L'ensemble pèse environ 2,5 tonnes et ses dimensions le rendent aisément transportable d'un chantier à l'autre à l'aide d'une remorque tractable.

6.- CAPACITE DE PRODUCTION

300 blocs/h, soit en 1 équipe : 2.400 blocs/jour.

Cette quantité correspond à 110 m² de mur de 15 cm (22 blocs/m²).

7.- INVESTISSEMENTS

7.1 Terrain et bâtiments

La machine ne nécessite aucune construction spéciale, sauf éventuellement pour abriter la machine et pour le stockage des blocs.

7.2 Equipements de base

L'unité coûte 270.000,- FF FOB MARSEILLE
300.000,- FF CAF TOMASINA.

7.3 Equipements et installations annexes

Il s'agit de matériel classique d'extraction de terre, pour environ 35 t/jour.

PRESSE TMR 6750-40 - TERRE 2000 - BREVETE

- Application : compression du matériau granuleux pour réaliser des blocs de dimensions 15 cm X 30 cm avec hauteur variable jusqu'à 15 cm maxi.
- Principe : hydraulique à double pression
Mouvement par tiroir et tam-
pou de compression et de décompression.
- Autonomie : complète. Energie en modèle de base par moteur thermique = 12,5 Kw - Consommation = 1,5 l. de Gasoil à l'heure - Batterie = 12 V. 90 A.
- Mobilité : machine tractable. Faible encombrement. remorque adaptée en option.
- Gabarit : largeur x longueur = 190 cm x 210 cm
hauteur = 210 cm (hors remorque)
poids = 1800 Kgs environ.
- Force de compression : en base 40 tonnes (90 Kg par cm² en pression sur le matériau).
- Cadence : 300 blocs à l'heure en fonction du matériau.
- Fonctionnement : en base semi-automatique = après remplissage de la hotte, action du levier de commande qui permet de compresser, de mouler et d'expulser le bloc que l'on peut manipuler aussitôt.

VIS DE TRANSPORT TERRE 2000

- Elément mobile, fonctionnement par moteur électrique ou système hydraulique (option à définir). Puissance = 3 kw.
- Dimensions : hauteur 2,70 m. - longueur de vis = 3,30 m. largeur = 1,20 m. - Poids = 350 Kgs environ.
- Système d'arrêt automatique quand le remplissage de la hotte est achevé.

MALAXEUR

- Dimensions : largeur = 0,80 m longueur = 2,30 m - hauteur = 1,50 m
Poids = 600 Kgs environ.
- Fonctionnement : par moteur électrique ou hydraulique. Puissance = 6 kw. Vitesse de rotation : 50 tours.
- Capacité : 300 litres.
- Trappe de distribution.

LA CHAINE

L'ensemble de ces trois éléments constitue la chaîne de fabrication TERRE 2000. Entièrement compatibles, des options peuvent être étudiées pour des demandes spécifiques.

Les caractéristiques définies sur ce document de présentation peuvent être modifiées par TERRE-2000 R.G.F. Un cahier des charges définis précisément chaque élément.

ALTECH

TERRE CRUE

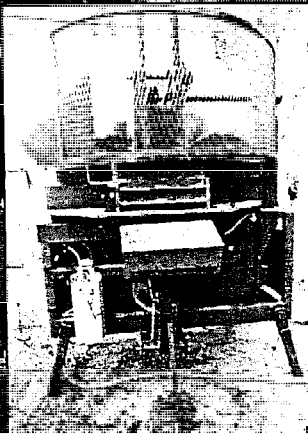

PACT 500 Block Press

LE BLOC DE TERRE CRUE COMPACTÉE,
UN MATÉRIAU LOCAL,
ÉCONOMIQUE EN ÉNERGIE,
POUR UN MEILLEUR CONFORT
D'HABITATION.

ALTECH

S.A.R.L. au capital de 145 000 francs
R.C. GAP n° B 327 543 161/83 B 67
Siège social: Rue des Cordeliers
05200 EMBRUN — FRANCE
Tél. (92) 43.21.90 - Telex : 420 219

ALTECH PACT 500

Rue des Cordeliers
05200 EMBRUN — FRANCE
Tél. (92) 43.21.90

INFORMATION TECHNICAL DOCUMENT ALTECH NATURAL EARTH PAGE 2

THE PLANT : PACT 500

PACT 500 is a press based on a specific patented gearing system and a four moulds rotating plate.

Its weight of 550 kgs categorizes it in the light mobile plants.

The machine essentially consists of a mechanical compaction system and a rotating plate equipped with four moulds permitting the following operations :

- feeding,
- control,
- compression,
- extrusion.

Each mould is bottomless parallelepiped. The soil rests on a fixed table placed under the rotating plate and slides when the plate moves. It is manually initiated.

Feeding is carried out through a hopper placed close on the plate, whose rotation razes the earth in the mould permitting a precise volumetric dosage.

Compaction is mechanically achieved by an eccentric whose shape permits to a constant couple to exert an increasing force up to 50 tons, with an energy source of 2 HP.

The duration of the entire compaction cycle is of the order of 6 seconds. It is operated through a command and automatically stops after each compaction - emptying.

Extrusion is done from below, through an opening of the section of the mould in the fixed table. The manufactured bricks are received on a tilting down table and are removed by hand.

If a change of brick size is requested, remove the four moulds, the two pistons (compacting and emptying), the reception table and the porch height wedges. This work doesn't take more than 20 minutes.

OPTIONS

- Electrical engine 220V mono, ou 380V tri,
- Road frame with removable wheels and pole,
- Pneumatic brickyard wheels instead of two feet.

MAINTENANCE

- Weekly greasing of bearings and sliding pieces.

INFORMATION TECHNICAL DOCUMENT ALTECH NATURAL EARTH PAGE 3

CHOICE OF SOILS

Many types of soils can be used to manufacture high quality raw earth blocks. They can also be blended to get better results.

The elementary technical criteria of choices are :

- Non vegetable soil,
- Soil or a mix compose of clay (10 to 30%),
- Soil or mix of a continuous grain size distribution.

Economical criteria must be added to these technical properties :

- Proximity of the site, (foundations, quarry, ...)
- Presence of lumps, (preparation cost).

PREPARATION OF THE SOILS

SIEVING

In order to eliminate undesirable elements from the soil for compacting (gravel and stones) and to get a uniform mix (lumps).

The rejected material shape must be studied and can vary from 5 to 15 mm according to the soils.

The soil must be sieved either through a fixed screen (manual sieving), or a vibrating screen, or a pulveriser which combine crushing and sieving.

The soil must be dry or slightly wet.

GRINDING

Fortunately, it is seldom necessary.

This operation brings to a correct grain size and transforms a stony lumpy material, or homogenizes other soils.

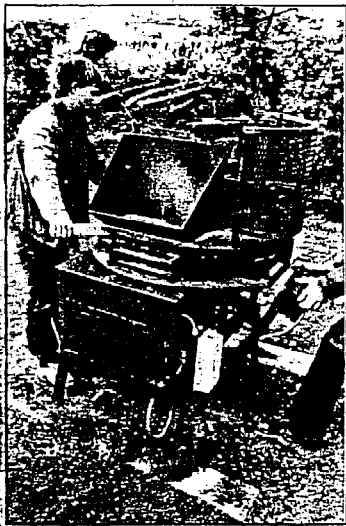

- Les qualités du matériau terre sont unanimement reconnues :
- absence de cuisson impliquant un faible coût énergétique ;
 - faible consommation de stabilisant permettant une indépendance de produits souvent importés (ciment, chaux...);
 - une bonne inertie thermique offrant un meilleur confort d'habitation ;
- Les blocs de terre crue compressée offrent les avantages suivants :
- une grande facilité et une bonne souplesse de mise en œuvre ;
 - des possibilités de fabrication en région humide (contrairement à l'adobe) :
 - blocs manipulables sitôt compactés ;
 - stockage immédiat en tas sous simple bache ;
 - la possibilité d'embaucher une main d'œuvre locale peu qualifiée à l'issue d'une formation de courte durée.

**CARACTÉRISTIQUES
 DES BLOCS**

- Elles dépendent essentiellement de la terre utilisée :
- la résistance à l'écrasement peut varier de 40 à 150 kg/cm² ;
 - la stabilité à l'eau est également fonction du choix et de la quantité du stabilisant introduit dans la terre.
- A titre d'exemple, certaines terres permettent de réaliser des blocs qui résistent à une semaine d'immersion totale avec moins de 3 % de ciment.

MIXING

A high quality product will depend on this operation.
 Mixing will ensure a good and homogenous blending of the soil (or soils), stabiliser and water.
 The stabilising powders must be mixed with the earth before watering.
 Precise water dosage is required for good compacting.
 Wet mixing is the hardest physical work.

In order to get a good output and a correct quality, mechanization will be recommended with the help of a dry concrete mixer, or eventually, a power cultivator.

WET CONTROL

This most important control must be done on the soil before compacting, and requires an apprenticeship easily obtained through studying the manufactured brick.

Visual observations

- too wet : water is appearing on the brick surface and very often, the soil sticks to the mould.
- too dry : the brick surface shows a few cavities due to bad compacting.

Tactile observations

- too wet : it is easy to press and leave fingerprints on the brick.
- too dry : friable edges.

DRIVING

It must be controlled according to the chosen stabiliser.
 The brick will generally be stored for 2 or 3 days in a wet atmosphere (plastic covers and watering), to allow the stabiliser a good hydration (lime, concrete). Then comes the drying stage itself, away from the sun in order to be homogenous.
 So treated blocks can be used in masonry within 10 days but will reach their ultimate hardness only a few weeks later.

OPERATIONS			SET UP	
COMPULSORY	OPTIONAL	CRITERIA of CHOICE	MANUAL Material	MOTORISED Material
EARTH STORAGE SHELTER			TARPAULIN, PLASTIC FILM	TARPAULIN, PLASTIC FILM
	SIEVING	LUMPS STONES	FIXED SCREEN SHOVELS	VIBR. SIEVE SHOVELS
	PULVERISATION SIEVING	CLAY STONES		PULVERISER
	GRINDING CRUSHING	STONES		GRINDER CRUSHER
	DRY MIXING	STABILISER	SHOVELS	CULTIVATOR MIXER
WET MIXING			SHOVELS	CULTIVATOR MIXER
LOADING			SHOVELS	SKIP CONVEYOR BELT
COMPACTING			PACT 500 (MOTORISED)	PACT 500
EXTRUSION			WHEELBARROW SLIDING OF PACT 500	CONVEYOR BELT
STORAGE			SHELTER PLASTIC FILMS	SHELTER PLASTIC FILMS
CONTROLLED DRYING			WATERING CANS HOSING	WATERING CANS HOSING

PRESSE HYDRAULIQUE CTBI

. Double système hydraulique (DSH)

a) DESCRIPTION :

Matériel réalisé avec des matières premières courantes et des composants courants.

Matériel fonctionnant à l'aide d'un verin hydraulique et alimenté par un moteur électrique.

Matériel plus volumineux que la presse manuelle mais de dimensions raisonnables.

Matériel monté sur longerons afin de pouvoir le fixer au sol en poste fixe. Il peut être monté sur un essieu et tractable derrière un véhicule léger.

b) FONCTIONNEMENT :

. 1er temps - Remplissage du moule :

Le remplissage peut se faire manuellement (à la pelle ou au seau) ou mécaniquement avec tapis d'amenée et une trémie de stockage située au-dessus du moule, la quantité de terre nécessaire est donnée par la position réglable du couvercle de pressage sur son appui.

. 2ème temps - fermeture du moule

Manuellement on tire sur le couvercle qui en coulissant vient obturer le moule.

. 3ème temps - Compression :

Dès que le couvercle est en position fermée et sans qu'aucune autre information ne soit donnée à l'armoire d'automatisme le verin de pressage s'actionne comprimant le carreau de terre en sandwich entre ses 2 plateaux inférieur et supérieur.

. 4ème temps - Ouverture du moule :

Automatiquement, sans intervention de l'opérateur dès que la côte finale du carreau est atteinte le couvercle s'ouvre verticalement.

. 5ème temps - Ejection :

L'opérateur, en poussant le couvercle vers l'arrière donne le signal d'éjection par micro-contact.

Dès que le carreau est sorti du moule, l'opérateur s'en saisit, le cycle est ainsi terminé.

. 6ème temps - Relance cycle suivant :

Une double commande (bouton poussoir + pédale) autorise le départ d'un nouveau cycle en phase de remplissage.

c) CARACTERISTIQUES PHYSIQUES :

- . Poids : 350 kg
- . Hauteur : 1,15 m
- . Longueur : 1,8 m
- . Largeur : 0,9 m

d) CARACTERISTIQUES TECHNIQUES :

Tous les composants sont français.

(1) ELECTRICITE :

- a) automatisme "Télémechanique" et protections
- b) puissance : Moteur "LEROY SOMMER" 1500 tr/mn
puissance 5,5 Kw
intensité 12,6 A
tension 380 V

En option matériel tropicalisé.

(2) HYDRAULIQUE :

- a- génération : Pompe HPI
Débit 20 l/mn à 1500 tr/mn
Pression de service : 160 bar
- b- verin : "CPOAC"
alésage = \varnothing 100 mm
tige = \varnothing 60 mm
course = 125 mm
force = 12,5 t.

- c- distribution : distributeurs "CPOAC"
limiteur de pression "CPOAC"
filtration "HYDAC"
bac contenance 50 l liquide hydraulique.

(3) MECANIQUE :

Le moule ainsi que toutes les pièces soumises à des efforts importants sont en aciers spéciaux mécano-soudés.

Les guidages sont réalisés par bagues "GLYCODUR" très résistantes.

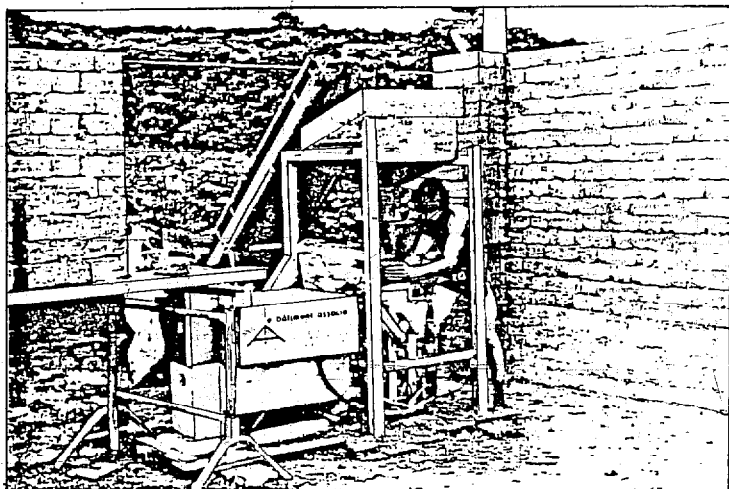

CTBI Hydraulic Press

e) CADENCE DE FABRICATION :

Carreaux de 32x16x10,5

Poids d'un carreau : 12 Kg

Cadence variable suivant :

- la fabrication à réaliser
- les matériels de service autour (alimentation et évacuation).
Ces matériels peuvent être mécanisés ou automatisés.

En moyenne de 80 à 110 carreaux/heure mais avec une seule personne au commandes et sans effort physique (données extraites d'un chantier).

f) CONDITIONNEMENT - TRANSPORT - POIDS :

Dans la conception même de ce matériel ces détails n'ont pas été oubliés.

Son châssis sur longeron permet une manipulation rapide et une mise en place précise.

Son conditionnement peut être soit :

- 1 caisse bois de 1,20 x 1,85 x 0,95 pour un volume de : 2.100 M³ et un poids de 400 Kgs

- 1 housse plastique retractable

Tous les moyens de transport peuvent être utilisés : l'avion, le bateau, le camion, la camionnette. Ce matériel peut également être tracté derrière un véhicule léger lorsqu'il est monté sur essieux.

g) COÛT :

Matériel exécuté en un seul exemplaire. Prix actuellement estimé entre 65.000 et 75.000 Francs H.T. Départ MUIZON. Toutefois, toute étude est nécessaire à chaque consultation afin de répondre précisément à la demande du client.

h) DESTINATION :

Marché local en construction neuve pour des petites opérations. Marché à l'exportation. Toutefois, pour les pays d'Afrique il y a lieu que le matériel soit tropicalisé.

GEO 500 Semi-Bloc, Unité Atelier

A - ORGANISATION - MATÉRIEL - MAIN D'OEUVRE

Hypothèse

- Gisement sur lieu de construction - extraction manuelle ou à l'aide de matériels agricoles disponibles sur place.
- Pas de réseau électrique: un moteur diesel (12CV) actionne la centrale hydraulique qui alimente la presse et le malaxeur équipé d'un moteur hydraulique.

Schéma de production

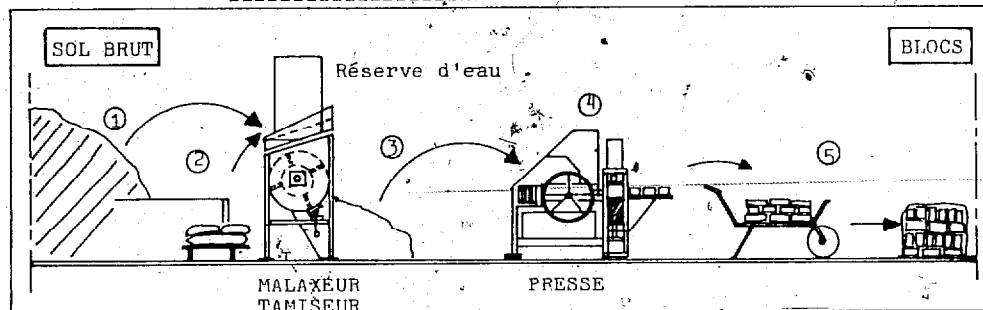

MAIN D'OEUVRE/OPERATIONS

1- Extraction - Préparation du sol brut:	2 pers
2- Chargement du malaxeur Dosage ciment/eau commande	2 pers
3- Alimentation de la presse:	1 pers
4- Commande de la presse Réglages, contrôle des blocs.	1 pers
5- Manutention - stockage des blocs (empilement)	2 pers
TOTAL MAIN D'OEUVRE	8 personnes

MATERIELS -

1- Matériels de base (à amortir)
.Malaxeur/tamiseur (moteur hydraulique) MX 200T
.Presse semi-automatique (moteur diesel) GEO 500 Semi-Bloc
2- Equipements complémentaires (disponibles ou réalisés sur plan).
.Abri pour cure des blocs/bâche
.Brouettes - pelles - pioché.

B - ANALYSE ECONOMIQUE

B-1 PRODUCTION MOYENNE JOURNALIERE

- Débit malaxeur: 1,5 tonnes/heure
Temps effectif de travail: 6,5 heures
Durée de gâchée: 13 à 15 minutes.
- Débit de la presse: 1,8 tonnes/heure
Temps effectif de travail: 5,5 heures
Temps de cyclage: 15 secondes.

PRODUCTION MOYENNE JOURNALIERE:	10 tonnes
NOMBRE DE BLOCS 29,5/14/(9)	1350 blocs
Poids moyen: 7,5 kg.	

B-2 CONSOMMATIONS JOURNALIERES

a) matières

Pour 10 tonnes de blocs produits
 - eau d'apport (6%): 600 litres
 - sol brut humide avec
 30% de refus au tamisage: 11,6 tonnes
 - ciment 4,5% du poids.
 total humide: 450 kg.

b) énergie

P.E.D.
 1 moteur diesel 12CV. Consommation 3 litres/h.
 Durée de fonctionnement 7 heures
 Consommation journalière gas-oil: 21 litres

Études et réalisations mécaniques

SOCIÉTÉ HALLUINOISE DE MÉCANIQUE

HALLUMECA

S.A.R.L. au Capital de 125 000 Francs

37, rue des Ecoles 59790 SAISIEUX
 Siège Social : 353, rue de la Lys 59250 HALLUIN
 Tél. (20) 84.64.95 56.25.26

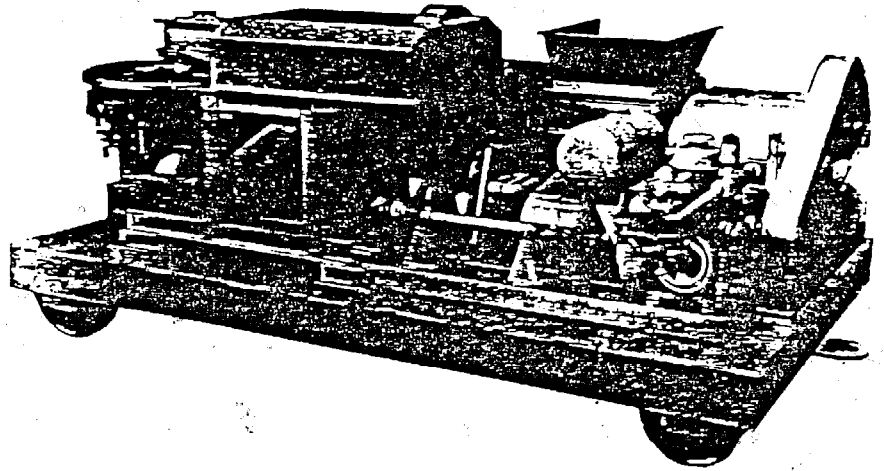
GROUPE UNIPRESS**11. - DESTINATION -**

Fabrication de briques pleines dont la production maximum est de

- 2 000 briques par heure, soit environ :
- 3 000 000 de briques par an.

12. - TYPE DE PRODUCTION -

La production de briques est réalisée à partir d'argile moyenne dont l'humidité est de 15 à 18 %, sans broyage particulier.

Les mélanges argile-sables sont également utilisés.

13. - AVANTAGES -

Les groupes UNIPRESS sont mobiles et peuvent se déplacer dans les usines près des fours et des carrières.

Ils sont autonomes et peuvent être alimentés par diesel ou électricité.

Les puissances absorbées sont faibles.

ULTRABLOC

Ultrabloc
P.O. Box 1363
Corrales, NM 87048 USA
(505) 898-0194

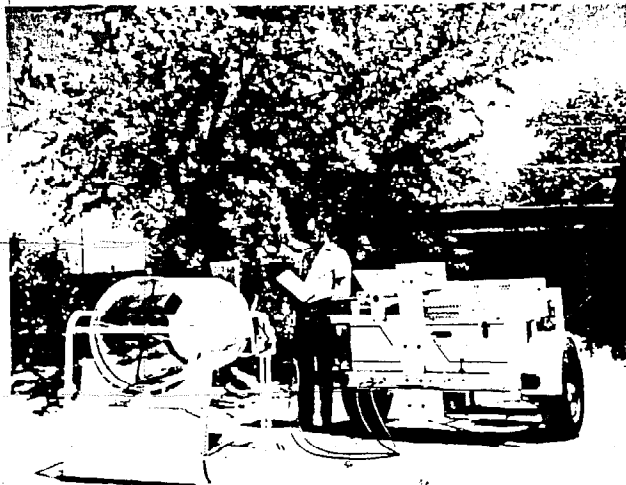
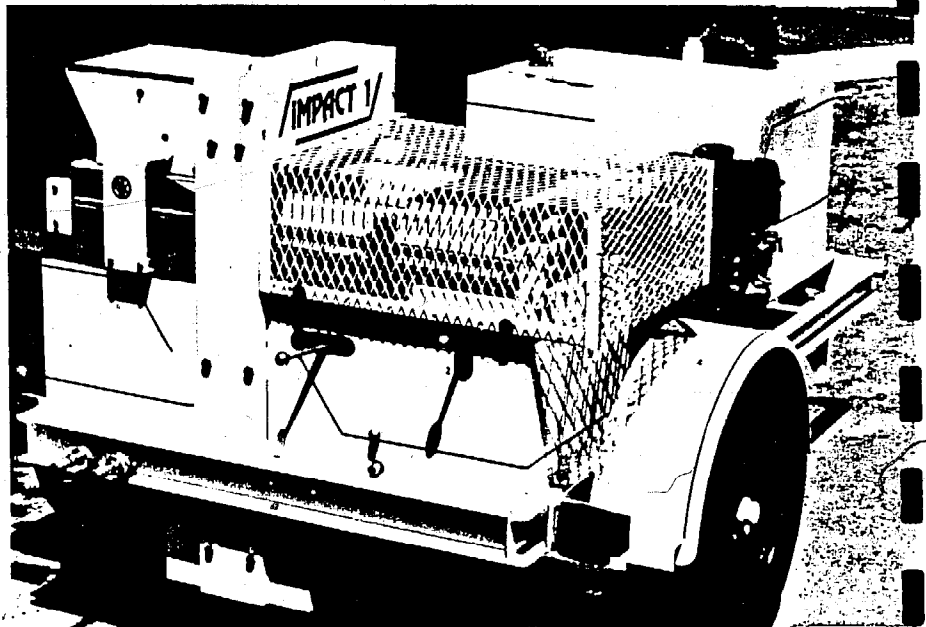

FEATURES

- precision-machined to $\pm .015"$
- special steel alloys in mold cavity
- heavy-wear parts of stainless steel
- industrial hard-chrome components
- rust-proof cowlings
- adjustable mold depth
- special non-stick press-foot
- top-quality engine and hydraulics
- standardized replacement parts
- hydraulic power-take-offs

OPTIONAL EXTRAS

- dirt screen with hydraulic motor
- log-splitter attachment

SPECIFICATIONS

	IMPACT 1	IMPACT 2
FEED TO DRAWER OPERATION	manual	automated
BLOCK SIZE	3.6" x 6.5" x 12" (9x14x30.5cm)	
AVE. BLOCK WT.	16 lbs. (7.25 kg)	
MACHINE DIMENSIONS	h.48" x w.80" x l.11.5' (117x153x350cm)	
MACHINE WT. approx.	2200 lbs. (988kg)	2650 lbs. (1202kg)
ENGINE	Yanmar diesel 7hp./crank start	19hp./self-start
CYCLE CAPACITY	1680/8 hrs.	2400/8hrs.
BLOCK PRODUCTION	1680/8 hrs.	2400/8hrs.
AXLES	single/3500*	double/each 2000*
COLOR	white/blue trim	

Ultrabloc's new Impact series of pressed-earth block machines represents over 20 years of experience in the field. Ultrabloc pressed-earth block units are similar to adobe, but are 3-4 times stronger, only need 4-6% moisture, and can be laid in the wall immediately after manufacture. Designed and built for trouble-free operation and easy maintenance, the low-profile Impact models need no special dirt-loading equipment and can be hauled by compact car or truck. Hydraulic power-take-offs run a dirt screen, available separately.

Instructions on machine operation and maintenance, soil analysis and preparation and suggested building systems are included with each machine.

The Terrablock System

When you're building from the ground up

"The Terrablock System of earth-wall construction is a process which I think will revolutionize the housing industry world wide. It is the ideal technique when you're building from the ground up."

Arnold Patoni

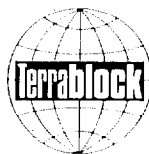

Once Terrablock walls have been built, a fast-drying chemical sealant is readily applied by brush, roller or sprayer. The walls are then ready for a finishing coat of plaster or other mortar, which can be finished in any texture or pattern desired. Protected in this way, the block wall remains stable.

The Terrablock is probably the most cost-effective wall building block in the world. The raw material is universally abundant and not likely to escalate in price. The production of Terrablocks is also efficient. Running on between 12 and 16 liters of fuel, the Terrablock Duplex can produce enough material to build the walls of a 12-foot square dwelling.

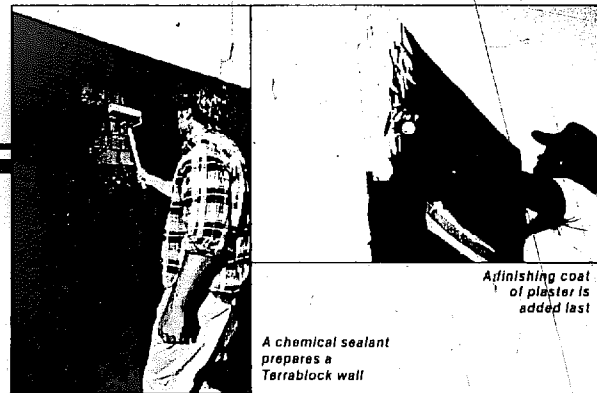

A finishing coat of plaster is added last

A chemical sealant prepares a Terrablock wall



Beautiful, practical, durable: A finished Terrablock structure

12-inch Terrablock walls are:

- Non-Toxic
- Sound Proof
- Chemically Stable
- Fireproof
- High Thermal Insulation Value
- Extremely Durable



Terrablocks: Common soil transformed into a building material of superb quality

The Terrablock System of earth-wall construction, commonly known as adobe, is probably the simplest and most cost effective home-building technique in the world. The Terrablock System virtually eliminates the labour intensive, time consuming drawbacks of adobe construction, whilst maintaining all of adobe's extraordinary properties and characteristics as a building material.

The Terrablock Duplex Machine

The key to the Terrablock System is the Terrablock Duplex Machine. This single piece of equipment transforms common soil into a building material of superb quality. The machine itself is compact, portable, uncomplicated, reliable, automatic and energy efficient.

The Terrablock Duplex uses hydraulic pressure, up to 4,875 P.S.I., to produce stable and dimensionally uniform blocks that can often go directly into a wall without any curing or drying time. Terrablocks can be grout-bonded, laid with a traditional mortar, or dry-stacked.

The Terrablock Duplex is self-contained, is easily towed, loaded with soil, and quickly put into operation on the construction site.

The Terrablock Duplex is simple to operate and maintain. Apart from its diesel power plant, it has only three main moving components. The entire production process is governed by a specially designed computer that controls sequence logic down to the millisecond. This computer is also self-diagnostic and monitors all functions.

Starting and operating is a simple one-man task. As long as the hopper remains loaded with soil, the Terrablock Duplex will automatically produce six to ten Terrablocks per minute, creating enough material in one hour to construct a 100 cubic foot (2.83 cm.) wall.

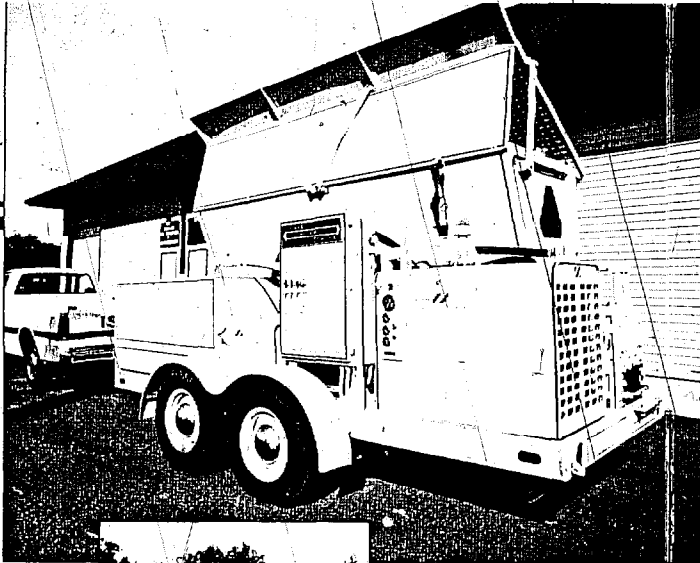

The fully portable Terrablock Duplex Machine...



makes earth-wall construction simple, quick and cost-effective

The hopper holds enough earth for ten minutes of continuous operation, and can be loaded by any method, from a crew with shovels to a front-end loading tractor. A heavy duty screen filters out foreign debris and large rocks; vibrating devices insure a consistent flow of soil into block moulds.

The Terrablock Duplex is powered by a 43 Horsepower Isuzu diesel engine, noted for its reliability, durability, and fuel efficiency. It can run continuously for an hour on approximately 3 liters of diesel fuel. It is equipped with a heavy duty heat exchanger to ensure reliable operation in extreme heat.

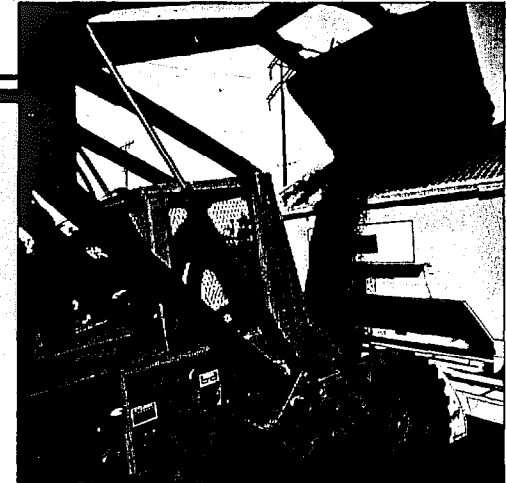

Loading the hopper. From a front-end tractor...

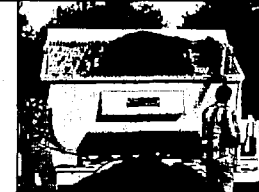

to a crew with shovels

Terrablocks: The End Product

Soil with a natural moisture content of 4 to 14% is ideal for the Terrablock System and can be hydraulically compressed into stable building units by the Terrablock Duplex Machine, usually without additives. It is estimated that 94% of all readily available soils fall within the acceptable range.

Terrablocks are easily lifted by specially designed tongs from the machine's conveyors directly into the wall, or, they can be stacked for future use. Since Terrablocks are dimensionally uniform and have a perfectly flat bedding surface, they can be dry-stacked, a technique that does not require a skilled mason or mortar, provided the blocks are properly levelled and set on a suitable footing.

Terrablocks. Dimensionally uniform and perfectly flat...

are easily lifted by gripping tongs to go directly into a wall...

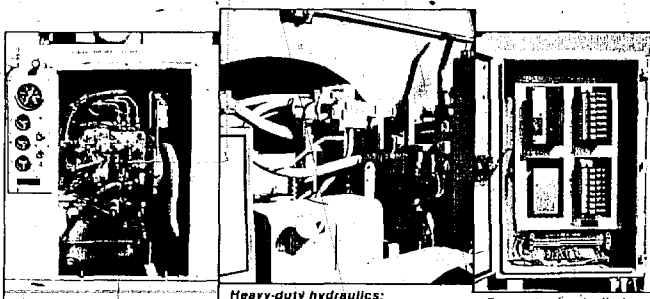
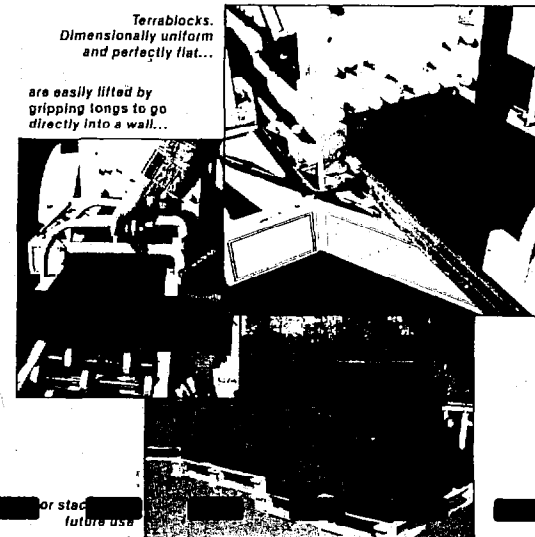

Isuzu 43 H.P. engine

Heavy-duty hydraulics: Rated for severe industrial use

Computer controlled, fully automatic operation

Features

- Fully automatic operation, controlled by Automate 15 computer.
- Hydraulic system has a capacity of 150 U.S. gallons (568 l.) of oil, continuously filtered to 10 microns by a permanent filter.
- Integrated hydraulic oil cooling system.
- All hydraulic components are industrial grade.
- Powered by 43 H.P. Isuzu diesel engine with a heavy-duty capacity radiator, specially fitted with integrated heat exchanger.
- All valves housed in heavy duty bronze with an internal chrome ball for long life.
- Permanent heavy duty grizzly screen on hopper filters out rocks and foreign debris.
- Two automatic vibrating devices keep soil moving at a constant rate through throat of hopper.
- Frame made of heavy wall tubing for extreme strength to weight ratio and rigidity.
- All welds are full periphery by metal inert gas process for superior strength and vibration resistance.
- Block molds heat treated to Rockwell R.C. 58 hardness for wear resistance.
- Tandem levelling axles with electric brakes.
- Four standard automotive wheels with heavy duty six-ply rated tires.
- Two ten foot skate wheel-type conveyors made of galvanized steel.
- Large volume built-in accessory compartment.
- Furnished with metric, fractional, and Allen wrenches.
- Finished in industrial white enamel for maximum solar reflection.
- Fully warranted free of defects in materials and workmanship when maintained per specifications for 1,000 hours of operation or six months.



Dimensions and Specifications

- Machine size: 17-feet (5.18m.) long by 7-feet 6-inches (2.29m.) high by 7-feet 10-inches (2.39m.) wide. Fits into standard size shipping container.
- Weight: Approximately 8,000 lbs. (3,629 kg.), excluding oil.
- Hopper capacity: 84 cubic feet (2.38 cm.).
- Hydraulic oil capacity: 150 U.S. gallons (568 l.).
- Hydraulic pressure: Variable from 1,180 P.S.I. to 1,875 P.S.I. (535 Kg./cm.² to 850 Kg./cm.²).
- Electrical system: 24 volt D.C. with two 12 volt storage batteries.
- Fuel consumption: Approximately 3 liters of diesel fuel per hour.
- Block size: Width, 12-inches; height, 4-inches. Both dimensions accurate to .005 inches. Entire block flat and square; length approximately 10-inches (250mm.).
- Rate of production: Finished Terrablocks produced at the rate of six to ten blocks per minute.



Robert Gross
Terrablock Director

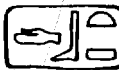

EARTH TECHNOLOGY CORP.
SOUTH ORANGE BUSINESS CTR

(305) 851-3287
TELEX: ETEC 567443

175 Drennen Rd.
Orlando, FL 32806

HANS SUMPFF Brick Machine

(Excerpt from Bibl. 16)

are to be out of service for any length of time.

The brick molding method used will depend on the availability of labor and its cost, and the production schedule required. In some labor intensive areas it is possible that hand molding with multiple forms might be acceptable. However, most large scale projects will require a mechanical molding machine. Although many different machine designs have been proposed for this purpose, the most efficient yet developed is the Sumpff Molding Machine invented by Mr. Hans Sumpff of Fresno, California (U.S. Patent 2,524,683, October 3, 1950). Figure 3 shows the plan of this machine. The machine is operated on a flat field area which has previously been scraped smooth. As the engine (8) moves the machine along, a sheet of paper (43) is rolled out on the soil surface to give a clean surface to the bricks that will be deposited on it (64). This paper, which is usually a kraft type, may not be needed in all situations. Other parting agents like straw or leaves spread on the surface could be used. The stabilized mud mix is placed in the hopper (31) by a small dump truck from the pug mill. The molding machine is stopped for a short period and the multi brick mold (24) is lowered hydraulically on to the paper covered soil. The hopper is then moved back and forth several times across the mold to

fill the cavities completely with mud mix and screed off the top to give a smooth surface. The mold is then lifted to leave a "nest" of bricks, and the machine is rolled ahead to a new spot and the process repeated. The mold is sprayed occasionally with water to eliminate any mud hanging up on the mold walls and to ensure the production of uniform bricks.

Many thousands of bricks can be produced each working day with this machine. It is important to note that the Hans Sumpff system for brick production is highly efficient and is designed so that soil, mud and bricks are moved the least possible amount. The bricks are turned on edge after a few days to speed drying, but are left in the field where they are cast until completely cured. The following pictures, Figure 4, show the Hans Sumpff plant in operation.

C. Bricks by Pressure Molding

We wish to consider this process separately from the conventional wet molding method because special techniques are required to use asphalt products as stabilizers in making pressed bricks. This is because pressure molding must use a soil mix that is relatively "dry," while conventional molding uses a much wetter mud mix. Generally portland cement is the best choice for compressed bricks as

Oct. 3, 1950

H. C. SUMPFF
BRICK MACHINE

2,524,633

Filed Dec. 16, 1946

4 Sheets—Sheet 2

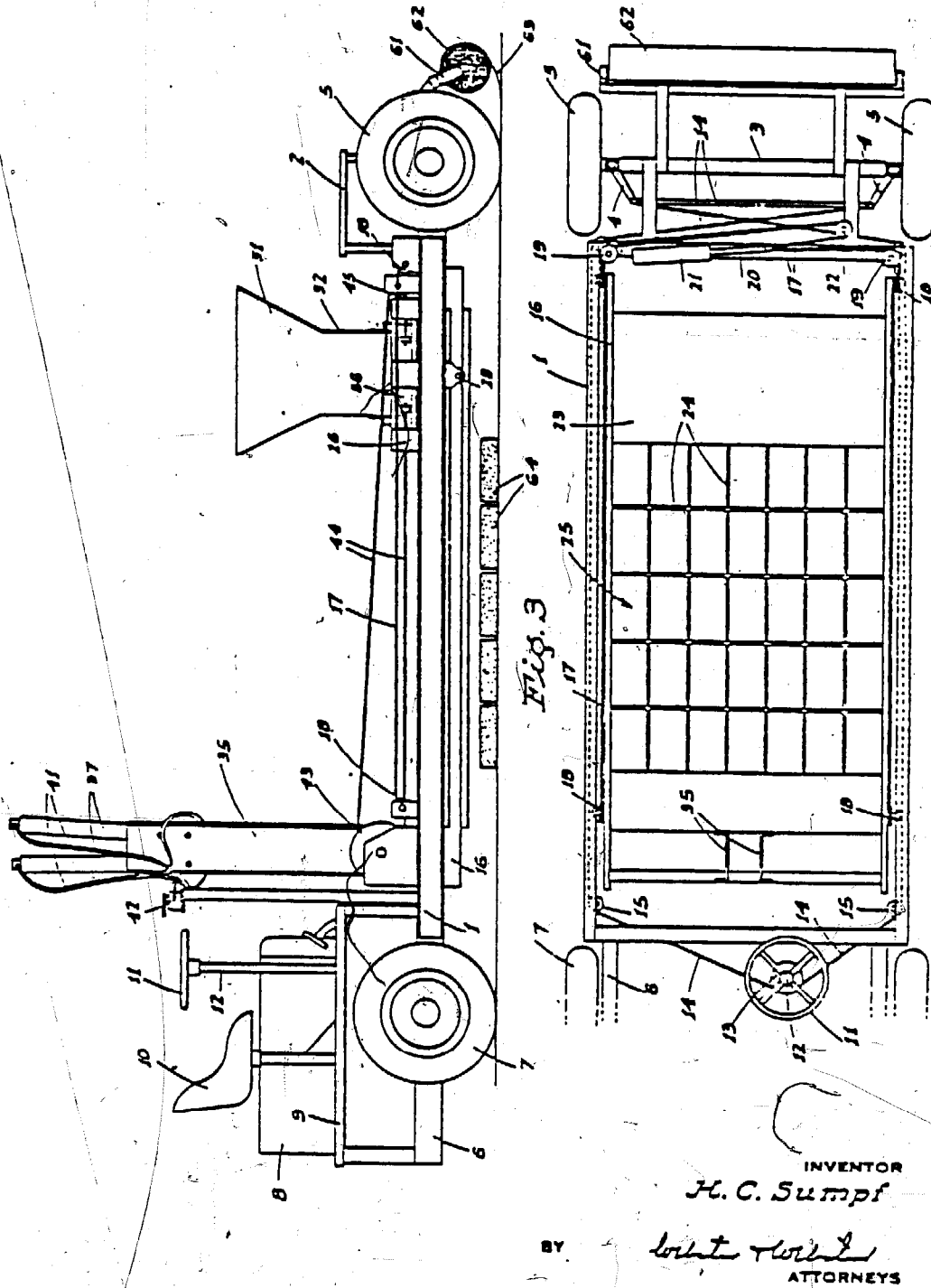

Figure 3. Brick Molding Machine



AUSTRALIAN ADOBE INDUSTRIES

General Manager: Ian Mills

TELEX AA 32271 Man Jud
TELEPHONE (052) 93018

JF/IM 001

January 2, 1985

Our machines are automatic, hydraulically controlled, and powered by a diesel or electric motor. They produce earth bricks stabilized with cement or lime or fly ash. The materials required are typically 95% soil, with a 15%-30% clay content, and 5% cement, which are readily available in any country. The stabilizing gives great strength (8.2 MPA average compressive strength) and durability, but bricks can be made from 100% soil unstabilized if stabilizers are unavailable or considered too expensive. Walls can then be sealed against weather with a variety of readily available sealants.

The machine can be mobile and is light enough to be towed anywhere by a four wheel drive. The main ram exerts 120 tons of pressure on each brick. Machines can be made to produce any size brick or one machine to produce a variety of sizes e.g. 12" x 10" x 5" (350/hour), 3" x 9" x 4" (1400 per hour), 2" x 10" x 5" (2000 per hour). The whole process is automatic and can be organised with as few as two people for the whole operation. Soil is fed in one end by a front end loader (or the machine can be designed for loading by a large team of labourers) and bricks emerge ready for use at the other end. Soil with a low moisture content (2-8%) is quite suitable and no firing is required.

The bricks are selling well in Australia. We are just commencing a project for the Fiji Housing Authority to build an initial 50 plus houses, but expect this to extend into many more with our special anti-hurricane anti-earthquake design for which our very dense bricks are particularly suitable. In the first six months of this year we expect to have machines also in India, China and Zimbabwe as we already have orders from those countries.

We are interested in co-operating with developing countries not only to supply the machines, but also to assist with any help required in the production of bricks and construction of shelter appropriate to whatever locality. The present cost of the machine is \$45,000 (Australian) ex factory.

Our main aim is to mass produce low cost housing in developing countries.

Suite 4, "Ormond House" 109 Yarra Street, Geelong, Australia, 3220
Head Office: 5 River Parade, Barwon Heads, Australia, 3227. Tel. (052) 54 2601

Addresses

ANNEX B

The following list of addresses is also the mailing list of this study. It includes a wide variety of institutions, in all parts of the world, comprising appropriate technology information centres, with question and answer services; education, training and research institutes that specialize in soil constructions, or generally in building in developing countries; development aid organizations; and publishers of journals and bulletins on appropriate technologies or Third World development issues in general.

Most of these institutions have been extremely cooperative and generously provided the author with information and advice, for which he is most grateful. Some of the other recipients did not respond to previous requests for information, but it is hoped that they will now be able to do so, or at least comment on this study. It is also hoped that this document, or parts of its contents, are passed on to other interested institutions and individuals, so that as many people as possible can benefit from it and possibly contribute further material for the final publication.

EUROPE

Federal Republic of Germany

- | | | | |
|-----|---|-----------------------|---|
| 001 | Ausbildungsverbund Metall
Bernhard-Adelung-Str. 42
6090 Rüsselsheim | 010 | International Institute for
Environment and Society (IIES)
Potsdamer Str. 58
1000 Berlin 30 |
| 002 | Deutscher Entwicklungsdienst (DED)
Kladower Damm 299 - 327
1000 Berlin 22 | 011 | Kreditanstalt für Wiederaufbau
Hauptabteilung Technik
Palmengartenstr. 5 - 9
6000 Frankfurt 11 |
| 003 | Deutsche Entwicklungshilfe für soziales
Wohnungs- und Siedlungswesen e.V.
(DESWOS)
Bismarckstr. 7
5000 Köln 1 | 012 | Misereor
Zentralstelle für Entwicklungshilfe e.V.
Mozartstr. 9
5100 Aachen |
| 004 | Deutsche Stiftung für
internationale Entwicklung (DSE)
Hans-Böckler-Str. 5
5300 Bonn 3 | 013 | Technische Hochschule Darmstadt
Fachgebiet Planen und Bauen in
Entwicklungsländern (FB Architektur)
Petersenstr. 15
6100 Darmstadt |
| 005 | Evangelische Zentralstelle für
Entwicklungshilfe e.V.
Mittelstr. 37
5300 Bonn 2 | 014 | Technische Universität Berlin
Planen und Bauen in Entwicklungs-
ländern (Sekt. A 53)
Straße des 17. Juni 150/152
1000 Berlin 12 |
| 006 | Gesamthochschule Kassel
Forschungslabor für experimentelles
Bauen
Menzelstr. 13
3500 Kassel | 015 | Technische Universität Hamburg-Harburg
Arbeitsbereich Städtebau III:
Objektbezogene Stadtplanung
Seminar: "Planen und Bauen in
Entwicklungsländern"
Schwarzenbergstr. 93c
2100 Hamburg 90 |
| 007 | Informationszentrum RAUM und BAU
der Fraunhofer-Gesellschaft
Nobelstr. 12
7000 Stuttgart 80 | 016 | Technische Universität München
Lehrstuhl für Städtebau, Orts- und
Regionalplanung
Seminar: "Planen und Bauen in
Entwicklungsländern"
Arcisstr. 21
8000 München 2 |
| 008 | Institut für Tropenbau
Waldschmidtstr. 6A
8130 Starnberg | 017 | Universität Hannover
Lehrgebiet für Industrialisierung
des Bauens (Seminar "Tropenbau")
Schloßwender Str. 1
3000 Hannover 1 |
| 009 | Institut Lehm- und
Benediktstr. 22
8911 Weil-Beuerbach | 018 | Universität Stuttgart
Institut für Baustofflehre, Bauphysik,
Technischen Ausbau und Entwerfen
Keplerstr. 11
7000 Stuttgart 1 |
| | | <u>United Kingdom</u> | |
| | | 019 | AHAS-Housing Advisory Services
P.O. Box 397
London E8 1BA |
| | | 020 | Building Research Station
Overseas Development Research Unit
Garston, Watford WD2 7JR |
| | | 021 | Intermediate Technology
Publications Ltd.
9, King Street
London WC2E 8HW |
| | | 022 | Intermediate Technology Development
Group
Myson House,
Railway Terrace
Rugby CV21 3HT |

- 023 International Year of Shelter
for the Homeless (IYSH)
London Office
3, Endsleigh Street
London WC1H 0DD
- 024 Oxfam
274, Banbury Road
Oxford OX2 7DZ
- 025 University College London
Bartlett School of Architecture
and Planning
Building Design for Developing
Countries
22, Gordon Street
London WC1H 0QB

France

- 026 Centre de Terre
Lavalette
31590 Verfeil
- 027 CRATerre
Les Rivaux
Haut-Brié
38320 Eybens/Grenoble
- 028 GRET
Groupe de Recherche et
d'Echanges Technologiques
30, rue de Charonne
75011 Paris
- 029 RILEM
12, rue Brancion
75737 Paris Cedex 15
- 030 UNESCO
Division of Technical Research and
Higher Education
7, Place de Fontenoy
75700 Paris

Belgium

- 031 AGCD
Belgian Administration for
Development Cooperation
5/57 place du Champs de Mars
1050 Bruxelles
- 032 ATOL
Aangepaste Technologie
in Ontwikkelingslanden
Blijde Inkomstraat 9
3000 Leuven
- 033 Commission Européenne
Direction Générale pour le Développement
200 rue de la Loi
1049 Bruxelles
- 034 COTA
Collectif d'Echanges pour la
Technologie Appropriée
Rue de la Sablonnière 18
1000 Bruxelles
- 035 Katholieke Universiteit Leuven
Post Graduate Centre Human Settlements
Kasteel Arenberg
3030 Leuven (Heverlee)
- 036 Université Catholique de Lovain
Centre de Recherches en Architecture
Place du Levant 1
1348 Louvain-la-Neuve

The Netherlands

- 037 CAT
Centre for Appropriate Technology
Delft University of Technology
P.O. Box 5048 / Stevinweg 1
2600 GA Delft
- 038 CIB
International Council for Building
Research Studies and Documentation
P.O. Box 20704
3001 JA Rotterdam
- 039 SATIS
Socially Appropriate Technology
International Information Services
Mauritskade 61a
1092 AD Amsterdam
- 040 TOOL
Stichting Technische
Ontwikkeling Ontwikkelingslanden
Entrepôtdok 68a/69a
1018 AD Amsterdam

Sweden

- 041 SADEL
Swedish Association for
Development of Low-Cost Housing
Arkitektur 1
P.O. Box 725
220 07 Lund
- 042 SIDA
Swedish International Development
Agency
Birger Jarlsgatan 61
105 25 Stockholm

Switzerland

- 043 The Aga Khan Award for Architecture
32 Chemin des Crêts
1218 Grand Saconnex
Geneva
- 044 ETH-Hönggerberg
Institut für Hochbautechnik
8093 Zürich
- 045 ILO
International Labour Office
Technology and Employment Branch
1211 Genève 22
- 046 SKAT
Schweizerische Kontaktstelle
für Angepaßte Technik
Varnbühlstr. 14
9000 St. Gallen

Austria

- 047 UNIDO
United Nations Industrial Development
Organization
Industrial Information Section
P.O. Box 300
1400 Vienna

Hungary

- 048 Hungarian Institute for Building Sciences
David Ferenc utca 6,
PO Box 71
1502 Budapest

N O R T H A N D S O U T H A M E R I C A

Canada

049 CIDA
Canadian International Development
Agency
200 Principle Street
Hull
Quebec K14 0G4

050 Mc Gill University
School of Architecture
Minimum Cost Housing Group
3480 University Street
Montreal 101, Quebec H3A 2A7

U.S.A.

051 Adobe Today
P.O. Box 702
Los Lunas NM 87031

052 Appropriate Technology International
1331 H Street, N.W.
Washington, D.C. 20005

053 Carnegie Mellon University
Department of Architecture
Pittsburgh PA 15213

054 Earth Systems Development Institute
P.O. Box 1217
Corrales, NM 87048

055 HUD
U.S. Department of Housing and
Urban Development
Office of International Affairs
Washington, D.C. 20410

056 Inter-American Development Bank
808, 17th Street, N.W.
Washington, D.C. 20577

057 International Association for the
Advancement of Appropriate Technology
for Developing Countries
University of Michigan
603 East Madison Street
Ann Arbor, Michigan 48109

058 IFEC
International Foundation for
Earth Construction
2501 M Street, N.W., Suite 450
Washington, D.C. 20037

059 Intertect
P.O. Box 10502
Dallas, TX 75207

060 Massachusetts Institute of Technology
Architectural Department
77 Massachusetts Avenue
Cambridge, Mass. 02138

061 National Academy of Sciences
2101 Constitution Avenue
Washington, D.C. 20418

062 TRANET
Transnational Network for
Appropriate Technology
Box 567
Rangeley
Maine-04970

063 Volunteers in Asia
Appropriate Technology Project
P.O. Box 4543
Stanford, CA 94305

064 UN Interim Fund on Science
and Technology for Development
United Nations
New York, NY 10017

065 VITA
Volunteers in Technical Assistance
1815 N Lynn Street, Suite 200
Arlington VA 22209 - 8438

066 The World Bank
Science and Technology Unit
1818 H Street, N.W.
Washington, D.C. 20433

Guatemala

067 CEMAT
Centro de Estudios Mesoamericano
sobre Tecnología Apropriada
Apartado Postal 1160
Guatemala Ciudad

068 CETA
Centro de Experimentación en
Tecnología Apropriada
15 ave. 14 - 61, Zona 10
Guatemala Ciudad

069 ICAITI
Instituto Centroamericano de
Investigación y Tecnología Industrial
Apartado Postal 1552
Guatemala Ciudad

El Salvador

070 CESTA
Centro Salvadoreña de Tecn.Apr.
Condominio Cuscatlán
306 - 25 AS y YCP
San Salvador

Panamá

071 Grupo de Tecnología Apropriada
Apartado 8046
Panamá 7

Dominican Republic

072 Ce TAViP
Centro de Tecnología Apropriada
para la Vivienda Popular
Apartado 20328
Santo Domingo

Barbados

073 CADEC
Caribbean Appropriate
Technology Centre
P.O. Box 616
Bridgetown

Colombia

074 SENA
Servicio Nacional de Aprendizaje,
Programa de Desarrollo Tecnológico
Apartado Aéreo 9801
Bogotá

Ecuador

- 075 CITA
Centro de Ingeniería para
Tecnologías Adecuadas
Casilla 1024
Cuenca
- 076 CATER
Centro Andino de Tecnología Rural
Casilla 399
Loja

Peru

- 077 CTA
Comisión de Coordinación de
Tecnología Andina
Av. Tullumayo 465
Cusco

Bolivia

- 078 SEMTA
Servicios Múltiples de
Tecnologías Apropriadas
Casilla Correo 20410
La Paz

Paraguay

- 079 CTA
Centro de Tecnología Apropriada
Universidad Católica
Casilla de correos 1718
Asunción

Brazil

- 080 CEPED
Centro de Pesquisas e Desenvolvimento
Km O da BA - 536
Camacari / Bahia

Chile

- 081 CETAL
Centro de Estudios de Tecnología
Apropriada para América Latina
Casilla 197-V
Valparaiso

A F R I C A

Algeria

- 082 Département d'Architecture
Centre Universitaire de Mostaganem
BP 227
Mostaganem

Tunisia

- 083 Ministère de l'Equipement et de l'Habitat
Cité Jardin
Tunis

Senegal

- 084 ENDA - TM
Environnement Développement Action
dans le Tiers Monde
B.P. 3370
Dakar

Burkina Faso (Upper Volta)

- 085 ADAUA
Association pour le Développement Naturel
d'une Architecture et d'un Urbanisme
Africains
B.P. 648
Ouagadougou

Ivory Coast

- 086 Banque Africaine de Développement
B.P. 1387
Abidjan 01

Ghana

- 087 Department of Housing and Planning
Research
Faculty of Architecture
University of Science and Technology
P.O. Box 40
Kumasi

Togo

- 088 CCL
Centre de l'Construction et du
Logement à Ca'cavelli
B.P. 1762
Lomé

Cameroon

- 089 APICA
Association pour la Promotion des
Initiatives Communautaires Africaines
B.P. 5946
Douala Akwa

Sudan

- 090 Housing & Engineering Unit
National Council for Research
PO Box 6094
Khartoum

Zaire

- 091 CEPAS/INADES-Formation
Centre d'Etudes pour l'Action Sociale
B.P. 5717
Kinshasa - Gombé

Burundi

092 Département de l'Habitat Rural
Ministère du Développement Rural
B.P. 2740
Bujumbura

Kenya

093 HRDU
Housing Research and Development Unit
University of Nairobi
P.O. Box 30197
Nairobi

094 UN Centre for Human Settlements
P.O. Box 30030
Nairobi

Tanzania

095 CAMERTEC
Centre for Agricultural Mechanization
and Rural Technology
P.O. Box 764
Arusha

Zambia

096 Human Settlements of Zambia
PO Box 50141
Lusaka

097 TDAU
Technology Development and
Advisory Unit
University of Zambia
P.O. Box 2379
Lusaka

Botswana

098 Botswana Technology Centre
P/Bag 0082
Gaborone

South Africa

099 National Building Research Institute
P.O. Box 395
Pretoria 0001

A S I A

Saudi-Arabia

100 Islamic Development Bank
P.O. Box 5925
Jeddah 21432

Pakistan

101 ATDO
Appropriate Technology Development
Organization
Ministry of Science & Technology
1 - A & B 47th Street, F -7/1
Islamabad

India

102 CBRI
Central Building Reserach Insitute
Roorkee 247 667

103 CORT
Consortium on Rural Technology
A - 89 Madhuvan
New Delhi 110 092

104 CSE
Centre for Science and Environment
807 Vishal Bhawan
95 Nehru Place
New Delhi 110 019

105 Development Alternatives
22 Palam Marg
Vasant Vihar
New Delhi 110 057

106 National Building Organization
"G" Wing, Nirman Bhavan
Maulana Azad Road
New Delhi 110 011

107 ATDA
Appropriate Technology Development
Association
P.O. Box 311
Gandhi Bhawan
Lucknow 226 001

108 CSV
Centre of Science for Villages
Magan Sangramalaya
Wardha 442 001

109 Asian and Pacific Centre for
Transfer of Technology
P.O. Box 115
Bangalore 560 052

110 ASTRA
Indian Institute of Science
Mallesinaram
Bangalore 560 012

Nepal

111 RECAST
Research Centre for Applied
Science and Technology
Tribhuvan University
Kirthipur, Kathmandu

Sri Lanka

112 Sarvodaya Shramadana Movement
77 De Souza Road
Moratuwa

Thailand

- 113 Asian Institute of Technology
Human Settlements Development Division
G.P.O. Box 2754
Bangkok 10501
- 114 TISTR
Thailand Institute of Scientific and
Technological Research
196 Phahonyothin Bang Khen
Bangkok 9

China

- 115 Architectural Society of China
Baiwanzhuang
Beijing

O C E A N I A

Philippines

- 116 PCATT
Philippine Centre for Appropriate
Training and Technology
Manila Suite
1416 F. Felipe Agoncillo St.
Ermita, Metro Manila
- 117 Asian Development Bank
2330 Roxas Boulevard
P.O. Box 789
Metro Manila

Indonesia

- 118 UN Regional Housing Centre
84 Jalan Tamansari
Bandung
- 119 Yayasan Dian-Desa
Jalan Kaliurang Km 7
P.O. Box 19
Bulaksumur, Yogyakarta

Papua New Guinea

- 120 SPATF
South Pacific Appropriate
Technology Foundation
P.O. Box 6937
Boroko

Tonga

- 121 Rural Development Centre
University of the South Pacific
P.O. Private Bag
Nuku 'alofa

Australia

- 122 Department of Architecture
University of Queensland
St. Lucia, Queensland 4067
- 123 Experimental Building Station
Department of Construction
P.O. Box 30
Chatswood, N.S.W. 2067

Bibliography

ANNEX C

(E)=English;(G)=German;(F)=French;(S)=Spanish

- 01 ADAUA (Association pour le developpement naturel d'une architecture et d'une urbanisme Africains): Dossier Presses, Versoix-Genève, 1977 (F)
- 02 Agarwal, Anil: Mud, Mud - The potential of earth-based materials for Third World housing, Earthscan/International Institute for Environment and Development, London, 1981 (E)
- 03 Bardou, P.; Arzoumanian, V.: Archi de Terre, Parenthèses, Marseille, 1978 (F)
- 04 CIB (International Council for Building Research Studies and Documentation) / RILEM (International Union of Testing and Research Laboratories for Materials and Structures): Appropriate Building Materials for Low Cost Housing, Volumes 1 and 2, E. & F.N. Spon Ltd, London, 1984/85 (E,F)
- 05 Concrete Association of India: Low-Cost Soil-Cement Houses, The Concrete Association of India, Bombay, 1966 (E)
- 06 CRATerre (Centre de recherche et d'application - terre: P. Doat, A. Hays, H. Houben, S. Matuk, F. Vitoux): Construire en terre, éditions alternatives, Paris, 1983 (F)
- 07 Dansou, P.A.: La Terre Stabilisée, Planification Habitat Information (No.76) S.M.U.H. (Secrétariat des Missions d'Urbanisme et d'Habitat), Paris, 1984 (F)
- 08 Dethier, Jean: Down to Earth: Mud Architecture - an old idea, a new future, Thames and Hudson, London, 1982 (E)
- 09 Denyer, Susan: African Traditional Architecture, Heinemann, London, 1978 (E)
- 10 Department of Housing and Urban Development: Earth for Homes, HUD, Washington, D.C., 1955 (E)
- 11 Department of Housing and Urban Development: Mud Brick Roofs, HUD, Washington, D.C., 1959 (E)
- 12 Duly, Colin: Houses of Mankind, Thames and Hudson Ltd, London 1979 (E)
- 13 Dye, John R.: Assembly Manual for the Tek-Block Press, Department of Housing & Planning Research, Faculty of Architecture, University of Science and Technology, Kumasi, Ghana, 1975 (E)
- 14 Ebert, Wolfgang: Home Sweet Dome - Träume vom Wohnen, Dieter Fricke GmbH, Frankfurt am Main, 1978, (G)
- 15 Fathy, Hassan: Architecture for the Poor - An Experiment in Rural Egypt, The University of Chicago Press, Chicago, 1973 (E)
- 16 Ferm, Richard: Stabilized Earth Construction - An Instructional Manual, The International Foundation for Earth Construction, Washington, D.C., October 1985 (E)
- 17 GATE (Ed.): Lehmarchitektur, Rückblick - Ausblick, Proceedings of a Symposium, held in Frankfurt in March 1982, Aus der Arbeit von GATE, Eschborn, 1982 (G)
- 18 Ghavani, K.; Fang, H.Y. (Editors): Low-Cost and Energy Saving Construction Materials, Vol. 1 (Int. Conference, Rio de Janeiro, Brazil, 9-12 July 1984), Envo Publishing Company Inc. 1984 (E)
- 19 Gieth, Thomas: Construction of Low-Cost Dwellings with Compacted Soil Blocks (Prototype "A"), C.T.A., Catholic University, Asunción, 1984 (E)
- 20 Gieth, Thomas: Bloquera del C.T.A., Boletín No. 2, C.T.A., Catholic University, Asunción, 1985 (S)
- 21 Grasser, Klaus; Mukerji, Kiran: Minimum Cost Housing Construction in El Salvador, Project report of the Institut für Tropenbau, Dr. Ing. G. Lippsmeier, Starnberg, in cooperation with FSDVM and CIG, San Salvador, Aus der Arbeit von GATE, Eschborn, 1981, (E, G, S)
- 22 Hammond, A.A.: Prolonging the Life of Earth Buildings in the Tropics, Building Research and Practice (May/June 1973), Building and Road Research Institute, UST Kumasi, 1973 (E)
- 23 Hecht, Hans: Instructions for Building and Using an Earth and Loam Brick Press (built by CENEEMA, Yaoundé/Cameroon), GATE-Modul D 6/12, Eschborn, 1979 (E,G,F)
- 24 Institution of Civil Engineers: Appropriate Technology in Civil Engineering, Proceedings of conference, April 1980, Thomas Telford Ltd, London, 1981 (E)
- 25 Jagadish K. S.; Venkatarama Reddy, B. V.: A Manual of Soil Block Construction, Alternative Buildings Series - 1, Centre for Application of Science and Technology for Rural Areas (ASTRA), Indian Institute of Science, Bangalore, January 1981 (E)
- 26 Kahn, Lloyd (Editor): Shelter, Shelter Publications, Bolinas, Calif. 1973 (E)
- 27 Kahn, Lloyd (Editor): Shelter II, Shelter Publications, Bolinas, Calif. 1978 (E)
- 28 Lander, Helmut; Niermann, Manfred: Lehm-Architektur in Spanien und Afrika, Karl Robert Langewiesche Nachfolger Hans Köster, Königstein im Taunus, 1980, (G)
- 29 Lola, Carlos R.: Research Efforts on Soil Cement Stabilization for Low-Cost Housing in Nicaragua, University of Tennessee, Knoxville, December 1981 (E)
- 30 Lola, Carlos R.: ADAUA Earthen Construction Techniques, AT International, Washington D.C., September 1983 (E)
- 31 Lou Má, Roberto E.: La Ceta-Ram, Una máquina para producir bloques huecos de suelo - cemento, inspirada en el diseño de la Cinva-Ram, CETA (Centro de Experimentación en Tecnología Apropiada), Guatemala, February 1977 (S,E)
- 32 Lunt, M.G.: Stabilized Soil Blocks for Building, Overseas Building Note No. 184, Building Research Establishment, Garston, February 1980 (E)

- 33 Marciano, Michel: Dossier Presses a Briques, Groupe de Recherche et d'Echanges Technologiques (GRET), Paris, August 1985, (F)
- 34 McHenry, Jr. Paul Graham: Adobe and Rammed Earth Buildings - Design and Construction, John Wiley & Sons, New York, 1984 (E)
- 35 MINKA 9: Casas de Tierra, Grupo Talpuy, Apartado 222, Jr. Cusco No. 237 - 40. piso, Huancayo, Peru, October 1982 (S)
- 36 Minke, Gernot: Alternatives Bauen, Report on the work of the Research Laboratory for Experimental Building, University of Kassel, Ökobuch Verlag, Grebenstein, 1980 (G)
- 37 Minke, Gernot: Lehmbauforschung, Development and Testing of partially mechanized rammed earth and wet soil techniques, Schriftenreihe Heft 8, Fachbereich Architektur, Gesamthochschule Kassel, 1984 (G)
- 38 Minke, Gernot (Ed.): Bauen mit Lehm, Journal on Building with soil, Reports on new developments, research studies and building projects, Ökobuch Verlag Grebenstein/Freiburg, 1984/1985 (G)
- 39 Mukerji, K.; Sulejman-Pasic, N.; Murison, H.S.; Hockings, J.E.: Prefabrication for Low-Cost Housing in Tropical Areas, I.F.T. Report 4, Institut für Tropenbau, Dr. Ing. G. Lippsmeier, Starnberg, 1975 (E,G)
- 40 Mukerji, K.; Bahlmann, H.: Laterite for Building, I.F.T.-Report 5, Institut für Tropenbau, Dr. Ing. G. Lippsmeier, Starnberg, 1978 (E,G)
- 41 Mukerji, K.; Whipple, J.H.; Castillo Escobar, R.: Roof Constructions for Housing in Developing Countries, Research Report of the Institut für Tropenbau, Dr. Ing. G. Lippsmeier, Starnberg, in cooperation with ICAITI, Guatemala, Aus der Arbeit von GATE, Eschborn, 1982 (E,G)
- 42 Niemeyer, Richard: Der Lehm- und seine praktische Anwendung, Nachdruck des Originalwerks aus dem Jahre 1946, Ökobuch Verlag, Grebenstein, 1982 (G)
- 43 Oliver, Paul (Editor): Shelter and Society, Barrie and Jenkins Ltd, London, 1969 (E)
- 44 Oliver, Paul (Editor): Shelter in Africa, Barrie and Jenkins Ltd, London 1971 (E)
- 45 Paillon, R.: Development of the Tek-Block Press, Artikel in Research Bulletin No. 1, Triannual Publication of the Department of Housing & Planning Research, Faculty of Architecture, UST Kumasi, May 1972 (E)
- 46 Pollack, E.; Richter, E: Technik des Lehmbaus, Grundlagen für Entwurfsbearbeitung, Bauleitung und Ausführung, Band I, Verlag Technik, Berlin, 1952, (G)
- 47 Popposwamy (alias Reinhold Pingel): Village Houses in Rammed Earth - an Indian Experiment, Reihe dū scriptum, Dienste in Übersee, Stuttgart, 1980 (G,E,F)
- 48 Riedijk, W. (Edit.): Appropriate Technology for Developing Countries, Delft University Press, Delft, 1984 (E)
- 49 Rudofsky, Bernard: Architecture without Architects, The Museum of Modern Art, New York, 1965 (E)
- 50 Rudofsky, Bernard: The Prodigious Builders, Secker + Warburg, London, 1977 (E)
- 51 Rybczynski, Witold: Paper Heroes, A review of Appropriate Technology, Prism Press, Dorchester, 1980 (E)
- 52 SADEL: Blockmaking Machines for Soil Blocks, Swedish Association for Development of Low-Cost Housing, Lund, 1983 (E)
- 53 Saini, B.S. Building Environment - An Illustrated Analysis of Problems in Hot Dry Lands, Angus and Robertson Pty.Ltd., Sydney, 1973 (E)
- 54 Schneider, Jürgen: Am Anfang die Erde - Sanfter Baustoff Lehm, Das Buch zur ZDF-Sendung im Februar 1985, Edition Fricke, Verlagsgesellschaft Rudolf Müller Köln, 1985 (G)
- 55 Schreckenbach, Hannah; Abankwa, Jackson, G.K.: Construction Technology for a Tropical Developing Country, Deutsche Gesellschaft für Technische Zusammenarbeit (GTZ) GmbH, Eschborn, 1983 (E)
- 56 SISD: Production of Dirt-Cement Bricks, by the Use of a Brick Presser, Southern Institute for Skill Development, Thai-German Project, Songkhla, 1984 (E)
- 57 SKAT: Soil Block Making Equipment, Compilation of material on some well-known systems, machines and equipment, Working Paper 05/84, Schweizerische Kontaktstelle für Angepaßte Technik, St. Gallen, November 1984 (E,F,S)
- 58 Spence, Robin: Making Soil-Cement Blocks, The Technical Services Branch, Commission for Technical Education and Vocational Training, University of Zambia, Private Bag RW 16, Lusaka. (E)
- 59 Spence, R.J.S.; Cook, D.J.: Building Materials in Developing Countries, John Wiley & Sons, Chichester, 1983, (E)
- 60 Stulz, Roland: Appropriate Building Materials, A Catalogue of Potential Solutions, SKAT (Swiss Center for Appropriate Technology), St. Gall, and Intermediate Technology Publications Ltd., London, 1981 (E)
- 61 UNIDO: Appropriate Industrial Technology for Construction and Building Materials, Monographs on Appropriate Industrial Technology, No. 12, United Nations, New York, 1980 (E)
- 62 United Nations: Soil Cement - Its Use in Building, (compiled by Rafael Mora-Rubio), United Nations, New York, 1964 (E)
- 63 Venkatarama Reddy B.V.; Jagadish, K.S.; Nageswara Rao, M.: The Design of a Soil Compaction Ram for Rural Housing, Alternative Buildings Series - 4, ASTRA; Indian Institute of Sciences, Bangalore, April 1981 (E)
- 64 VITA: Making Building Blocks with the CINVA-Ram Block Press, Volunteers in Technical Assistance, Mt. Rainier, 1977, (E)
- 65 Volhard, Franz: Leichtlehm- und alter Baustoff - neue Technik, Verlag C.F. Müller, Karlsruhe, 1983 (G)
- 66 Vorhauer, Klaus: Low Cost/Self Help Housing, GATE-Modul 6/6, Eschborn, 1979 (E)
- 67 Webb, David J.T.: Stabilized Soil Construction in Kenya, Proceedings of the International Conference "Economic housing in developing countries: materials, construction techniques, components", RILEM, Paris, 25-27 January 1983 (E)
- 68 Wolfskill, L.A.; Dunlap, W.A.; Gallaway, B.M.: Earthen Home Construction, A field and library compilation with an annotated bibliography, Texas Transportation Institute, College Station, 1962 (E)

--	--	--

Please fill in and return to :

Dipl.Ing. Kiran Mukerji
 Planning and Building in the Tropics
 Wittelsbacherstr. 14
 8130 S t a r n b e r g
 Federal Republic of Germany

Name and address
 of institution

.....

Department and
 person-in-charge

We have received your report on "Soil Block Presses" (Aus der Arbeit von GATE, February 1986) and wish to make

- no comments.
- the following comments :

.....

.....

.....

.....

.....

.....

.....

.....

.....

.....

(If the space is not sufficient, please use the reverse side of this form, or add extra sheets. In case printed material is being sent separately, please mention briefly what it is).

Date Signature