

Farming after a Nuclear War

At one time, almost every home was a little farm. Everyone had a garden and a few chickens. It is a life-style now unknown to present city dwellers but still present to some degree with our village neighbors. It is a life-style to which many will probably return and the purpose of these pages is to help that transition. This is our own little greenhouse.



Table of Contents:

[Library: Gathering Resources for After a Nuclear War.](#)

This web page deals with the technical aspects of farming such as seed saving, fertilizers, crop management and so forth. Other web pages in the hierarchy above this one deal with measuring radiation

in food, alternate energy sources, and other subjects necessary to successful farming.

Farm1: Protection of Food and Agriculture From Nuclear Attack

(In .pdf format.)

This 42 page booklet was the US Department of Agriculture comprehensive attempt to prepare the farmer for nuclear attack. It contains much important information.

Farm2: Fallout on the Farm

(In .pdf format.)

This 14 page booklet is by the Canadian Government and has useful information about crop alternatives after a nuclear war, the handling of animals exposed to fallout, and many other items of information.

More: The Have More Plan

(In .pdf format.)

The "Have-More" Plan (A Little Land - A Lot of Lving) by Ed and Carolyn Robinson is a 1940 classic devoted to the creation of a small farm. It is a bit dated in its view of DDT but generally may be exceptionally useful to those who are inexperienced and are trying to to start.

Seeds: Basic Seed Saving

(In .pdf format.)

6 pages in .pdf format from Seeds of Diversity.

Humanure: Humanure Handbook

This 200 page book - winner of *many* awards is placed here through the kind permission the author Joseph Jenkins. It can be obtained in print at Jenkins Publishing, PO Box 607, Grove City, PA 16127. To order, phone: 1-800-639-4099. <http://www.jenkinspublishing.com/> .

Humanure: The Handbook available in .pdf format.

Mulch: Explains organic composting.

(In .pdf format.)

This 30 year old 101 page book gives information about mulching.

Fences: Fence Planner for the Common Sense Fence

(In .pdf format.)

This 12 page booklet gives information about wire fences, barbed, stranded, and electric. There are other kinds.

[Seed Presses](#) [Pressing Oil from Seeds](#)

This 24 page .pdf file lists 56 oil bearing seeds and discusses a variety of methods for extraction and processing. These oils can be used either for food or fuel.

The books below this level are copyrighted and will be available (if there is enough Internet to disseminate them) after the nuclear war - when surely no one will object. The information here will indicate the types of information that you might be interested in gathering into your own library ahead of time.

[Ark: Build Your Ark](#)

(In .pdf format.)

"Build Your Ark" (How to Prepare for Self-Reliance in Uncertain Times) by Geri Welzel Guidetti. Published by: The Ark Institute, P.O. Box 364, Monkton, MD 21111, email arkinst@concentric.net : This 248 page Book One on Food Self-Sufficiency covers basic concepts on gardening and goes into detail on soil improvement and insect control. Details are provided on a wide variety of garden vegetables.

[Farmstead: The Farmstead Book](#)

(In .pdf format.)

"The Farmstead Book 1" edited by Paul Harmond and is Published in the US by: Cloudburst Press of America, Inc. 2116 Wetern Avenue, Seattle, Washington 98121 and in Canada by: Cloudburst Pres Ltd., Mayne Island British Columbia V0N 2J0 - This 262 page Book covers soil and woods management on a more macro level than the book above and also covers the farm machine shop.

[Taste: Like They Used To Taste](#)

(In .pdf format.)

"Grow Friuts & Vegetables The Way They Used To Taste" by John F. Adams published by Wynwood Press - New York, New York. This 104 page book deals somewhat with vegetables and seed saving but is more largely devoted to fruit trees.

[Seeds: Saving Seeds](#)

(In .pdf format.)

"Saving Seeds" (The Gardener's Guide to Growing and Storing Vegetable and Flower Seeds) by Marc Rogers and published by Storey Communications, Inc. Pownal, Vermont 05261. 97 pages.

Click here to return to the
[Individual Agricultural Recovery
After Nuclear Holocaust](#)

Overview

Gathering information Resources for Farming After a Nuclear War

This web page deals with the technical aspects of farming such as seed saving, fertilizers, crop management and so forth.

Other web pages, in the previous table of contents in the hierarchy above this one, deal with measuring radiation in food, alternate energy sources, and other subjects necessary to successful farming.

Still other web pages, in the previous table of contents in the hierarchy above this one, deal with old Pioneering skills. There may be some overlap between those and these immediate pages but it is well to look at both of them for what may be start up farming without access to all the present modern technology.

We cannot just go back to the old ways. We have lost many of the skills. No one had them all then and you would be hard put today to find a wheelwright, a miller, a tanner, a barrel maker. All those trades, like farming have advanced into modern technology and the present experts seldom have used the old ways. Many of the old implements are no longer around and we certainly don't have the horses. Modern horses are neither bred nor conditioned to pull the plow. Still, in the skills of the past we may find solutions to the problems of the moment.

Our personal library is very extensive. At one time I counted 13 encyclopedias. These are mostly specialized - like a 14 volume set on gardening and another 16 volume set on do-it-yourself repairs. There are others on health and medicine and a variety of other subjects.

We have also acquired CDs with hundreds of books and one summer put a crew to work microfilming thousands of documents which we have on microfiche. These, plus many many books, are in just our own home but our Ark Two Community librarian is the real gatherer of information - he has many thousands of books, mostly on technology for recovery.

In the future, when people want it, we hope to be able to disseminate all this information widely. There are many blind spots in our library. We have little information on modern technology and almost no information on leading edge technology. Members of our Ark Two community are of far more than average knowledge about nuclear and computers but there are many, many fields such as in modern metallurgy, petroleum refining, hundreds of specialties in chemistry, medicine, and untold numbers of

other areas that the expertise to re-establish them will have to survive with the experts - if they are going to be recovered in the immediate decades following.

One major focus of our library has been maps, in order to determine where that expertise may reside. We have thousands of maps. Local road maps. Topographical maps. More and more maps on an expanding scale. We have every map ever published by the National Geographic. We have CDs with map search programs. North American and World Atlases. The list goes on. One map set which we were very desirous of obtaining cost thousands of dollars (far beyond our budget) from the US government. It comes with a subscription program for real-time updating and the printed book is reprinted annually. A marvelous tool for demographers tracking changing patterns - but one copy would serve our purposes. Amazingly, we found one on the Internet - at a fraction of the cost.

Other associates of ours are providing us with gigabytes of survival information on CDs. Our problem has not been so much one of obtaining information but determining which areas on which to concentrate our limited resources for storing and cataloging. Tons of information is of no use, if you have no way of finding what you want in it. In early years we were given literally tons of books by libraries and publishers. Expensive volumes that cost over hundreds of dollars each - but we finally had to abandon that effort simply because of lack of storage space and manpower to handle it. We passed on trailer loads of books.

So the problem of the moment has not been getting information but one of determining which information is going to be most useful to survivors. These have been our choices. What we offer in these pages, measuring radiation contamination in food, producing food without the modern technology and its skills, finding alternate sources of energy, recovering and repairing remaining machinery, creating the nucleus of an economic system and restoring the basis of functioning society - information on how to do these things are what we feel will be most needed at the outset. It is our sincerest hope that we will be able to get it to the people who need it and that they will find it useful.

Click here to return to the
[Table of Contents](#)

MENU: [HOME](#) » [Reconstruction](#) » [Recovery](#) » [Renewal](#) » [Survival](#)

Embedded Secure Document

The file *file:///C:/CDROMs/SCDR-2/Prophecykeepers/POST-NUCLEAR-WAR/b_recovery/2_farm_recovery/ftpfiles/protection.pdf* is a secure document that has been embedded in this document. Double click the pushpin to view.



Embedded Secure Document

The file *file:///C:/CDROMs/SCDR-2/Prophecykeepers/POST-NUCLEAR-WAR/b_recovery/2_farm_recovery/ftpfiles/fallout_on_the_farm.pdf* is a secure document that has been embedded in this document. Double click the pushpin to view.



THE "HAVE-MORE" PLAN

"A LITTLE LAND— A LOT OF LIVING"

How to Make a Small Cash Income
Into the Best and Happiest Living
Any Family Could Want

BY

Ed and Carolyn Robinson

- Buying a Place in the Country
- Laying Out a Homestead
- Remodeling or Building a House Designed for Country Living
- Part-time Farm Pays for Itself
- A Good Garden with Less Work
- Building a Small Barn
- Earning Money in the Country
- Dwarf Fruit Trees and Berries
- Fish Pond in Your Backyard
- Starting Right with Poultry, Rabbits, Milk Goats or Cow, Bees, etc., etc.

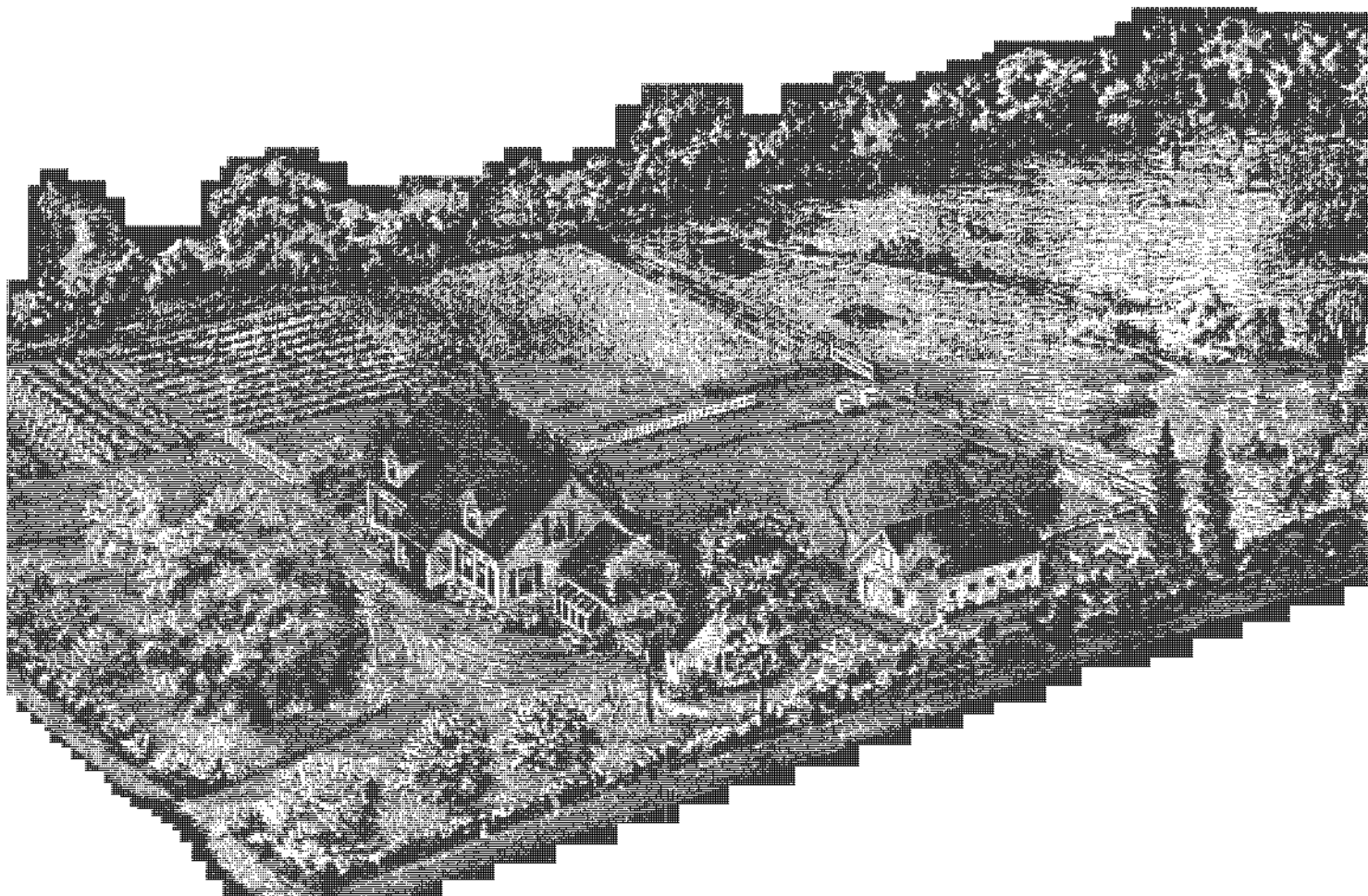

Dear Reader,

Garden Way Publishing Co. is the successor to the Noroton Country Bookstore and we are pleased to make the original "Have-More" Plan by Ed and Carolyn Robinson available again.

This classic book was written in the 1940's by leading experts of the day, to aid the individual in his search for self-sufficiency and independence on a country acre. We have reissued this work unchanged because it is still one of the best references available for the home gardener and homesteader. After all, poultry, goats, lettuce and home canning haven't changed much in a generation. It's no wonder the "Have-More" Plan has been in constant demand since it was first published. It will show you how to do things in ways that work superbly.

There are, however, just a few items mentioned such as the use of pesticides containing DDT, which we trust you will excuse and overlook. Three decades ago our understanding of such hazards was non-existent. We can help you, through our other publications, to learn more about non-toxic materials and techniques.

Many of the bulletins and books that were developed from the "Have-More" Plan are available once again directly from us. Please write to Garden Way Publishing, Charlotte, Vermont 05445 for our free book catalog which lists the "Have-More" Plan bulletins and books, as well as the most current books by all publishers that we feel to be the best on gardening and country living.

Please do feel free to contact me for any help I can be in your quest for "A Little Land—A Lot of Living".

Sincerely,

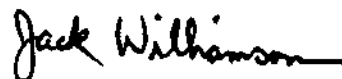
A handwritten signature in cursive script that reads "Jack Williamson".

Jack Williamson
Publisher

Contents

Chapter	Page
1 Why We Moved To The Country	2
2 A Letter To Wives	5
3 What Sort Of A Place In The Country Do You Want?	6
4 Setting Up A Homestead	7
5 Houses Especially Designed For Country Living	9
6 Plan A "Harvest Room" With Your Wife	10
7 Finding A Suitable Place	11
8 A Little House Can Grow	12
9 Score Card Of What To Look For In A "Have-More" Homestead	13
10 Water, Sanitation, Electricity, Roads	14
11 Landscape Your Place—Increase The Value 20%	16
12 Plans For A Small Barn	18
13 The Importance Of Raising Part Of Your Family's Food	20
14 A Good Garden With A Lot Less Work	21
15 Vegetable Planting Chart	24
16 Herbs	25
17 The Kind Of Berries And Grapes Money Can't Buy	26
18 Two Ways To Have Tree Fruits On A Small Place	28
19 Fresh Eggs From Your Own Hens	30
20 New Easy Way To Raise Tender Chicken	32
21 Geese Grow On Grass	34
22 Turkeys Can Be a Profitable Side Line	36
23 Ducks Are Easy To Raise	38
24 Squab	40
25 Rabbit—8 To 14 Cents A Pound	42
26 Ham, Bacon, Pork, Lard	44
27 The Miniature Dairy	46
28 (a) The Modern Dairy Goat	47
29 (b) A Family Cow	50
30 A Few Sheep For The Small Place	52
31 Veal and Beef On The Homestead	53
32 Our Little Sugar Factory	54
33 Have More In Winter Too!	56
34 Winter Gardens—Cold Frames, Hot Beds, Small Greenhouses	60
35 Grow Your Own Fish	61
36 The Woodlot	62
37 Transportation And Power	63
38 Housekeeping On A Homestead	64
39 Homestead Mechanics	66
40 Earning A Living In The Country	69
41 The Country Bookstore	70
42 Let's Rebuild America	72

Why We Moved to the Country and What We Set Out to Accomplish



CAROLYN, our son Jackie, and I haven't any land to sell—we aren't promoting anybody's products. We just want to tell you

some things we learned about how to have more fun, more health and more security than 99% of the people in this world ever had before.

Back in 1942, we Robinsons lived in a big apartment house in New York. Far from having all the conveniences and easy living you are supposed to have in a big city, we discovered we had very little.

In the first place, we always felt restricted. Living in the city wasn't easy, it was difficult. And every time we turned around—it cost us money.

For example, just to let the baby walk or play outdoors cost us money and trouble. First, we had to dress the baby nice (because we were going to the park), then get together blankets, diapers, his toys, etc., carry all this and the baby out to the elevator, wait until the elevator came for us, then outside we would have to walk two blocks and wait for a bus, then ride about 15 blocks and get off the bus, carry everything into the park, and find a spot where we could sit down.

One terribly hot Sunday afternoon we had gone all through this procedure and finally found a spot that wasn't crowded, spread a blanket to sit on, unpacked the baby's toys, diapers, etc. and settled down for a few minutes' peace. Just then a policeman came up to us: "Look—you can't stay here," he said.

"Why not?" I asked.

"How long d'ya think the grass would last if everybody was allowed to set and walk all over it?"

I suddenly remembered as a boy how wonderful it had been to lie in the grass in back of our house in the little New England town in which I was brought up.

We got up to leave. I said to Carolyn, my wife, "Look, let's get out of here!"

"It'll be awful hot back at the apartment," she said, "and Jackie hasn't had any sun for a long time."

"What I mean is let's get out of this dirty, noisy city—let's go live in the country . . ."

That is how we began to think seriously about living in the country. I say think about it—because we thought about it for a long time before we did it. First, we couldn't see how we could afford living in the country. Then we

began to wonder if we couldn't have a garden and maybe some chickens and by raising some of our food have more money so we could afford it.

The trouble was that a couple of our city friends who had farms always said the vegetables they raised cost about three times what they sold for in the store.

In fact, one man we knew about who had a fine modern dairy used to set before his guests two bottles. One was milk, the other champagne. "Take your choice," he'd say. "They cost me the same."

After we thought about this we realized these men were trying to run a commercial farm by remote control. Usually they went to their farms week ends only because it was so far away—and a hired man ran the farm for them. We wanted to keep a city job, for cash income; we wanted to stay near enough to the city to keep its advantages. We wanted to add the security and fullness of living that seemed more likely to come if we owned our home and some land, not much land necessarily, but good land and at least enough of it to raise most of our food.

There was nothing new about this idea. We were aware that Henry Ford and many others had been advocating just this for years. We knew that hundreds of thousands of American families were already doing what we proposed to do.

We faced the fact that we knew absolutely nothing about raising any part of what our family needed to live. In fact, our utter and absolute dependency on my job was appalling. If I should

lose my job—even temporarily—we would have no money to pay our rent—the landlord would put us out.....no money to buy groceries or pay the butcher and we wouldn't eat.

If there were another depression—and I were to lose my job like millions in the last depression—then there wouldn't be a thing to do but stand in line and beg the government for "surplus commodities" . . . rent money . . . relief clothing until things got better again—which might be years!

Living in the city we couldn't save much. Everything we did, almost, cost money. Our biggest item was food. Suppose, we thought, we could raise a big part of our food . . . We knew nothing about farming. But we began to look at things we ate . . . started to study how we could grow them ourselves. For a long time before we actually did move into the country we studied how to raise things. Perhaps in all we read a couple of hundred books and pamphlets on this. We found that most material was out of date and most of the newer books were designed for commercial farming specialists. For example, we found a dozen huge books on commercial dairy cattle, but no simple, up-to-date little book telling us how to produce milk efficiently for our family—and whether it was really economical to do so.

Then again there were lots of people telling you how to choose a farm of say 50-100 or 200 acres, but a dearth of information on telling us how little land we actually needed to raise food for one family.

Yet we gradually accumulated a good

Life in the City



many excellent books and pamphlets—all of which you'll find listed in these pages. When we had a fair idea of what we wanted to do we moved to our small place in Connecticut, about an hour from my job in New York, to try out our ideas.

This plan is the story of our place, of my family and me. It's the true story of how we have built our homestead. I hope you will be able to get some new ideas from it.

We call our plan—the "Have-More" Plan because that is the way it worked for us. Our plan shows how you can have a lovely home of your own on a piece of land that will furnish your family with food, recreation and health. Yes, and extra income too.

**If you'll follow our Plan
Here's how you'll be situated:**

You too can have a good home and an acre or more of land within a few miles of where you work. Your place will pay for itself as you go along—you will eventually own it free and clear. Think what that means—*no more rent to pay!*

You'll have far smaller weekly grocery, meat, and milk bills. With the small scale, modern, labor-saving methods we'll show you, you can raise up to 75% of all your family's food—perhaps do it all in spare time—and find real pleasure in doing it.

You and your family can become truly self-reliant. You will be able to keep your own home in shape, even improve your house and land. You can be healthier and happier. You can be sure that the food you eat is rich in vitamins and minerals. You need never worry very much about losing your job. You can retire years sooner, if you want to, and if you'll put away enough to be assured of just a small regular income.

Best of all, you can do as much or as little of our "Have-More" Plan as you like. You can fit it to your own pocket-book and spare time. If you are in

earnest it makes no difference whether you start with just a few dollars or five thousand.

If You Have a Full-time Job:

You can easily work out the "Have-More" Plan in *spare time*. If you work long hours and don't have a chance to do the whole plan at present, you can do part of it in as little as 15 or 30 minutes a day. Even so you can have all the health, happiness, and security of this kind of living. You can have a fine garden, beautiful flowers, get your fruit trees and berries, asparagus and rhubarb started, and perhaps have a few chickens.

This way of living is especially good for children. You can get your place all paid for and have that wonderful sense of security and independence knowing that you and your family have your place to fall back on—knowing that you could get by with very little cash income if you ever had to.

If You Have a Part-Time Job:

If you work short hours, such as 40 hours a week or less, you can get all the more benefit out of the Plan. Perhaps in your work you have several days a week free or maybe several weeks or months a year free. Perhaps there's an extra member in your household who'd like to help. If you have a place like ours, you can make your spare time worth money by developing a paying hobby right on your own place.

If You Are Planning To Retire:

Or if you have already retired, you can see that this Plan is a most practical way to stretch your retirement income and help keep yourself in better health. If you are going to receive Social Security benefits, or just a small pension, annuity, or small income of any sort, you can look forward to many years of happiness and security.

This Plan in no sense attempts to

turn you into a commercial farmer. There is all the difference in the world between farming for profit and raising only your own family's food. A farmer is a business man whose factory is his land. Probably—if he is really successful—he has become a specialist in producing one crop—milk—or poultry—or fruit. He has spent years learning to become expert enough not only to produce quantity but also to sell wholesale at a high enough price to pay overhead, his labor, machinery costs, etc. You, on the other hand, produce only what your family needs. You save yourself retail prices. You have no labor costs—practically no overhead—no distribution or selling costs. You sell only your surplus—and can easily find a ready retail market among neighbors or friends where you work.

You will be tempted—especially during a food shortage to produce, for example, more chicken than your family can eat—and sell the surplus at a profit. This you can do—but only if you have enough spare time so that you will not have to sacrifice growing some other foods for your family's own use.

The very fact that our "Have-More" Plan calls for raising a variety of vegetables, fruit, poultry, meat and dairy products means a diversification of work, a lot of different things to do, so that none of them becomes tiresome. Planning to have a garden, a cow or milk goats, laying hens and broilers, rabbits, bees—and maybe other livestock—sounds as though you had as much to take care of as many farmers who are notoriously overworked. But you have only sufficient garden, fruit, and livestock to supply your family's food.

A farmer, to have been deferred in the draft, and that meant that he was farming on a full-time basis, had to produce a certain amount, according to government rulings. For example if he himself were responsible for 5 milk cows, 60 hogs, 150 hens, and a 6 acre garden, he would be considered sufficiently productive to be deferred. On the same basis, if you were supplying 75% of your family's food—that is, you had 1/3 of an acre for a garden, 2 milk goats, a dozen hens, 100 broilers, 2 pigs, enough fruit trees and berries, you would have about 1/16 of what a farmer needed to win deferment.

I point this out so you will see that it is entirely possible for you to raise your family's food in your spare time if you go at it efficiently. A garden, hens, broilers, cow or milk goats, bees, etc. sound like an awful lot. Actually, only the variety is impressive—not the quantity.

Another thing, even though you have only enough poultry to supply your family, you use the most up-to-date, easiest way to take care of it. Then again, you will find this plan broken up by projects so that you add one project at a time and get that working perfectly before undertaking another.

Every so often somebody asks

Life at Your "Have-More" Homestead

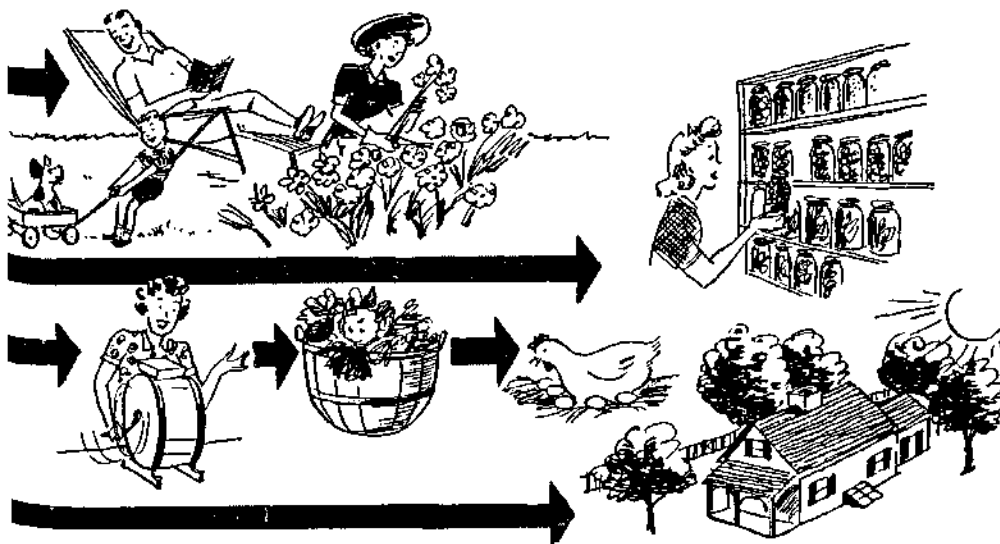

"How much of the Plan should I undertake?"

You yourself will have to decide this. The most difficult job is to get your house, barn, fencing and land ready for efficient operation. But once your place is set to go the actual chore time doesn't take long. A small flock of hens takes about 7 minutes care a day . . . a garden, the biggest and most difficult home food raising project, may take 150 hours a year or so.

Many people moving from the city to the country hesitate to add livestock to their places—because they don't want to be tied down. Livestock, however, can supply 40% of your family's food. Our livestock doesn't tie us down—our neighbors will do chores for us and, of course, we do chores at our neighbors' when they want to go away.

What has amazed us, was how relatively easy and practical it has become in the America of today for the average family with modest income to work out this plan of country living and city job.

No doubt many city families who have considered getting a place "out in the country" where they could live and raise some of their own food, have not done so because they thought it would take too much time and trouble to get back and forth; it would be all hard work and no play; it wouldn't be practical—it would cost more to grow food than to buy it—their chickens would die, the garden wouldn't grow, the bugs and birds would get all the fruit and berries; it would cost too much to get started anyway.

Well, the real reason we have written this Plan is to tell other people that these objections just aren't so. The average family can, today, make the country-living-city-job idea work and they can make it pay.

Some of the reasons why they can make it work today, where they might not have been able to even ten or twenty years ago, are these:

1. There has been a tremendous amount of highway building in the past

twenty-five years. Automobiles and busses, plus train service where needed, make it entirely practical for most people to live a considerable distance from their jobs. These same highways and cars have taken the loneliness out of country living, too.

2. Modern appliances and methods have eliminated much of the really hard work in keeping house and raising food for the family. The pressure cooker and the home freezer, for example, have made preserving far easier than it used to be. The short work week (30-48 hrs.) leaves plenty of spare time for work at home plus plenty of spare time for play. To add work at home on top of a 6 day, 70 hour week was one thing. To do the same work at home on top of a 5 day, 40 hour week is an entirely different thing. What was work actually becomes fun.

3. It is easy to learn to raise plants and livestock successfully today. Methods are simpler, more scientific. Seeds and plants are better, surer to grow, more productive. Fertilizers are better. Livestock breeds are better—they produce more per hen, per goat or per pig. Feeds you buy are better, more scientifically prepared. Disease and pest control is far more sure and specific. For example, what the famous sulfa drugs are doing for sick people, they are also doing for sick chickens.

4. Low-cost, long-term federal and private financing now bring the possibility of home and land ownership within the means of people who couldn't have even dreamed of it not so many years ago. Mass production of appliances, furnishings, tools, even houses has brought the cost of getting started down to a low figure. Both of these points will be even more true in the post war years. Home freezing equipment, for instance, which before the war was priced in hundreds of dollars will be priced in tens of dollars.

Everything we tell you about in our Plan has been tried out by us personally, or by people we trust. We believe we can make it all work just as well as we've said it would. Of course, nobody can guarantee what results other people in other places will get. But I've made a sincere effort to give you honest and frank answers in the plainest language I know how to use.

And I hardly need to remind you that various parts of the country have differing climate and soil conditions. We are telling what we've been doing here in Connecticut (a fine state, by the way) and you will realize what allowances you must make for your own local conditions.

You don't have to spend as much on buildings as we did. We happen to think this a good investment, but are the first to admit that you can get along fine with less expensive buildings.

Building a small barn for your livestock, buying a couple of acres of land instead of simply a lot big enough to set a house on, or shelling out fifteen dollars for a pressure canner is different from the same amount of money spent on a trip to Florida or an expensive dinner and theatre party. Money invested in productive capital will bring you a great deal for a good long time to come.

We believe that many farm families, too, are going to raise more of their own food. They will forego some of their extreme specialization to develop a more rounded self-sufficiency.

If homesteading, as we mean it here, really does become a trend in the post war years, it can itself create vast business and employment opportunities. It can furnish a pattern, an idea, an objective for the city, highway and industrial planning we hear so much about these days. It can contribute greatly to continuing security for all.

A friend once said to me, "Ed, why do you bother with other people? Why don't you settle down and just enjoy your own job and your "Have-More" Homestead? Why try to spread it all over the country?" I may sound silly trying to tell you why. But I feel, somehow, that in the years to come the U. S. is going to need all the help it can get toward happiness and peace and security. We aren't always going to have a boom going on. I've got a boy and I want to see him grow up in a good country, and if ten or twenty million American families can get set as well as we Robinsons are I don't think anything can hurt this nation.

Do you see what I mean? That's why I've worked so hard putting this Plan together. That's why I was so careful to be truthful and sensible in everything we put in it.

Anyway, Carolyn and I think this is a darn good idea and we hope you think it is a good idea—so good you'll want to get some of your friends to buy a copy of this book too.

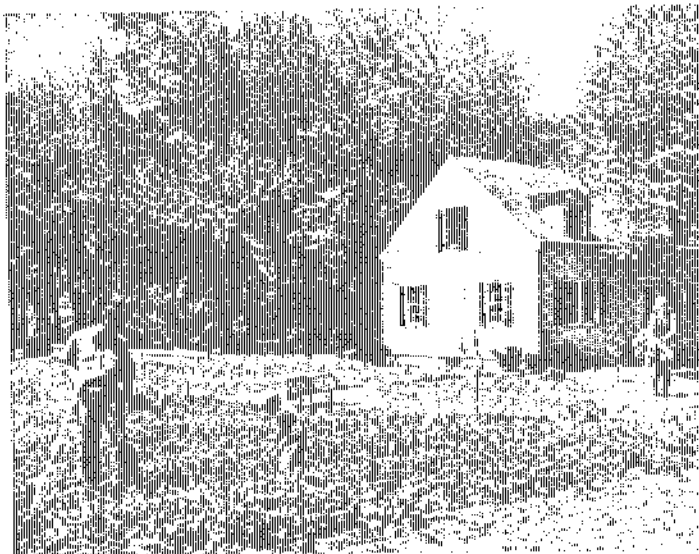

Even at 3½ our son Jackie likes to "help." Actually as yet, he isn't much help, but we try to encourage him. We want him to learn to do things — older children can be a real help on a homestead. And, more important, country living furnishes excellent opportunities for children to develop intelligent and responsible personalities.

A Letter to Wives from Mrs. Robinson

Dear Friends:

If your husband reads this plan and then tries to talk you into doing something like it, you might say, "Poor Mrs. Robinson—I'll bet she has to do most of it and I wouldn't be in her shoes for anything." So I thought you might like to know where I stand on all this.

The cue to our success with the "Have-More" Plan is found in one common little word throughout these pages. Our editorial "we" means exactly that—it isn't used just for the sound effect. We have honestly worked together as a team on everything from our first seven hens to writing this Plan. Believe me, the marriage of a man and woman really means something when you start homesteading. Somehow, working close to the earth and with nature seems to make the combination of man and wife more important and, I believe, makes marriage a happier success than is possible in sterile city life.

Do I sound old fashioned? Let me explain that neither Mr. R. nor I came from farms originally. We married and lived in New York City for five years and I suppose we could have been described as city sophisticates. So what we have discovered as an exhilarating way of life comes from actually trying city life and country living and then choosing (intelligently, we think) the better.

Out here on our wee farm my husband really needs me and I, in turn, could not get along without him. When he calls out, "Quick, honey, bring me my bee veil! These bees are in a bad mood," he really does depend on me to help him out.

Mr. R. naturally does the heavy work in the garden and with the animals, while I take care of canning, freezing and household jobs. But!!! We both encroach on the other's job. Mr. R. canned at least 50 quarts of tomatoes and froze a couple of dozen packages of vegetables—all after he got home at night which isn't before 7 o'clock. He's nuts, you think? Maybe, but he says it's a pleasure after sitting at a desk all day. I, in turn, do necessary chores during the day and I usually milk the goats.

Ed always envies me getting in on all the exciting events here—it's I who watched the bees swarm (sad affair, but very interesting), I who greet the fuzzy day old chicks that are so adorable, I who had the great thrill of watching the goslings gradually emerge from their shells, and so on indefinitely. There's always something happening here. That's what made me decide the old idea is really true—if you want to be happy and stay young, keep growing things around you. When you



grow vegetables, flowers, chickens, pigs, geese, goats and a child all at the same time, how can you be bored?

But about the work—that's what's worrying you, I know. Yes, I do work hard, I suppose—at least, other women seem to be impressed. But I don't work any harder than I did when I was employed in an office and at the same time kept house as so many women do. One secret I have found is not trying to keep a spotless house—I have decided it's a waste of time. I guess our other secret is that what seems dull work to many people frequently is fun to us.

Now I don't claim we enjoy doing everything—for instance, picking chickens, washing too many greens at one time for canning, or cleaning out manure. But even these disagreeable jobs are not too bad when done together, and what satisfaction I get when they're done! Being a woman you can imagine my blessed feeling at knowing I have, to name just one item, 25 broilers in my freezer—ready to be cooked for my family or friends whenever I want them. We women probably place security for our families above everything else—so you wouldn't mind being in *my shoes*, would you, if you could say—"I could feed my family well without buying another thing for six months!"

I guess you may think by now that I am a very unsociable person but I like to play as well as anyone else. I get very fed up with it all occasionally. When that happens, I try to park our child and the chores with a neighbor and off I go to the city—the Robinsons don't begrudge Mom her day off, especially when it makes her so glad to get back.

There are certain basic facts about the work though—summer is obviously the busiest season while winter gives you loads of time for parties, dinners or whatnot. Except in the middle of summer we have weekend guests who like to play at farming and in the winter we have supper parties. Incidentally, I find it doesn't cost much to entertain guests since we started our "Have-More" Homestead, because we

always have surplus food on hand. Nature has worked out a swell scheme—by the very fact of winter she forces you to rest. Then when spring comes, you're refreshed and eager to start all over again.

And I think you'll make some new friends you'll like—without exception, the people we have met in connection with our animals have been tops. I don't know whether owning animals makes people nice or whether only swell people care for animals, but whichever it is, both Ed and I have thoroughly enjoyed the new friends we have made.

After you work on some of the "Have-More" projects, you may well find you are so interested you would like to expand one of them on your very own and develop it to "pin-money" size. I, for example, really adore the geese and next year I think I'll raise a fair-sized flock.

There's one more vital point in what the "Have-More" Plan means to me. That's Jack Robinson, our little son. I can't begin to tell you what our new way of life is doing for him. He loves all the animals and already at the age of four wants to help take care of them. And we let him to the best of his tiny ability. He is already an independent little thing, afraid of nothing. And need I say what has been written so many times before—by seeing and helping care for our animals he will naturally grow up knowing many facts of life (and I don't mean just sex, though that is included). Furthermore, he will have a basic understanding of what living is all about and what it means to earn his own bread. I believe it is frequently the country boys who have made good in America—anyhow, I sincerely believe we are giving Jackie the best opportunity in the world to learn everything from hammering a nail to developing an intelligent and responsible personality.

And what's more—he will have all the childhood fun for which country life is famous. From his standpoint alone all this is worthwhile.

As you can see, I can't even keep "we" out of my own letter to you. Your husband can't "Have-More" alone—he needs all your interest and help—but isn't that the way you want it? If you start the "Have-More" Plan I truly believe you'll find many intangible rewards for yourself and your entire family—for you'll all be working together, probably more so than ever before in your lives.

My very best wishes to you with your plan—I hope you'll get as much fun and deep satisfaction out of it as I.

Sincerely,
Carolyn Robinson

What Sort of Place Do You Have — or Want?



Country home for city worker



Part-time commercial farm



A business at home



A full-time commercial farm



A place to retire

WHEN we first wrote our "Have-More" Plan we thought of it simply as a way a family could raise a good deal of its food on an acre of land.

"A little land—a lot of living" was our idea. Imagine our surprise when we began getting letters such as these:

"Dear Ed and Carolyn,
"Your Plan is just what we've been looking for out here on our 2,200 acre cattle ranch. Why should we drive 40 miles for our groceries? We are putting in a big freezer and raising our meat, fruits, vegetables, etc. . ."

"Dear Carolyn and Ed:
We think your Plan is wonderful. Of course, we aren't interested in raising our own food, but we have bought two-and-a-half acres so that our two children, Emily, 4 and Johnnie, 2½, can have a nice yard to play in. Keep up the good work. We are recommending your Plan to lots of our friends."

From many letters we saw that, in reality, our Plan is basic to five different patterns of country living:

1) **Country Home for City Workers:** In this set-up a family's main income comes from a "full-time" job. The land that this family can use productively is limited to what can be cared for in "spare time". However, with only an acre and an hour's spare time a day it is surprising how much of its food a family can produce, how many improve-

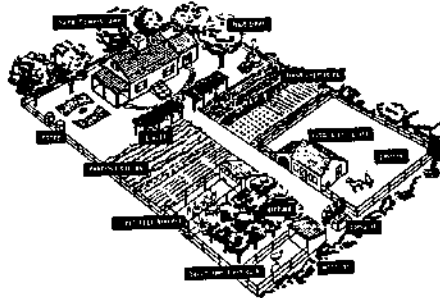

The "Have-More Plan" is basic for all

ments it can make, how much repairing and maintenance it can do. In fact, with proper instruction a willing family can make an acre home in the country productive enough to pay for itself. More important than any economic considerations, however, are the wholesome aspects—a country home gives a family a chance to work together creatively outdoors in the fresh air and sunshine. As the length of the work week shortens and city workers have more time to themselves, home ownership on an acre or so is going to become even more popular.

2) **A Part-Time Commercial Farm:** The distinction between a "Country Home for City Workers" and a "Part-time Commercial Farm" is a difference of degree. But because a Part-time Farm generally requires a good deal more than one to three acres of land, the distinction is important. Inasmuch as the Part-time Farmer will raise some crops for cash, the whole subject of what to raise becomes complicated by the necessity of considering a market. Generally, "part-time" is associated with hobby farming or "subsistence" farming—but thousands of part-time farmers, particularly truck gardeners, nurserymen, and even turkey raisers, farm during the growing season and work in industry during the winter and do well. The most profitable crops for the part-time or small farmer are those produced for home use.

3) **A Business in the Country:** Great opportunity lies in the "rural service field." Recently, the *N. Y. Times* said:

"The tremendous scope of the rural-service field is visualized by few. In the years ahead it is certain to include more frozen-food community locker plants, rural electrification, custom work with power machinery for farmers who prefer to hire instead of own, repair shops for farm machinery, expanded telephone service, scientific soil conservation, modern forestry and refrigeration. There will be opportunities for roadside stand sale of products bought from farmers who live some distance from main roads.

"It seems evident that we are ready for a great expansion toward higher standards of country living. It does not mean more farmers. It does mean many more part-time country homes on the roads radiating from cities and large towns."

Next time you're riding through the country, notice the many signs along the road put up by people operating little businesses of their own. It's just as though a classified telephone directory had come to life. Most of these people, whether business or professional men, own a home with considerable land around it. Very often they have a garden, fruit, berries, chickens, other livestock.

4) **A Full Time Commercial Farm:** Farmers realize farming can be more than a business—it can be a way of life. A farmer who raises only tobacco is no more secure than the man who runs the corner cigar store. But the tobacco farmer, having gone through food rationing, is now apt to be keeping a cow, a couple of pigs, poultry and a large garden. The Department of Agriculture has found that the indigent farmer was the "one-crop" specialist operating on the theory of raising everything to sell and buying all his groceries, meat, milk, and vegetables, just as though he were a city dweller. Today, most farmers know that it is not cheaper to buy their family's food. In the corn belt, points out Rt. Rev. Ligutti, a year's supply of vegetables would cost approximately \$260 for a family of five. In order for the corn belt farmer to earn \$260 cash, he must spend 520 hours working 50 acres of land and produce 2,000 bushels of corn when corn sells at 50 cents a bushel. A vegetable garden only 50 x 100 feet, with \$1.25 spent for seeds plus 50 hours of field work and 25 hours of canning will produce \$312 worth of vegetables. Which is better off—the man who raises corn to buy vegetables—or the man who raises his own vegetables?

5) **A Place to Retire:** Social Security, retirement income insurance, civil service, Army, Navy and the many pension plans of industry mean millions today can look forward to a regular income in later years. The man who will put his spare time in developing a productive country home can retire years sooner. With no rent to pay, with land and the ability to make it produce the family's food, a man can live in grand style on a small pension or other steady income.

The "Have-More" Plan is basic to each of these five ways of country living. Expressed in terms of a "platform," the "Have-More" Plan calls for:

- 1) A source of cash income.
- 2) Home ownership on at least an acre of land.
- 3) A family willingness to use a good part of its spare-time productively and creatively.

Before you dash off to the country and buy a place, consider carefully what sort of country home you want.

Setting Up a Homestead

AN old farmer struck it rich in oil and his family persuaded him to buy a \$4,000 automobile. Never having had anything better than a second-hand Model T, the old boy insisted on only one thing for the new car—the most colossal and expensive set of bumpers he could find!

I wish we'd had some good bumpers when we decided to move to the country. We bumped our noses on land, on the layout of our house, on the location of our barn, fruit trees, and pasture—on nearly everything a family could blunder at. I hope you'll profit by our mistakes!

Setting up a productive country home is probably the biggest and most important job any of us attempt during our lifetime. Despite all of the people who have needed some basic data on setting up a homestead, no one had completely worked the methods out and put them on paper. Every new family has been left to stumble its own way toward the answers.

Not long after our first edition of the "Have-More" Plan went out we began to get letters asking for help in laying out a place. Of course, we couldn't give specific advice without seeing each piece of property; and then, people have different ideas of what they want to do with their place.

Even though no one layout will fit everybody's ideas and site, there are certain basic points that ought not to be violated.

For example, where should you locate your house in relation to the highway? (If you do this right you can probably get the town snow plow to do your snow shovelling for coffee and doughnuts.) Where should your barn be placed with reference to the house? Toward what compass points should house and barn face?

What are the best locations for garden, orchard, pasture, hayfield? In placing fruit trees how much space should be allowed for them to mature without crowding? How can fencing and gates be placed for easy pasture rotation and so livestock can always get water without your having to carry it?

In planning the house itself, how can

you start small and yet make additions through the years so that the finally completed homestead is attractive and efficient for country living?

If you plan your place correctly from the beginning, you will save countless steps in the years to come. You can actually cut your chore time in half. One minute saved twice a day on chores equals 12 hours a year!

Have a Plan

Before you lay out your place you ought to be able to answer all the above points and more too. Even if you're buying a country house that's already built you should have a definite plan for refitting the house and land to your use. Over and over I've seen city people buy a farm, remodel the house but let the land go to rack and ruin. Even if you can't use all the land you've bought, you should learn enough about land management so you can rent your unused land to a neighbor and see that he keeps it in a good state. Idle land deteriorates just as fast as an idle house.

When we moved to the country about the only layout we could find to help us was the diagram below. Even though it shows so little detail as to be of questionable help to the novice, it has two major faults. The combination barn and poultry house should be located where the berry patch is—this will be painfully evident to anyone who has had to carry 100 pound sacks of grain and 150 pound bales of hay from the end of the proposed driveway 90 feet or so to the barn. The second questionable point is that far too many trees are shown in the orchard—a family couldn't possibly eat all the apples, peaches, pears, and cherries which would total about 75 bushels when these trees were mature. Of course,

you might sell the surplus, but it is difficult to make a small part-time orchard pay.

Some Mistakes We Made

At the top of the next page is a sketch of our homestead. The things wrong with it are errors that any novice is apt to make and if we tell you about them you ought to avoid making them. First, although very pretty, there is too much lawn. Our house sits 90 feet back from the road and the front and back lawn take a good hour to mow each week. Second, our small barn is too close to our neighbor's property; there is no room for a poultry run in back of the barn—in front is our backyard play area. Third, our quarter-acre hayfield isn't large enough. Fourth, there are too many trees in our pasture—good pasture grass needs sunlight. Fifth, originally our house sat right in the middle of a woods. We believed this the best way to have trees around the house, believing it would be easy enough to clear land for garden, pasture, and crops while "only God could make a tree". However, we found it is cheaper to build your homestead on clear land and plant a couple of big trees.

Our total acreage is only about 2½. Three to five acres would give us enough pasture for our livestock and enough hay we could then depend on our place to supply us with over 75% of all our food requirements and a high percentage of the roughage and grains needed to feed our livestock.

An "Ideal" Layout

At the bottom of page 8 is a cut of an "ideal" layout for a productive country home. The drawing is available in full-

Shown below is a suggested layout for a 4 acre homestead. To the original 2 acre house plot, 2 additional acres are attached to rear. These 4 acres of good land would not only provide the family vegetables, fruit and berries but more than enough pasture and hay for two or three milk goats or pasture for a cow and a good part of a cow's hay requirements. There is also room for a pig or two plus other livestock.

On the front cover is a suggested layout for a 2 acre homestead, and on page 28 is shown a suggested layout for a half-acre.

We emphasize that these are only suggested layouts. Each family will have its own ideas on just how to manage their own particular place.

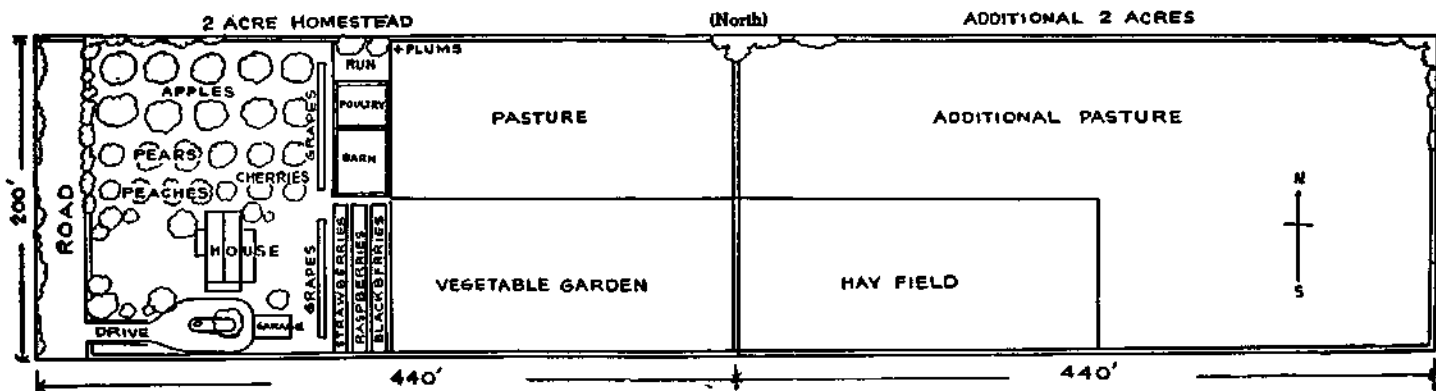

size (about as large as the top of a bridge table). Two experts helped with this "ideal" homestead plan: Milton Wend, author of *How to Live in the Country Without Farming* and John H. Whitney, R.A., an architect who specializes in designing country homes.

About 40 pages of description accompany this excellent plan; all the details can't be given here, but I'd like to point out that this basic plan of the "homestead area" (the country house, garden, barn, orchard, lawn, pastures, etc.) is a good point of departure if you're interested in any of the five productive homes described on page 6.

For example, suppose you want only an acre place in the country where you can have a lovely home, a garden, some dwarf fruit trees, and maybe some chickens. An acre is more than enough room; an acre, remember, is 209 feet by 209 feet. The portion of the ideal layout shown in the lower left-hand corner of this page is just over an acre. You'll notice that this "basic acre" includes a large house, an orchard of standard trees, barn and barnyard, a good-sized garden, flower gardens, lawns, driveways, and even some pasture and hayfield. The pasture and hayfield are not shown complete—the wavy line at the top of the cut indicates that these are only partially shown.

A Larger Place?

If you wanted a larger place, a part-time farm where you could, if necessary, grow 75% of the family's food, then you'd want more pasture space and hayfield. But the basic acre is still an excellent layout.

Then again, if you wanted to carry on a business at home, the office and "shop" to the left of the living room could be built. Naturally, this could be as small or as large as needed for your business.

If you want a commercial farm, then this same homestead acre is a good layout. You'd still want a kitchen garden for home use even if you were growing tobacco, or flowers, or fruit; if you

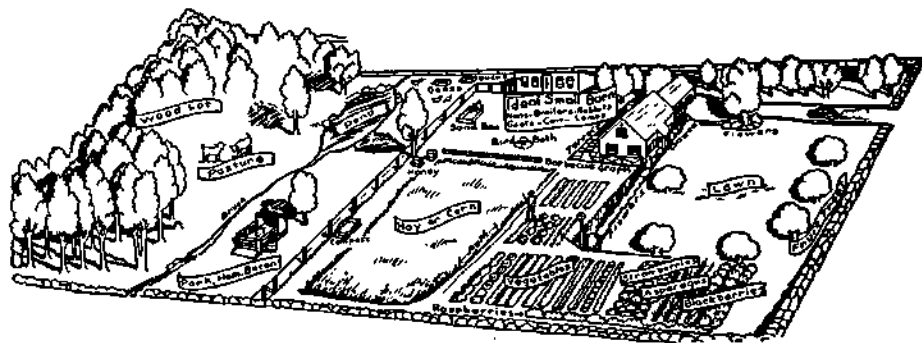

Here's a sketch of our homestead.

were running a commercial dairy or a poultry business then you'd drop your goats or cow out of the small barn, but might well have the rest of the items. Naturally, on a commercial farm you'd add to the basic acre as much land as you needed.

As a place to retire you might want an acre, or enough for a part-time farm.

Basic Acre Most Important

You can see that this *basic acre* is the key to a productive country home. Even though the house may not suit you, or the exact location of the items may be impossible to achieve, due to the fact that you are remodeling an existing place, or even because you want your place laid out differently, I think you'll find that this "ideal layout" makes a good point of departure. It does indicate basic principles that ought to be kept in mind.

For example:

- 1.) Every bit of land should be used advantageously.
- 2.) Garden rows should be of good length for easy cultivation; and run North and South for equal sunlight.
- 3.) Pasture should be fenced into plots for rotation. Pasture gates should be wide

- enough for entry for haying and plowing equipment.
- 4.) Vegetable garden should be handy to kitchen.
- 5.) Lawn and shrubbery arranged attractively, yet easily cared for.
- 6.) Child's play area screened from street and located so it can be watched from the house.
- 7.) Compost heap should be placed between barn and garden.
- 8.) Trees should be spaced so as not to be crowded at maturity.
- 9.) Shower, bath, dressing room should be accessible from outside.
- 10.) Barn should be to lee of house; close enough to make supervision of livestock easy.
- 11.) Adequate closet and storage space in house.
- 12.) Space for good home workshop.
- 13.) Housing for garden tools, wheelbarrow, lawnmower, small tractor.
- 14.) A cold storage room for vegetables and canned goods.
- 15.) Fencing so arranged that livestock may be turned loose from the barn.
- 17.) Space for home freezer, laundry, fireplace wood.
- 18.) Orchard should not shade garden.

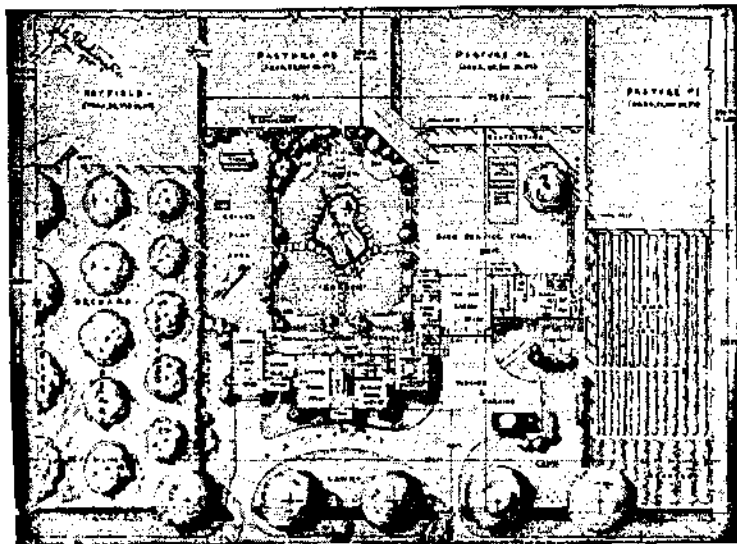

If you're thinking of having a place of your own — or you want to lay your present place out more efficiently — send for "Layout for a Productive Homestead" from which this small reproduction was made.

This will give you an idea of some of the things that you ought to think about when planning a homestead.

Houses Especially Designed For Country Living

TODAY practically all houses are designed for suburban living—not country living. A suburban house is simply an expanded apartment. No provision is made for the more productive kind of life you can live in the country.

For instance, if you have a garden or chickens or fruit trees, and most certainly if you are going to have livestock, you'll find that the small kitchen of the suburban house is totally inadequate. If you're going to have a laundry or you want to start your seedlings indoors or you plan on a quick freezer, you'll find no provision for these in the usual suburban house.

The fundamental differences between the ordinary suburban house and a house that's really satisfactory for productive country living or a small farming operation is illustrated in the three floor plans at the right.

The smaller the house the more difficult it is to provide space for homestead activities. Thus we asked John Whitney, R.A., an architect who specializes in country houses, to take a good small suburban house and show how approximately the same floor area might be laid out in a productive country home.

Note these plans are about minimum—one story, four rooms, with heater space instead of a basement. Ordinarily if 10% of a house is "waste space" (hall area), the plan is considered satisfactory. Hall area in these plans is only 2%!

PLAN A: (705 sq. ft.) Here is an efficient suburban house well planned for that type of living. Note that the kitchen is the small apartment house type. Living room is large.

PLAN B: (705 sq. ft.) This is the same basic plan as "A" achieved by turning "A" up-side-down and reversing it. (Dotted lines show eliminations.) The living-room becomes a "Harvest Kitchen" with heater space, chimney, and bedroom closet off one end thereby eliminating two small closets in larger bedroom and gaining 8 square feet of valuable wall area for dining in the enlarged kitchen. Heat and chimney area of Plan "A" becomes smaller sitting-room. By reversing living-room and kitchen in most suburban house plans you have a better country layout.

PLAN C: (753 sq. ft.) This is an ideal small homestead. By adding 48 square feet, 76 square feet are gained for the "Harvest Kitchen." Here is room for all food preserving activities plus laundry. The living room is 182 square feet compared with 181.5 square feet in Plan "A". Bedrooms are same size in both "A" and "C". By changing the corner closets in Plan "A" there is an additional gain of 8 square feet plus wall space.

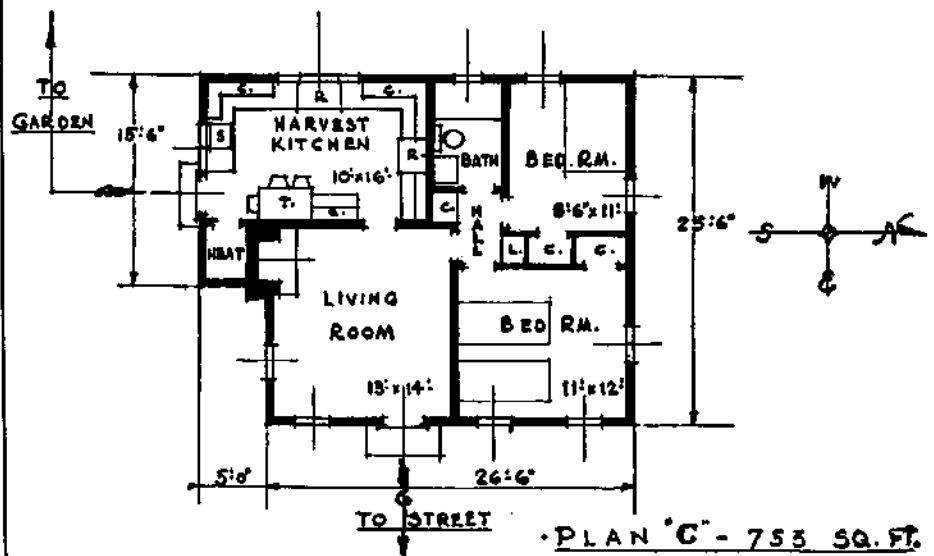
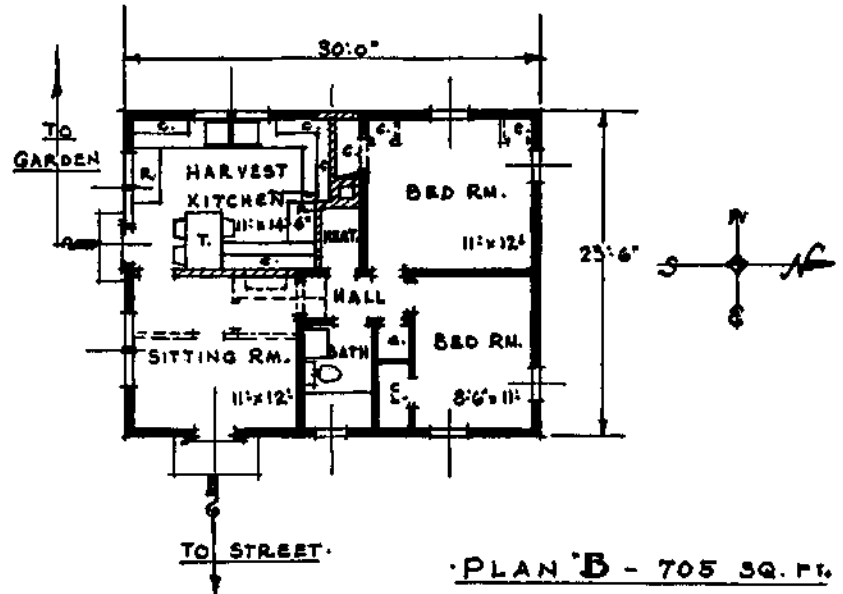
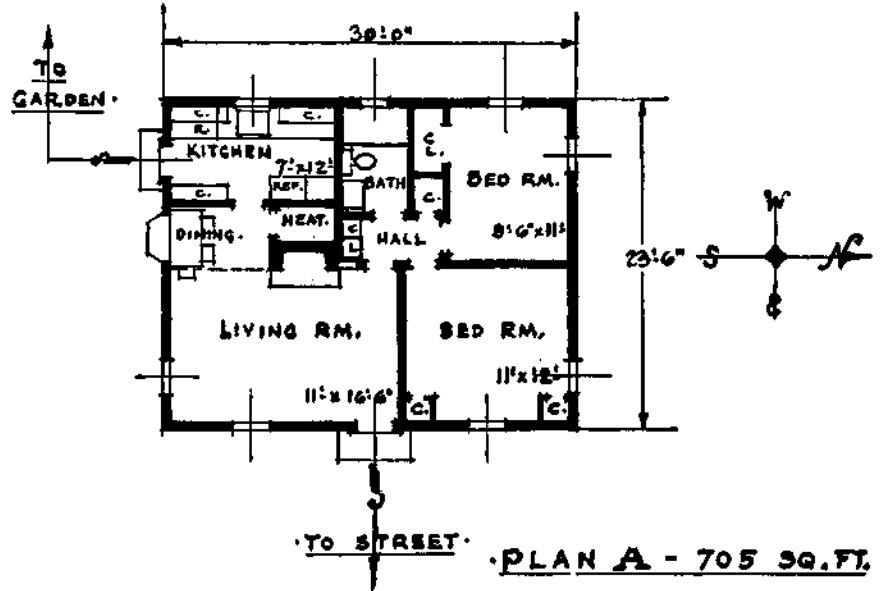

Plan a "Harvest Kitchen" With Your Wife

NOT long after Ed and I moved into our country house I began to realize my department was going to be overcrowded.

One look at our big quick freezer, the cream separator, the honey extractor, the pressure canner—and another look at our small kitchen and we were somehow reminded of trying to get a grand piano into a phone booth!

You see, when you begin to grow a good part of your food you need a "factory" to process it and preserve it. And you just live differently. The ordinary kitchen-dining room combination of the conventional house simply doesn't fit.

What you need is a streamlined, modern little food-conserving set-up, combined with the charm and warmth of Grandmother's kitchen.

We went to John Whitney, an architect who specializes in country houses, with our idea. Together we planned out every detail of food preservation, preparation and serving, added such things as the greenhouse window (for winter herbs, flowers, and spring plant starting), a desk and record-keeping corner and a rocking chair corner for relaxation, darning and sewing and general coziness.

And now we have our "Harvest Kitchen." It has turned out lovelier and more practical than our fondest dreams. Believe me, if you want to make cooking, canning and freezing a joy for your wife build her a "Harvest Kitchen!"

You can add it to any house; you can put it into new-house plans; sometimes you can convert your present dining room and kitchen into this needed "Harvest Room" or "Harvest Kitchen" as we call it.

In our "Harvest Kitchen" (see pictures at right) we have such features as a greenhouse window, special milk-handling and cooling equipment, quick-freezer cabinet, hardwood chopping block for meat and poultry dressing, vegetable-cleaning sink, glass-enclosed preserved and canned food compartments, garbage-handling arrangement, dry food storage space, cooking, canning and work space, etc.

Isn't it astounding that such a room has never been designed, not even for a farmhouse?

We can't begin to give you all the important details, plans and so forth, but if you're interested in building a country house or remodeling your present one, you can write for our complete portfolio giving full information plus plans drawn up by John Whitney, the architect.

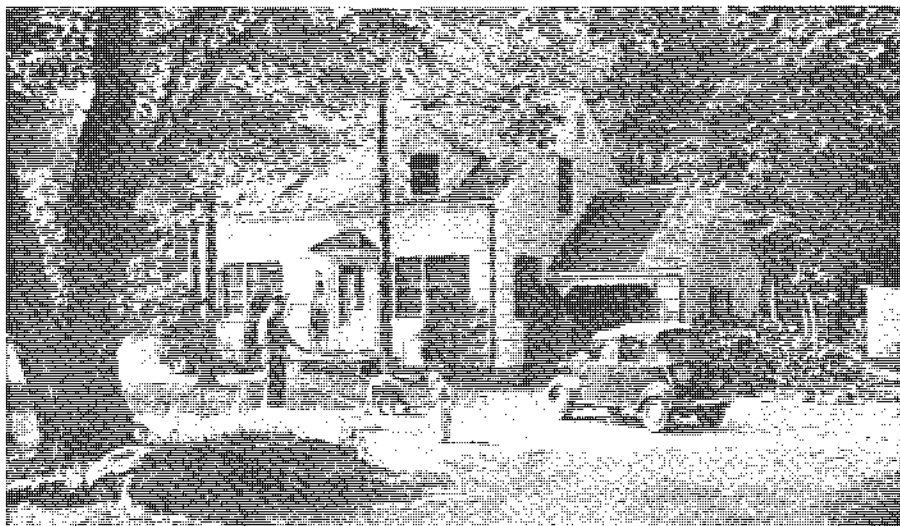

OUR HOUSE: This snapshot shows our house which is the so-called "Cape Cod" style. We found that the ordinary-size kitchen cramped our canning, freezing, and cooking so we planned the addition of an up-to-date version of the old "summer kitchen."



OUR HOMESTEAD: Another snapshot six months later showing how our suburban house has been turned into a homestead by adding a "Harvest-Room." The garage was remodeled—note the greenhouse window. Also, we improved the front entrance and added picket fence at left.



Here is one end of a special room every "Have-More" home needs very, very much. The big, roomy old farm kitchen was its "ancestor"—yet it is completely new in design and conception. We call it the "Harvest Kitchen."



This architect's sketch from PLAN FOR A HARVEST-KITCHEN is one of six showing various ways a "Harvest-Room" may be added to an existing house or planned for if you are building a new house.

Finding a Suitable Place

MAYBE you already have a place of at least $\frac{3}{4}$ of an acre of level, good land. So much the better, but read this section carefully to make sure your land is suitable for intensive cultivation.

I am going to suppose you live in the city—own no land—and know nothing about finding a suitable place in the country.

Here's how you start. Get a good map of your locality. Take a compass and using your place of work as a center point, make a circle the radius of which should be approximately the distance you can travel in one hour.

If you own a car, this radius could well be 25 miles. This 25 mile radius will enclose a territory of 1,962 square miles (an area about equal in size to the whole state of Delaware). If you expect to travel by bus, street car or subway to your job, the radius would be shorter.

Next study the encircled area. Is there any particular part of it in which you would especially like to live? Have you friends in some part? If so—talk to them about finding a place.

The most important single step in the "Have-More" Plan is selecting a suitable place. If there is any question in your mind as to whether you will enjoy owning your own home—raising your own food or living in the country—or any other doubts—rent in the community you select before you buy. Remember, you are choosing a place to make a permanent home—you are not simply leasing an apartment for another year.

The very fact that this first step is so important and difficult is a good thing because if you haven't enough gumption to go out and find yourself a place—then you probably would never

make it amount to anything even if a rich Uncle left you the place in his will.

One reason so many city dwellers continue to go on paying rent and living the restricted life people lead in an apartment seems to be because they don't know how to go about finding and developing a place of their own. Another obstacle is the mistaken belief that they can't afford a country place of their own.

Deal With A Good Real Estate Man

Many people who go to a doctor when they are sick, a dentist when they've got a toothache, balk at going to a real estate man to buy property. Somehow they figure they can find a bargain in real estate themselves if no real estate man enters the picture. Of course, a real estate man is in the business of selling real estate—and he is going to sell everybody he can. But most people who get stuck by a real estate man let him sell them something he wants to sell. They don't tell him exactly what they want—and make him find it for them.

We have prepared a "score-card" which you will find helpful in talking with a real estate man. This "score-card" is a guide to the qualifications a place in the country should ideally have in order for you to utilize it successfully in accordance with the "Have-More" Plan. Of course, you may not find a place that has everything you want, but with your own good judgment and careful consideration you can pick the best suited available place in your chosen locality.

Take this "score-card" with you when you talk to any real estate man.

It will save you time in telling him what you want. It will save you fruitless hours of riding from one piece of property to another only to be disappointed because it is not suitable. But most important, it may save you hundreds of dollars and years of work by protecting you from buying a place that you later find impossible to make productive.

When you are buying property it costs nothing to deal with a real estate man. He gets a commission, usually 5% of the sale price, from the seller. Every real estate man has a number of houses with land listed. This same property may also be listed by other real estate agents. So you can see how competition tends to keep the prices on property in line. Usually, it is the best practice for you to talk to a number of real estate agents. Then, you can do business with the agent you like.

A Word of Caution: If you can, rent a place with an option to buy it at a definite price at the end of a certain time—for example, a year—do this if there is any doubt in your mind about the place and the community.

Land More Important Than House

A good farmer in buying a new farm gives primary consideration to the land—the state it's in . . . whether it's easy to cultivate—neither dry nor wet, nor too sandy, nor too shallow. This you should also do.

We are approaching a wonderful new era of home-building. Shortly houses the like of which we have never seen will become available at low cost. Nobody knows just when these houses will be ready—but authorities agree they are coming. Remember this—and consider seriously buying your land now and getting the land in the condition you want it. Perhaps the house on it—even if it's "just a shack"—can be made livable for the present.

Should you plan to build your own house or buy land with a house on it? This question you can decide for yourself. If you find a suitable piece of land—I mean suitable because of size, condition, levelness, closeness to work—and it has a good substantial house on it that you like then buy it. But if you can't find on one place both a satisfactory house and satisfactory land—take the place where the land is right. You can always build a house—but some land is almost impossible to make fertile.

How Much Money Do You Need?

If you plan to rent a place before you buy—then you can find a house and

Points to check in buying a house (From F. H. A.)

1. Exterior trim.
2. Attic ventilation, attic room.
3. Flashings.
4. Chimney masonry, cap, etc.
5. Roof.
6. Rafters, studding.
7. Roof sheathing.
8. Dormers.
9. Weather-stripping.
10. Lath.
11. Garage—tool space, workshop, etc.
12. Walks and drives.
13. Exterior walls.
14. Sheathing and insulation.
15. Window frames and sash.
16. Blinds, shutters.
17. Porch—beach, transom, door columns, etc.
18. Steps—brick, wood, concrete, tile, etc.
19. Drain tile.
20. Footing.
21. Foundation walls.

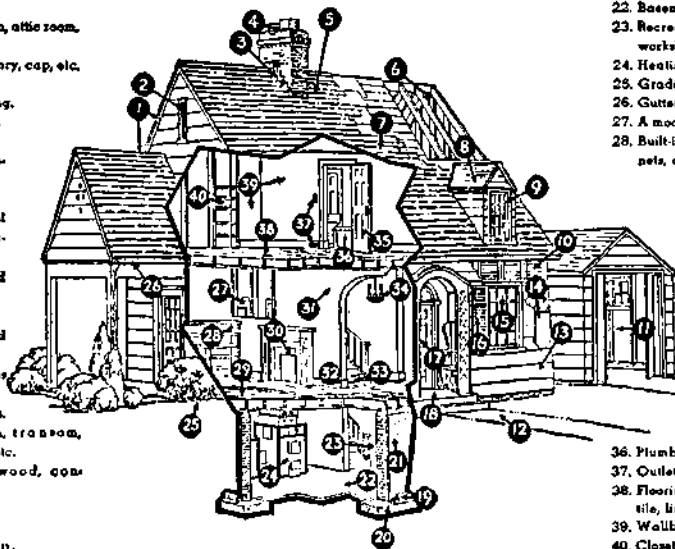

22. Basement floor.
23. Recreation room, laundry, workshop, etc.
24. Heating plant.
25. Grading and landscaping.
26. Gutters, downspouts.
27. A modern kitchen.
28. Built-in bookshelves, cabinets, cupboards, etc.
29. Joists and sub-flooring.
30. Fireplace, mantel, flue.
31. Paint, wall-paper, interior decoration.
32. Interior trim.
33. Stairways—treads, rails, balusters, etc.
34. Electric fixtures.
35. Doors, hardware.
36. Plumbing and fixtures.
37. Outlets and wiring.
38. Flooring—finished lumber, tile, linoleum, etc.
39. Wallboard, plaster, etc.
40. Closet space, shelves, etc.

land for what you are now paying. Specifically, you can rent a satisfactory place for \$15 a month or go as high as \$100, depending on section of country.

If you plan to buy you will find the price of suitable land ranges from \$100 to \$1500 an acre. The larger the piece—the less cost per acre. If you want to buy the land only, this is all right if you are now living close enough to go to it regularly and start getting it in shape.

You can buy land by putting up a cash payment of as little as 30%. Even if your land has no house you perhaps are living close enough to have a garden. The money you don't have to spend on vegetables can then help you pay for the land. Or go get a bank to pay the owner outright and take a mortgage for the balance. If a bank won't give you a mortgage on the land, be careful. There might be something wrong with the land, its location or price.

Perhaps you can buy land with a house on it. You can then put your rent money into paying for the property. Also, a house on the land means you can start immediately making the land pay for itself because if you live there you will be able to put more time into getting your "Have-More" Plan under way.

You may be surprised at this, but 44% of all Americans own their own homes. This the government encourages by sponsoring the Federal Housing Authority (F.H.A.).

F.H.A. makes it possible to buy or build a beautiful modern home and pay for it out of a moderate income.

For example—a small home:

Suppose land and buildings are worth	\$2650.00
Of which the value of land is	150.00
Your down payment would be	150.00
Your F.H.A. loan would be	2500.00
Your monthly payment including principal and financing charges (taxes and fire insurance a couple of dollars extra)	\$ 20.90
At the end of 180 months your F.H.A. loan is completely off . . . you own your home and land.	

For a more expensive home:

Appraised value of property	\$7500.00
Total down payment	900.00
F.H.A. mortgage	6600.00
Average monthly payment over 20-year period (including principal, interest, mortgage insurance)	\$ 43.38

The purchase, or building, of your house will probably be the biggest single financial transaction you will ever undertake. Only if you have a super-abundance of funds can you afford to experiment. Few people have the technical knowledge to tell the difference between a well-built house and a poorly built structure. As the F.H.A. points out:

The very elements which make the proposed loan a 'good risk' to the lender and to F.H.A. are the same elements which assure the borrower of a sound investment, good construction, livability, and comfort in his new home.

A Little House Can Grow Into A Homestead



1. Here's a pay-as-you-go house that starts small and can grow step-by-step. In fact, maybe you can pay for additions out of savings made by raising your family's food.



2. Added to the main section is a nice garage and root cellar . . . garage should be deep enough to provide space for a workbench in rear and garden tools.



3. A dining room, or better yet, a "Harvest Kitchen," has been added. The house now becomes a real homestead.

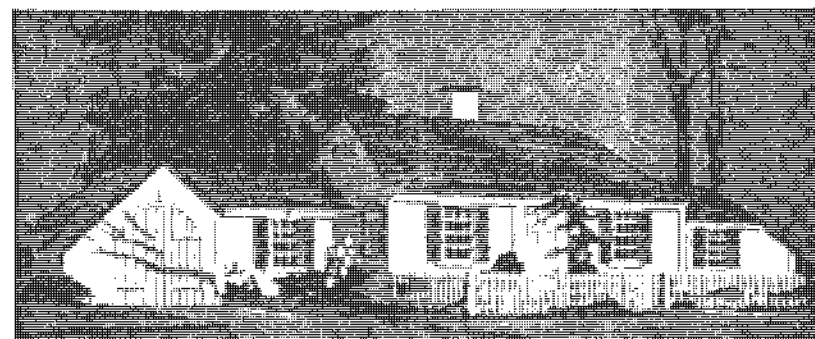

4. Finally, another bedroom (at right) is built. The so-called Cape Cod style lends itself particularly well to growth.

"Score-Card" of What To Look For In a "Have-More" Homestead

I. LOCATION

Owner's or Broker's Name and Address:

.....

Distance to your job ... Commutation Expense

Time Condition of Roads in winter

In spring Distance to: schools (school bus) to church to town Telephone Available ... Electricity ... Mail Del. ... Express ...

II. WATER SUPPLY

Town water..Artesian well..Shallow well..Spring..

If other than town water have tested by State Health Dept. (free). Be sure you have a minimum of 2-3 gallon flow per minute *even in dry season.*

III. SEWAGE DISPOSAL

Municipal septic tank cess pool

IV. LAND

Total Land Available

Should be at least ¼ acre of good, level land. Total of 2 to 5 acres to include orchard, pasture, hay field, and land to grow some stock feed.

Size of GardenDepth of Soil

For family of five should eventually be 100 x 150. Dig holes several places. Top soil should be 7" deep; 12" is better. Important: if top soil only 6" or 7" subsoil should then not be hardpan or deep gravel.

Pasture

½ to 1 acre for goats; 1 to 2 acres for cow.

Hayfield

Not necessary—but will save you buying hay. 1 to 2 acres for 2 sheep; 2 acres for steer. ¼ to ½ acre for goats; 2 acres for cow.

Land for grain crops

Part time farmer probably won't have time for grain. Additional 4-12 acres necessary to grow all livestock grain.

Woodlot

Enough for fireplace—fenceposts, etc.

Lay of land

At least ¼ acre level; also hayfield level—pasture, woodland need not be level.

Natural Fertility

Observe present garden, vegetation, etc. Watch out for poor drainage, too sandy or too much clay, too many large stones.

V. OUT BUILDINGS

Garage Tool House Workroom Barn

Poultry House and/or Barn

Barn for dairy, rabbits and poultry ideally should contain a minimum of 500 sq. ft. floor area.

VI. HOUSE (see diagram page 11).

VII. ORCHARD

Apple Peach Cherry

Plum Grape Raspberries

Strawberries Blackberries Blueberries

Currants Asparagus Rhubarb

An established orchard in good condition is worth money. For a family of 5 this should contain: 5 apple, 3 pear, 5 peach, 3 cherry, 2 plum trees, 10 grape vines. . . Small fruits: 50 raspberries, 100 strawberries, etc. (See pages 26-29).

VIII. OTHER

Shade trees

Fencing

(Good fencing is worth considerable)

Length of growing season

(Should be 120 days from frost to frost)

Neighborhood ... Land values going up or down ...

Kind of Neighbors

Possibility of disposal Selling Renting

Extra land available

Desirable place to retire to

Other people in neighborhood raising family food.....

Note tax rate Delinquencies in town

Is title sound Have lawyer search title

Any zoning restrictions against raising livestock, etc....

Asking price

How long property owned by seller

Assessed value

Insured value

What price did owner pay

(Sometimes you can get an idea by inquiring at the town recorder's office)

Why does he want to sell

Is there a mortgage\$.....

Down payment needed\$.....

Estimated cost to repair\$.....

WATER . . . SANITATION . . . ELECTRICITY . . . ROADS

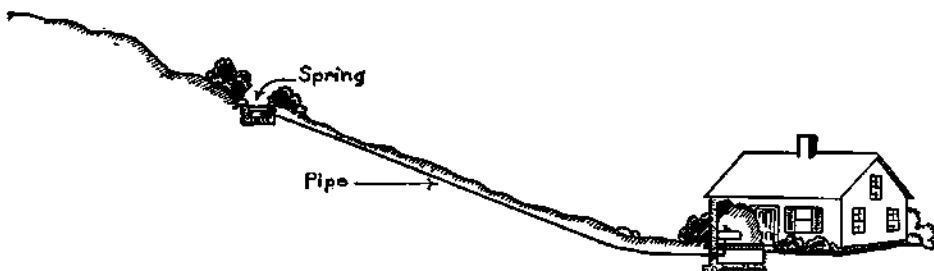

A **SPRING** is simply an opening where water flows out of the ground. It may be located at the bottom of a pond or lake. If you have a good spring near your house you may be saved the expense of digging a well. And if the spring is located on a high enough level you may be able to use a gravity system instead of a pump.

WHEN we bought our house in the country the water, sewage, electricity, and driveway were supposedly all finished. They looked all right to us. But we've had to spend additional money on all four.

Our main expense was the need to rebuild our sewage system—the builder had installed a minimum amount of drainage pipe and no siphon discharge system. We've also piped water to our barn and to our concrete pig pen. It was an easy job to wire our barn with electricity.

We've had to add more fill and build an edging to our driveway. In short, we've found that knowing a little about country water supply, sewage, electricity, and road building is most worthwhile.

If you are used to city water service, you probably think it means an awful lot of expense and trouble to have your own rural water supply. The expense of digging a well is uncertain because you can't be absolutely sure how deep you will have to go. Still there are a lot of people living within 100 feet of a town water main who find it is less expensive to dig their own wells than to buy water from the city. One man I know, who is now building a house in town, has discovered that installing city water will cost him about \$300. On top of this he will have to pay a water bill of about \$25.00 a year. He figured up this bill for a period of ten

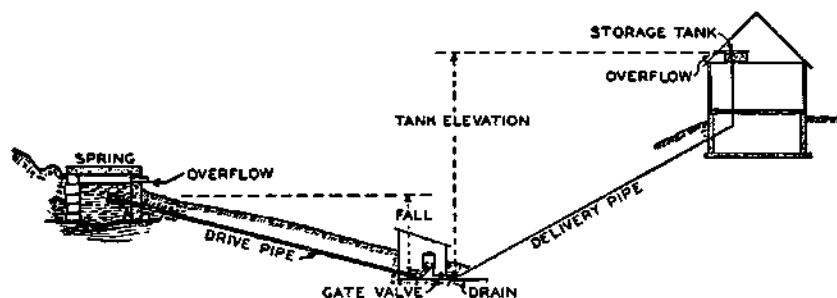

A **RAM** is really a sort of pump but it requires no electricity or gasoline and has no moving parts and is completely automatic. The water virtually pumps itself. There must be at least a 20 inch fall of water between the source and the ram. Under these conditions the ram will pump water to a much higher level, as high as 20 feet.

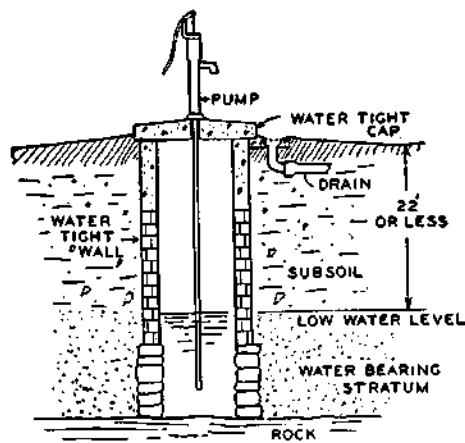

A **DUG WELL** is the kind that is actually dug with hand digging tools. This is the old fashioned type of well you see on many farms today. Wells are not dug by hand so often nowadays as they used to be because it is frequently easier to get a well driven or drilled. Another reason is that the dug well is more easily contaminated by seepage through the walls or from above. On the other hand, this type of well if properly constructed can be kept entirely pure and provide plentiful quantities of water for generations. If you're thinking of digging a well yourself, you'll want to learn more about this kind of well.

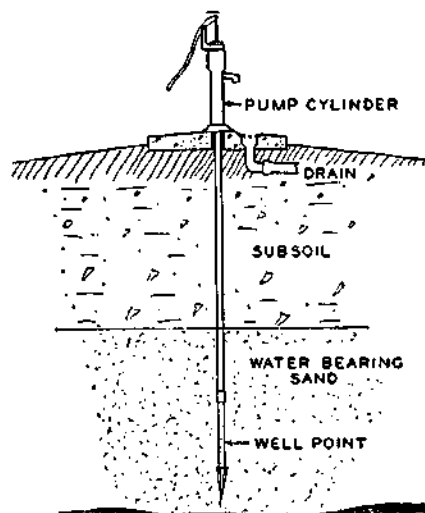

A **DRIVEN WELL** is made by driving into the ground a simple pipe fitted with a well point. It may be either a deep or shallow well, depending on how deep you go to get a satisfactory flow of water. If your soil is suitable for this type of well it is something worth investigating for it usually costs less than drilling a well or digging one. It is not generally considered as reliable as an Artesian well (which produces a steady flow of water), but in some sections it is quite satisfactory. You need a good sized storage tank and you should know what to do if the well points become clogged.

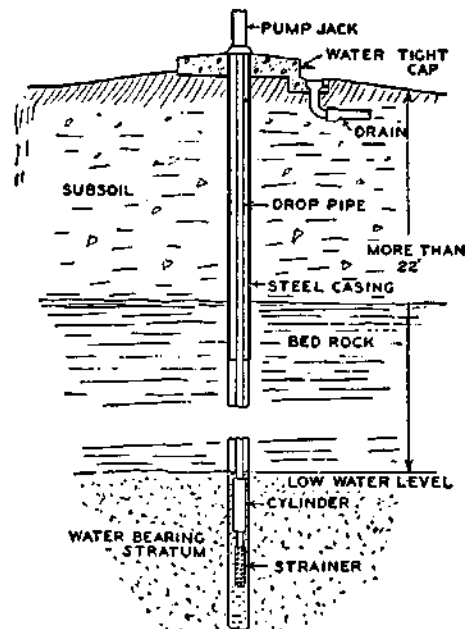

A **DRILLED WELL** is made by drilling a hole into the ground 4 to 8 inches in diameter with special well-drilling equipment. The upper part of this well is lined with a steel casing which protects it from contamination. If you think you will have to go down deep to get water, you should learn more about drilled wells. Also you will need to investigate deep and shallow well pumps. The cost of a shallow well pump is much less and can be used with a good Artesian well when you don't have to pump water up from over 22 feet.

LOCATING THE RURAL WATER SUPPLY

years (\$250) and added it to the \$300 he would pay for installing the city water, getting a total of \$550. When he compared this cost with that of drilling a good Artesian well 100 feet deep and putting in his own electric shallow well pumping system, he found that the city water over a 10 year period would cost him \$50 more . . . And in 20 years this city water would cost \$260 more. In 30 years he could install an entire new pump and tank and still beat the cost of city water for this period by \$400!

Here is a comparison of costs:

YOUR OWN WATER SYSTEM

Low Estimate

Drilling 50 ft. well (@ \$3.50 per foot)	\$175
120 gallon tank	40
Labor	25
Shallow Water Pump	45
Upkeep for 10 years	30
	<hr/>
	\$315

High Estimate

Drilling 300 ft. well	\$1,050
150 gallon tank	50
Labor	50
Deep Water Pump	150
Upkeep for 10 years	50
	<hr/>
	\$1,350

CITY WATER SYSTEM

Installation	\$300
Water bill for 10 yrs.	250
	<hr/>
	\$550

As you can see, your well may cost you anywhere between \$175 and \$1,050. About the only way to predict this cost is to find out how deep your neighbors had to dig their wells. Unless there is something unusual about your situation, you will probably have to go to the same depth. Be sure to have your well water tested for purity. The Health Department will make this test free in most states.

We've discussed a few of the many ways you can obtain water in the country. There's probably one combination just right for your circumstances.

Sewage Disposal

If you don't have city sewage disposal there are three practical solutions to your sewage problem: a cesspool, a septic tank, or a septic tank with a siphon discharge system.

Maybe you can use a cesspool, but on a long term basis you should consider spending a little more money and getting a septic tank.

After we bought our place, we discovered that our septic tank didn't have a siphon discharge system. This caused fouling of the ground near the tank. We had to dig up the whole system and found a siphon discharge tank was needed. The siphon discharge method distributes the sewage more forcefully so it spreads over a much wider ground area. Sometimes you can get by without the siphon discharge feature in a vacation home.

Electricity

If your house has never been sup-

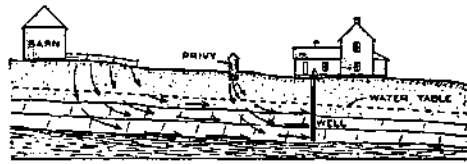

BAD—This well is located too near the barn and sewage disposal system. Sewage seeps into the well or drains directly into ground water the well uses.



GOOD—This well is located where it is not likely to be polluted by the sewage disposal system or livestock in the barn. Cesspool is over 100 feet from the well.

Here is a simple septic system with only one tank and a tile drainage field. Inside the septic tank are anaerobic bacteria which decompose a part of the solids into liquids and gasses. Incidentally these bacteria are killed by pouring strong disinfectants and mouth washes down the drain in your house.

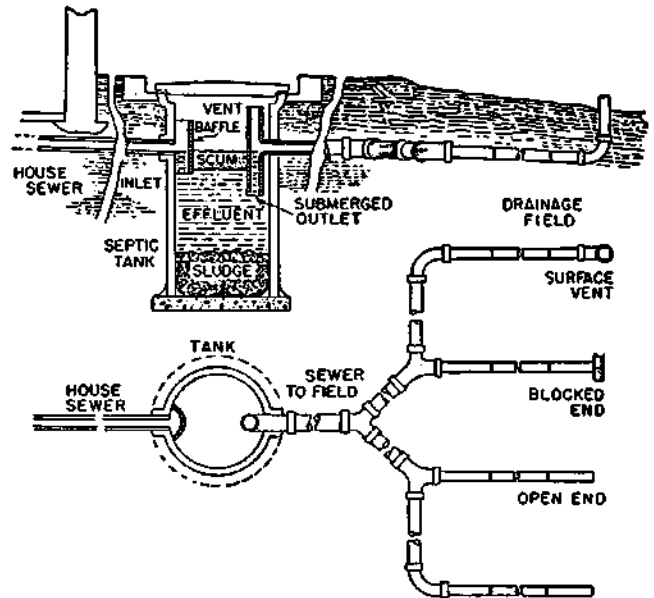

Here is a septic tank with a separate siphon discharge system. Another workable combination is a single septic tank like the one shown above which drains into a cesspool instead of a tile drainage field. The whole problem of proper sewage disposal is so important to health that it will pay you to go into the subject pretty thoroughly before you decide which system to use.

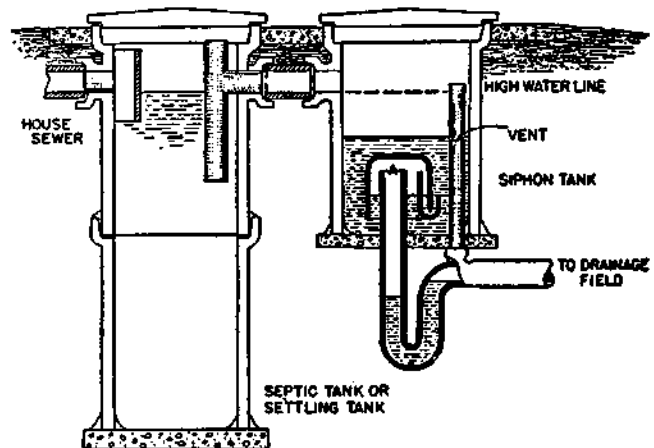

plied with electric power, measure the distance to the nearest power line. In our area the cost of getting this power to the house is about 25¢ a ft. You can reduce this cost by getting neighbors to come in with you. The more people on the line, the less each has to pay. Also, your contract with the power company should entitle you to a rebate when other people come in later. In wiring a house it's important not to underestimate the size of the wire needed. Some day you may want an electric stove, a freezer, electric power tools, or electricity in your barn and hen house so it's safer to use a no. 12 wire rather than a no. 14, the legal minimum.

Roads

Particularly today when land values are high you may save hundreds of dollars by buying land off the road and building your own road to it. Land not touched by a road may be a far more desirable site and usually sells at 30% or 50% less. If you build a road acceptable to your town or county, you can get it declared a public highway and have it kept up by the town.

Landscape Your Place—Increase the Value 20%

Developing a Plan

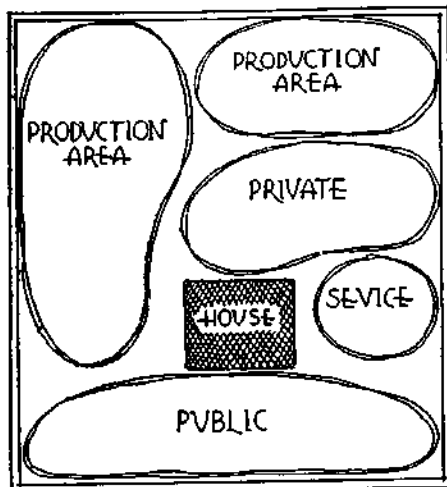

FIRST—Divide your place into four separate areas: public, private, service and production.

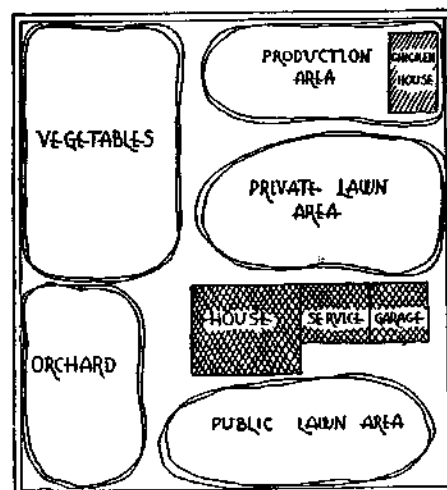

SECOND—In each area lay out the buildings, gardens, lawns as desired.

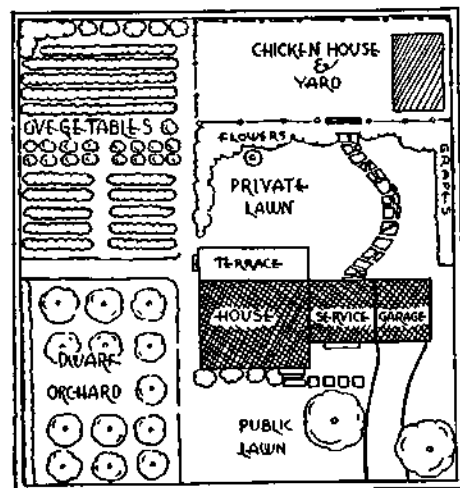

THIRD—Decide how each area should be planted to make boundaries for privacy, beauty and productivity.

ALTHOUGH our homestead is not for sale, in January of this year I was offered more than twice the amount we originally paid for it.

Part of this increase is due to inflation and the housing shortage. But even a few years from now when the housing shortage is over and inflation has levelled off—and maybe real estate prices will take a big drop—even then I feel confident that our homestead will be worth considerably more than we originally paid and will be far more desirable and easier to sell than it was when we bought it.

One big reason for this extra value is the simple combination of a few little things that improve its appearance and its outdoor livability. I don't want to call it landscaping because you may think that means we have a large estate or have spent a lot of money on fancy things whereas what we've actually done is to plant a few inexpensive trees, shrubs and flowers in the most natural places. The amazing fact is with \$25 worth of seeds and plants you can add literally hundreds of dollars to the value of a small place. More important, the place becomes lovelier and more livable. Your aim needn't be to make your yard showy—but just the kind of place people want to be in—a place that feels right outdoors.

If you'll look at the two top pictures of our place on page 10, you can see a couple of smaller changes that made a big difference. See how much better the small evergreens look compared with the tree at the corner. Also note the big improvement in the front entrance. Although it doesn't show too much in the snapshot, the picket fence (at left) gives the house a longer look.

Next time you are driving in the country look at the difference in various houses. Some seem bleak and undesirable. Others seem friendly and inviting. Often you see a new expensive place equipped with many modern improvements that you just wouldn't want to have for yourself. Then you'll notice a less expensive, less modern place, perhaps with a nice orchard and an informal hedge of berry bushes and several nice shade trees. This sort of place, though less modern, is the one that says "home".

Just what is it you do to a country place to make this difference? Here are a few suggestions—a five year plan that can greatly increase the value of a small homestead:

A 5-Year Landscape Plan

1st Year

Become familiar with basic landscaping methods so you can work out a good plan for the entire place. Make a pencil layout of your land showing the

house, road, driveway, nearest neighbors, barn, vegetable garden, etc. On this drawing show where you want to plant shade trees, fruit trees (dwarf), hedges and vines. Then mark desirable spots for flower beds, climbing roses, etc. You may need a screen of privet hedge or hemlock for privacy or to conceal the laundry yard or compost heap or close neighbors. If you want tall trees in a hurry, consider the fast-growing poplars—also privet hedge will grow high in one season. You can plant beds of perennials the first year too, but plant only as many as you can manage. Plant the trees, vines and shrubs first because they will take several years to grow and develop. If you don't like cutting the grass, you needn't have a large lawn. You can make it small by setting a hedge of brambles or berries, for instance, at the desired limits and beyond plant a beautiful field of alfalfa or clover.

2nd Year

Finish planting the flowers and any shrubs still desired. Be sure to have some good perennials (peonies, chrysanthemums, iris, hollyhocks). Study up on outdoor furnishings—maybe a terrace near the house or a trellis for climbing roses or grapes. Decide where you'd like to have a garden seat beneath a good shade tree or possibly an arbor with a love seat, swing or hammock.

3rd Year

Develop your present plantings a little more as needed. By now you may be ready to add the trellis you've been planning and some simple garden furniture. A brick walk set in sand can be very attractive and is easy to do. Consider adding a combination fish pond and garden pool using it partly as a fence with a border of blueberries. Any steep slopes or terraces will make a good place for a rock garden.

4th Year

By now you have finished all the foundation plantings. You are getting fruit from your dwarf fruit trees and berries from your "hedges" of raspberries, blackberries etc. A few finishing touches will probably be needed in the flower bed. Try to have enough flowers so they will bloom continuously from Spring to late Fall. Plant borders along the front walk from the house to the road.

5th Year

The plan should now be about complete, but you will see obvious improvements. For instance, you may want a little more variety now in your flowers and fruits. See if you can't find a few interesting and different varieties in your reference library. Consider ways to blend your animals into the general

scheme—especially ducks and geese in the pond, goats in the more wooded section, sheep on the more distant slopes. By now your experience, plus a little study, will tell you what is needed.

Be sure to take a picture of your homestead before you start this plan and another after it is completed. I'll bet there will be such a difference in the two photographs that you will hardly recognize the old place.

Now finally, to save you needless expense on plants and seedlings and flowers, here are a few practical tips:

- 1.) Always have your holes dug before you get the plants for transplanting.
- 2.) Transplant immediately—don't give the plants time to dry out or they will die.
- 3.) Plan to get "bare root" plants in early Spring or late Fall. At this time it is not usually necessary for plants to be balled and burlapped (as it is in the Summer) so you will save money.
- 4.) Don't buy more plants than you can plant in a day.
- 5.) Most big nurseries have a surplus list of trees and bushes which have grown so large that they must be transplanted. These are often reduced in price "for clearance". They will be perfectly healthy plants if you are dealing with a reliable nursery.
- 6.) If you learn enough about trees and plants and flowers you can master the trick of getting them from the woods and having a "wild garden" on your own grounds. Many varieties cannot be obtained in any other way.

At the right you'll find two aids to landscaping which can be a lot of help. First of all at the top are the two little diagrams showing the "wrong way" and the "right way" to arrange plantings and driveway of a small area. It shows pretty clearly what a mistake it is to just plant anywhere, how you can spoil the looks of your place by bad planning even though you may spend a lot of money for pretty flowers and beautiful trees. Of course you can avoid this by having a landscape architect, but we don't think that is necessary for a small place.

If you will do a little reading on the subject you'll find landscaping is simple and it's easy to learn the don'ts.

Below the "right-wrong" diagram is a landscaping score card which we've adapted from a farmstead score card put out by the Agricultural Extension Service at Ohio State University. You may not agree with all of the things listed here—some points are largely a matter of personal taste and a great deal depends on your locality. But we think you'll find this score card very useful just the same, for checking over your own place and finding ways to improve it.

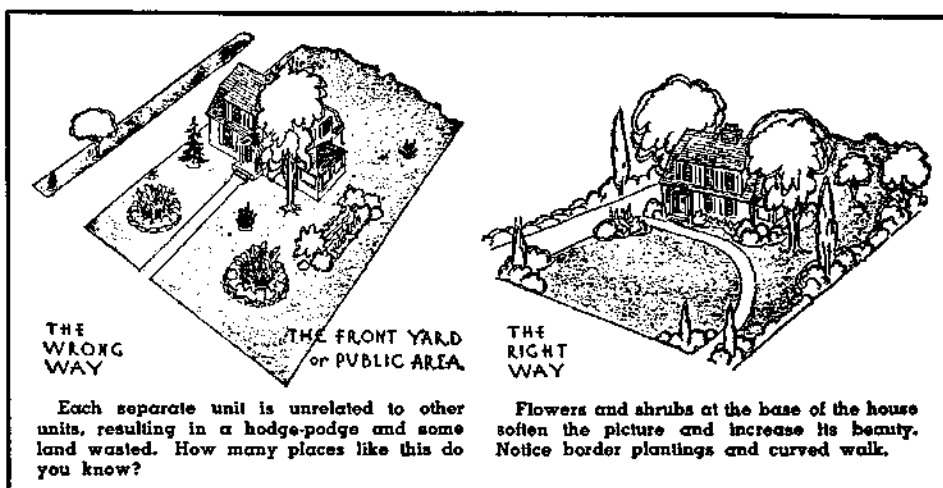

THE WRONG WAY

THE FRONT YARD or PUBLIC AREA

THE RIGHT WAY

Each separate unit is unrelated to other units, resulting in a hodge-podge and some land wasted. How many places like this do you know?

Flowers and shrubs at the base of the house soften the picture and increase its beauty. Notice border plantings and curved walk.

Score Your Own Homestead

	Value points	1st scoring	2nd scoring
I. — CONDITION OF GROUNDS:			
1. Arrangement—well separated areas for lawn, service, storage, stable yards, etc.	8		
2. Livestock and poultry in pens away from house and opposite direction of prevailing winds.	6		
3. Drainage of ground — good natural drainage or by grading and tiling, if necessary.	4		
4. Convenient system of walks and an attractive driveway, hard surfaced.	3		
5. Freedom from rubbish and scattered machinery.	3		
II. — LAWN:			
1. Well graded. Surface should sag rather than bulge. Should slope away from the house in all directions.	5		
2. Should have a smooth dense turf free from weeds.	5		
3. Should have no flower beds, trellis, or benches except around edges. Center should be open.	3		
III. — BUILDINGS:			
1. Dwelling			
a. Good design. Simple, seems to belong to setting.	7		
b. Well painted and in good repair.	4		
c. Appears as the most important building of the homestead as seen from the approach.	3		
2. Outbuildings and barns			
a. Properly placed — not too close to the dwelling.	5		
b. In good repair and painted.	4		
IV. — PLANTING:			
1. Good shade trees in rear of dwelling to form background, and in the front to frame building and to give shade on dwelling where needed.	6		
2. Screen planting of shrubs and trees to hide unsightly objects from dwelling and road.	6		
3. Good taste and restraint in use of vines on walls and fences; and in shrubbery at base of house and along margin of lawn.	5		
4. Some large hardwood trees in barnyard well protected from livestock. Protective frames on all young trees in this area.	3		
5. Some space devoted to the growing of annuals and perennials. Materials well cared for.	5		
V. — SOME PROVISIONS FOR FAMILY RECREATION: (Tennis court, outdoor fireplace, picnic area, etc., well placed.)			
	8		
VI. — ATTENTION TO BEAUTY OF ROADSIDE: (Adjacent to farmstead.) Absence of billboards. Native trees and shrubs preserved. No weeds.			
	7		
TOTALS		100	

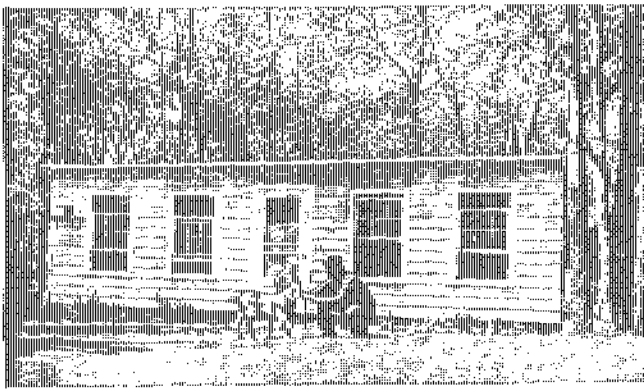

Plans for a Small Barn

THE idea for this "Have-More" Plan came to us at a party—our own "barn warming" party.

When our small "concentrated barn" was finished, we thought it deserved a celebration. And so we invited all the neighbors and our friends to come and see it. We had planned and built our small barn to house not only our milk goats and their kids, but a couple of sheep, 25-30 laying hens, a battery brooder that would produce 30 broilers a month, a six compartment rabbit hutch, a squab loft, plus storage space for grain, straw and bailed hay. Yet the size of the barn was only 16 x 30 feet, as large as a fair-sized living-room.

Of course, Carolyn and I—and Jackie—thought our small barn a thrilling place, but when we discovered how interested our guests were in all the animals and the compact, efficient layouts we had worked out for them, we saw that perhaps many people would be interested in the idea of a family producing a large part of its food in spare time on a small amount of land. Eventually, with the prodding of two friends at the party who are in the publishing business, we got this "Have-More" Plan written.

Now after producing about 75% of our family's food for about four years, we realize there are three main fundamentals which set a *productive* country home apart from the ordinary "house in the country." First, the layout of the grounds should be planned for efficient working of the land. Second, a "Harvest Room"—or a large kitchen—carefully planned for the *processing* of food, as well as the preparation, is needed to make the wife's part enjoyable. Third, an efficient small barn is a necessity—a homesteader's livestock can account for 40% to 50% of a family's food.

"Slightly Crazy!"

When we planned our barn we had almost nothing to go by. We wrote to all the barn equipment people, the lumber companies, the state and federal departments of agriculture, asking if they had small barn plans to house goats or a cow, laying chickens, rabbits, sheep, ducks, a pig, pigeons, and geese. Some of the answers indicated that the specialists thought we were slightly crazy. Some wrote of small commercial barns that we might adapt.

Well, we finally ended up with somewhere around \$15 worth of miscellaneous plans. None of them suitable for what we had in mind, however. So we set about designing our own barn. It was quite a job. We got the most efficient layout for poultry from one place, the best arrangement and style of goat stalls came from study and visits to a number of goat keepers and goat dairies. The broiler battery we bought for around \$30 and the rabbit hutch for \$20; both are of wire, sanitary, and efficient.

I was determined that our barn would be easy to operate with the best practices adapted from commercial barns and not cost us a fortune either. We moved to our country house in the fall and didn't start our barn building until the following spring. During the "long winter evenings", which actually flew by as time does at our place, we worked out scale models of goat stalls, brooder, hutch, feed storage, etc.

I was also able to locate not far away, a dilapidated horse barn and bought it "as is" for \$35. It had a lot of good siding and some usable timber in it.

Wrecking Is Fun

Wrecking the old barn was fun. A couple of teen age boys in the neighborhood got interested in my barn project and they turned out to be a big help in tearing down the old barn. In fact, if you can locate an old building to use and get it cheap enough, then I highly recommend rounding up a couple of teen age boys, buying them each a fifty cent wrecking bar, and turning them loose on the barn you want to demolish. Of course, you'd better be around to see that they don't pull the barn down on their heads.

Anyway, a Saturday afternoon and Sunday was enough time for us to get the sizable horse barn down flat. The following half-dozen winter weekends we spent in what is known as "cleaning up the lumber." This is the tedious process of going over every piece of timber and board and pulling out the old nails. Incidentally, this job is what makes it costly to hire a carpenter to take down an old building and re-use the lumber in a new structure. Usually, unless you are given an old building outright, it doesn't pay to have a carpenter pull it down, clean up the lum-

ber, and build with it. A carpenter dislikes old boards because he's apt to run his good saw into a nail and then its an hour's job to resharpen and reset it. Incidentally, an old barn is worth more than an old house—a house doesn't usually supply any more usable lumber and the wrecking job is much greater.

As we cleaned up a pile of lumber, we stowed it in our Crosley, with one of the front seats removed and the top down, and trucked it down the long hill to our place. Naturally, we piled it well so the air could circulate through it until spring.

When the ground thawed, we started building. I believe it was around the first of April when we could actually begin the trenching for the foundation. Before we started, Carolyn and I had a long heated discussion as to exactly where the barn was going to be located. She wanted it six feet closer to the house than I did. Her desire was based on aesthetic reasoning—mine on the practical point that if it were six feet closer, then I would have to dig and chop my way through a tremendous root. Finally, after we delayed the digging a weekend while we argued, we agreed to compromise because the goat we'd bought was due to kid the last week in May and we had to get the barn done so she could freshen in it—a goat is supposed to "take to" a place after she has had her kids there. We compromised by splitting the difference—only I still dug through the root.

In laying out the barn, which was to be 16 x 30 feet, I measured 16 feet one way, then 30 feet along the South side, 16 along the West end, and 30 feet along

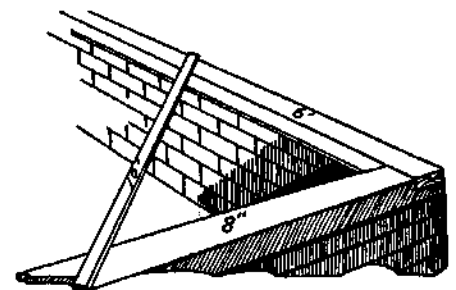

How to make a building square: measure 6 feet on the end sill and 8 feet on the side—if a cross piece then measures 10 feet (from outer edges) the building is square. This is often called "the rule of 5, 8, and 10."

the back. I connected the stakes with string and started to dig. That, it turned out later, was where I made my first mistake. I forgot, or rather didn't know, one important thing. I should have measured diagonally across corners to see if the measurements were the same. By not doing so, I wound up with a parallelogram instead of a rectangle. Not a noticeable one, but I was off about eight inches.

The foot-wide ditch I dug through stone and roots—there was very little soil as I well remember—to a depth of about two feet which is below frost level in our part of the country.

The next step was building the wooden forms into which concrete for the footing and the foundation wall was poured.

Cement—Ready-Mixed!

We ducked the laborious job of mixing gravel and cement and water to make the concrete; we simply ordered the cement ready-mixed just as a professional builder does. Ready-mixed cement delivered to the job costs little more than the materials and this is the best way to buy it when you are using a yard or more—this is the minimum amount usually delivered.

Before the cement stiffened in the forms we sunk about a dozen half-inch, foot-long iron bolts upright to use later to anchor the 4 x 4 sill to the foundation. If you have the bolts on hand it is a simple matter for the man who brings your cement to place these for you.

In two days the cement had hardened so we could take off the forms, but inasmuch as we couldn't do any more cement pouring until the next Saturday, we spent evenings tossing in stones to bring the ground inside the foundation up to within 6 inches of where the top of the floor was to be. Three of the six inches were filled with cinders.

On Saturday we were ready for the floor. The cinders were raked level and the sloping form for the dairy gutter was braced in place. The concrete floor was poured in three sections. The fellow who brought the concrete showed us how to lay two 12 foot 2 x 4's just inside the concrete foundation but three inches down from the top. Concrete was poured and the top of these 2 x 4's used as a guide for another 15 foot 2 x 4 which we sawed back and forth leveling the cement. This is not nearly as complicated as it sounds. We used wooden trowels to smooth off the top surface because we didn't want it as slick as you can make cement with a steel trowel.

The next step, according to the good book on carpentry we were reading, was to "lay the sills." This highly technical sounding procedure simply meant to take a piece of timber, in this case we used 4 x 4's from the old barn, and lay them lengthwise along the top of the concrete foundation. Where necessary, holes were bored in this sill to let the anchor bolts come through; the

washers and nuts were not screwed on for a few more days just to be absolutely certain that the bolts had hardened into the cement. The sills were set all around the foundation except where the doors were to go.

Next, at the four corners, 4 x 4 uprights (7½ feet at front, 4½ feet at back) were set in place, leveled so they would stand absolutely perpendicular by tacking a pair of braces from about half-way up each post down to the sill at either side. Then the corner posts were spiked to the sills. The 7½ foot 2 x 4's were cut and nailed up. The 2 x 4 plate, the piece that goes across the top of the studs, was leveled and nailed. Next the two end rafters were notched and fitted. The end studs cut and fitted under the end rafters . . . then all the rest of the rafters were put in place, we started boarding the sides and roof.

None of this was complicated, but it did take a good deal of time because we had to figure each step out as we went along. In fact, I would like to say right here, that there is nothing complicated about building a chicken house, a barn, or even the traditional country house. And now that the prefabricators are offering complete heating, plumbing, cooking, freezing, and laundry facilities built in one compact unit, building your own house has become about as easy as building a log cabin.

If a person has just a little manual dexterity, say the ability to drive a car, then he will have no difficulty in doing practically all the building that has to be done on a homestead. Carpenters, masons, plumbers, electricians love to make a great mystery of things—and the building codes, the building supply people, the utilities and appliance manufacturers do their best to keep the average householder from doing any building on his own. But the truth of the matter is that most of the skills of

the average mechanic are pretty simple to master. Naturally, their speed and accuracy is based on years of practice. But just as anybody who can read music can play all the notes in a difficult piano piece, anybody can build a barn or a house if he'll get some good manuals on building and good plans for what he wants to build—the difference is that in the case of the amateur at the piano, the piece won't sound right played so slowly, whereas when the building is finished, no one will ever know whether it took a day or a year to build.

Race Against Time

To return to our barn, a couple of rainy weekends, a garden waiting to be planted, plus the inescapable fact that Cassandra, the goat we'd bought but hadn't brought home yet, was due to kid in two weeks, made us call a carpenter to help finish our barn. I am not going to take time to describe in detail just how the interior of our barn was finished—you can get a good idea of that from the sketch shown below. If you want to build a small barn, we've had a draftsman work out complete details with a number of variations.

In the years that we've used our barn, we've found little that we've wanted to change. The only addition we are planning is to extend the barn another 10 feet in length to the West; this will give us more storage space which we will need when we begin harvesting our own hay. Of course, we could change the shed-roof to a gable or gambrel roof and store the hay there, but it is just as cheap to extend the length and eliminate hoisting hay into the loft and climbing up to throw it down.

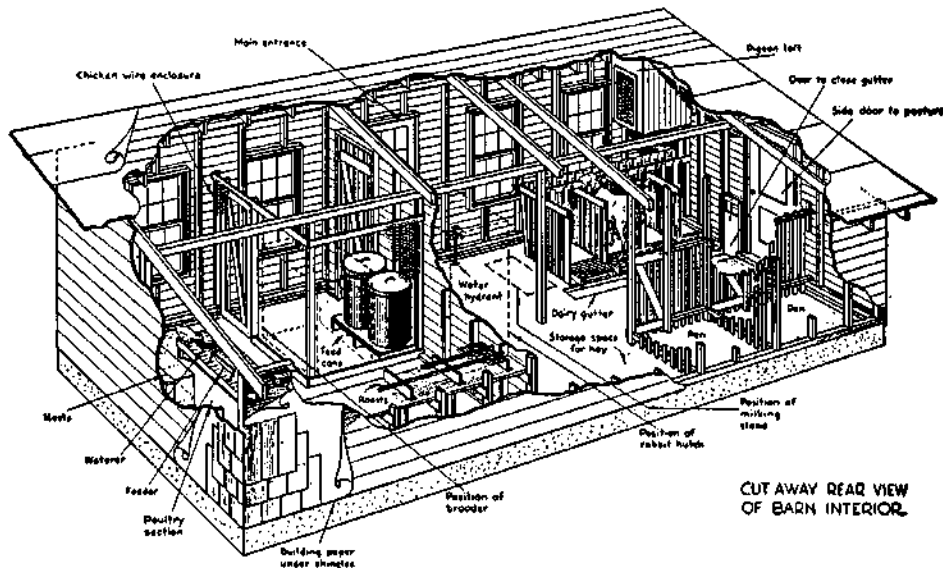

This "breakaway" drawing shows interior of our small barn. We found that this 16 x 30 foot barn efficiently houses 30 hens, 60 broilers, 20 or more rabbits, 4 goats or a cow and calf, 3 or 4 sheep, and a dozen squab. Barn cost \$200 to \$400. Bill of materials, plus complete building plans including 10 large detail drawings of front, ends, interior layout, goat stalls and milking stand, cow stalls, chicken section, squab loft also a turkey sunporch are available.

The Importance of Raising Part of Your Food

WHY do we put so much emphasis on home food production? In the first place, the health of millions of Americans would be far better if every family raised part of the food it eats.

And when we say every family, we really mean every family. No man, no matter who he is, can break the rules of health and escape suffering the consequences. Even the Presidents of the United States, we honestly believe, would be healthier individuals if they tended their own gardens and milked a family cow. Let us explain.

There are two basic reasons for raising part of your own food. First, only by so doing can you be perfectly fed. Secondly, physical contact with the good earth and livestock are the best known antidotes to the mad, hustle and bustle of our present work-a-day world.

There are many lesser reasons for owning your own home and raising part of your own food. There is the basic security of this way of life, an opportunity for the productive use of your spare time, cooperation of the family and the greater enjoyment of family life, the benefits of fresh air, sunshine, outdoor exercise, an opportunity to be creative, the independence and responsibility of land ownership, all in addition to the direct economic benefits.

3 Square Meals and Starve!

A doctor friend who read our Plan said, "Ed, you don't make clear in your Plan how important living-in-the-country and raising-your-food is from the health standpoint."

"Well, we meant to—we sure believe that country living can be healthier. . ."

I replied.

"What I mean," he explained, "is the

belief of so many physicians today that too much time is being spent diagnosing illness and patching up the sick without doing much about the cause. We're finding that basically much disease is caused by the food we didn't eat—and because the food we did eat lacked vital elements."

He spoke of how a millionaire in Manhattan could suffer from hunger as much as a share cropper. This hunger he talked about he called a "hidden hunger"—a lack of minerals and vitamins in food. Of course, he went on, we all know how a lack of iron causes anemia, a lack of calcium causes rickets, goiter is caused by insufficient iodine, night blindness by insufficient Vitamin A, tooth decay by a lack of fluorine, calcium and phosphorus. The thing, he said, doctors now worried about was how many more diseases of civilization were caused by year-in-year-out deficiencies in the food we eat. The unfortunate aspect of all this is the fact that vitamin and mineral deficient spinach looks about the same as spinach right out of a good garden!

Are You Growing Old Too Fast?

My doctor friend stimulated our interest. He opened our eyes to the vast amount of evidence appearing day-by-day on the subject of being healthy by eating properly.

For example, Army doctors found in their young patients symptoms that looked like those of old age. In the early New Guinea campaign young soldiers suffered from dejected appetites, physical and mental fatigue, reduced resistance to infection. Analyses of tinned food showed only slight deficiencies, but when supply ships came with fresh vegetables, fruit and meat,

these minor symptoms of old age disappeared.

And what about the major degenerative diseases of old age? Of middle age, rather—high blood pressure, hardening of the arteries, wearing out the heart, the kidneys, the brain?

Dr. N. Philip Norman, in a Friends of the Land Food Conference in Ohio, pointed out the harm that has been done and is being done to the health of our people by commercial food processing and by our food habits.

He told how all this stuff about vitamin pills had grown as a parasite on the nutrition-for-war-and-defense program—from a little over a million dollars in advertising to two hundred fifty million dollars a year in just four years shows what modern advertising can do with part of the truth. How much good has been done by this? Dr. Norman believes that had we eaten whole-grain cereals in our bread and breakfast food, unprocessed, untouched by the kiln drying, unexploded and not devitalized grain, forage fresh from the vine, tree, and garden—and if we had eaten the meat of animals that had been fed on whole cereals, forage rich with nutrients, especially the internal organs of these animals, and if we had drunk plenty of milk that has been not too badly abused, we would avoid most of these degenerative diseases. There is much evidence to back up Dr. Norman.

3 Ways Food Goes Wrong

Evidence is beginning to appear showing that soil and freshness all effect the mineral and vitamin content of the food we eat. Carrots raised in a mineral-rich soil are more healthful than those raised in poor soil. Hot-house tomatoes, the kind you buy in the store, have but half the Vitamin C content of tomatoes fresh from the garden. Steam-table restaurant fare has a fraction of the value of properly home-cooked foods.

Many of the so-called "fresh" vegetables you buy in the store haven't nearly the value of these same foods out of your garden. Out at Ohio State experiments show that about 43% of the "fresh" vegetables sold in stores have lost the biggest part of their vitamin content. Oranges and grapefruit lose around 30% of their Vitamin C 30 days after picking I've heard.

Now, if you will get yourself a productive home in the country, if you will take a real interest in the fertility of your soil, if you eat plenty of your own home-raised fresh vegetables and fruits, your own fresh eggs, fresh meat, use honey instead of sugar, drink lots of raw whole milk and eat whole grain bread, all the evidence says you and your family will be far healthier and live longer, more active lives as well!

Protective Foods You Should Eat Daily

FOODS	BABY 1 YR.	CHILDREN			ADULTS
		Preschool	Early School	Adolescent	
MILK, whole	1 qt	1 qt	1 qt	½ qt	½-1 qt
VEGETABLES and FRUITS					
Green, leafy, or yellow	¾ Tb	½-¾ c	¾-1 c	1 c	1 c
Tomatoes*	6-7 Tb	¾ c	¾ c	1 c	¾ c
Other vegetables	¾ Tb	½-¾ c	1-1½ c	1½-2 c	1½-2 c
Other fruits	¾ Tb	½-¾ c	¾-1 c	1-1½ c	1-1½ c
MEATS	½ Tb	1 small serving	1 serving	2 servings	1 large serving
EGGS	1	1	1	1	1

*Half as much orange as tomato. Tb = tablespoon; c = cup.

MILK, VEGETABLES (particularly FRESH green leafy ones), MEAT, EGGS and FRUIT are called the "protective" foods because they safeguard the body from a variety of diseases.

These foods are needed at all ages—not only by children and adults, but elderly people.

If you raise them on your homestead, you can eat them generously. Most of us need more calories—potatoes, wholegrain bread and cereals, butter, sorghum, and dried beans are good suppliers of calories. Eat sparingly of sugar and other refined foods!

A Good Garden With a Lot Less Work

EVEN before the victory garden boom there were so many books, articles, pamphlets on gardening that garden writers seemed to be having quite a time of it trying to be original. For example, I have in front of me a cute article in one of the "garden and home" magazines explaining how you can have cucumbers climb a fence, use carrots for borders, and make a tepee for the children by planting pole beans.

Well, maybe garden articles like that appeal to some folks, but what we wanted at our place was somebody to tell us how to raise a lot of vegetables with as little work as possible.

We weren't interested in gardening as a hobby. We wanted to make it pay and believed we could. We knew that out of every dollar's worth of vegetables my wife bought at the store 60 cents went for marketing and handling.

Our first garden was small—about 30 by 40 feet. We simply dug up the ground, mixed in a little all-purpose commercial fertilizer, bought some seeds at "the corner drug store"—and, needless to say, our garden was pretty much of a flop. Some vegetables grew fairly well, but most didn't. And the insects got more out of it than we did.

We were discouraged. Like many city people we thought a garden was "duck soup". But we've found out that

our garden is our most exacting and complex project. Producing eggs, or chickens, or milk, or honey, or pork requires less knowledge than having a good garden. The one especially attractive point about a garden is that even though it is complicated and considerable work, it does not have to be tended every day or twice a day as do livestock. At any rate I wanted to say, don't let your gardening difficulties discourage you from considering livestock projects—it's easier to produce a dozen eggs than a bunch of carrots.

Before we planted our second garden we made up our minds to find out how to do it. I guess maybe we studied a hundred books and pamphlets. Or rather, after reading the first dozen, we skimmed through the rest. We found ourselves reading and rereading the same basic facts.

After our reading, we went ahead with a much larger garden. We planted according to plan and beginning in May had all the fresh vegetables we could eat. In addition, we canned and froze about 275 quarts for winter use. According to Carolyn's figures, our garden saved about \$200—that's \$200 over the \$22.50 we spent for plowing, seeds, fertilizer, and spray.

Looking back over our experience, we have singled out certain fundamentals and ideas we would like to pass along because we believe they will be helpful to anyone interested in having a good garden with less work.

First, we are living in an exciting, revolutionary era—not the least important is the revolution that is taking place in agriculture—particularly in soil conservation. Louis Bromfield summarizes it thus: "The American farmer has largely worked against Nature. Our new agriculture will be based on the principle of working with Nature".

Probably you've read reviews of Edward Faulkner's startling book *Plowman's Folly*. If you haven't read it, do by all means. Briefly, from the Homesteader's standpoint, the implications of Faulkner's theory mean that by more natural care of garden soil—the incorporation of humus and manure into the top soil instead of plowing it ten inches underground—phenomenally more productive crops can be grown. Moreover, these healthy crops need less cultivating, watering (and stand up against attack by disease and insects.) In short, better gardens with a lot less work!

Of course, Mr. Faulkner's theories are not entirely proven as yet nor are they entirely new. Many government, state and independent agriculturists have been experimenting along the same lines for a long time. However, his ideas are stimulating and we think you'll profit by reading about them.

Then, too, the new plant hormones

and insecticides are evidently going to make gardening more scientific.

SEVEN FUNDAMENTALS

1. Get Your Soil in Shape

Almost any soil can be made to produce lavishly. But poor soil takes money and time—perhaps hundreds of dollars and years—to put in first-rate shape. For this reason before you buy a place it's a good plan to have

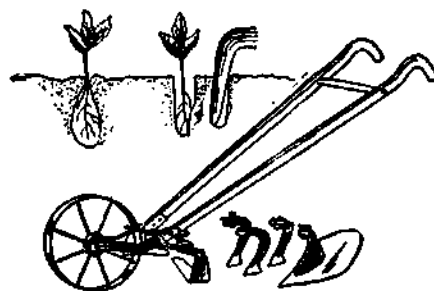

Plant at upper left improperly set out. Soil should have been pressed tightly about roots. Use dibble as shown. WHEEL HOE and attachments make planting and cultivating a lot easier.

soil analyzed; check for hardpan, excessive sand or clay condition.

Even if your soil looks good—have it analyzed. You may buy a soil test kit—they sell for as little as \$2.00. Or you can send it to your State Agricultural Experiment Station for a free analysis. For the address, ask your local paper or seed store.

Organic substance is the primary means of building good soil. The best source for this substance is barnyard manure. Goat manure is excellent. So, too, is cow manure. Poultry manure is extremely rich in nitrogen. Barnyard manure is usually difficult to obtain—but you will have plenty if you carry out the well-rounded livestock operation suggested in this Plan.

Barnyard manure increases the ability of the soil to hold moisture, keeps the soil loose and promotes root development. The best way to handle manure so it won't lose its value is to compost it as shown in the accompanying diagram. Ideally each year a plot 30 x 60 feet should receive a ton of stable manure.

In the summer when the garden is planted, manure can be used mixed with straw or bedding, etc., as a mulch. But take care not to let it come in direct contact with plants. Leaves, straw, hay, garbage—anything that will decompose should be dumped onto the compost heap and after ripening worked into the top soil. Don't bury this humus material by too deep plowing. If you are making a garden in sod land and must plow deep—then plow twice—once in the fall, then in the

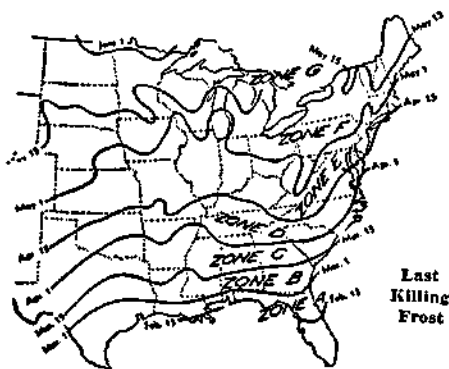

Last Killing Frost

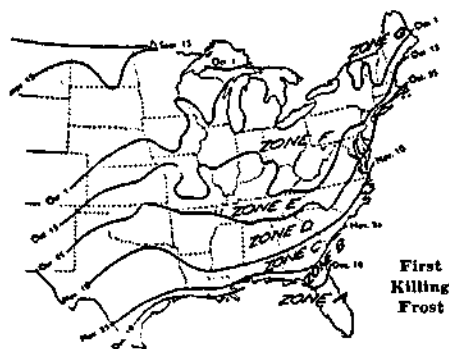

First Killing Frost

Frost dates for western states vary according to elevation as well as latitude. Accurate dates can be had by writing your State College of Agriculture or Weather Bureau.

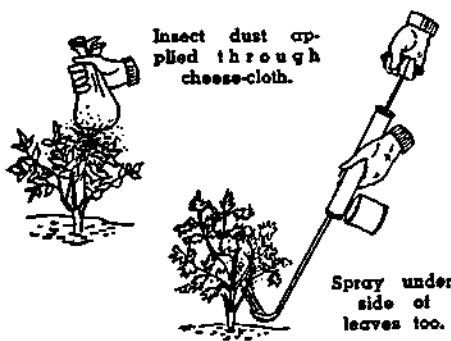

Insect dust applied through cheese-cloth.

Spray under side of leaves too.

spring plow again and bring your valuable top soil back to the surface.

Your soil test will undoubtedly show a deficiency in one of the three basic fertilizers—nitrogen, phosphoric acid, potash. The relationship of these has been worked out for the requirements of various types of vegetables. You can buy various combinations of these three elements—called commercial fertilizers—and work into your ground as you plant. A small application of commercial fertilizer usually brings a greater percentage gain in your harvests than a large application. Remember, commercial fertilizer is only a supplement to barnyard manure. Your soil test will supply you with directions as to the amount of commercial fertilizer you should use. Oftentimes, only super-phosphate is needed when you use barnyard manure. Incidentally, hardwood ashes contain potash; up to 50 pounds per 30 x 60 plot should be mixed into soil annually.

On richly fertilized land plants grow faster and are superior; incredible as it sounds, production of a given amount of vegetables may then take 1/5 as much land—likewise the time required may be cut to 1/5. Insects, too, find it more difficult to ruin healthy plants grown in rich soil.

2. Buy Suitable Varieties of Seeds and Plant According to Specifications

This needs no further explanation. Get seed catalogues in the winter—plan exactly what you want. (See chart on page 24). You can start some seeds, requiring an early start, growing in February or March, either indoors, or in a hot frame. Originally, we found spring so busy with our baby chickens, kids, geese, and young pigs arriving, that we bought tomato, cabbage, peppers, etc., from our local nurseryman as plants. Plants, of course, cost more than seeds. Now we are growing our own plants in our "Harvest Kitchen" greenhouse window.

Most vegetables require warm weather to grow. Don't be in too much of a hurry to plant early; once a seedling is stunted it will never attain normal growth.

Mark rows with a string to get them straight. Make a shallow trench—depth according to seeds—with a hoe. Scatter seeds evenly, cover with fine soil, pat down firmly with back of hoe.

When plants are up to a height of 2 or 3 inches, thin according to seed

man's directions. Even if this seems to leave too few in a row—do it, don't crowd plants. Beets, carrots, greens can be grown large enough so plants pulled in thinning can be eaten.

3. Cultivate, Weed, Mulch

Cultivate between rows with a hoe or wheelhoe often—after every rain—at least once a week during early growing season. Hand-weed along the row as necessary. Be careful not to cultivate so deep you disturb roots. As soon as plants are large enough we find a mulch of bedding from the barn laid between the rows keeps down weeds and holds moisture. This is a real labor-saver.

4. Spray or Dust on Schedule

Garden insects need not cause undue damage if you are ready for them with an insecticide and your garden sprays. Walk through the garden daily to inspect for insects. Read up on insects before they hit you.

One of the most discouraging things to the novice reading about garden insects is their great variety. But classi-



Mexican Bean Beetle



Green Cabbage Worm and Looper



Aphids



Flea Beetle and Injured Leaf

fied according to method of control, the whole question of what to do about garden pests becomes simple.

By far the greatest majority of insects and fungus diseases fall into four classifications according to their method of control:

Type 1. Sucking insects, such as aphids (plant lice), thrip, leaf hopper, and scale. This class of insects feeds by inserting their sharp slender beaks into the leaf stem or blossom, drawing forth the sap which is the vitality of the plant. Contact insecticides applied to this class of insect enter the body by penetrating the skin or pores, causing death by corrosion of the tissues or suffocation. Thorough spraying giving complete coverage on both upper and lower surfaces of the leaves, important.

Type 2. Leaf-eating insects, such as beetles, slugs, worms, caterpillars that eat holes in leaves, are effectively controlled by a stomach poison. Insect eats spray or dust that is on the leaf, the poison becoming effective when mixed with the digestive juices in the stomach.

Type 3. Certain blight and fungus diseases, including leaf-spot, rust, mildew, and anthracnose are satisfactorily controlled by a preventive with copper or sulphur the active ingredient. The tiny disease seeds (spores) ever present in the air are prevented from gaining a foothold on vegetation where a copper or sulphur fungicide has previously been applied. Even after fungus has gained a start, spraying with fungicides will retard and, in some cases, eliminate the disease.

Type 4. Migratory insects (leaf chewers) such as grasshoppers, ants, cutworms, sow bugs, also slugs or snails, don't live on plants but crawl along the ground, generally at night, destroying much vegetation. These crawling types of insects can be controlled by the use of poison baits, poison syrups, or under certain conditions, a sticky substance easily applied which will act like fly paper. (See chart page 24).

5. Irrigation

Probably more harm than good is done by water applied to home gardens. In arid and semi-arid localities watering is, of course, not only necessary, but a whole subject in itself. However, in most sections of the country, except for occasional droughts, a good rain every ten days is all any garden needs. Light sprinkling is bad. If rain does not come, one of the best and easiest ways to water is a rotary sprinkler attached to end of your garden hose and held in one spot for at least an hour. The ground thus soaked needs no more water for ten days to two weeks of dry weather. Cultivate soil after rain but not until surface dries out.

6. Harvest When Tender

Vegetables don't grow evenly from day to day—a warm day following a good rain may push vegetables ahead as much as a number of days not suited to growth. You must inspect the garden every day as vegetables begin to ripen. Pick most on the tender side—they'll taste even better if they're not quite as large as the longer, older, heavy type you are accustomed to buying in the store. Particularly when canning, choose the tender. Never pick ahead of time—wait until just before

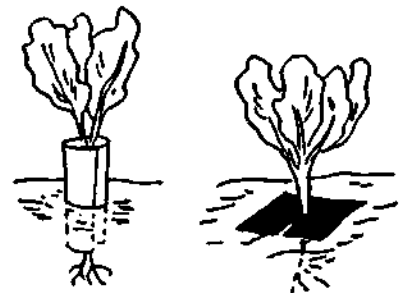

Cardboard or stiff paper wrapped around plants protects them from cutworms. Stiff paper (about 4 inches square) protects against maggots.



Succession planting

you're going to use them before bringing fresh vegetables from the garden. Try putting the water on to boil before you pick sweet corn—and cook it only 7-8 minutes for one of nature's most tasty feasts!

7. Keep Your Ground Planted in Green

As soon as your last vegetables are out of the ground in the fall, roughen up the soil and plant rye. This will get a good start before winter and grow again in early spring. When you are ready to plant in spring, incorporate this green manure into the top surface of the soil by disc harrow, or by fork and hoe. This green manure will decay fast when left in top soil and provide natural plant food for your seeds.

Hints for Easier Gardening

New land almost always requires lime to alkalyze the acid content resulting from leaf decay, etc. Your soil test will show whether or not your soil is acid or alkaline and tell you specifically how much lime or possibly its opposite, aluminum sulphate it needs.

An easy way to see that plants get proper amounts of lime is to divide the garden into four sections and lime one section heavily for vegetables in the first group, lime second section moderately, etc.

These require heavy Liming

(3-5 lbs. on 22 foot row every 3-4 yrs.)

Alfalfa	Cabbage	Lettuce
Asparagus	Carrots	Onions
Barley	Cauliflower	Parsley
Beets	Celery	Wheat
Blue Grass	Clover	

These need moderate Liming

(2½-3 lbs. on 22 ft. row every 3-4 yrs.)

Broccoli	Endive	Radish
Chicory	Kale	Raspberries
Corn	Leek	Red Clover
Cucumber	Melons	Rhubarb
Eggplant	Peas	Spinach

These need small amount Lime

(1-2 lbs. on 22 foot row every 3-4 yrs.)

Beans	Pepper	Turnip
Cowpeas	Rye	Rutabaga
Gooseberries	Squash	
Oats	Tomato	

No Lime for these— injury will result from Lime

Blueberries	Grapes	Pumpkin
Cranberries	Plums	
Parsnips	Potatoes	

Natural or Artificial Manure? There is, as probably many of you know, practically a pitched battle going on

amongst two groups of Agricultural Experts as to whether or not fertility is best kept up by use of artificial (chemical) fertilizers or organic substances. The "organic" group ask, "Are Chemical Fertilizers Ruining our Health?" They believe that only properly composted organic matter and barnyard manure should be used to preserve the soil's fertility. On the other hand, certain advocates of chemical fertilizers advocate "soil-less culture"—or growing vegetables solely in chemical solutions. The extreme in either method is costly. Generally, as far as we can judge, soil-less culture certainly seems a passing fad; and more and more attention seems to be given to methods of keeping the soil fertile by putting back manure and humus.

The poor "backyard gardener" is, however, in a tough spot if he is not willing to keep some animals. Right now, he has a hard enough time to gather leaves, garbage, etc., etc., to make his compost and with the new "electric garbage disposal sinks" which chew up garbage and send it down the drain, he's still harder pressed.

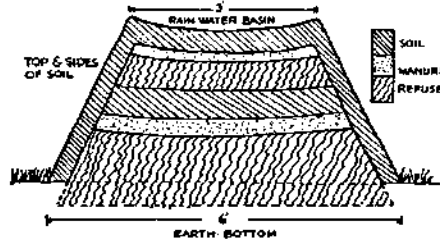

How to make a compost heap

Almost all garden books go into great detail explaining how to build a compost heap—a method of turning waste foods, leaves, inedible garden produce, kitchen parings into humus. Building a compost heap takes a lot of time. First, you choose a shady place for the compost pile. . . build pile in 6 inch layers, keep level, wet it down if necessary every week for 8 to 12 weeks, and then cut through the pile with a sharp spade . . . build it up again, keep watering for 8 to 12 weeks more, then it should be ready to use. . . but it's better after two years. Even then, when you're all done, you have an inferior substitute for barnyard manure. At our place, we don't bother much with a compost heap in the sense that we gather leaves, etc., etc. We feed surplus kitchen parings, vegetable husks, lawn clippings, etc., to the goats, chickens and geese, and in about 24 hours we have excellent manure.

However, to keep manure from losing its value as it will do if exposed to sun and rain, we pile alternate layers of manure and bedding, as shown, and cover with dirt. If this is turned once or twice during a good solid rain it will make excellent humus in six months, winter excepted.

Stake Tomatoes? Peas? In the garden books, you'll find all sorts of flossy ways to stake up tomatoes, Commer-

cial growers rarely bother with staking. And at our place we save a lot of effort by cultivating tomatoes only once, then *mulching* with 3 inches of poultry litter. Tomatoes then grow beautifully, don't require weeding, cultivating or watering. A few will rot on the ground, but simply plant a few extra.

Intercropping? This is the practice of growing 2, 3, even 4 crops on the same area at one time. Quick maturing crops like radishes, lettuce, beans, spinach may be between rows, or in rows of eggplant, tomatoes, melon, okra, or other crops which utilize ground for a complete season. This is all right where your garden is small—but it's lots easier planting, fertilizing, cultivating, spraying, not to do this.

All Purpose Sprays. There are on the market a number of "all purpose" sprays which attack many types of chewing as well as sucking insects. Obviously, these save effort.

Perennials. Asparagus, rhubarb, Jerusalem artichoke and horse-radish may be left in the garden all-year and are practically self-perpetuating.

Leave Ground Rough. Some gardeners are forever worrying their soil: treading, raking, plowing. Faulkner shows that land apparently produces much better when supplied with plenty of humus which is worked into the top of the soil by disc harrow and left rough. In fact, he points out that the ideal is to make your whole garden a sort of compost heap.

Plant Late. Usually garden writers say take a chance on losing some seed—plant as early as possible. We find it easier to plant a little late. We don't waste effort and seed this way. Anyway, with our well supplied freezer, plus Jerusalem artichoke, parsnip, and asparagus as early vegetables what do we gain by chancing early planting?

Transplanting. Transplant only when you must. Most transplanted plants get a set-back from which they take time to recover and resume growth. And, of course, unnecessary transplanting is wasted effort.

Easy to Grow Vegetables. Beans, beets, broccoli, cabbage, Chinese cabbage, carrots, celtuce, chard, corn, endive, kale, lettuce, okra, onions, parsley, parsnips, peas, potatoes, radishes, rhubarb, spinach, squash, tomato, turnips, Jerusalem artichokes.

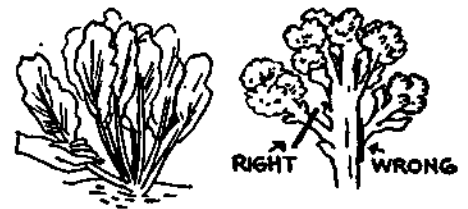

Harvesting swiss chard and broccoli

Vegetable Planting Chart

VEGETABLE	Rows apart feet	Plants apart in row, inches	Planting depth, inches	Seed for 50 feet	Days to germination	Days to yield	Buy plants or seeds	Possible yield per 50 feet of row	For a family of five, Summer and Winter Supplies		Common Insect Pests and Suggested Control
									Row Length	No. of Plantings	
Artichoke, Jerusalem	3	20	3	1/2 peck	8-12	120-140	P	1 1/2 bu.	100	1	Seldom bothered.
Asparagus	2 1/2	20	6	30 plants	8-10	2 yrs.	P	25 bunches of 1 dz. each	100	...	Asparagus beetle. Rotenone.
Parsnip	1 1/2	4	1/2	1 pkt.	15-20	80-100	S P	150 roots	50	1	Seldom bothered.
Rhubarb	4	48	1/4	10 plants	...	2-3 Yrs.	S P	180 stalks	50	...	Seldom bothered.
Beet	1 1/2-2	3-4	1/2	1/2 oz.	7-10	60-75	S S	150 roots	100	3	Seldom bothered.
Chard, Swiss	2	15	1/2	1/2 oz.	7-10	50-75	S S	15 plants	20	1	Blister beetle. Rotenone or hand pick.
Broccoli	2	18	1/2	1 pkt.	6-9	70-80	S P	30 heads	50	1	Same as cabbage.
Brussels Sprouts	2	18	1/2	1 pkt.	6-9	70-80	S P	30 qts.	50	1	(Green Cabbage Worm. Rotenone.
Cabbage, early	2	12	1/2	1 pkt.	6-9	65-75	S P	35 heads	50	1	Aphis. Nicotine dust or spray.
Cabbage, late	2	18	1/2	1 pkt.	6-9	80-100	S P	35 heads	50	1	Same as cabbage.
Chinese Cabbage	2	12	1/2	1 pkt.	6-9	75-85	S S	50 heads	50	2	Same as cabbage.
Carrot	1 1/2	3	1/2	1 pkt.	12-18	60-75	S S	200 roots	100	3	Seldom bothered.
Cauliflower	2	18	1/2	1 pkt.	5-10	55-65	S P	35 heads	50	2	Same as cabbage.
Celery	2	4	1/2	1 pkt.	15-20	90-120	S S	150 bulbs	25	2	Same as celery.
Celery	2-3	5	1/8	1 pkt.	15-20	120-150	S S	120 plants	50	2	Aphis. Nicotine dust or spray. Celery Leaf Flyer-Pyrethrum.
Chicory, Witloof	2	10	1/4	1 pkt.	3-12	for winter	S S S S S S S S	60 roots	50	1	Green Caterpillar. Pyrethrum or hand pick.
Callard	2 1/2	24	1/4	1 pkt.	6-9	90 & on	S S S S S S S S	25 plants	50	2	Same as cabbage.
Endive	1 1/2	9	1/4	1 pkt.	10-14	70-80	S S S S S S S S	60 plants	30	1	Seldom bothered.
Kale	2 1/2	24	1/4	1 pkt.	6-9	70-80	S S S S S S S S	25 plants	25	1	Same as cabbage.
Kohlrabi	2	8	1/4	1 pkt.	6-9	55-65	S S S S S S S S	70 bulbs	50	2	Same as cabbage.
Leek	1 1/2	6	1/2	1 pkt.	7-10	120-150	S S S S S S S S	100 stems	30	1	Onion Thrip. Nicotine sulphate and soap solution or tartar emetic.
Lettuce, leaf	2	12	1/4	1 pkt.	6-8	45-50	S S S S S S S S	50 heads	50	1	Cut Worm. Poison bait on ground.
Lettuce, head	2	12	1/4	1 pkt.	6-8	50-75	S S S S S S S S	50 heads	50	1	Aphis. Nicotine dust or spray.
Mustard	2	9	1/4	1 pkt.	5-8	60-75	S S S S S S S S	50 plants	20	2	Birds. Cover with screen or open-meshed cloth.
Onion	1 1/2	3-4	1/2	1 pkt. or 1 pint sets	7-10	90-110	S or P	150-200 bulbs	50	1	Same as cabbage.
Parsley	1 1/2	4	1/4	1 pkt.	15-20	85-100	S S S S S S S S	150 bunches	30	1	Onion Thrip. Nicotine sulphate and soap solution or tartar emetic.
Peas	2-3	1-2	1	1/2 lb.	7-10	60-80	S S S S S S S S	25-50 quarts	100	3	Seldom bothered.
Potato, white	3	12	4	3 lbs.	8-12	80-120	P S S S S S S S	60-80 lbs.	100	2	Aphis. Rotenone, pyrethrum, or nicotine dust or spray.
Radish	1	1-2	1/2	1 pkt.	3-6	25-60	S S S S S S S S	300-600	25	4	Same as tomato.
Spinach	1 1/2	6	1/2	1 pkt.	7-12	40-50	S S S S S S S S	100 plants	50	2	Cabbage Maggot. Avoid by quick root growth.
Turnip	1 1/2	4-6	1/2	1 pkt.	5-10	50-80	S S S S S S S S	100-150 roots	50	2	Aphis. Nicotine dust or spray.
Turnip, Rutabaga	2	6	1/2	1 pkt.	5-10	80-90	S S S S S S S S	100 roots	50	1	Seldom bothered.
Beans, bush	2-2 1/2	3-4	1 1/2	4 oz.	5-8	50-70	S S S S S S S S	20 qts.	100	4	Mexican Bean Beetle. Rotenone.
Beans, pole	3-4	9, or hills	1 1/2	4 oz.	5-8	65-80	S S S S S S S S	30 qts.	50	4	pyrethrum, or cryolite. Flea beetle, red spiders or corn borer. Apply rotenone dust just before ear forms, then 4 times more 5 days apart.
Corn, early	2 1/2	9	1	1 oz.	5-8	70-80	S S S S S S S S	50 ears	80	1	Corn Ear Worm. Snip off tips of ears after silk dries or apply mineral oil to ear tips.
Corn, main crop	3	12	1	1 oz.	5-8	80-95	S S S S S S S S	50 ears	100	1	Striped Cucumber Beetle. Rotenone.
Cucumber	4	24	3/4	1 pkt.	7-10	60-70	S S S S S S S S	150-200 pickles	50	1	Aphis. Nicotine dust or spray.
Pumpkin	8	60	1	1/4 oz.	7-12	110-130	S S S S S S S S	25-30 fruits	25	1	Squash Bug. Rotenone or hand pick.
Squash, bush	4	36	1	1 pkt.	7-10	55-65	S S S S S S S S	75-100 fruits	50	1	Same as pumpkin.
Squash, vining	6	60	1	1 pkt.	7-10	65-120	S S S S S S S S	40-80 fruits	25	1	Cut Worm. Paper collar around each plant when set out.
Tomato	3-4	36	1/2	1 pkt.	7-12	75-90	P S S S S S S S	175-200 lbs.	75	2	Green Tomato Worm. Dust with rotenone or hand pick. Aphis. Nicotine dust or spray.
Lima beans, bush	2-2 1/2	3-4	1 1/2	4 oz.	5-8	65-75	S S S S S S S S	15 qts.	100	2	See beans above.
Lima beans, pole	3-4	9, or hills	1 1/2	4 oz.	5-8	80-90	S S S S S S S S	20 qts.	50	1	See beans above.
Egg plant	3	30	1/2	1 pkt.	12-15	70-85	S P S S S S S S	50-75 fruits	50	1	Colorado Potato Beetle. Arsenate of lead or Paris green.
Muskmelon	5	48	1	1 pkt.	7-12	80-100	S S S S S S S S	75 fruits	50	1	Flea Beetle. Dust with arsenate of lead.
Okra	3	15	1	1/2 oz.	8-12	50-60	S S S S S S S S	250 pods	50	1	Seldom bothered.
Pepper	2 1/2	24	...	1 pkt.	10-14	65-80	S P S S S S S S	200 fruits	50	1	Cut Worm. Paper collar around each one when set out. Aphis. Nicotine dust or spray.

Very hardy. Not injured by winter freezing.

Hardy. Withstand light frost but not freezing. Plant when ground is early frozen.

Very tender. Plants late, may be injured by cool weather. Don't plant until all danger of late frost is over.

Very tender. Plants late, may be injured by cool weather.

Herbs



MARJORAM ROSEMARY BALM CHIVES RUE SAGE BURNET BORAGE

ED used to be a little sarcastic about my herbs—referring to my herb garden as “the weed patch.” He claimed he couldn’t tell seedlings from weeds.

But since he’s seen to what good use I put my few herbs and how little trouble they are, he has a new appreciation of them. Herbs really fall into the woman’s department. For although herbs offer a fascinating and learned hobby and can be grown as flowers for beauty, for fragrance, for dyes, vinegars, tea and incense-making, the main use on a homestead is in cooking.

Although I’ve heard a number of women say their husbands didn’t like herbs in cooking, I’m inclined to think that this is one of those preconceived notions that men have about food and ought not to be taken too seriously—especially when they say it after a dinner they’ve relished where herbs have perhaps been used without their knowledge in poultry stuffing, soup, tomato cocktail, iced tea, and fruit cup!

I think the reason more of us don’t use herbs regularly is because there is so much mumbo-jumbo mixed up in most herb literature just as there used to be about serving wines. Once people discover, as they have about wine, that you can use any herb you like in cooking, then a lot more of us will use herbs. Of course, certain herbs seem to be “just right” with certain foods.

Any cookbook worth owning, even conservative Fannie Farmer, has something on herb cooking. Usually for the beginner it’s too much to take in all at once. So, unless you’re an accomplished herb-cook, I suggest you start your herb cooking from the angle of what’s easy to grow in a small herb garden.

Herbs take practically no space, and, because most herbs don’t need any complicated soil preparation, you can grow them without even bothering your husband by asking him to prepare the ground. Because you need only about a dozen plants altogether; you can probably plan your herb garden and dig it up yourself. Herbs shouldn’t be planted in a wet place. A good mix for the soil for herbs is equal parts of compost and loam and double parts of sand—all sifted.

There is little reason for starting herbs indoors. After all, herbs are dried, and when drying is done carefully and the herbs put in screw top jars, they will keep easily from one season to the next. So there’s no special need for an early start.

Herbs are propagated from seed, by cuttings or “layering,” and by root divi-

sion. All annual herbs are best grown from seed . . . many perennials too.

Herbs are best in their own garden. The closer you can locate this to the kitchen the better—when you want a sprig of mint or couple of herbs for a “rainy day stew,” you’ll find you just won’t want to bother getting in the herbs if they’re located too far away.

The wheel garden is made with a heavy wagon wheel. The herbs planted in it should not be too tall growing or the effect of the division by the spokes will be lost. After obtaining a suitable

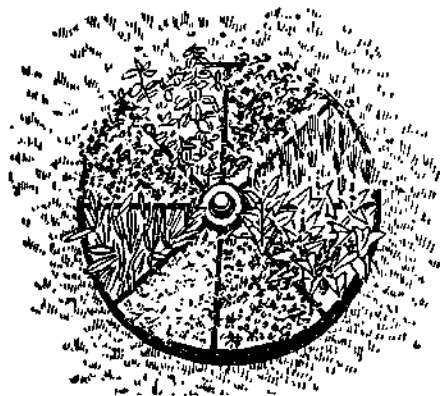

wheel, select a sunny spot on level ground or a gentle slope. Mark around wheel, then dig out the center for hub—the rim should set on the ground. Fill spaces between herbs with sandy loam. If any of the spaces are to be filled with mints, stick plates of metal—old license plates or sheet iron—around the boundary of the mint to prevent it creeping into adjacent beds. Although you can plant most any herbs in this wheel bed, the lower growing varieties make an especially pleasant pattern: parsley, chives, garden thyme, orange or apple mints, lungwort, dietary of crete, thrift, dead nettle—and such annuals as dwarf basil, sweet marjoram, chervil, summer savory, coriander.

Some Easy-to-Grow Herbs

ANISE: 75 days. Annual. 8 inches. Always grow from seed, don’t transplant. Uses: fresh leaves in salad and as a garnish. Good with fish. Seeds: in bread, cake, stew, soups, candy. Medicinal: tea.

BASIL: Sweet: 85 days. Annual 1 to 1½ feet. Germinates easily in 4 or 5 days—if tops are pinched off plants will bush. Spacing: 15 inches for regular—6 inches dwarf varieties. In harvesting, when buds appear use both leaves and buds, cut part way to ground for a second crop. Uses: in soups, meat, some salads. Tie in bunches, dry in sun, store.

BORAGE: 80 days. Annual (self-sowing).

1½ feet. Blue flowers attract bees. Should not be transplanted. Uses: tender leaves are used in salads and to flavor lemonade and other cool drinks, cooked, in pickles. Flower is candied for confection.

CARAWAY: 70 days. 1½ to 2 feet. Biennial seed; planted one year for harvest the next. Plants to stand 8 inches apart. Cultivate first year. When seed clusters ripen second year, snip plants a foot above ground, dry on old cloth a few days, then thresh seeds by slapping with a small stick. Blow off chaff and store in a tight jar. Early ripening seeds may be planted to give a crop the next year. Uses: in breads, cakes, candies—cabbage, soup and salads, in sauerkraut, goulash, baked apple.

CHIVES: Perennial. 6 inches. Seeds germinate slowly. Clumps may be divided in Spring. Uses: leaves give mild, onion-like flavor to soft cheese, vegetable cocktail, soup. Bulbs are chopped and added to sausage to give delicate onion flavor.

CORIANDER: 75 days. Annual 1 to 2 feet. Hardy, slow germination, but easy-culture. Can be grown with caraway. Plants should be thinned to stand 6 to 8 inches. Odor and flavor of growing foliage is unpleasant. As soon as seed tops are ripe, they’re cut off (heavy seeds easily fall to ground if this isn’t done), spread to dry, threshed, and stored in tight glass containers. Uses: in bread, cookies, baked apple, stuffing, sausage.

DILL: 70 days. Annual. 2 to 2½ feet. Easy germination and self-sowing. 10 inches between plants. Don’t transplant. Stake. Uses: for flavoring pickles; also in soups, stews, cream sauce, potato salad.

FENNEL: 60 days. Annual. 1 to 2 feet. Sow in moderately rich soil. Don’t transplant. 8 inches between plants. Uses: Stalks can be eaten like celery. Nutmeg-like seeds used on bread, cakes, sauces, in wine.

MINT: Perennial. 2 feet. Spearmint is ordinary garden variety. Best grown from a few plants. Spreads rapidly in medium rich soil. Uses: in lamb and fish sauces, iced-beverages, fruit cup, in currant and mint jelly, in French dressing for salads. Orange and apple mint not as strong as spearmint.

SAGE: 75 days. Perennial. 1 to 2 feet. 8 inch spacing. Plant seeds; choose “Garden” variety. Uses: as sage tea, in poultry dressing, sausage, soft cheese. Leaves can be smoked as tobacco.

SUMMER SAVORY: 60 days. Annual 1 foot. Seed germinates easily. Spacing 6 inches. Uses: for flavoring gravies, salads, dressings, stews, scrambled eggs and sausage.

SWEET MARJORAM: 70 days. Annual. Slow germination. Spacing 10 inches (requires shade until well started). Many uses either fresh or dried: in sausage, meat pies, roast lamb, cheese and egg dishes, peas, beans, and tomatoes, in vegetable cocktails.

THYME: 85 days. Perennial. 6 to 12 inches. Plant seeds—thin to about 4 inches. Plants may be divided and reset second Spring. When in full bloom, cut, dry, powder by rubbing and store in glass. Uses: green or dried in soups, stews, sausage, gravies, stuffings, with pork, veal, chipped beef, and especially good on lamb or chevon and chicken.



HYSSOP ANISE MINT CHERVIL THYME TARRAGON PEPPERMINT SPEARMINT CHAMOMILE CATNIP LAVENDER COTTON SUMMER SAVORY SAFFLOWER

The Kind of Berries and Grapes Money Can't Buy...



Strawberries

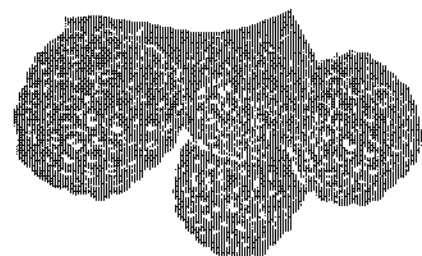

Black Raspberries

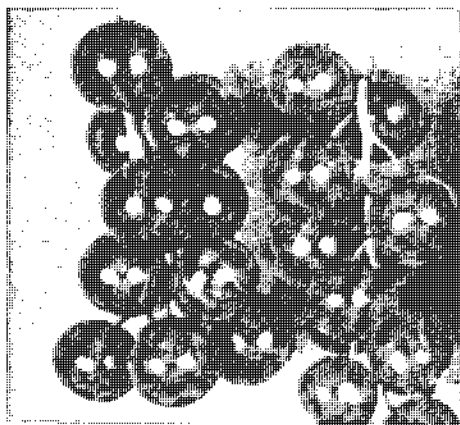

Currants



Gooseberries

BERRIES and grapes are one of the best investments you can make. Here it is early December and this morning for breakfast we had some of our own delicious raspberries and cream. When some friends came to dinner a few days ago we had strawberry shortcake made with our own strawberries. Soon we hope to have currant jelly and our own grapes and lots of delicious fruit juices—perhaps some home-made wine.

Even the smallest place can provide an abundance of mouth-watering small fruits and berries with only a few hours work a year. Home-grown fruits, especially blackberries, gooseberries and currants (all of which are almost too fragile to be handled commercially) offer a family delicacies they'd never otherwise have. Few people, according to government studies, get enough of the so-called "protective" fruits rich in vitamins needed for good health. And most city people never have the chance to indulge in all the fun of growing these fruits on a place of their own.

You can plan your garden so you'll have a succession of fresh fruits ripening from June to October. And all winter you can eat berries you've canned or frozen. Strawberries, raspberries, currants, and grapes are the best known favorites. If you prefer something a little different, you can choose gooseberries, dewberries, or mulberries. (Edible mulberries are delicious fresh, canned or for wine. They grow on a bushy tree.) If space is limited, the bushes make fine hedges and shrubbery. Probably nothing you do will give you more for less cost. By all means choose the better varieties that are too tender and delicate to be found in prime condition in the store. Your local nurseryman can advise you on this and supply plants best adapted to your climate. Before you decide on your planting of grapes and berries, you should learn when each has to be sprayed, pruned and mulched and figure out a schedule for doing this. It's worthwhile to read up on this. Meanwhile, here are some things we learned about growing these fruits that may help you.

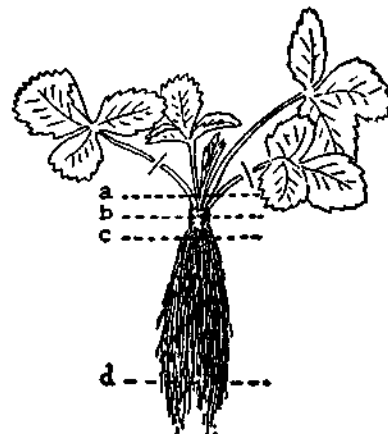

Strawberry plant showing trimming and depths of planting: (a) planted too deep. (b) planted correct depth. (c) not deep enough. (d) pruning of roots.

Strawberries

There's a big difference between strawberries you buy in the stores and those you pick sweet and fully ripe on your own place. Growing them is not difficult. You have a choice of planting them in hills, in matted rows or in spaced-rows. We used the spaced-row system and we think it's easier because it requires less pruning and makes weeding and picking the berries simpler. We planted 100 plants in the Spring and got 55 quarts the next year. Plants usually bear for two or three years, after which they need replacing.

Raspberries

We like raspberries so much we planted 100 bushes—cost \$8.00. This planting should bear for at least 7 years. Perhaps we made a mistake when we chose the *Latham* for our garden because this is really a commercial berry, but it is hardy and we did get wonderful berries. We also planted some *Indian Summer* because this is an everbearing type which means you get berries in the early Summer and another crop in the Fall. The raspberries planted in the Spring gave berries the following year. We learned

Small Fruit Planting Table

	Distance between rows (feet)	Distance between plants (feet)	Estimated Yield per plant	Age of Bearing (in years)
Raspberries	6-8	2-3	1 quart	2
Strawberries	3½	2	¾ pint	2
Blackberries	6-8	2-3	1¼ quart	2
Dewberries	6	6	1 quart	2
Gooseberries	8	3	2¼ quarts	3
Currants	8	3	2 quarts	3
Grapes	8	8	6 pounds	3-4
Blueberries	5'	5'	5-6 pounds	1-2

you shouldn't mulch raspberries with poultry litter in the Spring because it makes the shoots grow too fast. When this happens too many become "Winter killed." Raspberries are pruned early in the Spring, and sprayed 3 or 4 times. Any diseased canes should be removed immediately after crop is over. And that's all we've had to do to get 75 or more quarts of raspberries a year!

Currants

You can't beat currants for jelly. They are hardy, easy to grow. A half-dozen bushes are well worth considering. Some states ban currants and gooseberries because certain varieties supposedly carry white pine blister rust, a disease that destroys white pine trees. Cool moist climates are ideal for currants.

Gooseberries

I hope some of you people who are already living in a "Have-More" home-stead will want to try gooseberries. They make good pies, tarts and jams and the fresh ripe fruit makes a delicious dessert. Even in Canada they can be grown; in cool, moist climates they flourish. (In England they grow so well that the berries are often as large as eggs!) Experts say this fruit has been pretty much neglected in this country—it ought to make an interesting experiment.

Grapes

We planted 10 vines—4 Concord, old-standard, for jelly and jam . . . 2 Caco, a red grape ripening in early September . . . 2 Niagara, white grape which ripens in mid season . . . and 2 Portland, another white grape, which ripens early. Grapes really don't bear heavily until the fourth season, so we haven't actually had any from our vines as yet. All 10 grape vines cost only \$5.00.

Blueberries

Blueberries are rather expensive—\$1.00 per plant, we paid. But four to six are supposed to be enough for an average family. One interesting thing about blueberries—they often fruit the first year and will keep bearing for fifty years. Unhappily, out of our six bushes we lost four last year—the goats ate one and a bulldozer we had ripping

out stumps in our back yard chewed three more.

Blackberries

This fruit makes wonderful jam and jelly. We put in about 15 bushes as a hedge. Blackberries have a reputation for being sour. This is because often times the berries you buy are picked as soon as they turn black—actually they are best when left on the bush until dead ripe. As in the case of other berries, it is important to mulch blackberries. The best time to do this seems to be directly after the berries have been picked. Blackberries don't need commercial fertilizer, but the soil should be kept moist and provided with humus. Thus the mulch.

Dewberries

This is really a blackberry. It is often called "creeping blackberry," the main difference being that it grows on a vine instead of a bramble. The dewberry is sensitive to frost and will not bear good yields unless you plant several varieties to insure cross pollination.

Home Wine-Making

Although the wines we've tried to make have been pretty terrible so far, there's no reason you can't make excellent wines at home. In fact Fortune Magazine says 30 million gallons of wine are made in American homes every year.

Our mistake was in trying to make wine on the basis of "heresy" instead of getting good, clear, authoritative information. If you'd like to make wine from grapes, the main point is to get the right grapes. This isn't difficult because every state produces wine grapes. (See Farmers' Bulletin No. 1689). Or you can make delicious "wines" from blackberries, raspberries, elderberries, currants, gooseberries, dandelions, rhubarb, almonds, apples, apricots, barley, cherries, pears, oranges, pea pods, potatoes, tomatoes, rice—recipes for all of these and many more are in "Home-Made Wine Secrets".

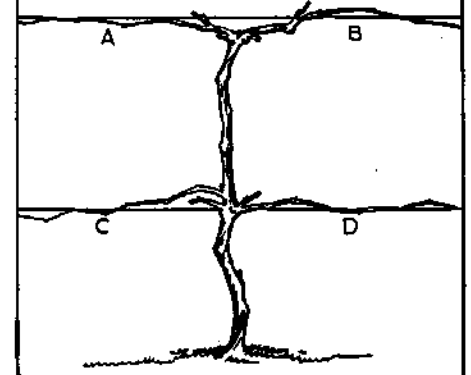
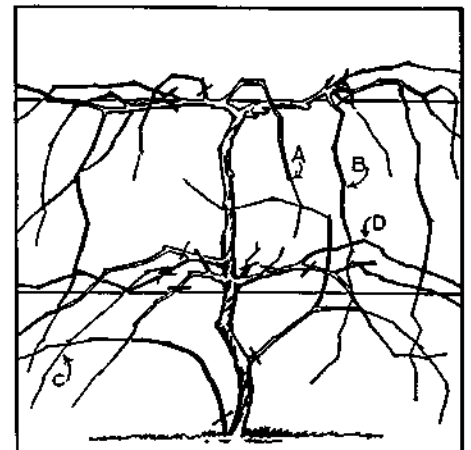

PRUNING—THE SECRET OF SUCCESS: Pruning can become a complicated subject. The main point is that all grapes are borne on branches (called canes) developed from previous year's growth. A little study of grape care and pruning pays high dividends.



(Above) After a raspberry cane has borne fruit it should be cut near the ground. Pruning is simple if you learn what to prune and when.

(Below) If strawberries are mulched as shown less cultivating is needed and you obtain better fruit.

In the Spring red raspberry canes should be cut back to a height of 4 to 5 feet as shown by dotted line. Remove weak canes completely. Leave 3 or 6 canes per plant.

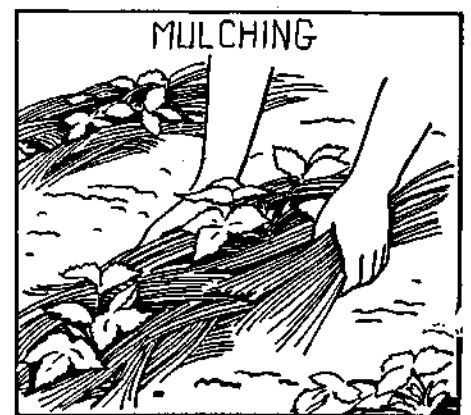
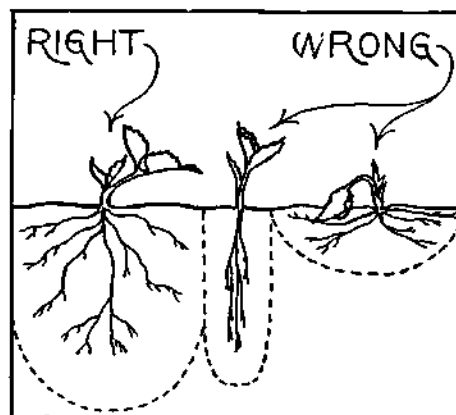

Two Ways to Have Tree Fruits on a Small Place

If the Ed Robinsons of five years ago could have talked with the Ed Robinsons of today about home orchards, the Ed Robinsons of five years ago would have been saved a lot of trouble. Now perhaps we can save you that trouble!

Soon after we first moved to our place we became excited about dwarf fruit trees—pigmy trees that produce delicious, normal size fruit in only 2 or 3 years. But when we went to order some our local nurseryman didn't have the right kind of dwarfs and he advised us to buy standard trees instead.

"But we haven't enough space in our back lot for many big trees," we protested.

"Then why don't you plant your orchard in front of the house?" he suggested.

"Well, we planned to landscape the front with pretty trees."

"Haven't you ever seen an apple tree in blossom?" he asked. Of course we had—so we planted our 18 fruit trees around the house and front lawn. We landscaped with fruit trees instead of shade trees. (Later we discovered that the back of our acre was too swampy for fruit trees anyway. If the roots of young trees stand in water they don't do well.) So we've never regretted our decision to plant fruit trees in front of the house.

We feel that the very first thing people should do when they buy a piece of land—even before the house is built, when possible—is plant a small orchard. The sooner planted, the sooner you will get fruit. The length of time you have to wait before your fruit trees bear seems to discourage a lot of people. But even if you should move before your fruit trees do bear, they'll increase the value of your place many times beyond their cost.

As for the care of fruit trees, our

nurseryman gave us a lecture before he would take our order. He said, "Now remember, you can't simply plant fruit trees and forget about them. You have to spray them—just as you do garden plants—and prune them once a year in addition." It wasn't until after we assured him we would do this, that he would take our order.

More likely than not your own local nurseryman will take a real interest in your fruit growing project. It is a good idea to buy from him rather than a far away nursery selling by mail because not only will you get some good advice from your local nurseryman from time to time, but he knows which varieties do best in your particular locality. Many local nurserymen today buy their young stock from famous nurseries all over the country, so if you want something special he'll get it for you.

We had a lot of fun considering what and how many trees to plant. Before we decided which variety of apples, we visited a commercial apple orchard, bought four or five varieties, tasted them and cooked them.

We learned that commercial growers give the appearance of an apple—or any fruit—undue importance. With them looks seem to rate as high as taste. Probably because appearance sells the apple at the fruit stand. Obviously, the first thing we were interested in was taste . . . next came keeping qualities . . . looks was last on our list.

In selecting the varieties we kept in mind the fact that certain apples ripen in July, others in August, September and October. By planting five apple trees, we would have apples summer and fall—and also a late apple which would keep over the winter.

After considerable reading and a lot of talks with our local nurseryman, the following is a list of the standard fruit

trees we believe sufficient to furnish a large family with enough produce for eating, canning and storage: 3 apple; 4 peach; 3 pear; 2 sour cherry; 1 sweet cherry; 2 plum. In Southern latitudes you can have citrus, apricot, nectarines, fig. Be sure not to plant your young trees too close to the house or to other trees. (See chart.)

The following table will give you an idea about yields and age of bearing:

Kind	Yield, When Full Grown, per plant		Age When You May Get Fruit*
	Bushels	Years	
Apple	6	6-8	
Pear	1	5-7	
Peach	1	3	
Plum	1	4-5	
Cherry (sour)	1	4	
Cherry (sweet)	1	6-7	
Quince	1/2	5-6	

*Based on planting 1 or 2 year-old standard trees—older trees usually don't fruit any sooner.

Even though all the fruit catalogues tell you that you can plant in either spring or fall, spring is preferred in most sections. Planting should be done as early as the ground can be worked and before growth has started in the plants. Don't use fertilizer when planting. Use fine earth and tramp earth solidly about the roots with your feet, shovel by shovel. Set trees about an inch deeper than they were in the nursery.

Keep a three foot circle cultivated around the tree trunk. In the fall mulch them with poultry house litter. From the second year on, cultivate regularly and fertilize at end of June by using a barnyard manure mulch. This serves to keep in moisture during hot dry spells in July and August and provides additional food. You will be surprised at how much faster this will bring your trees to bearing.

Some state agriculture departments will send you postcards throughout the year telling you with what and when to spray your fruit trees. Needless to say, this is an invaluable service and you should get your name on your state's list of fruit growers so you can more easily take care of spraying. Ask your County Agricultural Agent about this service.

Dwarf Fruit Trees

Now, after many years of experimental work really good dwarf fruit trees are available. The two exciting things about dwarf fruit trees is that they take very little space and they bear fruit a year or two after you plant them whereas with standard trees you have to wait four to eight years!

Take a look at the comparison chart on the next page. It will help you decide which type of trees to plant.

Dwarf trees have many advantages, and a few disadvantages, when a detailed comparison is made with standard trees. Let's look at the advantages:

Dwarf trees take less space. In the

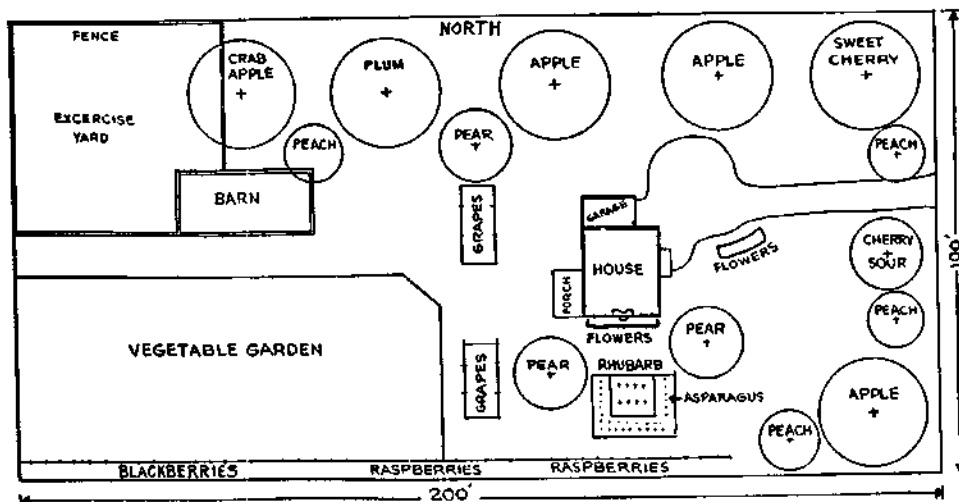

Here is one plan for less than a half-acre homestead showing how you can attractively landscape your grounds with fruit trees. Note that tall trees are generally planted on North boundary. In this plan trees are planted as close as is practical and size (spread) at maturity indicated—scale 1" equals 40'.

space required by 4 standard apple trees, 80 x 80 feet, you can plant as many as 64 dwarf apple trees! Even the ordinary suburban "house and lot" has space for a few dwarfs.

Dwarf trees are easier to spray or dust. All fruit trees must be sprayed or dusted. Dwarf trees, particularly the "little" dwarf or "semi-dwarf" can be sprayed or dusted with an efficient garden sprayer or duster. This is most desirable because the expensive, bulky spraying equipment for standard trees is not needed. Spraying is much easier, and consequently it gets done.

Dwarf trees bear fruit sooner. A "standard" apple tree usually does not produce fruit for 5-10 years after it has been planted. A dwarf tree will often bear fruit in two years!

Dwarf trees are easier to prune. Obviously a tree 5 to 10 feet tall is much easier to prune than a tree 25 to 30 feet tall.

Dwarf trees grow large fruit. Fruit buds, like turnips for instance, need to be thinned if the biggest fruit is to be grown. Dwarf trees, where the tiny fruit can be thinned easily, often produce bigger fruit.

Dwarf trees make possible more variety. Naturally if you can plant 10 to 15 dwarfs in the space required by a single standard tree, you can have 10 or more various kinds or varieties of fruit, instead of one. This has another advantage: you can have early, mid-season and late fruit by selecting varieties that ripen at different times.

Dwarf trees are easier to harvest. Fruit from the smaller dwarfs may be picked from the ground without the bother and danger of climbing a ladder.

Dwarf trees mean less damaged fruit. Fruit dropping from the small dwarfs, particularly when the ground under the trees is mulched with straw, hay or sawdust, is often undamaged.

Dwarf trees produce top-quality fruit. Fruit produced on a dwarf tree not only tastes as good as fruit from a standard tree, but because it is easier to give dwarfs better care, the fruit often surpasses that from large, and particularly old commercial trees.

As for the disadvantages, here are several you should know about:

Dwarf trees are more expensive. Of course prices vary in different localities, but a New York State nurseryman lists

2 year dwarfs at \$3.50 and his standard trees at \$1.75. When the supply catches up with the demand, this difference won't be as great.

Dwarf trees are shorter lived. However, this is not too serious a drawback. A dwarf apple tree will bear for 25 to 30 years compared to say 40 years for a standard tree.

The fruit you get from dwarf trees is full-sized. All standard varieties of fruit are available on dwarf trees; that is you can buy dwarf McIntosh, Baldwin, Northern Spy apples . . . Bartlett, Clapp's Favorite, Duchess, Seckel pears . . . Elberta, Hale-Haven peaches, and so on.

The fact that dwarf trees are easier to care for doesn't mean you can grow them without knowing a few of their peculiarities, however. Certain things about dwarf management are different. They must be planted correctly or they may grow into large trees. Pruning and thinning, though more simplified, is different. You'll find it really fascinating to read up on dwarf trees—also this will insure you against buying the older kind of dwarfs which nurseries used to carry and which weren't always reliable. We recommend you seriously consider planting dwarf apple, pear and possibly sweet cherry trees as these three have been developed the most successfully. Dwarf fruit trees, one of the biggest horticultural advances in years, mean a lot for the small place.

\$50 From a Single Nut Tree!

One day Carolyn and I received this letter:

Dear Ed & Carolyn:

"Here in Georgia a great many pecans are raised commercially and many farmers have a side line grove of the nuts which add considerably to their income. The trees make beautiful ornaments as shade trees besides the crop they bear. One suburban home I know of has two trees that brought in a total of \$84 cash this year. Another single tree I know of bore over \$50 worth of nuts."

Sgt. Herbert P. Keene

This was only one of the letters friends have written us to say that we should include mention of nut trees in our "Have-More" Plan. They pointed out that nut trees are unbelievably



The little girl is four years old—but the dwarf fruit tree has been planted only two years. And just look at the apples!

easy-to-grow, make beautiful shade trees, require less spraying and pruning than fruit trees, and supply the table with a nutritious, easy-to-keep food.

Well, I will say truthfully that about all that I know about nut trees is what I've read about them. We do have on our place one big, old butternut tree that has born huge crops; the nuts have a heavy husk and thick shell, but are mild and good-tasting after you get them cracked.

But Carroll D. Bush, in the *Nut Grower's Handbook* points out that here in America in the past thirty years, more has been accomplished with nut trees than millions of people in the old world accomplished in centuries. Better varieties of both European-Asiatic, and American nuts have been selected and bred for improvement and hardiness.

Today there are nut trees suitable for growing in every state. Of course, nearly everyone is familiar with the great almond and English walnut groves on the Pacific Coast and the pecans in the south. But do you realize the many varieties that have proven successful in the north and eastern states? Here are some of them: Im- great almond and English walnut pecan, hickory, hican (a cross between a hickory and pecan), filbert, almond, Chinese and Japanese chestnuts, heart-nut, and many varieties of hazel nuts.

Although nut growing is by no stretch of the imagination a "get rich quick idea," it does have a definite commercial side. For the homesteader, nut trees do have a good deal to offer.

Fruit Tree Comparison Chart

	Years After Planting To First Fruiting		Orchard Spacing	
	Standard	Dwarf	Standard	Dwarf
Apple	6-8	2-4	40' x 40'	8' x 10'
Pear	5-7	2	20' x 20'	10' x 10'
Sweet Cherry	6-7	4-5	25' x 25'	12' x 12'
Sour Cherry	4	3	20' x 20'	12' x 12'
Plum (Japanese)	4-5	3	20' x 20'	12' x 12'
Plum (European)	4-5	4	20' x 20'	12' x 12'
Quince	5-6	4	15' x 15'	10' x 10'
Neclarine	3	2	20' x 20'	12' x 12'
Apricot	3	3	20' x 20'	12' x 12'
Peach	3	2	20' x 20'	12' x 12'

Fresh Eggs From Your Own Hens

PERHAPS this sounds fantastic but we find that it's not much more work producing our own eggs than it is to make a weekly trip to a poultry farm to be sure we actually do have strictly fresh eggs. Our laying flock of 20 R.O.P. New Hampshires requires about 7 minutes care a day—and gives us on the average 11 eggs daily, year around.

Twenty hens require an 8 x 10 foot house which costs new about \$75. But if your family uses only four eggs a day a house for eight hens can be bought or made for as little as \$30.

Eggs were the first project we attempted when we moved out of the city. We estimated how many eggs we'd like to eat. With three in the family we thought we wouldn't need more than two dozen a week—3½ a day.

In estimating year around egg production, figure a hen will lay an egg every other day—if you can use six eggs a day, then plan on having a dozen hens. So, we bought a ready-made poultry house for \$28., 7 pullets for \$11.00; plus a water pan for 50 cents, a feeder, 69 cents.

If you can drive a nail and cut a straight line with a saw, you can build your own poultry house. If you want to, you can buy a "knock-down" poultry house and assemble it. You'll find them advertised in poultry magazines—be sure to write for catalogues and compare prices—they vary quite widely.

For the first week our 7 pullets (young hens beginning to lay for the first time) didn't lay an egg. One evening when I came from work, I found my wife all excited—our flock had produced an egg! That egg, counting the feed we had on hand cost us \$45.89.

But during the next eight fall and winter months those 7 hens laid 646 eggs—nearly 54 dozen—6½ dozen a month.

During that time we spent \$14.30 on feed—an average of 26 cents per dozen eggs. In our locality eggs sold for 60 cents a dozen. In short, we had saved \$32.40 on eggs and at any time could have sold our hens as fowl for 25 cents a pound or \$11.20.

But with our eggs only costing us 26 cents a dozen instead of 60, we began using more. That's why we have increased our flock. The next spring we raised 25 of the finest R.O.P. (Record of Performance) New Hampshire pullets (cost: 50 cents apiece as day old chicks), culled them down to 20, and began getting more eggs than we could use. With these better laying birds our eggs cost only 16-18 cents a dozen for feed costs. We sell the surplus at 60 or 65 cents a dozen—and right where I work I have more customers than we can supply.

How to Start

When we began studying up on chickens we found that there were many books on how to make a success of poultry commercially, but little information on raising a barnyard flock efficiently. Now, however, there are a number of good books—for example, G. T. Klein's "Starting Right With Poultry."

Many writers tell you any old building is suitable for poultry. But any old building and any old kind of equipment often result in a damp, drafty henhouse—probably ending up with your flock not laying and possibly getting sick.

A separate henhouse, or space in your small all-purpose barn, or a re-

modelled shed which gives 4-5 square feet of floor area per bird is needed. For a dozen hens a house 7' x 8' or thereabouts is satisfactory. The building should face south and permit plenty of sun deep into the building during winter. The house should be well-ventilated, but not drafty. Recent experiments show that it is better to give hens almost no air at all than have them exposed to a draft. Twenty hens give off a gallon of water per day—draft-free ventilation will keep this moisture from being absorbed in litter, doing away with frequent removal of same. With proper draft-free ventilation, you can put litter down in the fall, add more as needed during the winter, fork over weekly, and you should not have to change litter until spring. Then, old litter is used on the garden. But if litter becomes damp, change it right away.

Crushed sugar cane is excellent litter, deep straw or peanut shells are also good—all make good garden mulches. To obtain draft-free ventilation have windows in south only, and have them open in from the top, or hang regular double-window sash that can be regulated top and bottom.

The foundation of the house can be of concrete, which is best, or double-wooden floor with building paper and rat-proof wire between floors.

Interior

As for the interior of the chicken house, at the rear provide a dropping board 3 to 4 feet off the floor perhaps across the width of the house. Six to eight inches above the dropping board on supports, run a one-inch mesh wire. Provide roosts above wire, a foot apart. Allow 10 inches of roost per bird. The wire between roost and dropping board keeps hens clean and saves the eggs laid from the roost.

Nests—while they can be orange crates set a foot or so off the floor at the side of the house—should have a piece of ordinary corrugated carton cut to cover the bottom, then straw or excelsior for nesting material. The corrugated cardboard saves many an egg from breaking, and if an egg should become broken or the nest become messy cleaning is simply a matter of removing the cardboard. Provide a nest for each 5 hens.

Also buy a good waterer—preferably one that has a kerosene or electric heater to keep water from freezing in winter. Get one large enough—our 20 hens drink about two gallons of water a day.

Your State Agricultural College will send you free building plans for a backyard laying house. You can get plans to build a mash and feed hopper from your local lumber man. But it's practically as

See next page

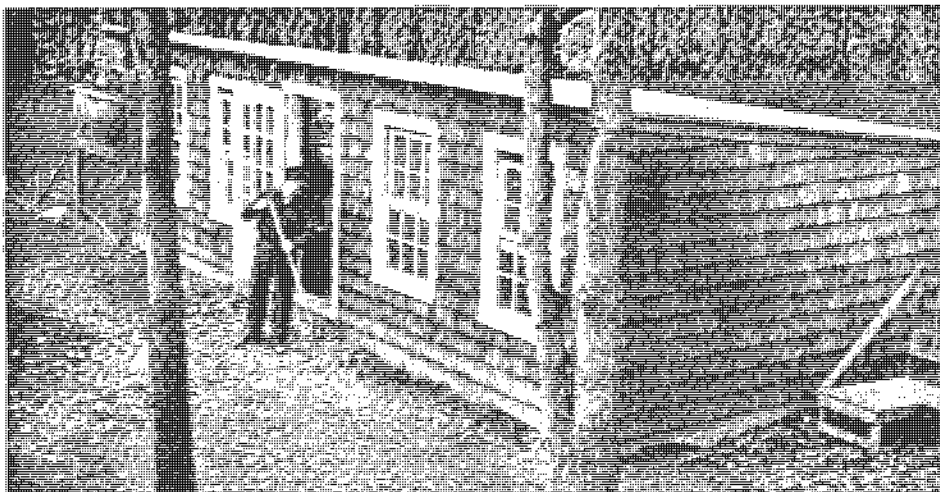

Our small all-purpose barn is 18 x 30 feet. Run at capacity this efficient little building houses up to 30 laying hens and a battery broiler in one section; in the other, 4 milk goats and in two pens up to 6 kids or lambs, plus a six compartment metal rabbit hutch, squab loft, milking stand, also feed and hay.

No-draft ventilation with plenty of sunlight is provided by four windows facing south. A second door at the far end (not visible) opens from the goat dairy section into the fenced pasture. Small hen door on the north side lets hens out into the yard.

Floor is concrete, building is regular frame and sheathing construction with cedar shingles—roof of heavy green mineral surface roofing. Water is piped from the house.

Cost including equipment: materials \$285, labor \$240.

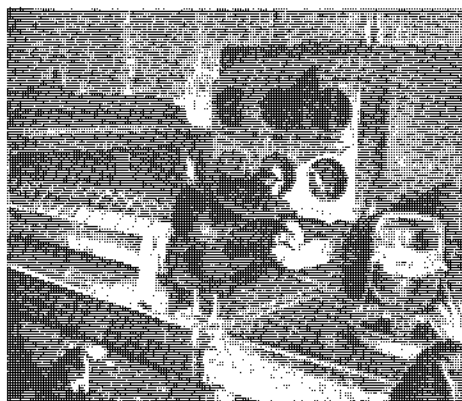

One-third of our barn is a laying pen. Simple and cheap feed and water equipment on a sturdy home-made stand keeps feed and water clean. Also, although it doesn't show up in this snapshot, wire is stretched between roosts and dropping board for sanitation.

cheap to buy a hopper from Sears Roebuck or Montgomery Ward or one of the poultry supply companies. The hopper should be well off the floor with a feeding platform that keeps feed clean and saves waste. Set the hopper and the water in the middle of the floor so that the birds can get the feed easily. (See diagram).

How to Feed

There are more different theories on feeding hens than feeding babies. Here is a simple, satisfactory way. In one large mash hopper (one foot long for each six hens) place a good egg mash in one half—and in the other scratch feed. Keep plenty of mash and scratch before the hens at all times. At first your hens will eat more scratch than mash, then gradually eat half mash, half scratch, which is what they should be eating for best results. (Hang an automatic feeder for oyster shells and grit from a side-wall).

Buy your feed from a hay and feed dealer with a good reputation. Keep a supply of feed on hand—don't let your feed get too low because feed deliveries are unpredictable. You can keep laying hens inside the poultry house all year around—they will lay as well as hens that have a yard. In winter an electric light with an inexpensive automatic switch which turns it on at 4 a.m. will increase your production—not because you're fooling the hens into thinking it's daylight, but because they can see to eat more egg-producing mash.

Mash means eggs—as they say. So keep your birds eating mash. If they drop off, moisten mash (in winter use hot water) and you'll be surprised how your hens will gobble it up.

Culling

"Cull" simply means to eliminate birds that seem sick, weak, or non-layers. Time was when characteristics showing good layers were not widely known, but today almost anyone can

cull their flock by checking these characteristics:

Judging Production

	Laying Hen	Non-Laying Hen
Vent	White, large oblong, moist	Small, round yellow, dry
Comb	Large, red, full, silky	Small, pale, scaly
Pelvic bones	Wide apart, pliable	Close together, rigid
Wattles & Earlobes	Prominent soft	Shrunken rough, dry
Eyes	Prominent sparkling	Listless, sunken, dull

Cull birds after dark. Take out of pen for table use those showing non-laying characteristics. Probably, at first, you won't trust your ability to cull. We were afraid we might "liquidate" a couple of valuable layers—so we kept the "cullers" in a small chicken house for two weeks to see if they were layers. They weren't.

If over 50% appear to be non-layers, probably, the trouble is with you. Exert every effort—feed hot mash, check for lice, mites—for four to six weeks to bring them back into production.

What Breed?

There is no best breed. All fall into three general classifications: egg machines (Leghorns), meat birds (Jersey Giants), all purpose birds (New Hampshire, Plymouth Rocks, R. I. Reds, Wyandottes.) By all means choose one of the all purpose birds—preferably the one your wife likes the looks of best. She'll be collecting the eggs and keeping an eye on the flock while you're away.

You can raise your own laying hens from chicks, particularly if you buy the battery brooder described in the section on broilers. Buy "straight-run" baby chicks using poultrymen's rule of three chicks for every pullet wanted in the fall. When they are six weeks old take out pullets (they'll be smaller, have less comb development) and raise them on range during warm months. (See page 33). Never put young growing chicks with older chickens or hens.



Almost one-half of daily chore time is taken up by watering stock. Running water in barn is easiest single way to save work.

Secondly, if you don't have a brooder, then buy 6 to 14 week pullets from a good breeder. These will begin laying at 20 to 24 weeks. Here you must be careful to buy from a poultry man

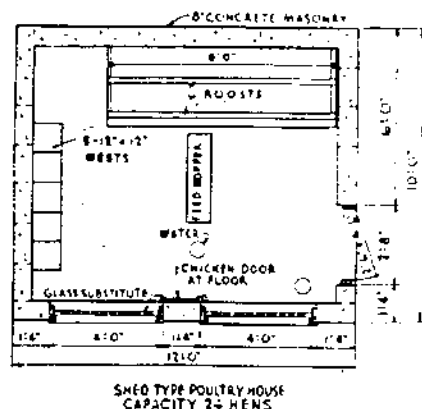

Diagram of interior of a laying house. Feed and water are placed prominently in the middle of pen to get hens to eat often — "the handier the mash . . . the more eggs."

who is in the business of raising pullets to sell. Be wary of buying from a poultry man who is primarily producing eggs—he usually keeps his best pullets, sells his culls. Only buy 6 week old pullet in the spring or summer when there's plenty of grass range for you to raise them into strong birds.

Thirdly, you can buy 20 week old pullets which are about ready to lay. These will cost \$1.50 to \$2.50 apiece. Buy only pullets—birds less than six month old. And remember, you don't need a rooster to produce eggs.

Prevention of Disease

It has been said that something like 300,000 people go into the poultry business each year to make their fortune—and about 289,000 give up because they couldn't make a go of it commercially. One reason for this bad showing is loss from disease. A backyard poultry raiser should have little trouble on this score if he has disease free birds to begin with and keeps sanitary conditions in the house. We know of any number of people who have been keeping poultry for years without serious loss from disease.

Main points to bear in mind:

1. Keep poultry house clean.
2. Avoid drafts.
3. Don't overcrowd birds.
4. Paint roost once a year or oftener with Carbolinum to get rid of mites. Disinfect water and feed equipment—do this monthly anyway.
5. Isolate any sick bird immediately.
6. If any contagious disease occurs, kill affected birds and bury them immediately.
7. Dust with lice powder if birds are lousy.
8. Feed properly, watch for mouldy feed.

New, Easy Way to Raise Tender Chicken

ONE of the most successful projects we've undertaken is raising chickens to eat—broilers and fryers, in what is called a "broiler battery". This efficient new way of raising eating chickens has become increasingly popular among the large commercial poultrymen during the past few years, but only recently have small broiler batteries been made for family use.

Directly below is a picture of our "home-size" broiler battery. Here is the way it works: In the top deck we place "30 day-old" chicks, dipping their beaks in the water tray (and the mash) as we take them out of the shipping carton. Dipping their beaks once or twice teaches them where to drink and eat. At the rear of the top deck is a heated chamber with a drape at the front. This is the brooder. It's heated automatically by an electric heat-unit. When the brooder drops below a certain temperature, the heat automatically goes on together with a small light. The light attracts the chicks and they duck under the drape into the warm brooder.

As they get hungry they come out to eat and drink from the feed and water trays. Once or twice a day—and it doesn't have to be done at a definite time—we change the water and add feed, a specially prepared battery-broiler mash (be sure to get a vitamin fortified battery feed). The chickens live on wire and are kept sanitary at all times. A few sheets of newspaper spread out in the dropping tray makes

the daily cleaning easy—simply pull out tray and roll up newspaper.

At the end of 4 weeks, the baby chicks are divided into two equal groups—half go into the second deck, half into the lower deck. At the same time, another batch of 30 baby chicks may be added to the top deck.

In another 4 weeks, and each succeeding 4-week period, if you keep your battery running at capacity, you have 30 two-pound broilers.

Feed Cost — 16¢ a Pound

Even with today's expensive feed, our chicken costs us only 16¢ a pound. What's more, our battery takes less than 10 minutes a day to operate and it is truly "so simple a child can run it". Moreover, you can set it up in the basement, garage or shed—provided that, if you run the brooder during the winter, you have enough heat in any of these places to keep room temperature at 50° or above.

If you want to keep for your own use 15 broilers a month, then the other 15 can be sold to friends. By selling them at market prices you ought to earn enough to pay all your feed costs thereby having all the chicken you can eat at no cost.

The brooder is about 4½ feet high, 3 feet wide, and 3½ feet long. This size is made by a number of companies. They range in price from \$23-\$30. Names and addresses of Manufacturers are given at the end of this chapter.

One of the great things about these batteries is that they eliminate practically all chance of your losing your chicks by disease. At this writing I should say we've put over 800 baby chicks through our brooder. The hatchery from which we order our baby chicks—incidentally, we buy all males (cockerels) for they are cheaper and grow faster—sends us 32 chicks but charges for only 30. We have never lost more than these two extra chicks in any batch we've raised. And that isn't because we've been especially lucky, because four different friends of ours have bought broiler batteries—3 of them didn't know enough to tell a hen from a rooster—and all have done well.

Mind These A B C's

If you will remember the following points, I'm sure you will have no trouble in raising chicks in a battery:

- A) Buy good baby chicks—the best cockerels cost only 7 to 13¢ each, depending on the season. You can run the brooder any time of year. Buy chicks of heavy breeds—Hampshires, R. I. Reds, Barred Rocks, White Wyandottes and White Rocks (easiest to dress), or any of these cross bred. Don't buy Leghorns—they are a poor meat bird.
- B) Make sure your feed dealer supplies you with *broiler-battery feed*. This feed is fortified with minerals and vitamins necessary because your chicks won't get sunshine.
- C) Brooder should be started a day before chicks arrive. The room temperature kept at 65°-75°, if possible. Set your brooder so that a thermometer 1" above wire floor inside registers 85°-90°. Fill water troughs with warm water. Let chicks feed upon arrival—unless they're under 36 hours old. Daily feeding period should be 12 to 14 hours. Temperature in brooder is gradually reduced each week until at end of 4 weeks it is down to 70°.
- D) Wash water pans in hot water every other day—see that chicks always have mash, and water and chick grit.
- E) Let chicks have plenty of fresh air—no drafts and don't let temperature in room drop below 50°.

A Few Tips on Dressing Chicken

The first chickens we dressed took about an hour a bird—the other day we did seven in about an hour.

We never particularly liked this phase of our farm activities and have spent a lot of time making it as efficient and simple as possible.

First, instead of using a chopping

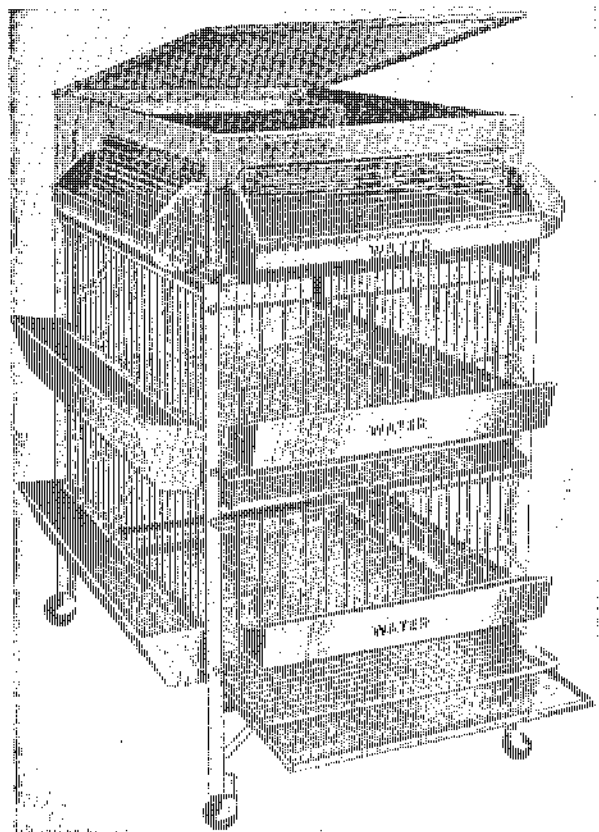

A complete chicken raising plant. With this broiler battery in your basement, garage or shed, and with no other equipment, you can raise baby chicks to 2 or 2½ pound broilers in 8 to 10 weeks. Not more than 10 minutes a day care will give you 30 broilers a month at a feed cost of 16 cents a pound or less, depending on feed prices.

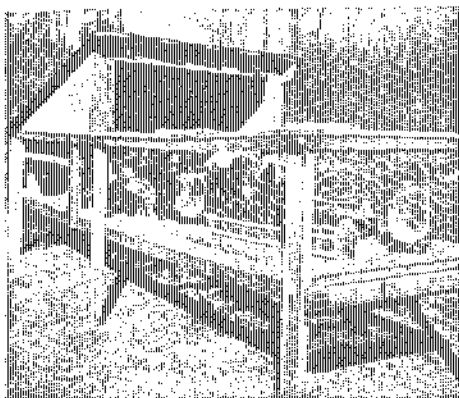

This outside sun porch is a convenient place to transfer 8 to 10 week old broilers and raise them to 3 to 7 pound fryers or roasters. Raising in confinement makes for tenderness and rapid weight gains. Sanitary floor is $\frac{1}{8}$ " wire mesh. Allow one square foot of floor space per bird at 10 weeks — two square feet at 20 weeks.

block and axe or the more expert commercial poultryman's method of sticking through the roof of the mouth, we use a gadget which looks like a miniature guillotine. This extremely humane device makes killing easy, sure and not messy.

Secondly, after dipping the chicken into hot water—not hot enough to burn chicken's skin—for about 30 seconds and plucking the feathers clean, we split the broiler down the back. This makes the intestines easy to remove in a mass. The bird can then be cut completely in half, washed, quartered, and it's done in much less time.

Tenderest Chicken

Battery broilers, fryers, or even roasters—and we've raised and eaten all three—are more tender than chicken grown on range. The reason for this is



One of the simplest most humane ways to kill poultry. A light blow of the hand and blade, held steady in the slot, punctures spinal cord leaving outlet for blood. Blade springs back, chicken is dropped into barrel.

immediately apparent—broilers raised in confinement do not toughen their muscles as do birds grown on range. Battery broilers and fryers, in fact, are usually so tender that the wholesale buyer of live poultry often will not buy them to dress and market, because battery broilers picked up alive at the farm and trucked even 10 to 20 miles, often lose up to 25% of their weight they are so tender. However, this commercial disadvantage is a distinct plus when you are raising chicken for your own use.

Home Made Brooder

If you do not have or buy the battery brooder pictured on the opposite page, you can easily set up a simple brooding outfit as shown. (Or you can buy a simple brooder like this at very small expense.) You can vary size of light bulb, get approximately right temperature under brooder—about 90 degrees one inch from floor, reducing gradually to room temperature in about 4 weeks. Then remove brooder.

Floor space required for each bird is about 7 to 10 square inches under brooder and about $\frac{1}{2}$ square foot outside brooder. Fine meshed wire or tar paper 12" high should be used to confine chicks close to brooder for first week.

Room or building used must be clean, fairly warm (70 degrees desirable—must not be less than 50), well ventilated, preferably with windows facing south for maximum sunlight. Your feed and grain dealer will have litter for floor, inexpensive feeding and watering pamphlets; perhaps free, detailed pamphlets on this phase of poultry raising.

Get your day-old chicks, either from

Summer Range Shelter

Putting pullets "on range" at 6 to 8 weeks old, with simple, shelter-type housing, as illustrated, is probably the best way to get healthy, sturdy birds. You can also raise broilers, fryers and roasters this way, but we think the battery-confinement method described and illustrated elsewhere on these two pages is preferable. You get better eating chicken in shorter time that way.

The shelters can be used in the North from May through October. Allowing the correct amount of floor space per bird—one square foot or more—a shelter 6 feet square would be large enough for 20 to 25 birds. (One of the most important things to remember about keeping any kind of livestock is never overcrowd).

Shelter design can be varied, but is based on these elements: a weather-tight roof; a wire mesh floor eight or more inches off the ground; roosts above this (one-by-two strips nailed flat on top of wire are suitable—allow 10" of roost space per bird); boards or wire all around bottom to keep birds

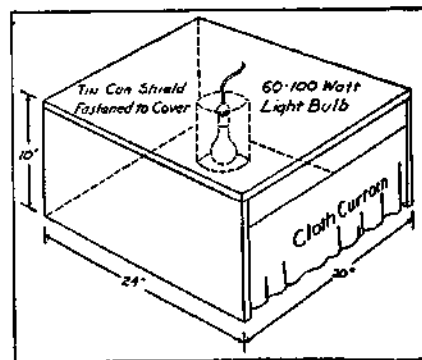

From Washington State College

feed dealer or by mail late in March or April. When six or seven weeks old, along in May (neck and head should be well feathered), birds can be transferred to summer range shelter unless house where started is designed for and has outside yards suitable for their growth to maturity. Cockerels and pullets should be separated at about 8 to 10 weeks of age, depending on the breed—in some breeds they are easier to tell apart than in others.

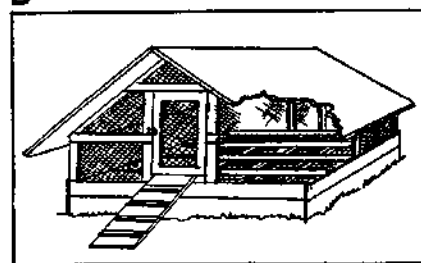

from droppings under floor; wire around sides from floor to roof to allow good ventilation; a door to shut chickens in at night and to keep rodents out.

Range can be any grassy piece of land, clover being particularly good. Allow 100 square feet per bird—the more range and the better the grass, the less boughten feed the birds will need, and the healthier they will be. Fence in to keep chickens away from garden and to keep dogs out. Covered feed trough and water fountain are placed near shelter and should be moved every week or so to assure clean footing for the birds.

Geese Grow on Grass

IN raising poultry, Ed and I believe chickens are fundamental—they furnish both meat and eggs. But after you are producing broilers in your battery and have a flock of laying hens, you ought to consider raising at least one other kind of poultry for variety's sake.

It is up to you to choose geese, ducks, turkeys, squabs—or something fancy like guinea hens or pheasants. You can easily handle one or maybe two of these in addition to your garden, fruits, chickens, goats and bees. You've probably eaten duck and turkey recently, maybe goose and squab. If you haven't eaten these latter two recently, do so—and then plan on raising what ever you like the best.

We Robinsons believe the goose is tops—best-tasting. Yet it seems to be the forgotten fowl in America. The most common objection we hear is that goose is too greasy. But you don't have to eat all the grease any more than you eat all the excess fat on the best cuts of beef. The first Christmas we were married I roasted a goose (at Ed's in-

sistence!) even though I had never tasted it. I used a prune and apple stuffing to offset the richness and pricked the skin to release fat which could then be poured out of the pan. I have been an ardent goose fan ever since. If you like dark meat, which we think more succulent and tasty than white, you should like goose.

Geese are the cheapest and easiest of all poultry to raise. Extremely hardy, they are rarely affected by any disease or insect pests. After they are two weeks old all they need is plenty of water and grass and they will gain a pound a week until they are about 12 weeks old. They may be eaten at this age and are called "green geese". Geese have no use for fancy housing—a simple 3 sided shed where they can keep dry in the severest winter weather is all they want for they prefer to stay in the open even at night. As for fencing, any low wall or fence 36 inches high holds them. At breeding time geese make their own nests, hatch their own eggs.

In Europe and Asia geese have been

highly valued for centuries. As far back as 4000 years ago the Egyptians used goose liver to cure night blindness—and they were right, for scientists now know goose liver is exceptionally rich in Vitamin A because geese eat such large quantities of green grass. Before the war Europeans raised more than 100 million geese a year.

If you live in a closely populated section you will not find geese desirable as their call is a noisy one and they are easily disturbed. In fact, they make good "watch dogs". If you want to keep feed at a minimum, ½ acre of good grass will support 8 to 10 large geese. Of course, you can keep them in smaller areas and supplement their grass with waste greens, vegetables or fruit and a little grain. Oats make a good grain. Geese need sand, grit and oyster shell for egg laying and digestion's sake. But from early spring till winter, it is grass and water than they prefer. If you supply those two things, your geese will virtually raise themselves.

You can start having geese by buying fertile eggs, day-old goslings, "started" goslings, or a matured pair or trio at least two years old. We could find no geese true-to-breed in our section so we bought eggs (35¢ to \$1.00 each) and hatched them under setting hens. It was one of the biggest thrills we have ever had—to see those little goslings hatch out. Here are the rules we would suggest after our experience:

1. Don't pay too much attention to all the free advice you'll get unless it comes from someone who has successfully handled geese for several years or from the Department of Agriculture or State Experiment Station.
2. Order your eggs from a reputable dealer suggested by your county farm agent or one who advertises in a good farm magazine.
3. Get your broody hens promised to you ahead of time by a large poultry keeper if you don't have any of your own. You may buy or borrow them. One hen covers 4 to 5 goose eggs. Move and place the hens on their new nests at night and keep the nest darkened.
4. When you make up the nests, dust them thoroughly with insect powder. Also dust the hens well a day or two before the eggs hatch. (You may use an orange crate on its side for 2 nests if you place a narrow board across the front to keep the eggs from rolling out).
5. Goose eggs, contrary to the usual practice, may be washed before setting. Turn the eggs once a day (when the hen is off her nest) as they are too large for hens to manage.
6. Take good care of your hen and her eggs. It takes from 28 to 35 days for eggs to hatch—a long setting for a hen. Take her off her nest once a day and give her grain and water. Be sure food and water is close so she won't wander off and forget her nest. A hen on goose eggs should not be off nest long enough for eggs to chill.

During the last week sprinkle the eggs with lukewarm water each day. The day before hatching place the eggs in a pan of warm water to cover eggs well and watch your live goslings bob. After a few bobs replace eggs in nest



Carolyn and Jackie get a close-up of a new member of the "family" — a day-old gosling. He came out of the shell yesterday. Today he is able to shift for himself quite well. A setting hen hatched him. Four or five goose eggs can be hatched (in 28-35 days) under a hen while your goose goes on laying more eggs.

and nature does the rest. (You furnish water to duplicate what occurs when a goose returns to her nest with her feathers a little wet.) If the egg should show the first crack of hatching, don't submerge the broken part. It can take a gosling as long as 24 hours to hatch after the first tiny crack in the shell, so don't be worried. Even if a gosling's head has emerged, the European custom is to push the head back into the shell so the gosling can obtain leverage to extricate himself. Take goslings from nest as soon as they hatch; place in a box and keep in a warm place until the hen completes her hatch. It is best to remove goslings because the hen is apt to get ex-cited at the first hatch, leave the rest of the eggs unhatched.

After you have hatched the goslings or if you buy them, keep them in a box with a few cloths in it in the house or some other warm place. A few hours after they are born feed them some chopped green feed—grass, lettuce, etc.—natural food for geese. Stale bread soaked in milk and sprinkled with a little sand, or a warm mash or chick starter may be fed. After the first day or so when they learn to manage their legs, put them out on the grass during the day—provided the weather is warm. But be sure to keep them in a warm dry shelter at night and don't let them out until the dew is off the ground. It is wise to let them have their box or shelter at night until they are well-feathered—at least 3 weeks old.

Care of Mature Geese

Buying matured geese ready for breeding is the most expensive way to start your flock, a good trio costing \$25-\$35. However, if you decide to do this, it's best to mate just a pair, even though it is common to have a trio of 1 gander and 2 geese. Geese prefer to live a monogamous life, in contrast to other birds. After they once mate, they are faithful to each other for years so don't break up their happy union. Buy your geese and pair them in the fall so they will be settled and ready to lay in February (the usual time in mild climates.) Your goose and gander should both be 2 years old to be fully matured and to produce fertile eggs.

The difficult aspects of raising geese are to get fertile eggs and proceed properly with the hatching. Your success or failure begins with the gander. He prefers living with but one female—although sometimes he'll take up with two. But the gander and goose usually must live together some months before they will mate. Although water isn't absolutely necessary, some kind of a little pool (see Chapter on Ducks for making pool) or stream is good because geese breed more easily in water. Once you have fertile eggs, be sure that the hen or goose you set them under is really broody. Start her setting on some hen eggs for a couple of days to make sure she's really serious about hatching

The young geese are 8 weeks old — half-grown and weigh about 9 pounds. The pair of breeders (at left) are two years old. Geese are extremely healthy, eat grass, and practically raise themselves.

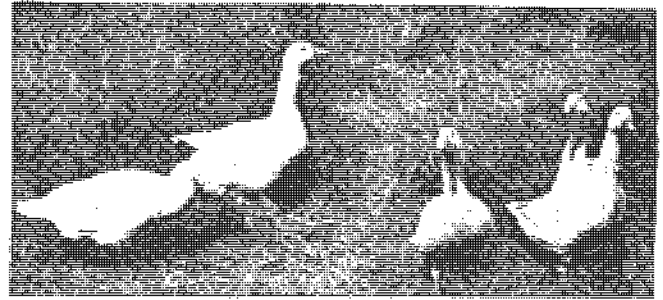

a family before trusting your geese eggs to her.

All the laying goose needs is a barrel or box on its side or some simple shelter and the goose will fashion her nest out of straw, twigs and her own goose down. The average goose of the heavy breeds can lay about 20 eggs, but is able to cover only 12 to 15, so remove the first eggs if you want her to continue laying more than she can set on. After she stops laying and becomes really broody see that she has as many eggs as she can cover well. Then, provided she has water (say, a large pond) so eggs will receive proper moisture, you can relax and let her hatch her own eggs. She'll turn them and do everything necessary.

We find geese are friendly and like to follow us around the yard, except during the mating and hatching season when it's best to stay away from the gander. Geese are fearless and will attack anything—you needn't worry about a rat, cat or dog bothering them.

Choosing a Breed

Every small flock we have seen seemed to be some kind of mixture stemming mostly from the gray and white Toulouse goose. We chose the Embden because my wife wanted all white Toulouse goose. The other two best known breeds in this country are the African and Chinese. Both have distinctive knobs on their heads. The African is brown, apt to be noisy. Chinese geese may be white or fawn, weigh from 10 to 12 lbs., are apt to be noisy. They belong to the exhibition breeds.

Though we don't expect you to go into the business of raising geese we thought you might like to know that the commercial by-products of the

goose are exceptional. When geese are specially fattened they develop large livers which can be made into the famous "pâté de foie gras" which means "patty of fattened goose liver".

You know how goose feathers are valued in pillows and upholstery, but did you know they are widely used in artificial flowers, Christmas tree decorations, fish lures, powder puffs, and many other things? And goose skins are also used in one kind of powder puff besides their more familiar use as cracklings. And that "awful goose fat" we hear about so much is known to many people as "schmaltz"—is exquisite in taste and highly regarded by knowing cooks for pastry shortening, bread spread and other cooking.

Some people like "schmaltz" plain as a bread spread—or if that is too fat, you can make a Swedish bread spread. Cover bottom of skillet with goose fat, add finely chopped onion (1 large) and unpeeled apple (about 3 medium), brown slightly. Add ½ cup goose fat and simmer over very low flame until onion and apple are soft. Then place in container and in refrigerator where it will keep a long time. Use cool.

To make plucking easier dissolve 2 cakes of paraffin (poultry plucking wax obtainable from a poultry supply house is better than ordinary paraffin) in a large kettle of boiling water. Dunk the goose thoroughly in this mixture immediately after it is killed and bled. Then start plucking right away. The paraffin ruins the feathers for future use, but if you really want the down you can dry pick.

Despite the difficulty of picking, we think the goose is a wonderful bird!

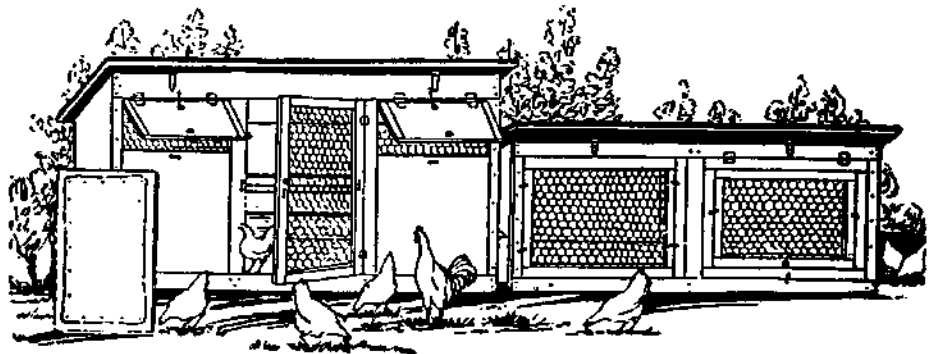

We bought this little poultry house and the scratch shed (at right) for our original backyard flock of 7 laying hens. It cost \$28.00. Since then we've used it as a coop to fatten broilers and as a shelter for our geese.

Turkeys

Can Be a Profitable Sideline

WHEN you start producing food for your family, money will begin to lose its importance. You won't be digging into your pockets every time you turn around. First, you yourself will be producing a good part of your food and secondly, you'll be trading your surplus with your neighbors.

For example, we trade geese for turkeys with one of our neighbors, Tyler Long. Ty and his father have always had a hankering to raise turkeys. For a long time they just talked about it, then a couple of years ago they started in doing it.

Unlike a lot of people, including a few farmers I've met, they were frank with themselves in admitting to begin with that they didn't really know much about turkey raising. They determined to find out all about the newest and best ways of going ahead, start on a small scale. So they talked to any number of commercial turkey men, our county agent, and read everything they could get their hands on about turkeys.

Just to give you an idea of how well they've done, in 1942 the national turkey mortality rate from all causes was reported to be 28%. In 1943, when feed conditions were at their worst in 20 years, Ty kept his mortality rate down to 15%.

While it's true that scientific turkey raising requires certain precautions not always necessary in chicken raising, if a few general principles are followed with care, turkeys can be a surprisingly easy, inexpensive and interesting way of increasing your food supply. Turkeys, incidentally, produce more meat per pound of feed than almost any other kind of poultry.

We say this after observing Ty Long's experience raising turkeys. In fact, we have gotten him to give detailed, week by week, instructions, explaining exactly how a family can scientifically raise a dozen or so turkeys.

What Breed?

By no means try to hatch out turkeys from eggs—buy day-old chicks or poults as they are actually called. Place your order early, sometime between December and March. The importance of good breeding in the day-old poults cannot be stressed too much.

Ty recommends buying them from a well-recommended breeder rather than from a hatchery. You can get names from the magazine, *Turkey World*, (Mount Morris, Ill., 15c a copy) or consult your county agent. Don't decide on a breeder farther away than

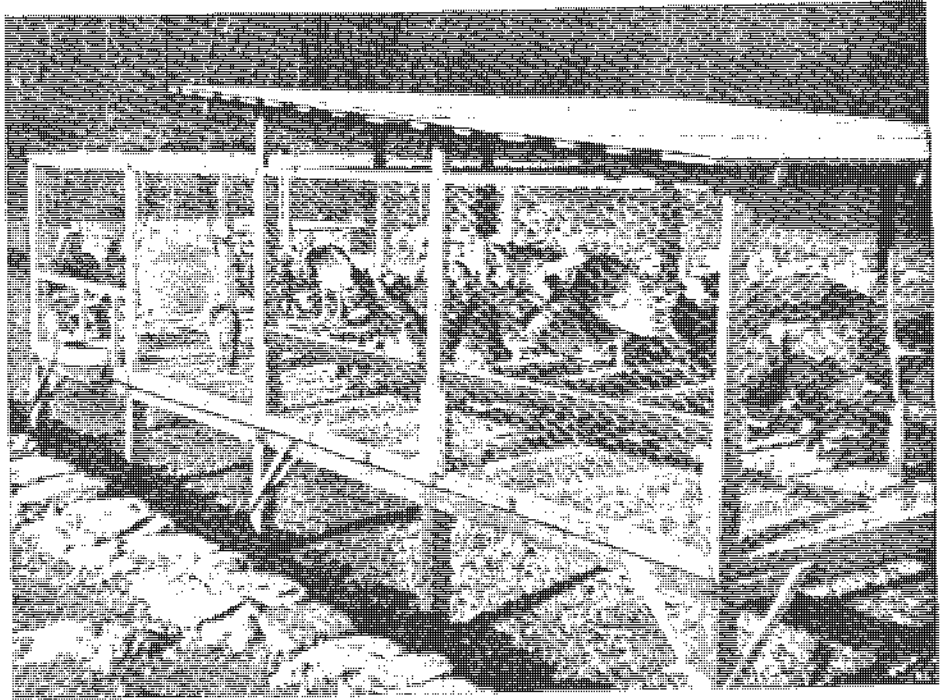

Twelve or thirteen turkeys should have a cage at least 10' by 12' with 12' of feed hoppers running along the outside. Roosts should be built in the sheltered end of the cage, using 2-by-4's with wide side as the roosting surface and allowing 14" space per bird. Top of roosts should be 20" from the wire floor and a space of 24" should separate one roost from another. Allow the birds complete access to the floor under the roosts, otherwise you cut their exercise area to the bone. A slanting roof of very heavy roofing paper and three sides of the same material (removed in above photo) should protect the roosting section.

300 miles, preferably closer. Specify shipment by Railway Express.

Most breeders specialize in Broad Breasted Bronzes—they give more meat per pound of frame. This is a good breed to start with, unless you want one of the smaller breeds. If, for your family use, you'd like to wind up with eight or ten fully grown turkeys, you'd best order 15 poults. Poults sell for from \$.50 to \$.75 apiece. These 15 will probably narrow down to twelve for the cage and eight or ten for your family and friends. You may, of course, do much better than this, in which case you can easily sell your surplus at a nice little profit.

Poor sanitation and dampness, huddling caused by improper heat control, and failure to start eating are the greatest causes of death in young poults. Because a battery brooder provides a maximum of sanitation and dryness, practically eliminates huddling, and its confined quarters are a big help in starting poults eating, we believe a battery is the easiest and safest way to raise your turkeys for the first four weeks. Equally important, a battery brooder reduces labor to a minimum. (See article on broiler battery, page 32).

Here are Tyler Long's week-by-week instructions. Don't let their seemingly lengthy detail discourage you. It's really easier than it sounds, and, besides, Ty is more of a "perfectionist" than most of us are likely to be.

Week-By-Week Instructions

These instructions are not intended to be absolute. We feel that reasonable appli-

cation of them plus common sense circumstances not discussed in this short article will result in your successfully raising your turkeys.

From First Day To Fourth Week

At least 2 days before the poults come, completely scrub battery, inside and out, feeders and waterers with hot soapy water. Rinse with hot water. Spray with a warm 4% solution of any reliable coal-tar disinfectant. Only then will your poults be reasonably safe from germs left by the battery's former inmates. Be sure all surfaces are thoroughly dry before the poults come in contact with them. Cover dropping board with newspaper to facilitate daily removal of droppings.

At least 4 hours before poults' arrival regulate temperature under hover (using brooder thermometer or thermostat) to between 95° and 105°. Reduce to 90° the third day. Thereafter a drop of 5° per week is usually advisable. However, behaviour of birds themselves is best barometer of their comfort. Cold poults usually huddle (their most dangerous habit), peep loudly and protestingly. Overheated poults act drugged and listless. Comfortable poults either sleep quietly or peep in a low, contented voice. Above all guard against huddling. More poults die in the first four weeks from smothering caused by huddling than from any other single cause.

On the other hand, it's just as important to remember that over-heating the birds at any stage of the game tends to produce a delicate, over-sensitive turkey. It is usually best for the first two or three nights to wake up at 1 or 2 a.m. to see that turkeys are comfortable. This is a chore, but a necessary one, since as many as 50% of your poults can be killed in one night by huddling.

Before placing your poults in their new quarters, fill the hoppers almost to overflowing with a turkey starter mash from a reputable feed concern. (If the mash is not Vitamin D fortified, add and mix thoroughly 1% Cod Liver oil until the birds are out in the sun.) Sprinkle about one teaspoonful

of fine hard chick grit to each three poult on top of the mash, so that they will get their "teeth" with their first meal. Continue giving this grit twice weekly until the tenth week. Fill the waterers with water the temperature of your hand. Continue for two weeks, then change to tap water. Keep both feeders and waterers filled to this level until poults can reach down into them.

Some of your poults may refuse to eat when you first get them. Put down a newspaper and scatter on it some chick scratch. Usually they will peck at this. Next day put chick scratch on top of mash in feeders.

Wash the waterer every day in hot soapy water. Keep it filled with fresh, clean water. Wash feeders every ten days. Stir old feed in with new to prevent any becoming stale.

Inspect your poults upon arrival, culling out any malformed, injured, or dying ones. The simplest, most humane method is to snap the neck with a quick, strong twist of the hand. The same treatment should always be accorded any deathly sick or badly injured birds as a protective measure for the rest of your flock. However, like chickens, no disease or injury to which a turkey is susceptible can in any way render the flesh unfit for human consumption. But any birds that are to be eaten should be killed so that they will bleed.

Disease Control

Baby turkeys are subject to a number of diseases, the most prevalent of which are coccidiosis and brooder pneumonia. The former is usually recognizable by bloody droppings and a general washed-out look to the bird. Pneumonia can sometimes be detected by the presence of phlegm in the nasal passage and some shivering. In each case the poult must be segregated from the others, kept warm and dry and fed warm milk, with an eye-dropper, if necessary. Nothing more can be done in the case of brooder pneumonia. The development of coccidiosis is sometimes arrested by administering a 1% solution of Epsom salts. This must be followed in six hours by dried skim milk mixed with the mash or water. Commercial anti-coccidiosis agents are sometimes found helpful. Never return the sick bird to its regular quarters until you are fairly certain a cure has been effected—you must not risk infecting the others. (Lederle's Sulfaguanidine, a new "sulfa" drug, has frequently halted rampages of coccidiosis when other measures failed.)

Keep a weather eye out for the condition known as "pasting-up", when the poult's droppings remain stuck to his backside. This is serious, as a poult (or chick) can die very quickly from the poisons caused

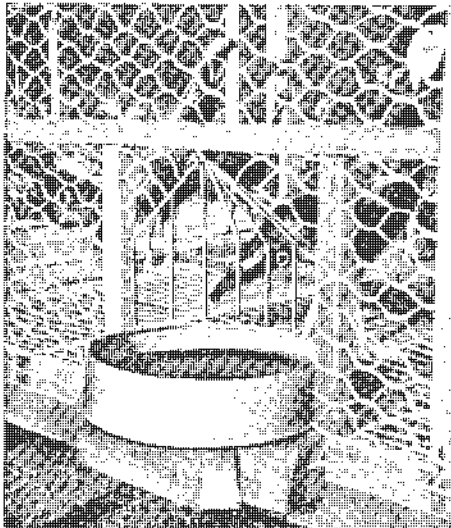

Detail of waterer: pan is protected by a wire guard. Construction prevents birds from contaminating water and enables you to water birds from outside.

by a clogged-up intestinal tract. Treatment we found safest: With a medicine dropper apply several drops of inexpensive mineral oil on and around the dropping, which will soon be worked off. Do not try to remove it; the poult's sensitive skin is easily injured.

From Fifth To Tenth Week

The advantages of raising turkeys in battery brooders will turn into serious disadvantages if the birds are kept in them after the four week period. Many growers leave poults in batteries only 16 days. The fact that the birds are allowed to develop neither immunity to disease-bearing bacteria nor resistance to less favorable climatic conditions in its protecting confines is responsible for this. Therefore, at least at the start of the fifth week the poults should be moved to a clean, dry, thoroughly disinfected floor covered with at least an inch of good quality shredded litter, preferably sugar cane shavings. The average temperature, at the floor, of their new quarters (section of garage, barn, enclosed porch, small brooder house, etc), should be somewhere between a minimum of 65° and a maximum of 75°. If it is not possible to use the top-section of your battery as their hover (in which case you would remove the dropping board, floor grid, removable sides, feeders and waterer, using it only as a source of heat and shelter on top of the litter), build or buy a small auxiliary hover. (See Chapter on Broilers).

Such a hover, which can be quite simply constructed of insulation board with either 2 or 3 25-watt bulbs or a commercial heating element installed in the roof, must be large enough and adjustable in height so as to accommodate all the birds when they are ten weeks old, at which time they should be more than twice the size they were at four. The temperature should be gradually reduced (if necessary, vary the number and size of the bulbs) so that the birds get little artificial heat for the next to the last two weeks and none whatever during the last two weeks. Important considerations in selecting the poults' new quarters are adequate ventilation facilities and a good supply of sunlight, at times directly on the birds, if possible. Be careful about direct drafts on the birds for the first 3 weeks in new quarters. It would be much to your advantage if you could provide the turkeys with direct access to the air and sun in a small, fine gravel-covered yard or wire-covered cage connected with their new quarters. To accustom the poults to outside temperatures and breezes, be sure to leave all ventilation facilities wide open for the last ten days and nights.

Litter should be thoroughly stirred every other day and completely changed weekly. This is necessary both to combat germs and to keep their walking surface dry, a point of great importance. It is also important to keep the waterers on three-inch high wire platforms to prevent contamination.

Mash should now be fed in a regular chick hopper, water in a one or two quart glass or metal chick waterer. Finely chopped tender green-stuff (lettuce, spinach, orange, cabbage, grass, clover, etc.) can now be fed the poults to great advantage. Scatter moderate amounts each day on top of their mash. Otherwise, feed, grit and water conditions remain as before. (8th week—start to mix growing mash with starter. Gradually increase to all growing, 10th week)

From the sixth week on, a careful watch must be kept for the most dread of all turkey illness, "blackhead." (For identification and treatment of this and other turkey diseases get the Dept. of Agriculture's Bulletin 1652 *Diseases and Parasites of Poultry*.) Sanitation and segregation of infected birds is your best weapon in fighting both blackhead and coccidiosis. Lederle's Phenothiazine has arrested many epidemics of blackheads, but cannot be guaranteed as a positive cure. If any signs of lice are detected a very light sprinkling of drops of "Black Leaf 40" wherever the birds bed down, be

it litter or roost, will rid them of the torments and dangers of lice.

From Tenth Week To Maturity

By the tenth week, under normal conditions, your poults should move to their permanent outside quarters. However, if poor feed or other circumstances prevent normal development or if the weather is unfavorable, it would be best to delay the transfer for a short time. These permanent quarters should consist of a solidly built wire-floored four foot high cage, with its base thirty inches off the ground and supported by pine or fir 4 x 4's whose bases have been dipped in creosote.



Ty Long feeding his turkeys. He says feeding time takes only a few minutes when hoppers are conveniently placed outside cage and adequate to hold a week's supply of feed. Good size for hoppers—8" deep, 8" wide, covered by 12" slanting roof.

If possible, open face of roost enclosure should face south. Sides and top of the cage may be constructed with lath or 2" poultry netting. Great caution should be exercised in eliminating all possible surfaces on the floor where droppings can collect. Bevel 2" x 3" (on the top) so that they will just hold staples 18" apart for the 1" by 2" flooring. A door should be placed on any side of the cage not taken up by the feed hoppers. Eliminate all sharp points or surfaces where the turkeys might injure themselves.

By this time a complete change from starting to growing mash should take place. Continue feeding chopped greens whenever possible. The grit, still lightly sprinkled on top of the mash twice weekly, should now be changed to broiler size. Starting with the 12th week broiler scratch, consisting preferably, of cracked corn, oats and wheat, should be fed in approximately one-quarter of the hopper space, boxed off from the rest. By the 20th week this should have been gradually increased to half the hopper space. Also near the 20th week the grit should be changed to full-sized and the scratch, consisting of the same ingredients, to full-size. Gradually increase the percentage of grain to mash until by the 20th week the birds are eating 50% of each. At this time it would make for a better finished turkey if you can make the scratch mixture 70% to 80% corn. It is possible, the last few weeks, to increase the consumption of feed by feeding a moist mash, made by mixing hot water on top of the dry mash in hoppers. However, care should be taken that none of the dry feed becomes sour. Remember the principle of finishing turkeys is to stuff them with as much feed of high caloric value as is possible.

An ailment known as perosis or "slipped tendon" is more prevalent in turkeys from the tenth week on, but it sometimes occurs earlier. Usually hereditary or nutritional in origin, perosis is sometimes introduced through infection. The trouble is easily recognized by the severe lameness and crookedness of one or both of the victim's legs. For treatment see the Farmer's Bulletin of poultry disease, No. 1652.

(Continued on next page)

Turkeys (Continued)

Your turkeys are ready to kill when they have a fine layer of fat covering the entire body (shown by a white or yellowish appearance of the skin, rather than the purple tint of the muscle tissue) and when at least 95% of the pinfeathers have disappeared. This usually takes from 24 to 28 weeks, but any number of circumstances can delay the finishing. If you want your turkeys to be the best you ever tasted, you'll just have to be patient. A well finished Broad Breasted Bronze tom should weigh a minimum of 18 pounds and often as high as 26 and 28. The hen (whose flesh is not of a quality superior to the tom's) should weigh from 12 to 16 or 17 pounds. A smaller breed will weigh proportionately less.

During starving time, 18 hours before killing, provide plenty of fresh water.

Killing and Picking

For a turkey slaughterer or amateur standing, decapitation with a sharp axe or machete is quickest, easiest. Immediately after the head has been severed, the bird should be elevated so blood is allowed to drip for about ten minutes. The plucking should take place immediately after the blood has stopped dripping. Again, the simplest method of plucking for amateurs is the semi-scald dip. Using a large vessel similar to a wash tub and a cooking thermometer to assure a temperature about 175°, the entire body of the turkey should be immersed for about 40-50 seconds. The feathers should come out with great ease; if not, dip again. It may be necessary to use gloves or pliers on certain of the wing and tail feathers. After the bird has been completely plucked, it should be hung by feet in a room with a temperature from 30° to 40°, and preferably, a relatively high humidity. If there is any food in the crop, the entire crop should be removed through a neat 3" incision in the front of the neck. Sew this up to prevent drying out and squeeze the vent to remove any droppings that may be there.

The turkey may be cleaned and roasted at any time after two days of chilling have passed; if the temperature and humidity are correct he may be kept up to 10 days. We recommend that you take your first bird to be cleaned to the butcher in order that you may learn the tricks of the trade directly from him.

Points To Remember

In conclusion, here is a digest of the cardinal principles of scientific turkey raising. 1) Sanitation and dryness are your most efficient weapons against disease. 2) Never overcrowd your birds at any stage of their development. Always provide more space rather than less. 3) Never allow your turkeys to come in contact with chickens or any other poultry. Keep them as far from other fowl as possible. If the turkeys are to live in any shelter formerly used by other poultry always thoroughly disinfect those quarters. If there has been any disease there, always fumigate with formaldehyde and potassium permanganate. 4) Always allow adequate space at the feeders and waterers. This means that every bird should be able to eat at the same time and four birds should be able to drink at the same time. 5) Remember that turkeys are but recently descended from their parental wild stock—avoid all unnecessary loud noises, sudden movements and other disquieting influences, since they are much more timid and easily frightened than other poultry. 6) Always slip on rubbers or different shoes when going into the turkey shelter, so as to reduce the possibilities of infection from your chickens. Do not allow any visitors into area where turkeys walk.

Ducks are Easy to Raise

P EOPLE are always giving us something. We got our trio of Muscovy ducks one day when a lady who lives near our Country Bookstore in Noroton, Connecticut, moved. They were breeders and she didn't want to have them killed. Knowing that we had a small farm, she thought we might like them.

There is a good deal to be said for making ducks your second poultry project, particularly if you have any kind of small stream or pond on your place, although neither is necessary. One of the unusual things about ducks is that they are well adapted to either a small place or to large-scale commercial production.

Don't start a duck project unless your family is fond of duck. If you're anywhere near as successful as we've been, you'll have a lot of duck. The trio that was given to us has produced over 25 ducklings in the first six months. Incidentally, Muscovy ducks are better eating, we think, than the ordinary Pekin variety that you get in the market.

Anyway, ducks do furnish delicious variety for the table. Many people like duck eggs, too, especially for cooking. Ducks require relatively little care and are practically free of disease problems. They are efficient and economical meat producers, gaining weight rapidly even when allowed to forage for much of their food.

You have three choices as to how to plan your duck raising program. You can keep a small flock of breeders the year around. You can buy day-old ducklings and brood them like baby chicks, but with less heat and care. Or you can buy duck eggs and hatch them out under hens.

Keeping A Small Flock Of Breeders

If you just plain like ducks and like having them around; if you would like having some duck eggs for eating or

cooking in addition to having duck meat; if you have some grass forage land; if you have a stream or pond—then keep a small flock of breeders.

You don't have to qualify on all these points to keep a flock of breeders, but if you do, then your flock will practically keep themselves, providing you with plenty of tasty meals from spring until late fall.

If you don't have forage, ducks can be fenced in, but will require more feed. If you don't have the stream or pond, you can provide a sunken trough, half-barrel or pan. You can raise ducks successfully without any water, but they like water to wash themselves in and it is said to be best if the eggs are moistened regularly during the setting. This moistening occurs naturally whenever the ducks return to the nest with wet feathers from bathing.

For housing almost any kind of shelter will do. A small coop with a door like that on page 39 would be ideal, because if you want to gather eggs it is a good idea to keep ducks shut in until 9 or 10 a. m. Supply litter on floor for warmth and dryness.

Your ducks will build their own nests in the shelter or around the place and will each hatch twelve to fifteen or even more ducklings at a sitting, and they will probably do it at least twice a year. They may produce eggs the year around, heavily from early spring through July. The number of ducklings you let them hatch will be determined by how many eggs they lay and how many you take to eat.

One drake for up to five or six ducks is a workable arrangement, but you will probably want to start with a "trio" of one drake and two ducks. A small flock will give you all the ducks that you want.

Ducks of most breeds are ready to eat from the age of about 10 weeks on. The commercial raisers force their flocks to a peak of growth and fatness at about nine weeks and then market the whole flock at one time. After that

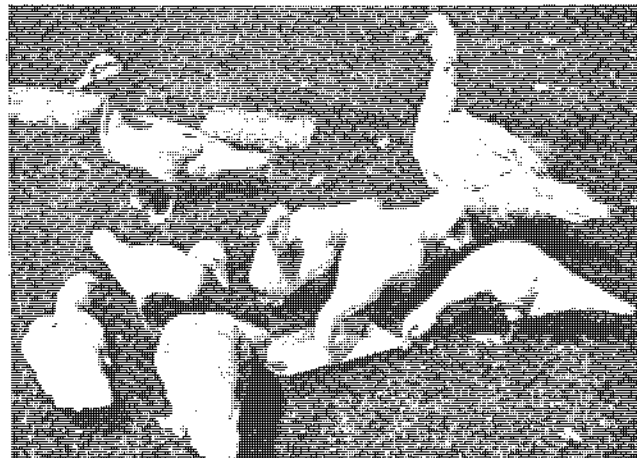

Here are our quackless Muscovy ducks. We chose this breed because they aren't noisy; they have a better flavor, we think; they're very hardy and free from disease. Our trio of drake and two ducks produced 18 young ducks on their first hatchings. These ducklings are about 6 weeks old.

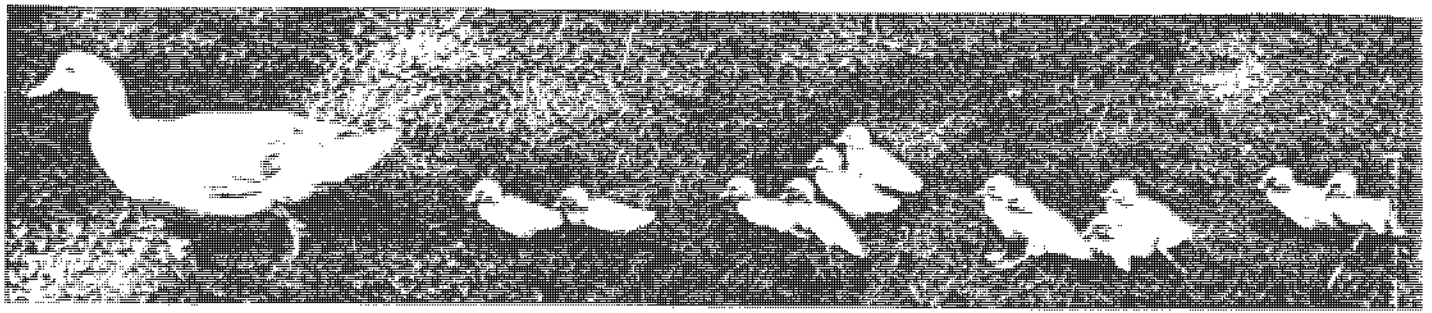

age the ducks will go into a moult and gain weight very slowly no matter how much they are fed. This is no great disadvantage in the small home-size flock which is foraging for much of its food anyway, and the usual practice is simply to start eating the ducks when they are big enough, and to go on eating them as needed until they are all gone, saving only the breeders chosen to be carried over to the next year.

Your original trio of breeders may be kept for two or three years or even longer, but more probably you will select from your whole flock a new drake and new ducks for breeders every year or two. You will probably want to buy or "swap" in new blood occasionally. There are many breeds of ducks, but the three breeds most suitable for the home flock are probably the Pekin, the Muscovy and the Indian Runner. The Muscovy is the largest, the Pekin next. The Runner lays the most eggs. Neither the Pekin nor the Runner is a good "sitter," and you would probably have to hatch their eggs under hens.

The Muscovy is a good big duck, the mature drake weighing 10 pounds and the duck 7 pounds, and they are a very hardy, self-reliant breed. The Indian Runners weigh only 4 to 4½ pounds at maturity. One important advantage of the Muscovy is that it is quackless and won't bother your neighbors. Muscovies are fliers, though, and if your fencing isn't pretty high, you may have to clip the outermost feathers from one wing.

A trio of one or two year old Muscovy ducks, of good healthy stock, will cost you about \$10.00, and you can obtain them by mail from breeders who advertise or perhaps you know some

one who raises them near you. Day-old Muscovies will probably cost from 40¢ to 60¢ apiece.

If you can't get the duck pellets, the simplest thing to do is to feed the same mash and grains you feed your chickens. A wet mash is sometimes fed, but this is an extra "wrinkle." When growing ducks are not able to forage, keep feed before them most of the time as you would for chickens.

If your ducks have a stream, pond or fairly large, clean bathing trough, you don't need to provide other drinking facilities. If they don't, you should

The season when they are easiest to get runs from April through July.

By starting a dozen ducklings two or three times during the season, the first batch early in April, you can have a steady supply of eating ducks coming along from mid-June until late fall. And again, of course, if you have a quick freezer, you can have roast duck any day of the year you choose.

You can brood your ducklings in the same way you brood chicks, except that they require artificial heat for only three weeks—a shorter time than chicks do.

Setting Duck Eggs Under A Broody Hen

There are points to watch carefully in this method. One is that you obtain the broody hen at just the right time. She should be in the first week of her broodiness because duck eggs take about 4 weeks (a week longer than chicken eggs) to hatch, and she may tire of the job unless you get her when she has just gone broody. (Muscovies take 5 weeks to hatch.)

You should also care for the hen faithfully during the period of incubation. Take hen off nest daily, feed and water her. Usually she will stay off only five minutes to eat and drink, then get back on eggs herself. If she doesn't, put her back before eggs cool. Dust her well with insect powder at the beginning. You must also be sure the eggs are moistened (sprinkled with water) the last few days of the period.

A hen can usually hatch only seven to nine duck eggs, because they are so much bigger than chicken eggs. A rat-proof coop with wire run, as illustrated, is advisable for the hatching period of about 4 weeks and also for the brooding period of about 3 weeks.

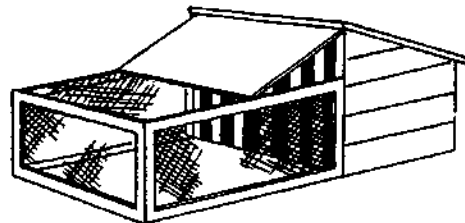

Coop and wire run suitable for hatching and brooding of ducklings with a hen. The bars keep hen confined, but let ducklings get sunlight and fresh air safe from dogs, cats, rats, etc. Top lifts up to allow cleaning, feeding, watering.

provide a reasonably deep (4 inches anyway and at least 12 to 15 inches across) supply of water. This is because of the peculiar nasal construction of ducks. They need to be able to get most of their bill in water when drinking.

Buying Day-Old Ducklings

You can get day-old ducklings through your feed dealer, from a neighbor who raises ducks, or by mail from people who advertise in farm journals.

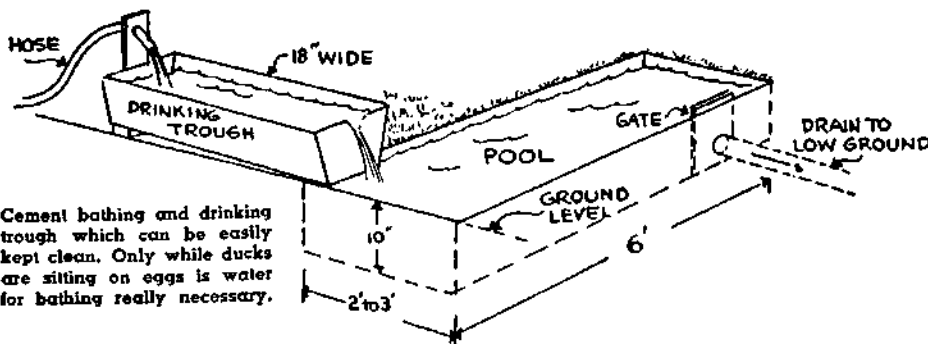

Cement bathing and drinking trough which can be easily kept clean. Only while ducks are sitting on eggs is water for bathing really necessary.

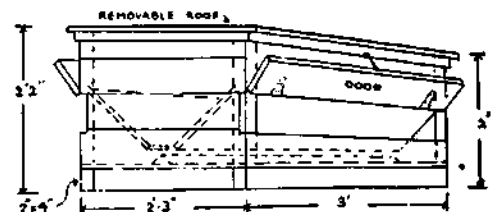

Ducks are messy feeders and will waste less if pellets instead of mash are used. Here is cross section of pellet hopper used by commercial duck raisers. It can be made any size to hold from one to several hundred pounds of pellets, thus saving much labor. "Flaps" can be closed to cut down time pellets are available to the ducks, thus forcing them to forage.

Squabs . . .

AS we've said we chose geese as our secondary poultry project, and we don't go in seriously for squabs. We thought we should include squab raising in the Plan, however, for those people who would want to raise them, particularly folks who live in the more crowded areas where there are city zoning regulations against chickens and other poultry. There are very few cities or towns that have strict ordinances against keeping pigeons.

In preparing this section about squabs we've visited a number of squab raisers and we've done a good deal of studying and reading. What we tell here is what we'd want to know before we started a new project.

Squab is one of those dishes that are usually thought of as being expensive, delicious and reserved for epicures. You can't even buy squab at most meat markets. Many people haven't so much as tasted this mouth-watering treat.

And yet, if you decide to have another poultry project in addition to chickens, you'll find squabs to be both interesting and delicious. Also, pigeons are among the easiest kinds of poultry to raise, among the surest of success.

They are not really cheap, though, even when you raise your own. They will cost you about half as much to raise as to buy, which means they will cost you about 35¢ to 50¢ apiece, depending on the price of feed at the time and other factors. Still, when you consider that one squab is about all one person can eat at a sitting, and that they are such a treat, the cost isn't so high at that.

Another point to remember is that it is just about as easy to raise twice the number of squab you will want for your own family, as it is to raise barely

enough. You can then easily sell the surplus to cover all your costs (first class hotels and restaurants are always in the market for squabs), or you can swap the surplus with neighbors for things they raise and you don't or you can make presents of squabs to friends.

What Size Flock?

First, taking into account the size of your family, decide how many squabs you will probably want in the course of a year. (Squab, incidentally, is defined by the U. S. Dept. of Agriculture as "a young pigeon which is marketed just before it is ready to leave the nest, usually at from 25 to 28 days of age, when it weighs from 12 to 24 ounces.")

One good pair of breeder pigeons should raise 12 to 14 squabs in the course of one year. They may do this at a more or less even production rate throughout the year, but more probably production will be greater in spring and summer than in fall or winter. If you have a quick freezer you can, of course, "even out" production by freezing when there is a surplus.

If you don't have a freezer, then you will probably want to plan to have enough breeders to produce all the squabs you'll need even during the poorer months.

Figuring in this way it will be found that a "loft" of 12 pairs of breeders will probably produce an abundance of squabs for your family.

Housing

Pictured on this page is the type of housing we would suggest. For 12 pairs of breeders the dimensions of the house should be about 6 feet wide and 8 feet deep (48 square feet to allow the 4 square feet of floor space per pair that is needed). It is important that the house should be as rat proof as possible, and, as in the case of chicken housing,

that it be dry, well ventilated and facing south for maximum sunlight. Open or semi-closed front may be used, but, as you would expect, the warmer the house in winter the better. A maximum temperature of 40 degrees F. in winter will tend to increase squab production, but you can get along fine without artificial heat.

There should be a double nest for each pair of breeders. Orange crates, with three inch board nailed across front at bottom and a six inch hinged landing board, piled one on top of another will serve for this purpose. Twelve such crates would be needed for a 12 pair house. If you build your own nests, each one should be about 12 inches square and 15 inches high.

Long leaf pine needles, straw, hay and tobacco stems are all used for nesting material. If nest bowls (which can be purchased from supply houses) are used, nesting material is not so necessary but some material is generally provided. The nesting material may be kept in a crate or rack in one corner of the pen to prevent waste. The pigeons will carry the material to build their own nests.

On the south side of the house there should be a wire-covered yard or "fly" as it is called. It can be approximately the same size and shape as the house. One-inch-mesh wire is good to use as it keeps out sparrows and rats. This wire should extend 12 inches into the ground, making a right angle bend at the bottom and extending 12" to 18" away from the pen to keep rats out.

Three to four inches of sand or gravel makes an ideal floor as this drains freely and is cleaned easily. A cement yard sloped to drain well and with one inch of sand is even better. "Running boards" about 8 inches wide should be placed on sides of pen, as illustrated.

Water, Feed and Health

Bathing in addition to drinking water must be provided for pigeons. An ordinary dishpan will serve for bathing and should be filled with water and left in the yard (except on cold winter days) for not over one hour or two a day. Then empty the pan and turn over so that pigeons cannot soil it.

For drinking water, use a regular chicken fountain. The water should be changed daily and the fountain kept clean. Obviously, running water handy to pen is a desirable convenience.

The young squabs are fed by the parents. The pigeons themselves should be fed a ration of whole grains—no mash or green feed. Minerals are fed in a separate mixture. Ordinary chicken feed will not do.

The simplest procedure is to buy a prepared pigeon ration from your grain dealer—and be willing to pay considerably more per pound for it than for chicken feed. It usually pays to buy the better grades offered, because they contain more of the ingredients the pigeons

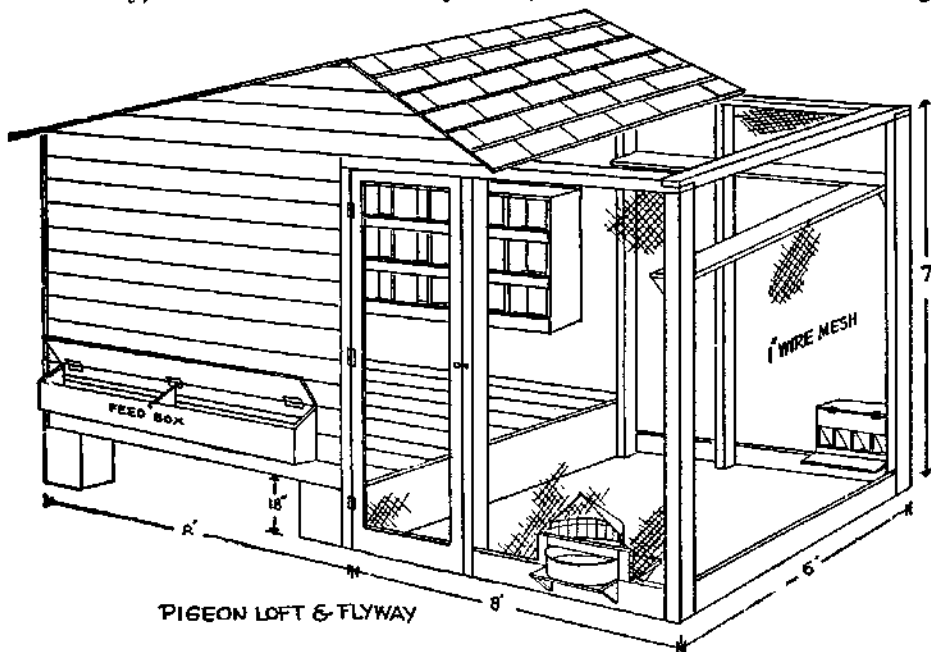

House is shown with open front. Wood or cardboard partition can be used to close two thirds of opening for winter months. Note that feed trough, water fountain and grit hopper can all be "serviced" without entering pen.

like and which are particularly good for them, such as peas.

A good pigeon feed will contain from 13 to 15 percent protein, 60 to 70 percent carbohydrates, 2 to 5 percent fat, and not over 5 percent fiber. You will find an analysis of the feed you buy tagged to the bag. One pair of breeders will probably eat about 90 to 100 pounds of grain per year.

Use a self-feeder hopper of type illustrated—one that holds feed waste to a minimum. Since pigeons will pick out certain favorite grains it is advisable to put only about one day's supply of grain in the hopper at one time.

At your feed dealer's you can also obtain a prepared pigeon grit, mineral mixture. This should be fed in an open pan or hopper, slightly moist, and kept before the pigeons at all times.

Pigeons are subject to many of the diseases which affect other poultry. However, in a small flock founded on healthy stock and with reasonably careful management, you should have little trouble. The floor of the house should have one inch of sand or gravel, droppings should be raked from house and yard once a week.

Nests and nest bowls should be cleaned whenever squabs are "harvested"—and nests containing eggs or squabs should not be disturbed. Twice a year house and pen should be thoroughly cleaned and disinfected.

Getting Started

You can purchase foundation stock from a pigeon breeder in your community, or order by mail from anywhere in the country. The magazine *American Pigeon Journal* (15¢ a copy, \$1.50 a year, address: Warrenton, Mo.) carries ads of breeders, or consult your county agent or grain dealer.

There are many breeds of pigeons, but the following are the best suited to squab production: *King*, *Carneaux*, *Swiss Mondaine*, *Homer*, *Runt* (the largest of all breeds). You can't go wrong by choosing *King* or *Carneaux*, because they are both among the most popular breeds and you will probably find it easier to connect with a good breeder, possibly one near you.

It is as important to get good pigeon stock as it is to get good stock for all your other poultry and animal projects. Get your pigeons from a careful breeder who keeps accurate records of the production and weight of his squabs and who guarantees both age and sex.

You will want mated pairs, at least 6 to 8 months old, and yet not too old—not more than two years old. As a rule, it rarely pays to keep breeders more than 5 years. (You can eat your old pigeons, but they aren't as good as the squabs. An old pigeon is worth about 25¢ and can be eaten in pigeon pie.)

After you get your flock established you can raise your own breeders. During April, May and June you will perhaps have more squabs than you need

for the table. You can raise some of these and when they are 6 to 8 months old they can be mated. One advantage in raising your own breeders is that they produce better at home where hatched.

But to begin with, you can expect to pay about \$3.00 to \$5.00 per pair of good breeders. Your best plan for getting good stock at a fair price is



Squabs 24 hours old.

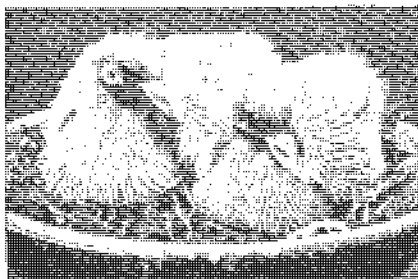

2 weeks old.



3 weeks old.



3½ weeks old—will be ready to eat when fully feathered underwing in another week. (Courtesy U. S. Dept. Agr.)

to deal with the most reliable breeder you can find. The wise procedure is probably to start with two or three or four pairs of breeders, and then to increase your flock as you go along.

Pigeons usually remain with the same mate for life. Together they rear and feed the squabs. The hen pigeon will lay one egg, skip a day, and lay again. If more than two eggs are laid, remove the extra ones, because a pair of breeders can tend no more than two squabs properly at one time. The incubation period of the eggs is 17 days. Both parents build the nest and take turns sitting on the eggs.

The hen often lays another setting of eggs when the squabs are two or three weeks old and leaves the feeding of the first pair of squabs largely to the male. This is the principal reason why double nests are provided for each pair of breeders.

The parent birds feed the squabs on a thick, creamy mixture called pigeon milk, produced in their crops. Care should always be taken not to frighten pigeons, especially while feeding their young, and squabs should not ever be disturbed more than is necessary.

In case a squab dies during the first week or ten days, another single squab may be placed in the nest, provided the two are about the same size. This gives the pigeons without squabs the opportunity to begin producing again sooner than they would otherwise.

If the parent birds become sick or die, the young birds may be fed by hand if they are at least a week old. They should be fed at least 2 and preferably 3 times a day on grain that has been soaked for about 8 hours. Drop into the squab's mouth—feed enough to fill but not stuff crop.

Harvesting

Squabs grow rapidly and are ready to eat about 26 days old or when fully feathered under the wings. Don't delay in eating them when ready because they will soon lose their baby fat and the flesh will begin to get hard.

To kill, hang squabs by the feet on a hook or nail and cut jugular vein in neck. (The professional way is to cut the vein, with a long, slender-bladed knife, inside the mouth just below base of skull). Lock the wings to keep from flapping, twist one behind the other.

Dry - pick the squabs immediately after killing because the feathers are very hard to pull out if the birds get cold. Pick the squabs on a bench or in your lap—do not hang on a wire. Pick clean and remove pin feathers. Skin is very tender, tears and bruises easily.

As soon as picked, cool for an hour or so in ice water, but not more than three hours. Clean as you would a young chicken. Cooking the squabs may sound like a problem but it isn't. All cook books give recipes.

Rabbit—8 to 14 Cents a Pound

ONE of the first projects I wanted when we moved to our place in the country was rabbits. I had read many times that they produced excellent tasting meat at little cost. Carolyn, however, was sort of skeptical of the project because she thought that she she might not be able to eat the rabbits—they looked so cute.

One pay-day when I happened to read an advertisement offering a six compartment, all-metal wire hutch for sale for less than \$20 I couldn't resist this good buy. The hutch eventually came, but Carolyn was still skeptical and, anyway, we were up to our necks getting our barn finished up, learning to milk, running our broiler battery, our bees, goats, and setting the geese. It wasn't hard to put off getting the rabbits for a while.

Then, a friend of mine, Wally Boren noticed I hadn't done anything with my rabbit hutch and he asked if he couldn't use it until I got ready. That was all right with me. He borrowed the hutch, set it up in his garage and began reading up on the subject of rabbits.

Choosing a Breed

Wally picked a variety called the Chinchilla. You can take your pick of several good meat breeds. Wally favored the medium sized breeds—weighing around 8 to 10 pounds grown. You could go in for the Flemish Giants, for instance, that sometimes weigh 20 pounds. They eat a lot more, of course, and their fryers, at 7 to 9 weeks, weigh not too much more than do those of

the medium breeds at the same age. The New Zealand Whites are another popular medium weight breed—their white fur is worth more than the Chinchilla...and there are a number of other good medium weight breeds.

Of course, there are Angoras (with their beautiful, white, long fur) and other "fancy" breeds. But these are not meat rabbits. In ordinary times many of the small rabbit raisers don't bother to save the skins, but they do have some value. Right now, for example, buyers are offering from 30 cents a pound to 90 cents apiece. You can obtain names of buyers from one of the rabbit magazines.

Wally started with a "trio"—a young buck nine months old and two does of the same age. He bred the does shortly after he got them. The following month he had 17 bunnies. Seven is a big enough litter, according to the experts, for one doe to raise. So Wally destroyed four from one litter of 12 and gave the other doe an extra to bring her litter of 6 up to 7. Wally rubbed a little Mentholatum on her nose so she couldn't smell the difference between her own and the young one from the other litter.

At seven weeks all 14 of the young rabbits were alive and frisky. At this age they weighed 44 pounds. The two does were bred again.

8c to 14c A Pound

Wally kept some careful records. Here's what he learned from them. A Chinchilla weighing 3 pounds, live weight will cost you from 25c to 35c or a little more to raise. You'd pay a dollar, at least, in the market for him.

Wally figured out how much time it took him to raise one 3 pound fryer. It took one hour flat. That is, he explained, "I spent 14 hours actual chore time—as a dub beginner—raising 14 meat-meals for the family. I could cut that in half, but I like pattering around them."

Wally had such good luck with the rabbits that, of course, I wanted to see what I could do. Wally, who is a most generous-minded fellow, kept us supplied with rabbit—he kept saying that after all he had to pay "rent" in some form or other for the hutch. Carolyn and I both liked rabbit very much; it tastes something like chicken but has a "firmness" that chicken doesn't have. I guess it was a year before I got my hutch back and got to keeping rabbits myself.

Incidentally, after we did get the rabbits we didn't mind the idea of raising them to eat—I guess after eating some rabbits raised by somebody else it's easier to go into rabbit raising strictly from the standpoint of raising



U. S. Rabbit Exp. Sec.

Here is how to cut up a rabbit. He makes six generous pieces, plus the liver — as good as chicken liver.

them for meat and not let yourself make pets of them. Of course, when you can put rabbits or chicken or anything else in a freezer and leave them there for a few weeks or months you'll find that you think of them as "meat" — not "cute animals."

What To Feed Rabbits

You'll see in the diagram on Page 43 a hayrack indicated for each hutch. This you keep full of hay—the rabbit experts, because the industry is located in California where Alfalfa is easily obtainable, recommend Alfalfa. But a good, leafy clover hay is all right. Timothy isn't as high in protein as clover, but if it's properly cured it's better than a poorly cured clover or Alfalfa. The rabbits can manage the hay better if it is cut up in 3 or 4 inch lengths. (Take a handful, squeeze it into a bundle and saw it off into a box with an ordinary hand saw.) You can also feed vetch, cow peas, and other rich hays. You can give your rabbits dried scraps of bread and crusts; also any kind of vegetable parings and tops they'll eat. You can feed them lawn trimmings and weeds. But don't leave what they fail to eat in the pen. Take it out next day and pretty soon you'll find what they like best and how much to feed. Rabbits relish carrots and other root vegetables. Feed green feeds sparingly at first if your rabbits aren't used to them. Sometimes they over-eat and bloat or get diarrhea.

You also feed them one of the prepared rabbit pellet foods or whole grain—they don't seem to like any grain that's ground up too fine. You can ask the man you buy your rabbits from for directions as to what he's found the best methods of feeding.

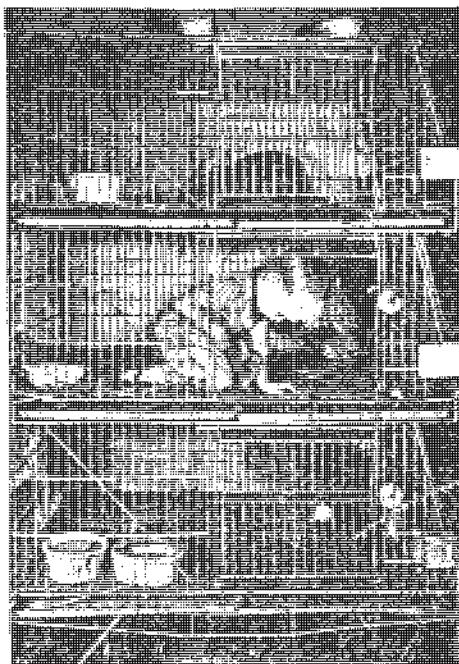

When Jacks, three years old in this picture disappears we look in the rabbit hutch. Country raised, he's independent and fearless.

How Fast Do Rabbits Multiply?

Everybody has a story about how fast rabbits multiply. I remember a friend of mine who had a small family and worried about this when getting his rabbits. In fact, he decided that he'd start with the minimum a single doe and a single buck. He was a salesman and everytime I'd see him I'd ask, "Well, how many rabbits have you now." The first month it was just two. The second month it was two. The third month it was still two. About this time my friend began to worry about his rabbits *not* multiplying. And when, at the end of the fourth month, he still had only two, I began to get a little suspicious. Sure enough, he didn't have a doe and a buck—he had two bucks!

Determining the sex of a rabbit is easy. Get the man you buy your rabbits from to show you.

I find that two does and a buck produce 40 or 50 rabbits a year to eat. At three pounds or more that is all our family needs.

You breed about every 90 days. Gestation only takes 30 to 32 days. The young nurse for five or six weeks, learning to eat as they go along. At six or seven weeks you put the young fryers in another hutch or two and eat them between then and ten or twelve weeks. Or you process the whole tender crop at 8 or 9 weeks and quick-freeze all except the one you want for dinner then.

You can eat them as fryers until they're seven or eight months old—full grown. But by that time they've eaten a great deal of fairly high priced food and therefore aren't so much of a bargain, cost-wise. Better separate the young bucks from the does at 3 months.

You can kill off old rabbits at the end of a couple or even three years and make a stew out of them. The skin from a mature rabbit is worth considerably more than from "fryers."

You can "inbreed" with no harm. Just keep a young doe or two out of a litter and breed her to your same buck when she's about 7 to 9 months' old. You can stagger your breeding times, having one fresh litter coming in every 6 weeks from one doe or the other. But if you adopt this system, you can't exchange the young between the does. Every 3 or 4 years buy or trade for a new buck.

And while we're on the subject of buying, try to get good, healthy and strong animals. You don't care about a "show" rabbit but do get good blood. They may even cost you from \$10 to \$25 a trio; you aren't likely to save money by starting out with \$3 worth of scrubs. However, don't worry about pedigree or perfect markings or blue ribbon winners.

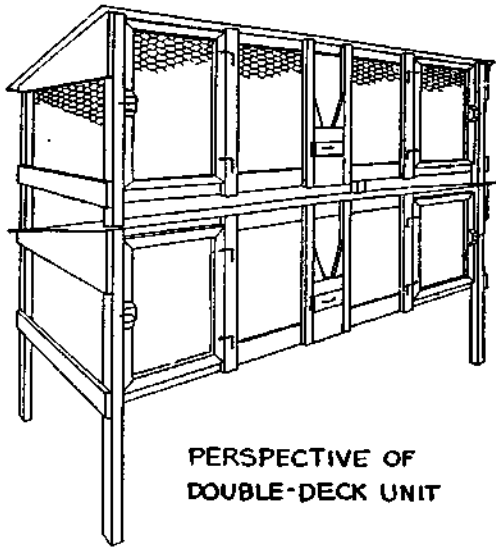

PERSPECTIVE OF
DOUBLE-DECK UNIT

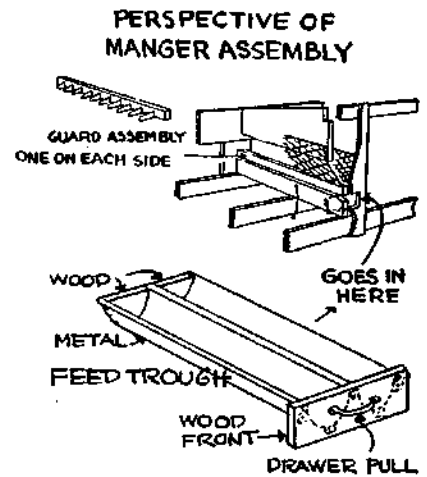

Here is a good wood-and-wire type of hutch.

Building the Hutch

Rabbits are very hardy animals, easy to raise and extremely clean. They can stand a lot of cold weather. They can't stand very much of a *wetting* and *hot weather* gets 'em down. They wear fur coats in *summer* remember. They have to have clean feed trays and clean water. They need a cool, shady summer place with lots of ventilation, *some* sunshine occasionally and a good roof. We keep our metal hutch in the barn. We clean it out once a week, keep plenty of straw on the floor and in the nest box (a nail keg with a strip across it—see illustration) and, in winter we water the rabbits night and morning, taking the water out before it freezes. In summer we keep the water trays always full. They drink a lot.

Hasenpfeffer

Here is a recipe for the famous German way of preparing rabbit. Cut up your rabbit meat and put it into a jar. Cover with vinegar or wine and water, equal parts. Add one sliced onion, salt, peppers, few cloves, bay leaves.

Let this soak in a cool place for two days. Then remove and wipe the meat dry and brown it *thoroughly* in a frying pan, in hot butter, turning it often. Gradually add the sauce or juice you pickled it in, and let simmer about half an hour, until tender. Before serving stir in one cupful of thick sour cream.

There's a lot more you ought to know about raising rabbits before you go ahead. But I've tried to give you an idea of what's involved. There are one or two good books on rabbits that you'll find worth while reading. You ought to have more detailed information about hutch building, about dressing a rabbit, about keeping records, etc. "See Country Bookstore Catalog."

All in all the impression I'd like to leave is that rabbits are one of the first projects any one interested in home food production should investigate.

The space required by my rabbits is only 3 x 10 feet—and rabbits can be started any time of year.

Easterners are behind the times in discovering how delicious rabbit tastes. In California, where rabbit is king, many prefer it to chicken which it resembles.

No other meat is easier, quicker, as inexpensive for the homesteader to produce as rabbit ... and it's easier to dress than chicken.

Two good does and a buck will give a family easily 180 pounds of good-tasting meat per year.

A modern, self-cleaning hutch fitted with the new automatic watering, requires less than 5 minutes attention a day.

Suggested Reading:

Rabbits For Food and Fur, \$3.00.

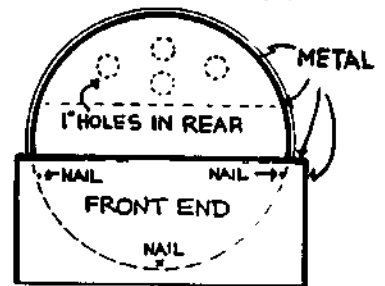

NEST BOX

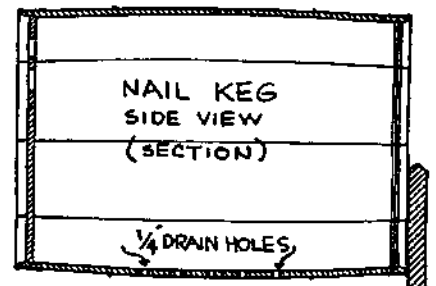

Here's a dandy nest box, made from a nail keg. The doe pulls hair and makes a warm fur-lined nest for the young before their birth. You keep the nest box in the doe's hutch from a couple of days before the young arrive until they are ready to leave the nest.

Ham, Bacon, Pork, Lard

*"You can breed the pigs and buy the corn and get on;
You can raise the corn and buy the pigs and get on;
If you buy the corn and buy the pigs to feed, you haven't got a chance;
But if you breed the pigs and raise the corn you'll make money."*

—Louis Bromfield

EVEN though this pessimistic little poem's about raising pigs commercially, it has a point that the backyard farmer shouldn't forget. The really profitable way to raise your own pork is to raise and fatten your pigs chiefly with surplus garden products, table scraps, home-grown corn.

The first year we started our plan, we raised two pigs. Because we didn't have many surplus vegetables, we bought about \$35 worth of grain per pig. We paid \$12.50 for inoculated 7 week-old pigs in April, had them slaughtered in December when they weighed 285 pounds. The dressed weight (per pig) was 230 pounds. In short, our pork cost 22¢ a pound. Last year it cost around 18¢.

From this experience we learned a few important points: For a family of three or four one pig will give quite a bit of meat. Even a 200 pound pig (live

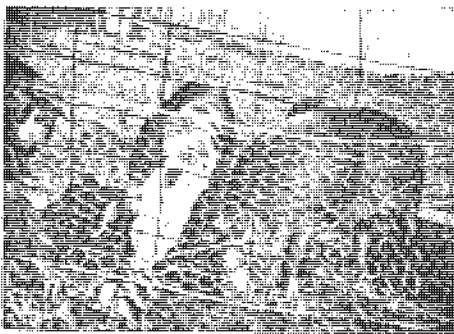

Our ¼ ton of pork! When we bought young pigs the chicken-wire netting was necessary to keep pigs in. Incidentally, have you heard the old farmer's definition of a good fence: "Hog tight at the bottom—goat high—and sturdy enough to hold a bull".

weight) will give about 55 pounds of hams and shoulder, 40 pounds of bacon and loin, plus lard, sausage, pigs feet, etc. Two pigs are sufficient for a family of 6 to 8.

With only three in our family we made a mistake keeping our pigs until they weighed 300 pounds. After pigs go over 225 pounds their ratio of weight gained to food consumed drops.

We found that if you buy a 7 to 10 weeks old pig, innoculated, properly weaned, fed and cared for, you shouldn't have any trouble raising it.

With only 3 in the family, the amount of table scraps and surplus garden vegetables we had was discouragingly small when fed to two pigs. Incidentally, a pig will do well even if it doesn't get much grain. To keep feed bills down, you should plant a patch of corn or supply extra food scraps or garden or orchard produce. In fact, good pasture, fenced into three lots for rotating will supply 10 to 15 percent of the total food for a couple of pigs.

A single pig, unlike a single goat, doesn't get lonely.

From weaning time (6 to 8 weeks) a pig should put on about a pound a day. If fed grain entirely it will eat nearly ½ ton from April to December. But with pasture and surplus produce—vegetables, corn stalks, fruit, skim milk, acorns, and table scraps, even 200 pounds of grain will produce a good sized pig.

The backyard farmer shouldn't try to keep a sow, breed her, and produce young pigs. This requires a lot of time, trouble, experience and feed.

A young pig (or two) should be bought in the Spring—a March or April born pig is best. Such an animal costs at 6 to 8 weeks of age \$5 to \$12. Buy either a young sow pig or a barrow (castrated male). Be sure the pig is inoculated against cholera. This usually costs 50 cents. The young pig should also be wormed before you buy it.

It has often been pointed out that the day you buy your pig is the day you'll make or lose the most money. In short, buy from a good breeder or farmer with clean, disease-free stock. Be careful you don't get a runt. Choose a young pig that's long—a chunky one will make too much lard. The breed is not important—all breeds have been developed to produce meat.

Easiest Way to Feed

The simplest way to feed a pig is to provide grain, (corn-on-cob, wheat or barley), a protein supplement (alfalfa leaf left from the hay fed goats for example), and a mineral mixture or a complete hog ration in separate compartments of an automatic hog feeder. This feeder plus an automatic waterer cuts chore time to the bone. Automatic feeders, which let animals eat as much and whenever they like, work best of all with pigs. No matter how much food you put before a pig it will eat only until full—never overeat.

Feeders and waterers are sold by Sears and Montgomery Ward.

Feed garbage, surplus garden produce etc. in a trough. This you can easily make, especially if you buy iron trough



Six-week old pigs, already weaned, can be bought by mail. By feeding surplus garden vegetables, table scraps, and some grain they'll grow to 175—200 pounds in 20 weeks.

ends. Save garbage in separate can and keep free from paper, soap, glass, dish-water, etc. Don't feed garbage older than 3 days.

Housing

Housing for a pig or two from April to December can be of the simplest. The standard portable A-type hog house is satisfactory and can be bought knock-down for around \$35. However, the backyard farmer probably hasn't enough land to require a portable house. A simple shed structure, 8 x 6 feet, 5 feet high in front, 3 in the rear, is most satisfactory. The front is open and the sun, which is the best disinfectant of all, can penetrate to the rear of the house. The roof is tar-paper, the rest of the shed is made of wood, including the floor which is set well off

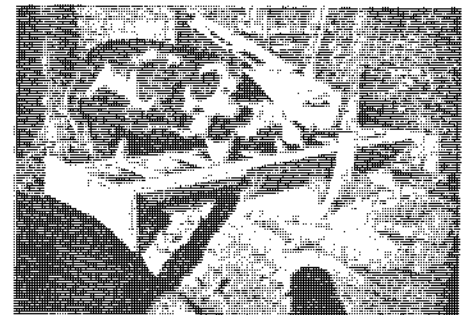

Simple hog feed trough for garbage. Note braces which give each pig a chance to eat. Wide end boards keep pigs from upsetting trough.

Building A Sanitary Pig Pen

the ground to keep the pigs dry. In the fall we keep the floor bedded with straw.

New Method of Raising Pigs

Of special interest to the backyard farmer are the experiments sponsored by the Portland Cement Association, Chicago, Illinois. These experiments have to do with the confinement system of raising pigs on concrete. Like the battery-broiler system, instead of permitting animals to range, all food is brought to the pigs. Less than 15 square feet of pen is allowed per pig, obviously a system which requires so little land is of interest to the backyard farmer.

Inasmuch as pigs spend their whole life on concrete this makes possible maximum sanitation. Concrete floors are swept or flushed with a garden hose daily. A pit provides a sanitary, easy method of holding manure until it can be spread over the garden.

Confinement on cement eliminates "rooting" and racing about. This results in unbelievably fast growth. John Hendricks, who is given credit for developing this method of growing hogs, reports average growth of a hog to be:

Age	Weight
67 days	82 lbs.
132 days	195 lbs.
260 days	325 lbs.

The photos at right are our adaptation of the commercial hog raisers' confinement-on-concrete system which we have scaled down to a size suitable for 1 to 4 pigs. The confinement pen has worked out fine.

Watering is done automatically by attaching a Montgomery Ward double-drinking cup to the bottom of a barrel. This barrel can be filled once or twice weekly with a garden hose.

Slaughtering

There is no need for the novice to do his own slaughtering. Your feed dealer will put you in touch with a man who will dress your pigs, smoke the hams, bacon, make sausage, hog's head cheese, liverwurst.

Or you can have your pigs slaughtered and dressed and do your own curing and smoking.

And boy—wait until you taste your own bacon and ham smoked country style—and that wonderful, honest-to-goodness all pork sausage—and fresh roast pork! If yours is as good as ours turned out you'll say you've never tasted any so delicious ever before.

With a proper set-up, fattening a pig will return more for the time spent than most any other project.

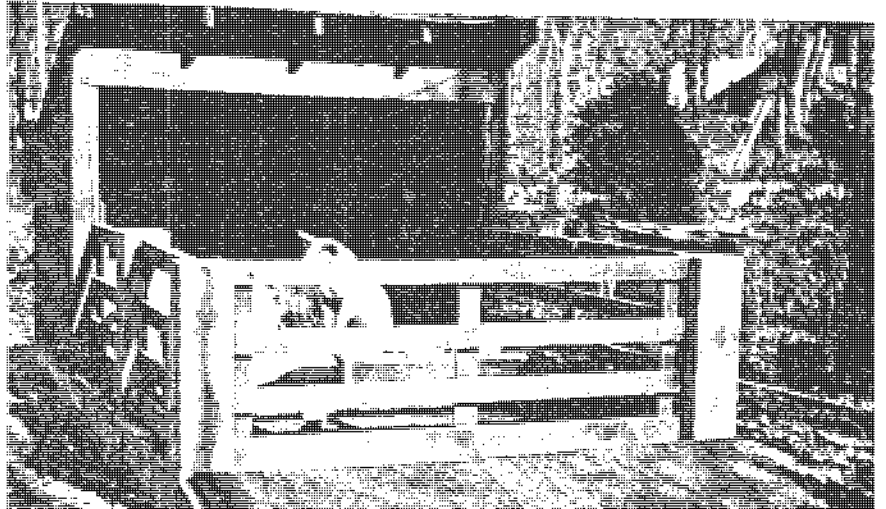
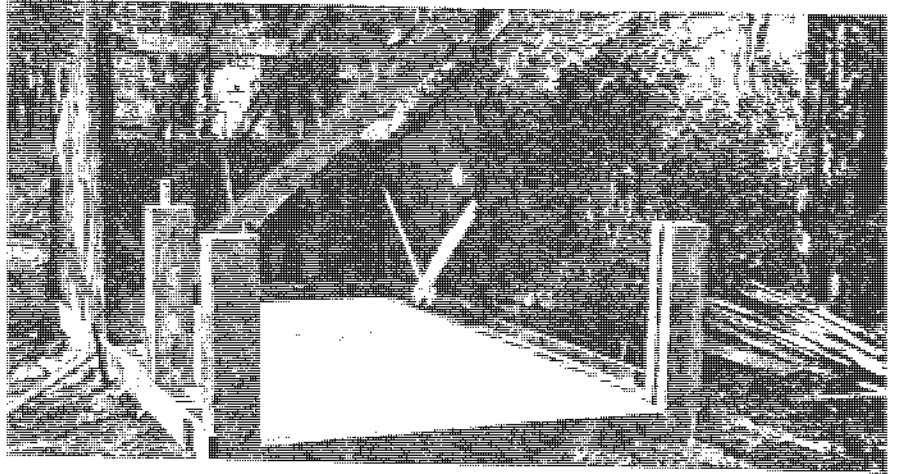
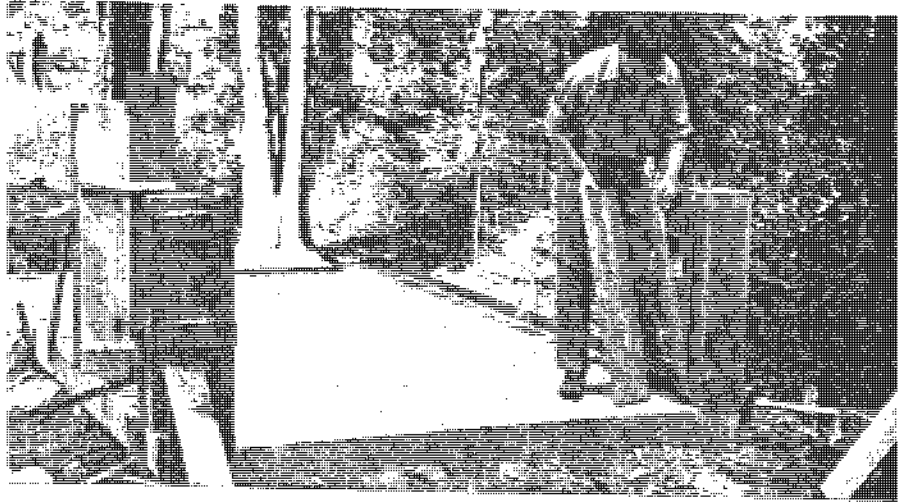
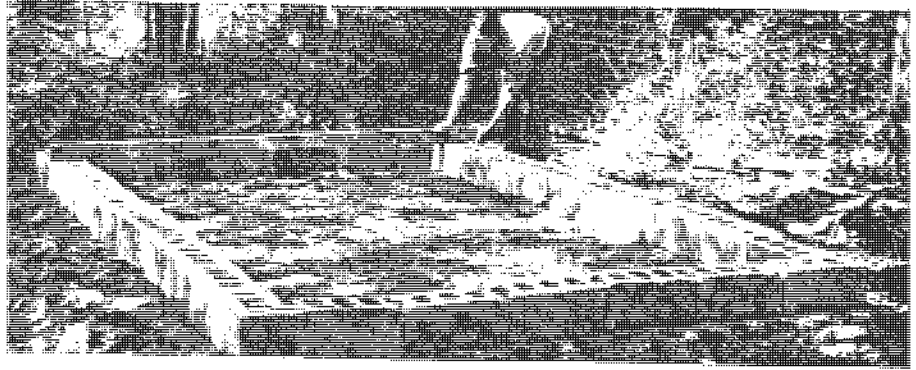

The Miniature Dairy

"A small, well balanced collection of livestock can contribute forty to forty-five per cent of the average family food budget. Contrast this to the fifteen to twenty per cent that the home garden and orchard can supply. . ." *HOW TO LIVE IN THE COUNTRY WITHOUT FARMING.*

SURPRISING as it seems there are in this country about 5 million families keeping a family cow or goats. Yet I don't believe there is \$100 a year spent by anybody promoting the idea of keeping a cow or goats for the family's own milk supply.

Obviously, if over 5 million families in this country are producing their own milk (this figure does not include any commercial dairy with more than three cows) it must be a sound practice.

As a matter of fact producing your own milk is actually so economically sound, so basic in good times or bad, so widespread a practice across the width and breath of our country, and so simple to do that until recently there has been no book available to tell a city man moving to the country the few things he ought to know to supply his family with milk and dairy produce successfully.

There are in the United States a total of over 27 million milking cows and goats—approximately one per family. Your family, if "well-nourished", is already using the complete milk supply of at least one cow. One of the first things a family should decide when it moves to the country is whether it is going to take over the care of a cow or goats or continue to go on paying somebody else to do this.

Cow and goat milk differ in many minor respects but in only this one important aspect: goat milk is naturally homogenized—the cream does not rise. But the cream can be extracted with a separator. A minor difference is in color; goat milk is whiter than cow milk. Butter and cheese can be produced from goat milk just as from cow milk.

Whether you choose to keep a cow or a couple of goats should be decided on the basis of how much milk your family can use, how much time your family can make available for milking, feeding, caring for your dairy—that includes butter, cheese, and ice-cream making if you keep a cow—and how much and what type of land you have available.

The following two chapters on goats and a family cow will, we hope, help you decide whether or not you'd like to produce the dairy products your own family needs.

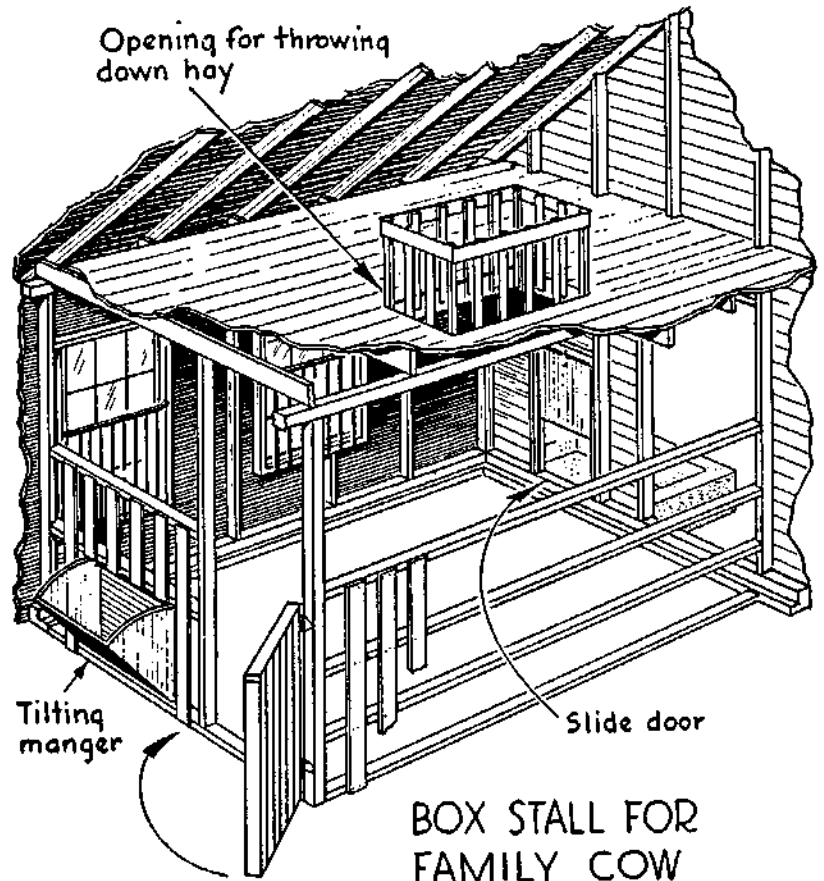

BOX STALL FOR FAMILY COW

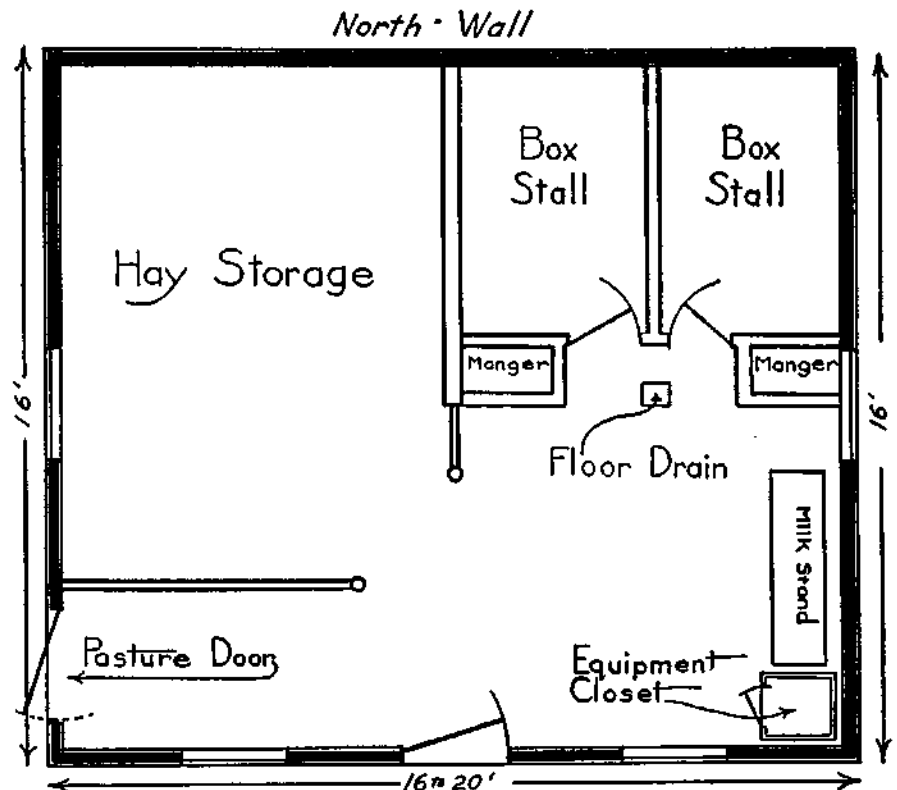

Two-Goat Barn

The Modern Dairy Goat

Of all our farm animals the least appreciated by city friends who visit us are our goats. "Goats! You don't actually keep goats, My goodness, why?"

"Have you ever tasted goat milk?" we ask.

"No—and I don't want to!" is the answer more often than not. But, possibly at lunch time, we serve them two half-filled glasses of milk. "One is goat milk—one is cow milk . . . Just for fun, tell us which is which," we say.

Almost invariably our city guests can't tell them apart. Sometimes, if they've read that goat milk is whiter they can guess. But they always are amazed that our goat milk has no "strong" taste.

In the face of the public's misunderstanding of the dairy goat it takes courage to decide to keep them. Here's how we happened to do so.

One day when we sat down and figured what our milk, butter and cheese cost we found we were spending about 25% of our food budget in the dairy department. This was in line with what nutritional experts recommended. It was obvious then that production of our own milk ranked with raising our own fruits and vegetables from an economic as well as a nutritional standpoint. We figured on a garden and fruit trees plus a cow or goat to supply milk, cream, butter and cheese and we'd have one-half of all our family's food requirements.

Of course, either a cow or a goat can be stall fed and be given only a small exercise yard. But, ideally, a cow requires 1 to 2 acres of good pasture, an hour a day of care, and supplies 10 to 20 quarts of milk a day. Ideally two

goats require less than an acre of pasture (brush, fern and shrubbery are their favorites), 30 minutes a day, and provide 3 to 7 quarts of milk daily, the year round. A goat eats only 1/16 of what a cow needs. Goats are freer from disease so that both animal and milk are safer.

For the small place everything is in favor of the goat except a goat's reputation. Believe it or not, the modern dairy goat is almost the exact opposite of what the American public believes she is. As we have already said, the prejudice against goat milk is unfounded as far as our experience is concerned

What the Goat Gives You

Let's make a list of all the products the dairy goat can furnish you:

1. *Milk*, not just ordinary stuff, but a rich, full-bodied milk. Goat's milk is naturally homogenized, small fat globules make it easier to digest. Frequently, it's used for invalids and children allergic to cow's milk. It's fine in coffee and makes a delicious, smooth ice cream. Also, goats are easier to milk.

2. *Cream*. Goat's milk has lots of cream, but it rises very slowly. Consequently, it is best to have a small cream separator. The cream may be whipped or used in any of your customary ways.

3. *Butter*, unusually smooth in texture, pure white, easily colored just as cow butter is colored.

4. *Cheese*. You have probably already enjoyed goat's cheese as millions of pounds are imported from Europe besides the domestic supply.

5. *Meat*, or chevon, as goat's meat is correctly named. Young buck kids 4 or 5 months old provide 35-45 pounds of dressed meat. Chevon makes many succulent dishes, and in the South particularly is considered a great delicacy.

Most likely you have eaten chevon without knowing it—thousands of pounds are sold each year as lamb. We think it is tastier than lamb, but Mrs. R. found it should be cooked a little longer.

6. *Furs and Skins*. Furs from newborn kids are beautiful and may be made into coats, jackets. A tannery or furrier can prepare the hides for you.

7. *Fertilizer*. Goat manure is one of the richest, most valuable manures—excellent enough to be in demand by greenhouses and fruit growers. You, however, will want to use it liberally yourself, for it will help you "have more" vegetables, fruits and flowers. Of all manures, it's the most inoffensive. You can see why from children's name for it, "nanny goat berries."

Considering all the products, the modern dairy goat is a valuable asset. Because of a goat's size a small barn is satisfactory. Also when it comes time each year to breed a goat you can hoist her into your car easily and get her to a buck. Goats are so easily handled that women frequently run large dairies.

Perhaps we seem unduly enamoured of our goats so we include this letter sent to the "Dairy Goat Journal," a magazine, (October, 1943). We quote: *I purchased a grade doe for \$15 which is giving me 3½ quarts a day of excellent quality milk. Two quarts of cow milk had been costing me \$8 per month. A grade cow would cost me \$75 to \$125 so I am somewhat amazed when people speak of milk being expensive and hard to obtain. I had a laugh when the editor of a farm magazine said that something should be done about it when an old stinky goat beat an honest dairyman out of \$7 or \$8 a month.*

My goat is giving \$13.65 worth of milk a month and her feed costs about 10 cents a day. She doesn't stink either!

This checks with our own experience—except our goats cost more than \$15.

Cost of a Goat

A good goat now costs considerable since their value is being recognized rapidly. Our first goat, a grade Nubian doe, with her two kids cost us \$40. Our second goat (a young doe) was given to us by a friend who has a 20-goat dairy. Our third which was shipped to us 2,000 miles from one of America's best goat breeders cost us \$49, including shipping.

We now have two milking does. When they first freshen they produce



Milking a goat is far easier than milking a cow. Notice 4-quart milk pail partially covered to help keep milk clean.

a total of eight quarts a day. Eight or nine months later, before we dry them up, they are producing 1½ to 2 quarts a day. A goat generally gives more milk on her second and subsequent freshenings than on her first. Five to seven quarts of milk are easily used by a family of three. It takes about 8 or 9 quarts to make a quart of cream or a pound of butter.

Goats are sensitive to changes of ownership and home. It takes them several months to adjust themselves completely. In fact, they become so closely attached to individuals that they give more milk to the person who stands by them at kidding time and handles their new-born young.

We believe the perfect solution to the family milk supply is two milk goats. Two grade goats are better than one purebred for several reasons. You can arrange to have milk all year round by breeding one goat in September, the other in January. Two "three-quart" grade does cost less than one fancy six-quart doe as six-quart does are rare and cost \$100 to \$200. Goats also love companionship and will give better results when they have company instead of being kept in solitary confinement.

There are three ways of starting your miniature goat dairy economically:

1. You may buy four month old kids for about \$15 or \$20 and raise them to breeding age (about 15 to 18 months). They'll cost \$10-\$15 a year to keep.

2. You may buy a purebred goat past her prime, breed her to give you good young stock. Goats reach their peak at about 6 years, but live to be about 12 years old.

3. Or you may buy a good common doe, breed her to a purebred buck and improve your stock while getting milk at the same time.

We are working on the third plan ourselves and think it's the best. Kids from a good doe pay for her upkeep. The only drawback to raising your new kids (the doelings for future milk stock and bucks for slaughter) is their need for part of your milk supply. A kid should have a quart of milk daily for at least 2 months but we find we can substitute skim milk we have left after separating the cream, or substitute cheaper evaporated or powdered cow's milk after kids are a few weeks old.

Goat Breeds

If you decide to buy a dairy goat you will find there are three popular breeds—Nubian, Saanen and Toggenburg. Keep away from the ordinary, short-haired American goat, commonly known as the old "alley goat." Goat breeders as a whole will not recommend one breed above another.

We chose the Nubian because it gives the richest milk rather than large quantity and because of the popularity of the breed in our section (an important consideration when breeding

time comes). It is not profitable for the small goat owner to keep a buck—a registered purebred buck is expensive, must be housed separately from the does as he is responsible for the unpleasant odor. Nubians range from cream to black in color, have long drooping ears and distinctive Roman shaped noses.

The Saanens are white or light cream and are the heaviest milk producers. The two goat dairies we know best have both Saanen and Nubian goats—thus combining the highest in quality with quantity.

Toggenburgs are brown with two white stripes down the face and white hocks. Toggenburgs are a popular breed. French Alpines and Rock Alpines are two other breeds relatively new in the United States.



Wilhelmina at 1 month.



Wilhelmina at 22 months.

Guides to Buying

1. Visit several goat dairies. To locate dairies subscribe to one of the four dairy goat magazines, (\$1 per year) and look at ads. Or contact your County Agricultural Agent.

2. See the goat that interests you milked. Ask for her milk record if the dairy keeps records. Milk is measured in pounds. One pint equals one pound. A good goat gives 3 to 6 pounds a day.

3. Look for a goat with depth of body

and well-sprung ribs—points which indicate good food capacity.

The udder should be large and even, carried well under the body and with good-sized teats for easy milking.

5. Get a hornless doe or one disbudded. Horns are dangerous to other goats, children and the milker.

6. If the goat is registered get her papers at the time you buy—proof of registered stock means the doe's value and her kids will be higher if you wish to sell.

Housing

A home for your dairy goats may be as simple or expensive as you wish as long as it keeps goats, feed and living quarters clean and dry. Whatever housing you do provide, plan the arrangements well. Place your pens, stalls and feed so that you take as few steps as necessary. Each minute saved on twice-a-day chores means 12 hours less work a year.

If you are just starting the "Have-More" Plan and cannot afford to build a miniature barn you may use any small, draft-free building you have or can buy secondhand. A shed 6' x 10' can accommodate two does. At kidding time, divide the pen into two smaller pens by use of a hurdle. A wire floor of ¾" heavy gauge mesh, held off the pen floor by a lumber frame keeps bedding dry and goats clean. A feed rack of wood slats will keep goats from wasting hay. (The grain ration should be fed in heavy, hard to tip-over, individual pans which can be bought for about 50c each.)

If you can build or develop part of your barn especially for the goats, you will find a miniature dairy attractive and easy to keep clean. We built our small barn to house laying chickens and our broiler battery in one part, goats, rabbits, sheep, and pigeons in the other. The floor is of cement which is easy to wash, especially with its small dairy gutter, running behind goat stalls. The 18" wide gutter is on a slight slope toward the wall with its own small opening to the outside. Thus dirt, manure and other trash may be swept into the gutter and outside into an iron wheelbarrow.

Our goat stalls are built of wood, on a wooden platform 8 inches off the floor. Each stall is 24" wide and 35" long and divided from the next by a partition 32" high. In front of all the stalls runs a long feed manger. Stalls are separated from the feed rack by slats or solid walling with keyhole opening for goats' heads—this keeps them from wasting hay. A feature we developed to keep a milking goat clean is a removable individual stall floor, the front solid, the rear slatted. Manure falls through the slats into the gutter and also doesn't get tramped down so it's hard to remove. Each stall's floor can be lifted out, cleaned easily and dried in the sun.

The goat barn should open directly to the pasture enclosed by a sturdy wire fence 4' high—goats are agile jumpers. Goats may be tethered on chains or ropes with swivels at both ends to prevent tangling—but tethering takes too much time.

Feed and Health

It costs about 10¢ a day to feed a producing doe when you buy all the feed. Goats relish stale bread and other kitchen scraps providing these are clean and free from mold. Contrary to popular opinion, we found goats meti-



Two pens for kids or maternity ward. A ¼" wire mesh floor tacked to 1" x 2" wooden frame and laid over cement floor keeps bedding in kid pens fresh longer.

culous in their food habits—they won't touch food dropped on the floor or contaminated in any way. And they dote on variety—my wife says they take after me (or vice versa).

During the winter a milking doe should have about 2 lbs. of alfalfa or clover hay (750 pounds yearly which you can raise on ¼ of an acre), 1½ lbs., when possible, of corn 'silage or roots (turnips, carrots, etc.) and 1 to 2 lbs. of grain ration. When on pasture, we feed less grain, only a little hay, no 'silage. The mixing of grains is too complicated for us—it's best to buy a prepared ration sold by a reputable hay and feed dealer. Clean warm water should be supplied at least in the morning and night and goats encouraged to drink (a few drops of molasses in the water makes it appealing.) Salt bricks should be accessible at all times.

Goats are naturally healthy, hardy animals and if they are well cared for you should have no trouble. They rarely get tuberculosis (as cows do) or Bang's disease, one cause of undulant fever in humans. We are following the rule required of dairies—having a veterinarian test the goats twice a year.

As a final precaution, you can pasteurize your milk by heating it to 142° F and holding it at this temperature or slightly higher for 30 minutes—or raise to 160° F for 15 seconds. In either case milk should be cooled rapidly by putting container in ice water. Also, we suggest you have a vet the first time

your goat kids—just for your peace of mind, as goats seldom have any trouble giving birth. You can expect 2 kids at the second kidding and you may get 3.

How to Milk

"How did you learn to milk?" is one of the most frequent questions our city friends ask. We truthfully answer, "by reading how." So can you. Here's how:

Sit with your right side next to the doe's right side, your shoulder close to her shoulder. Hold the teats, thumbs outside fingers. Close your grasp, beginning at the top (thumb and index finger) and successively close the other fingers, thus forcing the milk down the teat and out. Milk firmly but gently until milk stops flowing. Then strip the teats by running the thumb and first finger from the top of each teat to the bottom until the last drop is out. Gently nudging the bag encourages the milk flow. You will be slow and awkward at first as you will have to think about each step but it won't be long until you'll be doing it so casually you'll be surprised at people asking you where you learned.

We warn you that the first few milkings may seem like desperate events in your life—we laugh and laugh now when we look back at our struggles. Don't try to learn with just one hand. Use both hands from the beginning and keep a firm hold even if the doe tries to move around. She will test you out a time or two but you can keep her right front leg in place with your right shoulder and her right rear foot in place with your left wrist. Once you show her you won't let her go she will be quite patient with your efforts.

You will want a small milk stand which you can easily build yourself. It is simply a small stand about 1½' off the floor—40" long and 22" wide. At the front end you place posts 55" high and slats 4½" apart with one slat movable so that the goat's head can go through before you straighten the slat up to hold her in place. A rail on the side opposite the milker keeps the goat from moving too freely. See picture of our homemade milking stand.

When it comes to handling your milk I think you'd better do what my wife tries to do—follow dairy rules as well as you can. She insists on using a disinfectant (planned for milking equipment) on the milk pail, milk jars (we use canning jars because of their wide mouths) and in water used to wash the udder. The teats and the milker's hands must be dried thoroughly before milking, the first stream of milk from each teat thrown away. We strain the milk through filters, discarded after use, then set the jars of milk in ice water as rapid cooling creates a healthier, better-tasting milk.

Pasteurization with a tested goat is up to you. Raw milk certainly tastes

better and some experts say it has more food value.

When it comes to feeding milk to your kids, by all means pan feed them. If you let them nurse, you lose control of your milk supply. Bottle feeding is a messy affair. After the kids are born place them in a box or basket so they cannot get out to their mother. After you pan feed them a few days they will not try to nurse and can run with the mother. Dip your finger in the milk, let them lick it and get them to follow your finger into the pan. After a time or two your only trouble will be keeping the milk from being spilled as the kids dash for it. Feeding the kids is fun even though commonly called a "chore."

Time Savers

1. Try to have running water in the barn or as close as possible.
2. Store feed close to feed racks to save time and mess.
3. If you build, plan a dairy gutter sloping to an outside opening of its own.
4. In the pens build racks of slats or heavy wire mesh to stand an inch or so off the floor to keep bedding cleaner and drier.
5. In the stalls place removable wooden racks for ease in cleaning.
6. Fence in a pasture if possible—the initial work is easier than continuous tethering.



Even a Crosley is big enough to carry your goat. Mimi is on her way to visit Ptolemy, a prize Nubian buck.

A Family Cow

KEEPING a cow, like marriage, is a confining and responsible relationship not to be entered into lightly. Flirtation, study, an engagement, even trial marriage are advocated, for dairymen, like fond parents, are unduly enamoured of their heifers.

Like marriage, too, keeping a family cow is a great institution. In fact, American agricultural writers often refer to the cow as "The Foster Mother of the Human Race." This is undoubtedly a little over-enthusiastic for in many parts of Europe 80% of the milk is goat milk.

The first time you squat on your brand-new, insignificant three-legged milk stool and your new cow towers above you, a thousand pounds of the Lord-Only-Knows-What combination of unknown evil, wickedness, and danger and you see her big, horned head turn at the fumbling indignities you are attempting under her hind-quarters, you're bound to experience a sinking in the pit of your stomach and an intense feeling that a cow is too gigantic an undertaking for you. Anyway, if this feeling doesn't come over you at the beginning of your first milking, then it will unquestionably at the end when it dawns on you that all that milk, that big pail of milk, is going to be duplicated night and morning every day for the next ten months.

Actually, a cow isn't large or dangerous. In fact, compared with your car she's less than one-third the weight—and when you realize that the auto is responsible for some 30,000 deaths a year, not including some hundreds of thousand injuries, then you'll have to agree that a cow isn't dangerous. A family cow, particularly a Jersey, becomes the gentlest of pets.

As for the superabundance of milk—it's none too much when translated into terms of milk for the family, cream, skim-milk for chickens, pigs, and a calf, and particularly if you want to make ice cream, butter and cheese. If yours is an average, decently fed family, you are already using one cow's entire milk supply. There are in the United States, according to the census, something like 26,000,000 producing cows. That is at least one cow for each American family enjoying a sufficient amount of milk and milk products. In short, the point is: Are you going to keep a cow or go on paying somebody else to do it for you?

I know it's hard to believe that a family accustomed to buying one or a couple of quarts of milk a day can easily use 10 or 12 quarts. It was that way with us when we started getting 6 or 7 quarts of milk from our two milking goats. Honest, though, if you're going to have a productive homestead, you'll find it simple to use the milk effectively without setting up a milk

route. For example, you'll be able to have plenty of real, heavy cream—for coffee, for cereal, for berries, for ice-cream, for cooking, for butter-making. Remember, it takes 10 quarts of milk to produce one quart of cream. And a quart of cream makes only a pound of butter . . . or a quart-and-a-half of ice cream . . . and just ask your wife how much butter and cream she'd like to

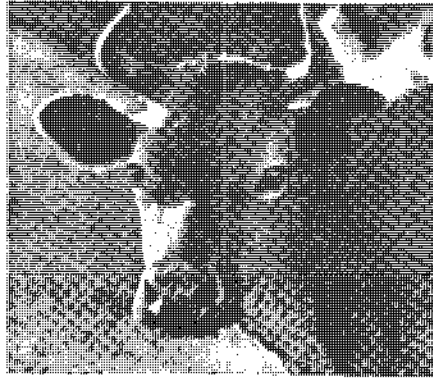

Isn't she lovely . . .

use in cooking if she could use all she wanted!

For every quart of cream you produce, you'll have about 9 quarts of skim milk. This is the finest food you can feed pigs, chickens and other poultry. If you still think you'll have too much milk, there's the annual calf that your cow will produce. If you raise the calf to veal size, about 180 pounds, the calf will consume daily a pint of milk for each ten pounds it weighs.

Another thing to bear in mind is that although a cow isn't by any means something you can turn on or shut off like a faucet, you can to a certain extent control the amount of milk she produces; she can be just as efficient producing less milk, strange as this might seem. The efficiency of a cow is simply a comparison between what she costs to keep and how much she produces. During the course of a year a commercial dairy cow will consume about 2 tons of hay, require one to two acres of good pasture, and eat 2,000 pounds of grain or other concentrates. A homesteader interested in self-sufficiency usually has the pasture land and can make the hay, but has to buy the grain. A cow, however, doesn't need grain. Professor Carl Bender, of Rutgers, explained to me how a cow could be kept in perfectly good health on a diet of good hay, good pasture and in winter succulents such as beet pulp or the sugar beets themselves. Obviously, a cow that isn't fed grain won't give as much milk—probably it'll give only 70% of what it would give when fed grain to supplement pasture and hay. But to the homesteader considering what to do with a cow's full production of milk, a cow that will give 7

quarts of milk a day instead of 10 quarts might be preferable, particularly when she can also eliminate a grain bill.

Less than an eighth of an acre will provide the 25 pounds of sugar beets a day necessary to feed your cow during the months when pasture is not good. Beets or mangels can be stored in a root-cellar. They are simply washed and sliced before feeding.

The more the countryman looks into the business of keeping a cow, the more practical it seems. Your first cost, buying the cow and fixing up to keep her, is figuratively speaking your last cost. For if you have some suitable pasture and raise your own hay and succulents, then the only other regular cash outlay should be about \$15 dollars a year breeding and veterinary fees. On the credit side you should get at least 5,000 pounds of milk (about 2,500 quarts), a calf which will give you 90 pounds of veal, and 12 tons of good manure. If you've had to buy manure, then you'll appreciate how valuable 12 tons is.

All this sounds pretty rosy. But there is the other side, too. Although neither an elaborate nor expensive building is required, you'll need a barn of some sort. It should be draft-free, have a decent sized window to let in plenty of sun and fresh air.

Also, you'll need a place to store two tons of hay. Hay can be stacked outside the barn and covered with canvas, but this should be considered only an emergency measure. Of course, if you're going to buy your hay, you can buy it by the bale and then you'll need very little space. Eventually, you'll want to make your own hay, and you'll need storage space of at least 10 x 10 x 10, or the equivalent, to store two tons of loose hay. Incidentally, the rule for finding the number of tons in a mow is: Multiply length x width x height (in feet) and divide by 400 to 500 depending on the length of time the hay has been in—there's also a slight variation depending on the type hay.

Another thing you'll want is between one and two acres of good pasture. The pasture should be fenced into three small pastures to let you rotate the cow. Although many people stake out their cows, this is needless trouble compared to fencing a pasture so the cow can simply be turned loose into the pasture from the barn.

You'll need some equipment: milk pail, water pail, milking stool, square manure shovel, 6 prong manure fork with tines not over 1 3/4" apart—wider tines allow droppings to fall through—cow halter and rope, curry comb and brush, barn thermometer, udder wash cloths, milk scale, milk production record chart, insect spray gun, hay forks—one in loft, one in barn level—and a metal wheelbarrow. Total cost—about \$30.

You should also run water to the barn. And you'll want to work out a manure pit or compost system for easy handling of manure.

Then there are certain items needed to handle the milk efficiently. Milk setting cans . . . milk strainer and filter discs . . . an inexpensive butter churn and, if you can afford it, a small separator.

That'll be most everything—except for the cow.

What Breed To Select?

There is no best breed. Oftentimes a Jersey is the first choice for a family cow because its milk is richer and it is a smaller cow. A few people find a Jersey's milk too rich. (See table.)

One thing to determine before selecting a particular breed is how you're going to get your cow bred each year. Find out from your County Agent about the availability of artificial insemination. If this isn't possible, then you'll be better off by getting a cow of the same breed as the most convenient bull, if you intend to raise any heifers.

Buying a Cow

When you set out to buy a cow the most important thing to do is to be sure that you buy a healthy one. Have her tested for both tuberculosis and Bang's disease, and see that her udder is free of mastitis. Your veterinarian will check up on these.

If the seller hasn't kept accurate milking records, and only about one in ten dairymen do, then be present at two—or better three—successive milkings. Or ask for a written guarantee of the cow's milk production.

Buy from a reliable man. Remember, in spite of all the to-do about judging cattle at the shows by external appearance nobody can honestly tell how good a milker a cow is by looking at her. If that were possible there wouldn't be the thousands of dollars spent on record-keeping by the big milk producers.

A young cow is worth more than an old cow. Although, if you get an especially good buy in an old cow with an outstanding milk record, you might consider buying her and replacing her as soon as possible with her heifer. Naturally, this is something of a gamble. She may have a couple of bull calves before a female—and when she

does have a heifer, it'll be almost 2½ years before the heifer will be milking. A cow reaches its prime at about 7 years of age; if healthy and well-cared for she will produce well to 10 or more years.

How Much Time Does a Cow Take?

For 10 months of the year the family cow must be milked twice a day. Milking should be regular, but can be done at any two periods 12 hours apart. There is absolutely no reason to milk a cow at such an ungodly hour as 5 or 6 A. M.—that is, not a family cow. A cow will do as well milked at noon and again at midnight. Or a cow can be milked on a 10-14 hour schedule—say 8 in the morning and 6 in the evening. But milk her regularly—at least within ½ an hour of her scheduled time.

Feeding will take about 10 minutes and needs to be done morning and night.

Pasturing shouldn't take but a minute or two if you have wired runs from barn down to pastures. (See "Layout for a Productive Homestead.")

Caring for milk—straining, cooling, washing utensils 5 to 10 minutes.

Separating, every other day, about 10-15 minutes to run through 25 quarts or so; about 8-10 minutes to clean separator.

Butter making from cream takes about 30 minutes.

A small cheese takes about 3 hours to make, spread over about 6 weeks time.

In addition, a certain amount of time will be needed to make a couple of tons of hay a year and produce the sugar beets or other ensilage.

This sounds like quite an undertaking when you add it all up. But compare keeping a cow with a family garden. The dairy products consumed will exceed in retail value the total possible saving from the operation of a well-run vegetable garden including canned and stored vegetables.

Milking will take about 20 minutes—morning and night. Cleaning barn and removal of manure about 15 minutes. Grooming cow—about 5 minutes.

Watering should be made automatic. If by hand it will take 5 to 10 minutes.

Raising a calf calls for teaching the calf to drink and then pan feeding three times a day for 4 to 6 weeks.

Specific Costs and Returns

Too often the benefits of productive country living have been interpreted solely in economic terms. How much more valuable is fresh milk with a 5% fat content as compared with the two or three day old store milk of only about 3% butter fat? To some people milk is milk—but to others fresh, rich milk and heavy cream from a Jersey cow is worth twice what ordinary milk costs.

Anyway, here are two sets of returns on keeping a cow. Neither take into account that fresh milk is usually preferable.

The first figures are from a state bulletin and are averages:

"Actual costs, on the average, for first year if pasture, housing, and bedding are available without monetary expenses are shown in the paragraph that follows:

Cow purchase price \$100 to \$200 (average usefulness of young cow five years) . . .	\$150
10 pounds grain (mixed ration) daily multiplied by 200 (days) equals 2000 pounds @ \$30 to \$50 per ton	40
15 to 20 pounds hay (alfalfa, clover, or mixed clover and timothy) multiplied by 200 (days) equals 2 tons @ \$20.540	60
(Amount depends on size of cow and her appetite. Plenty of hay is absolutely essential.)	
Breeding and Veterinary fees	15

\$265

Returns from a good cow per year are: 3,000 to 5,000 quarts of milk @ 10¢ equal to \$300 to \$500."

Now for some specific figures from the book, *The Family Cow*.

"Jeanne is an ordinary crossbred Jersey-Guernsey purchased for \$85. Her record of 1943 may be of interest even if the costs and prices may not apply elsewhere or at other times. She freshened in May and was milked for 318 days. She produced 8337 pounds of milk, ranging from a peak of 42 lbs. to a minimum of 12 lbs. This amounted to 3877 quarts of milk, an average of 12.2 qts. per day. Butterfat ranged up to 5.35% so she probably produced around 420 pounds of fat. This is equivalent to 462 pounds of 90% butter or an average of 1.45 lbs. of butter a day if all the milk had been thus used.

"Dairy products were consumed and sold as follows:

	Consumed	Saved	Sold	Cash Income
Milk	1200 qts. @ 15¢	\$180.00	250 qts.	\$35.46
Cream	80 pts. @ 35	31.50	70 pts.	27.26
Butter	90 lbs. @ 50	45.00	135 lbs.	67.31
Cheese	50 lbs. @ 12	6.25	32 lbs.	4.00
Skim	300 gal. @ 15	45.00	236 gal.	39.42
Buttermilk	70 qts. @ 9	6.30	30 qts.	2.70
		\$314.05		\$176.15

There are several bookkeeping approaches to these figures but they all show one thing clearly—that the family cow is a pretty good investment!

Cows Have Character

	Ayrshire	Brown Swiss	Guernsey	Holstein	Jersey
Average size at maturity (pounds)	1200	1350	1100	1300	1000
Color	Red and White	Dark Brown	Yellow	Black and White	Fawn
Butter test (per cent)	4	4	5	3.45	5.3
Disposition	Nervous	Docile	Active	Docile	Nervous
Maturity (months)	28	34	27	29	25
Adaptability for beef	High	High	Low	High	Low

From "A Practical Guide to Successful Farming."

A Few Sheep For The Small Place



CITY people who take up country living are generally amazed at the bounty of the land and are always giving something to friends. I guess that's why Carolyn's aunt, who'd recently bought a farm in Alabama, sent us one of her home-grown lambs. And that's how we learned a little about sheep.

A single lamb, like a single goat, is a lonesome creature. We tried using him as a "lawn-mower" on the front lawn but he bleated half the time. Finally, although we knew it wasn't the best practice we turned him out to pasture with our goats.

The goats had never before seen a lamb—and I guess the lamb had never seen goats. Goats and lamb eyed each other suspiciously. The ridges of the goats' backs bristled. Then the lonesome lamb, in a friendly fashion, ran toward the goats. Frightened, the goats scampered away and it was a couple of hours before they would let the lamb get near them. Finally, they sniffed him over and philosophically accepted this "ugly duckling". Our lamb was no longer lonesome.

This lamb proved so little trouble that the following year we bought two, fattened them, and had them butchered just as with our first. In many parts of the country I'm told the sheep's skin pays the cost of the butchering, but our butcher didn't seem to want the skin. For \$3.50 we had it made into a rug—they sell for \$7.50 to \$20.00. Buying one or two lambs, fattening them for 30 to 60 days, and then having them slaughtered is *not* the most economical way to produce your own lamb, however.

Often times, a weaned lamb when moved will lose weight for awhile and consequently require more grass and grain before they "make" 90 to 100 pounds, the customary weight at which

they are slaughtered. Then again a young lamb is apt to cost \$7.00 to \$20.00. The one point in favor of buying and fattening a lamb is that this is an easy way to gain experience.

Before we discuss a better way to get started, lets take a look at what is necessary in the way of pasture, grain, equipment, time, and money to economically produce your own lamb.

Good Pasture Essential

The first thing you should be able to supply is good grass. You don't need much grass pasture—it takes about a quarter-acre of grass, 750 pounds of hay, and 100 pounds of grain yearly to support one sheep. Remember, though, you should have at least two sheep.

As for the hay, alfalfa is best. In fact, you can raise and fatten your lambs solely on good grass and good alfalfa. Clover and soybean are good hays also.

Many different grain combinations are suitable for feeding sheep. The easiest plan for the homesteader with goats is to buy "sheep and goat" ration. In *Starting Right With Sheep* a mixture of two parts oats to one part bran is recommended as the best all-around sheep feed. For fattening use five parts wheat, two parts corn, two parts oats, one part linseed-oil meal. Sheep must have plenty of water.

Now the most economical way of getting started with sheep is to buy a couple of bred ewes in the winter. Ewes should be vigorous and in good flesh, but never fat. Also make sure they are free of external and internal parasites (notice droppings) otherwise the new born lambs will become infested. Bred ewes sell from \$10.00 to \$50.00 depending on whether they are scrubs, grades or registered purebreds, the reputation of the seller, age and merit of the animals. Fleece, conforma-

tion, age and udders should receive close inspection.

Housing and Equipment

Housing for sheep can be simple, a three-sided shed with roof and a dry dirt floor is satisfactory. Two sheep need an 8 by 10 foot pen or building. A wood or wire rack is necessary for feeding hay and a trough or manger for grain. Salt and phenothiazine mixed according to directions you get with the phenothiazine, plus water are kept available at all times.

Fencing

While it is true that sheep may be tethered by a chain and swivel, this is not practical. Sheep are not good lawn-mowers—they'll eat the grass too close. Tethered sheep cannot be left out all night, and they are easy prey for dogs. *Dogs are sheep's worst enemy! In fact, the primary purpose of fencing for sheep is to keep a stray sheep-killing dog out rather than the sheep in.*

Choosing A Breed

In general there are two types of sheep—the wool and the meat variety. The homesteader should choose a meat variety. The breeds differ a great deal according to various sections and systems of management, but the part-time farmer should choose from the meat or so-called medium wool class—Southdowns, Shropshires, Hampshires, Ox-fords, Dorsets, Cheviots. Unless you're going to keep a ram, it's a good idea to find out which breed of ram is available in your neighborhood. When your first lambing time comes (about 145 days after breeding) you might have to have a veterinary present. The simplicity of the whole thing will give you confidence to handle subsequent lambings yourself.

All in all, sheep are easier to handle than cows, goats, horses, or poultry.

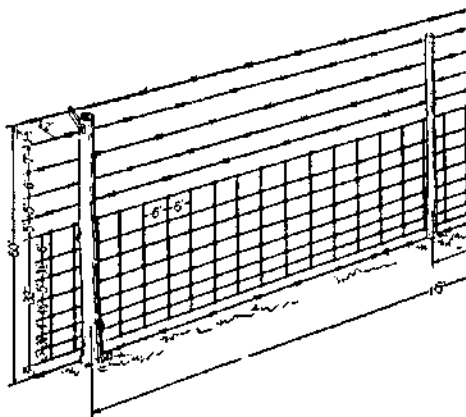

A Good Fence For Keeping Your Sheep Safe From Dogs

Veal and Beef on the Homestead

A FRIEND of mine who likes to eat once chose to spend his vacation at a Western Dude Ranch. He figured that for once he'd get all the tender juicy steaks and roast beef he could eat.

When he came back I asked, "How were the steaks?"

"Oh, good . . . good," he answered—but I detected an odd note in his voice.

He explained. "Funny thing about that ranch—even though they had a couple of hundred steers on the place they got their beef from Chicago. . ."

If a Western Ranch specializing in the production of beef cattle doesn't even raise beef for its own use then what right has a homesteader to think that he can profitably do so?

On one or two acres you probably won't go very deeply into beef production. But even on two acres if you are keeping a cow you'll find yourself raising beef in the shape of veal. Veal, as you know, is calf meat.

Once a year your family cow, like all dairy cows, has a calf. In the ordinary dairy, bull calves and heifer calves from low producing cows generally are slaughtered as veal at an early age. Often, before they are two weeks old because the dairyman does not want to bother feeding them or providing the milk they need. This early butchering is one reason why more people don't like veal. Early butchered veal hasn't anywhere near the quality of eight week veal. The best veal is from milk fed calves about eight weeks old. And this top-quality veal is the kind that the part-time farmer can easily produce because when the family cow freshens and starts producing 12, 14 or 16 quarts of milk a day a few quarts can be fed to the calf and the family still will have enough for drinking, cream, butter—and enough for cheese and chickens too.

Feeding The Calf For Veal

The calf should either stay with the cow for the first three or four days to suckle the first milk, the *colostrum*, or the cow should be milked and the milk given to the calf. If the latter procedure is followed, I think you will find that the calf will learn to drink from a pail more easily. We find it very difficult, for instance, to let a young goat kid nurse and then attempt to teach it to drink from a pan.

The weight of the calf will determine how much he should be fed. If allowed to stay with his dam, he will consume small amounts frequently. This is ideal, but you cannot favor him in this way if he is separated from the cow. On the average, feed eight to ten pounds (4 to 5 qts.) of milk per day, generally one-half in the morning, one-half in the evening. Milk should be at body temperature, and pails kept very clean. Give the calf a dry pen, free from

drafts. If he is not hungry, miss a feed rather try to make him eat. As age increases, gradually increase the amount.

If some skim milk is to be used, decrease the amount of whole milk gradually (one pint or less at a feed) and add equal amounts of skim. Warm the skim milk. Do not boil.

Raising A Steer

During the meat shortage there was a great revival of interest among small farmers, estate owners, and homesteaders in beef for home use.

If your place has enough good pasture (1 acre per steer) and enough good quality hay (2 acres of clover or alfalfa would be ideal), then you might consider raising a steer. Shelter can be simply a three sided shed; if you don't have to carry water, then a steer won't take much time.

A fellow down the road from me who has just about two acres has a steer project underway with a minimum of trouble and investment. He simply went to a dairy with a herd of Holsteins (Brown Swiss and Ayrshires make good beef too; Jersey and Guernsey not so good), bought himself a young male calf, weaned him, and tethered him out in the orchard. He kept the calf on grass all spring, summer, and fall. In October he started feeding some corn he'd grown and at the end of November he had the fatted calf slaughtered. Naturally, if he were going to sell this young steer (he had the vet castrate it) he'd have had to hold the animal for another 9 months or even a year. But for home use this baby steer provided some excellent eating.

What Is "Baby Beef?"

A number of people with small country places have an idea that because their place is small "baby" beef would be just the thing. "Baby" beef are young, well-bred, good quality cattle, often Angus, which are slaughtered at the tender weights of 700 to 1,200 pounds. BUT they are fed grain just as soon as they will take it—the idea being to keep them from losing their baby fat. The part-time farmer who probably doesn't grow much grain, won't find them economical, but of course they do make delicious beef.

How To Put On Fat

Is it practical for the part-time farmer or small farmer to raise an honest-to-goodness beef steer?

From what I've seen in the Northern part of our county I say yes—but he would go at it quite differently than the usual commercial operator.

The whole object in fattening a steer is to make it put on weight. Well-larded beef is the kind that has fine flavor, tenderness, and is good and

juicy. Incidentally, the next time a butcher shows you a steak look to see if it has streaks of white running through the red beef. This is fat—and the steak should be good and tasty.

Ordinarily, beef cattle are shipped off the ranches in the West to the Corn Belt where they are put in feeding lots and fed corn and other grains until they are fat enough to slaughter.

A Mid-west farmer buys beef cattle to fatten for market. You can do the same. Usually, for example, a couple of car-loads of Western steers are brought into our County Seat each spring to be sold to local farmers and estate owners. These "feeder" steers are usually from 6 to 12 months old and ordinarily sell for \$8 to \$12 a hundred pounds. Obviously, they're not a cheap investment and you'd do well to fatten a few pigs or some sheep before you try a steer.

In place of the intensive grain feeding program of the Midwest, there is another method that is probably more suitable for the small or part-time farmer. This is the "pasture method." It can be undertaken in two ways:

- 1.) *High-quality pasture may furnish the sole feed.*
- 2.) *Pasture during the grass season and then hay and grain for 6 or 8 weeks to finish off.*

Pasture doesn't make as finished a steer nor is it as fast as dry-lot grain feeding, but it is much cheaper and oftentimes more profitable even though the final beef doesn't bring so high a price. In addition the steer should have plenty of fresh water and a salt lick.

A new device that has made fattening a steer or two more interesting to the small farmer is the electric fence. A single strand of electric fencing is adequate to hold a steer and it is, of course, easy and inexpensive to put up.

Perhaps, however, the quick-freezer is doing still more to stimulate interest in home production of beef. The home freezer and freezer lockers mean that it is entirely possible for a single family to utilize the 500 pounds of dressed meat obtained from a good-sized steer. Five hundred pounds is not nearly as much as it sounds when you remember that the average annual consumption of beef is 65 pounds per person. If freezer space is limited remember that some cuts can be hung for weeks before cooking. Also you can make some corned beef, smoked beef, dried beef, or use the chuck in delicious canned stews. Another good plan is to divide your beef 50-50 with a neighbor slaughtering his steer one year and yours the next.

Our Little Sugar Factory

WE didn't decide to have bees until we had laying hens, chickens to eat, goats, pigs, and, of course, our garden all producing.

As I look back I believe it was my father who got us interested in the idea of keeping bees. Actually, he didn't know anything about bee-keeping, but every time he visited us he brought along a jar of honey. He liked

Parts of a Modern Beehive

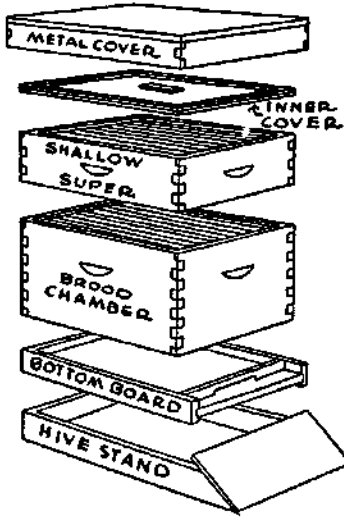

honey so much and believed it so much more healthful than sugar, he got us interested in producing our own.

We've found out that doctors do recognize that honey is the perfect sweet—it's easier to digest, furnishes a quick source of energy, and, unlike sugar, contains minerals.

Also about this time we were reading a book called *The Farm Primer* in which the author says that a hive or two of bees will increase the fruit yield by 30 percent and even make the fruit taste better. Moreover, he pointed out that a hive of bees requires only 8 hours of care per year and gives about 75 pounds of honey. Seventy-five pounds per hive seemed a lot but I've since heard of single hives producing as high as 500 pounds. Of course, it's unlikely a novice will get as much as that.

One lunch hour in New York, I went down to a bee equipment place. All I meant to do was buy a booklet called "Starting Right with Bees" I was going to read first—and get the bees later. I asked them how much the equipment necessary to have one bee hive would cost. They said, "About \$20—including a queen and three pounds of bees—but right now we have only one complete amateur outfit left."

It seems they were having trouble getting zinc to make bee smokers. This is no longer true. Obviously, if I were

going to have bees, then I'd best sign up for them right then and there. So I made out a check for the works.

Incidentally, somewhat later on in talking to Mr. C. C. Whitehead, one of the best amateur bee-keepers in Connecticut, I found it was his opinion that the only way to learn about bees is to get up your courage and order a complete beginner's outfit as I did and then you'll just have to learn or else—

One of the nice things about bees is that if you sign up for a beginner's outfit in January to March, you'll learn a good deal before the bees arrive.

That's because your outfit arrives in two shipments. The first shipment is equipment—later, sometime in April, depending on the weather, the queen and three pounds of bees—about 15,000 of them—arrive.

In the first shipment, you get a smoker, bee feeder, hive tool, bee veil, a booklet of directions, a year's subscription to a bee magazine, wax foundation; plus a hive, a deep super and two shallow supers, knockdown.

We spent about three evenings assembling the bee hive and supers—unassembled, 200 odd pieces look like a jig-saw puzzle. Each piece is so perfectly cut, it's fun putting them together.

The hive is simply a box-like structure. At the bottom is a stand with an alighting platform. Set on top of this is the bottom of the hive—3 or 4 boards cleated together to make a floor. Upon this rests a large oblong box without top or bottom. This is called the hive body or brood chamber. In it are hung ten wooden frames each one holding a patterned sheet of wax. The bees draw these sheets of wax into cells. In the cells the young bees are hatched.

On top of this large box you eventually place a shallow box, maybe two or three. These are called supers and like the hive body each hold ten frames. The honey stored by the bees in the hive body must be left with the bees for winter food. But the honey stored in the supers can be taken away and extracted. A queen excluder is placed between the hive body and the supers to keep the queen from laying eggs in the supers. On top of the super—or supers—for they may be piled one on top of the other—is an inside cover. Then over all is the tin-topped wooden cover which telescopes down over inner cover and top super to make the hive waterproof.

All the above—hive, supers, bottom, inner cover, frames and sheets of wax are sent you in pieces—and you put them together. Very complete directions (printed in about seven languages for a bee hive is standard throughout the world) are provided. We had a little difficulty putting the hive to-

gether because our playful kitten chewed up the directions, but we still made out all right.

By the time you get the hive together and painted, you'll understand a little something about the art of bee-keeping. You'll also have a chance to study up on what to do when the bees arrive.

Let me tell you, you'll get a real thrill when you come home some day and find the second part of your order—a screened box about a foot square crammed full of 15,000 buzzing bees.

I'd read that anyone can handle bees—if they do it properly—and not get stung. But I'll admit I had my doubts the evening Carolyn took me into the garage, pointed to the cage of buzzing bees the expressman had brought and said, "Well, do you want to put the bees in the hive now or after supper—remember, that's your department!"

I confess I postponed putting the bees into the hives until after supper. I also sneaked upstairs for a last reading of the chapter "How to Install Bees in a Hive".

Well, after supper I set up the hive and carried the caged bees out to the uncovered hive. I wore the bee-veil, but no gloves. It wasn't that I was being brave, I just couldn't find a pair of leather ones.

In opening the cage, I spilled the syrup can that goes along with the bees—spilled it all over my hand and about 3,000 bees tumbled out after it. Before I knew it my hand was covered with crawling bees. For about ten seconds I stood perfectly still. Then, suddenly I realized I was not being stung!

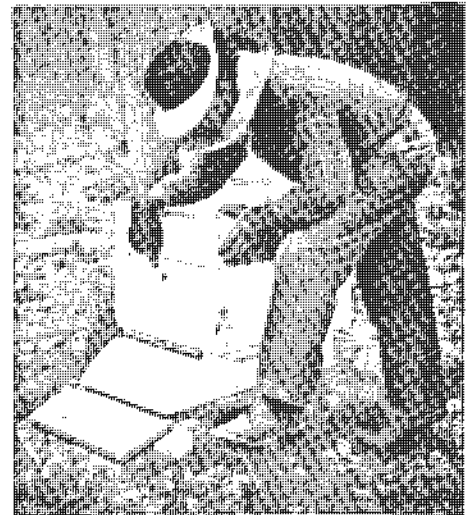

Pointing to the top entrance. In late years this second entrance, especially in the north, has demonstrated its advantages. It saves the bees from death in case bottom entrance gets clogged with snow or dead leaves. Also provides better ventilation.



At first Carolyn would have no part of the bees. Later, she learned you can handle bees without getting stung. Note "frame" of honey.

The bees were happily lapping the sugar syrup off my hand—that is, the two or three thousand that could get a lick in. I began to think again and remembered to put the opened cage inside the hive. Then, somehow, I brushed the bees off my hand into the hive, released the queen, put the cover over the hive, and went to the house.

Mrs. R. had been watching me from the kitchen window. I came in, undid my veil and tossed it onto a chair.

"Didn't you get stung?" she asked.

"Of course not—why should I?" I replied, shrugging my shoulders.

Right then and there I *did* get stung. It seems that one lone bee had crawled from my hand, up my arm, and when I shrugged my shoulders, I pinched her—and she let me have it.

I've dwelt at some length on the way I felt handling bees for the first time because so many people are missing the very real benefits they can have keeping bees because they are afraid of being stung.

All the rest of the year I was stung only twice. Both stings were due to my own carelessness. For example, one day I had been working hard in the garden in the hot sun. In fact, it was so hot that I wore only dungarees. Suddenly, I remembered I should feed the bees some sugar water. I carried it over to the hive, not stopping to put my veil on—or even a shirt. I opened the hive, flipped off the cover, bent over to pick up the Boardman bee feeder and had no sooner straightened up when I was stung by three bees. That was my fault for being so brisk and blowing my hot breath on the bees.

One other time I pinched a bee and she stung me. But by then I'd learned to rub, *not pull* the stinger out. And by getting the stinger out *fast* the sting was hardly more than a mosquito bite. With my veil, and gloves and handling the bees properly, I don't get stung.

For quite some time—from the middle of April when the bees arrived until the first honey flow in June—I fed the bees a mixture of sugar and water. This is fed by the bee feeder which

holds an inverted Mason jar with its zinc top perforated.

After the clover blossoms, the first real honey flow is on and the bees make their own honey. You'd think it might be smart not to get your bees until the honey flow started so you wouldn't need to feed them sugar-water. But the reverse is true. Although 15,000 bees sound like a lot of bees, they're just the nucleus of the hive. A strong hive builds up to three or four times this size. A few days after your bees arrive, the queen should begin producing eggs—at the rate of 2,000-3,000 a day. These eggs are attended by the 15,000 bees and the eggs begin to hatch 16 to 18 days later. So if you get your bees in April your colony should be built up to a fair size when the first honey flow starts in June.

For the first two or three months after our bees arrived the only help we had was from our books. I well remember one line in a book that proved comforting again and again—"The amateur is apt to err by giving the bees too much attention." So whenever I was in doubt about doing this or that I didn't do it.

This system worked fine until one evening when I arrived on the 6:42, Mrs. R. said, "Well, a phenomenon of nature took place today—"

I didn't like the way she said it. "What do you mean?"

"You guess," she replied.

"Jackie has started to talk."

"No."

"One of the geese laid a golden egg."

"No—your bees have swarmed."

Sure enough, in our back yard way at the top of the highest tree was a huge swarm of bees. My wife said she'd heard them come out of the hive around noon—they sounded like a squadron of high-flying airplanes, and after flying around a bit they'd clustered at the top of the tree.

It so happened that very morning a fellow commuter had told me about a neighbor of his, a Mr. Whitehead, who was an expert bee-keeper. All I knew about swarming was that bees don't usually stay around long after they swarm—sometimes only a half-hour. So I telephoned Mr. Whitehead.

Mr. Whitehead calmed me down—told me he'd lend me another hive. Then said that I should take a ladder, climb the tree, cut the branch on which the bees clustered, take it down and hang the bees on a clothes-line overnight. All this I did—incidentally without getting stung. The cluster was a foot in diameter and three feet long.

The next morning I got up at 5:30 A.M., spread a sheet on the ground in front of the newly set up hive, shook the bees off the branch and watched them stream into the new hive. Two hours later the last of them were marching into the hive—and I now had two hives of bees, for there was quite

a colony still left in my original hive.

Right here I'd like to say that Mr. Whitehead has since taught me a lot about bees. Incidentally, one of the real pleasures of bee-keeping is getting acquainted with other folks who keep bees—they are a fine bunch of people.

If you're really interested in starting in with bees, visit a beekeeper in your locality—tell him you're thinking of getting a hive of bees and see if he won't invite you over to his place to watch him open his hives. If you can, spend a few hours with a beekeeper and if you will read *First Lessons in Beekeeping* you should get along fine.

It wasn't until some time after we got our bees that we found out that we could not expect much honey from them the first year particularly because we let them swarm. The reason for this is simply that the bees have all they can do to draw the wax foundation into cells plus raising the young bees and storing enough honey for themselves. Our bees had stored up over 60 pounds of honey their first year which we left them to eat over the winter. We took only four or five pounds for our own use. The second year we had about 60 pounds of honey for our own use.

Bees are one of the most fascinating things you can have. They require only a few feet of space, gather their own food, and need only 8 hours care per hive a year. You can have bees even if you live in the city. I know of a beekeeper who lives in Brooklyn.



A honey "extractor" is used to whirl the honey out of the comb. Jackie and his friend were glad to sample each batch.

Have More In Winter, Too!

NOW we come to a part of the "Have-More" Plan that probably gives Ed and me the most satisfaction of all—preserving food in various ways so that we "live off the fat of the land" all year round.

Food preservation also has very practical compensations. Vegetables cleaned and prepared in the summer or fall save hours of shopping and of preparation in the kitchen during months to come. Furthermore, home preserved food costs less. For example, our home preserved tomatoes cost us about 5¢ per quart.

Folks today are lucky to have two wonderful modern ways of conserving food: quick freezing and pressure canning—besides that dependable old stand-by, the root cellar. One obvious rule applies to them all: use only the best of your fruits and vegetables, those just ripe and free from blemishes. If you take tough old string beans and freeze or can them, you're still going to have tough old beans. At first it hurts to throw away even one bean you've raised. But it isn't long before you realize you have plenty of the best and you can afford to give the few tough ones to the pigs or chickens.

If you want to keep your preserving to a minimum, enjoy your food to the fullest extent while it is at the height of its season instead of trying to have something different every day of the week. We certainly do not get tired of eating sweet corn nearly every day for weeks when it comes fresh from our own garden.

To show you how we have a lot of variety in our home-grown food with the least effort, here is a list of foods we emphasized, each in season. We

don't claim we ate only these items at these times, but we used them primarily—we supplement our home-grown list with things we don't grow, for instance, seafood, beef, etc.)

SUMMER (July-September)

Fresh garden vegetables—tomatoes, peas, string beans, lima beans, beets, corn, cucumbers, lettuce, summer squash, egg-plant, new potatoes, etc. Fresh fruits, raspberries, strawberries, blackberries, etc. Broilers, roasters, rabbit. All kinds of frozen meat (from winter killing). Milk, butter, cottage cheese, eggs.

FALL (October-December)

Root cellar vegetables—cabbage, beets, carrots, turnips, Hubbard and acorn squash, potatoes, Jerusalem artichokes (leave in ground). Greens still in garden: kale, broccoli, chinese cabbage, collards. Stored fruits—apples and pears. Baked beans and stews. Chicken, fricassee or pies (culled hens), broilers and roasters. Other fowl—(geese, turkeys, ducks). Lamb, chevon, rabbit. Milk, eggs, cheese.

WINTER (January-March)

Vegetables and fruits—rest of those stored in the root cellar—some canned and frozen vegetables, fruits. Fresh pork or chevon, smoked hams and shoulders, sausage, bacon. Frozen or fresh chicken. Other fowl (as you cull). Rabbit.

SPRING (April-June)

Vegetables and fruits—canned or

frozen. Spring garden greens, such as dandelions, beet tops, asparagus. Fresh rhubarb. Jerusalem artichokes, and parsnips left in garden over winter. Radishes, lettuce. Hams and bacon (cured in winter). Baked beans. Broilers, frozen or fresh. Other meats from freezer. Milk and eggs.

While we're making lists, here's one you'll find helpful in deciding whether to store, can, freeze or dehydrate the various vegetables from your garden.

Easy Storage: potatoes, carrots, beets, onions, winter squash, turnips.

Best for Freezing: all meats and poultry, snap beans, shell beans, lima beans, asparagus, peas, corn, all greens and berries.

Best to Can: tomatoes, snap beans, shell beans, soy beans, peas, corn and some fruits depending on your own likes.

Most Successfully Dried: soy beans, lima beans, kidney beans, peas, corn, onions, some fruits.

Cold Storage or Root Cellar

It so happens that the old trick of putting away root vegetables and some fruits in a cool, moist place is both easy and cheap and for certain things the best way to store.

The necessary conditions are a cool, moist atmosphere (temperature 35° up to 45°), darkness, and protection from rats and mice.

We are unfortunate in having a very small basement. What we would have liked is a cellar storage section about 10' x 6' and at least 6' high, for standing room and plenty of shelf space. A section of the basement can be walled off with economical concrete blocks or insulating board. Good insulation and a close-fitted insulated door are most important, especially if you have a furnace in the basement. A small window is also necessary in order to control the temperature within the storage unit. An earthen floor is best—it gives your storage the proper humidity. If you have a cement floor you must sprinkle it with water every day or two, or keep a bucket of water in the room. In basement storage it is also best to pack carrots, beets, and other root vegetables (except potatoes) in a barrel or crock with damp leaves or sand.

But don't hurry your harvesting to put the vegetables in storage. It is the early part of the storage period that is most dangerous. It's hard to get the temperature down to 40° or less when the weather is still warm so leave root crops in the soil until the ground is almost ready to freeze. Tomatoes, onions,

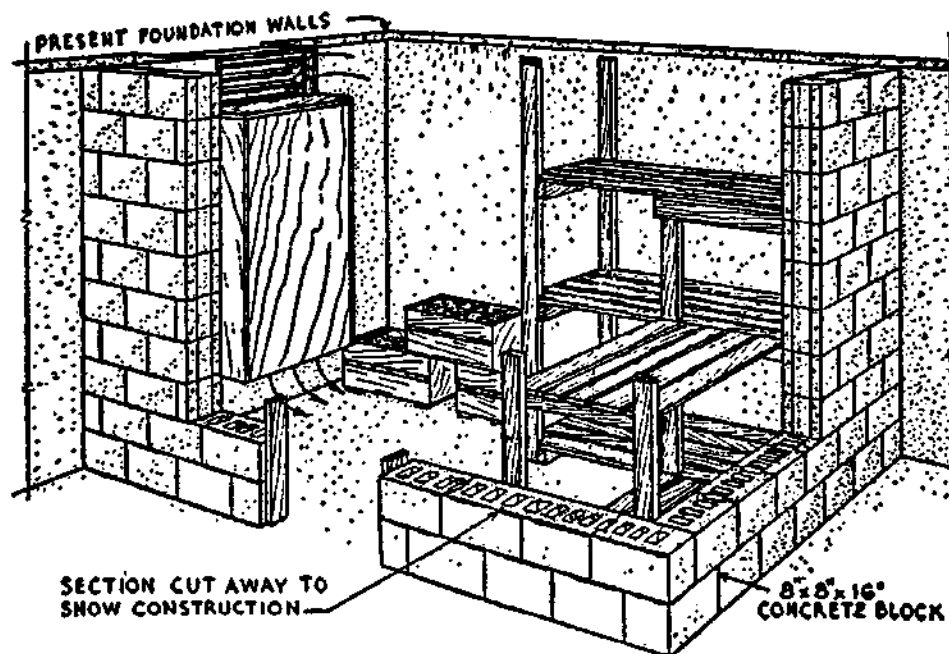

A Good Storage Cellar for Vegetables and Fruit.

squash and pumpkins, of course, have to come in before the first killing frost.

Squash, pumpkins and dry beans keep best in the attic, if you're lucky enough to have one that's warm and dry. Onions should be kept cool and dry.

Lettuce, spinach, broccoli, cauliflower, brussel sprouts, collards, kale and Chinese cabbage are hardy enough to survive light frosts and can even be left in the garden long after frosts if they are given protection with straw. We have been surprised how long you can eat right out of your garden, even in our cold New England climate. At times we have had some of these hardy vegetables in the garden until December. We've found, too, you can save your full-sized green tomatoes — just pull up the whole vine before the first frost and hang, or store the tomatoes in small baskets. They will gradually ripen if kept in a warm (not hot!) place.

But don't make one mistake we did! We didn't weed out the poor specimens at first and we lost a lot of our precious vegetables.

Bank storage space—if you have a hill handy—can be made with concrete or heavy lumber walls and ceiling. It should be at least 6' x 5' x 5' high and covered with 3 feet of dirt. No extra moisture or damp packing is necessary. In fact, getting plenty of drainage is the main problem along with keeping out vermin.

There are other methods of storage: sinking a barrel upright in the ground which is not too satisfactory because it holds so little. Another is the trench method which is simply digging a trench below frost and lining with straw; vegetables are then added, and all is covered. Obviously, it's not easy digging vegetables out and you can't check up on them easily.

For people with small cellars like us or for those of you who are planning new houses with radiant heating (which doesn't require expensive cellar space), it might be possible to have shed-type storage space attached to the garage. Of course, the walls would have to be insulated, as with the other methods, and the thickness would have to be determined by the material you used. We have not tested out this idea but it would seem to be a workable plan.

Obviously, cold storage is such an easy way to conserve food that it is probably the first method you will want to take advantage of.

Hub of The Homestead THE FREEZER

If you could take a peek in our freezer today, or any day, you would see an amazing, wonderful assortment of delicious foods. For on our miniature farm, nearly all activities lead to the freezer. Into it goes almost any-

thing and everything we can raise, plus items we buy. And the food comes out fresh whenever we want it—summer or winter. No other method of preserving food has ever made such a happy situation possible.

From the standpoint of abundance, we have eaten better on our homestead than we ever have before — and that includes the war years of scarcity and rationing. The chicken we take out of our freezer is tender, delicious. Yes, we have corn-on-the-cob and lush raspberries in January, and goodtasting greens as well as lots of other things from our past year's garden . . . and it tastes as good as it did fresh out of the garden.

Ed and I both believe the quick-freezer is one answer to man's long search for a way to harness the bounty



of nature. At any rate, we know it's a way ordinary people like us can have more security and independence than we ever thought possible.

The freezer was one of the first big capital investments we made and after using it, it would still be the first if we were starting over again. Ed loves to say that if you want to get your wife interested in homesteading, just get her a freezer. I must admit it helped intrigue me with country living and now I'm glad it did, for I would never go back to the city.

A freezing cabinet cuts your cost of living and at the same time raises your standard of living. Even if you did not raise any of your own food you could buy fresh vegetables, fruits or meat in quantities at wholesale or seasonal prices and store them away. The cabinet should eventually pay for itself from your savings in such buying. It costs

very little to run a freezer—about the same as an electric refrigerator.

Of course, if you raise your own food the savings are even greater. If you hunt or fish, you can put away some of your favorite wild duck or fresh trout for the time you couldn't otherwise enjoy such delicacies. Or you can even make some good trades with your friends—we have swapped some of our home grown fowl and meat for such tasty things as newly dug clams, fresh fish and that rare treat, venison.

You already know that in comparison with canned foods, many frozen foods taste better, look better and have more food value. We have even found that vegetables and fruits frozen immediately after picking are better than the so-called "fresh" stuff you buy in the market. When you stop to think how many hundreds or thousands of miles an out-of-season tomato or cauliflower travels to meet you you realize that the word "fresh" may mean a variety of things.

As a home-maker I have found there are many, many pleasures connected with our freezer besides its unequalled service in preserving foods. A freezer saves a tremendous amount of shopping time because you have your own little storehouse of vegetables, fruits and meats, ready to use. If you find you need a lot of fresh bread and don't make your own, you simply buy a large quantity and freeze it. What's more, you can freeze stale bread and when it defrosts, it's fresh again. Practically a miracle, isn't it?

A freezer has fascinating possibilities. Every fall we freeze lots of sweet apple cider at a cost of 2¢ a quart for morning fruit juice, or it's elegant for hot, mulled cider on a winter's evening. Also when I make stews, soups or home-baked beans, it's just about as easy to cook double or triple the amount needed and freeze some for future use. You can also freeze cakes and pies—or the dough to be used for pies and cookies. There seems to be no limit as to what a freezer can do.

If you are preserving your own foods, you'll find that freezing is far easier than canning. To show you how simple it is, here are the steps involved in freezing green peas:

1. Pick the peas from your garden.
2. Shell and wash the peas, discarding old or imperfect ones.
3. Blanch peas. That simply means placing peas in a colander or wire basket and immersing them in rapidly boiling water (at least a gallon to a pound of peas) for one minute.
4. Then immediately immerse peas in cold running water.
5. Drain and pour peas in to a moisture-vapor-proof bag or container and seal.
6. Place package in freezer.

Quick freezing fruits is absurdly simple. Take strawberries for instance. Remove stems, wash, cover with sugar-



When guests come in unexpectedly for meals, Mrs. R. can serve a wonderful dinner on short order, complete with half-a-dozen meat choices, corn-on-the-cob, and fresh strawberry shortcake. If you want to interest your wife in home food production, plan to get her a quick freezer.

ers widely distributed will make as phenomenal a change in this country as did low priced cars. With a good freezer and a little piece of land you can be just about as independent and as secure as you wish. The freezer can be the secret of one goal all we Americans constantly work for—freedom from want. Anyhow, that's what our freezer means to us.

Home Canning

There was a time when practically every article written on canning started out with the old saw—"Eat what you can—and can what you can't."

Today, that's so far from reality it isn't even funny. Of course, you eat all you want during July, August, September and October directly from the garden. Then, as we've pointed out, it's easiest to utilize a root cellar. Next is preservation by freezing—if you're lucky enough to be able to use this wonderful new method. Then comes canning.

In all frankness, it is best to preserve certain things in glass jars—tomatoes, sauerkraut, pickles, stewed fruits, preserves and jelly. But canning, even with a pressure cooker, is more difficult than freezing and the results, minus the exceptions noted, are, we think, inferior to freezing.

I will say that the savings in canning your own fruits and vegetables instead of buying them is tremendous. I know that's contrary to what we've been told, but it's true because you do it all on your own place—you don't pay for all the traveling raw vegetables do to get to a factory and back in cans to grocery shelves. Take the popular tomato as an example—here is the cost of our 75 quarts of home canned tomatoes the best we can figure it:

Plants	\$1.00
Spray25
Jar tops75
Jars (amortized on 10 yr. basis)...	.45
Cooking (coal stove) estimated25
Spices05
	<hr/>
	\$3.25

75 quart commercially sell at 22¢ each—\$16.50
Our Savings: 80%.

And we do not blush at saying our tomatoes are superior to what you can buy in taste, color and texture!

Prejudice had been built up against home canning by making it appear to be a back-breaking complicated chore. But we have found it fun by doing only a few jars each day in the summer instead of trying to do it all in a few days. It is pretty simple, especially with the help of the booklets put out by the canning jar companies. We happen to have a Kerr booklet (Kerr Glass Manufacturing Co., Huntington, W. Va.) which cost 10¢ and which led us successfully through all our canning, though neither Ed nor I had ever canned before.

Canning is not complicated but it

syrup, package, freeze. When it comes to meats, it's nothing at all once the meat is cleaned and cut, ready for cooking. Just wrap and freeze.

There is a wide assortment of containers made especially for freezing—that is, vapor and moisture proof. I won't describe these here, for you will have to get a bulletin or book with complete directions if you are going to freeze foods.

We bought our freezer shortly before Pearl Harbor and paid \$440 for it. It is a 13 cubic foot cabinet and holds approximately 700 pounds of food. The price we paid was high, but few freezers had been made at the time we bought ours. Now, many large companies are building them, with mass production the price is lower; \$230 for one similar to ours.

Many people have been using frozen food lockers which have rented for \$6-\$15 a year. If the locker plant is situated conveniently to your home, you may prefer this method of having a frozen food supply. A locker plant usually offers the convenience of packaging and cutting meat for you and also provides a place to hang and cool meat before freezing.

However, I personally prefer a quick-freezer at home where I can tuck away a few boxes of fruits or vegetables or a small quantity of meat as I find time to prepare them. When you are raising large quantities of your own food, it

may become practical to use both a home freezer and a locker, as you would then have the convenience of both arrangements. Or another plan would be to build (or have built) your own freezer room and cool room.

From our own experience we have learned several things about buying and running a freezer. We made a serious mistake in placing our freezing cabinet in our garage where the temperature drops below freezing in the winter. We discovered that such low temperatures prevent the motor from operating properly, so we now have it in our "Harvest Room." After having our freezer break down once and losing some of our hard-earned foods, we know now that there should be some signal to warn you when the temperature rises above the danger point. There should also be instructions fastened on the freezer to tell you when and where to oil the motor. These things we learned from our one bitter lesson and we wanted to pass them along. It pays to buy a good cabinet from a reputable dealer and with so many new designs developed during the war years it will be wise to look over a number of freezers before choosing yours. Whatever your intentions are on using a freezer, we would certainly recommend getting one with a special compartment for quick-freezing your own food.

We certainly believe that food freez-

does require accuracy. To make the work easier, get all your equipment ready to use before you actually prepare the food. And by all means do your preparatory work in a pleasant place. At first we did ours on our back terrace, but now we have our delightful "Harvest Room."

It is usually suggested that you plan 100 quarts of fruit and vegetables for each member of your family, but if you are seriously trying to be self-sufficient and are preserving food only by canning we believe you would want somewhat more. However, the first year aim for the 100 and the next year you'll be able to adjust the amount to your own needs. The 100 quarts should be approximately divided into one-third fruits, one-third vegetables and one-third tomatoes or tomato juice.

That figure sounds rather forbidding doesn't it, from the standpoint of quantity and time to preserve? Let's take up the question of quantity. In the case of apples, one bushel produces about 20 quarts; cherries, 24 quarts; peaches, 25 quarts, plums, 30 quarts; berries, 24 quarts. That is a good deal more of each fruit than any one person will eat during the non-productive season. So

Pressure Canner.

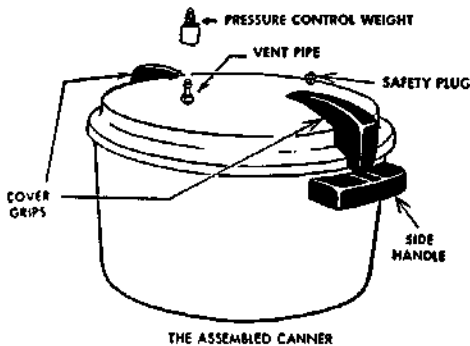

to achieve your goal you would only have to can a few quarts of each fruit as it came in season. The same principle applies to vegetables.

As for canning equipment, by all means try to get a pressure canner. It is recommended by all authorities as the safest way to can your vegetables properly and it saves time, fuel and work.

Still unknown to thousands of families the pressure canner is also a miraculous cooker. It will cook a complete meal in 10 to 15 minutes, including soup, roast and vegetables! Using little water, it saves valuable vitamins and minerals. It tenderizes cheaper cuts of meat. It can preserve surplus meat, poultry or fish, although we believe that the quick-frozen method is best.

As for pressure cooker size you will want an 18 quart canner (holds 5 quart jars) or a 25 quart size (7 jars). With the canner you will receive a booklet giving you a time table for processing and general directions for canning.

Even if you don't go in for all the "Have-More" Plan, we believe in "canning all you can" anyway—and that goes for peace time as well as during a war or a depression. Believe me, it will give you a tremendous feeling of satisfaction and security when you begin to line up the jars on your shelves. Ed is just as proud as I am to point to the canning shelf and say, "I canned those bread and butter pickles." Such bragging is good for the soul—it's one of those intangible satisfactions you get from homesteading.

Salt Some Away

Another easy way to keep certain vegetables is to salt them down. The one big fault with this method is that it destroys a lot of the vitamins and minerals. For this reason we have not done any brining (except to make sauerkraut, ham and salt pork).

Everybody knows about salting cabbage to make sauerkraut. I put mine up in jars as I have found this even easier than the crock method. It is also possible to salt away corn, beans, cauliflower, turnips and peppers.

Alternate layers of washed vegetables and salt are packed into earthen crocks and weighted down. If enough brine to cover vegetables completely is not formed, a concentrated brine made with boiling water may be added. Use $3\frac{1}{4}$ cups of salt (common or coarse salt is better than fine table salt) to 6 quarts of water. Keep in a cool place—the vegetables are ready to use at any time.

To desalt for use, put salted vegetables in a big pan, cover with cold water, heat to luke warm, stir and pour off water. Repeat until vegetables are only slightly salty. Then you can cook in regular manner.

Dehydration

During the early part of the war I read a lot of articles telling how wonderfully easy it was to dry your vegetables and fruits at home. Well—in our attempt to carry out miniature farming in the easiest, most modern way, we borrowed one of the very best home model dehydrators which set back one of our neighbors about \$40.

We soon found that proper dehydration is not so terribly simple after all. It takes as much preparatory work as canning and it is more difficult than freezing foods. We think its worst feature is the long drawn out drying process. It takes 10 hours just to dry the food thoroughly; you can scarcely complete the project in one day.

In our section of the country where there is much moisture in the air, dehydrated food should be packed in tightly sealed jars so it won't absorb water again until you use it. And when you do, dried food takes pre-soaking to return it to its normal state.

We do not believe home dehydra-

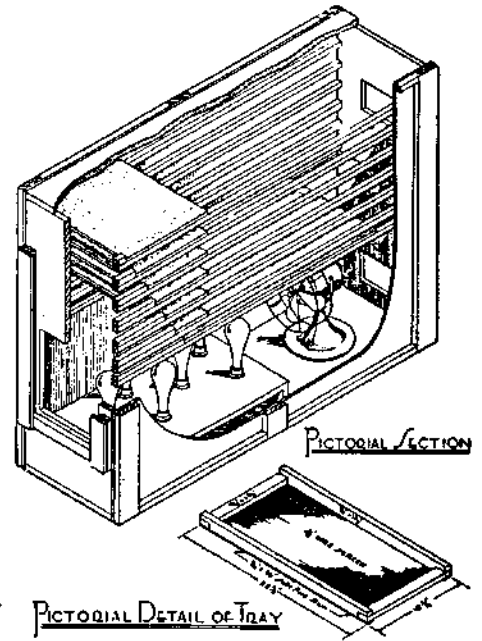

One Type of Dehydrator.

tion will ever be widely used in America except where it is specifically desirable for reasons of taste, geography or space. Frankly, we couldn't stand the taste of the three things we tried—snap beans, spinach and broccoli. But if your family is extremely fond of dried beans and peas then it would be worthwhile to dry them. Also, we all know that certain fruits are splendid dried.

If you are interested in drying foods, we suggest you try it out in your cooking oven first and see if you like the idea. You'll get about the same results you'd get with a special machine. Place oven door open and set the temperature at 165°. You'll have to get the length of time for drying your specific vegetable or fruit from an instruction booklet. Then freshen up the dried samples, cook them and see if you like them. If you do approve, you can either buy or build a dehydrator.

You can build a dehydrator using a small electric fan and a bathroom heater but the thermostat is quite important. It is probably just as well to buy the whole dehydrator or else use your oven. Detailed building plans may be obtained from your County Farm Agent.

We'd suggest you read a little booklet called "Dehydrating Fruits and Vegetables," put out by General Electric Company, Schenectady, N. Y. It costs 10¢ but it is well worth reading before you decide to go in for dehydration.

WINTER GARDEN—Cold Frame, Hot Bed, Small Greenhouse

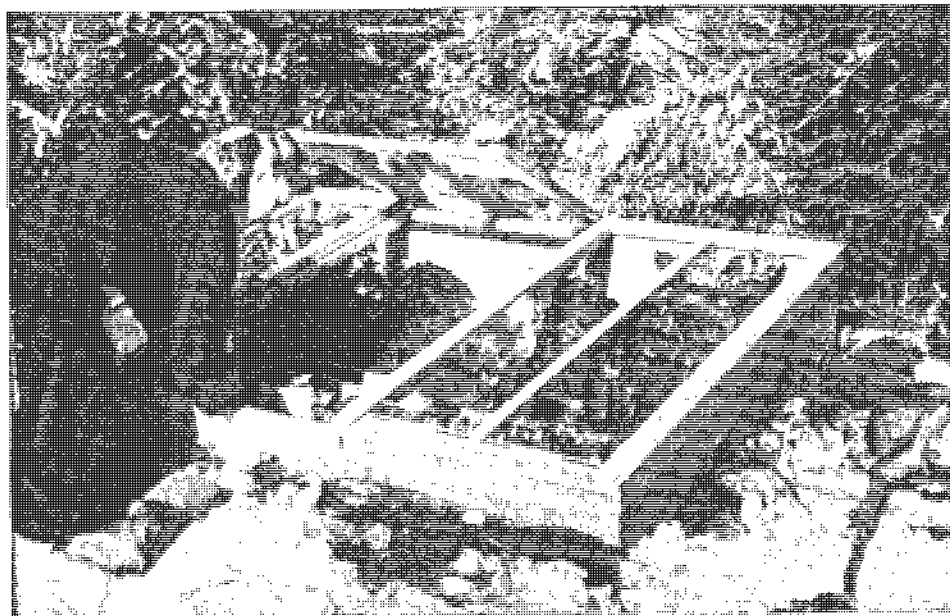

Hot bed made with new-type, small-size, putty-less sash. A hotbed is simply a cold frame heated by a bottom layer of manure or an electric heating unit.

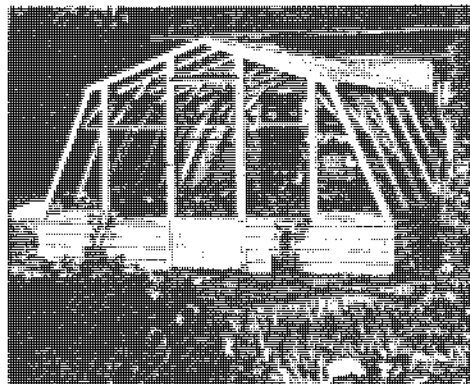

(Left) A small greenhouse may be attached to the house and heated by the house furnace.

(Below) Interior of a small greenhouse that can be bought for \$300. This new Lord & Burnham greenhouse has automatic temperature control and automatic watering.



WHEN we first produced our own vegetables, we looked into starting plants under glass. Because this seemed complicated and because we had only about an hour or so of spare time a day to devote to our food-raising activities, we decided we'd buy our plants from a good local greenhouse.

The main reason for growing plants under glass in all of the U. S. (except for the extreme Northern States with their exceptionally short growing season) is to spread the products of your garden over as long a period as possible. Once you have a freezer, glass gardening isn't nearly as vital.

Probably you've read about the new small greenhouses with automatic watering and temperature control that sell in the neighborhood of \$300. We talked to the manufacturer, the Lord & Burnham people at Irvington-on-Hudson, N. Y., to find out if these were economical and practical. Here's their answer:

"Frankly, from a straight economic point of view we cannot justify a greenhouse in a 'Have-More' project—we would not attempt to, any more than you can justify the purchase of any luxury on straight economic grounds.

"For an ardent amateur gardener, a greenhouse has a different appeal. It permits him to keep his hands in the soil all winter; it permits him to have the satisfaction and pleasure of growing plants and flowers. The best satisfaction comes to those specializing in bringing in unusually fine quality of some particular specie or variety. Then the greenhouse owner can raise plants for setting out in the spring and do it easier and more satisfactorily than in a hotbed or cold frame."

I do think it was pretty fine of these people who sell greenhouses to give us such an honest estimate. They just don't believe a small greenhouse will "pay for itself" on the average homestead. It seems that the value of a greenhouse depends largely on how far north you live. If you live where the grocery stores carry most summer vegetables all winter it probably won't pay you to grow vegetables in a greenhouse.

Commercial growers north of New Haven and especially up past Springfield, Massachusetts into Vermont and New Hampshire can make a greenhouse pay on just one tomato crop. Further north, in Ontario, Canada, it is easier for a commercial grower to make a sure success with winter vegetables.

If you think you'd like to have a greenhouse you might consider attaching it to your house. This lowers the heating cost considerably. I know that Fred Rockwell, editor of *Home Garden*, has a greenhouse hitched to the southeast corner of his house. The greenhouse is heated by the same furnace that heats the house. This is an economical arrangement because on sunny winter days the greenhouse absorbs a lot of heat and contributes this extra heat to the house. Fred says this system works so well his fuel bills are no higher than before he had his greenhouse.

Grow Your Own Fish

HAVING a fish pond in your back yard seems almost too good to be true. But Government experts say you can easily build a pond for as little as \$100, and that a one-acre fertilized pond will normally yield by hook and line "something like 40 or 50 one-pound bass and about 600 to 800 quarter-pound sunfish each year".

We were surprised to learn that you don't need a stream or brook to have a fish pond. In fact, experts say it's better not to build your pond by damming a brook because the pond is too easily destroyed by floods. They recommend excavating a naturally low area using the run-off from the surrounding terrain as the source of water. Or you can use a spring or well. The pond should be 6 to 12 feet deep to protect the fish from freezing and possible drought.

Over 7,000 farmers grow fish in their own ponds. You stock a fertilized pond in Spring or Fall with fingerlings of bluegill sunfish and large-mouth bass and you can fish them out after 4 to 12 months. The fingerlings are obtained free or at a small cost from State Hatcheries or from the U. S. Fish and Wildlife Service. Some states, Ohio for one, will practically build the pond for you.

To keep plenty of fish growing in the pond the experts have worked out a fascinating "food chain". First you distribute about 100 pounds of regular 8-8-4 crop fertilizer in the water. After a few days the water will take on a brown or greenish tinge which means the fertilizer has caused the growth of microscopic plants called algae on which young sunfish thrive. Then (in Spring or Fall) stock a one-acre pond with about 800 fingerlings of sunfish and 100 of bass. The sunfish live on the algae and the bass live on young sunfish. This food chain will continue producing fish year after year so long as you keep the pond sufficiently fertilized and do plenty of fishing! It's impossible to catch too many fish by hook and line. In fact not fishing out enough sunfish may result in too many for the amount of algae and the sunfish won't grow to eating size. The same will happen if there aren't enough bass to eat the young sunfish. For more variety you can also grow bullheads, pickerel, and other fish, but stocking must not be done indiscriminately or it may upset the whole balance in the food chain.

A permanent drainpipe in the dam facilitates draining; if pipe is large enough fish pass through so you can catch them the "easy way." Young trees, shrubs and grass planted around the pond make cover for wild life.

P. S. from Carolyn R.

Personally I don't want to go swimming in any old brown water full of algae, but as a fish pond it sounds wonderful and I hope we can build one!

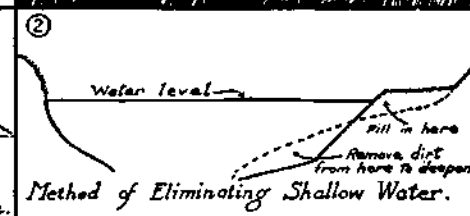
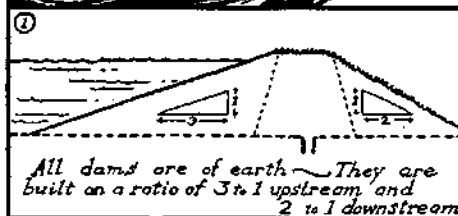

The Woodlot

ORIGINALLY our house was located in the midst of two acres of woods. As we've cleared our land, we've had plenty of firewood.

It's a good idea to have an acre or so of woods. Just the dead and fallen timber will give you about a cord of wood per acre each year for your fireplace—and some fence posts too. Maybe you can harvest some lumber—it's much cheaper to haul it to a local sawmill than it is to buy lumber these days. About 6 months of exposure to sun and air is necessary to dry green lumber.

A woodlot is little trouble. Here is a simple program that will help you keep your woods in good condition and at the same time provide you with firewood and some lumber:

- 1.) Fence out livestock. They eat saplings, injure young roots, cause erosion, and in time can ruin a woodlot.
- 2.) Take all diseased or down trees for firewood.
- 3.) Practice *thinning*. This simply means cutting out the weed trees and "crowders" so the good lumber trees will grow faster. It should be done about every two years. Save what you cut out for fenceposts, bean poles, etc.
- 4.) Prune off excess branches on lumber trees to prevent knots. Save these branches for firewood. Learn to recognize your valuable lumber trees, and mark them with a band of white paint.
- 5.) Harvest every lumber tree before it becomes over-age. You should learn the proper size tree to cut. Government studies show a 9 inch maple will bring only 1/36 of the price paid for a 26 inch maple. The profitable way to sell is to make the cutting yourself and haul the logs to the mill.
- 6.) Plant seedlings in any bare patches you find in your woodlot. Trees will grow in the poorest possible soil where no crops can be grown.
- 7.) If your trees are attacked by blight, disease, or insects, ask advice from your State Forester, or County Agricultural Agent.
- 8.) Protect your woods from fire!

For construction on your place you can hire (or borrow) a portable sawmill to come to your woodlot and saw up lumber trees there. This will be a lot cheaper than buying lumber. Whatever you do, never cut an entire stand of trees. Leave at least 5 large seed-producing trees per acre, and plenty of saplings and younger trees.

Fence Posts

Soft woods such as willow, soft maple, beech, and box elder will last only 3 to 5 years in the ground as fence posts. But you can make them last 20 to 25 years by boiling the lower ends in a steel drum of creosote. Let them cool in a second drum of creosote for best results.

How Much Is A "Cord"?

A standard cord is a stack of 4-foot lengths 4 feet high and 8 feet long. However, firewood is usually cut in shorter lengths so a "cord" of firewood

may not be a standard cord. If you have occasion to compare different prices for a "cord" of firewood, it's a good idea to get the measurements, so there is no misunderstanding.

Clearing

By all means don't try to save money by buying wooded land and clearing it to make your garden or pasture. Clearing is really tough work and it's expensive no matter what method you use. You have a choice of four methods of removing stumps (after you've cut down the trees) and you'll probably have to use *all four* ways on some of the big stumps before getting them out! The most primitive is to dig and grub the stump out with a pickaxe and axe. It's a long tough job. Allow at least 1/2 a day to dig out a 6 inch stump this way. A quicker way is to burn them out, using a portable burner which you may be able to borrow from a neighbor. We burn out small stumps this way in less than 2 hours. The burner has a strong forced draught which produces intense heat. However, it doesn't burn all the roots—you have to chop them out. Blasting is another way. Small stumps can be blasted entirely out of the ground and large stumps can be loosened up this way and then pulled out with a block and tackle or a patented pulling device hitched to a team or tractor. For details and safety precautions on blasting write to the Superintendent of Documents, Washington, D. C. for U.S.D.A. Bul. #191.

All in all, I really believe the best method of clearing is to hire a bulldozer. It's amazing how much damage a bulldozer can do in a short time. In just eight hours the bulldozer we hired (at \$5.00 an hour) cleared about 20 stumps, 2 big boulders, and did all the grading and filling necessary to give us a good level half-acre garden plot.

Erosion Control

If you have waste land where the soil is too poor for crops, you can grow trees there. They'll take many years to grow to maturity but meanwhile they prevent erosion, add beauty to your homestead, and increase its value. (In some localities you will be assessed slightly higher taxes for the acres you plant to forest, but they're worth it.) Your State Forestry Department may provide free seedling trees.

HEATING VALUE TABLE

GOOD	FAIR	POOR
Hickory	Chestnut	White Pine
Beech	Hemlock	Cottonwood
Locust	Catalpa	Aspen
White Oak	Box Elder	White Spruce
Ash	Butternut	White Fir
Birch	Soft Maple	
Sugar Maple		
Elm		
Black Walnut		
Apple		



The spirit is willing...

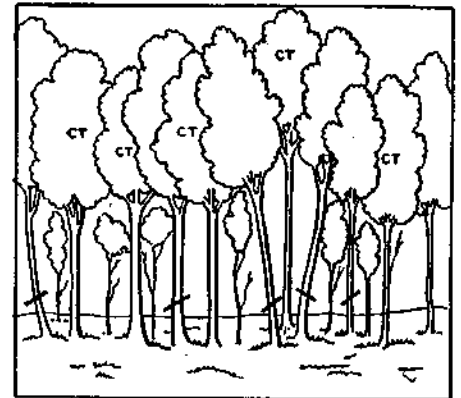
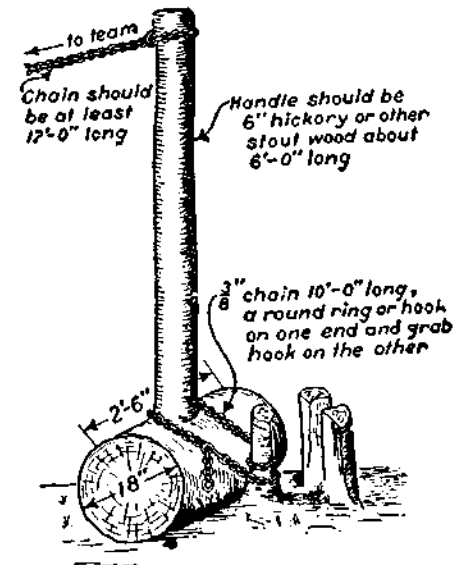

Diagram of a typical group of trees showing which trees to cut and which to save. Trees marked CT are the crop trees you are saving till ready for harvest. Notice you cut some large trees to allow younger trees to grow.



A simple stump puller like this can easily be made. It increases the pulling power of a team, car, or tractor about 6 times.

Transportation and Power

SOME kind of car is almost a necessity in the country. Even so, present day cars are not very satisfactory for productive country living.

Today cars are made primarily for city dwellers. That is they are made to transport people—and only people. In the country on a small farm there's a lot of other things in addition to people that you want to move. To name a few: lumber, hay, grain, livestock, poultry, firewood, gravel, cement, earth, produce. On a large farm a truck is probably a worthwhile investment but on a small place there is not enough work for a truck and there's many a need that a truck won't solve.

There are countless jobs around a small place that you can get done a lot easier with some power equipment. Until recently, the manufacturers more or less turned their backs on the small farmer. Now they realize the terrific potentiality in supplying the small land-owner and a number of power units for the small place are coming on the market.

In trying to decide how best to solve our Transportation and Power needs we made up the table below. Perhaps this will help you solve your problems. All prices are estimated for new equipment; obviously good second-hand equipment may be bought cheaper.

For example, in place of the 9,000 "garden type tractors" manufactured yearly before the war, over 100,000 are expected to be sold post-war. The "garden tractor" people are trying to put out better and more powerful machines. At the same time the manufacturers of large-scale tractors are developing smaller models for use on farms of 40 acres or less. All this can only result in better and cheaper power equipment for the small land-owner.

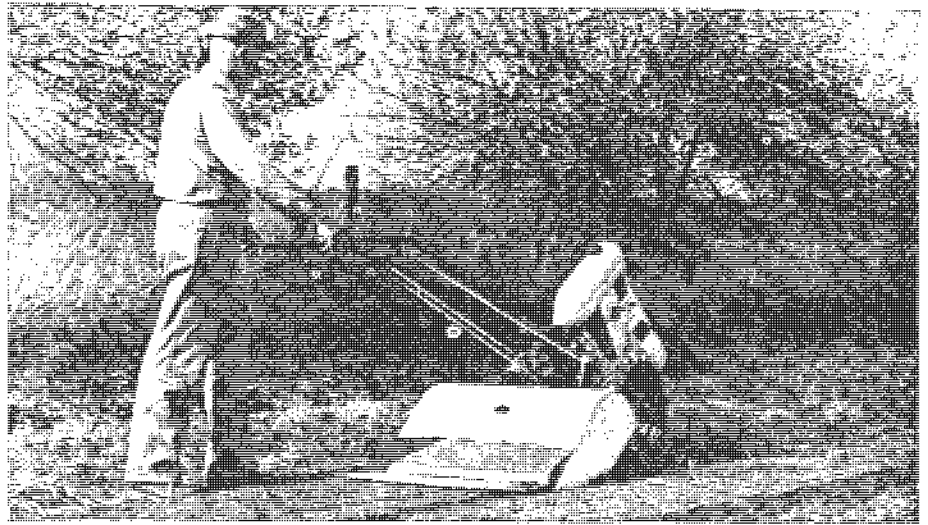

A Walking Tractor that plows, disks, and harrows in one combined operation—a "new" principle of cultivation ideal for some small areas.

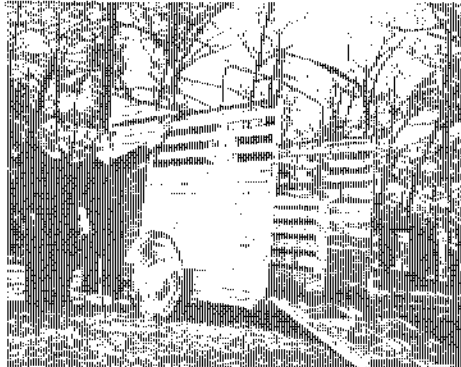

A Utility Trailer plus the family car is worth consideration. This home-made trailer is built low to facilitate loading . . . carries 2 animals . . . has many other uses.

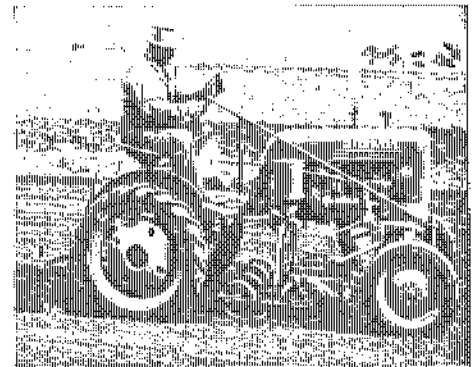

A Baby Tractor with the full complement of attachments offers the small-acreage farmer low cost power for all field and garden operations.

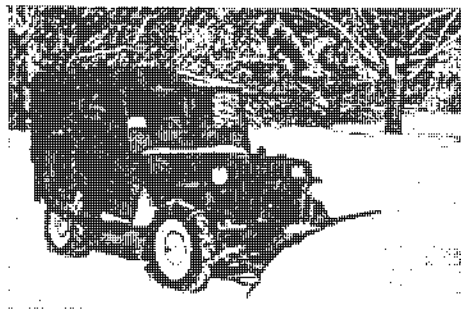

A Civilian Jeep works as tractor, passenger car or small truck and as auxiliary power plant for running all sorts of machinery from saws to your freezer in an emergency.

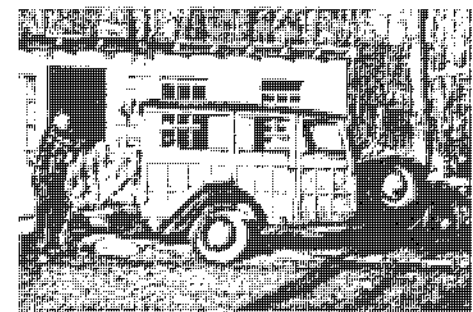

A Station Wagon is an all-purpose car for country homes. Unfortunately its cost is high and the wood construction needs yearly paint or varnish.

The Needs	Possible Solutions			
	Civilian Jeep	Car & Trailer	Station Wagon	Walking Tractor
Getting to work	Yes	Yes	Yes	No
Shopping	Yes	Yes	Yes	No
Social Life	?	Yes	Yes	No
Long Trips	?	Yes	Yes	No
Heavy Loads	Yes	Yes	Yes	(short distances (with trailer))
Moving Livestock	(with trailer)	Yes	(not large animals)	No
Snow Plowing	(with attachment)	(with attachment)	(with attachment)	(with attachment)
Power "take-off" for Sawing Wood, etc.	Yes	No	No	Yes
Cutting Lawn	?	No	No	Yes
Cutting Hay	Yes	No	No	Yes
Cultivating & Plowing	Yes	No	No	Yes
Cost (New)	\$1,500	\$1,150	\$1,350	\$500.

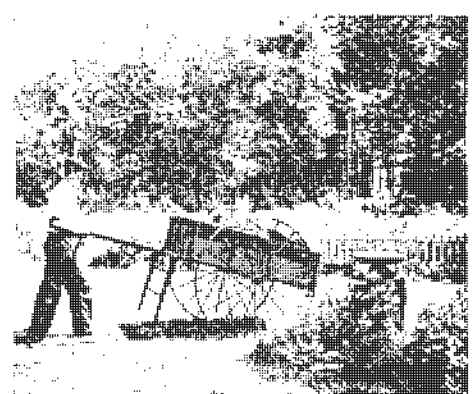

An Army Cart holds about four times the load of an ordinary wheelbarrow and is still easy to manage.

Housekeeping on a Homestead

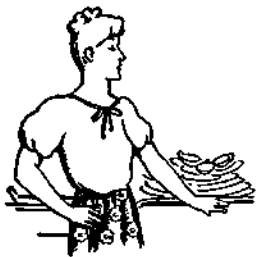

HOUSE-keeping should be a challenging subject to us American women. Instead, many of us consider it with boredom, or

with resentment that we have to do it at all—and if our husbands try to talk over our methods, we are likely to fly off the handle and wind up with the old come-back, “Well, I’d just like to see you take care of the house for a while!” I’m afraid I have to admit to just such arguments with Ed in the past, and to be honest, there is something to be said on both sides.

I do believe that there have been several things outstandingly wrong with modern housekeeping and that homesteading can answer some of our problems. The more important drawbacks I’ve found are:

(1) *Our own attitude toward housekeeping* is probably the key. I’m afraid that many of us look down our noses at it—we consider most any other job but homemaking glamorous. What we forget is that every job, whether it’s a man’s job or a career woman’s job in office or factory, has its own monotonous routines, too.

(2) *Lack of creative work in modern housekeeping.* Women really can’t be blamed for considering “housekeeping” a routine bore—that’s about all that’s left of homemaking in the city or suburbs. I don’t know how you classify your jobs, but, outside of raising children, I consider cooking about the only creative work left in most city and suburban homes today. The current trend seems to be for more and more of the family work, recreation and even child raising to be handled outside the home. All that will be left is vacuuming, washing dishes, and dusting—all negative and unstimulating.

(3) *Lack of economic satisfaction.* Since today’s woman has been brought up to be independent, it’s no wonder she’s not satisfied with the eternal routine left in the home. She’s not increasing her family’s security unless it’s in the negative way of cutting down expenses. Since the urban custom is to buy everything eaten, worn or used, it’s no wonder urban women have begun to feel their best contribution to their families would be jobs outside the home.

(4) *Lack of housekeeping efficiency.* Manufacturers have done much to make housekeeping efficient and easy,

but keeping house still needs a thorough engineering job done on it. The amount of your daily work is determined the minute you choose your house, the type of furnishings you put in it, the way you arrange your storage space and the type of clothes you buy. If we women want to contribute more to our families we will have to make routine work as efficient as possible.

What Does A Homestead Do To Housekeeping?

It makes a big difference in your housekeeping when you have a homestead. When I lived in the city I had no interest whatsoever in housework except for learning to cook elegant meals. I became so bored with apartment housekeeping I found a job in a large New York City department store. And did I add anything to Ed’s and my security? I did not—for it took practically all my salary to provide adequate clothes for my job, lunches, bus fares, a part-time maid and other incidentals. Now that I am a partner on a homestead, housekeeping is just the routine part of a bigger job—not the be-all, end-all of my existence.

Of course you have much more to do on a country place than in the city. But these new jobs are stimulating, creative and varied. Think of the satisfaction of having a freezer stuffed with luscious food you helped raise yourself. Imagine your canning shelves laden with full, glistening jars—your handiwork.

And you can do all sorts of other things: separate milk to get heavy cream, make scrapple, make cheese, extract honey from the combs, (this is a 3-ring circus of fun!) and serve dinners of “home-raised” products that guests really appreciate!

There are also many pleasurable activities outdoors. The pigeons, geese and ducks, and all the new born goats can be your special projects. You’ll help with the garden, have herbs and all the beautiful flowers you want. Someone has said, “He who lives with the land has innumerable professions.” He is, for example veterinarian, farmer, gardener, animal husbandman, chemist, accountant, manager, weatherman, machinist and so on. That is equally true for the wife who shares homesteading activities.

Once you get started doing and making things for yourself you’ll probably want to do even more—do more sewing for your house—make your own Christmas presents (we’re raising popcorn this year for little remembrances)—maybe even make some rugs or do weaving. You can also raise or make

things for sale. Life will become a question of how can you do all that you want to do.

Because a homestead offers a woman an unlimited field of creative activities, it removes the complaints against housekeeping.

First, your own attitude is brighter and more interested.

Second, your work gives you pleasure and satisfaction because it is creative.

Third, you have that fine independent feeling of holding your security in your own hands, and you’ll take great pleasure in knowing your children are being well-fed and growing up in the most wholesome of surroundings.

Fourth, you are more of an executive and have more interest in increasing your efficiency.

In the book “Zero Storage” Mr. Sparkes, the author, describes the Fylers, a family of seven who have been homesteading and he sums up the economic point with this sentence. “For Mr. Fyler, one fact must be crystal-clear: by reason of the land and the freezer, instead of one Fyler, seven are now helping to make the family living.”

When Jackie gets a little older, there will be three Robinsons instead of two “bringing home the bacon.” Before we started homesteading it was just *Father!*

Now For The Housekeeping Itself

It has taken me three years of “homesteading” to realize how ridiculous it is to judge a woman’s housekeeping ability by whether or not her country house is spotless, with dishes and beds attended to by 10 a. m. Instead of ironing or dusting, you will want to pick strawberries that are just ripe, wrap a chilled lamb for the freezer or go



fishing with your children. But your very annoyance with the routine tasks will give you the incentive to cut down the time they take. And when you tackle them with this sort of outlook, they

immediately become more interesting!

It seems to me, proficiency in housekeeping falls into three main divisions:

- (1) Layout and furnishing of your house.
- (2) Equipment.
- (3) Management and organization.

The House And What You Put In It

Architects are now beginning to realize that a woman's working areas should be laid out in an orderly, convenient way. I have begun to see more plans recently where washing, ironing, sewing, cooking and children's play areas are correlated instead of being scattered all over the house from attic to basement. Also on a homestead you will want to consider whether the bathroom is handy to the outdoors, whether there is plenty of space for outdoor clothes where you usually enter and whether there is sufficient place for country tools and equipment. The amount of your routine work is somewhat determined the minute you choose a house. If you should build a new house, there will be many new designs and ideas to choose from. For instance, new radiant heating (hot water pipes under the floor) not only provides a healthier heating plan, but it will mean less work for Mama—no dusting and no painting those unsightly dust catchers called radiators. Also floors over the heating pipes may well be tile—warmer in winter, cooler in summer. And if the floors are pretty and warm—why, fewer rugs to pay for or to clean.

If you already have a conventional house there are still plenty of things you can do to make housekeeping easier. On your floor you can use patterned or neutral colored rugs which don't show dirt quickly, or scatter rugs which can be picked up and washed. The floor itself is easier to clean if it's waxed and a vacuum cleaner can often be used on it to more advantage than a dust mop. Or if you have an old unsightly floor, spatter painting might be the answer to simple care. Wooden furniture collects less dust if it's waxed instead of polished with oil.

When it comes to upholstered furniture most of us know how much simpler it is to have slipcovers which can be removed and washed easily. And if you buy or make slipcovers, bedspreads and draperies out of material that doesn't have to be ironed, (say seersucker, monkscloth—rubber or aluminum cloth that can be washed with a hose) then you've saved yourself even more work. These are just a few samples of what you can do if you look at your work with a mental question mark.

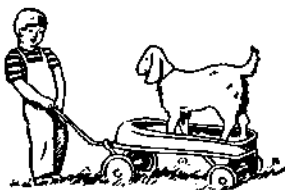

Equipment

I remember a city husband saying, "I don't want my wife to have any more gadgets to make her apartment keeping easier—she'll just spend more money shopping!" I guess it's true in the city that the more spare time you have the more money you spend. There's not much else to do.



On a homestead, however, spare time is time to use productively. Of course you can run into town but you don't want to go when you've got a garden to plant or the bees are getting ready to swarm or a new lamb is expected.

So machinery for housekeeping and homesteading jobs is a good investment, for you use this equipment to create more for your family. One homestead husband told me he would rather have an electric mixer with all its extra parts in his home than an automobile (granting that a car wasn't a vital necessity to his job).

Here are some specific ways to use equipment on a homestead like ours:

a) *Cooking.* The freezer is one of the greatest aids to cooking. While its primary function is to preserve raw food, it is a boon to better cooking management. While you're cooking stews, soups, beans, creamed foods, cakes, cookies or breads, it is easy to make double or triple batches and put part of them in the freezer for another meal. You can assemble a variety of dinners from soup to dessert, place each dinner in one bag or box and freeze it for future quick delivery. Lunches too can be prepared for the week and frozen each complete in a separate lunch box. I should mention that "a grocery store in your home" also saves a surprising amount of shopping time.

The electric mixer with all its parts is another wonderful aid to better and speedier cooking. Besides whipping up cakes, milk shakes, cream and meringues, the mixer can be used to squeeze oranges, grind coffee, peel potatoes and shell peas and beans.

The pressure cooker is a splendid contrivance. Ed discovered ours at the N. Y. World's Fair and considered it the most wonderful thing at the whole fair. The actual cooking time for a stew is just 15 minutes!

b) *Dishwashing.* The electric dish-

washer not only saves labor but also time because you store the dishes in the washer and run the machine once a day. But if you don't have a dishwasher, you can approach this chore somewhat as if you did have the appliance. In other words, washing the dishes after each meal is another one of those silly standards we have set up for ourselves. If you rinse the dishes, stack them, wash them once or twice a day, rinse with boiling water and towel-dry only the silver, you will save yourself almost as much time as the machine can save.

c) *House cleaning.* The vacuum cleaner can often be used to good advantage on the floors themselves and for more of the dusting jobs. However, cleaning can chiefly be simplified by the furnishings you choose and your own good management.

d) *Washing And Ironing Clothes.* Of course, we all know that washing is being reduced to the minimum by certain types of machines which wash, rinse, and even dry for you. As for ironing if you hang flat things like sheets and towels very smooth and straight, there's really no reason for ironing them at all. I have heard any number of men and women say they loved to sleep between sheets fresh from the country-scented breezes. Such clothing as seersucker dresses and cotton knit shirts also need no ironing (or the very slightest touch) if they are hung carefully on the line. Those fabrics which insist on being ironed (and how many we can do without!) should be taken down while damp to save the sprinkling job. Notice how your ironing depends on your washing routine and both depend even more on how you shop. As one clever homesteader wife in Ohio wrote, "I begin my ironing when I do my shopping"



All in all I've found that housekeeping in the country can be run a little more like a business. Each housewife, as an executive (when the Boss is away) will want to do her own planning, adapting the schedule to the weather vane—whether there are raspberries just ready to pick or whether it's high time for a relaxing swim.

The women I've met who are interested in homesteading in the modern way are smart—they know that they will have a big job to do.

But they also know the rewards are tremendous.

Homestead Mechanics



WHEN we lived in a city apartment we didn't even want to know how to fix a dripping faucet or repair a sagging door or paint our storm windows.

It's different when you have a place in the country of your own—you want to learn how to maintain your homestead. You also want to utilize all the labor-saving equipment that is practical. It doesn't seem right not to understand the workings of machines and devices we have to depend on every single day. And what a difference between the resentment you sometimes feel when you have to pay big repair bills and the feeling of real satisfaction you get from making repairs yourself. Even if you've never done more than stand by and watch a carpenter or a painter or a plumber at work there are a few simple repair jobs you can learn to do that will mean a big cash saving and a very pleasant form of recreation. Of course some jobs are frankly annoying, but I do think many are relaxing and fun to do. On days when other things don't go just right you come home from work mentally tired. Then your workshop can be a welcome refuge and little constructive jobs you do will reward you with a sense of accomplishment.

One morning last February the sink in our kitchen refused to drain properly and when I tried to clear it with the rubber plunger the water only backed up more. Finally, I sent for the plumber and after looking over the situation he dug to our septic tank and removed the lid. By this time I felt pretty helpless because I knew so little about plumbing and hadn't properly understood the trouble at first. This sense of helplessness is something that repair people are quick to notice. It is their cue to be mysterious about whatever repairs are needed and to encourage you to feel more helpless and more completely dependent on their superior knowledge. But I asked the plumber a few questions and he finally broke down and told me that the trouble was simply a blockage of the pipe and that I could

have saved about \$25 if I had known enough to prevent it!

Insurance underwriters say the majority of all accidents occur at home—accidents that can often be prevented just by replacing a loose board or repairing an electric fixture, or attending to the furnace properly. For this reason alone it's more than worthwhile to learn a few practical fundamentals of painting, carpentry, masonry, plumbing, electricity and last, but not least, simple auto maintenance.

Painting

The outside of a building is best painted at least once every four years. This is because wood deteriorates rapidly when there is no paint to protect it from moisture. The hardest work in painting usually is scraping off the old

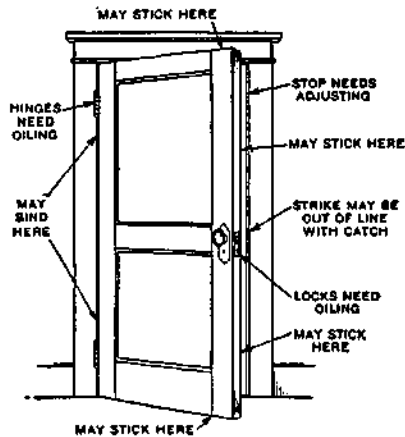

9 ways a door can go wrong

paint. Correct use of paint remover, wire brush, steel wool, or a scraper can often save you hours of needless work. You should learn how to store brushes properly and also the best method of storing paint for safety from fire. The difference between flat paint, enamel, varnish, wall sizing, and water paints is basic knowledge for every homesteader. For your kitchen there is a new 25% DDT water-based paint which can be sprayed or brushed on. It is said to kill flies and insects that walk or alight on it. An application remains effective 2 to 3 months inside and 2 to 3 weeks outside.

Carpentry

If you like making things out of wood the first thing to make is a good workshop for your homestead. So many workshops I've seen are located in attics or cellars or barns where it's nearly always too cold or too hot or too damp or too dark to work. The workshop is worth the same consideration and planning as your kitchen. If it must be in the attic or cellar it should be properly heated, insulated and lighted. Once you have a good workshop you can make it pay for itself many times just

by doing simple repairing or building. I never did any building until we put up our small barn. Since then I've watched a neighbor put up an entire two-story house single-handed. He says the amount of knowledge needed to build a small house is surprisingly little if you have a good set of plans. A carpenter earns about \$15 a day, and by doing your own carpentry you can save that much while you yourself learn to master the fundamentals. Here is a check list of ten fundamentals in carpentry. See how many you know already:

1. How to lay shingles.
2. How to use the steel square.
3. How to file and set saws.
4. How to use the chalk line.
5. How to use a mitre box.
6. How to set girders and sills.
7. How to make joints.
8. How to hang doors.
9. How to lath.
10. How to lay floors.

Masonry

One of the "trickiest" masonry jobs is supposed to be building a fireplace and chimney. But two high school boys I know apparently never heard how tricky it is because they built a fireplace out of fieldstone in a little house on Owasco Lake near Auburn, N. Y. and put up a 20-foot brick chimney. They dug and laid the concrete foundations, installed the damper, the flue, and put in fireproof bricks where required for proper fire protection. I admit they had some help — they had a ten minute conversation with a mason and read about three books! I haven't ever built a fireplace myself—about all the masonry I've done so far is to put in a cement floor in our small barn and pig pen. It's really worthwhile learning how to mix and pour concrete and lay foundations — you'll use it again



Why not paint your own house? Anyone can do a good job who is willing to read up on all the little tricks of the trade. Paint prolongs the life, increases value. If you do your own you can save up to 90%.

and again. If your cellar is damp, look into the new damp-proofing paint. It's a white powder you mix with water and scrub into the concrete or brick. The tiny particles penetrate and then expand which is said to work wonders in waterproofing masonry. It was developed by the French for waterproofing the Maginot line and is now being manufactured in this country for general use under the name, *Aquella*.

Plumbing

Once you've learned how to repack a dripping faucet and replace a washer and clean out a trap below the sink or basin you know the three most common plumbing repairs a house needs. From there you can easily go on and learn how to install running water in your barn, or put in a modern hot water system, or an extra shower. Even if you don't want to do any plumbing work yourself I do think it is necessary to understand the operation of plumbing systems just for your own self-protection. Some people actually believe that pouring coffee grounds down the sink drain helps keep it cleaned out! You probably know others who think nothing of pouring hot grease down the sink or piling the drain full of lye indiscriminately. These people would never have a quarter of the plumbing repairs they have now if they had a better understanding of preventive maintenance.

Electricity

Maybe you already know enough about electricity but what about your wife? So many fires are started by wives who don't understand the electrical appliances they use quite well enough for their own safety! Here is a little quiz in electrical safety facts every wife should know:

1. What is the difference between a volt, an ampere, and a watt?
2. What causes a fuse to blow?
3. Is it safe practice to replace a 20 amp. fuse with a 15 amp. fuse?
4. Is it safe practice to replace a 20 amp. fuse with a penny?
5. It doesn't matter if the insulation on a lamp cord is worn bare so long as the lamp is kept turned off?
6. Why is it dangerous to turn on any electrical appliance while you are touching a water pipe or have wet hands?
7. Is it dangerous to replace fuses while the floor beneath the fuse box is wet?
8. About how much current does a washing machine use compared to a toaster?
9. Why is it inadvisable to use a toaster, an electric heater, and a curling iron all at once?
10. Is it possible to get a fatal shock from a 110 volt socket?

Any woman who can answer all the above questions satisfactorily is pretty

A Good Layout for a Home Workshop

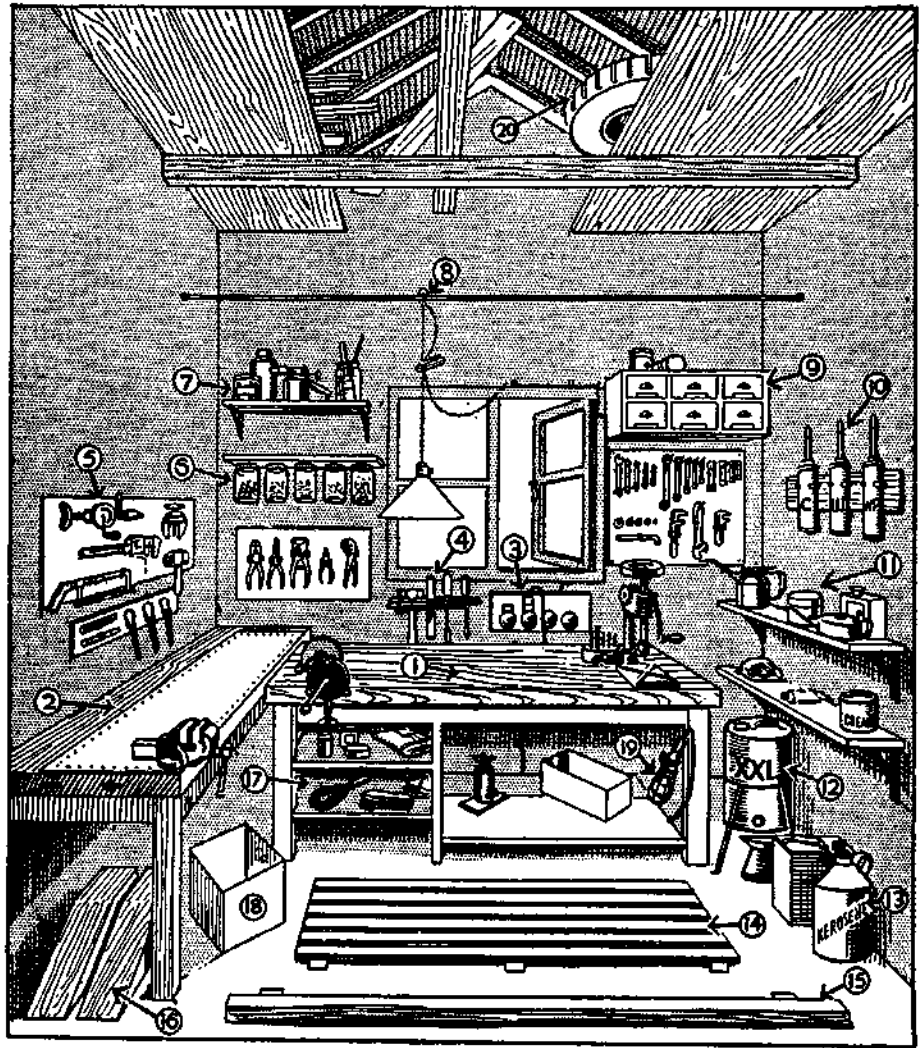

- 1.) Bench for light work.
- 2.) Bench for heavy work—sheet iron protects top.
- 3.) Electric outlets and switches.
- 4.) Small tool rack made from two converging laths, spaced $1\frac{1}{2}$ in. apart at one end and $\frac{1}{2}$ in. at the other.
- 5.) Rack for heavy tools.
- 6.) Screw-topped jars for nuts and bolts.
- 7.) Shell for painting materials.
- 8.) Trolley for light—clothespin adjuster cord length.
- 9.) Drawer for small parts.
- 10.) Three grease pumps; one for Universal joints, one for water pump, one for

- chassis bearings.
- 11.) Lubrication equipment.
- 12.) Five or ten-gallon oil drum on stand.
- 13.) Gasoline and kerosene, kept in different shaped cans to prevent error.
- 14.) Wooden platform protects feet from cold.
- 15.) Stop for front wheels of car.
- 16.) Ramps on which front or rear wheels can be run to facilitate greasing, etc.
- 17.) Shelf for washing and cleaning materials.
- 18.) Rubbish box.
- 19.) Inspection lamps.
- 20.) Storage in rafters for timber, tires, etc.

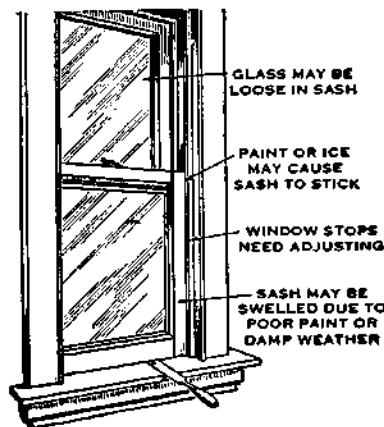

Common window troubles.

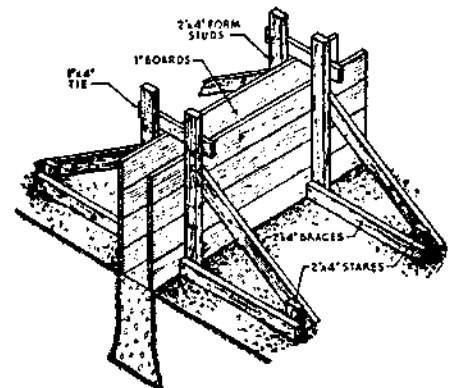

Foundation walls above grade may be formed in this manner where earth walls of the trench stand straight and true, and where a wide footing is not required.

Earning Money In The Country

MAYBE you'd like to move your job to the country? Maybe, as it happened to us and as has happened to many others, you'll find you enjoy living in the country so much you'll come to realize you'd like to *work* in the country as well as *live* there.

Perhaps if you now live or work in a big city you'll say to yourself, "But how can I earn a living in the country—I'm no farmer!"



Don't let that bother you. You may not have realized it, but most of the people who live in the country aren't farmers any more. Look at the figures:

1. According to the latest census, the farm population is 30 million.
2. The non-farm population in towns or small cities under 25,000 is 49 million.
3. In towns as small as 2,500 or less there live over 27 million non-farmers.

What's perhaps even more significant, the Census shows that while the farm population stayed at 30 million between 1930 and 1940, the non-farm population in towns of 25,000 or less increased by 5,329,432—an increase of 12%, a percentage increase nearly double that of the country as a whole!

Never before in our nation's history has there been such wonderful opportunity to earn a good living in the country as there is today. Two momentous events are taking place: cities are spreading out . . . small towns are growing. In this trend to decentralization lies the new American frontier of opportunity.

Take Your City Skill To The Country

The great movement away from the cities has been going on steadily ever since the automobiles became cheap enough for millions to own. This move is easy to see. Look at your own city or town. Aren't the better class new homes being built further away from the center of the city? Even 10 or more miles outside the city proper? Notice what this is doing to business. See the new community shopping centers . . . the so-called "service" industries are following the people.

More people are engaged in the "ser-

vice" industries than in manufacturing or farming. If you now are working in a "service" industry, you'll find—if you'll look into the matter—that there is untold opportunity in the rural service field. Remember, one advantage the city man moving to the country has over the country man is his more developed skill at earning a cash income.

If you're in one of the many "service" industries in the city, is there a need for your particular service in the country? Listed below is a group of services already being supplied by people in a town of 13,188 people. These are not *imagined* businesses—they're taken right out of the classified phone book for the town of Emporia, Kansas.

Abstractors
Accountants -
Adding Machines
Advertising
Airports
Ambulance Service
Architects
Attorneys
Auditors
Automobile Agencies
Automobile Repairing
Automobile Equipment
Automobile Graveyards
Awnings
Bakers -
Barbers
Batteries
Beauty Culture Schools
Beauty Shops
Beverages -
Bonds
Books -
Bottlers -
Bowling Alleys
Broadcasting Stations
Brokers, Investment
Building & Loan Assn.
Building Materials
Butane Gas
Butchers -
Cafes
Carpenters
Carpet Cleaning
Cemeteries
Chairs, Renting
Cheese
Chinaware
Chiropractors
City Offices
Cleaners
Clothing
Clubs, Country
Clubs, Night
Clubs, Social
Coal
Concrete Products
Confectioners -
Contractors
Credit Reporting Bureaus
Dairies -
Dairy Products -
Dead Animal Removers
Dentists
Department Stores
Doctors
Draperies
Drayage
Druggists

Dry Goods
Electric Appliances, Household
Electric Appliances, Repairing -
Electricians
Elevators, Grain
Exterminators, Termite
Farm Implements
Feed
Filling Stations -
Film Developing
Films
Fire Insurance
Five & Ten Cent Stores -
Floor Machines, Renting
Florists
Freight Truck Lines
Fruits Retail -
Funeral Directors
Furnaces
Furniture -
Furniture Repairing -
Garages -
General Merchandise
Gift Shops
Glass, Plate
Grain
Greenhouses -
Hardware
Hatcheries, Poultry -
Hats, Cleaning
Heating Contractors
Hemstitching
Hotels
Ice Cream -
Ice Cream Manufacturers -
Implement
Insulation Applicators
Insulation Materials
Insurance
Investments
Jewelers
Junk
Laboratories, Medical
Ladies Ready-to-Wear
Laundries
Linoleum
Live Stock Commission Companies
Loans
Lumber -
Lunch Rooms -
Machine Shops
Machinery Contractors
Mens Furnishings
Millinery
Monuments

Motor Trucks
Motor Repairing
Movers
Newspapers
Oil Marketers
Optometrists
Osteopathic Physicians
Packing Houses
Paint
Pharmaceutical
Photo Finishers
Photographers
Physical Therapy Technicians
Physicians & Surgeons
Pies -
Pipe
Plumbers
Pop Corn -
Poultry -
Printers
Produce -
Publishers
Radio Broadcasting Stations
Radio Service
Radios
Ranges, Gas
Real Estate
Refrigeration Equipment
Refrigerators, Serviced
Rendering Plants
Restaurants
Roofers
Rug Cleaning -
Rugs

Salvage, Automobile
Seeds -
Service Stations
Sewing Machines
Sheet Metal Work
Shoe Repairers
Skating Rinks
Storage -
Tailors
Taxicabs
Tea Rooms
Tents
Termite Control
Theatres, Open Air
Tourist Courts
Towing, Automobile Tractors
Transfer, Baggage
Truck Lines
Trucks, Motor
Undertakers
Upholstering
Venetian Blinds
Veterinarians
Vulcanizing
Wall Paper
Wall Paper Removing
Warehouses, Merchandise
Washing Machines
Washing Machines, Repairing
Watches, Repairing
Welding
Wrecker Service, Automobile

If you want to live in a smaller town and you find that the population is so small that the region can't support a full-time taxi service, for example, maybe you can combine your taxi service with an ambulance service, undertaking service, a car rental service and a delivery service.

Or you might combine a bookstore, newsstand, stationery store, mimeograph service, photostat service, local employment service, house rental service and travel information. Just a country store often supplies everything from shoes to meat—you can add up services until you're making the cash income you need.

Big Business Discovers The Country

You don't necessarily have to have a business of your own to work and live in the country. Big business is on the move—and you'll find new country job opportunities increasing all the time.



The largest aluminum producer in the world, at Alcoa, Tennessee, is in a town of 5,000

—and it isn't a suburb of a city either. The Sylvania Electric Company, one

of the largest manufacturers of lamps has found that the location of its factories in smaller towns has resulted in increased efficiency.

Ford-Ferguson and John Deere, both makers of farm equipment, have found that by locating plants in the midst of farm country instead of the heart of a big city many advantages accrue.

General Motors and General Electric both have planned programs for decentralizing. So too has International Business Machines. In fact, the atomic bomb has given decentralization such impetus that there's no telling what's going to happen.

The war showed that big business could profitably sub-contract to the small manufacturer. For example, Pratt & Whitney are said to have issued over 18,000 separate sub-contracts.

Homer Hoyt, Director of Economic Studies of the New York Regional Plan Ass'n. has pointed out some of the disabilities of the large city industry. He writes in *Civil Engineering* for August 1945:

"It is now a question not of how fast our cities will grow, but of whether they will grow at all . . . The very great advantages of New York's site have led to a higher standard of living than obtained in the Nation as a whole, and the highest cost of municipal services, which have tended to increase overhead costs of doing business and also labor rates. The congestion of a large population has likewise increased costs by the friction of traffic congestion in central areas, by the cost of subways and express highways to transport so great a population from places of work to residences, and by the extra expense of going great distances to secure an adequate water supply. In addition, in a city which has long enjoyed such great natural advantages, it was possible to succeed, even with some relatively inefficient methods on the part of labor and capital. In so rich a market, high charges could be levied for certain services, make-work policies could be adopted, and still the market would bear the burden.

for human beings. Gardens and small farms may give the security and the health which are lacking within the city walls. Fresh air and sunshine come once more within reach. In the future, large cities with high population density will no longer be needed. As production methods advance, it will be increasingly possible for production plants to divide into small units and be dispersed over a wide area, perhaps the entire country. Production would then become not only less expensive but also more efficient, for manufacture in the large city has come to be increasingly uneconomical and wasteful of energy and time."



Summing up these trends, Arthur E. Morgan in the excellent book "A Business Of My Own" says:

"For a long time the railroad and steam power favored centralization. Today the big city with its congestion, inefficiency, insecurity, and high cost, is a less favorable environment, while good highways, electric power, small unit machinery, and other conveniences, have greatly improved the status of the small community. In the eastern part of our country many industrial units are leaving the cities for small town locations, sometimes hundreds of miles distant."

If You Decide to Move Your Job

From the many letters we receive from folks who say, "I want a homestead like yours—and I want to work nearby so I don't have to waste any more time than necessary getting back and forth to work," we know that there is great interest in *working* as well as *living* in the country.

The fact that moving your job and setting up a homestead are both major tasks doesn't in the least effect the validity of either. But unless you're well fixed for an income to tide you over the transition period, it would be smart not to move your job and start a homestead at the same time. I don't believe it makes any difference which you do first. If you keep your present job and get your homestead all set up and running and perhaps paid for, then you'll have learned a good deal about business opportunities in your section. If on the other hand, you don't like your present job and want to find another in the country, then in getting your country job under control, you'll have

learned enough about the country to find a good site for a homestead.

And while you're riding through the country keep your eyes open for all the road signs put up by people operating little businesses of their own.

Of course, you're aware of lots of tourist camps, wayside markets, filling stations, and real estate agents. But also notice the less conspicuous signs,—the country lawyer, country doctor, country sign painter, the country tailor, the country radio repair man, the country beauty shop, the plumber, the upholsterer, the photographer. The small manufacturing plant, the craftsmen—and so on.

Often these people operate right from their own homes—and their places have enough land so they can really live. Enough so they can have a garden, fruits, berries, chickens—maybe a family cow.

There are just millions of folks in the country who've found out how to combine making a cash income with the home production of food.



A reference library can be most useful and important.

We have heard it said that "you can't learn to do this and that out of a book." However, judging from our own experience, we don't think this is strictly true. Here at our place we've got what you might call a reference library, with books and pamphlets on all sorts of subjects, and hardly a week goes by but what we "look up" how to do quite a lot of things.

We believe that every family who has a homestead should have a reference library—just the way all good cooks have cook books. You don't need a whole room full of books. You can get along with relatively few, if you choose them wisely.



"As cities grow older, traditional and customary practices which tend to impair efficiency become embedded in their economic structure."

Another expression of the trend toward decentralization is that of L. Hilberseimer in his book *The New City* (1944):

"Resettlement in the country as the exodus from the city gather momentum has obvious and far-reaching benefits



LET'S REBUILD AMERICA . . .

FROM the day the automobile was invented there has been an ever increasing movement of families to the countryside surrounding the cities. In these post-war years this trend may become almost a stampede.

We Robinsons are only one family out of hundreds of thousands who have discovered how practical it is to hold a job in town and to go daily to it from a home and an acre or so of land.

The only thing different about us is that we wrote the "Have-More" Plan about this way of living which has meant so much to us in security, health and happiness. We wanted to tell other families about our experiences so that they could profit by what we'd learned and thus succeed more quickly at setting up homesteads of their own.

The response we've had to our "Have-More" Plan has made us very happy but it has almost snowed us under at times. Not only have we had thousands of letters from other families telling us of their plans and asking advice—but we've heard from scores of manufacturers, real estate people, insurance companies, magazine and newspaper editors, and so on.

Here are just a few examples:

Soon after the "Have-More" Plan was published, *Better Homes and Gardens Magazine* asked us to write an article for them, with pictures, about our place. *The Reader's Digest* reprinted it. Then many other magazines and newspapers ran stories about the "Have-More" Plan. We were interviewed on the radio a number of times.

Real estate firms from all over the country write to us continually about their plans for dividing land into acreage plots instead of 50 foot lots as they might have done a few years ago.

Architects and builders have told us they are going to offer homes especially designed for country living.

One of the biggest insurance companies has asked our advice in developing a special low-cost, long-term

mortgage financing plan for families who want to have homesteads.

The Macmillan Company of New York has asked us to edit a whole series of books on the subjects people need to know about to succeed at homesteading.

The men in the services showed so much interest in the "Have-More" Plan that the Army bought a special printing of 55,000 copies for libraries.

We have talked to dozens of business men and have read about scores of others, including some of the biggest in the country, who are planning to move their offices and factories out of the cities so that their employees can enjoy the advantages that go with the ownership of a home and a little land.

In other words, it has sometimes looked to us as though just about everybody in the cities of America wants to move out to the countryside to live and to work!

And why not? Why wouldn't that be a good idea? Why shouldn't we set ourselves that goal—to rebuild our country in the next twenty or thirty years so that every family that wants to can own its home and a little land?

It is entirely practical for us to do so. We certainly have the productive capacity to build a whole new highway system, to move many factories away from the crowded cities, to build the millions of new homes, the equipment and furnishings that would go in them!

There was a time when a factory had to be located near water or rail transportation. Nearness to raw materials, nearness to markets, nearness to what was called a "labor supply" were the important considerations. Hardly anybody thought about whether the location chosen would be one where the workers in the factory would enjoy living.

Today, only four out of ten families in this country own their homes. In the big cities only one out of four families owns its home. Move factories away from the big cities, give people access to lower priced land, give them half a chance to own their homes, and the ratio may be reversed. How much sounder—how much better governed—would this country be if six instead of four families out of ten owned their homes—if the sense of responsibility, the interest in public affairs, the pride and independence that go with the ownership of property were theirs?

America needs a goal. It needs something tangible to work toward. Look what this nation has accomplished when it had a clear-cut job to do—like winning a war or opening the West.

For the sake of national security itself, remembering the atom bomb; for the welfare and happiness of every family; for the sake of having a big, worthwhile job to do—so that we can unite in doing it instead of quarrelling with each other—let's rebuild America so every family that wants to can own a home and a little land!

Basic Seed Saving

from Seeds of Diversity Canada

Seed saving is the simple act of helping plants to do what they do naturally: grow seeds and reproduce. When you grow your own seeds, you can grow your favourite varieties every year without buying them. You can maintain your own supply of unusual, or hard-to-find seeds. You can even try your hand at breeding your own new varieties! It's fun and it's easy. **The plants do all the work.**

People have been saving seeds for about 10,000 years. Long before there were any seed companies, long before professional seed-growers existed, ordinary people grew seeds for their own vegetables, grains, fruit, and flowers. There are many people alive today who can remember when most Canadian farmers and gardeners saved their own seeds as an ordinary part of their fall routine. They weren't experts in genetics, or university graduates in biology, but they knew a few simple things about plants. You can learn them here, and grow your own seeds too.

There are four main aspects of good seed saving:

- 1) Choosing varieties to meet your expectations
- 2) Controlling pollination
- 3) Selecting the most desirable seeds at harvest
- 4) Cleaning and storage

Choosing Varieties

Seed catalogues usually distinguish two general types of plants: **hybrid** and **open-pollinated**.

In typical garden vegetables, an **open-pollinated** plant variety is a "true" or "purebred" variety. Both of its parents were the same variety, and all of its offspring will be the same too. Since every generation is identical to the generation before it, you can collect and replant their seeds over and over for many years and still have the same variety.

In some crop species, notably ornamentals and grains such as corn or rye, **open-pollinated** often means that the variety is a mixture of many slightly different plants. For instance, open-pollinated annual flowers can simply be a mixture of colours. Open-pollinated corn varieties such as Golden Bantam frequently have some variation from one plant to the next. Even though the plants are not exactly uniform, they are considered to be all part of the same variety.

A **hybrid** variety is a crossbreed. Its parents were different varieties and it is a combination of the two. A combination of two different open-pollinated varieties is called an **F1 hybrid**. A combination of two hybrids is called an **F2 hybrid**. F1 hybrids are known for being very uniform (each plant is exactly like the others), partly because of the pollination control that is needed to create them. Some hybrids show greater vigour than open-pollinated varieties of the same species. This "hybrid vigour" is especially evident in grasses and cross-pollinating species, but less strong in species such as beans and tomatoes that normally self-pollinate.

There is a problem with saving seeds from hybrid plants. Since their genes are a combination of their parents' genes, their offspring will receive a mixture of an already mixed bag. A seed collected from a hybrid plant might produce a plant similar to the hybrid, or it might resemble one of the hybrid's original parents, or it might be an altogether new combination. To make matters even more unpredictable, two seeds from the same hybrid fruit will not necessarily contain the same combination of genes, so will not necessarily grow up the same.

Controlling Pollination

If two non-identical plants cross-pollinate (one is fertilized by pollen from the other), the seeds will be hybrids. They will consist of some combination of the two parent plants. Sometimes this is alright. For example, if you have a bed of mixed annual flowers and you plan to save some of the seeds to plant another mixed bed next year, it doesn't matter if the flowers cross-pollinate. The colours are already mixed anyway.

There are times when you want to prevent cross-pollination. Say you have two favourite varieties of tomato, one orange and one red. You want to replant the same two every year, so you want to keep each variety pure. Another example might be an heirloom bean variety that you want to keep pure, since you can't buy it from any seed company.

Cross-pollination can be prevented by:

- 1) Separating different varieties by enough distance so that pollen, or insects carrying pollen, can't travel between them.
- 2) Making a physical barrier to prevent insects from carrying pollen from one plant to another.

First you have to look at the anatomy of the flowers. There are three basic types of flowers:

- 1) Complete, self-pollinating
 - e.g. tomato, bean, pea, lettuce, wheat, barley
 - each flower has both male and female parts close together. Petals are tightly closed to keep insects out. These flowers almost always pollinate themselves, automatically preventing cross-pollination. In some cases (about 1 out of 20) a determined insect can crawl inside and cross-pollinate the flower, so a short isolation distance is still recommended.
- 2) Complete, cross-pollinating
 - e.g. petunias, onions, hollyhocks, rye
 - each flower has both male and female parts, but they are far apart and the flower is open, allowing insects in easily. These flowers are generally able to self-pollinate, and sometimes do, but they are cross-pollinated by insects just as often. Large isolation distances or insect barriers are required to prevent cross-pollination.
- 3) Incomplete, cross-pollinating
 - e.g. melons, cucumbers, corn
 - each flower is either male or female. Pollen must be carried from a male flower to a female flower for fruit and seeds to be produced. Large isolation distances or insect barriers are required to ensure that pollen comes from plants of the same variety as the female flowers.

Self-pollinating flowers are tightly closed, so insects and wind-blown pollen can't get in easily. They are also **complete** with both male and female parts in every flower. They (almost) always pollinate themselves, making it easy to keep varieties pure. In fact, it's fairly difficult to make hybrids of self-pollinating species.

In some rare cases, these plants can cross-pollinate over short distances. Pollen can drift for a few feet from any plant, further if the pollen is light and dusty, or an insect can sometimes push its way into a tightly-closed flower. We recommend that different varieties of self-pollinating plants should be separated by at least 10-15 feet in the garden, but the further the better to ensure that they remain pure.

Note that if two identical plants cross-pollinate, it has the same result as self-pollination.

Cross-pollinating flowers are open, allowing wind and insects to transfer pollen to any plant within several hundred feet. Most cross-pollinating garden plants have heavy, sticky pollen so they need insects such as bees to carry it. Since bees can travel up to a quarter of a mile from their hive, it is usually recommended to keep different varieties of these plants separated by a quarter of a mile to prevent them from crossing. Other plants have fine, dusty pollen which is carried by wind. Spinach, beet and grains such as corn and rye are among these. They must be separated by a greater distance of a mile or more.

Incomplete flowers are always the cross-pollinating kind. The name means that each flower is either male or female, but never both. Squash, cucumber, melon, corn, and spinach are examples. Pollen is not only able to move freely, by wind or insects, the plant requires something to move pollen from the males to the females. Without insects, no fruit would set on these flowers and no seeds would be produced. The best way to control pollination of these varieties is to learn the difference between the flowers and to hand-pollinate them.

Insect barriers are easy to make with spun-polyester row cover material, old nylons, paper or fine cloth. Cover a few flowers or entire plants, preventing insects from reaching the flowers. Don't use plastic film to cover plants, since it will trap heat from the sun and fry them! If the flowers are self-pollinating, they will pollinate inside the bag and the seeds will be purebred. If the flowers are incomplete, they will need help to transfer their pollen.

Usually, plants will only cross with other plants of the same species. For instance, different kinds of squash can cross with each other, but they cannot cross with cucumbers. However, some species are related closely enough that they can pollinate each other. For example, broccoli and certain kinds of wild mustard can cross-pollinate, producing an inedible hybrid. Lettuce can cross with its wild cousin, so learn to identify wild lettuce if you want to grow lettuce seed. Radishes can cross with mustard and chinese cabbage. If in doubt, consult a seed-saving book. These relationships are well-known and documented.

Selecting Seeds

Seeds must be allowed to ripen fully on the plant or they will not germinate. It's important to know at what stage the seeds are ripe. Flower seed heads are usually only ripe when they turn brown and dry. Fleshy fruit such as tomatoes and cucumbers should generally be very ripe, or even over-ripe before they are picked for seed-saving.

Although green tomatoes turn red and soft after they are picked, they do not continue to grow and develop. Immature seeds cannot mature unless the fruit is fed from the vine. Shelf-ripened tomatoes don't have true vine-ripened flavour, nutrition and may not have viable seeds.

If you aren't sure what your mature seeds will look like, keep a few seeds back in the spring. Then you can compare them to the ripening seeds. Compare size, colour and especially plumpness.

Collect seeds from the plants that are most like the plants that you want to have in future years. If you are trying to preserve an heirloom variety, choose seeds from many plants to maintain the natural diversity of characteristics. For example, some varieties of beans have natural variations in colour within their population. Some of each colour must be saved to preserve the variety completely.

If you want to try to create your own new variety, collect seeds from the plants that are closest to your ideal. For example, you might collect seed from the first tomato to ripen each year. Theoretically, you should be able to select early-ripening genes this way and eventually all of the resulting tomato plants should bear fruit a little earlier. Another example is to collect seeds from your favourite colours of a mixed planting of annual flowers. Cross-pollination may make this difficult, but every year that you repeat this you should get a higher proportion of that colour in your own special mix.

Choose seeds from plants that are free from disease since some disease organisms can survive on the seed surface and re-infect the whole planting next year. Seeds that are lumpy, mouldy or discoloured should not be kept for seed, unless absolutely necessary.

Cleaning

Seeds that are dry when collected (such as most flower seeds) should be freed from chaff and bits of the flower, which can harbour fungus spores, and should be stored in paper envelopes. Seeds from fleshy fruit such as tomatoes and cucumbers need to be cleaned well. These seeds are surrounded by a jelly-like substance that should be removed before storage. This seed jelly is meant to inhibit germination so that the seed does not sprout in the fall when the fruit drops. In nature, the jelly would rot during the late fall, and by the time the seed had been exposed, it would be too cold for it to sprout until spring.

To remove the seed jelly, simply scrub the seeds with your fingers or a towel. If you are saving a large number of seeds, you can use a method called "fermentation". Seed companies which grow and package many thousands of seeds cannot scrub them all with towels, so they use this simple, though disgusting, method. Place the seed pulp in a closed container and keep it in a warm place for 3 or 4 days. Don't let it dry out, but don't add water unless you have to. Soon, mould will cover the surface of the pulp and the jelly will rot, creating a delightful aroma. Holding your nose with one hand, strain the pulp through a sieve with lots of water and the seeds should come out clean. While the seeds are being rinsed, see if any of them float. Especially with tomato, cucumber and melon seeds, if they sink they're good; if they float, they're duds.

Storage

The best conditions for storing seed are, not surprisingly, the opposite of the conditions required for germination. Seeds germinate best in warm, moist conditions and store best in cold, dry conditions. Most seeds can remain viable for a few years in paper envelopes in dry air at room temperature. You can extend their lifetime considerably by keeping them cold in a refrigerator.

Inside every seed is a tiny plant embryo that lives by "eating" a stored quantity of starch. When the food runs out, the embryo dies and the seed will not germinate. The way to keep a seed alive for a long time is to slow down its metabolism. The lower the temperature and humidity, the slower the seed consumes its food.

A simple rule of thumb is that the sum of the temperature in degrees Fahrenheit and the percent relative humidity should be less than 100.

Temperature (degrees F) + Relative Humidity (%) < 100

More or less, for every 10 degrees that the temperature is reduced, seeds will live for twice as long. Humidity is very bad for seeds. If they absorb moisture, even from the air, they start to prepare for germination, and use up a lot of their stored food. **Never** store seeds in a humid greenhouse, a damp basement or garage, a laundry room, or a growing area where there are plants evaporating water into the air.

Seeds should be well-dried before they are put into storage. Open air drying is easiest. There are a few simple methods for testing seed dryness.

- * The hammer test: hit one of your seeds with a hammer. If it shatters, it's well-dried. If it just mashes, it needs to be dried further. (or rather, the others do)
- * The al dente test: a well-dried bean or pea should feel hard when you bite on it. If you can easily make tooth marks, it needs to be dried further.

If air-drying doesn't work, for instance if the air is too wet in your area, you can dry seeds in a food dehydrator or a slightly-warm oven, but avoid temperatures over 95F, since the seeds can be damaged by too much heat. Seeds do need a little moisture to stay alive, so don't try to make them dryer than they would naturally become in the open air.

Paper envelopes allow moisture to escape, preventing deadly condensation. Seeds can also be stored in jars, but it is a good idea to put a little silica gel in the jar too, to absorb excess moisture. Silica gel can be purchased at most craft

stores (it's used for drying flowers) for about \$10/kg. Most brands contain a few indicator crystals which turn blue when the gel has absorbed a certain amount of moisture. Heating the gel in an oven at about 200F dries it out again

A good system is to store your year-to-year seeds in paper envelopes in a cool, and especially dry place. Keep long-term backups in tightly-sealed glass jars in a consistently cool or cold place (humidity in your basement doesn't matter if the jars are well sealed). Note that plastic allows more moisture through than you might think – use glass jars. If you really want to keep seeds for a long time, you can jar them as above, and store them in a freezer. As long as they are well-dried, they will keep for many years. Frozen seeds should be kept in well-sealed jars, since the freezer can over-dry them, similar to freezer-burn, and fatally dehydrate the seed.

Isolation Distances and Seed Viability

The statistics on the following page are typical of those found in seed-saving books. They are provided as a guideline only, since there can be a lot of variation from garden to garden. Your own experience is the best teacher.

Isolation distance for bee-pollinated plants really means "how far will a bee travel while collecting pollen and nectar?" The actual distance depends a lot on the geography of the area, the types and quantities of flowers available and the distance from the hive. A guideline of 1/4 mile is usually given for these plants, but the actual required distance can be anywhere from 100 feet to 1/2 mile.

Isolation distance for wind-pollinated plants really means "how far do the plants have to be separated so that there is an 'acceptably small' chance of pollen being blown from one to the other?" Again, the actual distance depends on the usual direction of the wind, nearby wind blocks such as trees and fences, the weight of the pollen, humidity, and the amount of pollen being produced in your planting. One or two miles is often recommended, but as little as 1000 feet is sometimes enough, especially for large plantings.

Seed viability, or "shelf life" varies greatly with temperature and humidity. The figures given below are typical for seeds stored in a dry, cool place such as a dry cellar (or a humid cellar with the seeds in dry jars). Seeds stored at room temperature, but still dry, will usually last about half as long. Seeds stored in a humid location can lose their viability within a few months to a year.

A germination test can be helpful if you want to know how good your seeds are. Sprout 10 or 20 seeds in a small pot of potting soil or vermiculite, or wrap them in a paper towel and keep them moist in a warm place (wrapped in plastic on top of the fridge is good). In a week or two, some of the seeds should sprout. If less than ¼ of them do, you should consider regrowing them. If fewer than half of the seeds sprout, the rest of the batch is probably close to dying; time to plant them and collect fresh seeds.

The isolation requirements below are taken from How to Save Your Own Vegetable Seeds, by Seeds of Diversity Canada.

The seed storage statistics are typical for seeds stored in a dry, cool place.

	distance	shelf life(yrs)			distance	shelf life(yrs)	
		avg	max			avg	max
Angelica		1	3	Marjoram		3	7
Asparagus		5	8	Melon, Musk	1/4 mile	5	10+
Basil		8	10+	" , Water	1/4 mile	6	10+
Bean	15-20 ft	6	10+	Mustard	1/4 mile		
" , Kidney	15-20 ft	3	8	Nasturtium		5	8
" , Lima	1 mile			Okra	1 mile	5	10+
" , Runner	1/2 mile			Onion	1/4 mile	2	7
" , Soy	10 ft	2	6	Parsnip	1/4 mile	2	4
Beet	1/4 mile	6	10+	Parsley		3	9
Borage		8	10+	Peas	15-50 ft	3	8
Broccoli	1/4 mile	5	10	Peanut		1	1
Brussels Sprouts				Pepper	500 ft	4	7
	1/4 mile			Pumpkin	1/4 mile		
Cabbage	1/4 mile	5	10	Radish	1/4 mile	5	10+
" , Chinese	1/4 mile			Rhubarb		3	8
Calendula		3	7	Rosemary		4	?
Carrot	1/4 mile	4	10+	Rutabaga	1/4 mile		
Catnip		5	6	Sage		3	7
Cauliflower	1/4 mile			Salad Burnet		3	9
Celeriac	1/4 mile			Salsify	1/4 mile	2	8
Celery	1/4 mile	8	10+	Savory		3	7
Collard	1/4 mile			Sorrel		4	7
Corn	1/4-1 mile	2	4	Spinach,	1 mile+	5	7
Cucumber	1/4 mile	10	?	" , New Zealand		5	8
Cress, Garden		5	9	Squash	1/4 mile		
Dill		3	5	Strawberry		3	6
Eggplant	50 ft	6	10	Sunflower	1/4 mile		
Gourd		6	10+	Sweet Cicely		1	1
Horehound		3	6	Swiss Chard	1/4 mile		
Hyssop		3	5	Tansy		2	4
Kale	1/4 mile			Thyme		3	7
Kohlrabi		5	10	Tomato	15-20 ft	4	9
Lavender		5	6	Turnip	1/4 mile	5	10+
Leek	1/4 mile	3	9				
Lentil	10 ft	4	9				
Lettuce	15-20 ft	5	9				
Lovage		3	4				

MENU: [HOME](#) » [Reconstruction](#) » [Recovery](#) » [Renewal](#) » [Survival](#) » [Humanure Content](#)

The Humanure Handbook

[Front Cover](#) - [Back Cover](#)

Table Of Contents:

[Show Full Contents](#) - [Awards](#)

[Reader Feedback From The First Edition](#)

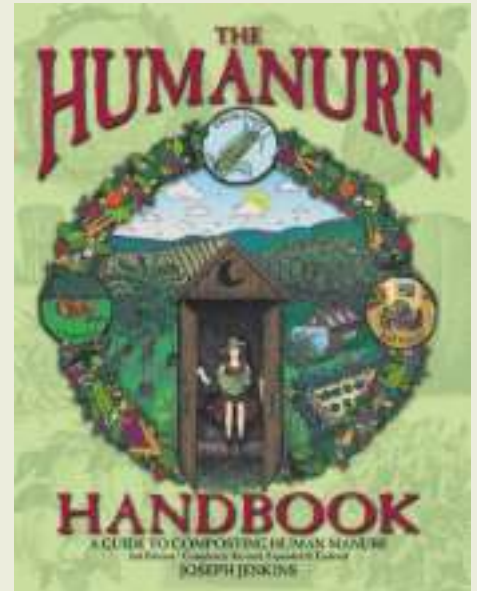

0 - [The Beginning](#)

1 - [Crap Happens](#)

2 - [Waste Not Want Not](#)

3 - [Microhusbandry](#)

4 - [Deep Sh*t](#)

5 - [A Day In The Life Of A Turd](#)

6 - [Composting Toilets And Systems](#)

[Worldwide Sources of Composting Toilets](#)

7 - [Worms And Disease](#)

8 - [The Tao Of Compost](#) (*how to do it!)

9 - [Alternative Grey Water Systems](#)

10 - [The End Is Near](#)

[References](#)

APPENDICES

- Appendix 1: Temperature Conversions
- Appendix 2: Sources of Wetland Plants
- [Appendix 3: US State Regulations](#)

[Glossary](#)

Other Goodies:

[Join a discussion](#) with your fellow humanure composters!

PalmOS file in DOC format: [Chapter 8: Tao of Compost](#)

Copyright 1999, Joseph C. Jenkins

The following information may be reproduced subject to the following three conditions:

- 1) The information must not be changed or altered
- 2) The following information must accompany all copies:

Source: The Humanure Handbook. Jenkins Publishing, PO Box 607, Grove City, PA 16127. To order, phone: 1-800-639-4099.

<http://www.jenkinspublishing.com/>

- 3) The reproduction is not done for profit. Persons wanting to use excerpts or artwork from this book for a profit venture must contact the publisher for permission.

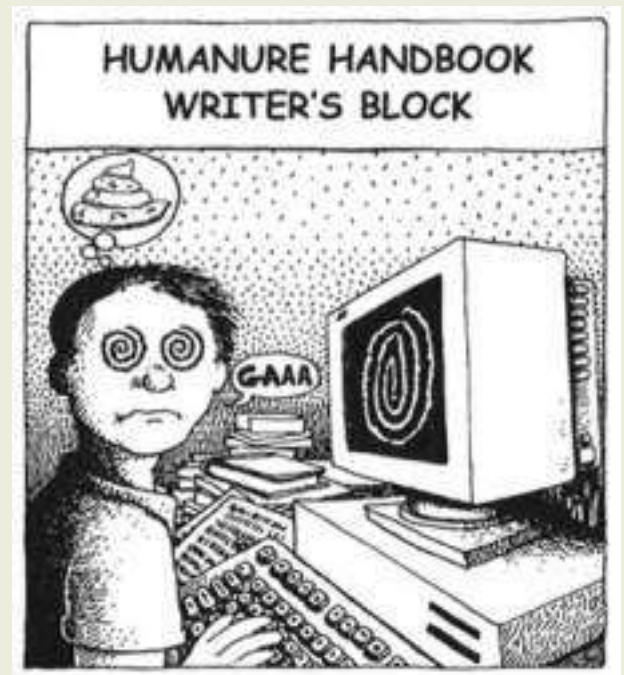

MENU: [HOME](#) » [Reconstruction](#) » [Recovery](#) » [Renewal](#) » [Survival](#) » [Humanure Content](#)



Jenkins Publishing

Affiliated with Joseph Jenkins Incorporated

PO Box 607, Grove City, PA 16127 USA

Phone toll free: 866-641-7141 or Fax: 814-786-8209

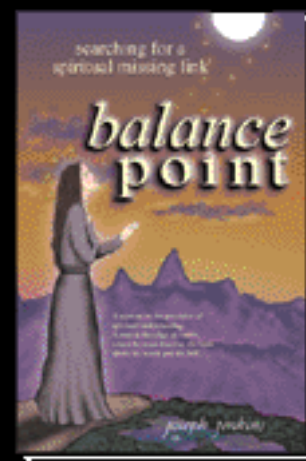
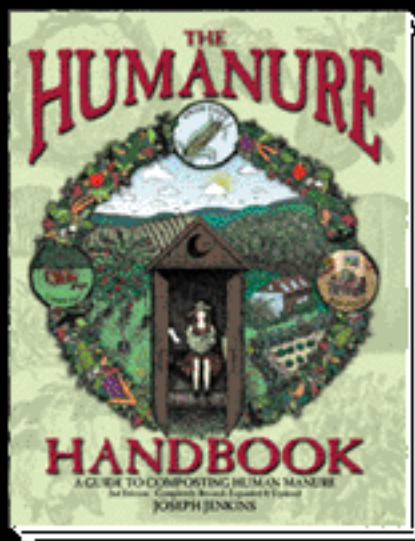
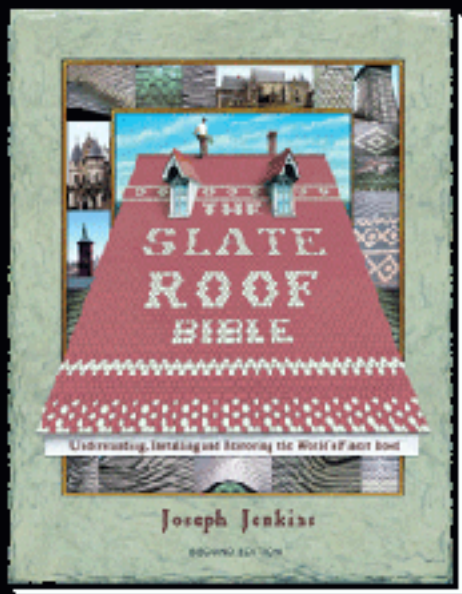

Jenkins Publishing, PO Box 607, Grove City, PA 16127 USA - [Order a book online.](#)

[Go to our message board!](#)

[Review our library.](#)

[Our free online publications.](#)

TRADITIONAL ROOFING MAGAZINE [free online](#)

"Dedicated to preserving the knowledge and skills of the traditional roofing trades." [Article Index](#)



Go to our
HOME
PLANET
now!



Joseph Jenkins Inc.

SLATE AND TILE ROOFS

[Jenkins Slate Roofing Services](#)

[Online STORE with slate roofing tools!](#)

[SLATE ROOF BIBLE for sale online!](#)

[Slate, tile, and asbestos roofing MESSAGE BOARD!](#)

[Slate roof CONSULTING services!](#)

[DIRECTORY of American slate roofers!](#)

Slate and tile LINKS!**Slate roof CONTRACTING services!**

Awards and Recognition	ORDER NOW
About Us at JP	International and Mail Orders
Raves & Reviews	Contact us!
Entire Humanure Handbook online!	Tables of Contents
Compost Links	Visit our Message Boards!
Traditional Roofing Newsletter	Food Gardening with Humanure
Sample pages from Slate Roof Bible	Humanure Hilton (Joe's compost bins)
Directory of Slate Roofers	Build a \$25 Sawdust Toilet
Humanure Links	Slate Roof Links

Jenkins Publishing, PO Box 607, Grove City, Pennsylvania USA 16127
Toll free phone (866) 641-7141, Business Fax (814) 786-8209

Order via our distributor, Chelsea Green Publishing at 800-639-4099
Send us email: mail@jenkinspublishing.com



Member:
[Publishers Marketing Association](#)



45530

[FastCounter by bCentral](#)

363.7288 J52h
Jenkins, Joseph C.
The humanure handbook : a
guide to composting human
S
33293006046736

HUMANURE HANDBOOK

A GUIDE TO COMPOSTING HUMAN MANURE

(Emphasizing Minimum Technology and Maximum Hygienic Safety)

Copyright 1994 by Joseph C. Jenkins

All Rights Reserved

Third Printing

The author permits the use of substantial excerpts from this book, providing that the use of such excerpts is not for the purpose of financial profit, and that the source of the information, including title of this book and the publisher's address, is acknowledged on the copied information. This license is granted for the purpose of making information on the subject of composting humanure available to those people who cannot afford to purchase the entire book.

Correspondences and/or book orders may be addressed to:
Jenkins Publishing, PO Box 607, Grove City, PA 16127 USA

ISBN 0-9644258-4-X

Library of Congress Catalog Card Number: 95-94239

The Humanure Handbook

Copyright 1994 by Joseph C. Jenkins
All rights reserved except as outlined on previous page.

Printed in the United States of America. - Published in the United States by:
Jenkins Publishing • PO Box 607 • Grove City, PA 16127 USA.

Acknowledgements

Editorial assistance from the following persons is gratefully acknowledged: Jeanine Jenkins, Joseph J. Jenkins, Michael Crews, Barry Smith, and Stephen Brown.

Thanks also to Tom Benevento for the information on the Guatemalan mouldering toilet and for allowing me to photograph him next to a Clivus Multrum; to Pam Owens for allowing me to photograph her with cedar posts in hand; to Jeanine for gracing the pages of this book with photos of her working with humanure compost; and to all the neighbors and friends who helped in the creation of this book by loaning the author reference materials, by suggesting sources of information, and for allowing the author to photograph their sawdust toilets, which was done in some cases (quite by accident) when they weren't home, allowing for candid photos of sawdust toilets as they look everyday.

A word of appreciation is in order for the Slippery Rock University Master of Science in Sustainable Systems program, Slippery Rock, PA 16057 USA, which played a significant role in encouraging the author to focus his attention on the subject at hand.

A note of appreciation must be added for the international permaculture, organic agriculture, and sustainable gardening communities, whose existence and support has been inspirational.

Finally, a *special* note of recognition must be added in behalf of the author's wife, Jeanine, whose assistance at every stage in the creation of this work was tremendously beneficial.

Photographs, design and graphics are by the author unless otherwise indicated. Some of the graphics include clip art, or modified clip art, and any advertisements or segments of advertisements came from very old magazines found in a barn.

Cartoon artwork on pages 28, 49, 64, 84, 108, 136, 184, 188, and back cover by
Tom Griffin, Otter Creek, Mercer, PA 16137 USA.

Front cover artwork by Joanna and Chris Ithen, Ithen Printing Services, Grove City,
PA 16127 USA.

Third Printing Notes from the Author

When first published, I wondered whether this book would sink or swim, suspecting that not many people would want to read about “*humanure*”. But I should have known - this book neither sinks nor swims. It *floats*. And like a turd that won’t flush, the Humanure Handbook keeps coming back. This is surprising, considering the humor throughout this book is execrable, and there is plenty to be offended or annoyed by if you have a mind for it. Worse, there are two prerequisites to reading this book: you must be able to read, and you must be able to defecate. Apparently there are still *some* people who fit into this category, and for the most part, their comments have been encouraging. Here’s a sampling:

“Your discovery of the proper small scale of the operation is world shaking.”

F. A., Delaware

“I enjoyed the book immensely, but my mother is appalled. Pleasing me and irritating my mother - you score big in my two favorite categories.” K. L., Indiana

“Your book is pure gold, just what I needed to give to my County Health Department.” M. T., Missouri

“Your book was carefully handed to me in a brown paper bag at church last spring. Great research, clear writing and terrific humor.” L. U., West Virginia

“I showed a review of your book to my dad and he almost gagged! Would you mail me one in a plain wrapper? I live with my parents.” M. C., Colorado

“If you could claim credit for engineering the thermophilic decomposers, you would probably win the Nobel Peace Prize.” T. C., Arizona

“We started using our ‘system’ the day after receiving the book. It took about two hours to put together. I wish more problems that at first seemed complicated and expensive could be solved as simply as this.” J. F., New York

“I’ve been composting and using my own waste for the past 20 years. Most of my friends think it odd. I counter that not even barbarians piss and shit in their drinking water!” E. S., Washington

“Fascinating! We are indebted to you for your book Humanure Handbook.”
R. L., New York

“I’m sure you’ve probably heard it all before, but I really appreciate the fact that someone finally did their research and put it together in a pleasant readable form.” S. C., Wisconsin

“For 22 years I have used scarab beetle/larvae . . . they eat my shit in five minutes flat.” C. M., South Carolina

“I live and work in an international youth hostel and we’re using your saw-dust toilets.” B. S., Georgia

"This wonderful book fits right into my compost = redemption religious philosophy. You have answered questions I have held open since childhood." R., Massachusetts

"Just finished reading your book and I'm glad. Seeing Mr. Turdly dancing around the compost pile wasn't my ideal dream." E. S., Washington

"I'm wracking my brain, trying to find a compelling way to tell you how great I think your book is." K. W., Wisconsin

"I've spent my whole life recycling, reducing, reusing everything but my own shit and I'm ecstatically grateful to have your directions reach my lap." W., Maine

"I found your book entertaining, informative, and a great motivating force compelling us to start recycling our "humanure" immediately." B. W., Texas

"It is the shittiest book I've ever read, but it's great!" D. H., Wyoming

"I liked your book. Putting back nutrients after taking them away makes sense as well as the image of dropping a turd in a 5 gallon toilet filled with pure drinking water seems crazy." T. O., New Hampshire

"As parasites attached to the earth, it would seem that the only conscious thing we do that isn't killing the host, is manuring in the woods, fields or a compost toilet." D. G., Minnesota

"Two things you might be interested in: A more natural way to eliminate is in the squatting position. [and] Urine is not a waste product. Taking urine internally has been going on for some time (1000's of years) and by many is considered a wonderful medicine. I take my first urine daily. Also, urine is used today in ear wax removal, hand creams, and other. Now is that full of crap . . . or is it?" W. E., Ohio

"Your book (Humanure) saved my butt at a town council meeting yesterday. Thank you for writing it." D. W., Colorado

"My 74 year old father thinks human waste should not be used in a garden, and I want to prove him wrong." A. M., Washington

"I had to call my dear heart long distance immediately to read her what may be the most hopeful environmental news I've read in my 35 years, that something can transmute horrible toxins. Why aren't all the environmentalists raving about this?" C., Vermont

There have been enough written comments about the Humanure Handbook to fill an entire book. The first two printings have been read in every state in the USA including Puerto Rico, and in at least nine other countries (Canada, Australia, Japan, England, Mexico, Guatemala, Spain, Wales, and Malaysia), by people of all ages (teens to nonagenarians). Perhaps the time has come to make *humanure* a household word. And with enough brown paper bags, perhaps the book will even get passed around a bit!

JCJ - Spring, 1996

TABLE OF CONTENTS

INTRODUCTORY INFORMATION

Page 7

Chapter 1 CRAP HAPPENS

Page 13

Soiled Water; Waste Reduction-Resource Recovery; Waste vs. Manure; Experience Helps.

Chapter 2 MICROHUSBANDRY

Page 29

Naturalchemy; Gomer the Pile; The Carbon/Nitrogen Ratio; Misinformation; Have a Good Blend; Newspaper; Lime.

Chapter 3 DEEP SHIT

Page 51

Waste vs. Manure, Again; The Advances of Science; Holy Sheesh; When the Crap Hit the Fan.

Chapter 4 A DAY IN THE LIFE OF A TURD

Page 65

Mexican Biological Digester; The Old Fashioned Outhouse; Septic Systems; Sand Mounds; Ground Water Pollution from Septic Systems; Wastewater Treatment Plants; Chlorine; Alternative Wastewater Treatment Systems; Agricultural Use of Sewage Sludge; Global Sewers and Pet Turds.

Chapter 5
COMPOSTING TOILETS AND SYSTEMS

Page 85

The Non-Commercial (Homemade) Mouldering Toilet; Commercial Mouldering (or Multrum) Toilets; More Commercial Composting Toilets; Asian Composting; Simple, Low-Tech Humanure Composting.

Chapter 6
WORMS AND DISEASE

Page 109

The Hunzas; Pathogens; Indicator Pathogens; Persistence of Pathogens on Soil, Crops, Manure and Sludge; Eliminating Pathogens From Humanure; More on Parasitic Worms; Summary of Conditions Needed to Kill Pathogens; Conclusions.

Chapter 7
THE TAO OF COMPOST

Page 137

Primal Compost; The Evolution of Compost; Thermophilic Microorganisms; Four Necessities for Good Compost; Doing It; The Sawdust Toilet; Analyses; Low-Impact Composting; Monitoring Compost Temperature; Legalities.

Chapter 8
THE END IS NEAR

Page 175

APPENDICES

Page 185

1) Sources of compost thermometers; 2) Metric conversions; 3) Centigrade/Fahrenheit conversions; 4) Sawdust toilet temperature curve.

GLOSSARY

Page 189

INDEX

Page 193

INTRODUCTORY INFORMATION

Figure A: The human nutrient cycle - intact11
 Figure B: The human nutrient cycle - broken12

CHAPTER ONE

Figure 1.1: Gross solid waste generated in the USA, not including sewage15
 Figure 1.2: Amount of humanure available worldwide per square mile of
 tillable land16
 Figure 1.3: Sewage sludge dumped in U.S. ocean waters, 1973-198618
 Figure 1.4: Average annual per capita water use in selected countries20
 Figure 1.5: Use of fertilizer worldwide since 195019
 Figure 1.6: Amount of nitrogen used in fertilizers in the USA derived from
 organic sources (1900 and 1948)19
 Figure 1.7: Composition of unrecycled discarded solid waste in the
 USA, 1980-200023
 Figure 1.8: Percentage of world population without adequate sanitation21
 Figure 1.9: Composition of municipal waste in USA, 198621
 Figure 1.10: Our increasing impact on planet Earth - world population
 growth, production and fuel consumption since 190022

CHAPTER TWO

Figure 2.1: Size of bacteria relative to a red blood cell, a hair, and a grain
 of sand33
 Figure 2.2: The Marino toilet - 1858 - Copenhagen42
 Table 2.1: Composition of humanure39
 Table 2.2: Carbon/nitrogen ratios for some compostable materials40
 Table 2.3: Nitrogen loss and C/N ratio39

CHAPTER FOUR

Figure 4.1: Biological Digester - South India66
 Figure 4.2: Spread of pollution through dry soil by outhouses66
 Figure 4.3: Pour flush latrines67
 Figure 4.4: The BOTVIP latrine: Botswana's rural ventilated improved
 pit latrines67
 Figure 4.5: Spread of pollution from outhouses (pit latrines) in wet soil68
 Figure 4.6: Cross section of a septic tank68
 Figure 4.7: Septic tank gravity distribution system69
 Figure 4.8: Sand mound waste distribution system69
 Figure 4.9: Sources of ground water contaminants in the United States70
 Figure 4.10: Ground water contaminants in the United States71
 Figure 4.11: Activated sludge wastewater treatment process72
 Figure 4.12: Wetland wastewater treatment system76

CHAPTER FIVE

Figure 5.1: Mouldering toilet (cutaway side view)89
 Figure 5.2: Mouldering toilet (cutaway south view)90
 Figure 5.3: Guatemalan mouldering toilet91
 Figure 5.4: Multrum toilet93
 Figure 5.5: Vietnamese double vault99

CHAPTER SIX

Table 6.1: Pathogens in urine112
 Table 6.2: Viral pathogens in feces113
 Table 6.3: Bacterial pathogens in feces114
 Table 6.4: Protozoan pathogens in feces114
 Table 6.5: Worm pathogens in feces115
 Table 6.6: Survival of enteroviruses in soil119
 Table 6.7: Survival time of some protozoa in soil119
 Table 6.8: Survival time of some bacteria in soil120
 Table 6.9: Survival time of polioviruses in soil120
 Table 6.10: Survival time of some pathogenic worms in soil121
 Table 6.11: Pathogen survival by composting or soil application127
 Table 6.12: Hookworms129
 Table 6.13: Average density of fecal coliforms excreted in 24 hours
 by various animals117
 Table 6.14: Parasitic Worm Egg Death131
 Figure 6A: Transmission of pathogens through septic tank waste

disposal systems	123
Figure 6B: Transmission of pathogens through conventional sewage treatment plants	124
Figure 6C: Transmission of pathogens through waste stabilization ponds	124
Figure 6D: Transmission of pathogens through passive, low temperature composting toilets and mouldering toilets	125
Figure 6E: Transmission of pathogens through a thermophilic composting system	126
Figure 6F: Safety zone for pathogen death	133
Figure 6G: Survival times of fecal coliforms in soil	118
CHAPTER SEVEN	
Figure 7.1: The Tao of the sawdust toilet	154
Figure 7.2: Diagrams of sawdust toilet	155
Figure 7.3: Constructing a simple compost bin	157
Figure 7.4: Two styles of three-chambered compost bins	159
Figure 7.5: Anatomy of a continuous compost bin	160
Figure 7.6: Temperature curve of frozen humanure compost pile after spring thaw	164
Figure 7.7: Camp composter	168
Figure 7.8: Camp composter on a bank	171

SIDEBARS

	PAGE
CHAPTER ONE	
Fun Facts: Waste not want not	14
Fun Facts: About water	18
CHAPTER TWO	
Fun Facts: Carbon/nitrogen ratio	41
Essential Reading for Insomniacs: pH	47
CHAPTER SEVEN	
Essential Reading for Insomniacs: Thermophilic microorganisms	143
A Tip from Mr. Turdley: Sawdust	151
Another Tip from Mr. Turdley: The secret to composting humanure is to keep it covered	153
Yet Another Tip from Mr. Turdley: Pressure treated lumber should never be used for constructing compost bins	156
Do's and Don't's of a Thermophilic Toilet Composting System	166

PHOTOGRAPHS

	PAGE
CHAPTER ONE	
Humanure compost being wheelbarrowed to a garden	17
Humanure compost applied by hand to garden beds	24
CHAPTER TWO	
Humanure compost being removed from a double chambered bin	34
Humanure compost being applied to a raised bed in the spring	45
Probing a compost pile with compost thermometers	46
CHAPTER FIVE	
A Clivus Multrum toilet at Slippery Rock University	94
The contents of a Clivus Multrum toilet being examined through the access door	95
A young lady setting cedar posts for a compost bin	97
A sawdust toilet 100	101
A sawdust toilet showing removability of contents	103
A sawdust shed at a sawmill	103
CHAPTER SEVEN	
Indoor sawdust toilet in new home	152
Sawdust toilet with recessed peat moss container	158
Sawdust toilet in a basement	162
Sawdust toilet made of wooden box	165
Sawdust toilet in mobile home	167
Outdoor sawdust toilet	169
Sawdust toilet "outhouse"	170
CHAPTER EIGHT	
The author at the end of a long day	183

The Humanure Handbook
INTRODUCTORY INFORMATION

"It is more important to tell the simple, blunt truth than it is to say things that sound good."

John Heider



America is a land of waste. Much of what we waste consists of organic material which would prove very valuable if we would recycle it for agricultural purposes. That organic material includes food wastes, municipal leaves and other yard wastes, agricultural residues, and human waste in the form of digestive refuse material, otherwise known as fecal material and urine. The simple blunt truth is that we shit every day and we should be returning that organic material back to the soil.

Each of us is responsible for the byproducts of our digestive systems, namely feces and urine. Feces and urine are not waste. They are natural, organic refuse materials discarded by our bodies after completing the digestive processes. We choose to make these organic materials either waste materials or resource materials depending on what we do with them. When we discard them, we waste them. When we recycle them, we recover a natural resource.

Recycled refuse is not waste. It is a common misuse of semantics to say that waste is, can be, or should be recycled. Resource materials are recycled. Refuse is recycled. But waste is never recycled. That's why it's called "waste". This may seem like a trifling point to some, however it's actually quite important. Those of you who take the responsibility for recycling your refuse materials are not creating waste, and the term "waste" should not be associated with you. If you are composting all of your body's organic refuse and returning it to the soil and someone asks you, "*What do you do with your human waste?*" the correct response would be, "*What waste?*"

So let's define some terms. Feces and urine are byproducts of the human digestive system. They are refuse materials. When discarded, they're known as human waste. When recycled for agricultural purposes they're known by various names, including night soil (in Asia) and human manure or **humanure**. *Humanure is not human waste. Humanure is not waste - it is an agricultural resource.*

Humanure is a valuable organic resource material, in contrast to human waste, which is a dangerous pollutant. Humanure originated from the soil and can be quite readily returned to the soil, especially if properly composted. Human waste (discarded feces and urine), on the other hand, creates significant environmental problems, provides a route of transmission for disease, and deprives humanity of important soil nutrients. It's also one of the primary ingredients in sewage, and is largely responsible for much of the world's water pollution.

When crops of any sort are produced from soil, it is imperative that the organic residues - the refuse materials resulting from those crops, including animal excrements - are returned to the soil from which the crops originated. *This recycling of all organic residues for agricultural purposes should be axiomatic to sustainable agriculture.* Yet, spokespersons for the sustainable agriculture movement in the West remain silent about using humanure for agricultural purposes. Why?

In the 1970's I played around with the idea of composting my own manure for a few years, but I didn't get into it seriously until I settled down on my own homestead in 1979. At that time, I began composting humanure, proceeding through the process instinctively, altering my procedures when necessary, but always maintaining an emphasis on simplicity. Now, fifteen years later, I've decided to write about my experiences for the sake of those who are interested.

In the process of creating this book, I engaged in an extensive review of the literature related to the topic of composting humanure. I have carefully listed all of my references at the end of each chapter, and I encourage the reader to look to those references for verification or for additional information. In that review, I was surprised and even shocked to find that a) there is very little in print on the subject of composting humanure, and b) the information that is available is inconsistent with and sometimes diametrically opposed to the information which I gleaned from my own experiences. For example, current literature still lists humanure as a taboo and dangerous compost ingredient. (I don't. In fact, I would describe it more as an *essential* compost ingredient.) It recommends turning compost piles. (I don't. In fact, turning compost piles can do more harm than good.) It recommends liming compost, using other rock dusts in compost, or covering it with wood ashes (I don't. Rock dusts have no place in a compost pile.) It recommends segregating urine from feces when humanure is composted (I don't, and I can't imagine anything more undesirable than segregating urine from fecal material.) And the list goes on.

Before I continue, I want to make it perfectly clear that I do not consider myself an agricultural or scientific expert in any professional sense of the word. I am simply a layperson with twenty years of gardening experience who has done research

and gained experiences on composting humanure which others may find valuable. Nobody has paid me in any way to write this book, and all expenses incurred have come out of my own pocket.

It has not been my intent or goal, nor will it ever be, to profit financially from this book, although I'd be happy if my production expenses are one day eventually reimbursed. My intent has been to provide helpful information to those who want it, and to stimulate discussion about neglected topics including composting, humanure, the human nutrient cycle, waste, sustainable gardening, sustainable agriculture, etc. I'd roughly estimate that one in a million Americans have an interest in composting humanure. If I manage to find all of them and they read this book, I'll need a total of about 250 copies available in print. If that. On the other hand, there are millions of people throughout the developing world who could benefit from the information in this book. These are people who live simple lives with minimal resources and who are more apt to understand the increasing need to hygienically recycle organic refuse as the human population continues to swell upon an ever-shrinking planet.

I approach this topic (composting humanure) with a certain bias in favor of simplicity; or perhaps *sustainability* would be a more appropriate word. Therefore, most of the practical information that I present in this book reflects a sustainable approach. I don't encourage energy intensive or resource consumptive approaches to humanure composting. The methods I encourage are ones requiring little, if any, technology, and no electricity. They focus on the single family level, and not on the municipal level. The information I present is ideal for people who cannot or do not want to use running water or electricity for organic resource recycling, either by choice, culture, or emergency circumstances, or who have meager material resources at their disposal and can't afford expensive waste disposal systems or the loss of soil nutrients that would result from such systems. It is also ideal for anyone wanting to gain a basic understanding of humanure composting, no matter how complicated a recycling system they want to use for themselves, if any at all.

Composting humanure involves a simple process of microbial digestion. Like anything, the process can be made as difficult or complicated as one wants. It's the *process* itself that's important, not to mention interesting. For example, few people realize that there are reportedly 100 billion bacteria *per gram* of humanure, or that bacteria can digest diesel fuel and TNT, or chemically alter uranium. Some say that microorganisms in a compost pile can even produce enough heat to cook an egg (so far I haven't tried this).

Let's face it- everybody shits. It's one of those basic functions of the human body. We breathe, we eat, we copulate, we defecate, not necessarily in that order. Yet,

few people know anything about what happens to their excrement after it's been flushed down a toilet, or about the value of humanure as agricultural fertilizer, or about how to render it hygienically safe for recycling. Must our topsoil become depleted of nutrients and our agricultural petrochemicals that currently replace those nutrients become scarce, and our water supplies polluted before the art of composting humanure will be taken seriously by the human race?

In a nutshell, the purpose of this book is to explain why we Westerners aren't composting our humanure, why we should be, and how it can be done. Much of the discussion about why we're not doing it is philosophical, with a bit of delving into history and (god forbid) religion. The discussion of why we should be composting humanure focuses on the environmental problems associated with current waste disposal systems, as well as on the loss of agricultural nutrients that is the legacy of such systems. Chapter six focuses on "worms and disease", the often repeated cry of warning from those humans who equate the recycling of humanure with barbaric and unsanitary foolishness. There is no greater barrier to the recycling of humanure than this ignorance of the Western populace. And that ignorance is pervasive, deeply rooted, and tenacious. Granted, the warnings of "worms and disease" certainly bear some merit, however, such warnings tend to be exaggerated, sensational, and rooted in ignorance or fear. It is possibly for this reason more than any other that I have been goaded into writing this book.

The observant reader may notice that there are some apparent inconsistencies in the information presented in this book. In cases where various sources present inconsistent data about specific topics, I have simply reported the data as presented and left the reader to draw his or her own conclusions. Such inconsistencies are infrequent and of little consequence, nevertheless their existence should not be ignored (for example, one source reports that roundworm eggs will die in two hours when subjected to a temperature of 55°C, while another source reports that the eggs will die in ten minutes at the same temperature). Furthermore, don't be surprised if some information is repeated within this book. This is not by accident, as some information is worth repeating, especially as this book may end up on a shelf to be used for later reference by many readers who may tend to refer to only one chapter or another, in which case the repetition of material may be to the reader's long-term advantage.

If you're only interested in composting humanure, and want to skip the philosophy and other extraneous information, go straight to chapter seven. However, I'd encourage the reader to start at the beginning. The story of humanure is an interesting one. It begins with witches, travels to the Far East, and ends up in one's backyard. Not in my backyard you say? Ha! Read on.

J. C. J.

FIGURE A

THE HUMAN NUTRIENT CYCLE - INTACT -

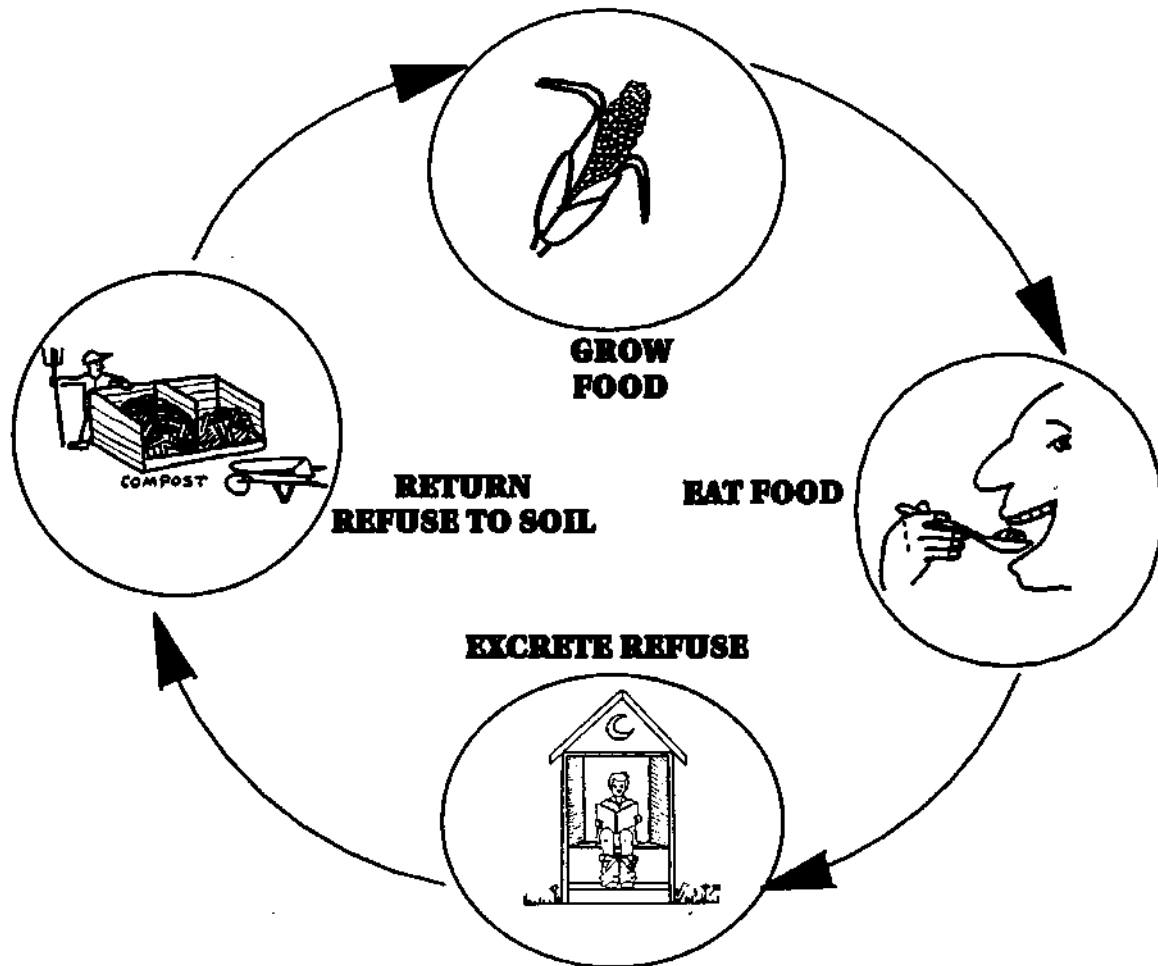

THE HUMAN NUTRIENT CYCLE IS AN ENDLESS NATURAL CYCLE.

IN ORDER TO KEEP THE CYCLE INTACT, FOOD FOR HUMANS MUST BE GROWN ON SOIL THAT IS ENRICHED BY THE CONTINUOUS ADDITION OF ORGANIC REFUSE MATERIALS DISCARDED BY HUMANS, SUCH AS HUMANURE, FOOD SCRAPS, AGRICULTURAL RESIDUES, AND THE LIKE. BY RESPECTING THIS CYCLE OF NATURE, HUMANS CAN MAINTAIN THE FERTILITY OF THEIR AGRICULTURAL SOILS INDEFINITELY, INSTEAD OF DEPLETING THEM OF NUTRIENTS AS IS COMMON TODAY. FOOD-PRODUCING SOILS MUST BE LEFT MORE FERTILE AFTER EACH HARVEST, DUE TO THE EVER-INCREASING HUMAN POPULATION AND THE NEED TO PRODUCE MORE FOOD WITH EACH PASSING YEAR.

FIGURE B

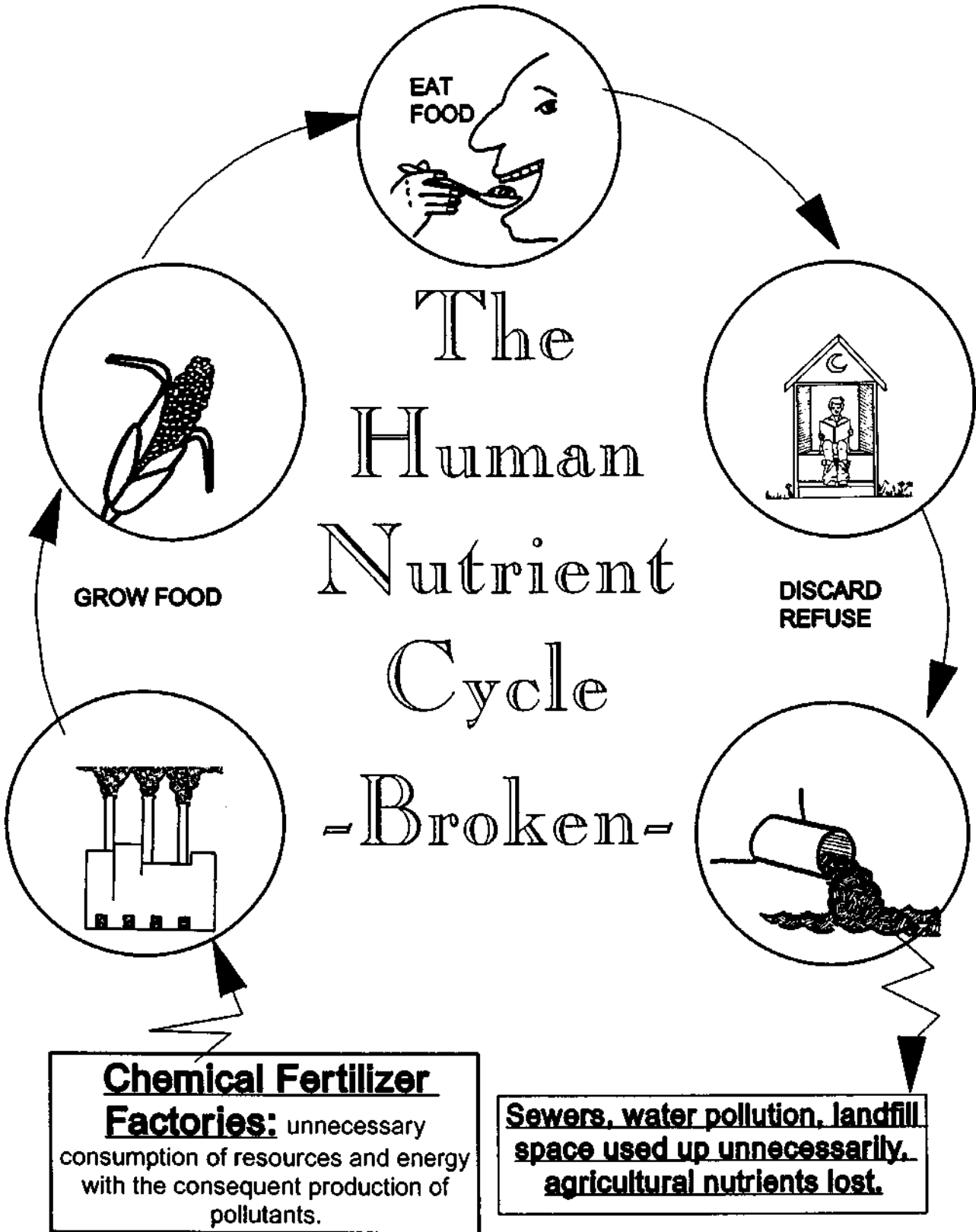

CRAP HAPPENS

“Anyone starting out from scratch to plan a civilization would hardly have designed such a monster as our collective sewage system. Its existence gives additional point to the sometimes asked question, Is there any evidence of intelligent life on the planet Earth?”

G. R. Stewart



The world is divided into two categories of people: those who shit in drinking water and those who don't. We in the Western world are in the former class. We defecate in water, usually purified drinking water. After polluting the water with our body's digestive system byproducts, we flush the once pure but now polluted water "away". Away to where? Good question.

This ritual of defecating in water may be useful for maintaining a good standing within Western culture. If you don't deposit your feces into a bowl of drinking water on a regular basis, you may be considered a miscreant of sorts, perhaps uncivilized or dirty or poverty stricken. You may be seen as a non-conformist or a radical. However, these perspectives are based upon ignorance. There is currently a profound lack of knowledge and understanding among Westerners about what is referred to as the "human nutrient cycle" and the need to keep the cycle intact.

The human nutrient cycle goes like this: a) grow food, b) eat it, c) collect and process the food refuse (feces, urine, food scraps and agricultural residues), and d) return the processed refuse to the soil, thereby enriching the soil and enabling more food to be grown. Then the cycle is repeated, endlessly. When our food refuse is instead discarded as waste, the natural human nutrient cycle is broken and all manner of problems can result. Those problems can be summed up in two convenient words: waste and pollution.

Crap happens. However, it's interesting to note that the creation of human waste is a matter of human choice. We *choose* to throw things away rather than recycle them. We *choose* to create waste rather than recycle useful resources, because it's more convenient to discard things than to reuse them. Even though those resources may be refuse materials with little *apparent* value, such as the refuse of our digestive

systems, when recycled, they can prove to be both useful and valuable.

It's common to refer to human fecal material and human urine as "human waste". However, such a term is misleading at best. Human waste actually consists of a huge number of items and substances (cigarette butts for example), and human digestive system refuse is only waste when it's discarded. When it's recycled for agricultural purposes it's called, among other things, human manure or *humanure* for short.

All humans create fecal material and urine. However, some people create human waste, or sewage, while others create humanure, an agricultural resource, depending on whether the material is wasted or recycled. We in the United States each waste about a thousand pounds of humanure every year, which is discarded into sewers and septic systems throughout the land. Much of the discarded humanure finds its final resting place in a landfill along with the other solid waste we Americans discard, which, coincidentally, also amounts to about a thousand pounds per person per year. For a population of 250 million people, that adds up to nearly *250 million tons of solid waste discarded every year, at least half of which is valuable as an agricultural resource.*

This is not to suggest that *sewage* should be used to produce food crops. In my opinion, it should not. Sewage consists of human digestive-system refuse collected along with other hazardous materials such as industrial, medical and chemical wastes, all carried in a common water-borne waste stream. Humanure, on the other hand, when kept out of the sewers, collected as a resource material, and properly

FUN FACTS



WASTE NOT - WANT NOT

America is a land of waste. Of the top fifty municipal solid waste producers in the world, America is fifth in line, being outranked only by Australia, New Zealand, France and Canada. Although the U.S. population increased by 18% between 1970 and 1986, its trash output increased by 25% during that time period, indicating that as time passes, we become more wasteful as a nation. Today, every individual in America produces about four pounds of trash daily, which will add up to 216 million tons per year by the year 2000, almost ten percent more than in 1988. If this sounds like a lot, sit down for a minute: municipal solid waste (the 216 million tons per year just mentioned) make up only one percent of the total solid waste created annually in the United States. The rest comes from industry, mining, utilities and other sources.

processed (composted), makes for a fine agricultural resource material suitable for food crops. Granted, there are certain hygiene considerations involved in the processing of humanure for food purposes, and these will be discussed at length later in this book.

The United States Environmental Protection Agency estimates that 13.2 million tons of food refuse are produced in American cities alone every year. That food refuse would make great organic material for composting, especially if mixed with humanure. If we composted the food refuse, we would be recycling a *resource* instead of creating *waste*. Instead, much of that food waste is buried in landfills, as is most of our discarded feces and urine. Yet, it is becoming more and more obvious that it is unwise to rely on landfills to dispose of recyclable materials. Landfills fill up, and new ones need to be built to replace them. The estimated cost of building and maintaining an EPA approved landfill is now nearly \$125 million. In fact, the 8,000 operating landfills we had in the United States in 1988 had dwindled to 5,812 by the end of 1991. Slowly, we're catching on to the fact that this trend has to be turned around. We can't continue to throw "away" usable resources in a wasteful fashion by burying them in disappearing landfills.

As a result, recycling is slowly becoming more widespread in the U.S.. Between 1989 and 1992 recycling increased from 9 to 14% and the amount of U.S. municipal solid waste sent to landfills decreased by 8%.² This is a welcome trend, however it doesn't adequately address a subject sorely in need of attention: what to do with humanure, which is not being recycled.

If we had scraped up all the human excrement in the world and piled it on the world's tillable land in 1950, we'd have applied nearly 200 metric tons per square mile at that time (roughly 690 pounds per acre). In the year 2000 we'll be collecting significantly more than *double* that amount because the global population is increasing, but the global land mass isn't. In fact, the global area of agricultural land is steadily *decreasing* as the world loses, for farming and grazing, an

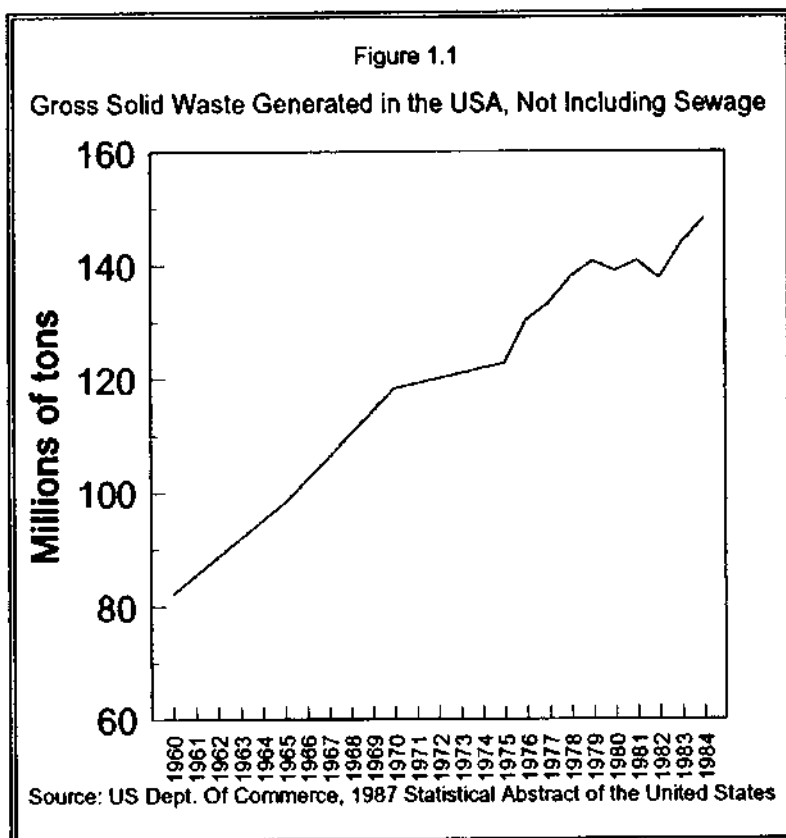
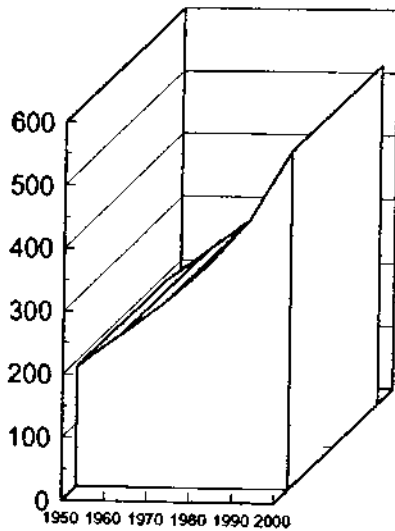

Figure 1.2

Amount of humanure available worldwide per square mile of tillable land.



□ Metric tons per square mile.

If the world's output of human excrement were collected and applied only to arable land, we would have applied nearly 200 million tons per square mile in 1950. By the year 2000, we will have over double that amount. This does not take into account the loss of farmland due to desertification.

(Fahm, L. *The Waste of Nations*, 1980, Osmund and Co., New Jersey, pp. 37-38.)

area the size of Kansas each year.³ The world's burgeoning human population is producing a ballooning amount of organic refuse which will eventually have to be dealt with responsibly and constructively. It's not too soon to begin to understand human organic refuse materials as valuable resource materials begging to be recycled.

In 1950 the dollar value of the agricultural nutrients in the world's gargantuan pile of humanure was 6.93 billion

dollars. In 2000 it will be worth 18.67 billion dollars (calculated in 1975 prices).⁴ This is money currently being flushed down the drain and out somewhere into the environment where it shows up as pollution, and/or landfill material. Every pipe line has an outlet somewhere; everything thrown "away" just moves from one place to another. Humanure and other organic refuse materials are no exception. Not only are we flushing "money" away, we're paying through the nose to do so. And the cost is not only economic, it's environmental.

A cursory review at the local library of sewage pollution incidents in the United States yielded the following: More than 2,000 beaches and bays in twelve states were closed in 1991 because of bacterial levels deemed excessive by health authorities. The elevated bacteria levels were primarily caused by storm-water runoff, raw sewage, and animal wastes entering the oceans. The sources of the pollution included inadequate and overloaded sewage treatment plants, sewage overflows from sanitary sewers and combined sewers, faulty septic systems, boating wastes, and polluted storm water from city streets and agricultural areas.⁵

Also in 1991, the city of Honolulu faced penalties of about \$150 million for some 9000 alleged sewage discharge violations that were recorded since 1985⁶. That same year, Ohio Environmental Protection Agency fined Cincinnati's Metropolitan Sewer District \$170,000, the largest fine ever levied against an Ohio municipality, for failure to enforce its wastewater treatment program.⁷ In 1992, the U.S. EPA sued the Los Angeles County Sanitation Districts for failing to install secondary sewage treatment at a plant which discharges wastewater into the Pacific Ocean, and for fourteen

years of raw sewage spills and other discharges that have violated California Ocean Plan bacteria standards.⁸

That same year California was required to spend \$10 million to repair a leaking sewer pipeline that had forced the closure of twenty miles of southern California beaches. The broken pipeline was spilling up to 180 million gallons of sewage per day into the Pacific Ocean less than one mile offshore, resulting in a state of emergency in San Diego County. This situation was compounded by the fact that a recent heavy storm had caused millions of gallons of raw sewage from Mexico to enter the ocean from the Tijuana River.⁹

Environmental advocates in Portland, Oregon sued the city in 1991 for allegedly discharging untreated sewage up to 3,800 times annually into the Willamette River and the Columbia Slough.¹⁰ In April of 1992, national environmental groups announced that billions of gallons of raw waste pour into lakes, rivers, and coastal areas each year when combined sewers, which carry storm water and wastewater in the same pipe, overflow during heavy rains, also causing many cities to suffer from discharges of completely untreated sewage.¹¹

Much of the sewage sludge along coastal cities in the United States has simply been dumped into the ocean. However, dumping of sewage sludge in the ocean was banned as of December 31, 1991. Nevertheless, the city of New York was unable to meet that deadline and was forced to pay \$600 per dry ton to dump its sludge at the Deepwater Municipal Sludge Dump Site 106 miles off the coast of New Jersey. Illegal dumping of sewage into the sea also continues to be a problem.¹² A bigger problem may be what to do with sewage sludge now that landfill space is



When humanure is composted with other organic refuse, it is converted into a sweet-smelling soil building material. Here it is applied to a garden.

Figure 1.3

Sewage Sludge Dumped in US Ocean Waters 1973-1986

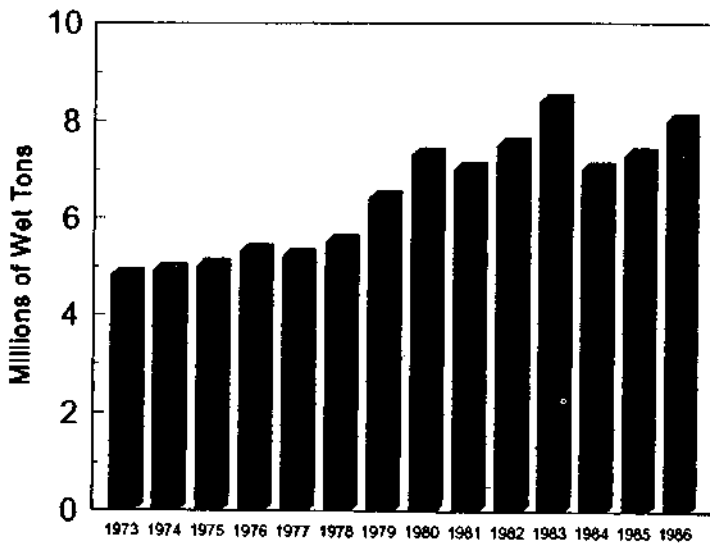

Source: US EPA, 1988, Report to Congress on Administration of the Marine Protection, Research, and Sanctuaries Act of 1972, EPA-503/8-88/002.

diminishing and it can no longer be dumped into the ocean. We'll get into that later.

SOILED WATER

The discarding of human waste adversely affects the quality of our planet's water supplies. First, by defecating directly into water, we pollute the water. Every time we flush a toilet, we launch five or six gallons of polluted water out into the world.¹³ Secondly, even after the polluted water is treated in wastewater treatment plants, it may still

be polluted with excessive levels of nitrates, chlorine, and other pollutants. This treated water is discharged directly into the environment. Also, by discarding organic human refuse materials as waste, we deprive ourselves of valuable soil nutrients. We should be returning the organic material back to the land in order to keep the human nutrient cycle intact.

Instead of using humanure to replenish the soil depleted by agriculture, we manufacture and use chemical fertilizers. From 1950 to 1980 the global consumption

FUN FACTS about water



- ▶ If all the world's drinking water were put into one cubical tank, the tank would measure only 95 miles on each side.
- ▶ Number of people currently lacking access to clean drinking water: 1.2 billion.
- ▶ Percent of the world's households that must fetch water from outside their homes: 67%.
- ▶ Percent increase of the world's population by the middle of the next century: 100%.
- ▶ Percent increase in drinking water supplies by the middle of the next century: 0%.
- ▶ Amount of water Americans use every day: 340 billion gallons.
- ▶ Number of gallons of water needed to produce a car: 100,000.
- ▶ Number of cars produced every year: 50 million.
- ▶ Amount of water required by a nuclear reactor every year: 1.9 cubic miles.
- ▶ Amount of water used by U.S. nuclear reactors every year: the equivalent of one and a third lake Eries.

▶ Sources: Der Spiegel, May 25, 1992; and Annals of Earth, Vol. 8, No. 2, 1990, Ocean Arks International, One Locust St., Falmouth, MA 02540.

of artificial fertilizers rose by 900%¹⁴, and in 1988, U.S. farmers used almost 19 million tons of synthetic fertilizers.¹⁵ All the while, hundreds of millions of tons of organic wastes are generated in the U.S. each year, including humanure, then buried in landfills when they could instead be composted and returned to the soil in place of artificial fertilizers.

Today, pollution from agriculture is said to be a main reason for poor water quality in our rivers, lakes and streams, the pollution being caused by both siltation (erosion) and nutrient runoff due to excessive or incorrect use of fertilizers.¹⁶ For example, in 1992 the state of Florida was required, through litigation, to build some 35,000 acres of marshlands to filter farm-related runoff that was polluting the Everglades with nutrients such as phosphorous.¹⁷ Nitrates from fertilizers are also causing pollution, seeping into ground water, lakes, rivers and streams. A 1984 U.S. EPA survey indicated that out of 124,000 water wells sampled, 24,000 had elevated levels of nitrates and 8,000 were polluted above health limits.¹⁸

Chemical fertilizers provide a quick fix of nitrogen, phosphorous, and potassium for impoverished soils. However, it's estimated that 25-85% of chemical nitrogen applied to soil and 15-20% of the phosphorous and potassium are lost to leaching, much of which can pollute groundwater.¹⁹ Much of this pollution shows up in small ponds which become choked with algae as a result of the unnatural influx of nutrients.

Not only are we polluting our water with agricultural runoff and sewage, we're

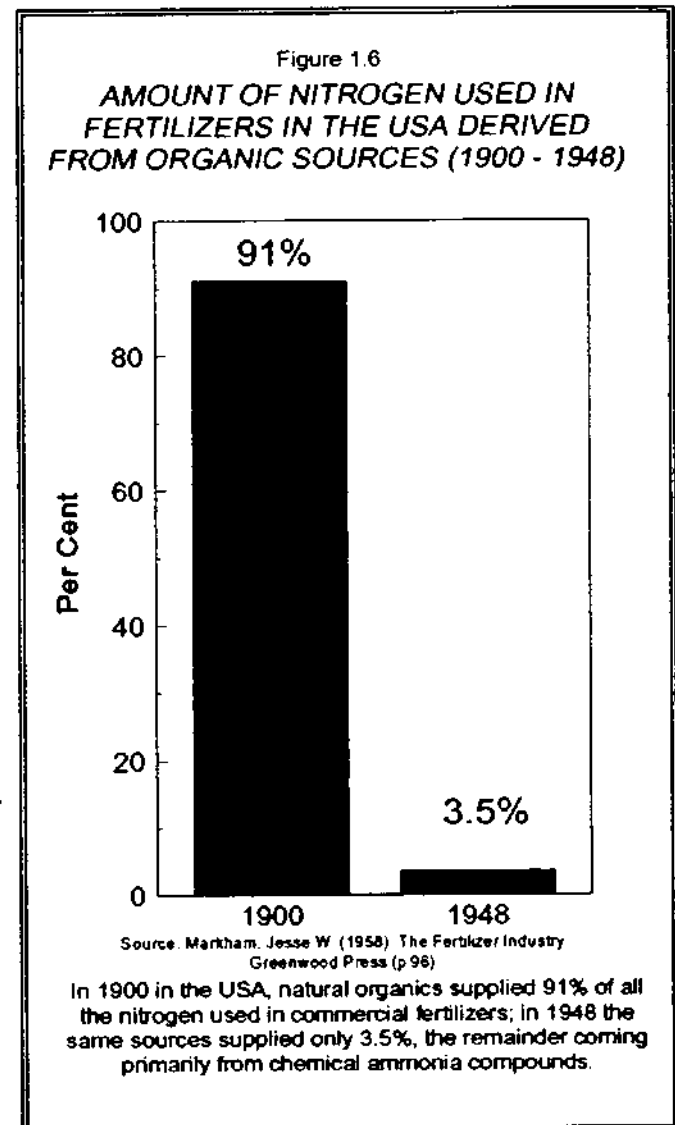
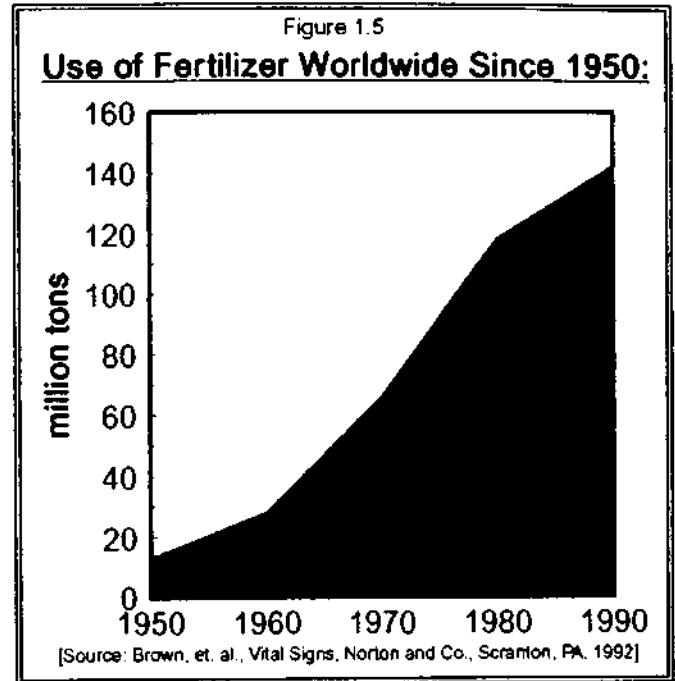
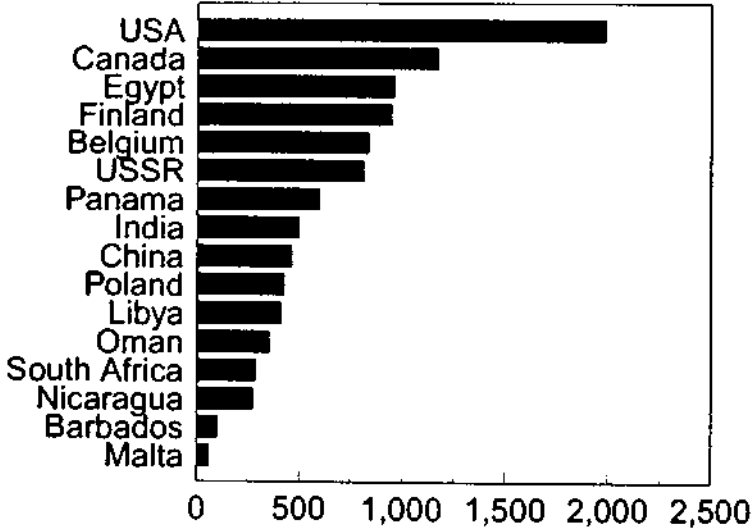

Figure 1.4

Average Annual Per Capita Water Use in Selected Countries



Cubic Meters of Water Per Person
 Source: World Resources Institute, 1986, World Resources 1986.
 As seen in The Water Encyclopedia, van der Leeden et.al.

using it up, and flushing toilets is one way it's being wasted. Of 143 countries ranked for per capita water usage by the World Resources Institute, America came in at #2 using *188 gallons per person per day* (Bahrain was #1).²⁰ The use of groundwater in the United States exceeds replacement rates by 21 billion gallons a day²¹. It takes one to two thousand tons of water to flush one ton of human waste (see chapter 4, reference # 43).

The impacts of polluted water are far ranging, causing the deaths

of 25 million people each year, three fifths of them children.²² Diarrhea, a disease associated with polluted water, kills 6 million children each year in developing countries, and it contributes to the death of up to 18 million people.²³ It's not necessarily the flushing of toilets that's polluting drinking water in developing countries, yet it's still, to a large extent, fecal contamination of water supplies, a problem that could be avoided by composting humanure instead of neglecting to do so. The object is to keep fecal material out of the environment and out of streams, rivers, wells and underground water sources, thereby eliminating the transmission of various diseases. Thermophilic (heat producing) composting will effectively convert fecal material into a hygienically safe humus, yet composting humanure has not become widespread in the West. Instead, human waste continues to pollute the world around us.

But in the United States haven't we solved the problem of water borne diseases? Largely yes, but not entirely. Illness related to polluted water afflicted 85,875 Americans from 1971-82. Forty-nine percent of these were caused by water treatment deficiencies.²⁴ Several American cities have suffered from outbreaks of cryptosporidia since 1984, cryptosporidia being protozoa which cause severe diarrhea. These protozoa enter people when they drink water contaminated by infected feces from humans and animals. Outbreaks occurred in Braun Station, Texas in 1984; in Carrollton, Georgia, in 1987; in Medford and Talent, Oregon in 1992; and in Milwaukee in 1993. Hundreds of thousands of people have been afflicted by the bug, for which there is no treatment. The illness runs its course in about fourteen days in healthy people, but can kill people who have weak immune systems.²⁵

Pollution from sewage and synthetic fertilizers results in part from the belief that humanure and food refuse are waste materials rather than recyclable natural resources. There is, however, an alternative. Humanure and food refuse can be composted and thereby rendered hygienically safe for agricultural or garden use.

Much of the Eastern world recycles humanure. Those parts of the world have known for millennia that humanure is a valuable resource which should be returned to the land, as any animal manure should. The West has yet to arrive at that conclusion.

**WASTE REDUCTION-
RESOURCE RECOVERY**

According to Sandra Postel (1992), *"The protective ozone shield in heavily populated latitudes of the northern hemisphere is thinning twice as fast as scientists thought just a few years ago. A minimum of 140 plant and animal species are condemned to extinction each day. Atmospheric levels of heat-trapping carbon dioxide are now 26 percent higher than the pre-industrial concentration, and continue to climb. The Earth's surface was warmer in 1990 than in any year since record keeping began in*

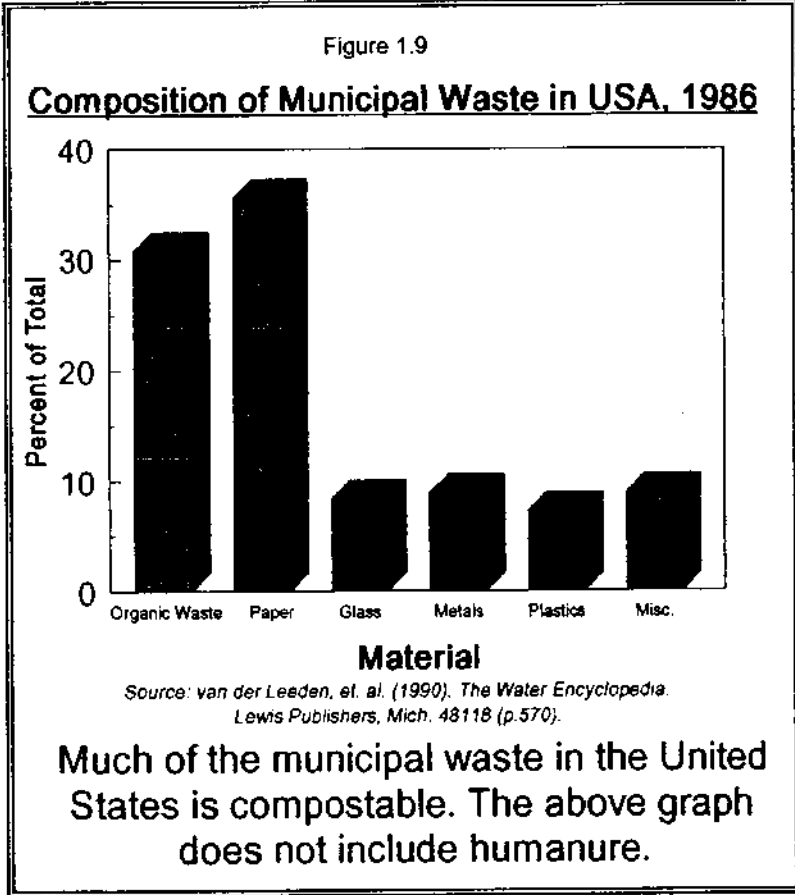
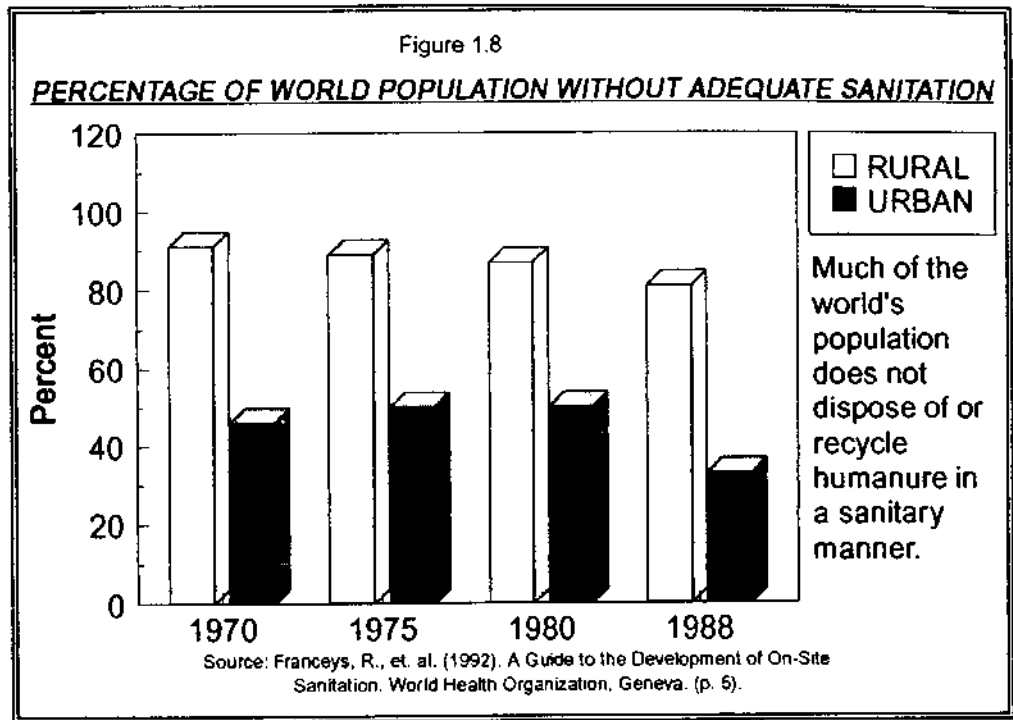

the mid-nineteenth century; six of the seven warmest years on record have occurred since 1980. Forests are vanishing at a rate of some 17 million hectares per year, an area about half the size of Finland. World population is growing by 92 million people annually, roughly equal to adding another Mexico each year; of this total, 88 million people are being added in the developing world."²⁶

Mr. Lester Brown adds that we're losing 24 billion tons of topsoil each year worldwide, and that areas of global farmland, grassland, and forestland are shrinking and being replaced by wasteland.²⁷

It should be added that CO2 levels are on the increase because of air pollution from the burning of fossil fuels such as coal and petroleum, and that CO2 and other gaseous pollutants bring us acid rain, acid fog, acid snow, and smog.

Crap happens. However, we don't inherit the earth, as the saying goes, we borrow it from our children, and we should be stewarding it for our future progeny. That's the sane thing to do. Most humans are sane, and they care about the future, about their children, their own health and their planet's health. The social and environmental problems we're faced with today are caused by poor leadership, lack of political foresight, and fear, greed and corruption caused by power and wealth, or a lack of it. If what Sandra Postel and Lester Brown are saying is true, our resources are dwindling and our ability to support life is slowly but steadily deteriorating. We

Figure 1.10

Our increasing impact on planet Earth:

World population growth, world production, and world fuel consumption since 1950 are increasing at a rapid rate with no end in sight-

Billions

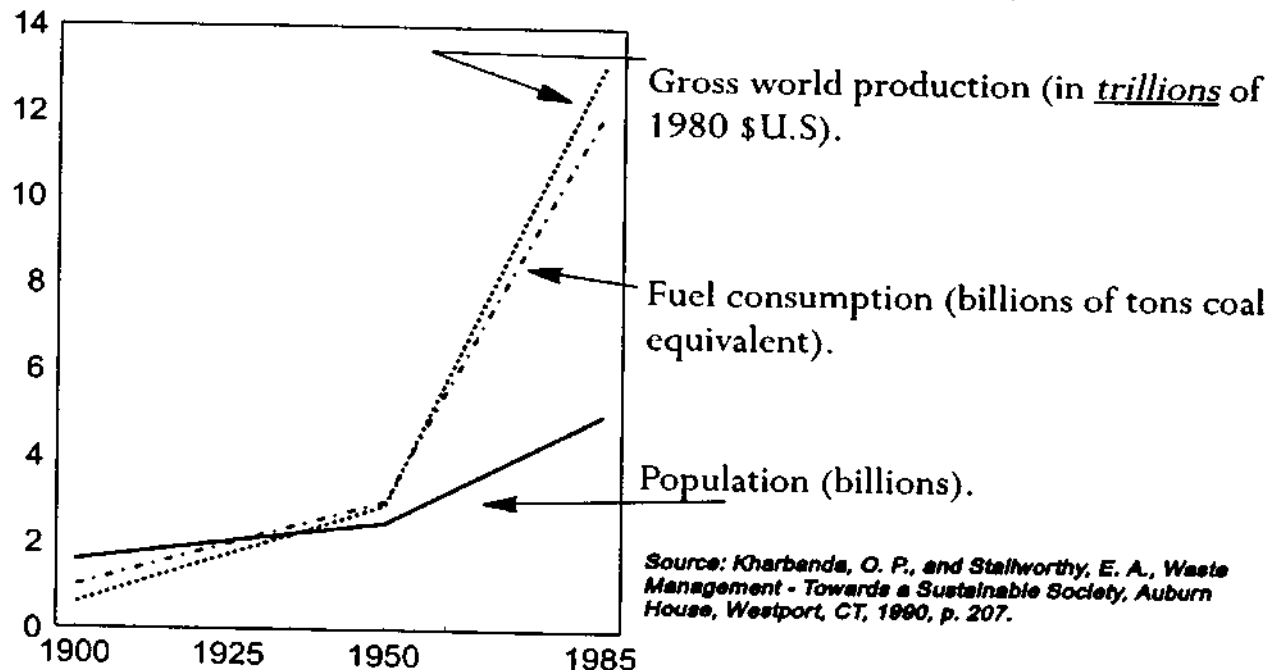

Source: Kharbenda, O. P., and Stallworthy, E. A., *Waste Management - Towards a Sustainable Society*, Auburn House, Westport, CT, 1990, p. 207.

should do something about that, and we can start with ourselves. What can we do? We can change our *minds*.

What we should be discarding is our throw-away *mentality*. Would it be so difficult to replace such a mentality with one which emphasizes *waste reduction and resource recovery*? “Waste reduction - resource recovery” is a worthy motto to lead us toward a sustainable future. A throw-away society eventually strangles itself in its own waste, while squandering valuable natural resources and energy in the process.

Ironically, the majority of the unrecycled solid waste discarded in the United States is organic waste and could be composted and thereby converted into one of the necessities of life: food.

Our refusal, as humans, to take intelligent responsibility for the recycling of our own nutrients, our own manure and food refuse, indicates a very significant blind spot in our understanding of natural processes.

WASTE VS. MANURE

Human digestive-system refuse is only waste if it's not recycled. Otherwise, it's manure, and a valuable resource and soil amendment material at that. Farmers never speak of “cow waste”, they speak of cow manure. Nor does one hear of “horse waste” or “pig waste” or “chicken waste”, instead they are all “manures” and for good reason. They aren't wasted. They're returned to the soil as they should be, thereby completing a natural cycle. These manures are valuable fertilizers for the soil, preventing the soil from becoming depleted of nutrients and inoculating the soil with bacteria and microorganisms which give the soil life and vitality.

Let's take a look at the process. Crops are grown, say oats; the oats are harvested and fed to animals, say cows. Now we stand back and wait. Eventually, the oats, which entered the cow's mouth, go through the cow's digestive system and the

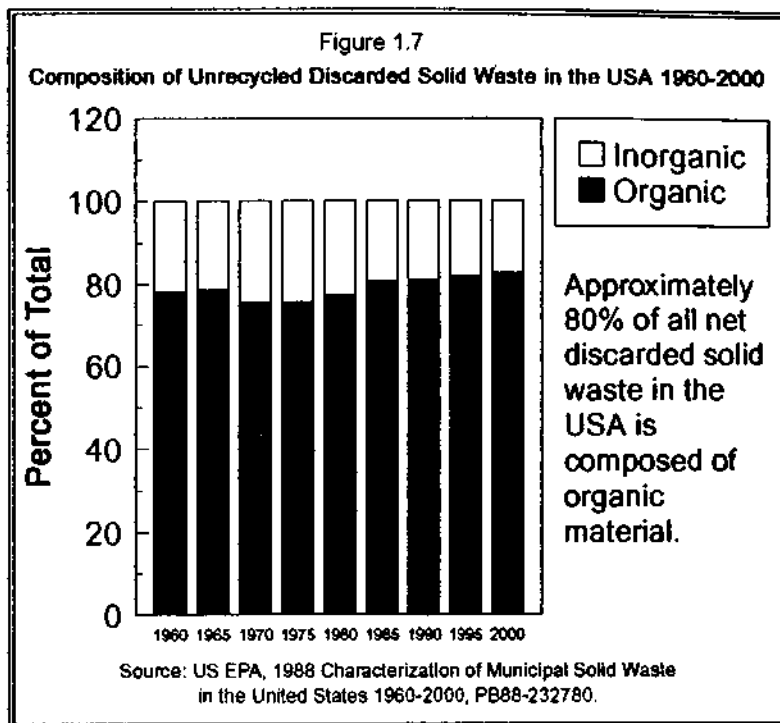



Properly composted humanure yields a rich, loamy, pleasant-smelling soil-building material, here being applied to spring garden beds.

lots of money on fertilizers, and keeping his soil healthy. Sounds reasonable enough. But what about *human* manure?

Humanure is a little bit different. It shouldn't simply be flung around in a fresh and repulsive state. It should undergo a process of bacterial digestion first, usually known as *composting*, in order to destroy possible pathogens. This is the missing link in the human nutrient recycling process. The process is similar to a cow's: A human grows food for itself on a field, or in a garden. The food enters the human's mouth and continues on into the digestive system where the body extracts what it needs, rejecting what it doesn't need at the time, or what it can't use. The body then excretes the rejected material.

At that moment the body is no longer responsible for the excretion. The body did its share of the work, now it's time for the mind to go to work. Thinking must now happen. The human mind now has basically two choices - consider the excretion to be waste and try to get rid of it, or consider the excretion to be a resource which must be recycled. Either way, the body's refuse must be collected. As waste, the human waste must be dispensed with in a manner that is safe to human health and to

cow's body takes what it needs from them. What it doesn't need or can't use goes out the other end and plummets to the barn floor as a "cow patty".

Now farmers know that cow manure is valuable. They also know that those cow patties are digested crops, and that crops are soil, water and sunshine converted into food, and the best way to get rid of those patties is to put them back in the field from where they originated. So the farmer loads up the manure spreader and flings the manure back into the fields, thereby cleaning up his barn, saving himself

the environment; as a resource, the humanure must be conscientiously composted to ensure the destruction of potential pathogens, then returned to the soil.

Much of the humanure (also known as "night soil") recycled in Asia is not composted. It's simply applied raw to the fields. *That is not what this book is about.* Raw humanure carries with it a significant element of danger in the form of disease pathogens. Those diseases, such as intestinal parasites, hepatitis, and others, are destroyed by composting, *when the composting process generates heat.* Raw applications of humanure to fields, on the other hand, are not hygienically safe and can assist in the spread of various diseases which may be endemic to areas of Asia where raw humanure is used. Americans who have traveled to Asia tell of the "horrible stench" of raw humanure that wafts through the air when such a material is applied to fields. For these reasons it is imperative that humanure always be composted before agricultural applications. Proper thermophilic (heat producing) composting destroys possible pathogens and results in a pleasant smelling material.

On the other hand, raw night soil applications to fields in Asia return humanure to the land and thereby do recover a valuable resource which is used to produce human food. *Composted* humanure is used in Asia as well. Cities in China, South Korea and Japan recycle humanure where it's returned to the land around the cities in greenbelts where vegetables are grown. Shanghai (China), a city which had a population of nearly 11 million people in 1970²⁸, produces an exportable surplus of vegetables in this manner.

Humanure can also be used to feed algae which can in turn feed fish for aquacultural enterprises. In Calcutta, such an aquaculture system produces 20,000 kilograms of fresh fish daily.²⁹ The city of Tainan, Taiwan, is well known for its fish, which are farmed in over 6,000 hectares of fish farms fertilized by humanure. Here humanure is so valuable that it's sold on the black market.³⁰

Furthermore, humanure can be mixed with other organic refuse from human activity such as kitchen and food scraps, grass clippings, leaves, garden refuse, and sawdust. When composted, this blend of nutrients can yield a balanced, loamy, rich, pleasant-smelling and hygienically safe soil additive suitable for food gardens as well as for agriculture.

The following chapters discuss the roots of the cultural bias against the recycling of humanure that we Westerners are burdened with. The amazing phenomenon of compost is also discussed, as it is the obvious alternative to organic waste disposal. Various conventional waste disposal systems currently in use, such as sewers and septic systems, are looked at, and a more detailed analysis of their environmental shortcomings is given. Common composting toilets, including home-made as well as store-bought ones, are also looked at, as are simple humanure composting systems

(which focus more on the composting and less on the toilet). The issue of human pathogens associated with humanure is closely scrutinized. Finally, a low-impact, largely technology-free system of humanure composting (the sawdust toilet) is discussed in detail.

EXPERIENCE HELPS

Allow me to interject here that I'm not advocating the composting of humanure based on theory. In fact, I have composted all of my family's humanure since 1979 (fifteen continuous years at the time of this writing) on our rural homestead using a very simple, low-impact, low-technology system (a *sawdust toilet*). The resulting compost has always been used in our food garden.

I've had an unusual opportunity to experiment with the composting of humanure, and this experience has yielded for me an abundance of empirical data. My experiences have made me confident that humanure can be easily and safely composted using only the simplest methods, yielding a valuable soil additive from what would otherwise be putrid and dangerous waste. By no means do I claim to have all the answers. But I do hope to at least be able to provide a *starting point* for those of you who seek information about composting humanure. Perhaps this book will shed a small ray of light onto what is otherwise a vacuum of information.

REFERENCES - CHAPTER 1

- 1 - Hammond, A., et. al. (Eds.). 1993 Information Please Environmental Almanac. Compiled by World Resources Institute. Houghton Mifflin Co. New York. 1993. (pp.50-51 and 339).
- 2 - Ibid. (pp.60-64).
- 3 - Daniel, J.E., et. al, editors. 1992 Earth Journal. Buzzworm Books. Boulder CO. (p.94).
- 4 - Fahm, L.A., (1980). The Waste of Nations. Allenheld, Osmun & Co. Montclair, NJ. (p.45).
- 5 - Environmental Reporter. 7/31/92 (p.1110). Bureau of National Affairs, Inc. Washington D.C.
- 6 - Environmental Reporter. 11/22/91 (p.1799).
- 7 - Environmental Reporter. 1/3/92 (p.2103).
- 8 - Environmental Reporter. 1/17/92 (p.2144).
- 9 - Env. Rep. 2/14/92 (p.2373).
- 10 - Env. Rep. 12/27/91 (p.2072).
- 11 - Env. Rep. 5/1/92 (p.13).
- 12 - Env. Rep. 11/8/91 p.1745-46 and 1/31/92 (p.2299)
- 13 - Golden, Jack. et. al. (1979). The Environmental Impact Data Book. Ann Arbor Science Publishers, Inc., PO Box 1425, Ann Arbor, Michigan 48106. (p. 495).
- 14 - Fahm, L.A., (1980). The Waste of Nations (p.46), see previous listing.
- 15 - 1992 Earth Journal, (p.159).
- 16 - Env. Rep. 4/24/92 (p.2877-78).
- 17 - Env. Rep. 2/28/92 (p.2439).
- 18 - 1992 Earth Journal, (p.159).
- 19 - Sides, S., Compost. The Mother Earth News. Aug/Sept. 1991. Issue 127. (p.50).
- 20 - Beyond Oil: The Threat to Food and Fuel in the Coming Decades. A Summary Report. November, 1986. Carrying Capacity Inc. 1325 G Street NW, Suite 1003, Wash. D.C. 10005.
- 21 - 1993 Information Please Environmental Almanac. (pp.340-341).
- 22 - Toward Organic Security: Environmental Restoration or the Arms Race?. Peace and Environment Platform Project, c/o World Citizens Assembly, Suite 506, 312 Sutter St., San Francisco, CA 94018.
- 23 - Courier. January, 1985. UNESCO. 7 Place de Fentenoy 75700 Paris, France.
- 24 - EPA Journal. Vol. 12 No. 7, September 1986, and Vol. 11 No. 7, September 1985, USEPA Office of Public Affairs, Wash. D.C. 20460.
- 25 - Associated Press, as seen in the Observer-Reporter (Washington and Green Counties, PA), Saturday, April 10, 1993. (p.A2).
- 26 - Brown, L.R. et. al. State of the World 1992. W.W. Norton & Co. New York. (p.3).
- 27 - Brown, L.R. et. al. State of the World 1990. (p.3).
- 28 - Mitchell, B. R. (1982) International Historical Statistics of Africa and Asia. New York University Press, New York, NY, 10003.
- 29 - State of the World 1990 (p.184).
- 30 - Rybczynski, W. et. al. (1982). Low Cost Technology Options for Sanitation - A State of the Art Review and Annotated Bibliography. World Bank. (p.23).

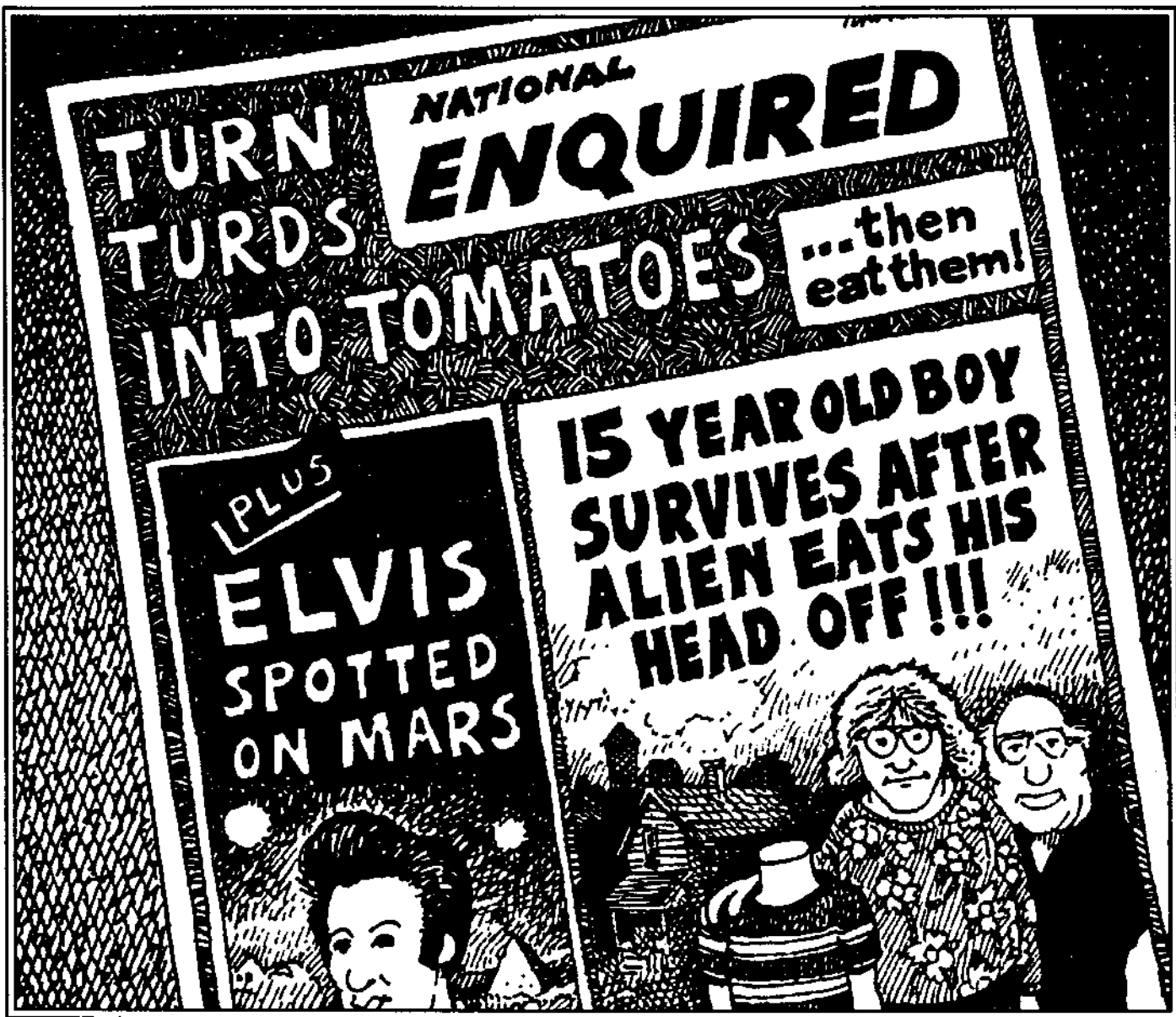

MICROHUSBANDRY

Harnessing the Power of Microscopic Organisms

“Making compost is an art rather than a science. To go about it mechanically, merely following rules, not only will not yield the best results, but the work will not be as enjoyable.”

J. I. Rodale



There are essentially four ways to deal with human excrement. The first is to *dispose of it*. People do this by defecating in water, or in outhouses or latrines. Most of this excrement ends up wasted, buried in the ground, or becomes a source of pollution. The second way to deal with human excrement is to *apply it raw to agricultural land*. This is popular in Asia where “night soil”, or raw human excrement, is spread on fields. Although this keeps the soil enriched, it acts as a vector, or route of transmission, for disease organisms. The third way to deal with human excrement is to *slowly compost it over an extended period of time*. This is the way of most commercial composting toilets and mouldering toilets. Slow composting generally takes place at temperatures below that of the human body (98.6 °F or 37°C). This method of composting eliminates most disease organisms in a matter of months, and should eliminate all human pathogens eventually, although some sources suggest that the total destruction of pathogens may require a period of up to ten years. Slow composting or mouldering, however, creates a useful soil additive that is at least safe for ornamental gardens or orchard use. The fourth way to deal with human excrement is to *thermophilically compost it*.

Thermophilic composting involves the cultivation of thermophilic (heat loving, or heat producing) microorganisms in the initial stage of the composting process. These bacteria and fungi can produce heat sufficient to destroy the disease organisms (human pathogens) that may be present in humanure. Thermophilic composting can render humanure into a friendly, pleasant-smelling, humus safe for food gardens. It's this type of composting which is the primary focus of this book, and this focus is not to be confused with the other three ways of dealing with human excrement. Thermophilically composted humanure is somewhat different from mouldered humanure, and *entirely different from night soil*.

What is compost anyway? I'm glad you asked that question. I remember

when I first moved out to the country and started living off the land at the age of 22. I was fresh out of college, so naturally I knew very little. One word that was a mystery to me was “compost”, another was “mulch”. I didn’t know what either of these things were, I only knew they had something to do with organic gardening, and that’s what I intended to learn about. Of course, it didn’t take me long to understand mulch. Anybody who can throw a layer of straw on the ground can mulch. But compost took a little longer.

Making compost is sort of like making bread, or maybe wine. My compost-learning experiences were a parallel of my wine-making experiences. Back then, having just graduated from the university, I had been conditioned to believe that everything had to be learned by using books. I had little awareness that instinct or intuition were powerful teachers. It seemed I was expected to believe that humans were the only thing in the universe with intelligence, and everything in nature was somehow below us. Furthermore, simple, natural processes had to be complicated with charts, graphs, measurements, devices, and all the wonderful tools of science, otherwise the processes had no validity. It was with this attitude that I set out to learn how to make wine.

Of course, the first thing I did was obtain a very scientific book replete with charts, graphs, tables, and detailed, step by step procedures. The book was titled something like “Foolproof Winemaking” and the trick, or so the author said, was simply to follow his procedures *to the letter*. This was no simple feat. The most difficult part of the process was acquiring the list of chemicals which the author insisted must be used in the winemaking process. After much searching and travel I managed to get the required materials and I then followed his procedures *to the letter*. This lengthy process involved boiling sugar, mixing chemicals etc. To make a long story short, I did succeed in making two kinds of wine in this way. Both tasted like hell though, and had to be thrown out. I was very discouraged.

It wasn’t too long after that when a friend of mine, Bob, decided he would try his hand at winemaking. Bob and I had a friend, Jim, who worked at a Pennsylvania vineyard, and Jim offered to bring Bob five gallons of grape juice for a try at the oenologist’s art. Jim, being the good sport that he is, even brought the juice in a five gallon glass winemaking container (carboy) with an airlock already on top of it (to allow fermentation gasses to escape while preventing air from entering). When he got the grape juice to Bob’s house, Bob took one look at the heavy carboy of juice and said, “*Jim, would you mind carrying that into the basement for me?*” Which Jim obligingly did. That was it. That utterance constituted Bob’s entire effort at winemaking. Two seconds of flapping jaws is the only work Bob did toward making that wine. He added no sugar, no yeast, did no racking, certainly used no chemicals. He didn’t

do a damn thing to that five gallons of grape juice except abandon it in his basement. And yet, that turned out to be the best homemade wine I had ever drunk. It tasted good and had a nice kick to it too. It was superb.

Now, I admit, there was an element of luck there, but I learned an important lesson about winemaking: the basic process is very simple - start with good juice and keep the air out of it. That simple, natural process can easily be ruined by complicating it with scientific procedures, and heck, all those charts and graphs took the *fun* out of it. Making compost is exactly the same sort of phenomenon.

NATURALCHEMY

What exactly *is* compost, you ask again? According to Webster, compost is “a mixture of decomposing vegetable refuse, manure, etc. for fertilizing and conditioning the soil.” To compost means to convert organic refuse into soil or humus. Humus is a brown or black substance resulting from the decay of organic animal or vegetable refuse. Organic refuse could be considered anything on the Earth’s surface that had been recently alive, or from a living thing, such as manure, plants, leaves, sawdust, peat, straw, grass clippings, food scraps, urine etc. A rule of thumb is that anything that will rot will compost. In some cases, even petroleum products are compostable.

In the Middle Ages alchemists sought to change base metals into gold. Old German folklore tells of a tale in which a dwarf named Rumpelstiltskin had the power to spin flax straw into precious metal. Somewhere in the psyche of the Western society was a belief that substances of little or no worth could be transmuted by a miraculous process into materials of priceless value. Our ancestors were right, but they were barking up the wrong tree. The miraculous process of thermophilic *composting* will transmute humanure into humus. In this way, a dangerous waste material becomes a soil additive vital for the processes of human life.

Our ancestors didn’t understand that the key to this alchemy was right at their fingertips. Had they better known and understood natural processes they could have provided themselves with a wealth of soil fertility and saved themselves the tremendous suffering caused by diseases originating from fecal contamination of the environment. For some reason they believed that gold embodied value, and in pursuit of glittering riches they neglected the things of real value in life: health, vitality, self-sufficiency, sustainability.

Their ignorance involved microbiology. Our ancestors had little understanding of a vast, invisible world which surrounded them, a world of billions of creatures

so small as to be quite beyond the range of human sight. And yet, some of those microscopic creatures were already being used to do work for humanity in the form of the fermentation of foods such as beer, wine or bread dough. Although *yeasts* have been used by people for centuries, *bacteria* have only relatively recently become harnessed by Western humanity. Composting is one means by which the power of bacteria can be utilized in a big way for the betterment of humankind. Unfortunately, our ancestors didn't understand the role of microorganisms in the decomposition of organic matter, and the efficacy of microscopic life in converting humanure, food scraps, plant residues and the like into soil. They didn't understand compost.

The decomposition of organic materials requires armies of bacteria which work so hard digesting (decomposing) the refuse they heat the stuff up. Other micro and macro organisms such as fungi and insects help in the composting process, too. When the compost cools down, earthworms often move in and eat their fill of delicacies, their excreta becoming a further refinement of the compost.

And so, successful composting requires the maintenance of an environment in which bacteria and fungi can thrive. Same for wine, except the microorganisms are yeast, not bacteria. Same for bread (yeast), beer (yeast), yogurt (bacteria), sauerkraut (bacteria); all of these things require the cultivation of microorganisms which do the work you want done. All of these things involve simple processes which, once you know the basic principles, are easy to carry out successfully. Sometimes bread doesn't rise, sometimes yogurt turns out watery, sometimes compost doesn't seem to turn out right. When this happens, a simple change of procedure will rectify the matter. Once you get the hang of it, you'd think that even a chimpanzee could be trained to make compost.

Often, in our household, we have yogurt being made by millions of hard-working bacteria in a few quart mason jars beside the cookstove. At the same time, millions of yeast cells are cheerfully brewing beer in carboys in the back pantry, millions more yeasts are happily brewing wine beside the beer, sauerkraut is blithely fermenting in a crock behind the stove, bread is rising on the kitchen counter, and fungi are tirelessly forcing their fruits from oak logs on the sunporch. And then there's the compost pile. At times like these, I feel like a real slave driver. But the workers never complain. Those little fellas work day and night, and they do a real nice job.

Making compost and using it agriculturally has its advantages. The end product of compost making, *humus*, consists of broken down organic matter that is the basis of soil life. Humus holds moisture, and therefore increases the soil's capacity to absorb and hold water. Compost is said to hold nine times its weight in water (900%), as compared to sand which only holds 2%, and clay 20%.¹ Compost also adds slow-release nutrients essential for plant growth, creates air spaces in soil, helps balance

the soil pH, darkens the soil and thereby helps it absorb heat, and supports microbial populations that add life to the soil.

The building of topsoil by Mother Nature is a centuries long process. Adding compost to soil will help to quickly restore fertility that might otherwise take nature hundreds of years to replace. We humans deplete our soils in relatively short periods of time. We can restore that fertility also in relatively short periods of time by composting our organic refuse and returning it to the land.

Another way to look at it is by seeing organic refuse as stored solar energy. Every apple core or potato peel holds a tiny amount of stored energy, converted into useable plant food by the compost pile. Perhaps S. Sides of the *Mother Earth News* states it more succinctly: "*Plants convert solar energy into food for animals (ourselves included). Then the [refuse] from these animals along with dead plant and animal bodies, 'lie down in the dung heap,' are composted, and 'rise again in the corn.' This cycle of light is the central reason why composting is such an important link in organic food production. It returns solar energy to the soil. In this context such common compost ingredients as onion skins, hair trimmings, eggshells, vegetable parings, and even burnt toast are no longer seen as garbage, but as sunlight on the move from one form to another.*"²

Adding compost to soil helps control plant diseases. Studies in 1968 by researcher Harry Hoitink indicated that compost, by adding beneficial microorganisms to the soil, inhibited the growth of disease-causing microorganisms in greenhouses. In 1987, he and a team of scientists took out a patent for compost that could reduce or suppress plant diseases caused by

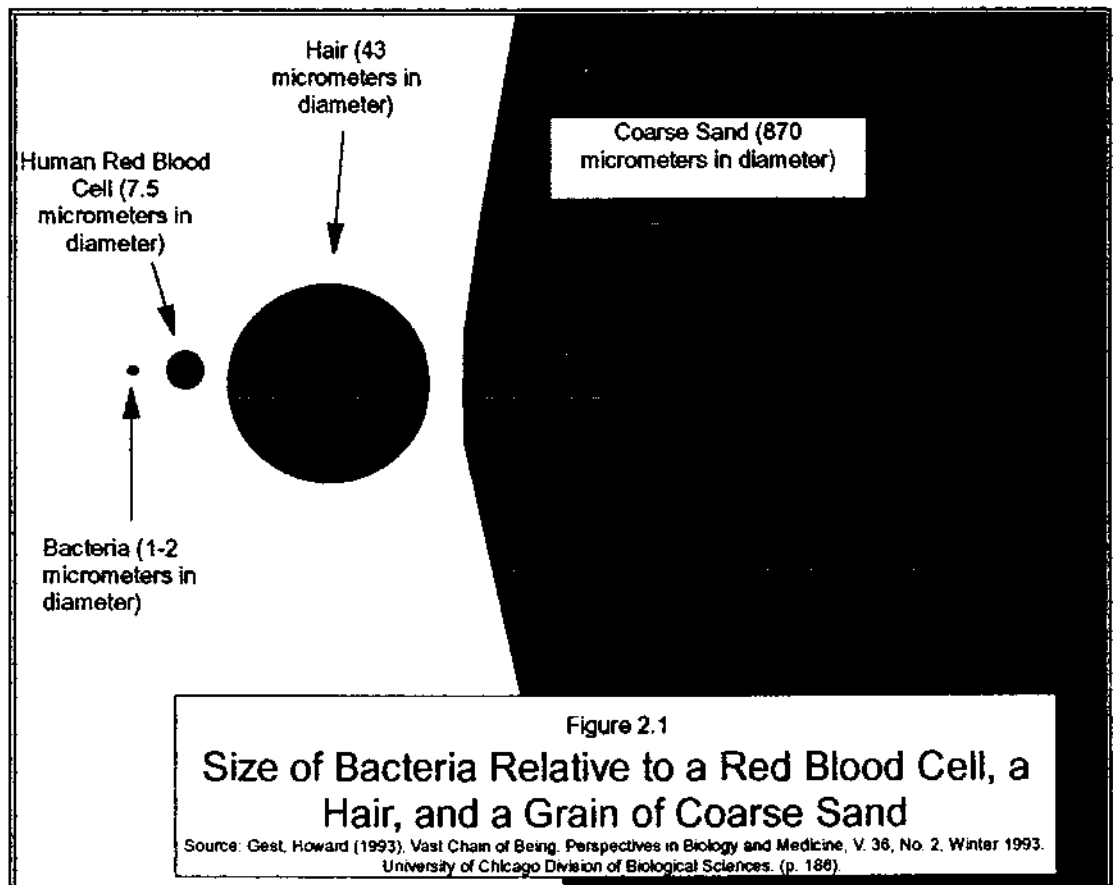

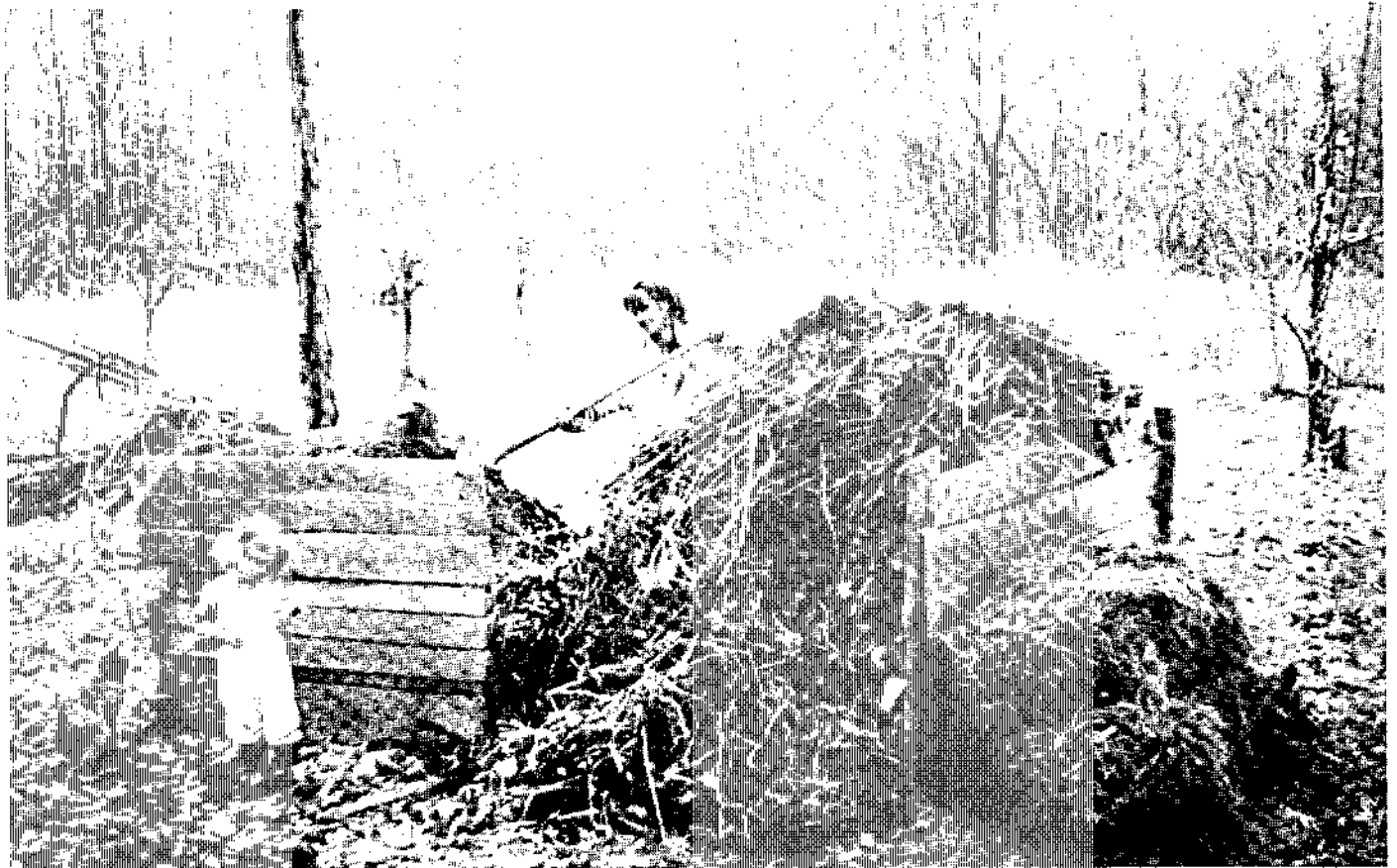

Finished compost is being removed from a double chambered compost bin.

The large pile of refuse in the chamber on the right is undergoing thermophilic decomposition, and represents nearly a year's worth of accumulated material, including humanure. When finished, it will shrink to half its size.

Clean hay is stacked against the right side of the bin to be used as cover material.

three deadly microorganisms: *phytophthora*, *pythium*, and *fusarium*. Growers who used this compost in their planting soil reduced their crop losses from 25-75% to 1% without applying fungicides. The studies suggested that sterile soils could provide optimum breeding conditions for plant disease microorganisms, while a rich diversity of microorganisms in soil, such as that found in compost, would render the soil unfit for the proliferation of disease organisms.³

Besides helping to control soil diseases, compost helps control nematodes, attracts earthworms, and aids plants in producing growth stimulators.⁴ It can also destroy some toxic wastes. One man who composted a batch of sawdust contaminated with diesel oil said, "*We did tests on the compost, and we couldn't even find the oil!*" The compost had apparently "eaten" it all.

Composting also seems to be able to decontaminate soil polluted with TNT

from munitions plants. The microorganisms in the compost digest the hydrocarbons in TNT and convert them into carbon dioxide, water, and simple organic molecules. Furthermore, some bacteria “eat” uranium. Derek Lovley, a microbiologist, has been working with a strain of bacteria that normally lives 650 feet under the earth’s surface. These microorganisms will eat, then excrete, uranium. The chemically altered uranium excreta becomes water insoluble as a result of the microbial digestion process, and can consequently be removed from the water it was contaminating.⁵

An Austrian farmer claims that the microorganisms he introduces into his fields have prevented them from being contaminated by the radiation from Chernobyl, the ill-fated Russian nuclear power plant, which contaminated his neighbor’s fields. Sigfried Lubke sprays his green manure crops with compost-type microorganisms just before plowing them under. This practice has produced a soil rich in humus and teeming with microscopic life. After the Chernobyl disaster, crops from fields in Lubke’s farming area were banned from sale due to high amounts of radioactive cesium contamination. However, when officials tested Lubke’s crops, no trace of cesium could be found. The officials made repeated tests because they couldn’t believe that one farm showed no radioactive contamination while the surrounding farms did. Lubke thinks that the humus just “ate up” the cesium.⁶

Finally, fertile soil yields food that promotes good health. One group of people, the Hunzas of northern India, has been studied to a great extent. One man who studied them extensively, Sir Albert Howard, stated, *“When the health and physique of the various northern Indian races were studied in detail the best were those of the Hunzas, a hardy, agile, and vigorous people, living in one of the high mountain valleys of the Gilgit Agency. . . There is little or no difference between the kinds of food eaten by these hillmen and by the rest of northern India. There is, however, a great difference in the way these foods are grown. . . [T]he very greatest care is taken to return to the soil all human, animal and vegetable wastes [sic] after being first composted together. Land is limited: upon the way it is looked after, life depends.”* We’ll take another look at the Hunzas in chapter six.

GOMER THE PILE

Back to the compost pile. Notice I said “pile”. Refuse is usually piled up in bins, racks, pits, drums or what have you. There are three basic reasons for piling the composting refuse. First, it keeps the pile from drying out or cooling down prematurely. A level of moisture (50-60%) is necessary for the bacteria to work happily.⁸ A vertical stack prevents leaching, prevents waterlogging, and holds heat in the pile.

Vertical walls around a pile, especially if they're made of wood, keep the wind off and will prevent one side of the pile (the windward side) from cooling down prematurely.

Secondly, a neat, contained pile just plain looks better. It looks like you know what you're doing, instead of looking like a garbage dump.

Thirdly, a pile makes it easier to layer, or cover over the compost. It's a good idea to cover the pile with clean refuse when a smelly deposit is added to the top, in order to eliminate unpleasant odors and to trap necessary oxygen in the pile. Therefore, if you're going to compost your refuse, don't just fling it out in your yard in a heap. Construct a nice little bin and do it right. That bin doesn't have to cost money, it can be made from recycled wood or cement blocks. Wood may be preferable as it'll insulate the pile and prevent heat loss and frost penetration. A compost bin doesn't have to be complicated in any way. It doesn't require electricity, technology, gimmicks or doodads. You don't need shredders or choppers, grinders or any machines whatsoever.

Compost *pits* are more likely to be used in dry, arid or cool climates where conservation of moisture and temperature is imperative. The main disadvantage of pits is that they can become waterlogged in the event of an unexpected cloudburst, and excessive water will rob the pile of oxygen, a critical element in the process of decomposition by aerobic microorganisms. When pits are used, therefore, a roof over them may be an advantage.

What sort of environment does the bacterial community like? As stated, the compost must be moist. A dry pile will not work. When composting humanure, the urine provides quite a bit of the necessary moisture. Other moisture comes from food scraps. In some cases, a compost pile may have to be watered. This would most likely occur in a very dry climate where the pile may also require a roof over it to reduce dehydration. In Pennsylvania, where I live, we have ample rainfall (35 inches per year, nearly one meter) and my compost never dries out, unless during an unusual drought. It is never covered by a roof and leaching has never been a problem. I've rarely had to water my compost. On the other hand, we compost all of our refuse, including our urine. We use rotting hardwood sawdust in our waterless sawdust toilet as an odor-preventing cover material, which also soaks up the urine to create a good moisture balance. Compost should be moist, not wet.

The amount of moisture a compost pile receives or needs depends on the materials put into the pile and on the location of the pile. According to Sir Albert Howard, watering a compost pile in England where the annual rainfall is 24 inches is also unnecessary. Nevertheless, the water required for compost-making may be around 200 to 300 gallons for each cubic yard of finished compost.⁹ This moisture

requirement will be met when human urine is used in the compost and the top of the pile is open and receiving adequate rainfall. If adequate rainfall is not available and the contents of the pile are not moist, watering will be necessary to produce a moisture content equivalent to a squeezed out sponge.

The bacteria we want to cultivate in the compost pile in order to ensure thermophilic decomposition are *aerobic* and they will suffer from a lack of oxygen if drowned in liquid. Bacterial decomposition can also take place anaerobically, but this is a slower, cooler process, which can, quite frankly, stink.

A good, healthy, aerobic compost pile need not offend one's sense of smell. However, in order for this to be true, one simple rule must be followed: anything added to the compost collection that smells bad must be covered with clean organic material. This means in your compost toilet, this means on your compost pile. Shit stinks, I don't care what Adelle Davis* said. When you defecate or urinate in your toilet, cover it. Use sawdust, use peat, use clean soil, use leaves, but keep it covered. Then there will be no odor. When you deposit smelly manure on your compost pile, cover it. Use weeds, use straw, use hay, whatever you can get your hands on (especially bulky material which will trap oxygen), but keep it covered. That's the secret. That's all there is to it (the smell issue, that is).

Dehydration will cause your bacteria to go on strike and stop working. So will freezing. Compost piles will not work if frozen, as during the cold winters of the north. However, don't despair, the bacteria will wait until the temperature rises and then they'll work like hell. I continue to add to my outdoor compost pile all winter, even when the pile is frozen solid as a rock. The freezing stage helps to destroy potential pathogens, and after the thaw, the pile works up a steam as if nothing happened. (See page 164, and appendix 4 on page 187, for charts showing the rise of temperature after a frozen pile thaws.)

Actually, I consider this whole process to be one of the miracles of nature. I take humanure with urine mixed in sawdust from our low-impact toilet, buckets of food scraps from the kitchen, armfuls of weeds from the garden, and anything else on hand, and layer it all onto a pile where it's transformed into a rich loamy garden soil before my eyes. The final product looks and smells like a beautiful soil. This process requires no electricity, no technology, no bells or whistles, no heaters, and no dancing girls. It's a model of simplicity,

The top of a compost pile should be kept somewhat flat. Keep a garden utensil handy to the compost bin for this purpose. I use an old hay fork with a broken handle. The short handle is long enough to rake the top of my pile. The flat top collects water and prevents leaching. It makes it easier to layer things on the pile. Things don't roll

off a flat-topped pile. This is just a simple and standard maintenance procedure. If the pile is frozen and can't be flattened, don't worry about it. When it thaws, flatten the top. Don't overdue it though, as your thermophiles may not like being disturbed!

Don't be confused by layering. Layering occurs naturally. Every time you add something to your pile you're adding another layer. No, you don't have to stir these layers up. Many people believe that you do, but you don't.

Don't be confused about mixing and blending the compost. This happens naturally when you add all of your organic refuse to the same compost pile, including humanure. By adding a variety of materials to the pile, you are creating a mix of ingredients, trapping oxygen into the pile, balancing nutrients, and eliminating the need to turn or stir the pile. If the bacteria like your compost, they'll heat the pile up and won't want to be disturbed by turning or stirring. If they don't like your compost, it's more than likely you're not adding a mix of materials to the pile. One can't just defecate in a 55 gallon drum, throw lime on it and expect it to compost. This is the single most common mistake I've seen made by people trying to compost humanure. They think humanure is dangerous and must be isolated, quarantined from all other compost. This is ironic, as the potential dangers of humanure are most effectively eradicated by thermophilic composting. To get a good, hot pile, you need organic material such as kitchen scraps, garden weeds, and maybe some hay or straw or leaves layered with your manure. These rough materials create interstitial air spaces in the pile that aid the aerobic digestion. They create a good blend of nutrients for the microbes. Think about it, how would *you* like it if you had only crap to eat?

THE CARBON/NITROGEN RATIO

One way to look at the blend of ingredients in your compost pile is by using the C/N ratio, the carbon/nitrogen ratio. Quite frankly, the chance of anyone measuring and monitoring the carbon and nitrogen quantities of their refuse is almost nil. This is like making wine the "foolproof" way. If composting requires this sort of drudgery, no one would do it.

However, I've found that by using all of the organic refuse my family produces, including humanure, urine, food refuse, weeds from our garden, rotting sawdust (which is hauled in), and maybe a little straw or hay now and then, we get the right mix of carbon and nitrogen for successful thermophilic composting.

Nevertheless, no discussion of composting is complete without a review of the subject of the carbon/nitrogen ratio. A good C/N ratio for a compost pile is between 20/1 and 35/1.¹⁰ That's 20 parts of carbon to one part of nitrogen, up to 35

Table 2.1
Composition of Humanure

Fecal Material -

0.3-0.6 pounds per person per day, or 135-270 grams, wet weight.

Organic Matter (dry weight).....	88-97%
Moisture Content	66-80%
Nitrogen.....	5-7%
Phosphorous.....	3-5.4%
Potassium.....	1-2.5%
Carbon.....	40-55%
Calcium.....	4-5%
C/N Ratio.....	5-10

Urine-

1.75-2.25 pints per person per day (1.0-1.3 liters)

Moisture.....	93-96%
Nitrogen.....	15-19%
Carbon.....	11-17%
Calcium.....	4.5-6%
Potassium.....	3.0-4.5%
Phosphorous.....	2.5-5%

Source: Gotaas, *Composting*, (1956), p. 35

parts of carbon to one part of nitrogen. Or, for simplicity you can figure on shooting for an optimum 30/1 ratio.

The reason this ratio is good is because the microorganisms that digest the compost need 30 parts of carbon for every part of nitrogen they consume. If there's too much nitrogen and not enough carbon, the microorganisms can't use the excess nitrogen. Then the excess nitrogen is lost in the form of ammonia gas, which you can

smell. Nitrogen loss due to excess nitrogen in the pile (a low C/N ratio) can be over 60%. At a C/N ratio of 30 or 35 to 1, only one half of one percent of the nitrogen will be lost. That's why you don't want too much nitrogen in your pile: you'll lose a lot of it in the form of ammonia gas, and nitrogen is too valuable for plants to allow it to go to waste (see Table 2.3).¹¹

Table 2.3

NITROGEN LOSS AND C/N RATIO

Initial C/N Ratio	Nitrogen Loss %
20	38.8
20.5	48.1
22	14.8
3005
3505
76	-8

Source: Gotaas, *Composting*, 1956, p. 92

The C/N ratio of humanure is between 5 and 10, or roughly around

Table 2.2 (Source: Gotaas, *Composting*, 1956, p. 44)

Carbon/Nitrogen Ratios for Some Compostable Materials

MATERIAL	% N	C/N RATIO		MATERIAL	% N	C/N RATIO
Urine	15-18	0.8		Grass Clippings	2.4	19
Humanure	5-7	5-10		Amaranth	3.6	11
Activated Sludge	5-6	6		Lettuce	3.7	----
Rotted Sawdust	0.25	208		Cabbage	3.6	12
Raw Sawdust	0.11	511		Tomato	3.3	12
Wheat Straw	0.3	128		Onion	2.65	15
Oat Straw	1.05	48		Pepper	2.6	15
Timothy Hay	0.85	58		Turnip Tops	2.3	19
Poultry Manure	6.3	----		Raw Garbage	2.15	25
Sheep Manure	3.75	----		Bread	2.10	----
Pig Manure	3.75	----		Seaweed	1.9	19
Horse Manure	2.3	----		Red Clover	1.8	27
Farmyard Manure	2.25	14		Whole Carrot	1.6	27
Cow Manure	1.7	----		Mustard	1.5	26
Blood	10-14	3		Potato Tops	1.5	25
Fish Scrap	6.5-10	----		Fern	1.15	43
Meat Scraps	5.1	----		Whole Turnip	1.0	44
Purslane	4.5	8				

The above chart reveals the ratio of carbon to nitrogen in various common organic materials. For example, the C/N ratio of rotted sawdust is 208, indicating that there are 208 parts of carbon to every one part of nitrogen. The optimum C/N ratio for compost is 25 or 30/1, so obviously sawdust should have quite a bit of nitrogen added to it to ensure vigorous microbial decomposition. It should be evident from the above chart that humanure requires a fair amount of carbonaceous material to be mixed with it in order to obtain the optimum C/N ratio of 25 or 30/1. Sawdust happens to work quite well for this purpose, especially if somewhat rotted. When rotted sawdust is used as a cover material in a compost toilet, it also very effectively eliminates odors. Presumably, many common organic materials will work well as compost toilet cover. The idea is to use what's locally available. Note that garbage has nearly an optimum C/N ratio and would feel right at home in a compost pile, and straw and hay are well suited as cover materials for compost piles when manure is to be covered. The carbon in the hay balances the nitrogen in the manure.

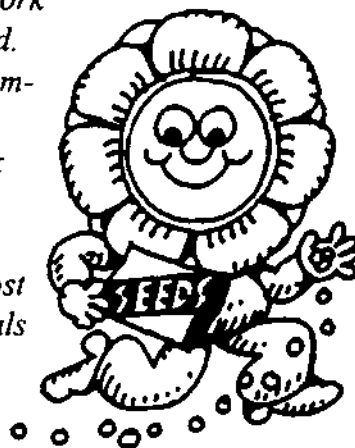

8/1, or eight parts of carbon to one part of nitrogen. Therefore, you need to add a fair amount of carbon to humanure to get a 30/1 ratio and good compost. I've found that the proper balance is obtained by putting all the organic refuse of my household in the same pile, layered with weeds, straw, hay or whatever else happens to be within reach. The humanure is collected in a twenty-liter non-corrodible receptacle where it is constantly kept covered with clean, partially rotted, hardwood sawdust (I live in a hardwood forest). The sawdust adds quite a bit of carbon, although no extra sawdust is ever added to the compost pile other than what's put into the toilet. I'm getting ahead of myself here, as I'll discuss a bio-solids (sawdust) toilet in detail in chapter 7.

MISINFORMATION

There was some literature published on the subject of composting humanure back in the 1970's which insinuated that humanure compost was practically as toxic as nuclear waste. And this information came from a publisher *promoting* the recycling of humanure.¹² Undoubtedly the publisher's intentions were good, and fecophobia (fear of fecal material) is understandable in our culture, but I must question the perpetuation of fecophobia from published information that is incomplete or incorrect. By some stroke of luck I didn't run across this book until recently, although I realize now that many of my acquaintances had been influenced by the publication and therefore feared the use of human excrement in compost. They were rendered fecophobic.

For example, the publisher had strongly recommended that human urine and feces be collected separately as the urine was "good" and the feces "bad". I had seen

FUN FACTS



Proper composting requires a balance of carbon and nitrogen in the organic material being composted. Human excreta is not properly balanced as it is too high in nitrogen, and it requires a carbon material to be added to it for the encouragement of rapid and thorough microbial decomposition. In the mid 1800's, the concept of balancing carbon and nitrogen was not known, and the high nitrogen content of humanure in dry toilets prevented the organic material from efficiently decomposing. The result was a foul, fly-attracting stench. It was thought that this problem could be alleviated by segregating urine from feces (which thereby reduced the nitrogen content of the fecal material) and dry toilets were devised to do just that. Today, the practice of segregating urine from feces is still widespread, even though the simple addition of a carbonaceous material to the feces/urine will balance the nitrogen of the material and render the segregation of urine unnecessary.

Figure 2.2
THE MARINO TOILET
 1858 - Copenhagen

Cutaway view of the chamberpot version:

Source: Rybczynski, et. al. (1982). *Low Cost Technology Options for Sanitation: A State of the Art Review and Annotated Bibliography*. World Bank (p. 10).

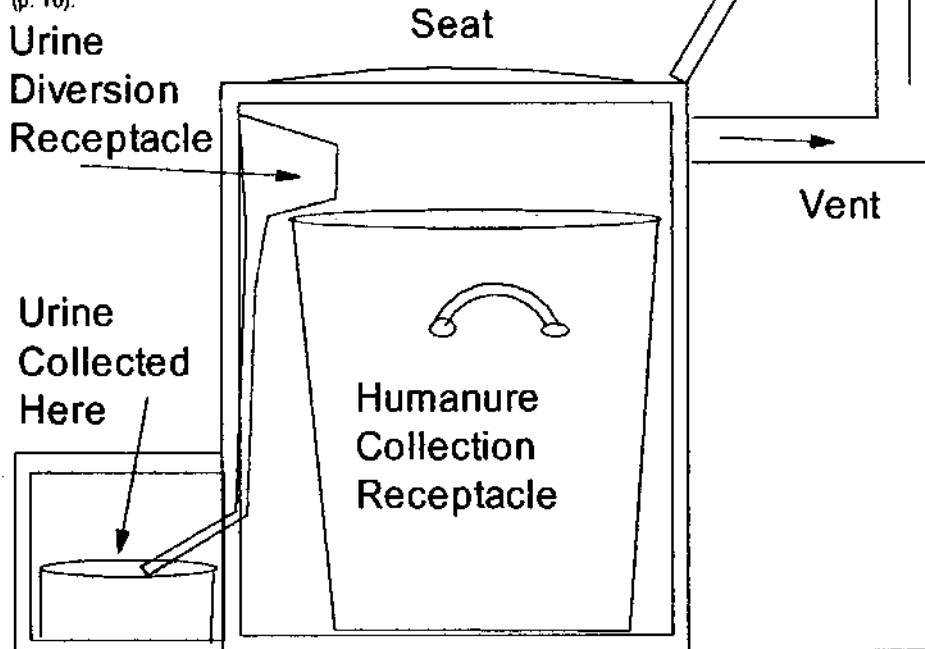

In the mid-1800's, attempts were made to devise humanure collection devices which did not require water. Since the organic material was not being composted, the urine was segregated from the fecal material to minimize odor problems. This technique is still in wide use today, even though the simple use of a semi-dry, organic cover material such as rotting sawdust in the toilet absorbs excess liquids, prevents odors, eliminates flies and makes unnecessary the need to segregate urine. Such a cover material further balances the carbon-nitrogen ratio of the organic material, rendering it suitable for composting.

people doing this, but I could never understand where they came up with this idea until I read that book and also did some additional research into the subject. Urine was to be collected in a bucket and applied to the garden or compost pile, while fecal material was to be collected in a separate receptacle and buried in a trench far away (as in a distant orchard, maybe on another planet) and covered with twelve inches of soil. Now, the idea of defecating in one receptacle and urinating in another seems bizarre enough (I've never tried it and don't intend to),

but if you think fecal material stinks, you should smell a bucket of urine. It's enough to gag a maggot.

A neighbor of mine tried the separation method recommended in the book (defecating in one receptacle and urinating in another). However, the urine stank so bad that he couldn't continue to use this method without modifying the recommended system in some way. He said it was especially repulsive when he had to pour the urine from one container to another when applying it to the garden or compost pile. Now, my neighbor is a resourceful guy and he realized that all he had to do was fill a five-gallon bucket with *sawdust* and urinate in that to eliminate the odors. This worked so well that he wrote to the publisher suggesting this improvement to the

method, but the publisher never responded.

In the Rodale Book of Composting (1992, Rodale Press, Emmaus, PA 18098), human feces is listed under “Materials to Avoid”, where we are informed that *“human feces should not be used unless they have been properly treated and permitted to age sufficiently. Even then, concerns about disease pathogens make the use of such material dubious at best for the home gardener.”*

Ironically, however, the best way to “properly treat” humanure is to thermophilically compost it, which destroys potential pathogens. When humanure is thermophilically composted and then left to age for a while, it makes a fine soil additive for the home gardener. Furthermore, humanure provides a source of nitrogen for compost-making that is available to all people. When that nitrogen source is discarded as waste, we not only lose an essential and critical compost ingredient and an agricultural resource, we also pollute the environment. Rather than perpetuate fecophobia by continuing to relentlessly portray humanure as dangerous and to be avoided, advocates of organic gardening would provide a greater service to society by objectively researching the merits of composted humanure for agricultural purposes.

For example, the World Health Organization Expert Committee on Environmental Sanitation stated at its third session in 1954 that *“the committee recognizes the widespread use, in many parts of the world, of human excreta as fertilizer . . . With the growing world population and the limited extent of world resources, all efforts to utilize sanitary by-products and return them to the soil should be encouraged. The necessity of controlling these activities in such a way as to reduce to an absolute minimum their inherent public health hazards cannot be too strongly emphasized”* (see Rybczynski et. al., 1982).

Granted, humanure can be dangerous. Drink some water polluted with fecal material that came from someone afflicted with typhoid or cholera. You’ll soon find out how dangerous humanure can be when harboring disease organisms and polluting the environment. Cars can also be dangerous. Jump out in front of one on the highway some day and you’ll see what I mean. Matches can be dangerous. Try lighting your bed sheets. No, don’t. But do you get my point? There is potential danger everywhere. Humanure has the potential to be harmful too, but when *thermophilically composted* it is transformed into a friendly and valuable material.

Perhaps Gotaas (Composting, 1956, p.21) best sums it up: *“Van Vuren was unable to demonstrate any health hazards in properly managed [humanure] composting operations in South Africa. His findings are confirmed by Blair [South Africa]; Loots [South Africa]; Hamblin [South Africa]; Acharya [India]; Scharff [Malaya]; and others in Great Britain, Germany, Australia,, the Netherlands, Denmark, and New Zealand.*

HAVE A GOOD BLEND

A sawdust-filled receptacle makes a good urine depository, as my neighbor discovered, but it can also act as a receptacle for human fecal material. Instead of beginning with a full receptacle of sawdust as with the urine receptacle, the sawdust is added after each use so that *there's a clean layer on the top at all times*. Urine is added to the same receptacle. Sawdust is added after urination as well as after defecation, if needed. Then, when the bucket is full, the whole works goes on the compost pile - feces, urine and sawdust (which is saturated with urine). The bucket is then rinsed, and the rinse water also deposited on the compost pile. This, in essence, constitutes the collection process of an absolutely minimum technology hygienic toilet. Waste is completely eliminated using this routine, *but the humanure must be thermophilically composted in a responsible and conscientious manner*. That's the missing link that must be incorporated into the process. How?

At the risk of repeating myself, you must blend the humanure with a healthy mix of other materials if you want good finished compost. What constitutes a healthy mix? If you're a serious gardener, most of your food scraps and some of your garden refuse will do. A clean cover material (such as hay, straw or weeds) ices the cake. It's that simple. I compost everything in the way of organic refuse produced on my small (no livestock,) gardening homestead, in a bin that is approximately five feet by five feet and four feet high. Everything. This provides a nice mix which produces approximately 75 cubic feet of lovely compost each year. If your garden produces large quantities of weeds at times, pile the weeds *beside* the compost bin and use them for cover material *a little at a time* (see three-chambered bin designs on page 159). This subject will be discussed in detail in chapter seven.

Compost shrinks. Unbelievably. That 5x5 bin holds a year's worth of humanure (family of four), and a year's worth of everything else. We just keep piling it on and it just keeps shrinking down and down. We pile, it shrinks. When it's all done, it stops shrinking.

Toilet paper composts too. So do the cardboard tubes in the center of the rolls. Use unscented, undyed paper if you want to keep trace contaminants out of your compost. Unbleached, recycled paper is ideal. Or you can use the old fashioned toilet paper, otherwise known as corncobs. Popcorn cobs work best, they're softer. Corncobs don't compost very readily though, so you have a good excuse not to use them. There are other things that don't compost so well: eggshells, bones, hair, and woody stems, to name a few. We throw our eggshells back to our chickens, or into the woodstove. Bones (rare in our house) go into the woodstove, too, or to the cats or

dog. Hair goes out to the birds for nests, if not into the compost pile.

And never put woody stemmed plants, such as tree saplings, on your compost pile. I hired a young lad to clear some brush for me one summer and he innocently put the small saplings on my compost pile without me knowing it. Later, I found them networked through the pile like iron reinforcing rods. I'll bet the lad's ears were itching that day - I sure had a lot of nasty things to say about him. Fortunately, only Gomer, the compost pile, heard me.



Applying thermophilically composted humanure to a raised bed garden in the springtime.

What about things like sanitary napkins and disposable diapers? Forget it. Sure, they'll compost, but they'll leave strips of plastic throughout your finished compost which is quite unsightly. Of course, that's OK if you don't mind picking the strips of plastic out of your compost. Otherwise, use cloth diapers and washable cloth menstrual pads instead.

Furthermore, it has been reported that food preserved with BHT should stay out of the compost pile, as research has shown that very small amounts of this antioxidant can alter plant growth profoundly.¹³

NEWSPAPER

What about newspapers? Yes, newspaper will compost, but there are some



The author probing a humanure compost pile in late winter. This compost had not yet become thermophilically active. Of the two thermometers, one has a long probe and the other a short one. PHOTO BY JEANINE JENKINS.

concerns about newsprint. For one, the glossy pages are covered with a clay that retards composting. For another, the inks can be petroleum-based solvents or oils with pigments containing toxic substances such as chromium, lead and cadmium in both black and colored inks. Pigment for newspaper ink still comes from benzene, toluene, naphthalene and other benzene ring hydrocarbons which may be quite harmful to human health if accumulated in the food chain. Fortunately, quite a few newspapers today are using soy-based inks instead of petroleum-based inks.** If you really want to know about the type of ink in your newspaper, call your newspaper office and ask them. Otherwise, don't use glossy paper or colored pages in your compost and keep the newspaper to a minimum. Remember, ideally, compost is being made to use for producing human food. One should try to keep the contaminants out of it if possible.¹⁴

On the other hand, Wood's End Laboratory in Maine did some research on composting ground up telephone books and newsprint, which had been used as bedding for dairy cattle. The ink in the paper contained common carcinogenic chemicals,

added made better use of lime than plots without composted sludge. The lime in the composted plots changed the pH deeper in the soil, indicating that organic matter assists calcium movement through the soil *“better than anything else”* according to Cecil Tester, Ph.D., research chemist at USDA’s Microbial Systems Lab in Beltsville, MD.¹⁶ The implications are that compost should be added to the soil when lime is added *to the soil*.

Sir Albert Howard, one of the most well-known proponents of composting, as well as J. I. Rodale, another organic gardening great, have recommended adding lime to compost piles.¹⁷ They seemed to base their reasoning on the belief that the compost will become acidic during the composting process, and therefore the acidity must be neutralized by adding lime to the pile while it’s composting. It may well be the case that compost becomes acidic during the process of decomposition, however, my experience shows me that it seems to neutralize itself if left alone, yielding a neutral end product. Therefore, I’d recommend that you make sure you need to neutralize the pH of your compost before you jump to the conclusion that you do. You can do that by testing your *finished* compost for pH.

I find it ironic that the same author who has recommended liming compost piles in one book (Rodale, as mentioned above), states in another, *“The control of pH in composting is seldom a problem requiring attention if the material is kept aerobic . . . the addition of alkaline material is rarely necessary in aerobic decomposition and, in fact, may do more harm than good because the loss of nitrogen by the evolution of ammonia as a gas will be greater at the higher pH.”*¹⁸ In other words, don’t assume that you should lime your pile. Only do so if your finished compost is consistently acidic. Get a soil pH test kit and check it out.

What is pH? It’s a measure of acidity and alkalinity. pH ranges from 1 - 14. Neutral is 7. Below seven is acidic, above seven is basic (alkaline). If the pH is too acidic or too alkaline bacterial activity will be hindered or stopped completely. Lime and wood ashes raise the pH. This is where things could get complicated, taking us into the domain of the chemist rather than the composter.

How does one become an accomplished composter, a master composter? That’s easy - just do it. Then keep doing it. Throw the books away (not this one, of course) and get some good, old-fashioned experience. There’s no better way to learn. Book learning will only get you so far, but not far enough. There’s nothing worse than someone who’s read a lot of books and thinks s/he knows everything. A book such as the one you’re now reading is for inspiring you, for sparking your interest, and for reference. But you have to get out there and do it if you really want to learn.

One’s best bet is to work with the compost, get the feel of the process, look at your compost, smell the finished product, buy or borrow a compost thermometer and

get an idea of how well your compost is heating up, then use your compost for food production. Rely on your compost. Make it a part of your life. Need it and value it. In no time, without the need for charts or graphs, Ph.D.s, or worry, your compost will be as good as the best of them. Perhaps someday we'll be like the Chinese who give prizes for the best compost in a county, then have inter-county competitions. Now *that's* getting your shit together.

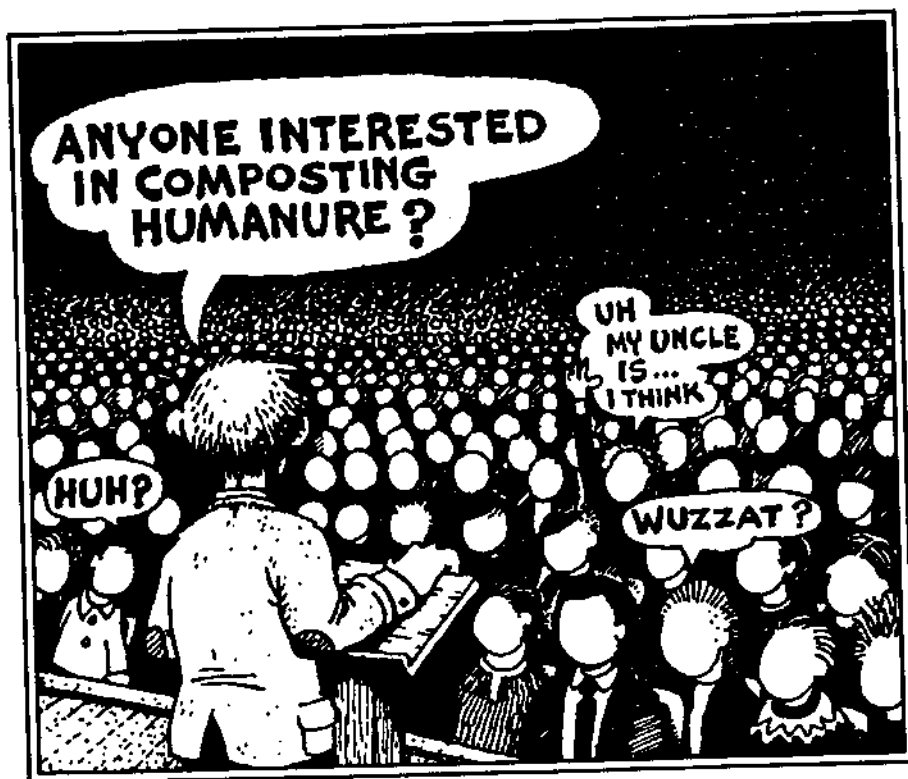

REFERENCES - CHAPTER TWO

- 1 - Bem, R., (1978). Everyone's Guide to Home Composting. Van Nostrand Reinhold Co., NY (p.4).
 - 2 - Sides, S. (1991). Compost. *Mother Earth News*. Issue 127, Aug/Sept 1991 (pp.49-53).
 - 3 - Logan, W.B. (1991). Rot is Hot. *New York Times Magazine*. 9/8/91, Vol. 140, Issue 4871. (p.46).
 - 4 - Sides, S. (1991). Compost. *Mother Earth News*. Issue 127, Aug/Sept 1991 (p.50).
 - 5 - Logan, W.B., (1991). Rot is Hot. (see #3).
 - 6 - Lubke, Sigfried. (1989). Interview: All Things Considered in the Wake of the Chernobyl Nuclear Accident. *Acres U.S.A.* December 1989. (p. 20) [also contact Uta and Sigfried Lubke, A4722 Peuerbach, Untererleinsbach 1, Austria]
 - 7 - Howard, Sir Albert, (1943). An Agricultural Testament. Oxford University Press: New York.
 - 8 - Bhamidimarri, R. (1988). Alternative Waste Treatment Systems. Elsevier Applied Science Publishers LTD., Crown House, Linton Road, Barking, Essex, IG11 8JU, England. (p.129).
 - 9 - Howard, Sir Albert, (1943). An Agricultural Testament. (p.48).
 - 10 - Stoner, C.H. (Ed.). (1977). Goodbye to the Flush Toilet. Rodale Press: Emmaus, PA, 1977. (p.46).
 - 11 - Rodale, J.I. et. al. (Eds.). (1960). The Complete Book of Composting. Rodale Books Inc.: Emmaus, Pa (pp.646-647).
 - 12 - See Stoner, Goodbye to the Flush Toilet (as above).
 - 13 - Sides, S. (as above) (p.51).
 - 14 - *Garbage: the Practical Journal for the Environment*. May/June 1992, p.66, Old House Journal Corp., 2 Main St., Gloucester, MA 01930.
 - 15 - Logan, W.B. (as above).
 - 16 - Poncavage, J. and Jesiolowski, J. (1991). Mix Up a Compost and a Lime. *Organic Gardening*. March 1991, Vol. 38, Issue 3. (p.18).
 - 17 - Howard, Sir Albert (1943). An Agricultural Testament. Oxford University Press: New York. (p.44).
- Also see:
- Rodale, J.I. (1946). Pay Dirt. The Devon-Adair Co.: New York.
- 18 - Rodale, J.I. et. al. (Eds.) (1960). The Complete Book of Composting. Rodale Books Inc.: Emmaus, PA (p.658).

*Adelle Davis was a popular nutritionist in the 1960's and 70's who advocated that people take dietary supplements to replace the lack of nutrition in the typical refined-food American diet. Much of what she wrote about in her list of books was on target. However, she also contended that a healthy person's shit won't stink. Dead wrong on that one, Adelle.

** Contact the National Soy Ink Information Center, c/o Iowa Soybean Association, 1025 Ashworth Road, No. 310, West Des Moines, Iowa 50265-3542.

DEEP SHIT

"I do not think that any civilization can be called complete until it has progressed from sophistication to unsophistication, and made a conscious return to simplicity of thinking and living."

Lin Yutang



The Asian people have recycled humanure for thousands of years. Why haven't we? This is a philosophical question which should be delved into. Now let's think about this for a second. The Asian cultures, namely Chinese, Korean, Japanese and others have evolved to understand human excrement to be a natural resource. Smelly perhaps, but not to be wasted, nor to be conceived of as a waste material. We have human waste, they have humanure (also known as night soil). We produce waste and pollution, they produce soil nutrients and food. It's clear to me that the Asians are more advanced than the Western world in this regard. And they should be, they've been working on developing sustainable lifestyles, especially sustainable agriculture for four thousand years on the same land. For four thousand years those people have worked the same land with little or no chemical fertilizers and, in many cases, have produced greater crop yields than Western farmers, the same farmers who are quickly destroying the soils of their own countries through depletion and erosion.

Here is a fact largely being ignored by people in Western agriculture: *agricultural land must produce a greater output over time because the human population is constantly increasing, but available agricultural land is not. Therefore, our farming practices should leave us with land more fertile with each passing year.* Nevertheless, we are doing just the opposite.

Back in 1938, the U.S. Department of Agriculture came to the alarming conclusion that *a full 61% of the total area under crops in the U.S. at that time had been completely or partly destroyed, or had lost most of its fertility.*¹ Nothing to worry about? We have artificial fertilizers, tractors, and oil to keep it all going? True, U.S. agriculture is heavily dependent upon fossil fuel resources. However, in 1993 we were importing about half our oil from foreign sources, and it's estimated that the U.S. will be out of domestic oil reserves by the year 2020. Some sources also report that the U.S. will be unable to export food beyond the year 2000.² If this is true, then

a heavy dependence on foreign oil for our food production seems unwise at best, and probably just plain foolish, especially when we're producing soil nutrients every day in the form of organic refuse, then throwing those nutrients "away" by burying them in landfills.

Now, it seems to me that if we want to learn something about sustainability, we would look to those people who are doing it. The Chinese have it figured out: *waste not, want not*. But there's a lot more to it than that.

Why don't we follow the Asian example? It's not for a lack of information. Dr. F. H. King wrote an interesting book, published in 1910 and titled Farmers of Forty Centuries³. Dr. King (D.Sc.) was a former chief of the Division of Soil Management of the U.S. Department of Agriculture who traveled through Japan, Korea and China in the early 1900's as an agricultural visitor. He was interested in finding out how people could farm the same fields for 4,000 years without destroying their fertility. He states:

"One of the most remarkable agricultural practices adopted by any civilized people is the centuries long and well nigh universal conservation and utilization of all human waste [sic] in China, Korea and Japan, turning it to marvelous account in the maintenance of soil fertility and in the production of food. To understand this evolution it must be recognized that mineral fertilizers so extensively employed in modern Western agriculture has been a physical impossibility to all people alike until within very recent years. With this fact must be associated the very long unbroken life of these nations and the vast numbers their farmers have been compelled to feed.

When we reflect upon the depleted fertility of our own older farm lands, comparatively few of which have seen a century's service, and upon the enormous quantity of mineral fertilizers which are being applied annually to them in order to secure paying yields, it becomes evident that the time is here when profound consideration should be given to the practices the Mongolian race has maintained through many centuries, which permit it to be said of China that one-sixth of an acre of good land is ample for the maintenance of one person, and which are feeding an average of three people per acre of farm land in the three southernmost islands of Japan.

*[Western humanity] is the most extravagant accelerator of waste the world has ever endured. His withering blight has fallen upon every living thing within his reach, himself not excepted; and his besom of destruction in the uncontrolled hands of a generation has swept into the sea soil fertility which only centuries of life could accumulate, and yet this fertility is the substratum of all that is living."*⁴

According to King's research, the average daily excreta of the adult human weighs in at 40 ounces. Multiplied by 250 million, a rough estimate of the current U.S. population, Americans each year produce 1,448,575,000 pounds of nitrogen,

456,250,000 pounds of potassium, and 193,900,000 pounds of phosphorous, almost all of which is discarded into the environment as a waste material and a pollutant, or as Dr. King puts it, "*poured into the seas, lakes or rivers and into the underground waters.*"

According to King, "*The International Concession of the city of Shanghai, in 1908, sold to a Chinese contractor the privilege of entering residences and public places early in the morning of each day and removing the night soil, receiving therefor more than \$31,000 gold, for 78,000 tons of waste [sic]. All of this we not only throw away but expend much larger sums in doing so.*"

In case you didn't catch that, the contractor paid \$31,000 gold for the humanure, referred to as "night soil" and incorrectly as "waste" by Dr. King.

Furthermore, using Dr. King's figures, the U.S. population today produces approximately 228,125,000,000 pounds of fecal material annually. That's 228 billion pounds. You could call that the *Gross National Shit*.

Admittedly, the spreading of raw human excrement on fields, as is done in Asia, will probably never become culturally acceptable in the United States, and rightly so. The use of night soil in this regard produces an assault to the sense of smell, and provides a vector for various human pathogens (disease organisms). Americans who have traveled abroad and witnessed the use of raw human excrement in agricultural applications have largely been repulsed by the experience. That repulsion has instilled among many Americans an intransigent bias against, and even a fear of the use of humanure for soil enrichment. However, few Americans have witnessed the *composting* of humanure as a preliminary step in its recycling. Proper thermophilic composting converts humanure into a pleasant smelling material devoid of human pathogens.

Although the agricultural use of raw human excrement will never become a common practice in the U.S., the use of composted human refuse, including humanure, food refuse, and other organic municipal refuse such as leaves, can and should become a widespread and culturally encouraged practice in the United States. The act of composting humanure instead of using it raw will set Americans apart from Asians in regard to the recycling of human excrements, *for we too will have to constructively deal with all of our refuse materials eventually*. We can put it off, but not forever. As it stands now, at least the Asians are recycling their refuse. We're not.

WASTE VS. MANURE, AGAIN

Human *waste* is human excrement *that is not recycled*. A waste material is

something *with no inherent value*. Waste is something we believe to be useless and we discard it. People who recycle things are not wasting them. People who compost their manure do not produce human waste in the form of body excrements.

Sorry, I know it's a hard concept to grasp, that human waste is *something we create by choice*. In the English language today, human waste is synonymous with human feces and urine. Eventually, this will change. We don't necessarily create human waste naturally. We produce human manure naturally. What we do with it constitutes whether it's waste or not. Now this may seem like a trivial matter to some. You've always known fecal material to be human waste, therefore you'll always call it human waste.

On the other hand, you may be capable of advancing your understanding. As understanding and consciousness change, so does language change. In the same way that the word "man" is no longer appropriate when referring to the human race because we've finally figured out that half of the human race is made up of women, human "waste" is no longer appropriate when referring to humanure, unless that manure is being wasted (which, in the USA, it usually is). There's no reason why we can't clarify our terms, evolve our language a bit, and thereby enhance communication and understanding.

What is human waste? Human waste is cigarette butts, empty beer cans lying along the road, plastic six-pack rings, styrofoam clamshell burger boxes, deodorant cans, disposable diapers, discarded appliances, discarded pop bottles, newspapers, old car tires, spent batteries, junk mail, nuclear garbage, convenience foods, exhaust emissions, the five billion gallons of drinking water we flush down our toilets every day, and the millions of tons of organic refuse discarded into the environment year after year after year.

My household produces one bag of waste, i.e. non-recyclable junk, every two months. Six garbage bags a year that end up in a landfill. I believe that's excessive. It's waste and my family produces it. Let's face it - six bags a year in fifty years means we've "thrown" 300 bags out into the environment. If those all stayed in my own backyard I'd eventually be living by a small mountain of garbage. Our consumption of electricity, use of internal combustion engines, and consumption of consumer goods also add to the waste my family contributes to our ecosystem. Unfortunately, in the United States we take waste for granted. It's a way of life, one promoted by our government and our business leaders and one far removed from the harmonious existence with our planet that a sustainable future requires of us. "Waste reduction - resource recovery" will not be meaningful words to Americans unless they're spoken, written, published, and most importantly, lived.

THE ADVANCES OF SCIENCE

How is it that the Asian peoples developed an excellent understanding of human nutrient recycling which pervades their collective consciousness and is completely accepted and taken for granted, and we haven't? After all, we're the advanced, developed, scientific nation, aren't we? Dr. King makes an interesting observation concerning scientists. He states:

*"It was not until 1888, and then after a prolonged war of more than thirty years, generated by the best scientists of all Europe, that it was finally conceded as demonstrated that leguminous plants acting as hosts for lower organisms living on their roots are largely responsible for the maintenance of soil nitrogen, drawing it directly from the air to which it is returned through the processes of decay. But centuries of practice had taught the Far East farmers that the culture and use of these crops are essential to enduring fertility, and so in each of the three countries the growing of legumes in rotation with other crops very extensively, for the express purpose of fertilizing the soil, is one of their old fixed practices."*⁵ [Emphasis mine.]

In our culture we believe we have to wait for the experts to figure things out before we can claim any real knowledge. This appears to have put us several centuries behind the Asians. It certainly seems odd to me that people who gain their knowledge in real life through practice and experience are shunned, ignored or trivialized by the academic world and associated government agencies. Such agencies will only credit learning that has taken place within their institutional framework. As such, it's no wonder that Western humanity's crawl toward a sustainable existence on the planet Earth is so pitifully slow.

"Strange as it may seem, says King, there are not today and apparently never have been, even in the largest and oldest cities of Japan, China or Korea, anything corresponding to the hydraulic systems of sewage disposal used now by Western nations. When I asked my interpreter if it was not the custom of the city during the winter months to discharge its night soil into the sea, as a quicker and cheaper mode of disposal [than recycling], his reply came quick and sharp, 'No, that would be waste. We throw nothing away. It is worth too much money.'"⁶ The Chinaman, says King, wastes nothing while the sacred duty of agriculture is uppermost in his mind."⁷

Perhaps, a few centuries from now, our scientific community will understand.

HOLY SHEESH

Here I must propose some philosophical speculation. My theory is this: the

Asians evolved over the millennia with a spiritual perspective that maintained, to some extent, a view of the earth, and of nature, as sacred. This was a relatively holistic spiritual perspective which did not single out the human race as being the pinnacle of creation, but instead recognized the totality of interconnected existence as sacred, and advocated human harmony with the Whole.

Now contrast this to our Western religious heritage which taught us that divinity lies only in the human form, and that peoples who revere nature are “pagans”, “heathens”, “witches” and worse. Admittedly, this is a broad and contentious topic, too broad for the scope of this book. Perhaps a few quotes here, however, will help to illustrate my point.

Hinduism, more common to India, but reaching into the Far East, seemed to be sensitive to the sanctity of the natural world:

“He who tries to give an idea of God by mere book learning is like the person who tries to give an idea of the city of Benares by means of a map or a picture.” (Shri Ramakrishna)⁸

“When Svetaketu, at his father’s bidding, had brought a ripe fruit from the banyan tree, his father said to him, Split the fruit in two, dear son.

Here you are. I have split it in two.

What do you find there?

Innumerable tiny seeds.

Then take one of the seeds and split it.

I have split the seed.

And what do you find there?

Why, nothing, nothing at all.

Ah, dear son, but this great tree cannot possibly come from nothing. Even if you cannot see with your eyes that subtle something in the seed which produces this mighty form, it is present nonetheless. That is the power, that is the spirit unseen, which pervades everywhere and is all things. Have faith! That is the spirit which lies at the root of all existence, and that also art thou, O Svetaketu.” (Chandogya Upanishad)⁹

Buddhism is a dominant influence in vast sections of Asia:

“May all living things be happy and at their ease! May they be joyous and live in safety! All beings, whether weak or strong - omitting none - in high, middle, or low realms of existence, small or great, visible or invisible, near or far away, born or

to be born - may all beings be happy and at their ease! Let none deceive another, or despise any being in any state; let none by anger or ill will wish harm to another! Even as a mother watches over and protects her only child, so with a boundless mind should one cherish all living beings, radiating friendliness over the entire world, above, below and all around without limit; so let him cultivate a boundless good will toward the entire world, uncramped, free from ill will or enmity.” (the Metta Sutra)¹⁰

Zen is a transliteration of the Sanskrit word “dyhana” meaning meditation, or more fully “contemplation leading to a higher state of consciousness”, “union with Reality”. It can be described as a blend of Indian mysticism and Chinese naturalism with a Japanese influence:

“When the mind rests serene in the oneness of things . . . dualism vanishes by itself.” (from the Hsis-hsis-ming by Seng-ts’an)¹¹

“Zen does not go along with the Judaic-Christian belief in a personal savior or a God - outside the Universe - who has created the cosmos and the human race. To the Zen view, the Universe is one indissoluble substance, one total whole, of which humanity is a part.” (Nancy Wilson Ross)¹²

Confucius, like Buddha, was born in the sixth century B.C. and preached a philosophy of common Chinese virtue:

“The path of duty lies in what is near and people seek for it in what is remote. The work of duty lies in what is easy and people seek for it in what is difficult.” (Confucius)¹³

The Tao (the way), written by Lao Tsu, a contemporary of Confucius, has provided one of the major underlying influences in Chinese thought and culture for 2,500 years:

“Those who know do not talk. Those who talk do not know. Keep your mouth closed. Guard your senses. Temper your sharpness. Simplify your problems. Mask your brightness. Be at one with the dust of the earth. This is primal union. He who has achieved this state is unconcerned with friends and enemies, with good and harm, with honor and disgrace. This therefore is the highest state of humanity.” (Lao Tsu)¹⁴

Christianity, the primary religious influence of the Western world, strongly supported the idea that humans were separate from and dominant over the natural world:

“And God said, Let us make man in our image, after our likeness, and let them have dominion over the fish of the sea, and over the fowl of the air, and over the cattle, and over all the earth, and over every creeping thing that creepeth on the earth. . . And God blessed them, and God said unto them, Be fruitful and multiply, and replenish the earth, and subdue it: and have dominion over the fish of the sea, and over the fowl of the air, and over every living thing that moveth upon the earth.” (the Bible)¹⁵

Far Eastern culture is imbued with the concepts of oneness, with the belief that the highest state of human evolution is one of harmony and peace with one's inner self and with one's outer reality, i.e. the natural world, one's society, the Universe. This would certainly seem to contribute to the development of sustainable agricultural methods. When one accepts the sacredness of life, one can easily understand why one should create compost and soil rather than waste and pollution.

WHEN THE CRAP HIT THE FAN

While the Asians were practicing sustainable agriculture and recycling their organic resources and doing so over a period of millennia, what were the people of the West doing? What were the Europeans and those of European descent doing? Why weren't our ancestors returning their manures to the soil too? After all, it does make sense. The Asians who recycled their manures not only recovered a resource and reduced pollution, but by returning their excrement to the soil they succeeded in reducing threats to their health. There was no putrid sewage collecting and breeding disease germs. Instead the humanure was, for the most part, undergoing a natural, non-chemical purification process in the soil which required no technology.

Granted, a lot of “night soil” in the Far East today is not completely composted or composted at all, and is the source of health problems in Asia. However, even the returning of humanure raw to the land succeeds in destroying many human pathogens in the manure, and returns nutrients to the soil. We'll get more into this later. Let's take a look at what was happening in Europe from, say, the 1300's on, regarding public hygiene.

Great pestilences swept Europe throughout recorded history. The Black Death killed more than half the population of England in the fourteenth century. In 1552,

67,000 patients died of the Plague in Paris alone. Fleas from infected rats were the carriers of this disease. Did the rats dine on human waste? Other pestilences included the sweating sickness (attributed to uncleanness), cholera (spread by food and water contaminated by the excrement of infected persons), "jail fever" (caused by a lack of sanitation in prisons), typhoid fever (spread by water contaminated with infected feces), and numerous others.

Andrew D. White, cofounder of Cornell University, writes, "*Nearly twenty centuries since the rise of Christianity, and down to a period within living memory, at the appearance of any pestilence the [Christian] Church authorities, instead of devising sanitary measures, have very generally preached the necessity of immediate atonement for offenses against the Almighty. In the principal towns of Europe, as well as in the country at large, down to a recent period, the most ordinary sanitary precautions were neglected, and pestilences continued to be attributed to the wrath of God or the malice of Satan.*"¹⁶

It's now known that the main cause of such immense sacrifice of life was a lack of proper hygienic practices. It's argued that certain theological reasoning at that time resisted the evolution of proper hygiene. According to Mr. White, "*For century after century the idea prevailed that filthiness was akin to holiness.*" Living in filth was regarded by holy men as an evidence of sanctity, according to Mr. White, who lists numerous saints who never bathed parts or all of their bodies, such as St. Abraham, who washed neither his hands nor his feet for fifty years, or St. Sylvia, who never washed any part of her body save her fingers.¹⁷

Interestingly, after the Black Death left its grim wake across Europe, "*an immensely increased proportion of the landed and personal property of every European country was in the hands of the church.*"¹⁸ Apparently, the church was reaping some benefit from the deaths of huge numbers of people. Perhaps the church had a vested interest in maintaining public ignorance about the sources of disease. This insinuation is almost too diabolical for serious consideration. Or is it?

Somehow, the idea developed around the 1400's that Jews and witches were causing the pestilences. Jews were suspected because they didn't succumb to the pestilences as readily as the Christian population did, presumably because they employed a unique sanitation system more conducive to cleanliness, including the eating of kosher foods. Not understanding this, the Christian population arrived at the conclusion that the Jew's immunity resulted from protection by Satan. As a result, attempts were made in all parts of Europe to stop the plagues by torturing and murdering the Jews. Twelve thousand Jews were reportedly burned to death in Bavaria alone during the time of the plague, and additionally thousands more were likewise killed throughout Europe.¹⁹

In 1484, the “infallible” Pope Innocent VIII issued a proclamation supporting the church’s opinion that witches were causes of disease, storms, and a variety of ills affecting humanity. The feeling of the church was summed up in one sentence: “*Thou shalt not suffer a witch to live.*” From the middle of the sixteenth to the middle of the seventeenth centuries, women and men were sent to torture and death by the thousands, by both Protestant and Catholic authorities. It’s estimated that the number of victims sacrificed during that century in Germany alone was over a hundred thousand.

The following case in Milan, Italy summarizes the ideas of sanitation in Europe during the seventeenth century:

The city was under the control of Spain, and had received notice from the Spanish government that witches were suspected of being on the way to Milan to “anoint the walls” (smear the walls with disease-causing ointments). The church rang the alarm from the pulpit, putting the population on the alert. One morning, in 1630, an old woman looking out of her window saw a man who was walking along the street wipe his fingers on a wall. He was promptly reported to the authorities to whom he claimed he was simply wiping ink from his fingers which had rubbed off the ink-horn he carried with him. Not satisfied with this explanation, the authorities threw the man into prison and tortured him until he “confessed”. The torture continued until the man gave the names of his “accomplices”, who were subsequently rounded up and tortured. They in turn named their “accomplices” and the process continued until members of the foremost families were included in the charges. Finally, a large number of innocent people were sentenced to their deaths, which is all reportedly a matter of record.²⁰

One loathsome disease of the 15-1700’s was the jail fever. The prisons of that period were filthy; people were confined in dungeons connected to sewers with little ventilation or drainage. Prisoners incubated the disease and spread it to the public, especially the police, lawyers and judges. In 1750, for example, the disease killed two judges, the lord mayor, various aldermen and many others in London, not to mention prisoners.²¹

The pestilences at that time in the Protestant colonies in *America* were also attributed to divine wrath or satanic malice, but when the pestilences afflicted the Native Americans, they were considered acts of divine mercy. “*The pestilence among the Indians, before the arrival of the Plymouth Colony, was attributed in a notable work of that period to the Divine purpose of clearing New England for the heralds of the gospel.*”²²

Well, let’s not get too far off the track. But perhaps the reason the Asian countries have such large populations in comparison to Western countries is because they

escaped some of the pestilences common to Europe, especially pestilences spread by the failure to responsibly recycle human excrement. They presumably plowed their manure back into the land because their spiritual perspectives supported such behavior. Westerners were too busy burning witches and Jews with the church's wholehearted assistance to bother to think about recycling humanure.

Our ancestors did eventually come to understand that poor hygiene was a causal factor in epidemic diseases. Nevertheless, it was not until the late 1800's in England that improper sanitation and sewage were suspected as causes of epidemics. At that time, large numbers of people were still dying from pestilences, especially cholera, which killed at least 130,000 people in England in 1848-9 alone. In 1849, an English medical practitioner published the theory that cholera was spread by water contaminated with sewage. Ironically, even where sewage was being piped away from the population, the sewers were still leaking into drinking water supplies.

The English government couldn't be bothered with the fact that hundreds of thousands of (mostly poor) citizens were perishing like flies year after year. So it rejected a Public Health Bill in 1847. A Public Health Bill finally became an act in 1848 in the face of the latest outbreak, but wasn't terribly effective. However, it did bring poor sanitation to the attention of the public, as the following statement from the General Board of Health (1849) implies: *"Householders of all classes should be warned that their first means of safety lies in the removal of dung heaps and solid and liquid filth of every description from beneath or about their houses and premises."* This may make one wonder if a compost heap would have been considered a "dung heap" in those days, and therefore banned.

The wealthy folks, including the Tories or "conservatives" of the English government still thought that spending on social services was a waste of money and an unacceptable infringement by the government on the private sector (sound familiar?). A leading newspaper, "The Times", maintained that the risk of cholera was preferable to being bullied by the government. However, a major act was finally passed in 1866, the Public Health Act, with only grudging support from the Tories. Once again, cholera was raging through the population, and it's probably for that reason that any act was passed at all. Finally, by the end of the 1860's, a framework of public health policy was established in England. Thankfully, that cholera epidemic of 1866 was the last and the least disastrous.²³

The powers of the church eventually diminished enough for scientists to have their much delayed say about the origins of disease. Today, the church no longer remains such an insurmountable obstacle to the progress of society, and in many cases acts as a force of hope for peace, justice, and even environmental awareness in the Western world. Our modern sanitation systems have yielded a life safe for most

of us, although not without shortcomings. The eventual solution developed by the West was to collect humanure in water and discard it, perhaps chemically treated and dehydrated, in the seas, on the surface of the land, and in landfills, somewhere away from population centers.

Finally, I'm not naive enough to suggest that the Asian societies are perfect by any stretch of the imagination. Asian history is rife with the problems that have plagued humanity since the first person hatched out of the first egg. You know what I mean: wars, oppressive rule by the rich, more war, famine, natural catastrophes, oppressive rule by heathens, more war, and now overpopulation. There is also ample evidence of diseases and parasites afflicting the Asian peoples even to this day. However, the causes of the health problems that are linked to human excrement most likely stem from the failure to responsibly compost it. Not all Asian families strive to attain impeccably clean surroundings, and they pay for their lax habits with poor health. That is a universal problem.

I'll leave you with a quote from Dr. Arthur Stanley, health officer of the city of Shanghai, China, in his annual report for 1899, when the population of China amounted to about 500 million people, roughly double that of the U.S. today, and no artificial fertilizers were being employed for agricultural purposes - only organic, natural materials such as agricultural residues and humanure were being used:

“Regarding the bearing on the sanitation of Shanghai of the relationship between Eastern and Western hygiene, it may be said, that if prolonged national life is indicative of sound sanitation, the Chinese are a race worthy of study by all who concern themselves with public health. It is evident that in China the birth rate must very considerably exceed the death rate, and have done so in an average way during the three or four thousand years that the Chinese nation has existed. Chinese hygiene, when compared to medieval English, appears to advantage.”²⁴

Sounds like an understatement to me.

REFERENCES - CHAPTER THREE

- 1 - Rodale, J. I., (1946). Paydirt. Devon-Adair Co.: NY, (p.vi).
- 2 - *Beyond Oil: The Threat to Food and Fuel in the Coming Decades, A summary Report*. November 1986. Carrying Capacity Inc., 1325 G. Street, NW, Suite 1003, Wash. D.C. 10005.
- 3 - King, F.H., (1911). Farmers of Forty Centuries. Rodale Press: Emmaus, PA 18049.
- 4 - Ibid. (p.193, 196-7).
- 5 - Ibid. (p.10).
- 6 - Ibid. (p.19).
- 7 - Ibid. (p.199).
- 8 - Wilson, N.W., (1966). Three Ways of Asian Wisdom. Simon and Shuster: New York. (p.11).
- 9 - Ibid. (p.11-12).
- 10 - Ibid. (p.77-78).
- 11 - Ibid. (p.137).
- 12 - Ibid. (p.145).
- 13 - Ibid. (p.140).
- 14 - Lao Tsu. Tao Te Ching. Vintage Books Edition, 1972. Vintage Books (Random House): New York. (#57).
- 15 - Holy Bible. King James Version. The World Publishing Co.: New York. (p.9).
- 16 - White, A.D. (1955). The Warfare of Science with Theology. George Braziller: New York. (pp.68,70).
- 17 - Ibid. (p.69).
- 18 - Ibid. (p.71).
- 19 - Ibid. (p.73).
- 20 - Ibid. (pp.76-77).
- 21 - Ibid. (p.84).
- 22 - Ibid. (p.85).
- 23 - Seaman, L.C.B. (1973). Victorian England. Methuan & Co.: London. (pp. 48-56).
- 24 - Farmers of Forty Centuries. (p.198).

**ATTENTION EARTHLINGS, I AM GIRDLOK...
FROM THE PLANET TURDNOK IN THE
CONSTELLATION ALPHA ROMEO. WE HAVE
DISCOVERED AN ANCIENT
MANUSCRIPT IN ONE OF OUR
ARCHEOLOGICAL RUINS, AMAZINGLY
IT IS WRITTEN IN EARTHLING
ENGLISH AND IT IS ABOUT YOUR
ODOROUS EXCRETIONS.
IT IS CALLED THE HUMANURE
HANDBOOK AND IT IS THE
KEY TO THE SPIRITUAL
SALVATION OF YOUR PITIFULLY
INSIGNIFICANT SPECIES.
AS AN ACT OF INTERGALACTIC
GOOD WILL WE HAVE CHOSEN
TO PUBLISH AND DISTRIBUTE
THIS BOOK ON EARTH.
WE ASK FOR NOTHING
IN RETURN ETC... ETC...
DRIBBLE... DRIBBLE...**



The Humanure Handbook - Chapter Four
A DAY IN THE LIFE OF A TURD

"Civilization is a limitless multiplication of unnecessary necessities."

Mark Twain

"Most of the luxuries, and many of the so-called comforts of life, are not only not indispensable, but positive hindrances to the elevation of [humanity]."

Henry David Thoreau



I remember when I was a kid and veterans would talk about their stints in the Korean war. Usually after a beer or two they'd turn their conversation to the "outhouses" used by the Koreans. They were amazed, even mystified about the fact that the Koreans tried to lure passers-by to use their outhouses by making the toilets especially attractive. The idea of someone wanting someone else's shit always brought out a good guffaw from the vets. Only a groveling, impoverished, backward gink would stoop so low as to beg for a turd. Haw, Haw.

Perhaps this attitude sums up the consciousness of Americans. Humanure is a waste product, plain and simple. We have to get rid of it and that's all there is to it. Only fools and scoundrels would think otherwise. One of the effects of this sort of consciousness is that Americans don't know and probably don't care where their organic refuse goes after it emerges from their backsides, so long as they don't have to deal with it.

MEXICAN BIOLOGICAL DIGESTER

Well, where it goes depends on the type of "waste disposal system" used. Let's start with the simplest: the Mexican biological digester, also known as the stray dog. In India this may be known as the stray pig (see figure 4.1). I spent a few months in southern Mexico in the late 70's in Quintana Roo on the Yucatan peninsula. There, toilets were not available and people simply used the sand dunes on the coast. No problem though, one of the small, unkempt, and ubiquitous Mexican dogs

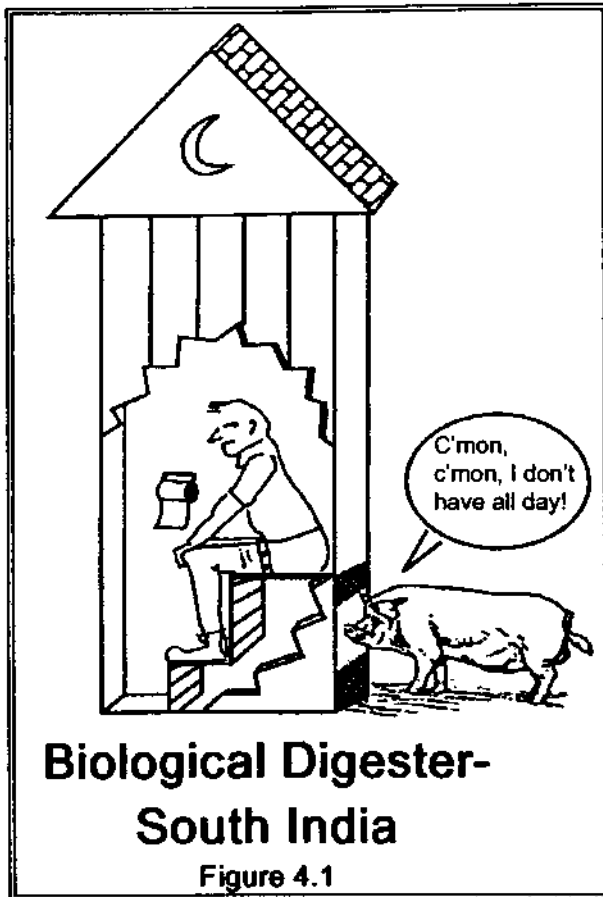

would wait nearby with watering mouth until you've done your thing. Burying your excrement in that situation would have been an act of disrespect to the dog. No one wants sand in their food. A good, healthy, steaming turd at the crack of dawn on the Caribbean coast never lasted more than 60 seconds before it became a hot meal for a human's best friend. Yum.

THE OLD-FASHIONED OUTHOUSE

Next up the ladder of sophistication is the old-fashioned outhouse, which is also known as the pit latrine. Simply stated, one digs a hole and defecates in it, and then does so again and again until the hole fills up. It's nice to have a small building (privy) over the hole to provide some privacy and to keep the elements off. However, the concept is simple: dig a hole

and bury your excrement. Interestingly, this level of sophistication has not yet been surpassed in America. We still bury our excrement, in the form of sewage sludge, in landfill holes. But I'm getting ahead of myself again.

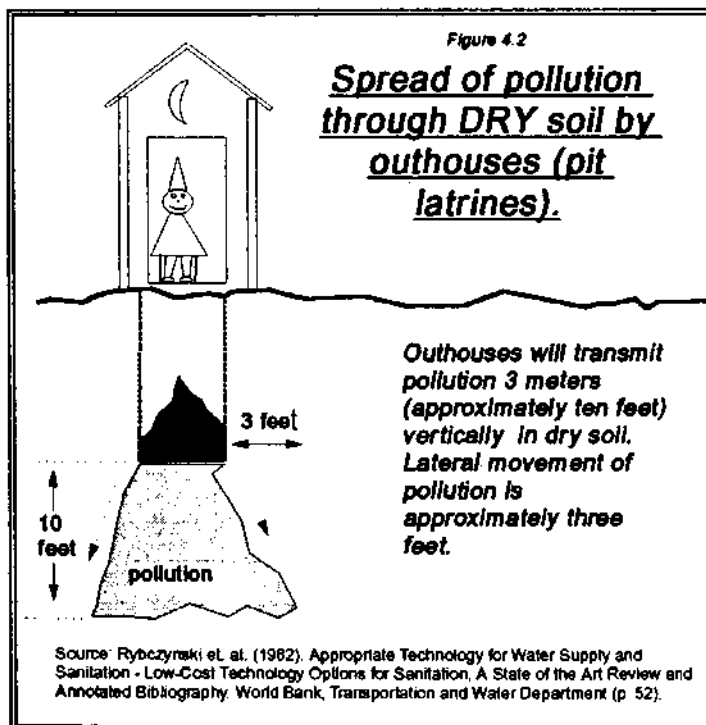

The first farmhouse I lived in during the mid-seventies had an outhouse behind it and no plumbing whatsoever. What I remember most about the outhouse is the smell, which could be described as quite undesirable, to say the least. The flies and wasps weren't very inviting either, and of course the cold weather made the process of "going to the bathroom" uncomfortable. When the hole filled up, I simply dug another hole twenty feet away from the first and dragged the outhouse from one hole to the other. The dirt from the second hole was used to cover the first. The excrement was left in

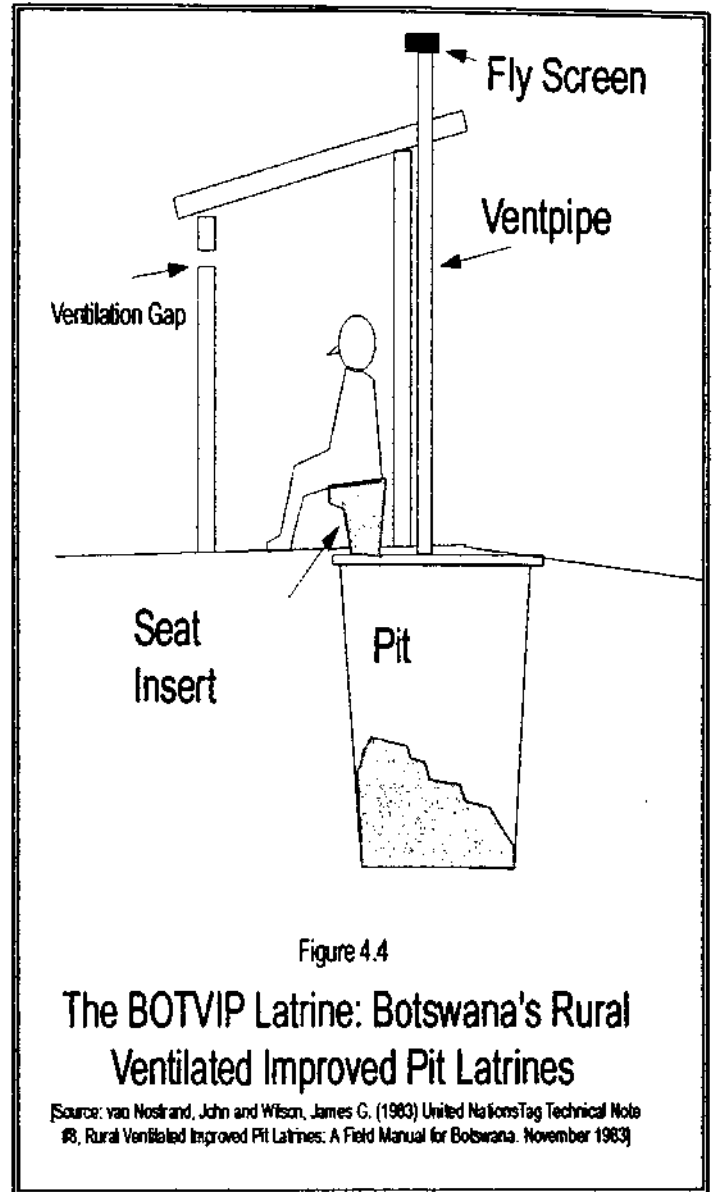
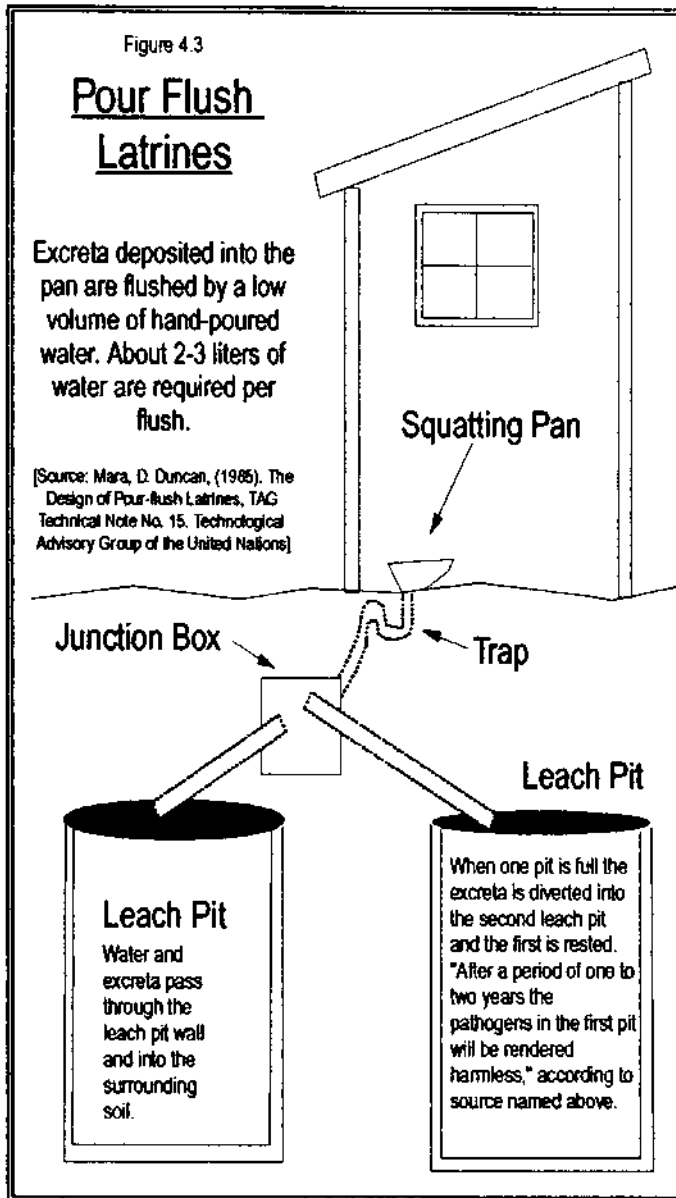

the ground, probably to contaminate groundwater. Of course, I didn't know I might be contaminating anything because, as I've stated earlier, I had just graduated from college and was quite ignorant about practical matters. Therefore, I plead not guilty to environmental pollution on the grounds of a college education.

Outhouses create very real health, environmental and aesthetic problems. The hole in the ground is accessible to flies and mosquitoes which can transmit disease over a wide area. The pits leak pollutants into the ground even in dry soil. And the smell. *Hold your nose.*

SEPTIC SYSTEMS

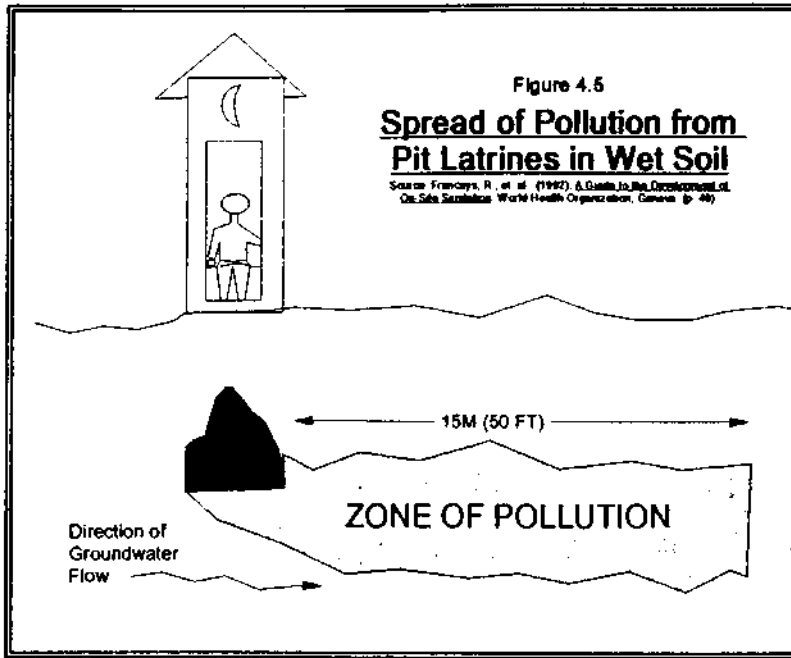

Another step up on the sophistication ladder one finds the septic tank, which is a common method of human waste disposal in rural and suburban areas of the United States. In this technique of organic waste disposal, the turd is deposited into a container of water, usually pure drinking water such as in a toilet, and the water is piped away.

After the turd, now carried by the water, travels away from the house inside a sewage pipe, it

plops into a fairly large underground storage tank, or septic tank, which is usually made of concrete and sometimes of fiberglass. In Pennsylvania (USA), a 900 gallon tank is the minimum size allowed for a home with three or fewer bedrooms.¹ The heavier solids settle to the bottom of the tank and the liquids continue on to drain off into a leach field, which consists of an array of drain pipes situated below the ground surface allowing the liquid to seep out into the soil (see figures 4.6 and 4.7). While in the tank, the wastewater should be undergoing anaerobic decomposition. If septic

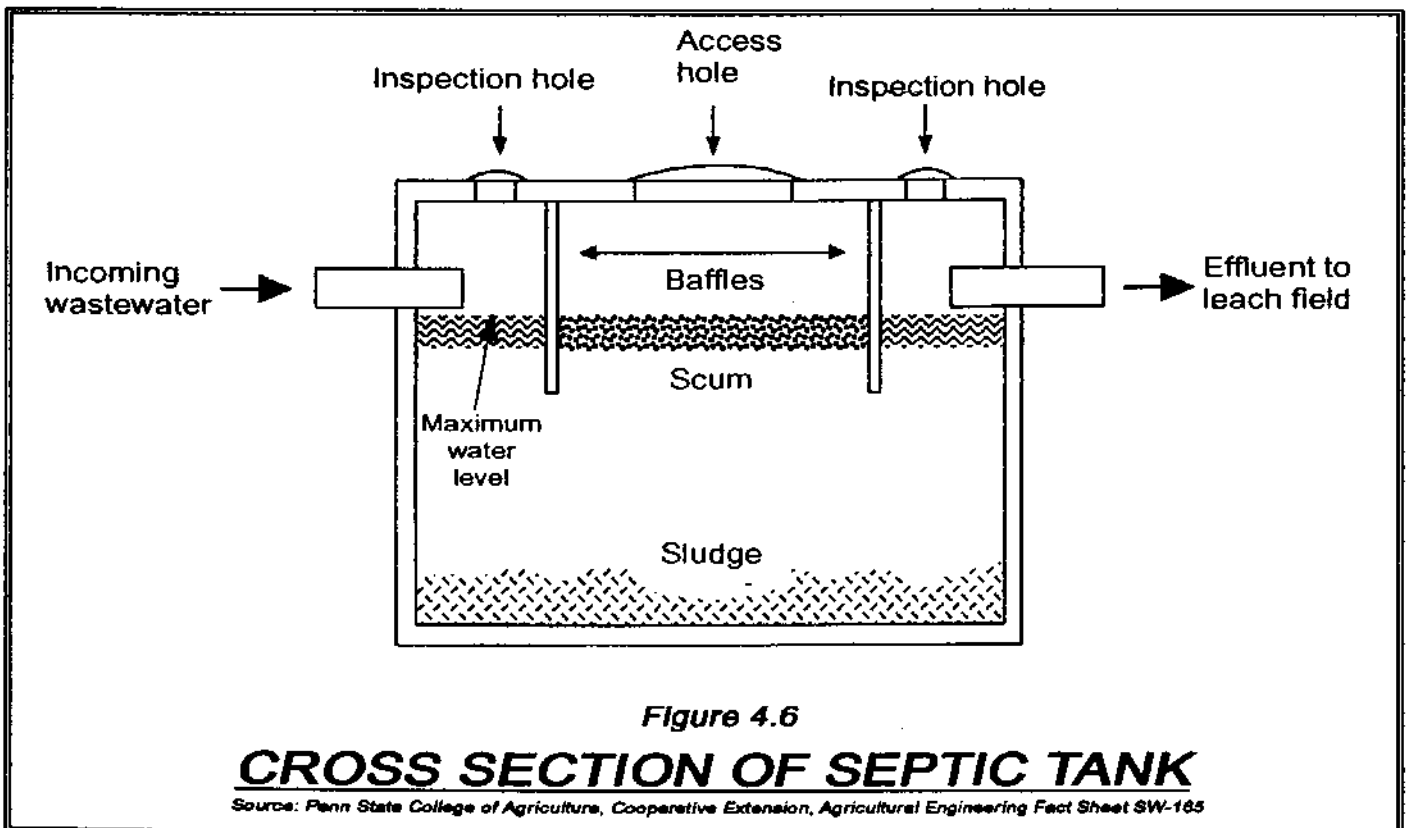

tanks fill up, they are pumped out and the waste material is supposed to be trucked to a sewage treatment plant.

SAND MOUNDS

Some soils drain poorly because they may have a high clay content or may be low-lying or otherwise water impermeable. In the event of poorly drained soil, a standard leach field will not work very well, especially when the ground is saturated with rain water or snow melt. One can't drain

wastewater into soil that is already saturated with water. That's when the *sand mound* sewage disposal system is useful. In this method of waste disposal, when the septic tank isn't draining properly, a pump will kick in and pump the effluent into a pile of sand and gravel above ground (although sometimes a pump isn't necessary and gravity does the job). In the pile of sand is a perforated pipeline which allows the effluent to drain down through the mound. Sand mounds are usually covered with soil and grass. In Pennsylvania, sand mounds must be at least one hundred feet downslope from a well or spring, fifty feet from a stream, and five feet from a property line.²

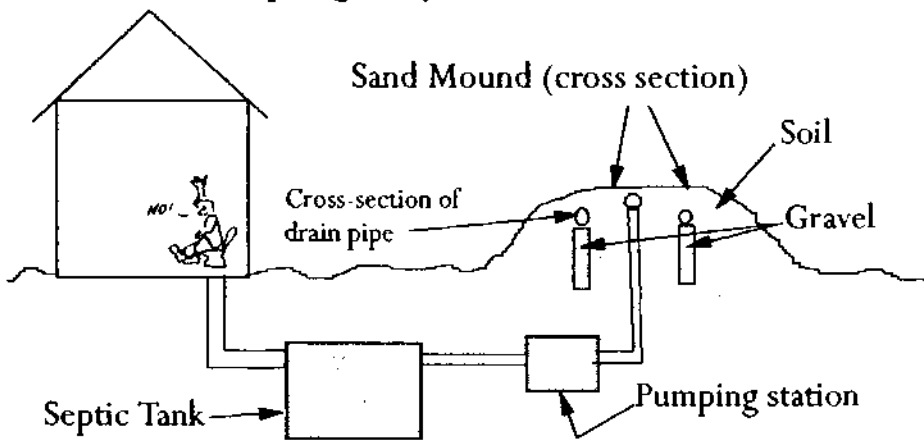
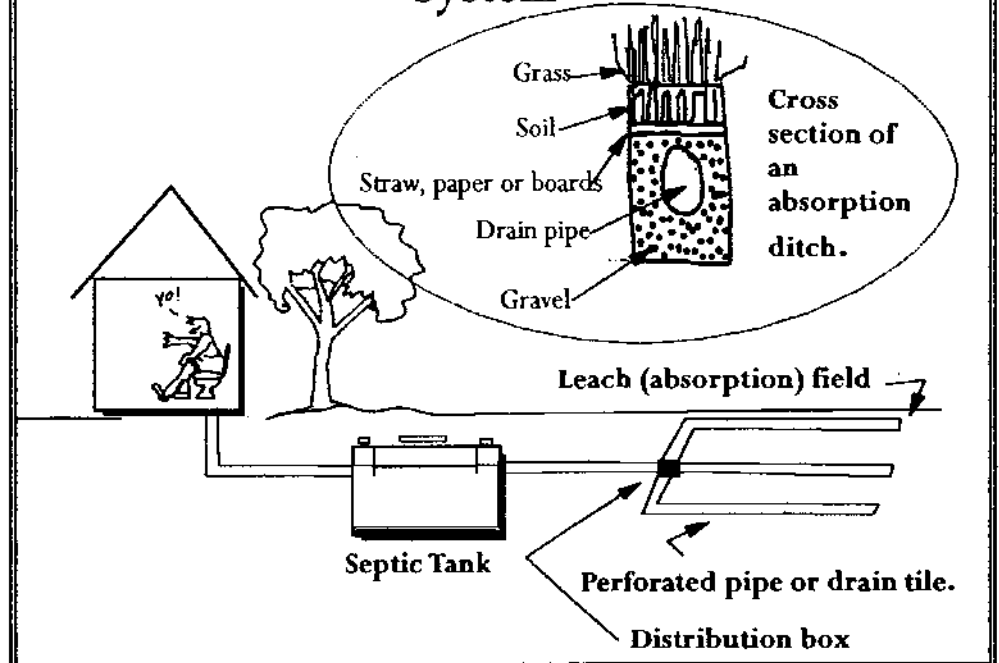

Figure 4.8

Sand Mound (or Trench Mound) Waste Distribution System

Figure 4.7

Septic Tank Gravity Distribution System



According to local excavating contractors, sand mounds cost \$5,000 to \$12,000 to construct (1993). They must be built to exact government specifications, and aren't usable until they pass an official inspection (see figure 4.8).

GROUND WATER POLLUTION FROM SEPTIC SYSTEMS

We civilized humans started out by defecating into a hole in the ground (outhouse), then discovered we could float our turds out to the hole using water and never have to leave the house. However, one of the unfortunate problems with septic systems is, like outhouses, they pollute our groundwater.



**IF you have a
Septic Tank System...**

There are currently 22 million septic system sites in the United States issuing contaminants such as bacteria, viruses, nitrates, phosphates, chlorides, and organic compounds such as trichloroethylene into the environment. An EPA study of chemicals in septic tanks found toluene, methylene chloride, benzene, chloroform, and other volatile synthetic organic compounds related to home chemical use.³ Between 820 and 1,460 billion gallons of this contaminated water are discharged per year to our shallowest aquifers.⁴ According to the EPA, states reported septic tanks as a source of ground water contamination more than any other source, with 46 states citing septic systems as sources

of groundwater pollution, and nine of these reporting them to be the primary source of groundwater contamination in their state⁵ (see figures 4.9 and 4.10).

The word "septic" comes from the Greek "septikos" which means "to make putrid". Today it still means "causing putrefaction", putrefaction being "the decomposition of organic matter resulting in the formation of foul-smelling products" (see

Figure 4.9

Sources of Ground-Water Contamination in the United States

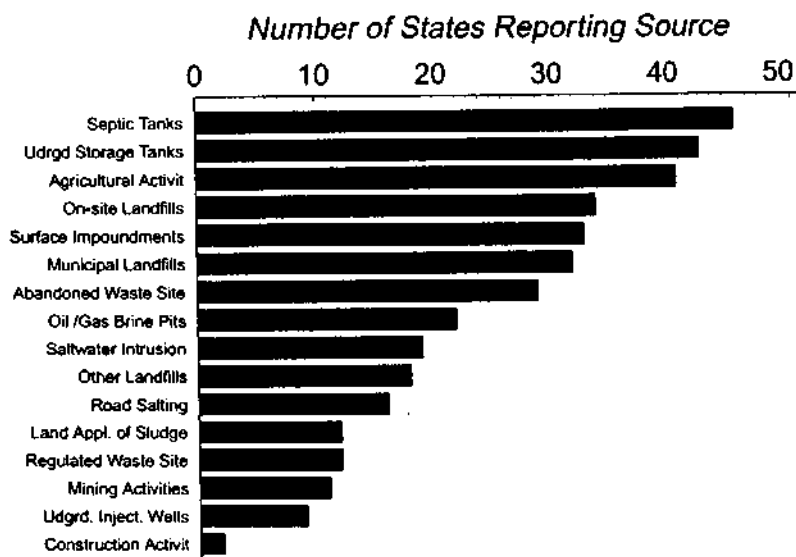

Source: U.S. Environmental Protection Agency, National Water Quality Inventory 1986 Report to Congress, EPA-440/4-87-008

Webster). Septic systems are not designed to destroy human pathogens that may be in the human waste that enters the septic tank. Septic systems are instead designed to collect human wastewater, settle out the solids and anaerobically digest them to some extent, and then leach the effluent into the ground. Therefore, septic systems can be highly pathogenic, allowing the transmission of disease-causing bacteria, viruses, protozoa and intestinal parasites through the system.

One of the main problems associated with septic systems is the problem of human population density. Too many septic systems in any given area will overload the soil's natural purification systems and allow large amounts of wastewater to contaminate the underlying watertable. A density of more than forty household septic systems per square mile will cause an area to become a likely target for subsurface contamination, according to the EPA.⁶

Toxic synthetic organic chemicals are commonly released into the environment from septic systems because people dump toxic chemicals down their drains. The chemicals are found in pesticides, paint and coating products, toilet cleaners, drain cleaners, disinfectants, laundry solvents, many other cleaning solutions, antifreeze, rust proofers, even septic tank and cesspool cleaners. In fact, over 400,000 gallons of septic tank cleaner liquids containing synthetic organic chemicals were used in one year by just the residents of Long Island alone. Furthermore, some synthetic organic chemicals can corrode pipes thereby causing even more heavy metals to enter septic systems.⁷

In many cases, people who have septic tanks are forced to connect to sewage lines when the lines are made available to them. A U.S. Supreme Court case in 1992 reviewed a situation whereby town members in New Hampshire had been forced to connect to a sewage line that simply discharged untreated, raw sewage into the Connecticut River for 57 years. Despite the crude

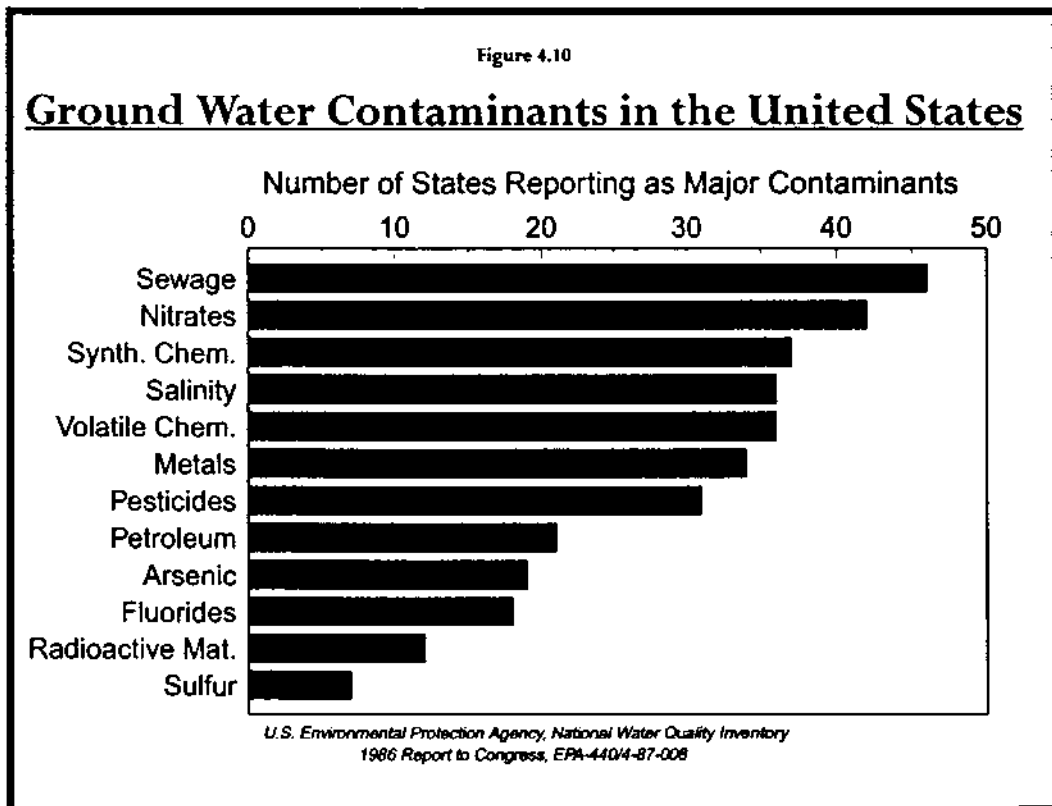

method of sewage disposal, state law required properties within 100 feet of the town sewer system to connect to the system when it was built in 1932. This sewage disposal system apparently continued to operate in this barbaric manner until 1989, when state and federal sewage treatment laws forced a stop to the dumping of raw sewage into the river.⁸

WASTEWATER TREATMENT PLANTS

There's still another step up the ladder of wastewater treatment sophistication: the wastewater treatment plant, or sewage plant. The wastewater treatment plant is like a huge, very sophisticated septic tank, because it collects the water-borne excrement of large numbers of humans. Inevitably, when one defecates or urinates into water, one pollutes the water. Therefore, that "wastewater" must somehow be rendered fit to return to the environment in order to avoid environmental pollution. The liquid entering the wastewater treatment plant is 99% water because all sink water, bath water and everything else that goes down one's drain ends up at the plant too, which is why it's called a *water* treatment plant. In some cases, storm water runoff also enters wastewater treatment plants via *combined sewers*. Also, a lot of contaminants can and do enter this wastewater stream from industries, hospitals, gas stations, and any place with a drain.

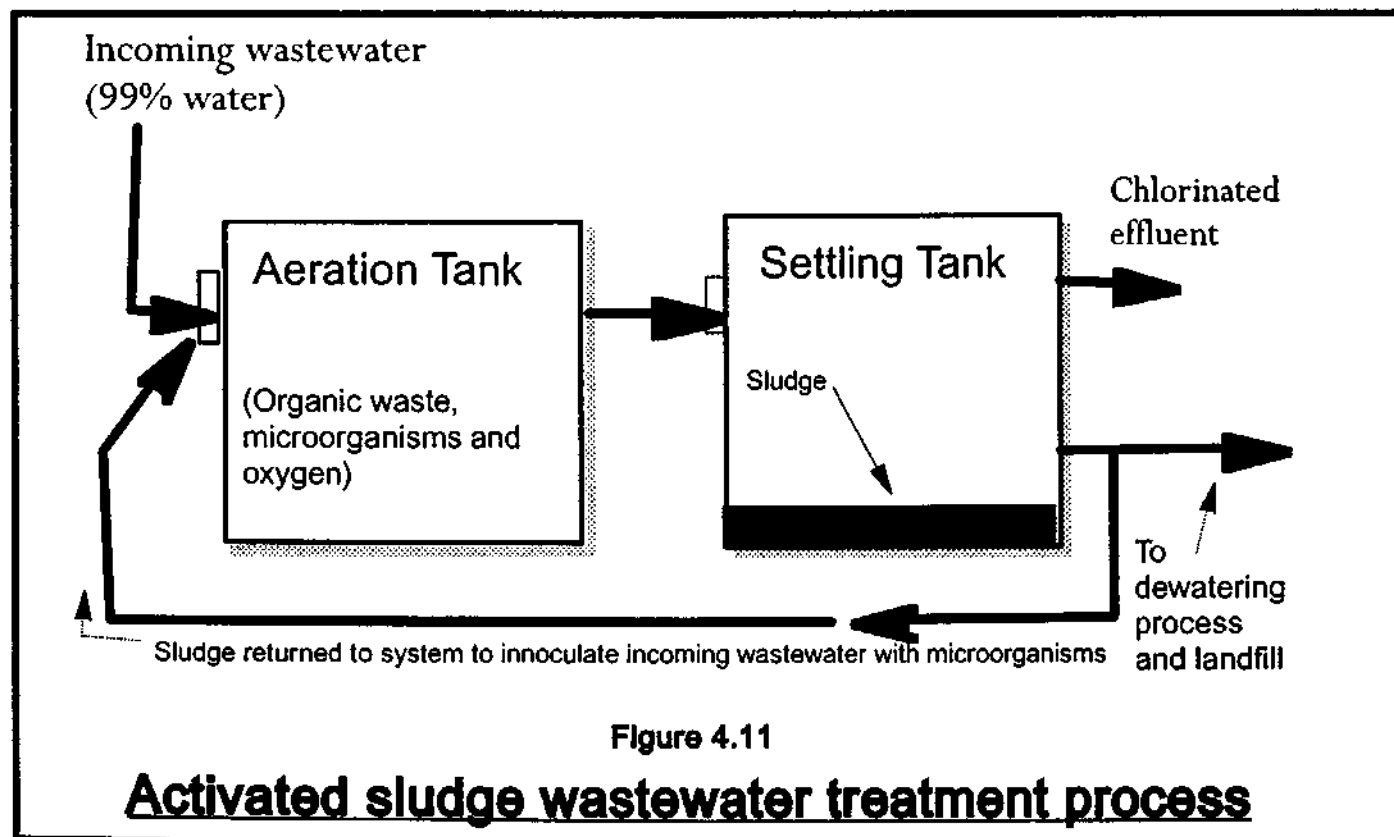

Many modern wastewater plants use a process of activated sludge treatment whereby oxygen is vigorously bubbled through the wastewater in order to activate microbial digestion of the solids. This aeration stage is combined with a settling stage that allows the solids to be removed. The removed solids (sludge) are either used to reinoculate the incoming wastewater, or they're dewatered to the consistency of a dry mud and buried in landfills (see figure 4.11). Sometimes the sludge is applied to agricultural land. The microbes that digest the sludge consist of bacteria, fungi, protozoa, rotifers, and nematodes.⁹ The water left behind is treated (usually with chlorine) and discharged into a stream, river, or other body of water. Sewage treatment water releases to surface water in the United States in 1985 amounted to nearly *31 billion gallons per day*.¹⁰

U.S. sewage treatment plants generated about 7.6 million dry tons of sludge in 1989.¹¹ New York City alone produces 143,810 dry tons of sludge every year.¹² In 1993, the amount of sewage sludge produced annually in the U.S. was 110-150 million wet metric tons. Incidentally, the amount of toilet paper used (1991) to send all this waste to the sewers was 2.3 million tons.¹³

CHLORINE

Wastewater leaving wastewater treatment plants is often treated with chlorine before being released into the environment. For this reason, the act of defecating into water often ultimately contributes to the contamination of water resources with *chlorine* in addition to feces.

Chlorine, used since the early 1900's, is one of the most widely produced industrial chemicals with about 10 million metric tons manufactured in the U.S. each year - \$72 billion worth.¹⁴ Approximately 5% of the chlorine manufactured is used for wastewater treatment and drinking water "purification", amounting to about 1.2 billion pounds annually. The lethal liquid or green gas is mixed with the wastewater from sewage treatment plants, in order to kill disease causing microorganisms, before the water is discharged into streams, lakes, rivers and seas. It is also added to household drinking water via household and municipal water treatment systems.

Chlorine (CL₂) doesn't exist in nature. It's a potent poison which reacts with water to produce a strongly oxidizing solution that can damage the moist tissue lining of the human respiratory tract. Ten to twenty parts per million (ppm) of chlorine gas in air rapidly irritates the respiratory tract, and even brief exposure at levels of 1,000 ppm (one part in a thousand) can be fatal.¹⁵ Chlorine also kills fish, and reports of fish kills caused chlorine to come under the scrutiny of scientists in the 1970's.

The fact that harmful compounds are formed as *by-products* of chlorine use also raises concern. In 1976, the U.S. Environmental Protection Agency (EPA) reported that chlorine use not only poisoned fish, but could also cause the formation of cancer-causing compounds such as chloroform. Some known effects of chlorine-based pollutants on animal life include memory problems, stunted growth and cancer in people; reproductive problems in minks and otters; reproductive problems, hatching problems and death in lake trout; and embryo abnormalities and death in snapping turtles.¹⁶

In a national study of 6,400 municipal wastewater treatment plants, the EPA estimated that two thirds of them used too much chlorine, which exerts lethal effects at all levels of the food chain. Chlorine damages the gills of fish, inhibiting their ability to absorb oxygen. It also can cause behavioral changes in fish, thereby affecting migration and reproduction. Chlorine in streams can create chemical “dams” which prevent the free movement of some migratory fish. Fortunately, since 1984, there has been a 98% reduction in the use of chlorine by sewage treatment plants, although chlorine use continues to be a widespread problem because a lot of wastewater plants are still discharging it into small receiving waters.¹⁷

Another controversy associated with chlorine use involves “dioxin”, which is a common term for a large number of chlorinated chemicals that are classified as possible human carcinogens by the EPA. It’s known that dioxins cause cancer in laboratory animals, but their effects on humans are still being debated. Dioxins, byproducts of the chemical manufacturing industry, are present in the total environment, and are concentrated through the food chain where they’re deposited in human fat tissues. A key ingredient in the formation of dioxin is chlorine, and indications are that an increase in the use of chlorine results in an increase in the dioxin content of the environment, even in areas where the only dioxin source is the atmosphere.¹⁸ Dioxins are unintended byproducts of chlorine use.

In the upper atmosphere, chlorine molecules gobble up ozone, in the lower atmosphere they bond with carbon to form organochlorines. Some of the 11,000 commercially used organochlorines include hazardous compounds such as DDT, PCBs and carbon tetrachloride. Organochlorines rarely occur in nature, and living things have little defense against them. They’ve been linked not only to cancer, but also to neurological damage, immune suppression, and reproductive and developmental effects. When chlorine products are washed down the drain to a septic tank, they’re producing organochlorines.

“Any use of chlorine results in compounds that cause a wide range of ailments,” says Joe Thorton, a Greenpeace researcher, who adds, *“Chlorine is simply not compatible with life. Once you create it you can’t control it.”*¹⁹

There’s no doubt that our nation’s sewage treatment systems are polluting our

drinking water sources with pathogens (see chapter 6). As a result, chlorine is also being used to disinfect *the water we drink* as well as to disinfect discharges from wastewater treatment facilities.



According to a 1992 study, *chlorine is added to 75% of the nation's drinking water* and is linked to cancer. The results of the study suggested that at least 4,200 cases of bladder cancer and 6,500 cases of rectal cancer each year in the U.S. are associated with consumption of chlorinated drinking water.²⁰

In December, 1992, the U.S. Public Health Service reported that pregnant women who routinely drink or bathe in chlorinated tap water are at a greater risk of bearing premature or small babies, or babies with congenital defects.²¹

According to a spokesperson for the chlorine industry, 87% of water systems in the U.S. use free chlorines, and 11% use chloramines. Chloramines are a combination of chlorine and ammonia. The chloramine treatment is becoming more widespread due to the health concerns over chlorine.²² However, EPA scientists admit that we're pretty ignorant about the potential byproducts of the chloramine process, which involves ozonation of the water prior to the addition of chloramine.²³

Of course, we don't have to worry. The government will take care of us, and if the government doesn't, then industry will. Won't they? Well, not exactly. According to a U.S. General Accounting Office report in 1992, consumers are poorly informed about potentially serious violations of drinking water standards. In a review of twenty water systems in six states, out of 157 drinking water quality violations, the public received a timely notice in only 17 of the cases.²⁴

ALTERNATIVE WASTEWATER TREATMENT SYSTEMS

New systems are being developed to purify wastewater. One popular experimental system today is the *constructed, or artificial wetlands system*, which runs wastewater through an aquatic environment consisting of aquatic plants such as water hyacinths, bullrushes, duckweed, lilies, and cattails (see figure 4.12). The plants act

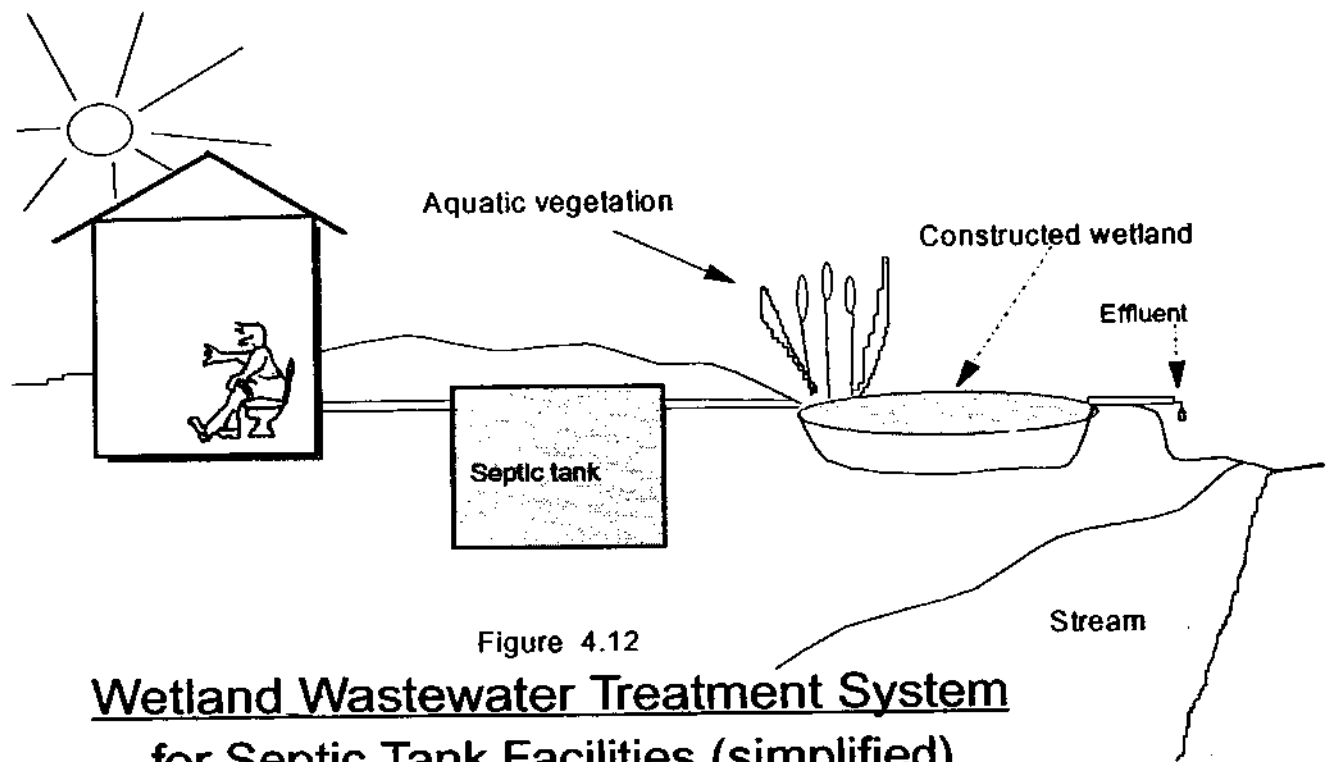

Figure 4.12

Wetland Wastewater Treatment System for Septic Tank Facilities (simplified)

as marsh filters, and the microbes which thrive on their roots do most of the work. They break down nitrogen and phosphorous compounds as well as toxic chemicals. Although they don't break down heavy metals, the plants absorb them, and they can then be harvested and incinerated or landfilled.²⁵

According to EPA officials, the emergence of constructed wetlands technology shows great potential as a cost effective alternative to wastewater treatment. The wetlands method is said to be relatively affordable, energy efficient, practical and effective. However, scientists don't yet have the data to determine with assurance the performance expectations of wetlands systems, or contaminant concentrations released by these systems into the environment. However, the treatment efficiency of properly constructed wetlands is said to compare well with conventional treatment systems.²⁶ Unfortunately, wetlands systems don't recover the agricultural resources available in humanure.

Another system uses solar powered greenhouse-like technology to treat wastewater. This system uses hundreds of species of bacteria, fungi, protozoa, snails, plants and fish, among other things, to produce advanced levels of wastewater treatment. These solar aquatics systems are also experimental, but appear hopeful.²⁷ Again, the agricultural resources of humanure are lost when using this or any disposal method or wastewater treatment technique instead of a humanure recycling method.

AGRICULTURAL USE OF SEWAGE SLUDGE

Now here's where a thoughtful person may ask, "Why not put *sewage sludge* back into the soil for agricultural purposes?"

One reason: government regulation. When I asked the supervisor of my local wastewater treatment plant if the one million gallons of sludge the plant produces each year (for a population of 8,000) was being applied to agricultural land, he said, "*It takes six months and five thousand dollars to get a permit for a land application. Another problem is that due to regulations, the sludge can't lie on the surface after it's applied so it has to be plowed under shortly after application. When farmers get the right conditions to plow their fields, they plow them. They can't wait around for us, and we can't have sludge ready to go at plowing time.*" It may be just as well.

Sewage sludge is a lot more than organic human refuse. It can contain DDT, PCBs, mercury, other heavy metals, and the like.²⁸ One scientist alleges that more than 20 million gallons of used motor oil are dumped into sewers every year in the United States.²⁹ America's largest industrial facilities released over 550 million pounds of toxic pollutants into U.S. sewers in 1989 alone, according to the U.S. Public Interest Research Group. In 1987, 614 million pounds of toxic pollutants were released into sewers, and in 1988, another 570 million pounds were released, although the actual levels of toxic discharges are said to be much higher than these.³⁰ Of the top ten states responsible for toxic discharges to public sewers in 1991, Michigan took the cake with nearly 80 million pounds, followed in order by New Jersey, Illinois, California, Texas, Virginia, Ohio, Tennessee, Wisconsin and Pennsylvania (around 20 million pounds from PA).³¹

An interesting study on the agricultural use of sludge was done by a Mr. Purves in Scotland. He began applying sewage sludge at the rate of 60 tons per acre to a plot of land in 1971. After fifteen years of treating the soil with the sludge, he tested the vegetation grown on the plot for heavy metals. On finding that the heavy metals (lead, copper, nickel, zinc and cadmium) had been taken up by the plants, he concluded, "*Contamination of soils with a wide range of potentially toxic metals following application of sewage sludge is therefore virtually irreversible.*"³² In other words, the heavy metals don't wash out of the soil, they enter the food chain.

Other studies have shown that heavy metals accumulate in the vegetable tissue of the plant to a much greater extent than in the fruits, roots or tubers. Therefore, if one must grow food crops on soil fertilized with sewage sludge contaminated with heavy metals, one might be wise to produce carrots or potatoes instead of lettuce.³³ Guinea pigs experimentally fed with swiss chard grown on soil fertilized with sewage sludge showed no observable toxicological effects, however their adrenals showed

elevated levels of antimony, their kidneys had elevated levels of cadmium, there was elevated manganese in the liver and elevated tin in several other tissues.³⁴

Furthermore, *“the fact that sewage sludge contains a large population of fecal coliforms renders it suspect as a potential vector of bacterial pathogens and a possible contaminant of soil, water and air, not to mention crops. Numerous investigations in different parts of the world have confirmed the presence of intestinal pathogenic bacteria and animal parasites in sewage, sludge, and fecal materials.”*³⁵ (See chapter 6)

Another interesting study was published in 1989 indicating that the bacteria that survive in sewage sludge show a high level of resistance to antibiotics, especially penicillin, one of the most commonly used. The theory is this: because heavy metals are concentrated in sludge during the treatment process, the bacteria that survive in the sludge can obviously resist heavy metal poisoning. But these same bacteria also show an inexplicable resistance to antibiotics, suggesting that somehow the resistance of the two environmental factors are related in the bacterial strains that survive. The implication is that sewage sludge selectively breeds antibiotic-resistant bacteria, which may enter the food chain if the agricultural use of the sludge becomes widespread. The results of the study indicated that more knowledge of antibiotic-resistant bacteria in sewage sludge should be acquired before sludge is disposed of on land, as this method of disposal can be dispersing countless antibiotic resistant bacteria into the environment.³⁶

This poses somewhat of a problem. Collecting human excrement with wastewater and industrial pollutants seems to render the organic refuse incapable of being adequately sanitized. It becomes contaminated enough to be unfit for agricultural purposes. As a consequence, sewage sludge is not highly sought after as a soil additive. For example, the state of Texas sued the U.S. EPA in July of 1992 for failing to study environmental risks before approving the spreading of sewage sludge in west Texas. Sludge was being spread on 128,000 acres there by an Oklahoma firm, but the judge nevertheless refused to issue an injunction to stop the spreading.³⁷ Considering that the sludge was from New York City, who can blame the Texans?

Now that ocean dumping of sludge has been stopped, where's it going to go? Researchers at Cornell University have suggested that sewage sludge can be disposed of by surface applications in forests. Their studies suggest that brief and intermittent applications of sludge to forestlands won't adversely affect wildlife, despite the nitrates and heavy metals that are present in the sludge. They point out that the need to find ways to get rid of sludge is compounded by the fact that many landfills are expected to close over the next several years and ocean dumping is now banned. Some sources say that landfills in the U.S. are being closed permanently at the rate of

two per day.³⁸ In a report to congress by the EPA in 1989, 45% of the landfills then currently in operation were expected to be closed by 1991.³⁹

Under the Cornell model, one dry ton of sludge could be applied to an acre of forest each year.⁴⁰ New York state alone produces 370,000 tons of dry sludge per year, which would require 370,000 acres of forest each year for New York state sludge disposal. Then there are the other forty-nine states and the 7.6 million dry tons of sludge produced in the U.S.. Then there's figuring out how to get the sludge into the forests and how to spread it around. With all this in mind, a guy has to stop and wonder. The woods used to be the only place left to get away from it all.*

The problem of treating and dumping sludge isn't the only one. The costs of maintenance and upkeep of wastewater treatment plants is another. According to a report issued by the EPA in 1992, U.S. cities and towns need as much as \$110.6 billion over the next twenty years for enlarging, upgrading, and constructing wastewater treatment facilities.⁴¹

Ironically, when sludge is *composted*, it may help to keep heavy metals *out* of the food chain. According to a 1992 report, composted sludge lowered the uptake of lead in lettuce that had been deliberately planted in lead-contaminated soil. The lettuce grown in the contaminated soil to which composted sludge had been added had a 64% lower uptake of lead than lettuce planted in the same soil but without the compost. The composted soil also lowered lead uptake in spinach, beets and carrots by more than 50%.⁴² Three cheers for compost!

Some scientists claim that the composting process transforms heavy metals into benign materials. According to Joseph C. Horvath, a soil and compost scientist who designs facilities that compost sewage sludge, "*at the final product stage, these [heavy] metals actually become beneficial micro-nutrients and trace minerals that*

SEWER TROUBLE?

"Root Eliminator" KEEPS Sewers & Septic Tanks OPEN

Easy-to-use chemical prevents and frees stoppage of sewer by roots. Just drop one soluble briquette in your lavatory monthly.

A year's supply for only \$3.95

Show this ad to your local store, or mail your order direct to us. Sent promptly, postpaid.



BETTER LIVING THROUGH CHEMICALS

MONEY BACK GUARANTEE

Dripless toilets China's top priority

BEIJING, June 7 — With oceans of scarce water literally going down China's drains, Communist Party chief Jiang Zemin has made the dripless toilet a national priority. "If the country can send satellites and missiles into space, it should be able to dry up its latrines," today's China Daily quoted Jiang as saying. The Construction Ministry estimates leaky toilets sold by negligent manufacturers waste 200 million cubic meters of water a year. Vice Minister of Construction Ye Rutang launched a purge of leaky and sub-standard toilet hardware. Three hundred of China's 570 cities, including the capital, Beijing, face serious water shortages, China Daily said.

(From a Saudi Arabian newspaper, 1994)

add to the productivity of soil. This principal is now finding acceptance in the scientific community of the USA and is known as biological transmutation, or also known as the Kervran-Effect." Composted sewage sludge that is microbiologically active can also be used to detoxify areas contaminated with nuclear radiation or oil spills, according to Dr. Horvath. Clearly, the composting of sewage sludge is a grossly underutilized alternative to landfill application, and it should be strongly promoted.**

GLOBAL SEWERS AND PET TURDS

Let's assume that the whole world adopted the sewage philosophy we have in the United States: defecate into water and then treat the polluted water. What would that scenario be like? Well, for one thing it wouldn't work. It takes between 1,000 and 2,000 tons of water at various stages in the process to flush one ton of humanure. In a world of just five billion people producing a conservative estimate of one million metric tons of human excrement daily, the amount of water required to flush it all would not be obtainable.⁴³ When one adds to this equation the increasing landfill space that would be needed to dispose of the increasing amounts of sewage sludge, and the tons of toxic chemicals required to "sterilize" the wastewater, then one can

see that this system of human waste disposal is not sustainable and will not serve the needs of humanity in the long term.

As one person puts it, "Conventional 'Western' methods of waterborne sewerage are simply beyond the reach of most [of the world's] communities. They are far too expensive. And they often demand a level of water use that local water resources cannot supply. If Western standards were made the norm, some \$200 billion alone [early 1980's] would have to be invested in sewerage to achieve the target of basic sanitation for all. Resources on this scale are simply not in sight." (Barbara Ward, President of the International Institute for Environment and Development).

To quote Lattee Fahm, "In today's

TRICKLING ...



**NOISY?
TOILET**

GET THE
GENUINE

**WATER
MASTER**

**America's Largest Selling
TOILET TANK BALL**

Noisy running toilets can waste over 1000 gallons of water a day. Stop this annoying noise, waste and expense. The amazing patented Water-Master Tank Ball instantly stops the flow of water after each flushing, stops the flow everytime, not just some of the time.

75c at hardware stores EVERYWHERE
Higher in Canada

world [1980], some 4.5 billion people produce excretal matters at about 5.5 million metric tons every twenty-four hours, close to two billion metric tons per year. [Humanity] now occupies a time/growth dimension in which the world population doubles in thirty five years or less. In this new universe, there is only one viable and ecologically consistent solution to the body waste problems - the processing and application of [humanure] for its agronutrient content.”⁴⁴ In other words, we have to understand that humanure is a natural substance, produced by a process vital to life (human digestion), originating from the earth in the form of food, and valuable as an organic refuse material that can be returned to the earth in order to produce more food for humans. That’s where composting comes in.

But hey, wait, let’s not be rash. We forgot about incinerating our excrements. We can dry our turds out, then truck them to big incinerators and burn the hell out of them. That way, instead of having fecal pollution in our drinking water or forests, we can breathe it in our air. Unfortunately, burning sludge with other municipal waste produces *emissions* of: particulate matter, sulfur dioxide, nitrogen oxides, carbon monoxide, lead, volatile hydrocarbons, acid gasses, trace organic compounds and trace metals. The left-over *ash* has a high concentration of heavy metals, such as cadmium and lead.⁴⁵ Doesn’t sound so good if you live downwind, does it?

How about microwaving it? Don’t laugh, someone’s already invented the microwave toilet.⁴⁶ This just might be a good cure for hemorrhoids, too. But heck, let’s get serious and shoot it into outer space. Why not? It probably wouldn’t cost too much per fecal log after we’ve dried the stuff out. This could add a new meaning to the phrase “the Captain’s log”. Beam up another one, Scotty!

Better yet, we can dry our turds out, chlorinate them, get someone in Taiwan to make little plastic sunglasses for them, and we’ll sell them as pet turds! Now that’s a realistic entrepreneurial solution, isn’t it? Any volunteer investors out there?



REFERENCES - CHAPTER FOUR

- 1 - Mancini, K. *Septic Tank - Soil Absorption Systems*. Agricultural Engineering Fact Sheet SW-44. Penn State College of Agriculture Cooperative Extension, University Park, PA 16802.
- 2 - Mancini, K. *Mound Systems for Wastewater Treatment*. SW-43. Same as above.
- 3 - Stewart, J.G. (1990). Drinking Water Hazards: How to Know if There Are Toxic Chemicals in Your Water and What to Do If There Are. Envirographics: Hiram, Ohio. (pp.177-178).
- 4 - van der Leeden, F. et al. (1990). The Water Encyclopedia. Lewis Publishers Inc.: Chelsea, Michigan, 48118. (p.526).
- 5 - Ibid. (p.525).
- 6 - Stewart, John G. (as in #3 above, same pages).
- 7 - Ibid.
- 8 - *Environmental Reporter*. 2/28/92. The Bureau of National Affairs, Inc., Washington D.C., (pp. 2441-2).
- 9 - Gray, N.F. (1990). Activated Sludge Theory and Practice. Oxford University Press: New York. (p.125).
- 10 - van der Leeden, F. et al. (1990). The Water Encyclopedia Second Edition. Lewis Publishers, 121 South Main Street, Chelsea, Michigan 48118 (p. 541).
- 11 - *Journal of Environmental Health*. July/August 1989. "EPA Proposes New Rules for Sewage Sludge Disposal". (P.321).
- 12 - Logan, W.B. (1991). "Rot is Hot". *New York Times Magazine*. 9/8/91 Vol. 140, Issue 4871, p.46.
- 13 - *Garbage*. February/March 1993. Old House Journal Corp., 2 Main St., Gloucester, MA 01930. (p.18).
- 14 - Manahan, S.E. (1990). Hazardous Waste Chemistry, Toxicology and Treatment. Lewis Publishers, Inc.: Chelsea, Michigan. (p.131).
- 15 - Ibid. (pp. 148-49).
- 16 - Baumann, Marty. *USA Today*. Feb 2, 1994, p. 1A, 4A. USA Today (Gannet Co. Inc.) 1000 Wilson Blvd., Arlington, VA 22229.
- 17 - "The Perils of Chlorine". *Audubon Magazine*, 93:30-2. Nov/Dec 1991.
- 18 - Liptak, B.G. (1991). Municipal Waste Disposal in the 1990's. Chilton Book Co.: Radnor, PA. (pp.196-8).
- 19 - Stiak, J. "The Trouble With Chlorine". *Buzzworm*. Nov/Dec 1992. (p.22).
- 20 - *Environmental Reporter*. 7/10/92. (p.767).
- 21 - *Buzzworm*. March/April 1993. (p.17).
- 22 - *Environmental Reporter*. 7/10/92. (p.767).
- 23 - Ibid. 4/24/92. (p.2879).
- 24 - Ibid. 8/7/92. (p.1155).
- 25 - Burke, W.K. "A Prophet of Eden". *Buzzworm*. Vol. IV, Number 2, March/April 1992. (pp.18-19).
- 26 - *Environmental Reporter*. 8/7/92. (P.1152).
- 27 - Ibid. 5/15/92. (p.319).

- 28 - Ibid. 3/6/92 (p. 2474) and 1/17/92 (p.2145).
- 29 - Ibid. 1/3/92 (p.2109).
- 30 - Ibid. 11/1/91 (p.1657).
- 31 - Hammond, A. et al. (Eds.) (1993). The 1993 Information Please Environmental Almanac. Compiled by the World Resources Institute. Houghton Mifflin Co.: New York. (p.41).
- 32 - Purves, D. (1990). "Toxic Sludge". *Nature*. Vol. 346, 8/16/1990 (pp. 617-18).
- 33 - Rybczynski, W. et. al. (1982). Appropriate Technology for Water Supply and Sanitation - Low Cost Technology Options for Sanitation, A State of the Art Review and Annotated Bibliography. World Bank. (p. 124).
- 34 - Ibid. (p. 125).
- 35 - Fahm, L.A. (1980). The Waste of Nations. Allanheld, Osmun & Co.: Montclair, NJ (p.61).
- 36 - Radtke, T.M., and Gist, G.L. (1989). "Wastewater Sludge Disposal: Antibiotic Resistant Bacteria May Pose Health Hazard". *Journal of Environmental Health*. Vol 52, No.2, Sept/Oct 1989. (pp.102-5).
- 37 - *Environmental Reporter*. 7/10/92. (p.770).
- 38 - Daniel, J.E., et al. (Eds.). (1992) 1992 Earth Journal. Buzzworm Books: Boulder, CO. (p.131).
- 39 - Rivard, C.J. et al. (1989). "Waste to Energy". *Journal of Environmental Health*. Vol.52, No.2, Sept/Oct 1989. (p.99).
- 40 - *Environmental Reporter*. 11/1/91. (p.1653).
- 41 - Ibid. 1/17/92. (p.2154).
- 42 - Damsker, M. (1992). "Sludge Beats Lead". *Organic Gardening*. Feb, 1992, Vol. 39, Issue 2, p.19.
- 43 - Fahm. (1980). The Waste of Nations. (p.xxiv).
- 44 - Ibid. (p.40).
- 45 - Rivard, C.J. et al. (1989). "Waste to Energy". *Journal of Environmental Health*. Vol 52, No.2, Sept/Oct 1989. (p.100).
- 46 - See *Garbage*, Oct/Nov 1992, (p.14).

*** "All sewer sludge is not bad," according to Ancil Schmidt, West Virginia Division of Environmental Protection Extension Agent. Mr. Schmidt offers a very helpful packet of information about the use of sewage sludge for agricultural purposes ("Use and Disposal of Municipal Wastewater Sludge"), which is available from: West Virginia University Extension Service, 200 1/2 South Kanawha Street, Beckley, West Virginia, 25801-5616; Phone (304) 255-9321.**

**** Contact JCH Environmental Engineering, Inc., 2730 Remington Court, Missoula, MT 59801-7121. Phone (406) 721-1164.**

**YOU MAY HAVE NOTICED THAT THIS BOOK
HASN'T (YET) MADE IT TO THE NEW YORK
TIMES BESTSELLER LIST.**

**HERE'S YOUR MANUSCRIPT
BACK SIR. SORRY, WE DON'T
PUBLISH CRAP LIKE THIS.
PERHAPS YOU COULD USE IT
FOR EMERGENCY
TOILET PAPER.**

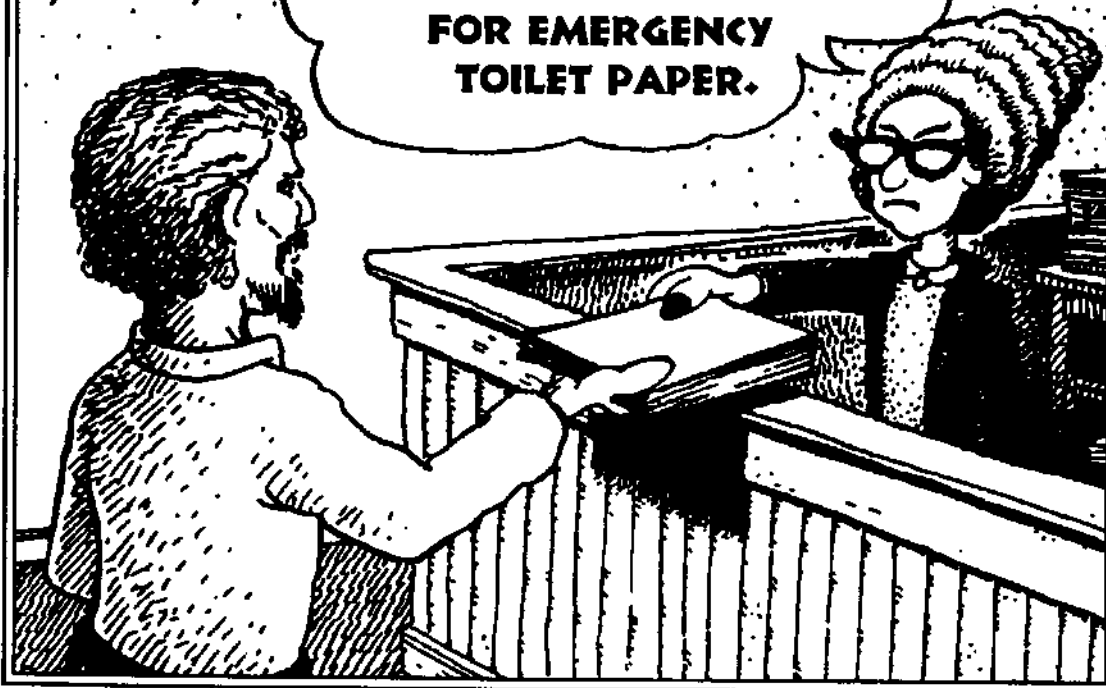

COMPOSTING TOILETS AND SYSTEMS

"Simplicity of life, even the barest, is not misery but the very foundation of refinement."

William Morris



The act of composting humanure can be done *actively*, with full and voluntary participation by the person(s) creating the refuse, or it can be done *passively*, with little or no participation in the composting process by the person(s) creating the refuse. Many people in the West who agree with the idea of composting humanure want to do so, but only if the process is passive. They don't want to be actively involved in the compost-making process. They want the toilet to do the work, although they may be willing to haul the finished compost off somewhere to be disposed of, usually desiring to do so as infrequently as possible. For many people, a composting toilet is another disposal system, one that doesn't require water (usually), and one that is not to be used in the human nutrient cycle.

Others, those who make compost through an aerobic, thermophilic process, know that there's a technique to building a compost pile that must be respected in order to achieve the desired result, i.e. good quality garden compost. These people use their finished compost to produce food for themselves to eat, therefore they want to be actively involved in the composting process in order to assure quality control over the finished product.

People who actively compost their organic refuse, including humanure, are as rare as hen's teeth in the West. The practice is so alien to Western culture that a person who thermophilically composts humanure may as well walk around with a bone through his or her nose. This is ironic because well-managed thermophilic composting ensures the destruction of human pathogens in the composted material and transforms organic refuse into humus in a relatively short period of time compared to passive composting, which is not thermophilic (the compost does not heat up). However, as pointed out in chapter three, Westerners gained a deep distrust of human excrement over the past several hundred years. This was largely due to terrible epidemic diseases during the Middle Ages and up to the late 1800's spread by fecal contamination of the environment, a condition caused by a cultural ignorance of both the

origins of disease and of the the benefits of composting in destroying human pathogens. That deeply entrenched bias against the use of humanure agriculturally, still currently prevalent in the West, will not be easily rooted out, although eventually it must be. I call the belief that humanure is unsafe for agricultural use: *fecophobia*.

People who are fecophobic can suffer from severe fecophobia or a relatively mild fecophobia, the mildest form being little more than a healthy concern about personal hygiene. Severe fecophobics do not want to use humanure for food growing, composted or not. They believe that it's dangerous and unwise to use such a material in their garden. Milder fecophobics may, however, compost humanure passively and use the finished compost in horticultural applications. People who are not fecophobic may thermophilically compost humanure and utilize it in their food garden. Some may even use it raw, a practice not recommended by the author.

In any case, humanure is best rendered hygienically safe by proper thermophilic composting. Passive, low-temperature composting is very unlikely to become thermophilic and usually does not focus on the destruction of possible human pathogens in the organic refuse being composted. Yet, even passive composting will eventually yield a relatively pathogen-free compost after a period of time, a period which, according to some sources, may be as long as five and a half¹ or even ten² years. This is in contrast to thermophilic composting which will destroy human pathogens in a matter of hours or days, or, for larger quantities, weeks or months.

Commercial composting toilets are, for the most part, passive. They are *mouldering* toilets, meaning that the compost moulders or decomposes slowly at temperatures lower than that of the human body. The consumer who buys a commercially distributed composting toilet can rest assured that s/he will have to do little more than use the toilet and then once a year (or two or three) empty out some compost. Often, a dry, organic cover material such as peat moss is recommended to be added to the contents of the toilet on a regular basis. Other than that, there's not much to it.

On the other hand, *non-commercial* mouldering toilets, or *toilets constructed by the users*, are in widespread use throughout the world since many people do not have the financial resources required to purchase commercially produced toilets. Non-commercial mouldering toilets usually require the separation of urine from feces when collecting the organic refuse. This is done by urinating in a separate container or into a diversion device which causes the urine to collect separately from the feces. The rationale for separating urine from feces is that the urine/feces blend contains too much nitrogen to allow for effective composting and the collected refuse gets too wet and odorous. Therefore, the urine is collected separately, thereby reducing the nitrogen, the liquid content, and the odor of the collected refuse.

However, there is a little known alternative method of achieving the same

result which does not require the separation of urine from feces. Organic material with too much nitrogen for effective composting (such as a urine/feces mixture) *can be balanced by adding sufficient carbon material such as cellulose in the form of sawdust or a similar material, rather than removing nitrogen.* The extra carbon material also absorbs excess liquids and can cover the collected refuse to eliminate odor completely. This alternative of adding a carbon material to humanure instead of segregating urine from it, also sets the stage for thermophilic composting because of the carbon/nitrogen balancing. However, almost all commercial and non-commercial composting toilets are designed to only achieve mouldering conditions in the compost and not to generate thermophilic conditions.

A *commercial* composting toilet such as a Clivus Multrum (see figure 5.4 on page 93 and the photos on pages 94 and 95) is a manufactured device including a toilet seat and a composting chamber whereby individuals can deposit their feces with little or no active involvement in a nutrient cycling process. In other words, you can take a shit and forget about it, and urine does not need to be segregated. Commercial composting toilets are convenient for that reason. The compost may or may not be suitable for a kitchen garden, as the composting process is usually slow and usually maintains a relatively low temperature which can allow some pathogens to survive. These toilets are popular among those who understand that defecating in water doesn't make sense, or among those who have no electricity or water in their summer cottages and can't use a water-based waste disposal system even if they wanted to. Commercial composting toilets often strive to dehydrate the organic refuse deposited in them so as to reduce bulk and minimize the quantity of compost being produced. This is done by blowing air through and over the organic refuse with fans, and/or by heating the refuse electrically, or by draining excess liquids out into the soil.

On the other hand, an *active, thermophilic composting system* (not a mouldering system) may only use a toilet for *collection* purposes. The humanure may be collected regularly, perhaps daily or weekly, in a simple, low-cost receptacle and deposited on a compost pile or in a compost pit away from the toilet area and layered with other organic materials so that a high aerobic decomposition temperature is generated in order to kill all potential pathogens. (By the way, *a pathogen is any microorganism or worm that can cause a disease.* See glossary or see next chapter.) In some cases, the humanure is deposited directly onto a compost pile in a basement or under an elevated toilet, and layered with other household organic refuse and organic cover materials. Those who use such an active composting system understand that the composting process is only one step in a larger cyclical system of nutrient transfer: soil produces food, we eat the food, we discharge organic refuse (feces, urine, food scraps, agricultural refuse), the humanure is composted with other veg-

etable or animal refuse, the compost turns back into soil, the soil produces more food, we eat the food, we discharge refuse, and so on. This never-ending human nutrient cycle, when humanure is composted and used to grow human food, maintains a harmonious balance between the human and the earth. It's an active process and requires diligent and conscientious involvement by the human participant(s). What's of value here is the entire, unbroken system, the process itself. The physical toilet may only be a small but important part of the entire cycle. When the actual composting takes place away from the toilet area, this approach requires little construction cost. An active composting system is more labor intensive, but requires little use of technology or natural resources, including water.

Thermophilic composting of humanure has not gained popularity among Westerners for three basic reasons: 1) You can't take a shit and forget about it. The organic refuse has to be dealt with on a regular basis, even if only covered after each deposit and the finished compost removed regularly. S/he who defecates and/or urinates must acknowledge and take responsibility for what comes out of his/her body. 2) Fecophobia. There seems to be a general fear that if you don't die outright from actively composting humanure, you'll die a slow, miserable and wretched death, or you'll surely cause an epidemic of something like the plague and everyone within two hundred miles of you will die, or you'll become so infested with worms that you'll no longer be recognized as human. 3) Misinformation. Much of the information in print concerning the recycling of humanure is confusing, erroneous or incomplete.

As chapter 6 deals with pathogens and chapter 7 deals with the subject of practical thermophilic composting, I won't go into either subject here in any great detail. Let's take a look at some commercial and/or passive composting toilets instead.

THE NON-COMMERCIAL (HOME-MADE) MOULDERING TOILET

The objectives of a mouldering toilet are to achieve safe and sanitary treatment of fecal material, to conserve water, to function with a minimum of maintenance and energy consumption, to operate without unpleasant odors, and to recycle humanure for horticultural use in a form usable to nature (see figures 5.1, 5.2, and 5.3).

The decomposition process is akin to what happens on a forest floor, i.e. cool, slow decomposition. Because the temperature of the compost does not elevate high

enough to destroy all pathogens, the resulting compost, also known as duff, is considered suitable only for horticultural purposes, not for agricultural purposes, except, perhaps, for orchard use where the duff is covered or buried after application.

It is well known that humanure contains the potential to harbor disease-causing microorganisms, or pathogens. Compost temperatures must rise significantly *above the temperature of the human body* (98.6°F or 37°C) in order to begin eliminating disease-causing organisms, as human pathogens can live happily in temperatures similar to that of the human being. The human body attempts to destroy pathogenic infections by elevating its own temperature, thereby creating a fever, which pathogens don't like. Human fevers rarely rise above 104°F (40° C), and when they do, they rarely sustain that level of heat for more than a day or two. Compost must also generate heat in order to destroy human pathogens, and fortunately thermophilic composting will readily create temperatures much higher than the human body temperature and sustain them, perhaps for weeks.

However, mouldering toilets generally do not achieve thermophilic conditions and therefore do not achieve temperatures higher than that of the human body. Consequently, some human pathogens may smugly reside in the finished compost, perhaps for years. According to current scientific evidence, which is discussed at greater length in chapter six, a few months retention time in just about any compost toilet will result in the deaths of nearly all human pathogens. The most persistent pathogen seems to be the roundworm (*Ascaris lumbricoides*) however, and particularly the egg of the roundworm, which is pro-

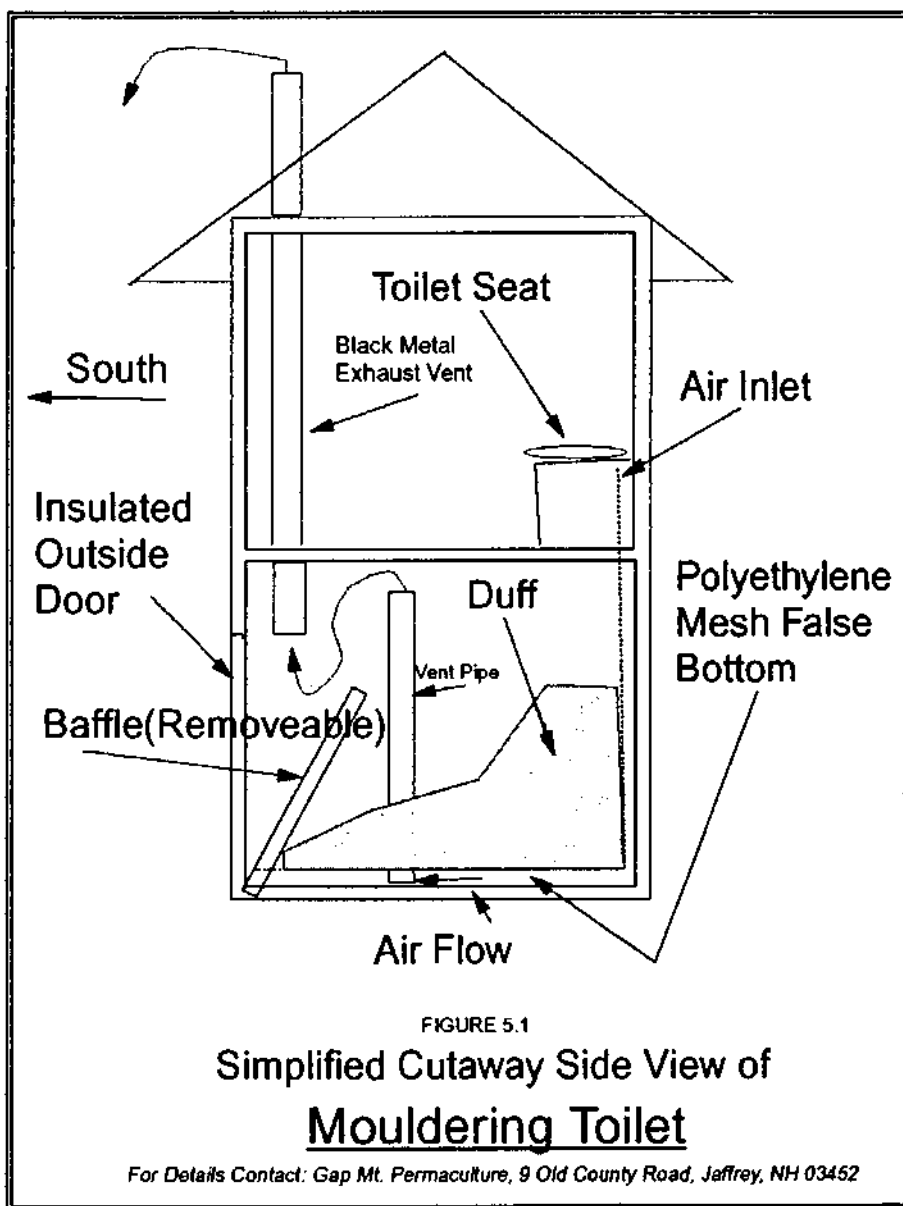

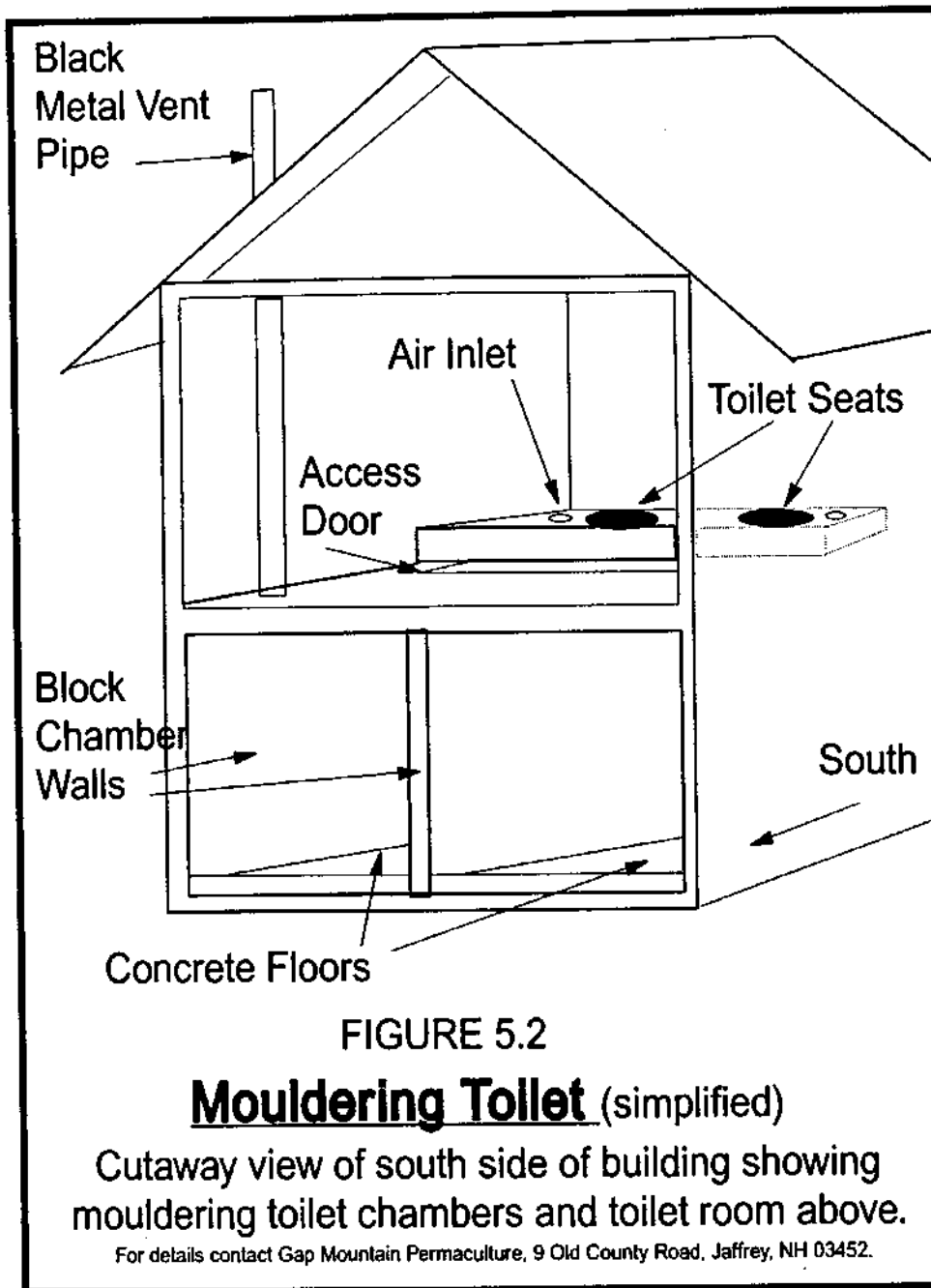

tected by an outer covering which renders the egg resistant to chemicals and adverse environmental conditions. Estimates of the viability of *Ascaris* eggs in soil range as high as ten years. Although the *Ascaris* and the eggs are readily destroyed by thermophilic composting, the eggs may survive in conditions generated by a mouldering toilet. This is why the compost resulting from a mouldering toilet is not recommended for human food production, and why mouldering toilets are only used as elements of the human nutrient cycle in groups of people who are willing to accept the possibility of a level of *Ascaris* infection in their population.

The primary advantage to this sort of toilet is the passive involvement of the user, as the toilet collection area need not be entered into more than every two or three years, unless to rake the pile flat. The pile that collects in the chamber must be raked and mixed somewhat every few months (which can be done through a floor access door), and the chamber is emptied only after nothing has been deposited in it for at least two years, although this time period may vary depending on the individual systems used.

In order for this system to work well, each toilet must consist of two chambers. The first is deposited into until it's full, then the second is used. By the time the

FIGURE 5.3

Guatemalan Mouldering Toilet

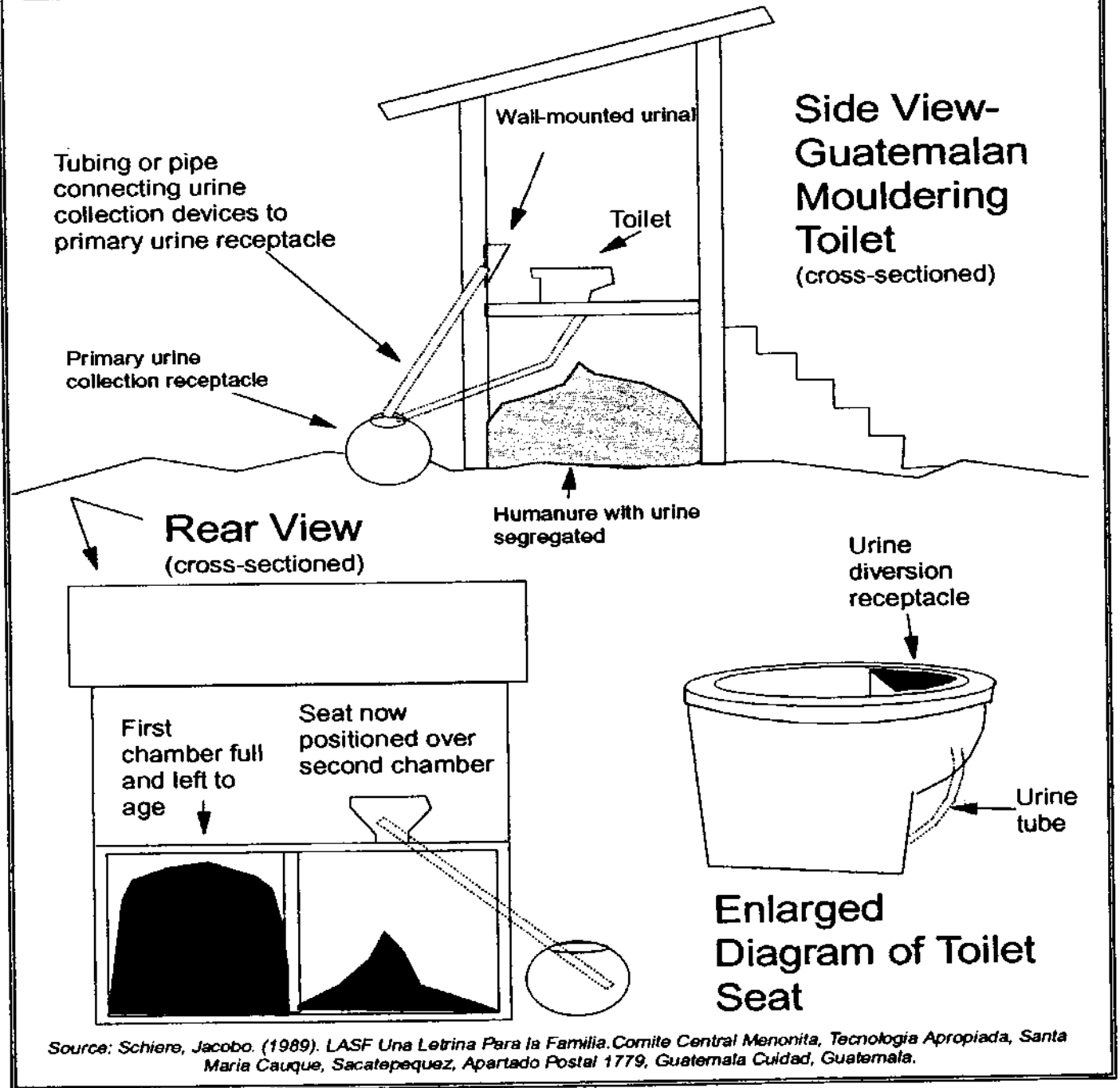

second side is full the first should be emptied. It may take five years to fill a side. In addition to feces, carbonaceous organic matter such as sawdust is regularly added to the chamber in use. One drawback to this system may be the desire to segregate urine from feces in order to minimize odors and waterlogging of the duff. Urination then takes place in a separate container and the collected urine is deposited on a garden or compost pile. Some toilets, such as one currently being used in Guatemala (see figure

5.3 on page 91), automatically separate urine from feces during defecation. However, an alternative to segregating urine to prevent waterlogging of the duff would be to simply add more dry cover material to soak up the excess moisture. Urine-soaked sawdust composts quite well.

An advantage to this system is that there are no moving parts or electrical devices. Air ventilation may take place through a large, black vertical pipe which passes indoors through the toilet room in front of a south-facing window (in the northern hemisphere) where it will be heated, passively causing the air to rise.

In short, the mouldering toilet seems to offer a method of composting humanure that would be attractive to persons wanting a low-maintenance, low-cost, passive approach to excrement recycling. However, urination in a separate receptacle seems to somewhat offset the passive nature of this type of toilet, as the urine must be dealt with on a regular basis. The other primary drawback, as I see it, aside from occasional fly infestations, is the low-temperature composting of the humanure rendering it unfit for growing human food, except for orchard application, until after a quite lengthy period of time. The total destruction of human pathogens should be the goal of anyone composting humanure. However, any effort which successfully returns organic refuse to the soil without polluting water or the environment and without using electricity certainly demands a high level of commendation.³

COMMERCIAL MOULDERING (OR MULTRUM) TOILETS

Commercial mouldering toilets have been popular in Scandinavia for some time, and at least twenty-one different mouldering toilets were on the market in Norway alone in 1975.⁴ One of the most popular types of commercially available composting toilets in the United States today is the multrum toilet, invented by a Swedish engineer and first put into production in 1964. These toilets have found their way into public buildings, banks, even universities. The concept is similar to that of a simple double-chambered mouldering toilet, although fecal material and urine are deposited *together* into a single chamber with a double bottom. The decomposition takes place slowly over a period of years, and the finished compost gradually falls down to the very bottom of the toilet chamber where it can be removed. Again, the decomposition temperatures remain cool, not usually climbing above 90° F, which is not high enough to kill all pathogens. Therefore, it is recommended that the finished compost be buried under one foot of soil or used in an ornamental garden.⁵

The advantages of this type of toilet include the passive nature of user partici-

pation. Anybody will happily use a multrum toilet because they know full well that *someone else* someday will have to empty it out. Also, no water is used or required during the operation of this toilet, thereby keeping human excrement out of the water supplies as well as conserving water. According to one report, a single person using a Clivus Multrum will produce 40 kg (88 lbs) of compost per year while refraining from polluting 25,000 liters (6,604 gallons) of water annually.⁹ Finally, the finished compost can be used as a soil additive where the compost will not come in contact with food crops.

Drawbacks include the cost, which can easily exceed two or three thousand dollars (1990's), and the fact that the composting chamber is usually made of plastic, which means that for every plastic multrum toilet purchased, a non-biodegradable plastic multrum toilet will probably end up someday in a landfill. If these toilets were made from recycled plastic, that would certainly be a bonus, but that currently doesn't seem to be the case. Also, the multrums require electricity to run both a fan-driven ventilation system and a pump for pumping excess liquid (urine) from the composting chamber. Finally, the composting process does not kill all pathogens in the manure by means of thermophilic composting, although the lengthy retention time of the compost undoubtedly contributes to the destruction of most pathogens that may exist in the excrement (see table 6.11 on page 127).

I'm aware of a couple of multrum toilets currently being used by friends of mine, and they both have had problems with odors, while one has had problems with flies and excess liquid buildup in the composting chamber.

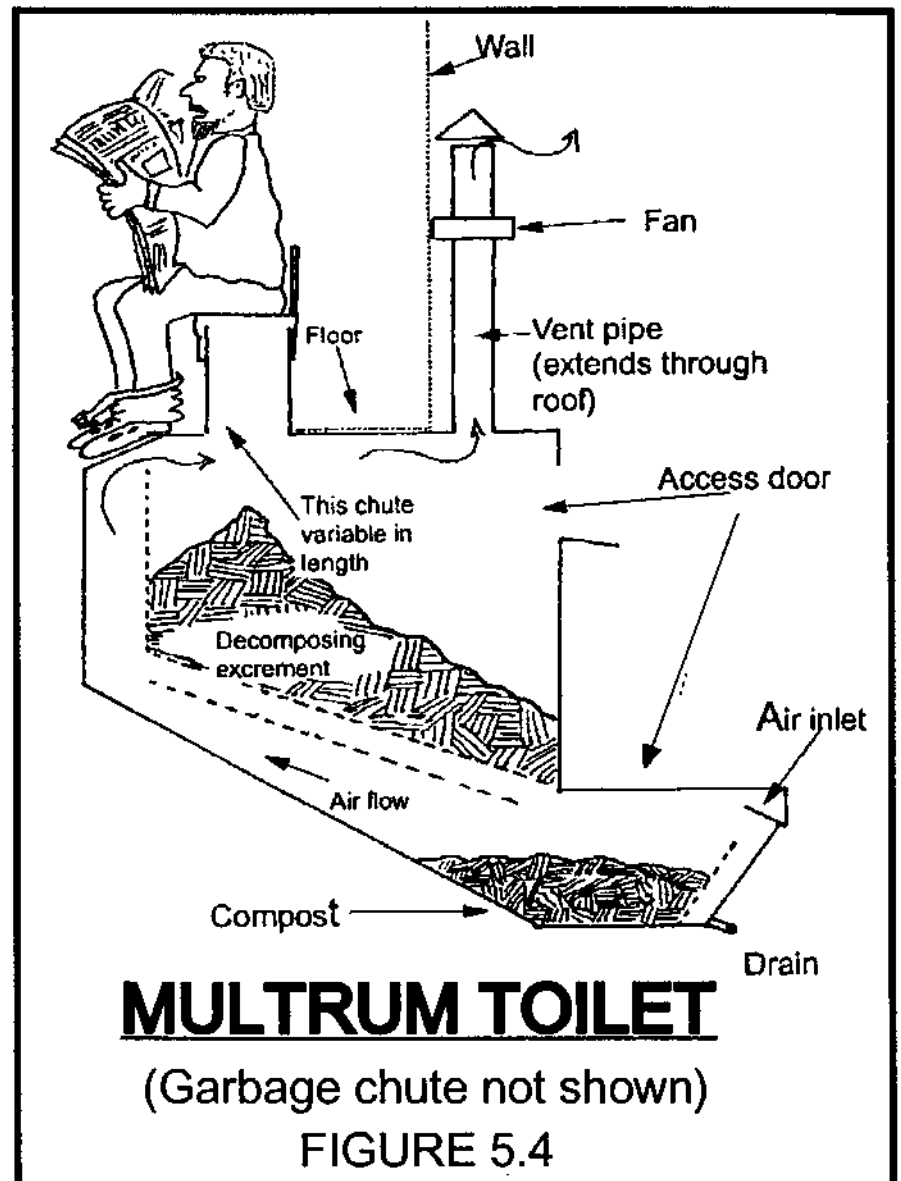

Now, it seems to me that these problems *are due to improper use of the toilet, not necessarily to the toilet itself*, as eventually both parties managed to get their toilets working well, without odors or flies. However, this indicates that some management of the composting toilet is required by someone using the toilet in order to avoid these kinds of problems. For example, organic bulking materials such as sawdust or fine wood shavings must be added regularly to the toilet to absorb excess liquids, aid the composting process, and minimize or eliminate odors. If a multrum toilet is managed properly, it should easily be odor and worry free. As always, a good understanding of the basic concepts of composting will help anyone who wishes to use a composting toilet. Nevertheless, the multrum toilets, when used properly, should provide a suitable alternative to flush toilets for people who want to stop defecating in their drinking water. You can probably grow a heck of a rose bed with the compost, too.

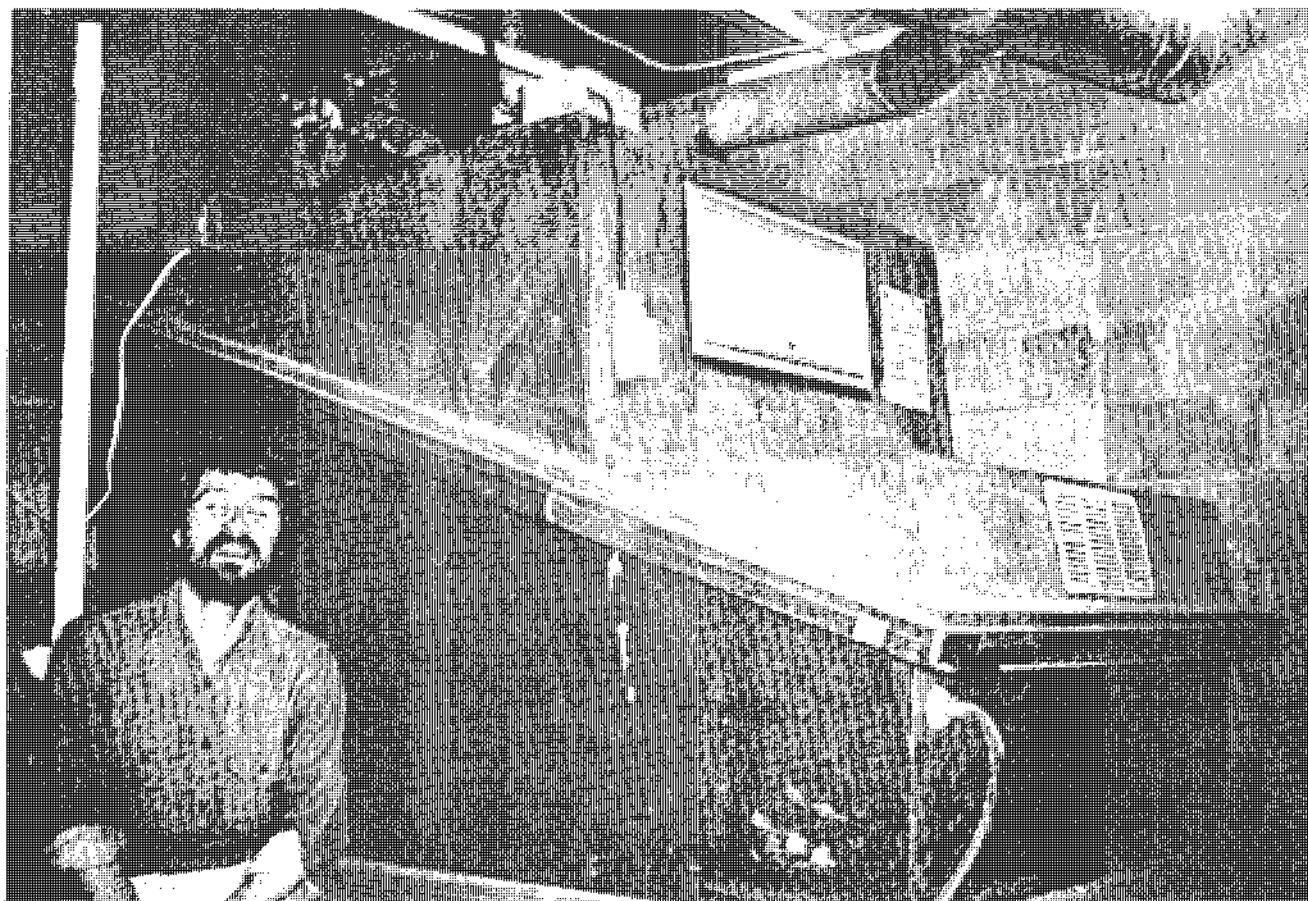

A CLIVUS MULTRUM IN THE BASEMENT OF SLIPPERY ROCK UNIVERSITY'S HARMONY HOUSE. THE TOILET AND THE KITCHEN COMPOST DISPOSAL CHUTE ARE ON THE FIRST FLOOR.

Finished compost from seven Clivus Multrum toilets which had been in use for 4 to 14 years was analyzed for nutrients, according to a report issued by Clivus Multrum USA in 1977. The compost averaged 58% organic matter, with 2.4% of nitrogen, 3.6% of phosphorous, and 3.9% of potassium,

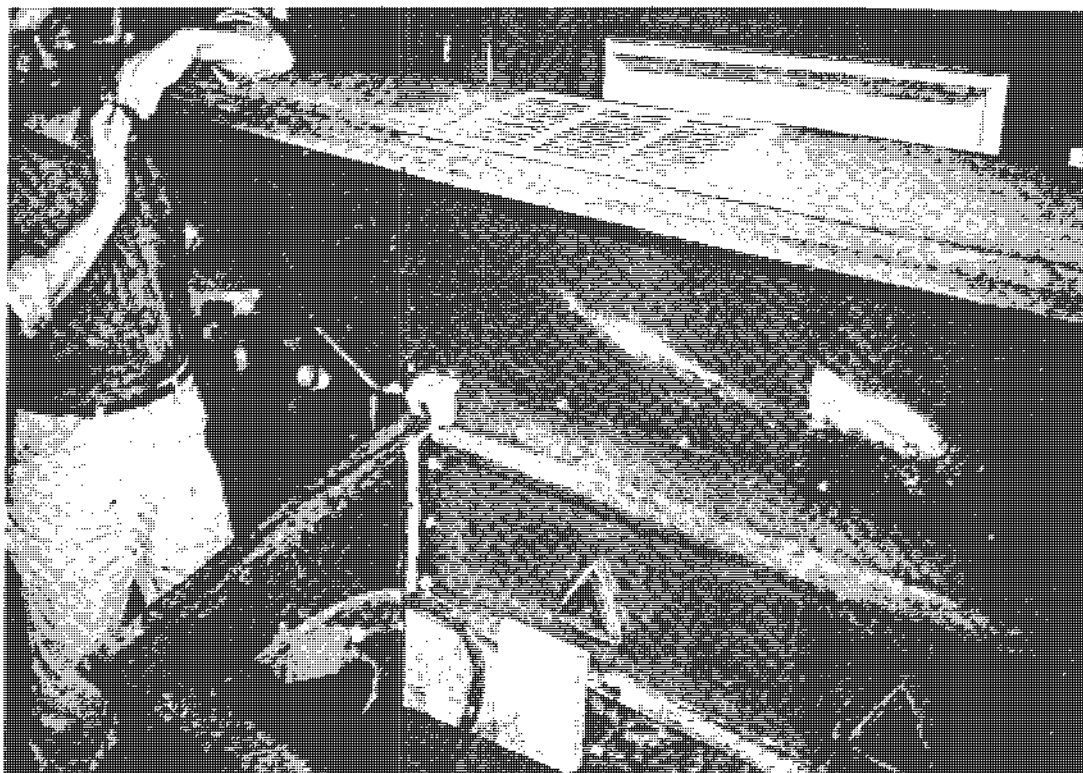

THE CONTENTS OF A CLIVUS MULTRUM ARE BEING EXAMINED THROUGH ITS MAIN ACCESS DOOR.

which is reportedly higher than composted sewage sludge, municipal compost, or ordinary garden compost. Suitable concentrations of trace nutrients were also found. Toxic metals were found to exist in concentrations far below recommended safe levels.⁹

MORE COMMERCIAL COMPOSTING TOILETS

There are a variety of other composting toilets available on the market today (see reference list and additional sources of composting toilets on pages 107-108). One manufacturer (*Sun Mar*) claims that over 200,000 composting toilets have been sold worldwide. The same manufacturer produces a fiberglass and stainless steel toilet which consists of a drum under the toilet seat or under the bathroom floor into which the feces and urine are deposited. The drum is rotated by hand in order to blend the ingredients, which should include garbage and a carbon material such as peat moss. The toilet can come equipped with an electric heating system and an electrical fan ventilation system. The compost is produced in small quantities which are

removed by pulling out a drawer beneath the drum. The compost is said to be suitable for garden purposes.

Drawbacks? Some of the models require water as well as electricity (although some require no electricity or water). Again, the cost may be prohibitive to some, although these smaller, more self-contained toilets seem to cost less than the multrums. 1993 price quotes ranged from \$1100.00 to \$1400.00. Also, for every fiberglass toilet unit purchased, someday a fiberglass toilet unit will undoubtedly end up thrown "out" somewhere when it wears out.

However, as the manufacturer insists that the toilet produces absolutely no odor and generates compost suitable for a food garden, it must be assumed that the heating element in the electric toilets in combination with the active compost blending create optimum composting conditions which kill all pathogens. The literature on these toilets doesn't discuss the pathogen issue in any detail though, and as some of the toilets aren't electrically heated, the destruction of pathogens in the finished compost remains a matter of speculation.⁶

Another composting toilet that is currently on the market (*AlasCan*) is even further up the ladder of technological sophistication. Made in Alaska and costing upwards of \$10,000 or more, the toilet is complete with an insulated tank, conveyers, motor-driven agitators, a pump and sprayer, and exhaust fan.⁷

Finally, another source of a composting toilet⁸ (*Composting Toilet Systems*) manufactures a fiberglass unit similar to a multrum toilet, and advertises it as a "waste disposal system". The 1993 price for this unit, which uses no water, but does require electricity, is \$3656.00. According to the manufacturer, waterless composting toilets reduce household water consumption by 40,000 gallons per year. This is significant when one considers that only 3% of the Earth's water is fresh, even more so when one realizes that two thirds of that fresh water is locked up in ice. That means that less than one percent of the Earth's water is available as fresh water. Why shit in it?

ASIAN COMPOSTING

As stated in chapter three, it is well known that Asians have *recycled* humanure for centuries, possibly millennia. However, historical information concerning the *composting* of humanure in Asia seems difficult to find. Rybczynski et. al.⁹ in fact state that such composting was only introduced to China in a systematic way in the 1930's, and that it wasn't until 1956 that compost toilets were used on a wide scale in Vietnam. On the other hand, Franceys et. al. tell us that composting, "*has been practiced by farmers and gardeners throughout the world for many centuries.*" They add

that, “*In China, the practice of composting human wastes [sic] with crop residues has enabled the soil to support high population densities without loss of fertility for more than 4000 years.*”¹⁰

However, a book published in 1978 and translated directly from the original Chinese (Compost, Fertilizer and Biogas Production from Human and Farm Wastes in the People’s Republic of China, by M. G. McGarry and J. Stainforth, International Development and Research Center, Ottawa)¹³ indicates that composting has *not* been a cultural practice in China until only recently. An agricultural report from the Province of Hopei, for example, states that the standardized management and hygienic disposal (i.e. composting) of excreta and urine was only initiated there in 1964. The composting techniques being adopted and developed at that time included the segregation of feces and urine, which were later “*poured into a mixing tank and mixed well to form a dense fecal liquid*” before piling on a compost heap. The compost was made of 25% human feces and urine, 25% livestock manure, 25% miscellaneous organic refuse, and 25% soil.

Two *aerobic* methods of composting were reported to be in widespread use in China, according

to the 1976 report. The two methods are described as a) surface aerobic continuous composting, and b) pit aerobic continuous composting. The *surface* method involves constructing a compost pile around an internal framework of bamboo, approximately nine feet by nine feet by three feet high (3m x 3m x 1m).



A YOUNG LADY SETTING CEDAR POSTS IN THE GROUND FOR THE CONSTRUCTION OF A DOUBLE-CHAMBERED COMPOST BIN.

Compost ingredients include fecal material (both human and non-human), organic refuse, and soil. The bamboo is removed from the constructed pile and the resultant holes allow for the penetration of air into this rather large pile of refuse. The pile is then covered with earth or an earth/horse manure mix, and left to decompose for 20 - 30 days, after which the composted material is used in agriculture. The *pit* method involves constructing compost pits five feet wide and four feet deep by various lengths, then digging channels in the floor of the pits. The channels (one lengthwise and two widthwise) are covered with coarse organic material such as millet stalks, and a bamboo pole is placed vertically along the walls of the pit at the end of each channel. The pit is then filled with organic refuse and covered with earth, and the bamboo poles are removed to allow for air circulation.¹¹

Additional light is shed on the subject of Chinese composting by a report from a hygienic committee of the Province of Shantung, as published in the aforementioned work by McGarry and Stainforth. The report lists three traditional methods used in that Province for the recycling of humanure: 1) drying it (*"drying has been the most common method of treating human excrement and urine for years"*), 2) using it raw for agricultural purposes, and 3) *"connecting the household pit privy to the pigpen . . . a method that has been used for centuries"*, a method in which the excrement was simply eaten by a pig. No mention is made whatsoever of composting being a traditional method used by the Chinese for recycling humanure. On the contrary, all indications were that the Chinese government in the 1960's was *at that time* attempting to establish composting as preferable to the three traditional recycling methods listed above, mainly because the three methods were hygienically unsafe, while composting, when properly managed, would destroy pathogens in humanure while preserving agriculturally valuable nitrogen. Once again, the report describes composting techniques in which soil was being used as a main ingredient in the compost, or, to quote directly, *"Generally, it is adequate to combine 40-50% of excreta and urine with 50-60% of polluted soil and weeds"*.

For further information on Asian composting I must defer to Rybczynski et. al., whose World Bank research on low-cost options for sanitation considered over 20,000 references and reviewed approximately 1200 documents. Their review of Asian composting is brief, but includes the following information, which I have condensed:

There are no reports of composting privys (toilets) being used on a wide scale until the 1950's, when the Democratic Republic of Vietnam initiated a five-year plan of rural hygiene and a large number of *anaerobic* composting toilets were built. These toilets, known as the Vietnamese double vault (see figure 5.5), consisted of two, above ground water-tight tanks, or *vaults*, for the collection of humanure. For a

family of five to ten people, each vault was required to be 1.2 m wide, 0.7 m high, and 1.7 m long (approximately 4 feet wide by 28 inches high and 5 feet seven inches long). One tank is used until full then left to decompose while the other tank is used. The use of this sort of composting toilet requires the segregation of urine, which is diverted to a separate receptacle by means of a groove on the floor of the toilet. The fecal material is collected in the tank and covered with soil, where it anaerobically decomposes. Kitchen ashes are added to the fecal material for the purpose of reducing odor. Intestinal worm eggs, which are one of the most persistently viable forms of human pathogens, were found to be 85% destroyed after a two month composting period in this system.

Another anaerobic double-vault composting toilet in use in Vietnam includes the use of fecal material *and* urine, but the bottom of the vaults are perforated to allow drainage, and the urine is filtered through limestone to neutralize acidity. Other organic refuse is also added to the vaults, and ventilation is provided via a pipe.

In India, the composting of organic refuse and humanure is advocated by the government. A study of such compost prepared in pits in the 1950's showed that

intestinal worm parasites were completely eliminated in 3 months and pathogenic bacteria were also completely destroyed. The destruction of pathogens in the compost was attributed to the maintenance of a temperature of about 104°F for a period of 10-15 days. However, it was also concluded that the compost pits had to be properly constructed and managed, and the compost not removed until fully "ripe", in order to achieve the total destruction of human pathogens. If done properly, it is reported that *"there is very little hygienic risk involved in the use and handling of [humanure] compost for agricultural purpos-*

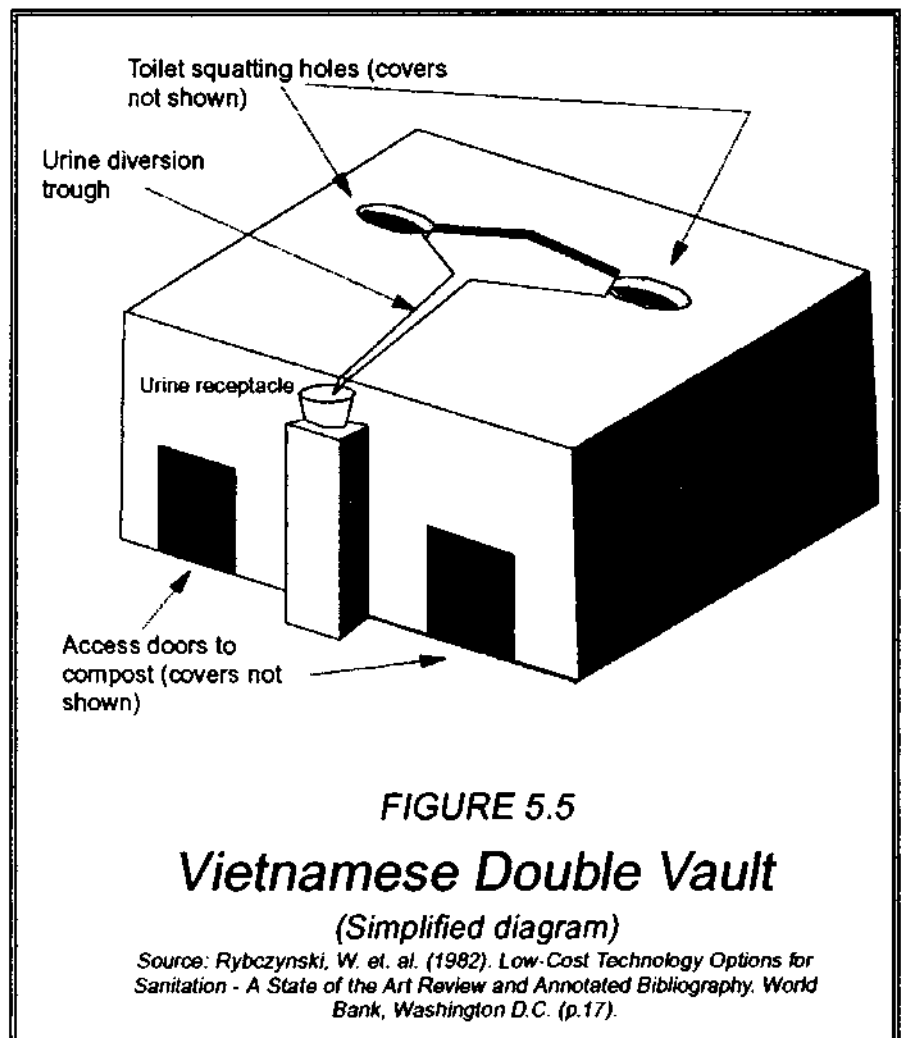

FIGURE 5.5

Vietnamese Double Vault

(Simplified diagram)

Source: Rybczynski, W. et. al. (1982). *Low-Cost Technology Options for Sanitation - A State of the Art Review and Annotated Bibliography*. World Bank, Washington D.C. (p.17).

es". The issue of pathogens will be discussed at length in the next chapter.

SIMPLE, LOW-TECH HUMANURE COMPOSTING



A SAWDUST TOILET. HUMANURE IS COLLECTED IN THE FIVE-GALLON CONTAINER UNDER THE SEAT AND KEPT COVERED WITH ROTTED SAWDUST. WHEN FULL, THE ORGANIC MATERIAL IS DEPOSITED INTO A COMPOST BIN FOR THERMOPHILIC COMPOSTING (SEE NEXT PAGE). SUCH A TOILET COSTS VERY LITTLE TO INSTALL OR OPERATE AND REQUIRES NO WATER OR ELECTRICITY.

Simple, low-tech compost systems are traditionally used by people who do not have the luxury of buying expensive, electrically powered, plastic or fiberglass receptacles to defecate in. Instead, they develop simple methods of collecting their manure and composting it, often away from their living spaces. Sometimes these systems are called cartage systems or bucket systems, as the manure is carried to the compost pit, chamber or bin, often in buckets or other waterproof vessels. People who utilize such simple techniques for composting humanure simply take it for granted that feces recycling is one of the regular and necessary chores of sustainable human life on this planet.

How it works is a model of simplicity. One begins by depositing one's organic refuse (feces and urine) into a plastic bucket, clay urn or other non-corrodible waterproof receptacle with about a five gallon (approximately 20 liters) capacity. Food scraps may be collected in a separate receptacle. The humanure is kept covered with a clean, organic material such as sawdust, peat moss,

soil, etc. in order to prevent odors, absorb urine, and eliminate any fly nuisance, and a lid is kept on the receptacle when not in use. A standard, hinged toilet seat is quite suitable as a lid. This system of using an organic cover material works well enough in preventing odors to allow the toilet to be indoors, year round. When the bucket is full, it is carried to the composting area and deposited on the pile. The deposit is then immediately covered with a layer of clean, bulky, organic material such as straw or weeds, in order to eliminate odors and trap air. The bucket is then thoroughly scrubbed with a small quantity of water, which can be rain water or wastewater, and biodegradable soap, if available or desired. A long-handled toilet brush works well for this purpose. The soiled water is then poured on the compost pile. Rain water or wastewater is ideal for this purpose as its collection requires no electricity. The bucket is then replaced in the toilet area. The inside of the bucket can then be dusted with clean, dry sawdust and it's ready to "go".

Drawbacks to this system include the inconvenience of carting buckets of excrement on a regular basis; having to look at and smell the excrement (mixed in sawdust), no



THE FULL SAWDUST TOILET RECEPTACLE IS SIMPLY LIFTED OUT OF THE TOILET AND EMPTIED INTO A COMPOST BIN OUTDOORS. ALL URINE AND FECES IS COLLECTED IN SUCH A TOILET. A FAMILY OF FOUR CAN EXPECT TO FILL A SAWDUST TOILET OF THIS SORT IN THREE OR FOUR DAYS. THE SAWDUST COVER ELIMINATES ODORS AND FLIES, AND BALANCES THE NITROGEN OF THE HUMANURE WITH CARBON, THEREBY FACILITATING THERMOPHILIC COMPOSTING. SUCH A TOILET SHOULD BE LOCATED INSIDE, BUT NEAR AN OUTSIDE DOOR FOR EASE OF REMOVAL.

matter how briefly, when depositing it on the compost pile; having to clean the bucket after emptying; and having to keep a supply of clean, organic material (e.g. sawdust, peat or clean soil, and straw/hay, weeds or leaves) available to use as cover materials, which is absolutely essential to the success of this sort of humanure composting system. Furthermore, when the bucket gets full, it can't be used until it's been emptied, no matter how bad one has to go. There is a degree of conscientious and serious responsibility involved in this system of composting in order for it to work well.

The advantages to this system include low financial cost in the creation of the facilities and low, or no energy consumption in its operation. Also, such a simple system, when the refuse is thermophilically composted, has a low environmental cost, as little or no technology is required for the system's operation, and the finished compost is as nice and benign a material as humanure can ever hope to be. No large, non-biodegradable composting chambers are required, and no composting facilities are necessary in or near one's living space, unless by choice (the manure collection can and should be inside one's home and can be quite comfortably designed). No electricity is needed, and no water is required except a small amount for cleaning purposes. The compost, if properly managed, will heat up sufficiently to kill all pathogens and thereby be useful for gardening purposes. A complete natural cycle is maintained, unbroken. Finally, the composting process is fast, i.e. the humanure is converted quickly (within a few days if not frozen) into an inoffensive substance that will neither attract rodents nor flies. In cold winter months, the compost simply freezes until spring thaw, then heats up.

The thought of carrying humanure to a compost site away from one's living space is one that will cause most Westerners to immediately reject the idea of composting their manure in this manner. The Western culture is built upon the idea of convenience, which is one reason why commercial composting toilets are relatively popular in the West, and the inconvenience of carrying refuse (*any* refuse) to a compost pile on a regular basis is just unacceptable. It is more convenient to *discard* organic refuse, such as down a toilet or in a garbage can, and that's why Western cultures do so. However, there are still more than a few people on the planet who are happy to endure a small inconvenience in exchange for less waste, a cleaner environment, and for soil-building compost. Furthermore, there are many people who do not have the luxury of choosing the convenience of waste disposal, as they don't have electricity, running water, or garbage pick-up, and they are therefore prime candidates for the thermophilic composting of their manure.

Likewise, there are those who want to compost their manure, are willing to endure some inconvenience, and still don't want to have to carry it anywhere. Those are people who may want to try situating their toilets directly above their compost

piles, such as is done with a mouldering toilet. This may be best suited in warm climates where an outdoor toilet is acceptable, or in situations where an easily accessible basement is available for the location of the compost pile. There's no reason why this scenario would not work *if the compost is properly managed*. Proper management can be summed up simply with four requirements:



This sawmill shed is full of raw, hardwood sawdust. Large quantities of this carbon-rich organic material are typically available at numerous sawmills throughout any forested area, either free for the hauling, or at very little cost. The above sawdust is being protected from the weather so it won't freeze, however, for composting purposes it is best to leave the sawdust exposed to the elements so it will become damp and will more rapidly decompose. Rotted sawdust is better for a compost pile than raw sawdust; kiln-dried sawdust (from a lumber yard) is the worst due to its relatively inert dehydrated state which resists microbial decomposition (let it sit out in the rain to rehydrate it). Sawdust alone decomposes slowly and may take 15 years to fully decompose. However, when blended with nitrogen rich, moist humanure, it will decompose relatively rapidly, returning to humus in year or two.

An Important Note About Sawdust

Not all sawdust decomposes well. Some tree species contain antibiotic oils that retard the development of microorganisms, and sawdust from these trees does *not* make good compost. These trees include **CEDAR, REDWOOD, BLACK LOCUST, OSAGE ORANGE, CYPRESS, WHITE OAK**, and perhaps others. Some rot-resistant hardwoods such as white oak *will* make good compost if the sawdust is left to decompose outside for a year or two before using for compost. Although the author uses only hardwood sawdust for compost because he lives in a hardwood forest area, **softwood sawdust makes good compost too, and some say it's even better than hardwood**. You be the judge. Experiment!

1) *Use at least a double chambered, above ground compost bin.* Deposit in one chamber for a period of time (e.g. a year), then switch to the other for an equal period of time.

2) *Deposit a good mix of organic refuse into the compost pile, including kitchen scraps.*

3) *Always cover humanure deposits with an organic cover material such as sawdust, leaves or hay.* Make sure that enough cover is applied so that there is neither excess liquid build-up nor offensive odors escaping the compost pile. The trick to using cover material is quite simple: *if it smells bad, cover it.*

4) *Keep good access to the pile* in order to rake the top flat, to apply bulky cover material when needed, and to monitor the temperature of the pile, if desired. The advantage of aerobic composting, as is typical of an above-ground pile, over anaerobic composting typical of sealed pits, is that the aerobic compost will generate higher temperatures, thereby ensuring a more rapid and complete destruction of potential human pathogens. It is still widely reported today that the aeration of a compost pile is best achieved by manual methods, especially turning of the pile, such as with a shovel, although I dispute this. Because of the widespread encouragement to turn compost piles, I turned my compost every year for over a decade, until I started monitoring the temperature of my compost pile using a compost thermometer. That's when I discovered that when I turned my compost, the thermophilic activity of the pile immediately stopped, and the pile cooled down, which is just the opposite of what one would expect. Yet the explanation is simple.

Perhaps my composting technique is unique in that it is as simple as it can get. I build the same pile for a year in an above-ground wooden bin, then I leave it to age for another year as I build a second pile. After the second year, I remove the first pile, which is now finished, and I start over in the first bin with a new pile. I use an annual system because my growing season is based on an annual system. I apply compost to my garden once a year because I only plant a garden once a year. When one builds the same pile *continuously* for a year, one will find during the course of that year that the thermophilic area of the pile is on the top where the fresh deposits reside. The lower sections of the pile have already heated and are now undergoing a cooler decomposition by fungi, earthworms etc. The pile is constantly growing on top and constantly shrinking beneath, and the thermophilic layer is therefore constantly rising to digest the newer deposits. When a pile such as this is turned, the thermophilic layer on top becomes diluted with the cooler, thermophilically-spent lower layers, and the carbon/nitrogen balance consequently becomes disrupted. The thermophiles don't have the proper balanced diet, and they cool down and die off, oxygen or no oxygen. All the oxygen in the world isn't going to ensure a successful compost

pile when the other requirements for successful compost are not met.

When I came to understand this phenomenon as it relates to continuous composting, I realized that if the compost pile is heating sufficiently, it obviously has enough oxygen. There is no need to add more, and if one tries to do so by turning the pile, one instead runs the risk of disrupting the C/N ratio of the thermophilic layer of the compost, thereby putting out its fire. Since my compost heats more than adequately for the purposes of hygiene, I've been forced to come to the conclusion that the simple act of covering humanure deposits with coarse materials such as straw or weeds, actually helps to trap sufficient oxygen in the pile *to render any additional or manual aeration of the compost unnecessary.*

Furthermore, in my case, all human urine is collected with fecal material and composted in the same elevated pile. This is made possible and convenient by using an absorbent carbonaceous material in the toilet receptacle itself, which absorbs the urine and covers the humanure deposits, thereby eliminating odors, flies and any other problems. I use rotting sawdust from logs because it is a readily available and inexpensive local resource, and it works. I used to haul a free load home every so often in the back of my pick-up truck, but now I just have a fellow with a small dump truck deliver me a load every year or two. I have the sawdust dumped outside where it can remain exposed to the elements and thereby slowly decompose on its own, as rotting sawdust makes compost more quickly than fresh sawdust. The sawdust doesn't cost anything, but it usually costs about five dollars to have it loaded and another twenty or so to have it hauled. This is an expense I'm happy to pay in order to ensure for myself a functional compost toilet system. However, my guess is that any cellulose-based material or combination of materials would work, including perhaps ground newsprint, or even just plain soil, if collected and kept dry enough to be absorbent.

Anaerobic systems seem best suited in situations where large amounts of refuse need to be composted, such as in an anaerobic pit where municipal refuse is deposited. Compost microorganisms, in the absence of oxygen (anaerobic), convert organic nitrogen to ammonia, while carbon is reduced to methane, and sulfur to hydrogen sulfide. This results in rather severe odor problems, and the destruction of pathogens proceeds slowly due to the relatively low composting temperatures. Such destruction may take up to twelve months for roundworm eggs.¹²

When I read about all of the styles and techniques for composting humanure, including vaults, pits, segregation of urine, liming, ashing, sealing, turning, etc., I wonder if anyone has tried to simply collect humanure, with urine and a carbon cover material, and pile it in a bin with garbage and other local organic cover materials such as weeds. Such a simple system, although not glamorous or sophisticated, works.

And that's what really matters, doesn't it?

Simple, low-tech compost systems not only have a low negative impact on the Earth's ecosystems, but are proven to be sustainable. Westerners may think that any system not requiring technology is too primitive to be worthy of respect. However, when Western culture is nothing more than a distant and fading memory in the collective mind of humanity thousands (hundreds?) of years from now, the humans who will have learned how to survive on this planet in the long term will be those who have learned how to live in harmony with it. That will require much more than intelligence or technology - it'll require a sensitive understanding of our place as humans in the web of life. That self-realization may be beyond the grasp of our egocentric intellects. Perhaps what is required of us in order to gain such an awareness is a sense of humility, and a renewed respect for that which is simple.

Some would argue that a very simple system of humanure composting can also be the most advanced system known to humanity. It may be considered the most advanced because it works well *while consuming little, if any, non-renewable resources, producing no pollution, and actually creating a resource vital to life.*

Now others may argue that in order for a system to be considered "advanced", it must display all the gadgets, doodads and technology normally associated with advancement. The argument is that something is advanced if it's been created by the scientific community, by humans, not by nature. That's like saying the most advanced method of drying one's hair is using a nuclear reaction in a nuclear power plant to produce heat in order to convert water to steam in order to turn electric generators in order to produce electricity in order to power a plastic hair-drying gun in order to blow hot air on one's head. But that's only technological advancement. It reflects humanity's *intellectual* progress . . . (I think).

True advancement, others would argue, instead requires the *balanced* development of humanity's intellect with physical and spiritual advancement. We must link what we know intellectually with the physical effects of our resultant behavior, and with the understanding of ourselves as small, interdependent, interrelated life forms in relation to a greater sphere of existence. Otherwise, unbalanced technological advancement uses technology to excessively consume non-renewable resources and to create toxic waste and pollution in order to do a simple task such as hair drying, which is easily done by hand with a towel. If that's advancement, we're in trouble.

Perhaps we're really advancing ourselves when we can function healthfully, peacefully and sustainably without squandering resources and without creating pollution. That's not a matter of mastering the intellect or of mastering the environment with technology, it's a matter of mastering one's self, a much more difficult undertaking, but certainly a worthy goal.

REFERENCES - CHAPTER FIVE

- 1 - Crook, James. (1985). "Water Reuse in California", *Journal American Water Works Association*, v.77, no.7, as seen in The Water Encyclopedia (van der Leeden, et. al., 1990, Lewis Publishers, Chelsea, Mich. 48118).
- 2 - Boyd, Robert F. and Hoerl, Bryan G. (1977). Basic Medical Microbiology. Little, Brown and Co., Boston. (p.494).
- 3 - Clayton, D., and Jacke, D. (1992). The Gap Mountain Permaculture Mouldering Toilet. Published by Gap Mountain Permaculture, 9 Old County Road, Jaffrey, NH 03452, phone:(603) 532-6877. Cost of mouldering toilet publication is \$12.00.
- 4 - Rybczynski, W. et. al. (1982). Appropriate Technology for Water Supply and Sanitation - Low Cost Technology Options for Sanitation, A State of the Art Review and Annotated Bibliography. World Bank. (p. 63). [see below]
- 5 - See ***Clivus Multrum Maintenance Manual***, Clivus Multrum, Inc., 21 Canal St., Lawrence, Mass. 01840. (Also contact Hanson Assoc., Lewis Mill, Jefferson, MD 21755)
- 6 - Contact ***Sun Mar Corp.***, 900 Hertel Ave., Buffalo, NY 14216 USA; or 5035 North Service Road, Burlington, Ontario, Canada L7L5V2.
- 7 - Contact ***AlasCan, Inc.***, 3400 International Way, Fairbanks, Alaska 99701, phone/fax (907) 452-5257 [as seen in *Garbage*, Feb/Mar 1993, p.35].
- 8 - ***Composting Toilet Systems***, PO Box 1928 (or 1211 Bergen Rd.), Newport, WA 99156, phone: (509) 447-3708/ fax (509) 447-3753.
- 9 - Rybczynski, W. et. al. (1982). Appropriate Technology for Water Supply and Sanitation - Low Cost Technology Options for Sanitation, A State of the Art Review and Annotated Bibliography. World Bank. Transportation and Water Department, 1818 H Street N.W., Washington D.C. 20433 USA. [Note: This work contains a bibliography on compost toilets that the reader may find useful.]
- 10 - Franceys et. al. (1992). A Guide to the Development of On-Site Sanitation. World Health Organization, Geneva. (p. 213).
- 11 - Rybczynski, as above. (p. 114).
- 12 - Franceys, et. al., as above. (p.214).
- 13 - McGarry, Michael G., and Stainforth, Jill (eds.) (1978). Compost, Fertilizer, and Biogas Production from Human and Farm Wastes in the People's Republic of China. International Development Research Center, Box 8500, Ottawa, Canada, K1G 3H9 (pages 9, 10, 29, 32).

Additional Sources of Composting Toilet Plans and/or General Information:

- ***Appalachia Science in the Public Interest**. Route 5, Box 423, Lexington KY 40445. [ASPI has a technical bulletin on composting toilets which includes a schematic for a compost toilet which ASPI designed.]
- ***Water Conservation Systems, Inc.** Damonmill Square, Nine Pond Lane, Concord, MA 01742 (508) 369-3951 [A source of several brands of composting toilets, including Biolet, Sunmar, Carousel, Alascan, Ecos Soltran, Sealand, Pactosan, and Nepon, as well as a variety of toilet accessories.]

***EKAT**, Robert J. Fairchild, Executive Director, 150 Gravel Lick Branch Road, Dreyfus, KY 40426-9700, ph. (606) 986-6146. ["Big Batch Composting Toilet Plans" \$7. Describes the do-it-yourself construction of compost toilets built of large, rolling, polyethylene dump carts, or "tilt trucks".]

***Long Branch Environmental Education Center**. P.O. Box 369, Leicester, NC 28748 (704) 683-3662. ["Do-It Yourself Passive Solar Compost Toilet" (\$25.00 for blueprints); Goodbye to the Flush Toilet by Carol Stoner (\$18.00 postpaid); "Compost Toilets: A Guide for Owner Builders" (\$8.00 postpaid).]

***National Center for Appropriate Technology**. 3040 Continental Drive, PO Box 3838, Butte MT 59702 (406) 494-4572. ["Compost Toilets: Suggested Readings", 1992, 6 pages, \$2; and "Wastes to Resources: Appropriate Technologies for Waste Conversion", 1984, 28 pages, \$4.]

***Real Goods**. 966 Mazzoni St., Ukiah, CA 95482-9486 USA, (800)762-7325. [They sell compost toilets and many other things.]

* **Biolet** (International, Canada, and USA)

Biolet USA Inc., Damonmill Square, Nine Pond Lane, Concord, MA 01742; 1-8005BIOLET. In Canada: Biolet Toilets Ltd., 1177 West Hastings Street, Suite 1106, Vancouver, BC, V6E2K3; Ph: 604-685-5265.

***Jade Mountain** 717 Poplar Ave., Boulder, CO 80304, or PO Box 4616, Boulder, CO 80306-4616; Ph: 303-449-6601 or 800-442-1972. (They sell various toilets).

***Lehman Hardware**, Box 41, Kidron, Ohio 44636; Ph: 216-857-5441. (They have a selection of toilets).

***Soiltech** (Biolet distributor) 607 E. Canal St., Newcomerstown, Ohio 43832-1207; Ph: 614-498-5929 or 800-296-6026.

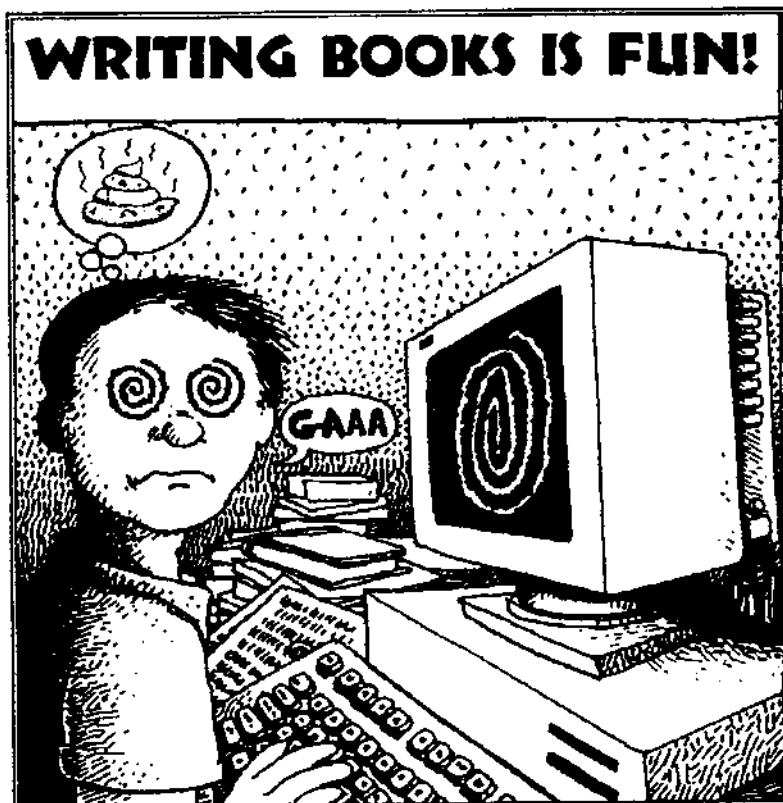

WORMS AND DISEASE

“Compost heaps. We built them regularly out of all the waste material we could find and watered them lavishly with liquid from the communal cesspool. I had, as chief composter, responsibility for seeing that they heated properly . . . A well-made compost heap steams like a tea kettle and gets hot enough to destroy all pathogens that may be present when one uses human sewage. An extraordinary device when one thinks about it. Thermophilic bacteria. Bacteria that can live and flourish in temperatures hot enough to cook an egg. How can they survive in such heat? Truly the tricks of nature are extraordinary!”

Robert S. deRopp



I well remember in 1979 when I first informed a friend that I intended to compost my own manure and grow my own food with it. *“Oh my God, you can’t do that!”* she cried.

“Why not?”

“Worms and disease!”

Of course. What else would a fecophobe think of when one mentions using humanure as a fertilizer?

An English couple was visiting me one summer after I had been composting humanure for about six years. One evening, as dinner was being prepared, the couple suddenly understood the horrible reality they now found themselves faced with: the food they were about to eat was *recycled shit*. When this “fact” dawned upon them it seemed to set off some kind of instinctive English alarm in their minds, possibly inherited directly from Queen Victoria. *“We don’t want to eat shit!”* they quite seriously informed me (that’s an exact quote), as if in preparing dinner I was simply defecating on plates and setting them on the table. Never mind that the food appeared quite palatable. It was the *thought* of it that mattered.

Fecophobia is alive and well and currently residing in about a billion Westerners. Oh well, ignorance is a problem. I have no doubt that if I were living five hundred years ago, I’d be considered one of those “witches” of bygone days. What made a person a witch was their refusal to accept the intellectual constraints of the era, which forced them to be seen as nonconforming and threatening to the status quo. The solution at that time reflected the puny intelligences and spiritual destitution of the establishment leaders: they’d simply gather up the non-conformists and burn

them alive. Yes, ignorance is a chronic human problem.

One common misconception is that fecal material, when composted, remains fecal material. *It does not.* Humanure comes from the earth, and through the miraculous process of composting, returns to earth. When the composting process is finished, the end product is earth, not shit. That earth, or humus, is useful in growing food. My friends unfortunately didn't understand this, and they chose instead to continue clinging to their misconceptions, despite my attempts to clarify the matter for their benefit. Apparently, some fecophobes will always remain fecophobes.

THE HUNZAS

It's already been mentioned that entire civilizations have recycled humanure for thousands of years. That should provide a fairly convincing testimony about the usefulness of humanure as an agricultural resource. Nearly everyone's heard of the "healthy Hunzas", a people in what is now a part of Pakistan who live among the Himalayan peaks, and routinely survive to be 120 years old. The Hunzas gained fame in the United States during the 1960's health food era, at which time several books were written about the fantastic longevity of this ancient people. Their extraordinary health has been attributed to the quality of their overall lifestyle, including the quality of the natural food they eat and the soil it's grown on. Few people, however, realize that the Hunzas also compost their humanure and use it to grow their food. The Hunzas, who call themselves "Hunzakuts", have bronzed but Caucasian features like southern Europeans. They're said to have virtually no disease, no cancer, no heart or intestinal trouble, and they regularly live to be over a hundred years old while *"singing, dancing and making love all the way to the grave."*

According to Tompkins (1989), *"In their manuring, the Hunzakuts return everything they can to the soil: all vegetable parts and pieces that will not serve as food for humans or beast, including such fallen leaves as the cattle will not eat, mixed with their own seasoned excrement, plus dung and urine from their barns. Like their Chinese neighbors, the Hunzakuts save their own manure in special underground vats, clear of any contaminable streams, there to be seasoned for a good six months. Everything that once had life is given new to life through loving hands (emphasis mine)."*¹

Sir Albert Howard wrote in 1947, *"The Hunzas are described as far surpassing in health and strength the inhabitants of most other countries; a Hunza can walk across the mountains to Gilgit sixty miles away, transact his business, and return forthwith without feeling unduly fatigued."* Sir Howard maintains that this is illustra-

tive of the vital connection between a sound agriculture and good health, insisting that the Hunzas have evolved a system of farming which is perfect. He adds, *“To provide the essential humus, every kind of waste [sic], vegetable, animal and human, is mixed and decayed together by the cultivators and incorporated into the soil; the law of return is obeyed, the unseen part of the revolution of the great Wheel is faithfully accomplished.”*²

Sir Howard’s view is that soil fertility is the real basis of public health. A medical professional associated with the Hunzas claimed, *“During the period of my association with these people I never saw a case of asthenic dyspepsia, of gastric or duodenal ulcer, of appendicitis, of mucous colitis, of cancer. . .Among these people the abdomen over-sensitive to nerve impressions, to fatigue, anxiety, or cold was unknown. Indeed their buoyant abdominal health has, since my return to the West, provided a remarkable contrast with the dyspeptic and colonic lamentations of our highly civilized communities.”*

Sir Howard’s response to this is, *“The remarkable health of these people is one of the consequences of their agriculture, in which the law of return is scrupulously obeyed. All their vegetable, animal and human wastes [sic] are carefully returned to the soil of the irrigated terraces which produce the grain, fruit, and vegetables which feed them.”*³

PATHOGENS

[Much of the following information is adapted from Appropriate Technology for Water Supply and Sanitation, by Feachem, et. al., World Bank, 1980.⁴ This comprehensive work cites 394 references from throughout the world, and was carried out as part of the World Bank’s research project on appropriate technology for water supply and sanitation. The reader can assume that the following facts and figures for which no references are shown originated in the above work. Other sources used for reference are as indicated.]

Clearly, the recycling of humanure for agricultural purposes does not necessarily pose a threat to human health, as evidenced by the Hunzas. And yet, it can. Feces can harbor any of a host of disease germs which can make their way into the environment to infect innocent people, as was apparently the case in medieval Europe. In fact, even a healthy person apparently free of disease can pass potentially dangerous pathogens through the feces, simply by being a carrier. Even urine, usually considered sterile, can contain disease germs (see table 6:1).

Table 6.1 (Source: Feachem et. al., 1980)
POTENTIAL PATHOGENS IN URINE

Healthy urine on its way out of the human body may contain up to 1,000 bacteria, of several types, per milliliter. More than 100,000 bacteria per milliliter of a single type signals a urinary tract infection.²³ Infected individuals will pass pathogens in the urine that may include:

<u>Bacteria</u>	<u>Disease</u>
1. <i>Salmonella typhi</i>	<i>typhoid</i>
2. <i>Salmonella paratyphi</i>	<i>paratyphoid fever</i>
3. <i>Leptospira</i>	<i>leptospirosis</i>
4. <i>Yersinia</i>	<i>yersiniosis</i>
<u>Worms</u>	<u>Disease</u>
<i>Schistosoma haematobium</i>	<i>schistosomiasis</i>

The following information is not meant to be alarming. It's included for the sake of thoroughness, and to illustrate the need to *thermophilically compost* humanure, rather than to try to use it raw for agricultural purposes. Humanure has been used raw in farm fields and is still used in such a state at times in various places throughout the world, including China. This is where the danger lies, as the process of thermophilic composting is required in order to kill dangerous pathogens that may reside in human excrement. When the composting process is side-stepped and pathogenic organic material is distributed throughout the environment, various diseases and worms can infect the population living in the contaminated area. This fact has been widely documented in societies where members recycle their manure carelessly as well as in those that don't recycle at all.

For example, consider the following quote from Jervis (1990): "*The use of night soil [raw human fecal material and urine] as fertilizer is not without its health hazards. Hepatitis B is prevalent in Dacaiyuan [China], as it is in the rest of China. Some effort is being made to chemically treat human waste [sic] or at least to mix it with other ingredients before it is applied to the fields. But chemicals are expensive, and old ways die hard. Night soil is one reason why urban Chinese are so scrupulous about peeling fruit, and why raw vegetables are not part of the diet. Negative features aside, one has only to look at satellite photos of the green belt that surrounds China's cities to understand the value of night soil.*"⁵

On the other hand, "worms and disease" are not spread by properly prepared compost, nor by healthy people. There is no reason to believe that the manure of a

healthy person is dangerous unless left to accumulate, pollute water with intestinal bacteria, and breed flies and/or rats, all of which are the results of negligence or bad customary habits. It should be understood that the breath one exhales can also be the carrier of dangerous pathogens, as can one's saliva and sputum. The issue is confused by the notion that if something is potentially dangerous, then it is always dangerous, which is not true. Furthermore, it is generally not understood that the carefully managed thermophilic composting of humanure kills all human pathogens in the manure. No other system of fecal material and urine recycling or disposal does this without the use of dangerous chemical poisons or a high level of technology and energy consumption.

The pathogens that can exist in human feces can be divided into four general categories: *viruses, bacteria, protozoa, and worms (helminths)*.

There are more than 100 types of **viruses** worldwide that can be passed through human feces, including polioviruses, coxsackieviruses (causing meningitis and myocarditis), echoviruses (causing meningitis and enteritis), reovirus (causing enteritis), adenovirus (causing respiratory illness), infectious hepatitis (causing jaundice), and others (see table 6:2).

Of the pathogenic **bacteria**, the genus *Salmonella* is significant because it contains species causing typhoid fever, paratyphoid, and gastrointestinal disturbances. Another genus of bacteria, *Shigella*, causes dysentery. *Mycobacterium* cause

Table 6.2 (Source: Feachem et. al., 1980)

POTENTIAL VIRAL PATHOGENS IN FECES

<u>Virus</u>	<u>Disease</u>	<u>Can Carrier Be Symptomless?</u>
1. <i>Rotaviruses</i>	Diarrhea.....	yes
2. <i>Hepatitis A</i>	Infectious hepatitis	yes
3. <i>Adenoviruses</i>	varies	yes
4. <i>Reoviruses</i>	varies	yes
5. <i>Coxsackievirus</i>	varies	yes
6. <i>Echoviruses</i>	varies	yes
7. <i>Polioviruses</i>	Poliomyelitis	yes

Rotaviruses may be responsible for the majority of infant diarrheas. Hepatitis A causes infectious hepatitis, but is often without symptoms, especially in children. Coxsackievirus infection can lead to meningitis, fevers, respiratory diseases, paralysis, and myocarditis. Echovirus infection can cause simple fever, meningitis, diarrhea, or respiratory illness. Most poliovirus infections don't give rise to any clinical illness, although sometimes infection causes a mild, influenza-like illness which may lead to virus-meningitis, paralytic poliomyelitis, permanent disability or death. It's estimated that almost everyone in developing countries becomes infected with poliovirus, and that one out of every thousand poliovirus infections leads to paralytic poliomyelitis.

tuberculosis (see table 6:3).

The pathogenic **protozoa** include *Entamoeba histolytica* (amoebic dysentery), and members of the Hartmanella-Naegleria group (meningo-encephalitis). The cyst stage in the life cycle of protozoa is the primary means of dissemination as the amoeba die quickly once outside the human body. Cysts must be kept moist in order to remain viable for any extended period (see table 6:4).⁶

Finally, a number of parasitic **worms** pass their eggs in feces, including hookworms, roundworms, and whipworms (see table 6:5). Various researchers have reported 59 to 80 worm eggs in sampled liters of sewage. This suggests that billions of pathogenic worm eggs may reach an average wastewater treatment plant daily. These eggs tend to be resistant to environmental conditions due to a thick outer covering.⁷

Now here's a good place to stop and do some calculations. If there are fifty-nine to eighty worm eggs in a liter sample of sewage, then we could reasonably estimate that there are 70 eggs per liter, or 280 eggs per gallon to get a ballpark average.

Table 6.3 (Source: Feachem et. al., 1980)
POTENTIAL BACTERIAL PATHOGENS IN FECES

<u>Bacteria</u>	<u>Disease</u>	<u>Symptomless Carrier</u>
1. <i>Salmonella typhi</i>	Typhoid fever.....	yes
2. <i>Salmonella paratyphi</i>	Paratyphoid fever.....	yes
3. Other <i>Salmonellae</i>	Food poisoning	yes
4. <i>Shigella</i>	Dysentery.....	yes
5. <i>Vibrio cholerae</i>	Cholera.....	yes
6. Other <i>Vibrios</i>	Diarrhea	yes
7. <i>E. coli</i>	Diarrhea	yes
8. <i>Yersinia</i>	Yersiniosis	yes
9. <i>Campylobacter</i>	Diarrhea	yes

Table 6.4 (Source: Feachem et. al., 1980)
POTENTIAL PROTOZOAN PATHOGENS IN FECES

<u>Protozoa</u>	<u>Disease</u>	<u>Symptomless carrier?</u>
1. <i>Balantidium coli</i>	Diarrhea	yes
2. <i>Giardia lamblia</i>	Diarrhea.....	yes
3. <i>Entamoeba histolytica</i>	Dysentery, colonic	yes
	ulceration, liver abscess	

Table 6.5 (Source: Feachem et. al., 1980)
POTENTIAL WORM PATHOGENS IN FECES

<u>Common Name</u>	<u>Pathogen</u>	<u>Transmission</u>	<u>Distribution</u>
1. Hookworm	<i>Ancylostoma doudenale</i> <i>Necator americanus</i>	Human-soil-human	Warm, wet climates
2. ———	<i>Heterophyes heterophyes</i>	Dog/cat-snail-fish-human	Middle east, S. Europe, Asia
3. ———	<i>Gastrodiscoides</i>	Pig-snail-aquat. veg.-human	India, Bangladesh, Vietnam, Philippines
4. Giant Intestinal fluke	<i>Fasciolopsis buski</i>	Human/pig-snail-aq. veg.-human	S.E. Asia, China
5. Sheep liver fluke	<i>Fasciola hepatica</i>	Sheep-snail- aq. veg.-human	Worldwide
6. Pinworm	<i>Enterobius vermicularis</i>	Human-human	Worldwide
7. Fish tapeworm	<i>Diphyllobothrium latum</i>	Human/animal-copepod-fish-human	Mainly temperate
8. Cat liver fluke	<i>Opisthorchis felineus</i> , <i>O. viverrini</i>	Animal-aq. snail-fish-human	USSR, Thailand
9. Chinese liver fluke	<i>Chlonorchis sinensi</i>	Animal/human-snail-fish-human	S.E. Asia
10. Roundworm	<i>Ascaris lumbricoides</i>	Human-soil- human	Worldwide
11. Dwarf tapeworm	<i>Hymenolepis spp</i>	Human/rodent-human	Worldwide
12. ———	<i>Metagonimus yokogawai</i>	Dog/cat-snail-fish-human	Japan, Korea, China, Taiwan, Siberia
13. Lung fluke	<i>Paragonimus westermani</i>	Animal/human- snail-crab/crayfish-human	S.E. Asia, Africa, S.America
14. Schistosome, bilharzia	<i>Schistosoma haematobium</i>	Human-snail- human	Africa, M. East, India
-----	<i>S. mansoni</i>	Human-snail- human	Africa, Arabia , Latin America
-----	<i>S. japonicum</i>	Animal/human- snail-human	S.E. Asia
15. Threadworm	<i>Strongyloides stercoralis</i>	Human-human (dog-human?)	Warm, wet climates
16. Beef tapeworm	<i>Taenia saginata</i>	Human-cow- human	Worldwide
Pork tapeworm	<i>T. solium</i>	Human-pig-human or human-human	Worldwide
17. Whipworm	<i>Trichuris trichiura</i>	Human-soil-human	Worldwide

That's approximately 280 pathogenic worm eggs per gallon of wastewater entering wastewater treatment plants. My local wastewater treatment plant serves a population of eight thousand people and collects about 1.5 million gallons of wastewater daily. That means there could be 420 million worm eggs entering the plant each day and settling into the sludge. In a year's time over 153 *billion* parasitic eggs can pass through my local small-town wastewater facility. Now let's look at the worst scenario: all the eggs survive in the sludge because they're resistant to the environmental conditions at the plant. Well, in a year's time, 30 tractor-trailer loads of sludge are hauled out of the local facility. Each truckload of sludge could then contain over 5 *billion* pathogenic worm eggs, en route to maybe a farmer's field, but probably a landfill. Now, if we were composting that manure instead of floating it downstream, we'd be killing those eggs. But there I go getting ahead of myself again.

INDICATOR PATHOGENS

Indicator pathogens are pathogens whose detectable occurrence in soil or water serves as evidence that fecal contamination exists.

The astute reader will have noticed that many of the pathogenic worms listed previously are not found in the United States. Of those that are, the *Ascaris lumbricoides* (roundworm) is the most persistent, and can serve as an indicator for the presence of pathogenic helminths in the environment.

A single female roundworm may lay as many as 27 million eggs in her lifetime.⁸ These eggs are protected by an outer covering that is resistant to chemicals and that can enable the eggs to remain viable in soil for long periods of time. The reported viability of roundworm eggs (*Ascaris ova*) in soil ranges from a couple of weeks under sunny, sandy conditions⁹, to 2 and a half years¹⁰, four years¹¹, five and a half years¹² or even ten years¹³ in soil, depending on the source of the information. Consequently, the eggs of the roundworm seem to be the best indicator for the determination of parasitic worm pathogens in compost. In China, current standards for the agricultural reuse of humanure require an *Ascaris* mortality of greater than 95 percent.

Ascaris eggs develop at temperatures between 15.5°C (59.90° F) and 35°C (95.00° F), but the eggs disintegrate at temperatures above 38°C (100.40° F)¹⁴. The temperatures generated during thermophilic composting can significantly exceed levels necessary to destroy roundworm eggs.

One way to determine if the compost you're using is contaminated with viable roundworm eggs is to have a stool analysis done at a local hospital. If your compost

is contaminated and you're using the compost to grow your own food, then there's a good chance that you've contaminated yourself. A stool analysis will reveal whether that is the case or not. Such an analysis cost about \$41.00 (1993). [*See page 135]

Indicator bacteria include fecal coliforms, which reproduce in the intestinal systems of warm blooded animals. If one wants to test a water supply for fecal contamination, then fecal coliforms, usually *Escherichia coli*, are looked for. The absence of *E. coli* in water indicates that the water is free from fecal contamination.

Water tests, however, often determine the level of *total coliforms* in the water, reported as the number of coliform/100 ml. Such a test measures *all* species of the coliform group and is not limited to species originating in warm-blooded animals. Since some coliform species come from the soil, the results of this test are not always indicative of fecal contamination in a *stream* analysis. However, this test can be used for *ground water* supplies, as no coliforms should be present in ground water unless it has been contaminated by a warm blooded animal.

Fecal coliforms do not multiply outside the intestines of warm blooded animals, and their presence in water is unlikely unless there is fecal pollution, They survive for a shorter time in natural waters than the coliform group as a whole, therefore their presence indicates relatively recent pollution. In domestic sewage, the fecal coliform count is usually 90% or more of the total coliform count, but in natural streams fecal coliforms may range from 10-30% of the total coliform density. Almost all natural waters have a presence of fecal coliforms, since all warm-blooded animals excrete them. Most states in the U.S. limit the fecal coliform concentration allowable in waters used for water sports to 200 fecal coliform/100ml.

Table 6.13

Average Density of Fecal Coliforms Excreted in 24 Hours (million/100ml)

Human	13.0
Duck	33.0
Sheep	16.0
Pig	3.3
Chicken	1.3
Cow	.23
Turkey	.29

Bacterial analyses of drinking water supplies are routinely provided for a small fee (in 1994 around \$20.00) by agricultural supply firms, water treatment companies, or private labs.

PERSISTENCE OF PATHOGENS IN SOIL, CROPS, MANURE AND SLUDGE

According to Feachem, et. al. (1980), the persistence of fecal pathogens in the environment can be summarized as follows:

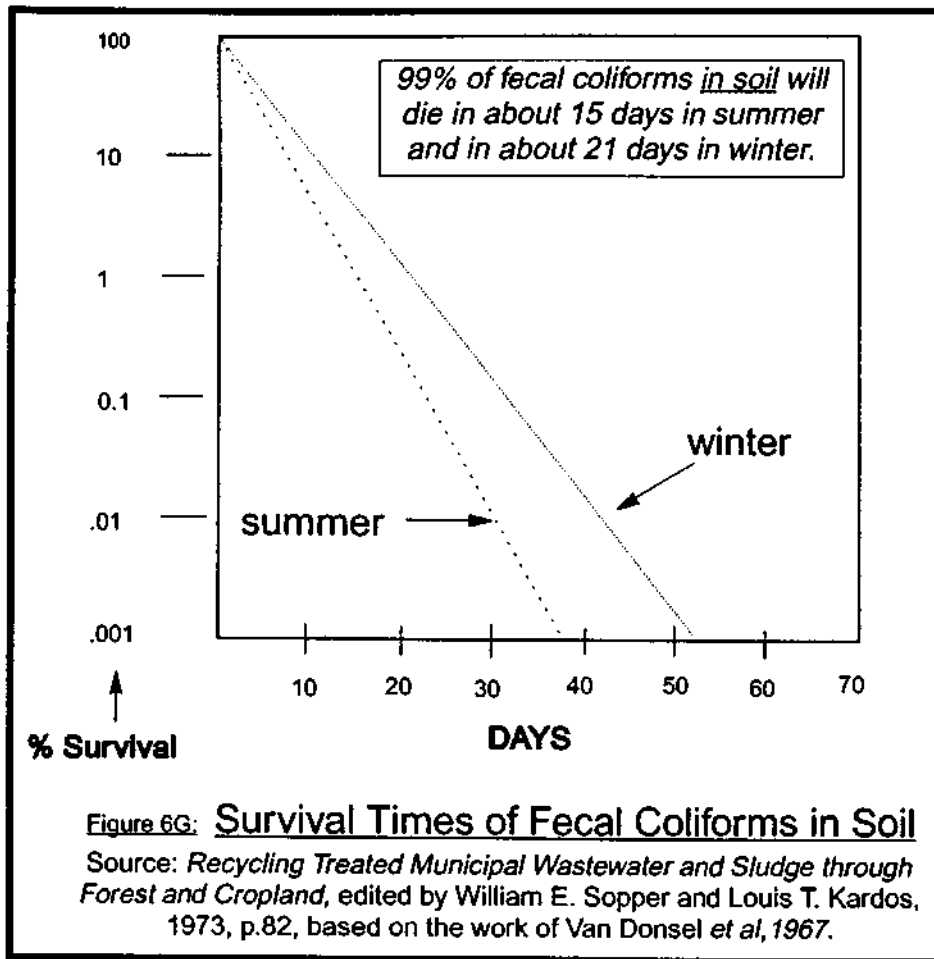

In Soil

Survival times of pathogens in soil are affected by soil moisture, pH, type of soil, temperature, sunlight, and organic matter. Although **fecal coliforms** can survive for several years under optimum conditions, a 99% reduction is likely within 25 days in warm climates (see Figure 6G). **Salmonella bacteria** may survive for a year in rich, moist, organic soil, although 50 days would be a more typical survival time. **Viruses** can

survive up to three months in warm weather, and up to six months in cold. **Protozoan cysts** are unlikely to survive for more than 10 days. **Roundworm eggs** can survive for several years.

The viruses, bacteria, protozoa and worms that can be passed in human excrement all have limited survival times outside of the human body. Let's take a look at their survival times when deposited raw into soil (refer to tables 6.6 through 6.10):

Survival of pathogens On Crops

Bacteria and **viruses** cannot penetrate undamaged vegetable skins. However, pathogens can survive on the surfaces of vegetables, especially root vegetables. Sunshine and low air humidity will promote the death of pathogens. **Viruses** can survive up to 2 months on crops but usually less than one month. **Indicator bacteria** up to several months, but usually less than one month. **Protozoan cysts** usually less than two days. **Worm eggs** usually less than one month.

For example, lettuce and radishes sprayed with sewage inoculated with poliovirus I showed a 99% reduction in pathogens after 6 days, 100% after 36 days (in Ohio). Radishes grown outdoors in soil fertilized with fresh typhoid feces four

Table 6.6 (Source: Feachem et. al., 1980)
SURVIVAL OF ENTEROVIRUSES IN SOIL

Viruses - These parasites, which are smaller than bacteria, can only reproduce inside the animal or plant they parasitize. However, some can survive for long periods outside of their host:

Enteroviruses - Enteroviruses are those that reproduce in the intestinal tract. They have been found to survive in soil for periods ranging between 15 and 170 days. The following chart shows the survival times of enteroviruses in various types of soil and soil conditions:

<u>Soil Type</u>	<u>pH</u>	<u>% Moisture</u>	<u>°C</u>	<u>Days of Survival</u> (less than)
Sterile, sandy	7.5-----	10-20%-----	3-10 -----	130-170 days
		“-----	18-23 -----	90-110
	5-----	“-----	3-10 -----	110-150
		“-----	18-23 -----	40-90
Non-sterile, sandy	7.5-----	“-----	3-10 -----	110-170
		“-----	18-23 -----	40-110
	5-----	“-----	3-10 -----	90-150
		“-----	18-23 -----	25-60
Sterile, loamy	7.5-----	“-----	3-10 -----	70-150
		“-----	18-23 -----	70-110
	5-----	“-----	3-10 -----	90-150
		“-----	18-23 -----	25-60
Non-sterile, loamy	7.5-----	“-----	3-10 -----	110-150
		“-----	18-23 -----	70-110
	5-----	“-----	3-10 -----	90-130
		“-----	18-23 -----	25-60
Non-sterile, sandy	7.5-----	“-----	18-23 -----	15-25

Table 6.7 (Source: Feachem et. al., 1980)
SURVIVAL TIME OF SOME PROTOZOA IN SOIL

<u>Protozoa</u>	<u>Soil</u>	<u>Moisture</u>	<u>Temp°C</u>	<u>Survival</u>
E. histolytica	loam/sand	Damp	28-34	8-10 days
“	soil	Moist	?	42-72 hr
“	“	Dry	?	18-42 hrs.

Table 6.8 (Source: Feachem et. al., 1980)
SURVIVAL TIME OF SOME BACTERIA IN SOIL

<u>Bacteria</u>	<u>Soil</u>	<u>Moisture</u>	<u>Temp. °C</u>	<u>Survival</u>
<i>Streptococci</i> -----	<i>Loam</i>	?	?	<i>9-11 weeks</i>
“-----	<i>Sandy loam</i>	?	?	<i>5-6 weeks</i>
<i>S. Typhi</i> -----	<i>various soils</i>	?	22	<i>2 days-400 days</i>
<i>Bovine tubercule bacilli</i>	<i>soil & dung</i>	?	?	<i>less than 178 days</i>
<i>Leptospire</i> s-----	<i>varied</i>	<i>varied</i>	<i>summer</i>	<i>12 hrs-15 days</i>

Table 6.9 (Source: Feachem et. al., 1980)

SURVIVAL OF POLIOVIRUSES IN SOIL

<u>Soil Type</u>	<u>Virus</u>	<u>Moisture</u>	<u>Temp. °C</u>	<u>Days of Survival</u>
<i>Sand dunes</i> -----	<i>Poliovirus</i>	<i>dry</i>	?	<i>Less than 77</i>
		<i>moist</i>	?	<i>" 91</i>
<i>Loamy fine sand</i> -----	<i>Poliovirus I</i>	<i>moist</i>	4	<i>90% reduction in 84 days</i>
		<i>moist</i>	20	<i>99.999% red. in 84 days</i>
<i>Soil irrigated w/</i> ----- <i>effluent, pH=8.5</i>	<i>Polioviruses</i> <i>1,2 &3</i>	<i>9-20%</i>	<i>12-33</i>	<i>Less than 8</i>
<i>Sludge or effluent</i> ----- <i>irrigated soil</i>	<i>Poliovirus I</i>	<i>180mm total</i> <i>rain</i>	<i>-14-27</i> -----	<i>96-123 after sludge applied</i>
			<i>-14-27</i> -----	<i>89-96 after effluent applied</i>
		<i>190mm total</i> <i>rain</i>	<i>15-33</i> -----	<i>less than 11 days after</i> <i>sludge or effluent applied</i>

Table 6.10 (Source: Feachem et. al., 1980)

SURVIVAL TIME OF SOME PATHOGENIC WORMS IN SOIL

<u>Worm</u>	<u>Soil</u>	<u>Moisture</u>	<u>°C</u>	<u>Survival</u>
Hookworm larvae	Sand	?	rm. temp.	less than 4 months
	Soil	?	open shade, Sumatra	less than 6 months
	Soil	Moist	Dense shade	9-11 wks
			Mod. shade	6-7.5 wks
			Sunlight	5-10 days
	Soil	Water covered	varied	10-43 days
	Soil	Moist	0°	less than 1 week
		16	14-17.5 weeks	
		27	9-11 weeks	
		35	less than 3 weeks	
		40	less than 1 week	
Hookworm ova (eggs)	Heated soil with night soil	water covered	15-27	9% survival after 2 weeks
	Unheated soil with night soil	water covered	15-27	3% survival after 2 weeks
Roundworm ova	Sandy, shaded		25-36	31% dead after 54 days
	Sandy, sun		24-38	99% dead after 15 days
	Loam, shad		25-36	3.5% dead after 21 days
	Loam, sun		24-38	4% dead after 21 days
	Clay, shade		25-36	2% dead after 21 days
	Clay, sun		24-38	12% dead after 21 days
	Humus, shade		25-36	1.5% dead after 22 days
	Clay, shade		22-35	more than 90 days
	Sandy, shade		22-35	less than 90 days
	Sandy, sun		22-35	less than 90 days
	Soil irrigated with sewage		?	less than 2.5 years
	Soil		?	2 years, 5.5 years ¹⁴ , even 10 years ¹⁵

days after planting showed a pathogen survival period of less than 24 days. Tomatoes and lettuce contaminated with a suspension of roundworm eggs showed a 99% reduction in eggs in 19 days and a 100% reduction in 4 weeks. These tests indicate that if there is any doubt about pathogen contamination of compost, the compost should be applied to long-season crops at the time of planting, so that sufficient time ensues for the pathogens to die before harvest.

Pathogen survival In Sludge and Feces/Urine

Viruses can survive up to 5 months, but usually less than 3 months in sludge and night soil. **Indicator bacteria** up to 5 months, but usually less than 4 months.

Salmonellae up to 5 months, but usually less than one month. Tubercle bacilli up to 2 years, but usually less than 5 months. **Protozoan cysts** up to one month, but usually less than 10 days. **Worm eggs** vary depending on species, but roundworm eggs may survive for many months.

When I started writing this book, I'd been composting my own humanure for nearly fourteen years and using it to grow about 50% of my food (the other 50% I buy). My sawdust toilet was used by many other people during that time period, especially since I operated an alternative school for five years on my property with a peak enrollment of 23 kids, which involved frequent use of my composting toilet system. I had many gatherings of people at my homestead over the years, as many as 150 people during a weekend. Not long before I began writing this book, I had 130 people visit within a twenty-four hour period. The humanure receptacle had to be emptied onto the compost pile four times that day. I've had little control over who's been using my toilet. There may have been people infected with all manner of pathogens depositing their contaminated feces into my composting system. However, I've had faith that the thermophilic composting routine I use has been killing any human pathogens present in the compost. Nevertheless, for the sake of thoroughness I had two stool analyses conducted by the local hospital laboratory as I wrote this, and no intestinal worms or eggs were found.

ELIMINATING PATHOGENS FROM HUMANURE

It should be evident to the reader by now that humanure certainly possesses the capability of transmitting various diseases. For this reason, it should also be evident that the composting of humanure is a serious undertaking and should not be done in a frivolous, careless or haphazard manner. The pathogens that may be present in humanure have various survival periods outside the human body and maintain varied capacities for re-infecting people. This is why the *careful management* of a thermophilic compost system is so important. Nevertheless, there is no proven, natural, low-tech method for destroying human pathogens in organic refuse that is as successful and accessible to the average human as well-managed thermophilic composting.

The following information illustrates the various waste treatment methods and composting methods commonly used today and shows the transmission of pathogens through the individual systems:

Outhouses and Pit Latrines

Outhouses have odor problems, breed flies and possibly mosquitoes, and pollute groundwater. However, if the contents of a pit latrine have been filled over and left for a minimum of one year, there will be no surviving pathogens except for the possibility of roundworm eggs, according to Feachems. This risk is small enough that the contents of pit latrines, after twelve months burial, can be used agriculturally. Franceys, et. al. (1992) state, "Solids from pit latrines are innocuous if the latrines have not been used for two years or so, as in alternating double pits."¹⁵

Septic Tanks

It is safe to assume that septic tank effluents and sludge are highly pathogenic (see figure 6A).

Conventional Sewage Treatment Plants

The only sewage digestion process producing a guaranteed pathogen-free sludge is batch ther-

mophilic digestion in which all of the sludge is maintained at 50°C (122°F) for 13 days. All other sewage digestion processes will allow the survival of worm eggs and possibly pathogenic bacteria. Typical sewage treatment plants instead use a continuous process where wastewater is added daily or more frequently, thereby guaranteeing the survival of pathogens.

I took an interest in my local wastewater treatment plant when I discovered that the treated water it was discharging into our local creek had ten times the level of nitrates that unpolluted water has, and three times the level of nitrates acceptable for drinking water.¹⁶ In other words, the water being discharged from the water treatment plant was polluted with nitrates (we didn't test for pathogens or chlorine levels). Despite the pollution, the levels were within legal limits for wastewater discharges (see figure 6B).

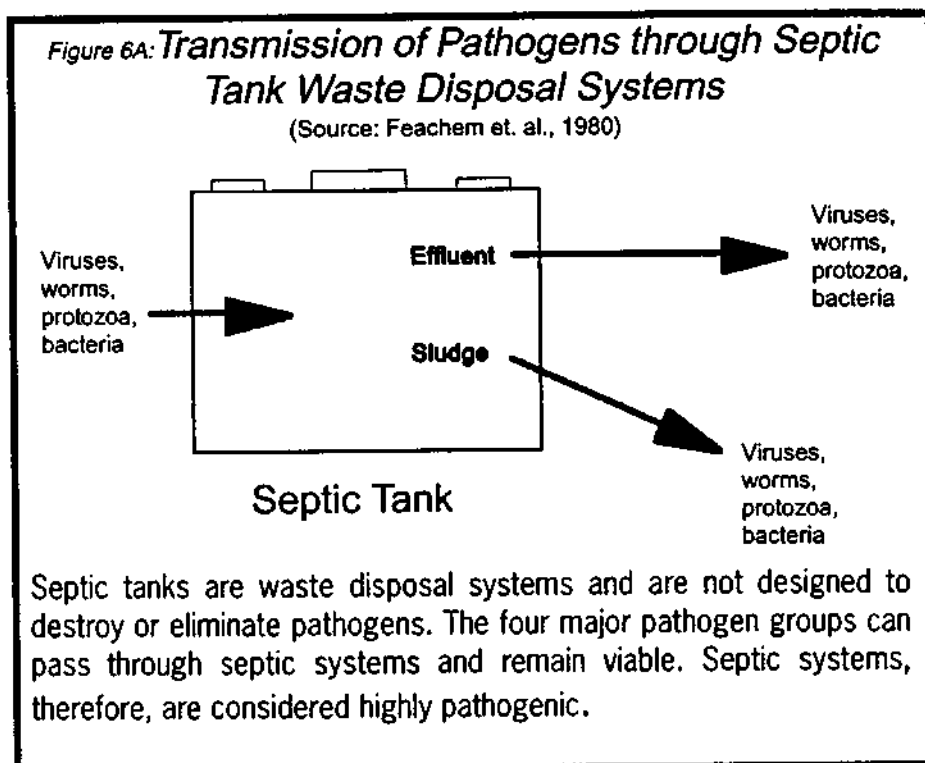
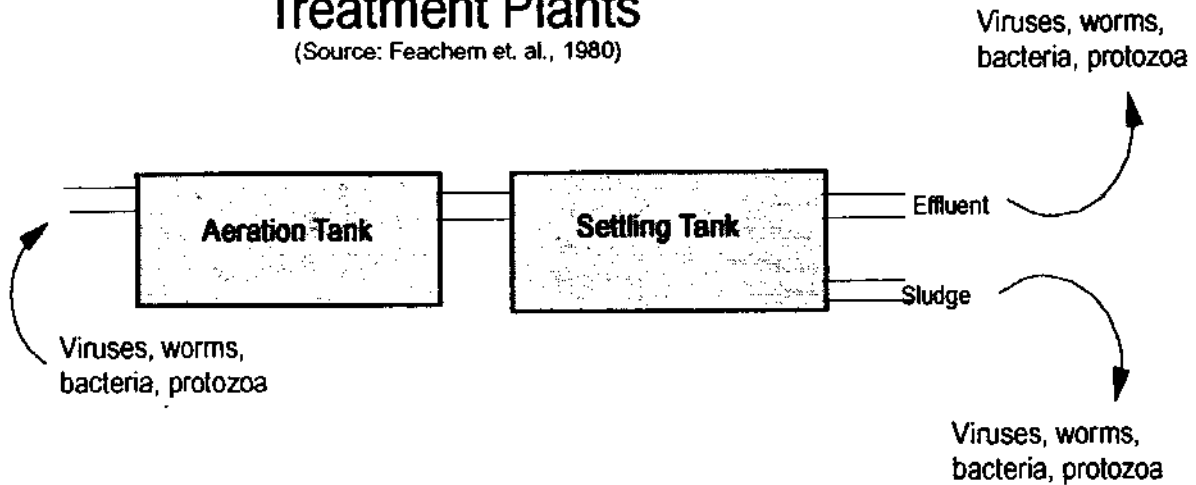

Figure 6B: Transmission of Pathogens through Conventional Sewage Treatment Plants

(Source: Feachem et. al., 1980)



Conventional sewage treatment plants allow the transmission of pathogens through them. Consequently, the effluent is commonly treated with chemical poisons such as chlorine, and the sludge is commonly buried in landfills.

Waste Stabilization Ponds

Waste stabilization ponds, large shallow ponds widely used in North America, Latin America, Africa and Asia, involve the use of both beneficial bacteria and algae in the decomposition of organic waste materials. Although they can breed mosquitoes, they can be designed and managed well enough to yield pathogen-free waste

Figure 6C: Transmission of Pathogens through Waste Stabilization Ponds

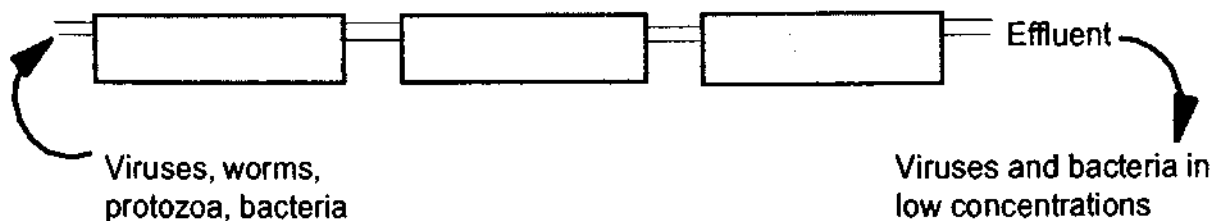

(Source: Feachem et. al., 1980)

water. However, they typically yield water with low concentrations of both pathogenic viruses and bacteria (see figure 6C).

Composting Toilets and Mouldering Toilets

Due to the relatively anaerobic conditions of the multrum and mouldering toilets and the consequently low decomposition temperatures, complete elimination of pathogens from the manure is not likely to be obtained.

However, according to Feachems, et. al., a minimum retention time of three months produces a compost

free of all pathogens except possibly some intestinal worm eggs. Also, the compost obtained from these types of toilets can conceivably be composted again in a thermophilic pile and rendered suitable for food gardens (see figure 6D and table 6.11).

Figure 6D: Transmission of Pathogens through Passive, Low Temperature Composting Toilets and Mouldering Toilets

(Source: Feachem et. al., 1980)

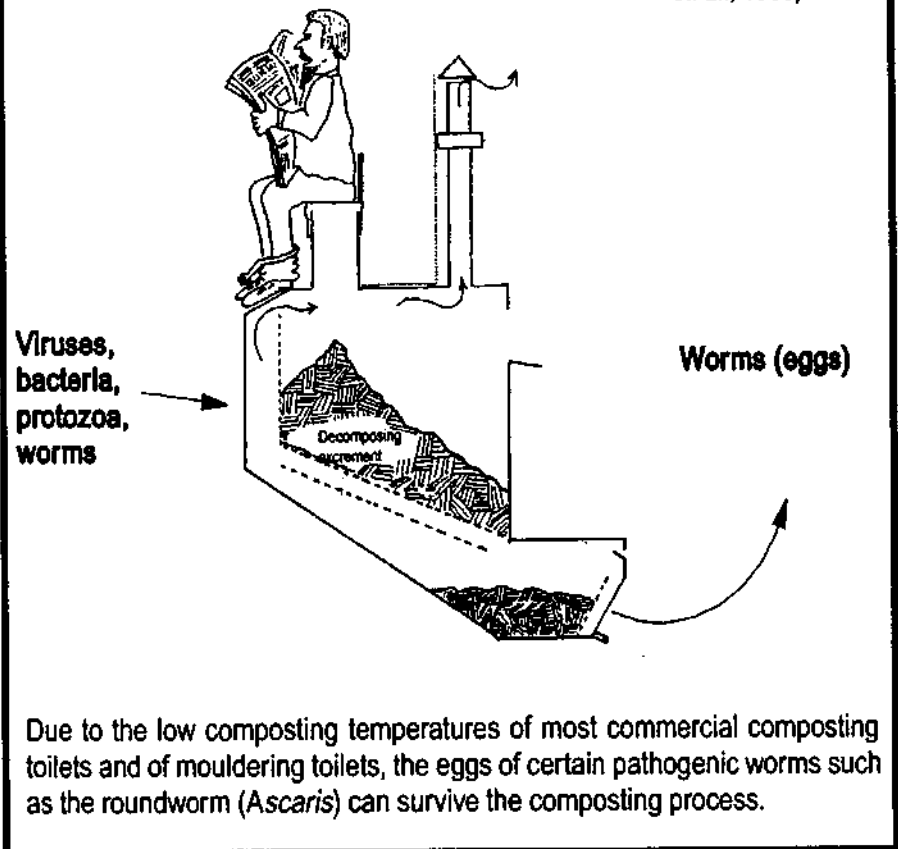

Well-managed Thermophilic Composting System

Complete pathogen destruction is guaranteed by arriving at a temperature of 62°C (143.6°F) for one hour, or 50°C (122°F) for one day, or 46°C (114.8°F) for one week, or 43°C (109.4°F) for one month. It appears that no excreted pathogen can survive a temperature of 65°C (149°F) for more than a few minutes. A compost pile containing entrapped oxygen may rapidly rise to a temperature of 55°C (131°F) or above, or will maintain a temperature hot enough for a long enough period of time to thoroughly destroy human pathogens (see figure 6E). Table 6.11 indicates survival times of pathogens in a) soil, b) anaerobic decomposition conditions, c) composting toilets and d) thermophilic compost piles.

*Figure 6E: Transmission
of Pathogens through
a Thermophilic
Composting System*

(Source: Feachem et. al., 1980)

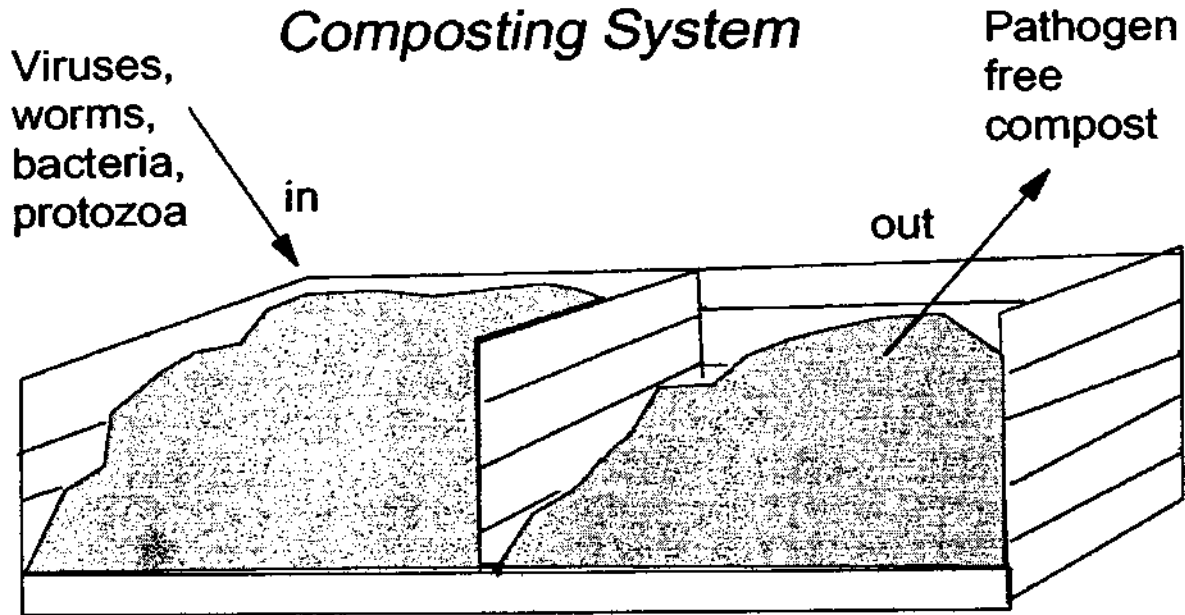

A properly managed thermophilic composting system will generate enough heat to destroy all four groups of human pathogens including parasitic worms and their eggs, viruses, bacteria and protozoa. The resulting finished compost is a hygienically safe, user friendly, soil-building humus.

MORE ON PARASITIC WORMS

This is a good topic to discuss in greater detail as most people know so little about it. Therefore, I'll take a few minutes here to discuss the most common of human worm parasites: pinworms, hookworms, whipworms and roundworms.

Pinworms

I confess, my kids had pinworms during childhood. I know exactly who they

Table 6.11 (Source: Feachem et. al. 1980)

PATHOGEN SURVIVAL BY COMPOSTING OR SOIL APPLICATION

<u>Pathogen</u>	<u>Soil Application</u>	<u>Unheated Anaerobic Digestion</u>	<u>Composting Toilets (3 mo. min. ret.)</u>	<u>Thermophilic Composting</u>
<i>Enteric viruses</i>	May survive 5 months	Over 3 months	Probably eliminated	Killed rapidly at 60°C
<i>Salmonellae</i>	3 months to 1 year	Several weeks	A few may survive	Killed in 20 hrs. at 60°C
<i>Shigellae</i>	Up to 3 months	A few days	Probably eliminated	Killed in 1 hr. at 55°C or in 10 days at 40°C
<i>E. coli</i>	Several months	Several weeks	Probably eliminated	Killed rapidly above 60°C
<i>Cholera vibrio</i>	1 week or less	1 or 2 weeks	Probably eliminated	Killed rapidly above 55°C
<i>Leptospire</i> s	Up to 15 days	2 days or less	Eliminated	Killed in 10 min. at 55°C
<i>Entamoeba histolytica</i> cysts	1 week or less	3 weeks or less	Eliminated	Killed in 5 min. at 50°C or 1 day at 40°C
<i>Hookworm eggs</i>	20 weeks	Will survive	May survive	Killed in 5 min. at 50°C or 1 hr at 45°C
<i>Roundworm (Ascaris) eggs</i>	Several years	Many months	Survive well	Killed in 2 hrs. at 55°C, 20 hrs. at 50°C, 200 hrs. at 45°C
<i>Schistosome eggs</i>	One month	One month	Eliminated	Killed in 1 hr. at 50°C
<i>Taenia eggs</i>	Over 1 year	A few months	May survive	Killed in 10 min. at 59°C, over 4 hrs. at 45°C

got them from (another kid), and getting rid of them was a simple matter. However, the rumor was circulated that they got them from our compost. We were also told to worm our cats to prevent pinworms in the kids (these rumors allegedly originated in a doctor's office). Yet, the pinworm life cycle does not include a stage in soil, compost, manure or cats. These unpleasant parasites are spread from human to human by direct contact, and by inhaling eggs.

Pinworms (*Enterobius vermicularis*) lay microscopic eggs at the anus of a human being, its only known host. This causes itching at the anus which is the primary symptom of pinworm infestation. The eggs can be picked up almost anywhere, and once in the human digestive system they develop into the tiny worms. Some estimate that pinworms infest or have infested 75% of all New York City children in the 3-5 year age group, and that similar figures exist for other cities.¹⁷

These worms have the widest geographic distribution of any of the worm parasites, and are estimated to infect 208.8 million people in the world (18 million in Canada and the U.S.). An Eskimo village was found to have a 66 per cent infection rate, a 60% rate has been found in Brazil, and a 12-41 % rate in Washington D.C.

Infection is spread by the hand to mouth transmission of eggs resulting from scratching the anus, as well as from breathing airborne eggs. In households with several members infected with pinworms, 92% of dust samples contained the eggs. The dust samples were collected from tables, chairs, baseboards, floors, couches, dressers, shelves, window sills, picture frames, toilet seats, mattresses, bath tubs, wash basins and bed sheets. Pinworm eggs have also been found in the dust from school rooms and school cafeterias.

Pregnant female pinworms contain 11,000 to 15,000 eggs. Fortunately, pinworm eggs don't survive long outside their host. At room temperature and 30% to 54% relative humidity more than 90% of the eggs will die within two days. At higher summer temperatures, 90% will die within three hours. Eggs survive longest (2-6 days) under cool, humid conditions; in dry air, none will survive for more than 16 hours.

A worm's life span is 37-53 days and an infection would self-terminate in this period, without treatment, in the absence of reinfection. *The amount of time that passes from ingestion of eggs to new eggs being laid at the anus is from 4 to 6 weeks.*¹⁸

Although dogs and cats do not harbor pinworms, the eggs can get on their fur and find their way back to their human hosts. In about one-third of infected children, eggs may be found under the fingernails.

In 95% of infected persons, pinworm eggs aren't found in the feces. Transmission of eggs to feces and to soil is not part of the pinworm life cycle, which

is one reason why the eggs aren't likely to end up in either feces or compost. Even if they do, they quickly die outside the human host.

One of the worst symptoms of pinworm infestation is the trauma of the parents, whose feelings of guilt, no matter how clean and conscientious they may be, are understandable. However, if you're composting your manure, you can be sure that you are not thereby breeding or spreading pinworms. Quite the contrary, any pinworms or eggs getting into your compost are being destroyed.¹⁹

Hookworms

Hookworm species in humans include *Necator americanus*, *Ancylostoma duodenale*, *A. braziliense*, *A. caninum*, and *A. ceylanicum*.

The small worms are about a centimeter long, and humans are almost the exclusive host of *A. duodenale* and *N. americanus*. A hookworm of cats and dogs, *A. caninum*, is an extremely rare intestinal parasite of humans.

The eggs are passed in the feces and mature into larvae outside the human host in favorable conditions. The larvae attach themselves to the human host usually at the bottom of the foot when they're walked on, and then enter their host through pores, hair follicles or even unbroken skin. They tend to migrate to the upper small intestine where they suck their host's blood. Within 5 or 6 weeks they'll mature enough to produce up to 20,000 eggs per day.

Hookworms are estimated to infect 500 million people throughout the world, causing a *daily blood loss of more than 1 million liters*, which is as much blood as can be found in all the people in the city of Erie, PA, or Austin, Texas. An infection can last 2 - 14 years. Light infections can produce no recognizable symptoms, while a moderate or heavy infection can produce an iron deficiency anemia. Infection can be determined by a stool analysis.

These worms tend to be found in tropical and semi-tropical areas and are

Table 6.12 Hookworms:		
<i>Hookworm larvae develop outside the host and favor a temperature range of 23°C to 33°C (73°F to 91°F).</i>		
<u>Temperature</u>	<u>Survival Time of</u>	
	<u>Eggs</u>	<u>Larvae</u>
45°C (113°F).....	Few hours	less than 1 hour
0°C (32°F).....	7 days	less than 2 weeks
-11°C (12°F).....	less than 24 hours
Both thermophilic composting and freezing weather will kill hookworms and eggs.		

spread by defecating on the soil. Both the high temperatures of composting will kill the eggs and larvae, as will the freezing temperatures of winter. Drying is also destructive²⁰

Whipworm

Whipworms (*Trichuris trichiura*) are usually found in humans, but also may be found in monkeys or hogs. They're usually under two inches long and the female can produce 3,000 to 10,000 eggs per day. Larval development occurs outside the host, and in a favorable environment (warm, moist, shaded soil) first stage larvae are produced from eggs in 3 weeks.

Hundreds of millions of people worldwide, as much as 80% of the population in certain tropical countries, are infected by whipworms. In the U.S., whipworm is found in the south where there is heavy rainfall, a subtropical climate, and soil polluted with feces. The lifespan of the worm is usually considered to be 4 to 6 years.

Infection results from ingestion of the eggs, which can contaminate the hands of persons handling soil that has been defecated on by an infected person. Light infections may not show any symptoms. Heavy infections can result in anemia, and death. A stool examination will determine if there is an infection.

Cold winter temperatures of -8°C to -12°C (17.6°F to 10.4°F) are fatal to the eggs, as are the high temperatures of thermophilic composting.²¹

Roundworms

The roundworms (*Ascaris lumbricoides*) are fairly large worms (10 inches) which parasitize the human host by eating semi-digested food in the small intestine. The females can lay 200,000 eggs per day for a lifetime total of 26 million or so. The larvae develop from the eggs *in soil* under favorable conditions (21°C to 30°C or 69.8°F to 86°F). Above 37°C (98.6°F) they cannot fully develop.

Approximately 900 million people are infected with roundworms worldwide, one million of them in the U.S. The eggs are usually transmitted hand to mouth by people, usually children, who have come into contact with the eggs in his/her environment. Infected persons usually complain of a vague abdominal pain. Diagnosis is by stool analysis.²²

The eggs are destroyed by direct sunlight within 15 hours, and are killed by temperatures above 40°C (104°F), dying within an hour at 50°C (122°F). Roundworm eggs are resistant to freezing temperatures, chemical disinfectants, and other strong chemicals. Thermophilic composting will kill them.

Roundworms, like hookworms and whipworms, are spread by fecal contamination of soil. Much of this contamination is caused and spread by children who defecate outdoors within their living area. One sure way to eradicate fecal pathogens is to conscientiously collect and thermophilically compost *all* fecal material. Therefore, it is very important when composting humanure to be certain that *all* children use the toilet facility and do not defecate elsewhere. When changing soiled diapers, scrape the fecal material into the humanure receptacle with toilet paper or another biodegradable material. It's up to adults to keep an eye on kids and make sure they understand the importance of *always using a toilet facility*.

Fecal environmental contamination can also be caused by using raw fecal material for agricultural purposes. *Proper thermophilic composting of all fecal material is essential for the eradication of fecal pathogens.*

SUMMARY OF CONDITIONS NEEDED TO KILL PATHOGENS

There are two primary factors leading to the death of pathogens in humanure. The first is *temperature*. A compost pile that is properly managed in order to cultivate thermophilic organisms will destroy pathogens with the heat it generates.

The second factor is *time*. The lower the temperature of the compost, the longer the retention time needed for the destruction of pathogens. That period may be long if the pile doesn't heat at all, such as in a mouldered pile, as roundworm eggs have been known to survive for years in soil, and some bacteria can survive for two years in sludge and over a year in soil. Feachem, however, states that three months retention time will kill all of the pathogens in a low-temperature composting toilet except worm eggs, although table 6.11 (also from Feachem) indicates that some additional pathogen survival may occur.

A high-temperature thermophilic compost pile will destroy pathogens, including worm eggs, quickly, possibly in a matter of minutes. Lower temperatures require longer periods of time, possibly hours, days, weeks or months, to effectively destroy pathogens. One need not strive for extremely high temperatures (say 150°F or 65°C) in a compost pile to feel confident about the destruction of pathogens. Instead, it may be more realistic for one to strive to maintain lower temperatures in a compost pile for longer periods of time (say 120°F or 50°C for twenty four hours, or 115°F or 46°C for a week). For example, as one source puts it, "*All fecal microorganisms, including enteric viruses and roundworm eggs, will die if the temperature exceeds 46°C (114.80° F) for one week.*"¹⁵

A sound approach to pathogen destruction when composting humanure is to

thermophilically compost the organic refuse, then allow the compost to sit, undisturbed, for a lengthy period of time after the thermophilic heating stage has ended. The subject of thermophilic composting is discussed in greater detail in chapter seven.

In the words of Feachem (et. al.), *“The effectiveness of excreta treatment methods depends very much on their time-temperature characteristics. The effective processes are those that either make the excreta warm (55°C) [131°F], hold it for a long time (one year), or feature some effective combination of time and temperature.”*

In short, the combined factors of temperature and time will do the job of converting “turds into tomatoes” (The time/temperature factor of pathogen destruction is illustrated in figure 6F.)

CONCLUSIONS

Humanure is a valuable resource suitable for agricultural purposes and has been recycled for such purposes by large segments of the world’s human population for thousands of years.

However, humanure contains the potential for harboring human pathogens, including bacteria, viruses, protozoa and parasitic worms or their eggs, and thereby can contribute to the spread of disease. When pathogenic raw humanure is applied to soil, pathogenic bacteria may continue to survive in the soil for over a year, and roundworm eggs may survive for many years, thereby maintaining the possibility of human reinfection for lengthy periods of time.

However, when humanure is thermophilically composted, human pathogens are rapidly destroyed, and the humanure is thereby converted into a hygienically safe form suitable for soil applications for the purpose of human food production.

Finally, it must be added that thermophilic composting requires no electricity and therefore no coal combustion, no acid rain, no nuclear power plants, no nuclear waste, no petrochemicals, and no consumption of fossil fuels. The composting process produces no waste, no pollutants, and no toxic byproducts. Thermophilic composting of humanure can be carried out century after century, millennium after millennium, with no stress on our ecosystems, no consumption of resources, no garbage or sludge for our landfills. And all the while it will produce a valuable resource necessary for our survival while preventing the accumulation of dangerous and pathogenic waste. If that doesn’t describe *sustainability*, nothing does.

Figure 6 F (Source: Feachem et. al. 1980)

Safety Zone for Pathogen Death

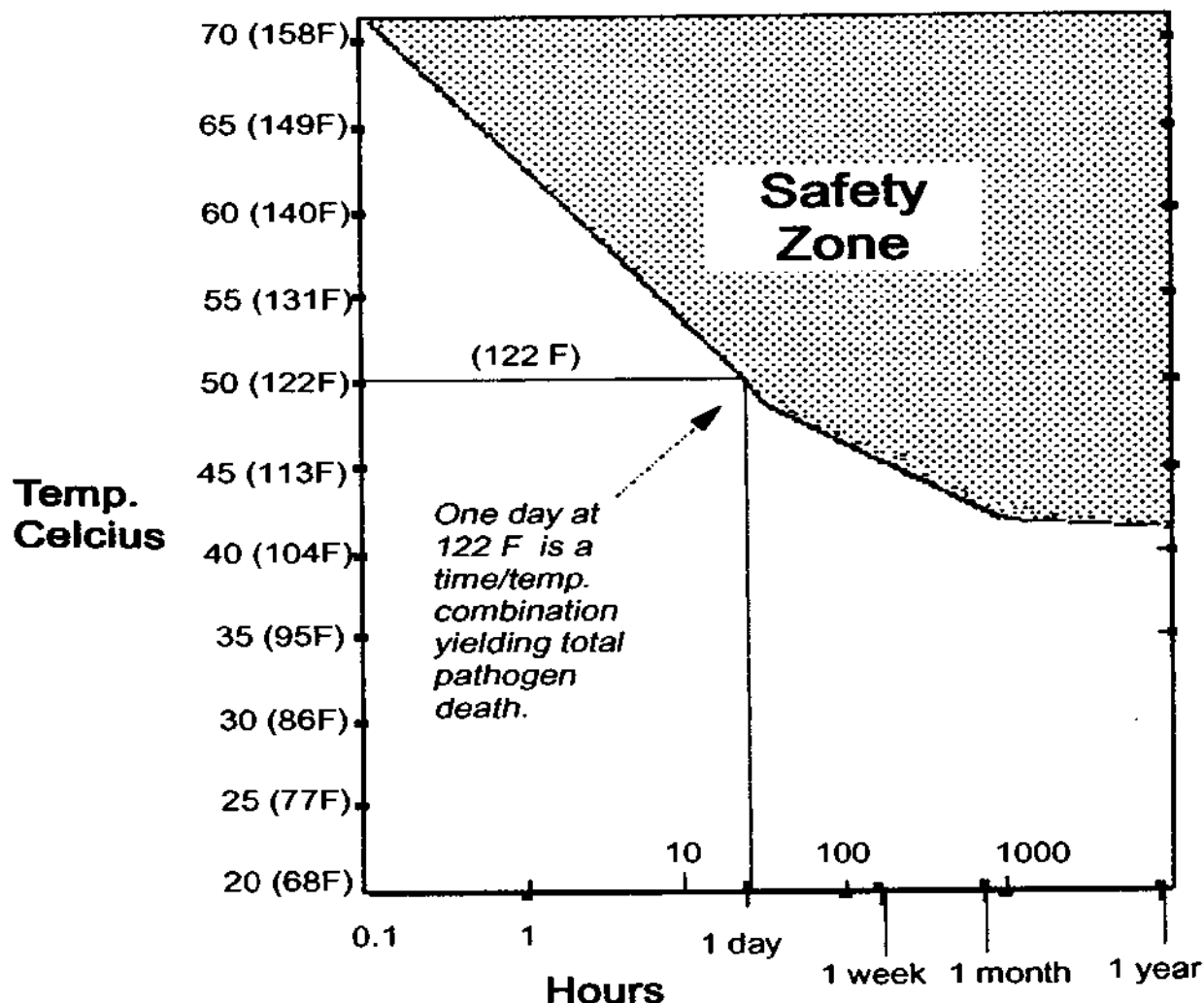

The above pathogen death boundaries include those for *enteric viruses, shigella, taenia, vibrio cholera, Ascaris (roundworm), salmonella, and entamoeba histolytica*. Source: Feachem, et. al., 1980.

Table 6.14- Parasitic Worm Egg Death

Eggs	Temp.(°C)	Time required to die
Schistosome	53.5	1 minute
Hookworm	55.0	1 minute
Roundworm	55.0	10 minutes
"	60.0	.5 seconds
"	0	4 years
"	-30	24 hours

[Source: *Compost, Fertilizer, and Biogas Production from Human and Farm Wastes in the People's Republic of China*, (1978), M. G. McGarry and J. Stainforth, editors, International Development Research Center, Ottawa, Canada. (page 43)]

REFERENCES - CHAPTER SIX

- 1 - Tompkins, P., and Boyd, C. (1989). Secrets of the Soil. Harper and Row: New York. (pp.94-5).
- 2 - Howard, Sir Albert. The Soil and Health: A Study of Organic Agriculture. Schocken: New York. 1947. (pp. 37-38).
- 3 - Ibid. (p.177).
- 4 - Feachem, et al. (1980). Appropriate Technology for Water Supply and Sanitation. The World Bank, Director of Information and Public Affairs, Washington D.C. 20433 (see listing #9).
- 5 - Jervis, N. "Waste Not, Want Not". *Natural History*. May, 1990 (p.73).
- 6 - Sopper, W.E. and Kardos, L.T. (Eds.). (1973). Recycling Treated Municipal Wastewater and Sludge Through Forest and Cropland. The Pennsylvania State University, University Park, PA (pp. 248-51).
- 7 - Ibid. (pp. 251-252).
- 8 - Cheng, Thomas C. (1973). General Parasitology. Academic Press, Inc., 111 Fifth Avenue, New York, NY 10003 (p. 645).
- 9 - Feachem, et. al. (1980). Appropriate Technology for Water Supply and Sanitation: Health Aspects of Excreta and Sullage Management. Energy, Water and Telecommunications Department of the World Bank, 1818 H Street N.W., Washington D.C. 20433.
- 10 - Ibid.
- 11 - Olson, O. W. (1974). Animal Parasites - Their Life Cycles and Ecology. University Park Press, Baltimore, MD (p. 451-452).
- 12 - Crook, James (1985). "Water Reuse in California". *Journal of the American Waterworks Association*. v77, no. 7. as seen in The Water Encyclopedia by van der Leeden et. al. (1990), Lewis Publishers, Chelsea, Mich. 48118.
- 13 - Boyd, R. F. and Hoerl, B. G. (1977). Basic Medical Microbiology. Little, Brown and Co., Boston Mass. (p. 494).
- 14 - Cheng, Thomas C. (1973) General Parasitology. Academic Press Inc., 111 Fifth Ave., New York, NY 10003. (p. 645).
- 15 - Franceys, R., et. al. (1992). A Guide to the Development of On-Site Sanitation. World Health Organization, Geneva (pit latrine info p. 212, quote on time/temperature factor, p. 214).
- 16 - Schoenfeld, M., and Bennett, M. (1992). Water Quality Analysis of Wolf Creek. (Unpublished manuscript). Slippery Rock University, Applied Ecology Course, PREE, Fall Semester. (Prof. P. Johnson), Slippery Rock, PA 16057
- 17 - Pomeranz, V.E. and Schultz, D., (1972). The Mother's and Father's Medical Encyclopedia. The New American Library, Inc., 1633 Broadway, New York, NY 10019. (p.627).
- 18- Chandler, A.C. and Read, C.P. (1961). Introduction to Parasitology. John Wiley and Sons, Inc.: New York.
- 19 - Brown, H.W. and Neva, F.A. (1983). Basic Clinical Parasitology. Appleton-Century-Crofts/Norwalk, Connecticut 06855. (pp.128-31).
- 20 - Ibid. (pp.119-126).
- 21 - Ibid. (page numbers uncertain).
- 22 - Ibid. (page numbers uncertain)

23 - Lewis, Ricki. (1992). *FDA Consumer*, September 1992 (p. 41).

24 - Crook, James. (1985). "Water Reuse in California". *Journal of the American Waterworks Association*, v.77, no.7. as seen in The Water Encyclopedia by van der Leeden et. al. (1990), Lewis Publishers, Chelsea, Michigan 48118.

*** A wide range of compost analyses and tests for pathogens and other contaminants such as pesticides and herbicides are available from Woods End Research Laboratory, Inc., Route 2, Old Rome Road, Box 1850, Mt. Vernon, ME 04352; Phone (207) 293-2457. In 1995, a helminth ova test cost \$145.00, and required a one gallon sample of compost.**

**WE DO IT EVERY DAY. BUT DO WE EVER
THINK ABOUT IT!**

I
DEFECATE,
THEREFORE I
AM . . .



THE TAO OF COMPOST

"Always bear this in mind, that very little indeed is necessary for living a happy life."

Marcus Aurelius

"Aspire to simple living? That means, aspire to fulfill the highest human destiny."

Charles Wagner



I will never forget the day I introduced my mother to my composting system. She came to visit me at my newly established homestead one spring day in 1980 and I gave her a tour of my garden, which was already quite vibrant. A fresh pile of finished compost had been dumped from a wheelbarrow onto one of the raised garden beds and, as we passed, I reached down and scooped up a big handful, thrusting it toward her. "Smell this," I said. So she put her nose right up to the black earth I held out before me and took a deep breath.

"Boy, that smells good!" she said, inhaling the rich, sweet-smelling aroma of fertile soil, and smiling.

"This is my alternative to a septic system!" I proudly informed her, still holding the compost out in front of me as I watched her smile suddenly freeze. I will always remember the look on her face when I caught her so completely by surprise in an unexpected, and perhaps awkward, situation. My dear mother, although very open-minded, had not, prior to that moment, had the experience of so intimately communing with composted humanure. But the compost did smell good, like a rich soil from the woods.

PRIMAL COMPOST

Try to imagine yourself in an extremely primitive setting, maybe sometime around 10,000 B.C. Imagine that you're just slightly more enlightened than your brutish companions and it dawns on you one day that your feces should be disposed of properly. Everyone else is defecating in the back of the cave, creating a smelly mess, and you don't like it. You're going to improve on the system.

Your first revelation is that *smelly refuse should be deposited in one place*, not spread around for everyone to smell or to step in, and it should be deposited away from one's living area somehow. You watch the wild cats and see that they each go to a special spot to defecate. But the cats are still one step ahead of the humans, as you soon find out, because they cover their excrement.

When you've shat outside the cave on the ground in the same place several times you see that you've still created a foul smelling, fly-infested mess. Your second revelation is that *the refuse you're depositing on the ground should be covered after each deposit*. So you scrape up some leaves every time you defecate and throw them over the feces. Or you pull some tall grass out of the ground and use it for cover.

Soon your companions are also defecating in the same spot and covering their fecal material as well. They were encouraged to follow your example when they noticed that you had conveniently located the defecation spot between two large rocks, and positioned logs across the rocks to provide a convenient perch, allowing for care-free defecation above the collecting refuse underneath.

A pile of dead leaves is now being kept beside the toilet area in order to make the job of covering it more convenient. As a result, the offensive odor of human feces and urine no longer foul the air. Instead, it's food scraps that attract flies and smell bad. This is when you have your third revelation: *food scraps should be deposited on the same spot and covered as well*. Every stinky bit of refuse you create is now going to the same spot and is being covered with a natural material to eliminate odor. This hasn't been hard to figure out, it makes good sense and it's easy to do.

You've succeeded in solving three problems at once: no more humanure scattered around your living area, no more garbage, and no more offensive odors assaulting your keen sense of smell and generally ruining your day. You also begin to realize that the illnesses that were prone to spread through the group have subsided, a fact that you don't understand, but you suspect may be due to the group's new found hygienic practices.

Quite by accident, you've succeeded in doing one very revolutionary thing: *you've created a compost pile*. You begin to wonder what's going on when the pile gets so hot it's letting off steam. What you don't know is that you've done exactly what nature intended you to do by piling all your organic refuse together, layered with natural, biodegradable cover materials. In fact, nature has "seeded" your excrement with a breed of microscopic animal that proliferates in and digests the pile you've created, and, in the process, heats the compost to such an extent that any disease-causing pathogens resident in the humanure are destroyed. The invisible microscopic animals, otherwise known as thermophilic bacteria, would not multiply rapidly in the discarded refuse unless you created the pile, and thereby the conditions,

which favor their rapid proliferation. By daring to be different, you stumbled upon a miracle of nature.

Finally, you have one more revelation, a big one. You see that the pile, after it gets old, sprouts all kind of vibrant plant growth. You put two and two together and realize that *the stinking refuse you carefully disposed of has been transformed into rich earth, and ultimately into food*. Thanks to you, humankind has just climbed another step up the ladder of evolution.

Yet there is one basic problem with this scenario: *it didn't take place 12,000 years ago. It's taking place now.*

THE EVOLUTION OF COMPOST

The hypothetical discovery of compost in a primal situation would be most likely to occur in a group of humans who had settled into an agricultural lifestyle rather than a nomadic, hunter-gatherer one. Nomadic people can walk away from the trash they leave behind, allowing nature to deal with it. Settled peoples don't have that luxury. The development of rooted human settlements and the development of agriculture go hand in hand, for it is the working of the land to grow food crops that forces a people to stay put year after year. Unless, of course, they deplete the soil of nutrients and are then forced to move on to find a new patch of fertile ground.

More enlightened peoples will develop an understanding of the human nutrient cycle instinctively, and will strive to maintain that cycle intact on a day-to-day basis as if it were a natural and necessary part of their lives, as natural and necessary as growing or cooking their food, or bathing, or nursing their children. For settled, agricultural peoples, there is an abundance of organic refuse materials needing to be recycled on a regular or daily basis, these materials may include potato peels, apple cores, crop residues, humanure, garden refuse and on and on. In most cases, those organic materials would be recycled without question, day in and day out, year in and year out, not as a chore or a burden, but as a necessary responsibility for human life on the planet Earth. Such is the Tao of compost, the balanced way, the natural way, not the glamorous way, not the exciting way, not the get-rich-quick way of contemporary pop culture. The Tao is the endless way.

Although such recycling has apparently been a common practice in the East for thousands of years, it is a relatively unknown phenomenon in the West. In fact, compost itself is a relatively new phenomenon in the West and perhaps even in the East, a phenomenon that never gained recognition throughout the ages in Europe, despite its potentially valuable utility. Perhaps people in Europe who developed an instinctive understanding of natural phenomenon were simply rounded up and burned

at the stake by religious fanatics. One can only speculate as to why the West has been so slow to catch on to humanure recycling, and in view of the religious extremism of the past ages in Europe, such speculation can be both gruesome and saddening.

Much of compost's current popularity in the West can be attributed to the work of Sir Albert Howard, who wrote An Agricultural Testament (1943) and several other works on aspects of what has become known as *organic* agriculture. Sir Howard's discussions of composting techniques focus on the Indore process of composting, a process developed in Indore, India between the years of 1924 and 1931. The Indore process was first described in detail in Sir Howard's work (co-authored with Y. D. Wad), The Waste Products of Agriculture, in 1931.

The two main principles underlying the Indore composting process include 1) mixing animal and vegetable refuse with a neutralizing base, such as agricultural lime, and 2) managing the compost pile by physically turning it. These Indore process composting techniques subsequently became adopted and espoused by composting enthusiasts in the West, and today one still commonly sees people turning and liming compost piles. For example, Robert Rodale wrote in the February, 1972 issue of *Organic Gardening* concerning composting humanure, "*We recommend turning the pile at least three times in the first few months, and then once every three months thereafter for a year.*"

However, as composting becomes more deeply looked into over the years by us Westerners, new information is bound to be brought forth that challenges the conventional wisdom. For years I also believed that compost should be turned, and perhaps limed or treated with rock dusts. Yet, after monitoring my own compost, I've come to understand differently. Now, due to my own experiences, I contend that compost piles need not be limed, and need not be turned at all. Turning is unnecessary unless one is perhaps trying to accelerate the composting process, trying to compost piles of refuse that are exceedingly large, or trying to stir the outer areas of a batch of compost into the center in order to subject all parts of the batch to the high inner temperatures. I discussed the liming issue in chapter 2 of this book, and I'll discuss the turning (aerating and mixing) issue later in this chapter. I realize now that compost-making is really simpler than I could have imagined, and the arduous task of turning a compost pile may actually do more harm than good *if the pile is being continuously added to*. This is by no means an attempt by me to disparage the work of anyone, including Robert Rodale or Sir Albert Howard, who both very justifiably remain held in high regard by proponents of organic gardening and farming.

The Tao of compost, however, requires that *compost-making be an integral part of normal and daily life*. Such compost-making is a natural and *bio*regional phenomenon. Organic refuse from a given population and geographic area is layered

together for the purpose of cultivating the microscopic organisms that convert the refuse into humus. As there are thousands of geographic areas on the earth each with its own unique human population, climatic conditions and available organic refuse materials, there will also be potentially thousands of composting methods and styles. What works in one place on the planet for one group of people may not work at all for another group in another geographic location. Where one group uses above-ground, continuous compost bins such as described in this book, another group will use below-ground pits sealed with clay. Where one group chooses to compost aerobically, as described in this book, another may choose to compost anaerobically such as in a sealed pit. Where a group only uses natural, organic materials in their compost, another may add chemical fertilizers or rock dusts. Where one group may compost each family's refuse separately, another group may compost the refuse of many people all together.

It is not my intention to unfairly promote certain methods of composting as superior over others. My intention is to describe my own experiences in the hope that others may benefit from such descriptions. I would hope that others with different experiences would also make their information available for the benefit of the general public. If I must insist upon anything, I would insist that the compost-maker be clear in understanding why s/he is making compost. If compost is being made in order to eliminate waste and pollution as well as recover resources, as it should be, then the compost-maker will strive to utilize local refuse resources in a wise and efficient manner. The availability of local, organic refuse materials in combination with local climatic conditions, and cultural predispositions toward the recycling of humanure, will determine the methods of composting for a given location, or bioregion.

When composting humanure, the additional factor of pathogen destruction must be taken into account and incorporated into the composting formula. The destruction of human pathogens occurs most readily under the conditions of aerobic, thermophilic composting, because of the heat generated by the process. This is the sort of composting in which I engage and which this book primarily entails. In short, humanure composting requires 1) a knowledge of accessible local refuse materials suitable for composting, 2) a sensitivity to and understanding of seasonal fluctuations in weather conditions, and 3) a willingness to combine the refuse materials in a manner that suits the climate and still promotes the growth of aerobic, thermophilic bacteria.

I would add to this formula one more thing: the technique one finally settles on for composting humanure should be sustainable. It should not be creating waste or pollution or squandering resources.

Bearing all this in mind, perhaps Sir Albert Howard's Indore process of com-

posting was the most appropriate for his purposes, in Indore, India in the 1920's. But that's no reason for anyone else to believe that the compost they are producing in their area of the world for their own purposes should utilize the same techniques that the Indore process calls for. This is especially important to understand when one realizes that if all compost required both liming and turning, many people would be unable to make compost. Agricultural lime is not available to everyone, everywhere, and turning compost can be quite an arduous task, especially for the frail or elderly. Whereas, *all people, everywhere, should be able to make compost.*

Additionally, people who recommend the frequent turning of humanure compost are people who have never engaged in humanure composting as a way of life. We simple humans of meager material resources who insist on recycling our daily refuse are aware of this one important fact: we produce organic refuse *continuously*, and therefore we must engage in *continuous composting*, which involves the continuous addition of organic refuse to a compost pile. Such a continuous compost pile requires the slow and constant upward movement of thermophilic organisms in the pile, which digest incoming refuse deposited on the pile above them, and abandon digested refuse below them. Such a pile of compost is always growing on top and always shrinking on the bottom, and does not need to be turned for aeration. In fact, such turning could be extremely disruptive.

This is in contrast to *experimental* composting, whereby large amounts of refuse are suddenly made available for the purpose of experimentation. Such experiments have a purpose and value all their own, but they may not reflect real situations in real life in the real world. When a person is suddenly faced with a large mass of raw organic material to be composted, perhaps turning the pile is a useful management technique. Certainly if the refuse is piled out in the open, the outer surfaces of the pile may remain unacceptably cool and will need to be turned into the center periodically. This can possibly be remedied by keeping the refuse in bins that hold in the heat, and covering the piles with insulating organic materials such as straw.

In other words, there is a big difference between the Tao of compost, which is composting *as a way of life*, and composting done for agricultural or academic experimentation. And although from an evolutionary standpoint we are slowly advancing our understanding of compost in the West, we are still back in the cave when it comes to incorporating composting into our daily lives.

In any case, I contend that not much has changed since ten thousand B.C. in the eyes of the compost pile. The thermophilic microorganisms that convert humanure into humus don't care what techniques we use today anymore than they cared what techniques were used eons ago, *so long as their needs are met.* And those needs haven't changed in human memory, nor are likely to change as long as humans roam

the earth. Those needs include: 1) *temperature* (compost microorganisms won't work if frozen); 2) *moisture* (they won't work if too dry or too wet); 3) *oxygen* (they won't work without it; and 4) *a balanced diet* (otherwise known as balanced carbon/nitrogen). In this sense, compost microorganisms are a lot like people, and, with a little imagination, we can think of compost microorganisms as a working army of microscopic people who need the right food, water, air and warmth.

The art of compost-making then, remains the simple and yet profound art of providing for the needs of these invisible workers so that they work as vigorously as possible, season after season. And although those needs may be the same worldwide, the techniques used to arrive at them may differ from time to time and from place to place.

THERMOPHILIC MICROORGANISMS

Converting humanure back into soil requires microorganisms that produce and thrive at high temperatures - high enough to kill the human pathogens that may be found in the excrement. The beneficial microorganisms are primarily thermophilic (heat-loving) microscopic bacteria, and they're extremely valuable to humanity. They ask for very little and they give a lot in return, and, for the most part, we ignore them. However, people interested in composting humanure need to know something about the little buggers and how to keep them happily working.

Bacteria are usually divided into three classes based upon the temperatures in which they grow best. The low temperature bacteria are the *psychrophiles*, which can grow at temperatures down to -10°C , but whose optimum temperature is above 20°C (68°F). The *mesophiles* live at medium temperatures, 20°C - 37°C (68°F - 98.6°F).

ESSENTIAL READING FOR INSOMNIACS



*A number of thermophilic microorganisms may be found in the composting process including bacteria: *Bacillus stearothermophilus*, and *Clostridium thermocellum*; fungi: *Geotrichum candidum*, *Aspergillus fumigatus*, *Mucor pusillus*, *Chaetomium thermophile*, *Thermoascus auranticus*, *Torula thermophila*, and *Humicola insolens*; and actinomycetes (a cross between a bacterium and an imperfect fungus): *Thermoactinomyces*, *Actinomyces thermophilis*, *Talaromyces (Penicillium) duponfi*, and *Thermomonospora*.³*

Thermophiles thrive above 40°C (104°F), and the optimum temperature for some thermophilic strains may be as high as 65°C (149°F) or higher. These bacteria occur naturally in hot springs, tropical soils and compost heaps, to name a few places. Some thermophilic bacteria have been found at temperatures as high as 89°C (192°F), and perhaps higher.

Thermophiles are responsible for the spontaneous heating of hay stacks which can cause them to burst into flame. When growing on bread, they can raise the temperature of the bread to 74°C (165°F). Heat from bacteria also warms germinating seeds, as sterile seeds are found to remain cool while germinating.¹

Thermophilic bacteria were first isolated in 1879 by Miquel, who found bacteria capable of developing at 72°C (162°F). He found these bacteria in soil, dust, *excrement*, sewage and river mud. It wasn't long afterward that a variety of thermophilic bacteria were discovered in soil - bacteria that readily thrived at high temperatures, but not at room temperature. These bacteria are said to be found in the sands of the Sahara Desert, but not in the soil of cool forests. Composted or manured garden soils may contain 1-10 percent thermophilic types of bacteria, while field soils may have only 0.25% or less. Uncultivated soils may be entirely free of thermophilic bacteria.²

The presence of thermophilic bacteria in garden soil to which compost has been added indicates that the use of garden weeds in one's compost pile, including soil clinging to roots, may help keep the pile inoculated with the necessary bacterial strains. However, it seems more likely that the bulk of the thermophilic bacteria enter the compost pile from the humanure itself. In which case, it would seem that mother nature has provided for the human race a built-in solution to the problem of getting rid of human excrement. The thermophilic bacteria are already in it; we just have to provide the conditions they need to do their thing, which is heating and digesting the manure sufficiently to render it hygienically safe. Nature provides us with seeds to grow our food too, but those seeds won't grow unless we create the right conditions for them. We've already figured *that* out.

Humanure is said to contain 100 *billion* bacteria per gram (there are 28.34 grams in an ounce).⁴ This means that *one gram of humanure contains a bacterial population twenty times greater than the entire human population of the earth*, which seems unbelievable. If the average excrement weighs about 40 ounces, then each stool could contain 113 *trillion* bacteria, a figure totally beyond human comprehension.

When a pile of organic refuse begins to undergo the composting process, the mesophilic bacteria proliferate, raising the temperature of the composting mass up to 44°C (111°F). These mesophilic bacteria can include *E. Coli* and other bacteria from

the human intestinal tract, but these soon become increasingly inhibited by the temperature as the thermophilic bacteria take over in the transition range of 44°C-52°C (111°F-125.6°F). Thermophilic growth can then continue up to about 70°C (158°F).⁵ These bacteria combine organic carbon with oxygen to produce carbon dioxide as well as to release energy. Some of the energy is used by the microorganisms to proliferate, the rest is given off as heat.

The heat produced by thermophilic bacteria kills the pathogenic microorganisms, viruses, bacteria, protozoa, worms and eggs that may inhabit humanure. A temperature of 122° F (approx. 50°C), if maintained for twenty-four hours, is sufficient to kill all of the pathogens. A lower temperature will take longer to kill pathogens (a temperature of 115°F may take nearly a week to kill pathogens completely), a higher temperature may only take minutes. For example, when Westerberg and Wiley composted sewage sludge which had been inoculated with polio virus, salmonella, roundworm eggs, and *Candida albicans*, they found that a temperature of 116°F to 130°F (46.66°C to 54.44°C) maintained for three days killed all of these pathogens (see *Applied Microbiology*, December 1969). This sort of phenomenon has been confirmed by many other researchers, not the least of which being Gotaas, who indicates that few organisms are able to survive temperatures of 120°F (48.88°C) for more than one hour. However, for safety's sake, a period of twenty-four hours at 122°F is generally recommended for the assurance of total pathogen destruction. Therefore, the first goal in composting humanure should be to create a compost pile that will heat sufficiently to kill all potential human pathogens that may be found in the manure (see figure 6F and table 6.14 on page 133, and table 6.11 on page 127).

It should be understood though, that *the heating process carried out by thermophilic bacteria occurs only in the initial stage of organic decomposition*. The heating stage takes place rather quickly and may only last a few days, weeks or months. The thorough decomposition of organic material, or the conversion of organic refuse into humus may take a year or two. After the initial thermophilic heating period, the humanure will appear to have been digested, but the coarser organic material will not. The fungi and macroorganisms that break the coarser elements down into humus wait for the heat to die down before they move in. Then they take their good old time, and I say "more power to them!" I only plant a garden once a year, so I only need compost once a year. No need to hurry the process.

FOUR NECESSITIES FOR GOOD COMPOST

1. Moisture

In order for the composting process to work properly, several conditions must be met. The first is proper moisture content. A correct moisture content is 50-60%. The pile should be quite moist, but not wet or water logged. How does one determine the moisture content of the compost? How does one regulate the moisture content? First, don't worry. Second, if the pile is getting too much moisture (not likely in an open topped pile with an earth bottom), add more dry materials such as hay, straw, weeds, leaves etc. These things soak up excess moisture.

In extreme cases, a roof over your compost pile may be needed to keep the rain out, or to keep the sun from drying the pile. You may want a roof over your pile so you can collect rain water to use for cleaning composting containers and utensils, then you can use the cleaning water to help keep your pile damp. In any case, the more you work with your compost, the easier you'll find the process to be.

I don't water my compost except to empty cleaning water on it after cleaning the toilet container, and I don't cover it to keep the rain out. Average annual rainfall where I live is about 35 inches per year. There is no apparent leaching from the compost pile into the surrounding environment, and no visible surrounding environmental deterioration whatsoever resulting from my humanure compost bin which has been situated in the same place for fifteen years. I do, however, have my compost bin under tree cover so it has protection from the pouring rain, and I keep the top of the pile flat to minimize water runoff. When monitoring the temperature of my compost pile during a period of drought, I found that the temperature rose dramatically after a heavy rain. This has led me to believe that rain water is good for compost, and provides a source of essential moisture. Compost tends to soak up rain water like a sponge, especially if the pile has a flat top.

On the other hand, much of the moisture in our compost pile comes from human urine. Urine not only provides needed moisture, but it also provides needed nutrients such as nitrogen, and it expedites the decomposition of the sawdust or other organic cover material used in the toilet. If one wants to use a cover material in one's toilet to eliminate odors (and one should), then one needs urine in the toilet to provide the extra moisture and nitrogen to balance the dry carbonaceous cover material so that it'll all compost together thermophilically. If one wants to compost urine as well as feces, then one will have to add a significant amount of relatively dry carbonaceous material to soak up the urine and balance its nitrogen. Cover materials and urine go hand in hand. You shouldn't have one without the other in a composting toi-

let system.

The segregation of urine from feces in composting systems has been promoted far and wide. I strongly disagree with this practice when applied to thermophilic composting systems, as the alternative of using a carbonaceous cover material is much more simple, pleasant and beneficial. People who segregate urine from feces claim that the urine creates foul odors and waterlogs the compost. However, it is a lack of cover material that allows for the creation of foul odors and waterlogging, not the existence of excess urine. Collecting urine (and feces) in a receptacle filled with sawdust or other organic and fairly dry material before depositing it on the compost pile will ensure that adequate carbonaceous material is added to the pile to balance the nitrogenous urine. The covering of such deposits again, *after application to a compost pile*, with additional organic cover materials such as grass or weeds will ensure an odor free system. This will be discussed in greater detail later in this chapter.

2. Oxygen

The second necessity for a good compost pile is oxygen. Thermophilic bacteria are aerobic bacteria, they need oxygen. One way to oxygenate your pile is by turning it, chopping it, running pipes through it with little holes in them, moving it on augers, blending, agitating, sweating, digging, etc. The belief that one must turn one's compost pile surely is the leading reason why many people don't have them. Especially little old ladies.

I also believed that turning was an essential step in the aeration of a pile and therefore essential in making good compost, and I turned my pile once a year for over a decade. It wasn't until I conducted the more detailed research for this publication when I discovered that turning the pile was not assisting the process of thermophilic decomposition. In fact, after I turned my pile, the bacterial activity slowed way down instead of speeding up as it was supposed to. The microorganisms continued to work, but not as earnestly, and the temperature of the compost dropped significantly (about 30°F) immediately after the pile was turned, then petered out altogether.

The reason this happened was a revelation to me at the time: The thermophilic bacteria in my compost were happily multiplying in the fresher, upper layers of the pile, which contained the proper conditions for vigorous microbial proliferation, namely fresh food, and that layer was around 120°F or 50°C. The lower, older layers of the pile had already been digested by the thermophilic bacteria and were "spent", or cool. When I turned the pile, I diluted the fresh, hot, upper half of the pile with the

spent lower half and left the thermophilic bacteria without enough food. Or, in other words, I disrupted their carbon/nitrogen balance. They had plenty of oxygen, but that wasn't good enough. So they quickly cooled down. Now I realize that if a compost pile is arriving at temperatures adequate for the destruction of human pathogens, the microorganisms are enjoying the proper conditions and should be left alone. Turning the pile after it has cooled down will reintroduce oxygen, but it won't refresh the food supply, so why bother? Now I don't turn my compost at all, and the process of compost-making has become that much more enjoyable.

It seems that the act of turning and artificially aerating compost piles is advocated for the purpose of accelerating the compost-making process so that it takes less time. There are many examples in the available literature showing compost piles finished and removed for agricultural application in a few weeks. This may be appropriate for the composting of large quantities of municipal refuse or something of that sort, but for individual families who produce compost for gardening purposes, such compost acceleration will provide little advantage. Furthermore, such tales of fast, hot, compost apply to situations where a sufficient quantity of organic refuse becomes immediately available for piling, turning, and composting. The reality for individual families is that compostable refuse is produced daily in small quantities, day after day, year after year, forever. Therefore, a sudden large heap of compost (a batch) cannot be readily created, and an alternative approach must be used. That approach requires the use of a continuous composting system (as mentioned earlier, but worthy of repeating), in which refuse is continuously added to a pile, and the thermophilic layer continually rises in the pile to digest the incoming refuse. This sort of system is not aided by manually turning the pile. Instead, the pile is aerated by providing it with a blend of ingredients which trap air space in the pile. For those of you who aren't in a hurry, turning or aerating compost manually will not be necessary. I produce compost to use in my food garden, which I plant annually. Therefore, I only need finished compost on an annual basis. An annual cycle works well in a temperate climate such as the one I live in, although shorter cycles may be useful in tropical climates with year-round growing seasons.

In many cases, batch composting piles (not continuous composting piles) are turned in order to insure that all parts of the pile are subjected to the high internal temperatures, thereby ensuring total pathogen destruction. However, small-scale composting by individual families, if done in wooden bins where the compost is kept covered by an insulating layer of organic refuse (such as straw), may be sufficient to retain the necessary temperatures throughout the pile, without turning.

Another reason why compost piles are manually turned or aerated is because they are just too big, and the inside of the pile is smothered. This can be remedied by

not making big compost piles. A workable bin size is 5'w x 5'd x 4'h (1.5m x 1.5m x 1.2m), or smaller. There are easy ways to oxygenate a pile this size sufficiently to allow for proper thermophilic decomposition to occur. The easiest way to get oxygen into your pile is by using coarse cover materials such as hay, straw, grasses, or weeds (a main crop in my garden) to cover over odorous compost deposits. These coarse materials trap air spaces in the pile, as well as trap odors. A pile constructed with layered materials including coarse cover materials would have to be under water to be starved of oxygen.

Finally, there is an abundance of evidence that the more compost piles are turned, the greater they suffer from a loss of nutrients, particularly nitrogen and organic matter. Unturned compost retains the highest nutrient value. It also costs much less to produce, as the need for equipment or labor is kept to a minimum.

3. A Balanced Diet

A good carbon-nitrogen balance (a good blend of materials) is required for a nice, hot compost pile (see page 38 to refresh your memory on the topic of carbon and nitrogen). Since most of the materials commonly added to a compost pile are very high in carbon, this means that a source of nitrogen must be incorporated into the blend of composting ingredients. This isn't as difficult as it may seem. You can carry bundles of weeds to your compost pile, add hay, straw, leaves and garbage, but you'll still need one thing: nitrogen. Of course the solution is simple - add manure. Where can you get manure? From an animal. Where can you find an animal? Look in a mirror.

And be sure to keep that kitchen garbage going into the compost. Variety is the spice of life, even for a microscopic critter.

4. Temperature

Compost ceases to be active when frozen, and may slow down considerably when the ambient air temperature is consistently below freezing. However, frozen compost can resume vigorous activity after thawing, providing that it has adequate moisture, oxygen and a balanced diet (see Figure 7.6 on page 164, and appendix 4 on page 187).

DOING IT

OK. You should know by now that anyone can compost humanure at little if any cost in money or resources. You know that, if done properly, the manure will be

rendered hygienically safe, no matter what pathogens were in it before composting. The next question is, *“How can I do it, considering our cultural predisposition against the idea, and my own personal circumstances?”* My guess is that if you’re living in downtown Pittsburgh, you won’t be composting humanure in the near future. On the other hand, if done properly, you could probably compost humanure almost anywhere else without causing a problem. Let me fill you in on my own experiences, and on some possibilities for adapting my experiences to different situations. Maybe this will give you some ideas.

In 1974, after graduating from a university, I set out to learn a thing or two. I soon learned that diet and lifestyle are keys to good health. I decided to experiment a little and eventually put money down on land for the purpose of establishing a homestead and growing my own food. My intentions were to proceed in a manner that was gentle on the Earth, so to speak, while maximizing my own self-reliance and independence.

I traded a wood-burning cookstove for a canvas tipi and set the tipi up on my newly acquired wooded land. I soon had an area cleared for a garden. The first obstacle I ran into was a lack of soil fertility. How was the soil to be built up? Obviously, I had to replace what I took from the land when I gardened. It occurred to me that I had to complete the human nutrient cycle by returning my manure to the soil in the form of compost. It was either that or truck in manure from nearby farms year after year, while my own manure collected underground in a septic tank as toxic waste, thereby threatening the quality of my spring water. So I started composting in a serious way.

I varied my techniques and methods of composting until I hit upon what seemed to work best for me, having now composted in the same bin since 1979. The system I use requires no electricity, running water or technology (although a little technology, such as a truck to haul sawdust, or a sawmill to create it, is useful). And it’s not very labor intensive. Most of the work involves regularly emptying organic materials into the compost bin (my sawdust toilet is usually used by four people and is usually emptied every three or four days), and occasionally (annually) removing finished compost from the bin. What’s important is that the system works well.

During the development of my composting experiences, I knew at least a dozen families who lived in my surrounding area and were also composting humanure. Today, half of them have converted to flush toilets and conventional septic systems. This is an indication of the obvious: that composting is not for everyone, even the well-intentioned. However, none of the families I knew had done their homework and understood the importance of thermophilic composting or its ability to destroy the pathogens in humanure. Perhaps they weren’t sure they were doing the right

thing, and in fact many of them were mouldering their compost rather than thermophilically composting it. One family who composts humanure by a mouldering process uses it to fertilize trees in a field, having banned it from their garden, which, of course, is better than shitting in drinking water. Ironically though, it is a simple matter to convert a mouldering system into a thermophilic one, thereby rendering the compost fit for food production.

I now have a house built primarily of bioregional and recycled materials. The tipi ended up at a local state-owned environmental center where it was used to teach kids environmental ethics until a wind storm blew it to shreds. I lived “off the grid”, without mainstream electricity, for the first ten years, eventually incorporating photovoltaics (solar electricity) into my home, then mainstream electricity, conservatively consumed. I added the mainstream electricity when I realized I would never want to pay for a photovoltaic system big enough to even light my house, not only because of the prohibitively high cost, but also because of the toxic lead-acid batteries I would have had to buy and eventually discard in order to store the solar power. Besides, the kerosene lamps we had to use were causing indoor air pollution and creating a fire hazard. I also married a woman who owned a freezer, which not only required electricity, but which proved itself to be very useful in preserving food for the winter. The woman’s pretty nice too.

In short, ideals carved in stone are eventually molded by the constant rain of reality, which transforms them into a practical wisdom.

On the other hand, my composting system has changed little. I’ve upgraded it by moving the original “outhouse” indoors, where it works much better and does not

A Tip From Mr. Turdley



Sawdust works best in compost when it comes from logs, not kiln-dried lumber. Although kiln-dried sawdust (from a wood-working shop or retail lumber yard) will compost, it is a dehydrated material and will not decompose as quickly as sawdust from “green” logs, which is a byproduct of sawmills. Kiln-dried sawdust may also contain sawdust from pressure treated lumber, a dangerous addition to any compost pile. Sawdust from logs makes a better cover material in a sawdust toilet, as it prevents the escape of odor more effectively than the lighter, airier, kiln-dried material. Sawdust from logs is an inexpensive and plentiful local resource in forested areas, and can be found at local sawmills, usually free for the hauling. Sawdust should be stored outside where it will remain damp and continue to decompose, although during the winter special provisions must be made to ensure a supply of unfrozen sawdust. Some people will tell you that sawdust will make your soil or your compost acidic. That’s not true. A comprehensive study of sawdust done between 1949 and 1954 by the Connecticut Experiment Station showed no instance of it making the soil more acidic.⁶ This is verified by the author’s experience.

create an odor problem at all. In fact, the most common remark visitors offer concerning the toilet is "Gee, why doesn't it smell?" The system itself is still the same model of simplicity that I've been employing all along, if not more so. People ask me when I'm going to get a septic system. They take one look at the compost toilet and say things like "I respect the way you're living, but I could never do it." Well, I could install a septic system, as I have the running water and the electricity. However, in doing so I'd likely create environmental pollution and threaten the quality of my ground water, which I drink. That's what septic systems do. They're *waste disposal* systems. They collect and store waste, allowing the waste to slowly seep into the



A SIMPLE, COMPACT, INDOOR SAWDUST TOILET IN A NEWLY CONSTRUCTED HOME.

environment. I'd rather engage in resource recovery instead of waste disposal. My compost is my reward, and that's too valuable for me to be willing to sacrifice. It helps me to grow my food.

Finally, I don't understand humans. We line up and make a lot of noise about big environmental problems like incinerators, dumps, acid rain, and pollution. But we don't understand that when we add up all the tiny environmental problems each of us creates, we end up with those big environmental dilemmas. Humans are content to blame someone else, like government or corporations, for the messes we create, and yet we continue doing the same things ourselves day in and day out that have created the problems. Sure, corporations create pollution. If they do, don't buy their products. If you have to buy their products (gasoline for example), keep it to a minimum. Sure, municipal waste incinerators pollute the air. Stop throwing trash away. Minimize your production of waste. Recycle.

Buy food in bulk and avoid packaging waste. Simplify. Take a few months off work each year and don't spend money. Turn off your TV. Grow your own food. Plant a garden. Be part of the solution, not part of the problem. If you don't, who will?

THE SAWDUST TOILET

By now the reader should realize that the thermophilic composting of humanure will render it hygienically safe for garden use. However, thermophilic composting requires managing a compost pile by ensuring that the composting microorganisms have their basic needs of oxygen, food and moisture met. That management process simply entails heaping a mix of organic refuse in a constructed bin on bare soil, using some coarse (but not woody) material in the heap, and making sure the pile doesn't dry out. An additional important management practice involves occasionally raking the exposed outer edges of the compost pile onto the top of the pile to ensure that no material is escaping the thermophilic process.

In any case, when composting humanure one may ask, "*How does one get the humanure to the compost pile?*" There are two basic answers to that question. First, the compost pile may be situated under the toilet. I have never used such a toilet and therefore cannot discuss such a system with any authority. I don't see why this sort of collection system would not work as long as the compost pile is readily accessible and closely managed to ensure thermophilic decomposition and to prevent odor and waterlogging. Secondly, the humanure may be collected in one location, then moved to the compost pile in another location on a regular basis. This is the sort of system I am most familiar with, therefore, it is the system on which I focus my discussion.

Another TIP FROM MR. TURDLEY



THE SECRET

**to composting humanure is
to keep it covered.**

Always cover toilet deposits thoroughly with a clean, organic cover material such as rotting sawdust. When depositing humanure onto a compost pile always cover the deposit with another cover material, preferably a coarse one such as straw or weeds. Proper cover materials eliminate odors and flies, and balance the nitrogen in the humanure.

Figure 7.1

The Tao of the Sawdust Toilet

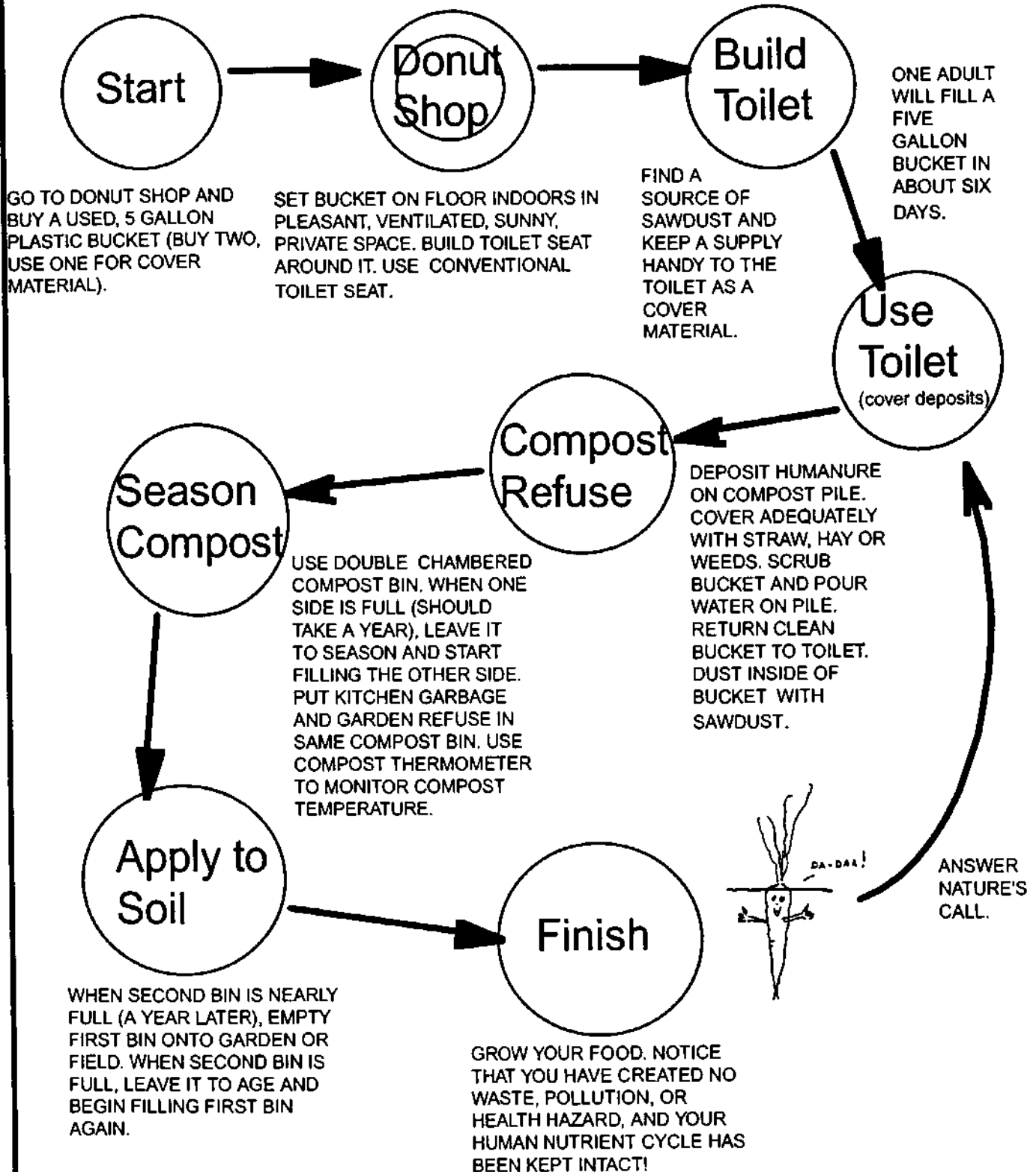
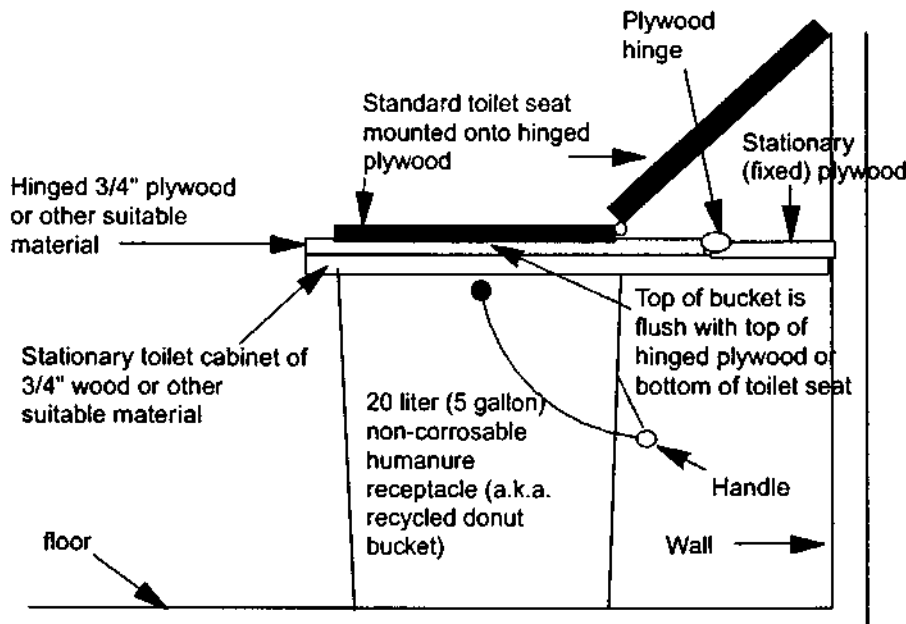

Figure 7.2

CUTAWAY VIEW OF SAWDUST TOILET HUMANURE RECEPTACLE



SAWDUST TOILET VITAL STATISTICS

100 pounds of human body weight will fill approx. 3 gallons (.4 cubic feet, or 693 cubic inches or approx. 11 liters) in a sawdust toilet *per week* - this volume includes the sawdust cover material. 100 pounds of human body weight will also require approximately 3 gallons of semi-dry, deciduous, rotting sawdust per week for use as a cover material in a toilet. This amounts to a requirement of approximately 20 cubic feet of sawdust cover material per 100 pounds of body weight per year for the proper functioning of a sawdust toilet. Human excrement tends to add weight rather than volume to a sawdust toilet as it is primarily liquid and fills the air spaces in the sawdust. Therefore, for every gallon of sawdust-covered excrement collected in a sawdust toilet, nearly a gallon of cover material will have been used.

Diagram of Simple Humanure Sawdust Toilet Arrangement

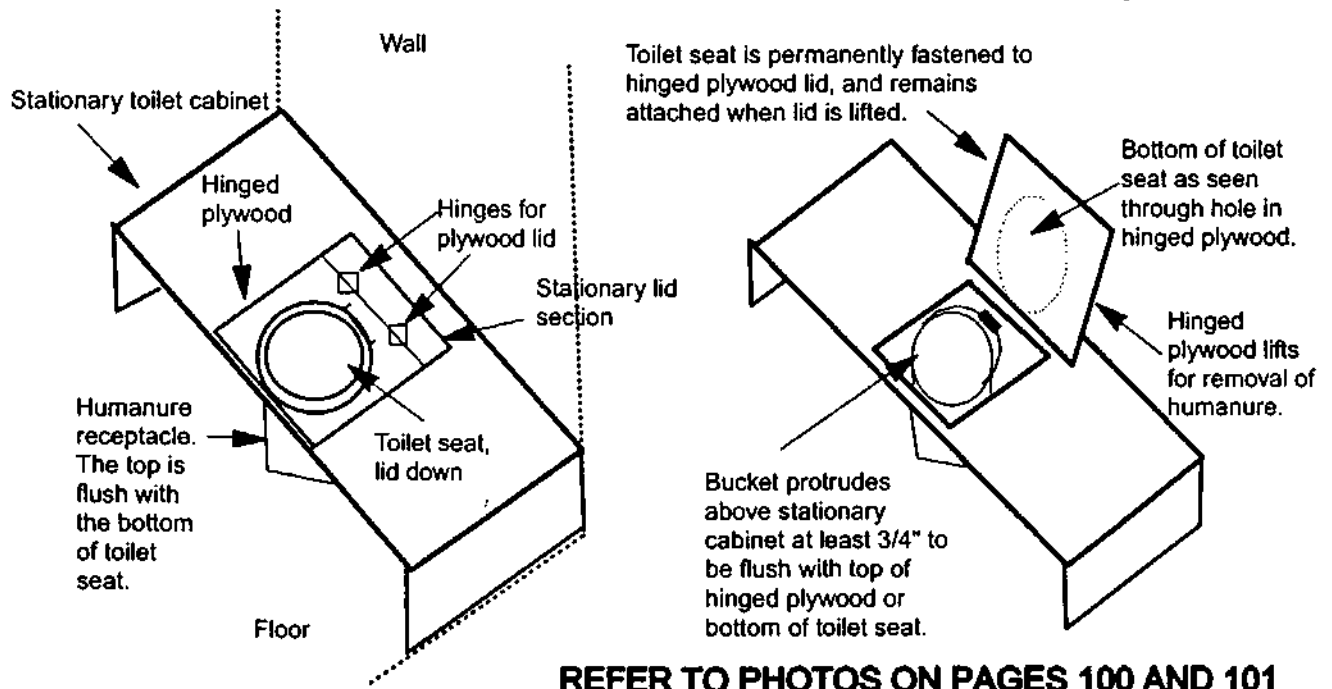

REFER TO PHOTOS ON PAGES 100 AND 101

A simple collection system whereby humanure is collected regularly, then moved to a compost pile has its advantages and disadvantages. The advantages include:

1) A very low cost is required to initiate such a system. The lower the cost of a system, the more universally available it is to humans on planet earth. A collection receptacle that is non-corrosable with a 20 liter or five gallon capacity is ideal. A larger capacity receptacle would be too heavy when full. Plastic, five-gallon food grade buckets with handles are available in the United States for a very small cost as discarded from donut shops and other food establishments. Such a receptacle will withstand many years of constant use with little or no degradation.

2) The toilet can (and should) be comfortably indoors, with no odor. In order to prevent odors, a cover material *must* be used in the collection receptacle. Sawdust from logs is ideally suited for this purpose, although other organic materials would also work. Not only does the cover material trap odor in the collection receptacle, but it also completely eliminates any fly or insect problems. If sawdust from logs is not available, the compost-maker will have to find an alternative that is available in his or her locality. The cover material should be natural, organic, clean and not wet, although it may be damp, and a slight dampness may actually be preferred for odor prevention purposes. Some people use peat moss. Other possibilities would include leaves (preferably dead or dried), ground corncobs or stalks, plain dirt, grain chaff,

Yet Another Tip from Mr. Turdley



PRESSURE TREATED LUMBER SHOULD NEVER BE USED FOR CONSTRUCTING COMPOST BINS, or for anything else. Pressure treated lumber is saturated with chromated copper arsenate. Both arsenic and chromium have been classified as human carcinogens (causing cancer) and are suspected mutagens (causing mutations). The poisons in pressure treated lumber will leach into your soil and into your compost, and may enter your food chain. You can't even safely burn pressure treated lumber to get rid of it - it produces highly toxic fumes and ash! When using sawdust in compost, don't use sawdust from a lumber yard as it may be made from pressure treated lumber! [See *Organic Gardening*, July/August, 1992. p. 8-10]

Figure 7.3

CONSTRUCTING A SIMPLE COMPOST BIN

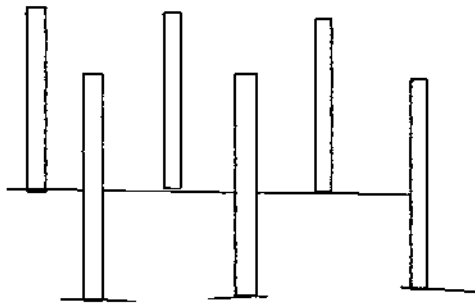

Set six posts into the ground. Use cedar, locust, redwood, or other wood resistant to rot. Do not use pressure treated lumber! Posts should be about five feet (1.5m) apart, about 40" (1m) out of the ground, and buried about two feet (.6m) deep.

(See photo, page 97.)

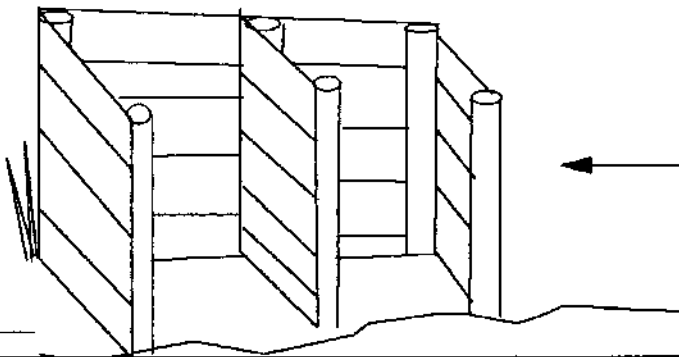

Close posts in so that two chambers are constructed, each about five feet square and 40" high. Recycled lumber without paint is ideal for this purpose. **Do not use pressure treated lumber.**

NOTE: A bin for only one or two people may need to have smaller chambers.

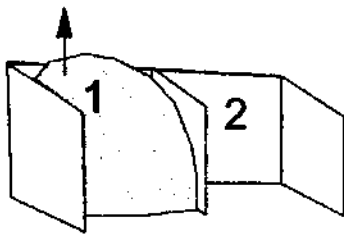

Fill one side to full (about a year), let it sit and age while the other side is filled. When filling the bin, layer the compost with weeds, hay, straw or similar coarse material.

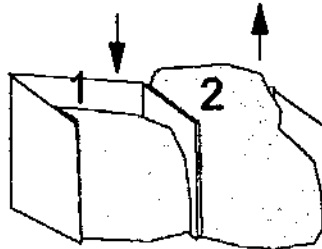

Fill second side. Notice that first side has shrunk considerably. When second side is nearly full, empty first side onto garden or field.

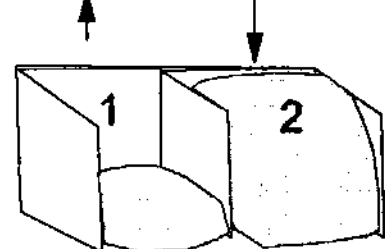

Begin filling first side again, as second side shrinks and ages. When side one is full, empty side two and start over.

THE CEASELESS CYCLE OF COMPOST MAKING

(Refer to page 159 for additional illustrations.)

possibly ground newsprint, perhaps even green leaves, etc. The cover material is an absolutely essential part of a thermophilic compost toilet - it not only eliminates odors and insects, but it also balances the nitrogen of the humanure by providing carbon, thereby setting the stage for the desired thermophilic decomposition.

3) No energy is required to operate such a system. No ventilation is necessary if the composting does not take place inside one's home. In which case, no fans or electricity are needed, and no running water is needed, although a small quantity of water is needed (a minimum of 2 quarts or 2 liters) to wash out the collection receptacle after emptying, which is also essential for maintaining an odor free system. The

soiled wash water can be dumped on the compost pile, or at the base of a fenced-off bush or shrub which is inaccessible to people, especially children. Or the water can be deposited into a standard septic system, or into a natural wetland wastewater treatment system.

4) The thermophilically composted organic refuse is transformed into a hygienically safe, valuable resource. The process eliminates sewage, fecal contamination of the environment, and the spread of disease by human pathogens resident in human excrement.

The disadvantages of a collection system requiring the regular removal of humanure to a compost pile are obvious. They include: 1) the inconvenience of carrying the organic refuse to the compost pile; 2) the inconvenience of keeping a supply of organic cover material available and handy to the toilet; 3) and the inconvenience of maintaining and managing the compost pile itself.

In researching the literature during the preparation of this book, I found it surprising that almost no mention is ever made of the thermophilic composting of humanure as a viable alternative to on-site sanitation. When “bucket” systems are mentioned, they are also called “cartage” systems, and are universally decried as being the least desirable sanitation alternative. For example, in A Guide to the Development of On-Site Sanitation by R. Franceys et. al., published by the World Health Organization in 1992, “bucket latrines” are described as *“malodorous, creating a fly nuisance, a danger to the health of those who collect or use the nightsoil, and the collection is environmentally and physically undesirable”*. This sentiment is echoed in Rybczynski’s (et. al.) World Bank funded work on low-cost sanitation options, where it is stated that *“the limitations of the bucket latrine*



A PEAT TOILET WITH A RECESSED CONTAINER HOLDING PEAT MOSS FOR USE AS A COVER MATERIAL.

include the frequent collection visits required to empty the small container of [humanure], as well as the difficulty of restricting the passage of flies and odors from the bucket.”

Now, I've personally used what could be called a bucket latrine (actually *sawdust toilet* or *biosolids toilet* would be more appropriate terms) for fifteen years and

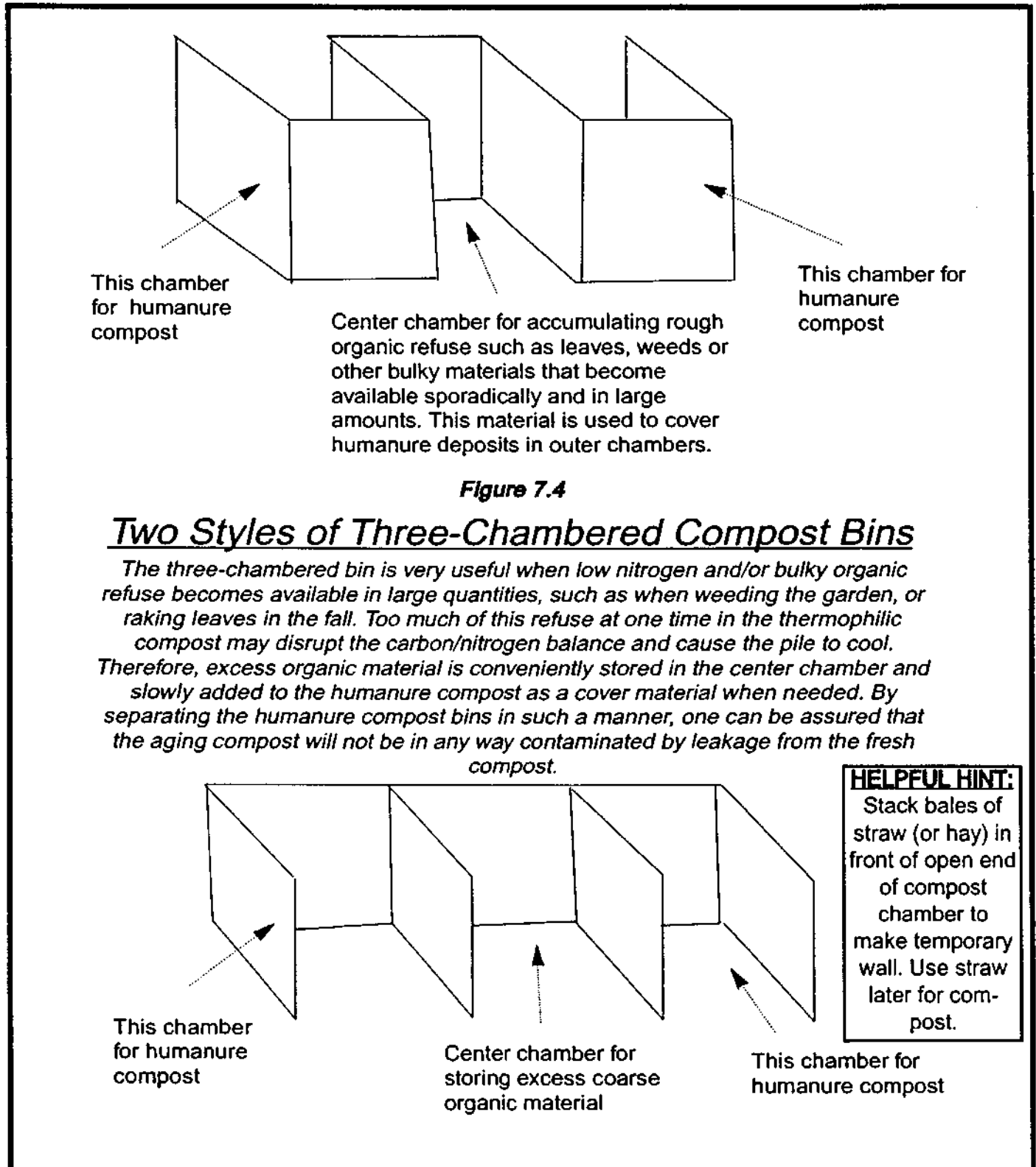

it has never given me odor problems, fly problems, health problems, or environmental problems. Quite the contrary. Nevertheless, Franceys et. al. go on to say that "[humanure] collection should never be considered as an option for sanitation improvement programmes, and all existing bucket latrines should be replaced as soon as possible." Say what?

Obviously Franceys et. al. are referring to the practice of collecting humanure in buckets without a cover material (which would surely stink to high heaven and attract flies) and without any intention of composting the humanure. Such buckets of feces and urine are presumably dumped raw into the environment. Naturally, such a practice should be decried and strongly discouraged, if not outlawed. However, rather than forcing people who use such crude waste disposal methods to switch to other more prohibitively costly waste disposal methods, perhaps it would be better to edu-

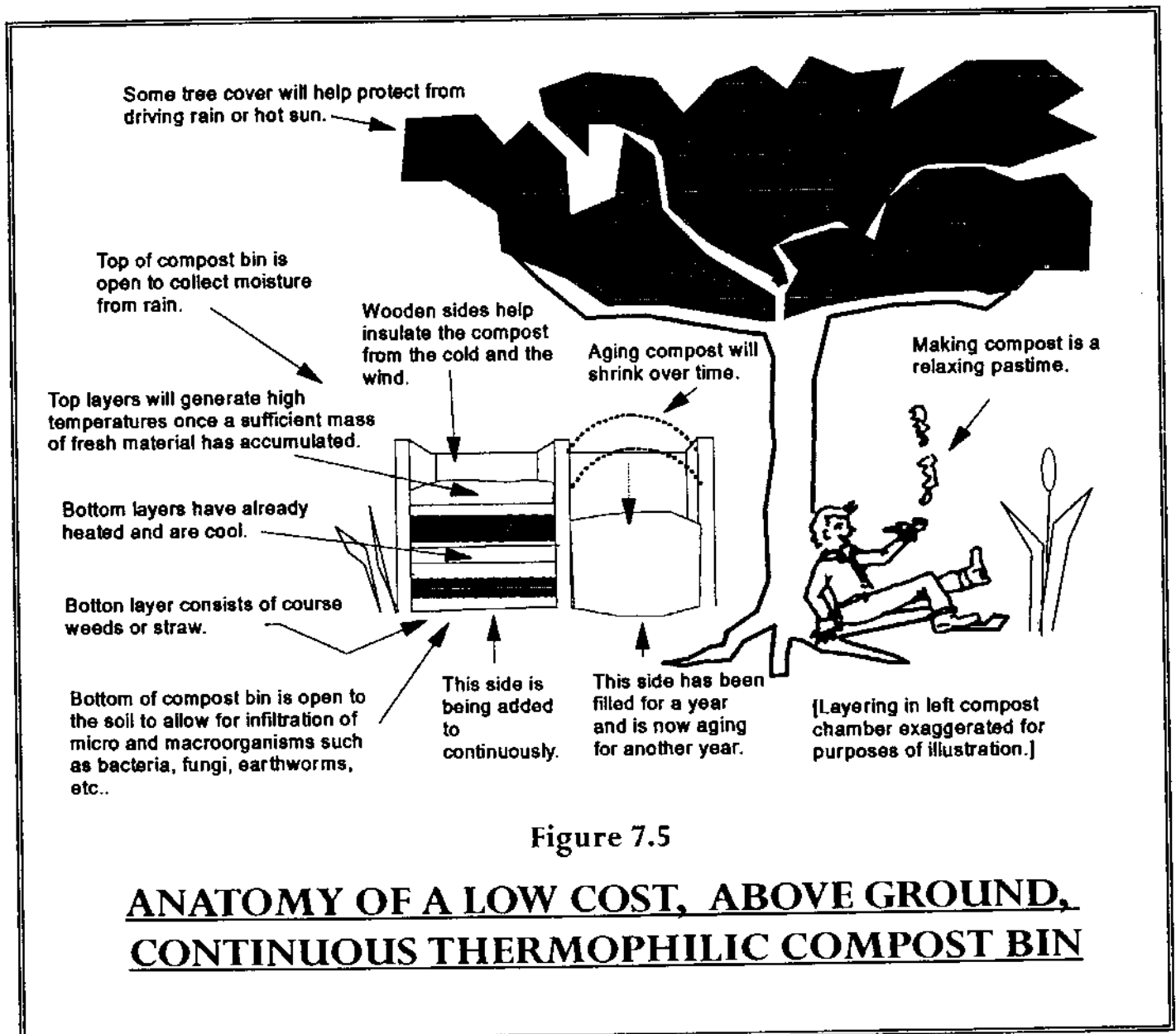

cate those people about *resource recovery*, about the *human nutrient cycle*, and about *thermophilic composting*, and help them acquire adequate and appropriate *cover materials* for their toilets, assist them in constructing *compost bins*, and thereby eliminate waste, pollution, odor, flies and health hazards altogether. I find it inconceivable that intelligent, educated scientists who observe bucket latrines and the odors and flies associated with them do not see that the simple addition of a clean organic cover material to the system would solve the aforementioned problems. Plus balance the nitrogen of the human feces and urine with carbon.

Franceys, et. al. state, however, in their aforementioned book, that "*Apart from storage in double pit latrines, the most appropriate treatment for on-site sanitation is composting.*" I would agree that composting, when done properly, is the most appropriate method of on-site sanitation available to humans. I would not agree that double pit storage is more appropriate than thermophilic composting unless it could be proven that all human pathogens could be destroyed using such a double pit system, and that such a system would not require the segregation of urine from feces. According to Rybczynski, the double pit latrine shows a reduction of *Ascaris ova* of 85% after two months, a statistic which does not impress me. When my compost is finished, I don't want *any* pathogens in it.

Ironically, the work of Franceys et. al. further illustrates a "decision tree for selection of sanitation" that indicates that the use of a "compost latrine" as being one of the least desirable sanitation methods, and one which can only be used if the user is willing to collect urine separately. Unfortunately, contemporary professional literature is rife with this sort of inconsistent and incomplete information which would surely lead a reader to believe that composting humanure just isn't worth the trouble.

On the other hand, Hugh Flatt, who, I would guess, is a practitioner and not an academic, in Practical Self-sufficiency tells of a sawdust toilet system he had used. He lived on a farm for more than thirty years which made use of "bucket lavatories". The lavatories serviced a number of visitors during the year and often two families in the farmhouse, but they used no chemicals. They used sawdust, which Mr. Flatt described as "absorbent and sweet-smelling." The deciduous sawdust was added after each use of the toilet, and the toilet was emptied on the compost pile daily. The compost heap was located on a soil base, the deposits were covered each time they were added to the heap, and kitchen refuse was added to the pile (as was straw). The result was "*a fresh-smelling, friable, biologically active compost ready to be spread on the garden.*"

Perhaps the "experts" will one day understand, accept, and advocate simple humanure composting techniques such as the sawdust or biosolids toilet. However, we may have to wait until Composting 101 is taught at the university.

ANALYSES

After nearly fourteen years of composting all of my family's and visitor's humanure on the same spot about fifty feet above my garden, and using all of the finished compost to grow the food in our single garden, I analyzed my garden soil, my yard soil (for comparison), and my compost, each for fertility and pH, using LaMotte test kits from the local university⁸. I also sent samples of my feces to a local hospital lab to be analyzed for indicator pathogenic ova or worms. The analyses are as follows:

The humanure compost proved to be adequate in nitrogen (N), and rich in phosphorus (P), and potassium (K), and higher than either the garden or the yard soil

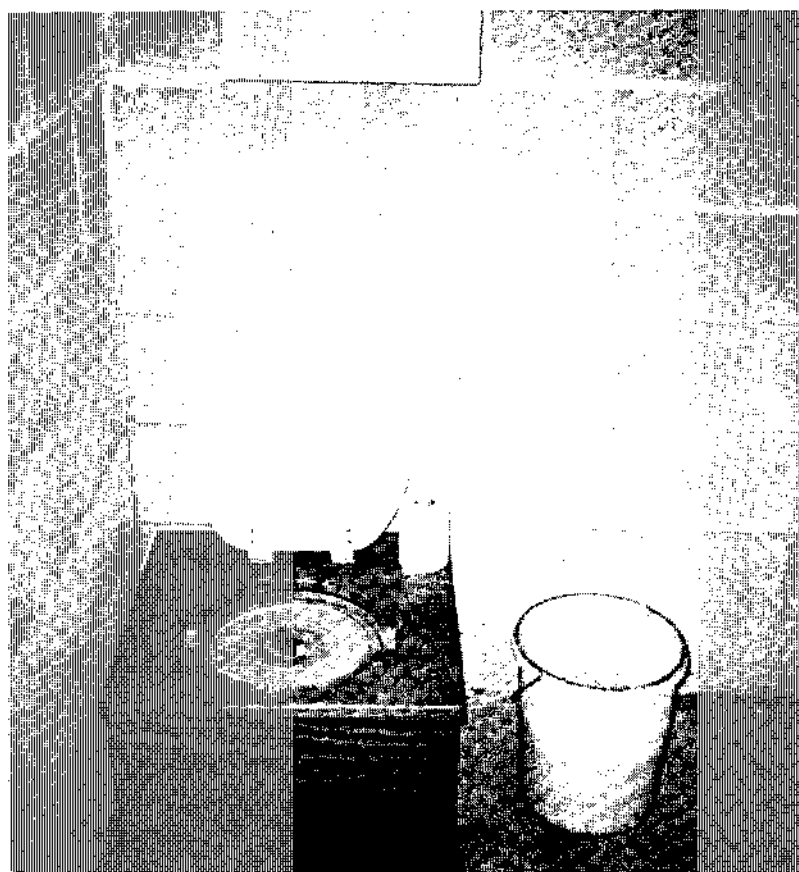

A SAWDUST TOILET IN A BASEMENT.

THIS TOILET IS USED AS AN EMERGENCY BACKUP IN A HOUSE WITH A SEPTIC SYSTEM. NOTE THAT THE HUMANURE RECEPTACLE EMPLOYS AN INNER LID, WHICH IS NOT NECESSARY WHEN ROTTED DECIDUOUS SAWDUST IS USED AS A COVER MATERIAL AND THE REGULAR TOILET SEAT FITS SNUGLY AGAINST THE TOP OF THE HUMANURE RECEPTACLE. THE BUCKET TO THE RIGHT CONTAINS CLEAN SAWDUST, WHICH IS ADDED TO THE TOILET AFTER EACH USE.

in these constituents as well as in various beneficial minerals. The pH of the compost was 7.4 (slightly alkaline), and no lime or wood ashes had been added during the composting process. This is one reason why I don't recommend adding lime (which raises the pH) to a compost pile. A finished compost would ideally have a pH around 7 (neutral).

The garden soil was slightly lower in nutrients (N, P, K) than the compost, and the pH was also slightly lower at 7.2. I had added lime and wood ashes to my garden soil over the years, which may explain why it was slightly alkaline. The garden soil, however, was still significantly higher in nutrients and pH than the yard soil (pH of 6.2), which remained generally poor.

My stool sample was free of pathogenic ova or worms. I used my own stool for analysis purposes because I had been exposed to

the compost system and the garden soil longer than anyone else in my family by a number of years. I had freely handled the compost year after year with no reservations (my garden is mostly hand-worked). I repeated the stool analysis a year later (after fifteen years of composting humanure) again with negative results (no ova or parasites observed).

These results indicate that the compost is a good soil builder, and that no intestinal parasites were transmitted from the compost to the compost handler. This wasn't a laboratory experiment; it was a real life situation conducted over a somewhat lengthy period of time. The whole process, for me, has been a success.

LOW-IMPACT COMPOSTING

It's very important to understand that *two* factors are involved in destroying pathogens in humanure. Along with heat, the *time* factor is important. Once the organic material in a compost pile has been heated by thermophilic microorganisms, it should be left to age or "season". This part of the process allows for the final decomposition to take place, decomposition that may be dominated by fungi and macroorganisms such as earthworms. Therefore, a good compost system will utilize at least two sections or chambers in a single bin, or two separate bins, one to fill and leave to age, and another to fill while the first is aging. One may want to have two separate single-chambered compost bins, or a three-chambered compost bin, or any variation of the double-chambered bin that meets the individual's needs.

When using two compost chambers, fill them one at a time. Stop filling the first one when it's full, which may take a year, and leave it alone. Don't turn it unless you want some exercise, however it should still be heating on the top layer, and turning it now may put out the fire. At that time start filling the second chamber. Then, when the second chamber is nearly full (a year later?), the first one can begin to be emptied onto the garden. The object is to let the compost rest for about a year after the pile has been fully constructed. Pure simplicity (see figures 7.3, 7.4 and 7.5).

A compost pile can accept a huge amount of refuse, and even though the pile may seem to be full, as soon as you turn your back it will shrink down and leave room for more material. So when I say fill the first chamber before filling the second, I mean *FILL* it. You'll know when it's getting full when nothing else will fit on the pile without trying to roll out of the bin.

The timing cycle I follow for compost-making is natural. Natural cycles of time include daily cycles, or "circadian rhythms". For humans that usually involves a daily defecation, a daily sleeping period, etc. For the planet it involves the daily rotation. This cycle of time connects us, as humans, to the other life forms on the earth. It's something we all share in common.

Monthly cycles include the waxing and waning of the moon, the monthly new and full moons, or the monthly revolution of the moon around the earth. This involves tidal cycles, menstrual cycles, and probably a heck of a lot more that I'm not aware of.

Seasonal cycles break up the annual revolution of the Earth around the sun. They're marked by the spring and fall equinoxes and the winter and summer solstices, and by the weather changes of the seasons. All of these cycles are included in the yearly cycle, which involves gardening, farming, planting, harvesting, and anything else done on an annual schedule, including an annual period of rest.

Figure 7.6

Temperature Curve of Frozen Humanure Compost Pile After Spring Thaw

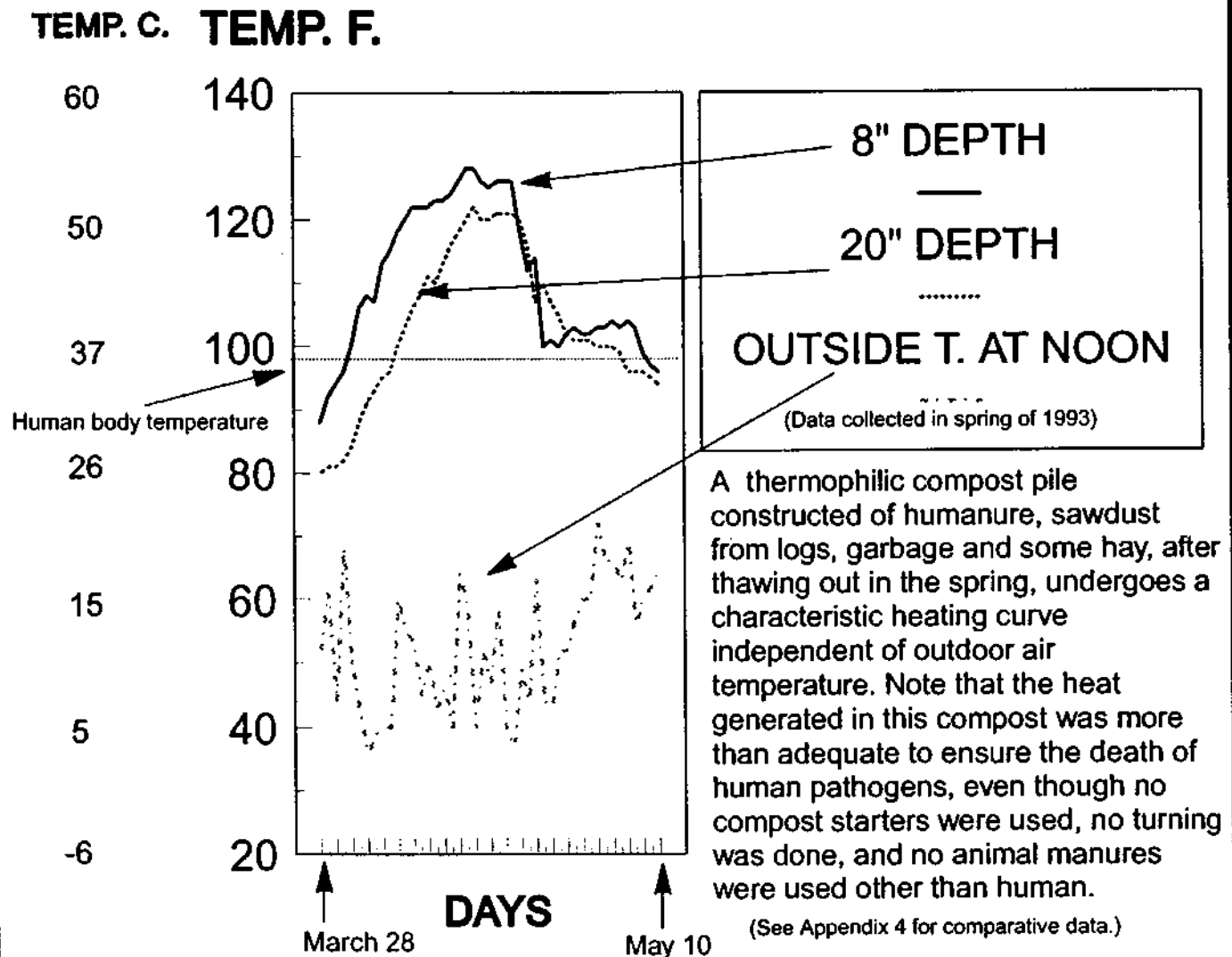

When working with natural cycles such as with the composting stage of the human-nutrient cycle, it's best, I believe, to follow natural cycles of time as well. They go hand in hand. Therefore, I've found a yearly cycle to work best for me in making compost. By late spring, the compost bin is full and it's time to leave it sit until the next spring, when the finished compost will be ready to be removed to the garden. The removal of the finished compost takes place in the spring prior to or during planting time.

MONITORING COMPOST TEMPERATURE

The preceding graph shows the rise in temperature of a humanure compost pile (feces, urine, and garbage) which had been frozen all winter. That particular spring was very cold, so the pile didn't thaw out until late March. Until then it was hard as a rock, a large pile of frozen mass, nearly filling a 5' x 5' x 4' bin.

The compost consisted primarily of deposits from the sawdust toilet, which contained raw hardwood sawdust (just enough to cover the material in the toilet), humanure including urine, and toilet paper. In addition to this material, kitchen garbage was added to the pile intermittently throughout the winter, and hay was used to cover the toilet deposits on the pile. Some weeds and whatnot may have been thrown in now and then, but garden material isn't available during the winter except in the form of

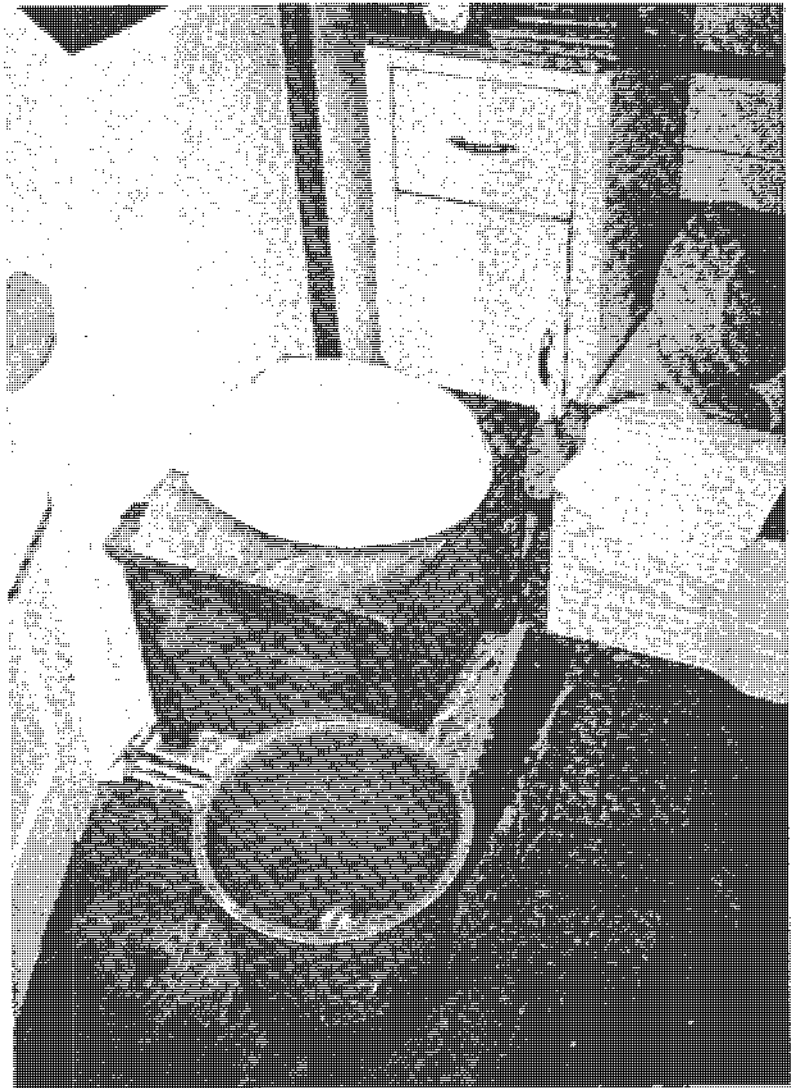

THIS SAWDUST TOILET CONSISTS OF A WOODEN BOX SITUATED OVER A FIVE GALLON, PLASTIC HUMANURE RECEPTACLE (NOT VISIBLE). THE BOX IS LIFTED OFF THE RECEPTACLE WHEN IT IS FULL, AND THE ORGANIC REFUSE IS THEN REMOVED TO THE COMPOST BIN OUTDOORS.

DO's and DONT's of a thermophilic toilet composting system:

DO - Collect urine in the toilet. Urine provides essential moisture and nitrogen.

DO - Have a supply of cover material for the toilet to eliminate odor, absorb excess moisture and urine, and balance the C/N ratio. Examples: rotting sawdust, peat moss.

DO - Have another supply of cover material to cover the compost pile itself, for odor prevention, air entrapment, and C/N balance. Examples: Hay, straw, weeds, leaves, grass.

DO - Occasionally rake exposed outer surfaces of the compost pile onto the top of the pile.

DO - Add a mix of organic material to the compost pile, including organic garbage.

DO - Keep top of compost pile somewhat flat. This allows rain to be absorbed, and added organic material to stay on top.

DO - Use a compost thermometer. If the temperature of your compost does not seem adequate to you, use finished compost for berries, fruit trees, and ornamentals, instead of garden crops.



DON'T - Segregate urine from feces.

DON'T - Turn the pile if it is being continuously added to.

DON'T - Cover fresh compost deposits with lime or wood ashes. Put lime and wood ashes directly on soil. Cover compost with clean organic materials that will benefit the composting process, such as mentioned at left.

DON'T - Deposit urine/feces/sawdust into a compost bin without cover

materials and other organic refuse and expect it to thermophilically compost. The layering of a wider mix of materials traps air and provides nutrients that stimulate thermophilic activity.

DON'T - Worry if your compost does not reach an extremely high temperature quickly. Temperatures above 110° F indicate thermophilic activity, which may peak periodically in a continuous compost pile when sufficient organic mass has accumulated.

Temperatures above 104°F may be sufficient to kill pathogens (see page 99).

A compost bin may require some time to develop a resident thermophilic population. If your compost does not achieve thermophilic temperatures, after collecting it for a year and aging it for another year, use it to plant berries, fruit trees, or ornamental plants.

kitchen refuse, so not much in the way of garden weeds was in this pile.

The material was collected over a period of about four months from a family of four. Nothing special was done to the pile at any time. No unusual ingredients were added, no compost starters, no water, no animal manures other than human, and no turning whatsoever. The compost pile was situated in a three-sided, open-topped wooden bin on the dirt ground, outside. Only normal household organic refuse such as produced by any human being was added to the pile including human fecal material and urine. The only imported materials (not from the home) were sawdust, a locally abundant resource, and hay from a neighboring farm (one or two bales were used during the entire winter).

Notice that the outside of the pile was heated by thermophilic activity before the inside. The outside thawed first, so it started to heat first. Soon thereafter the inside thawed and also heated. By April 8th the outer part of the pile had reached 120°F (50°C) and the temperature remained at that level or above until April 22 (a two week period). The inside of the pile reached 120°F on April 16, over a week later than the outside, and remained there or above until April 23. The data suggest that the entire pile was at or above 120°F for a period of eight days before starting to cool. Two thermometers were used to monitor the temperature of this compost, one having an 8" probe, the other having a 20" probe. The 8" thermometer came from Edmund Scientific Co.; the 20" thermometer came from Real Goods, 966

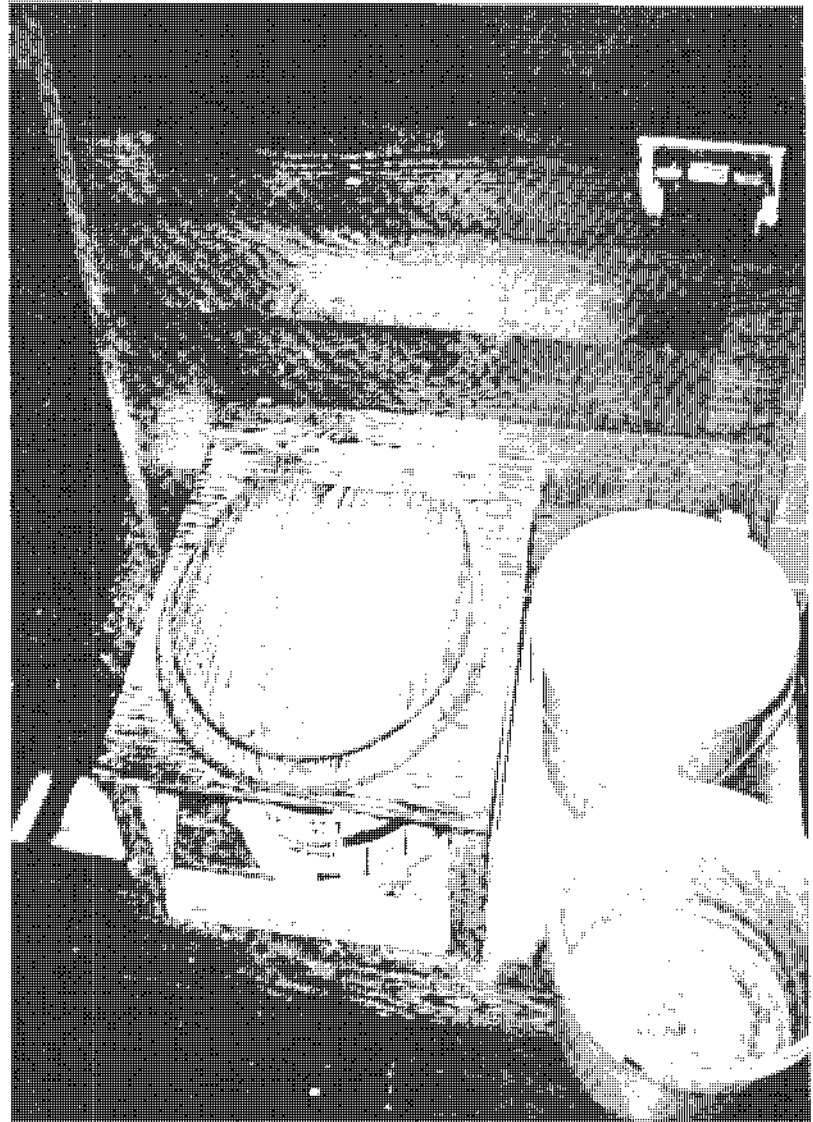

A SAWDUST TOILET IN A MOBILE HOME. THE FRAME IS HINGED TO THE WALL AND LIFTS UP OFF THE HUMANURE RECEPTACLE WHEN REMOVAL IS NECESSARY.

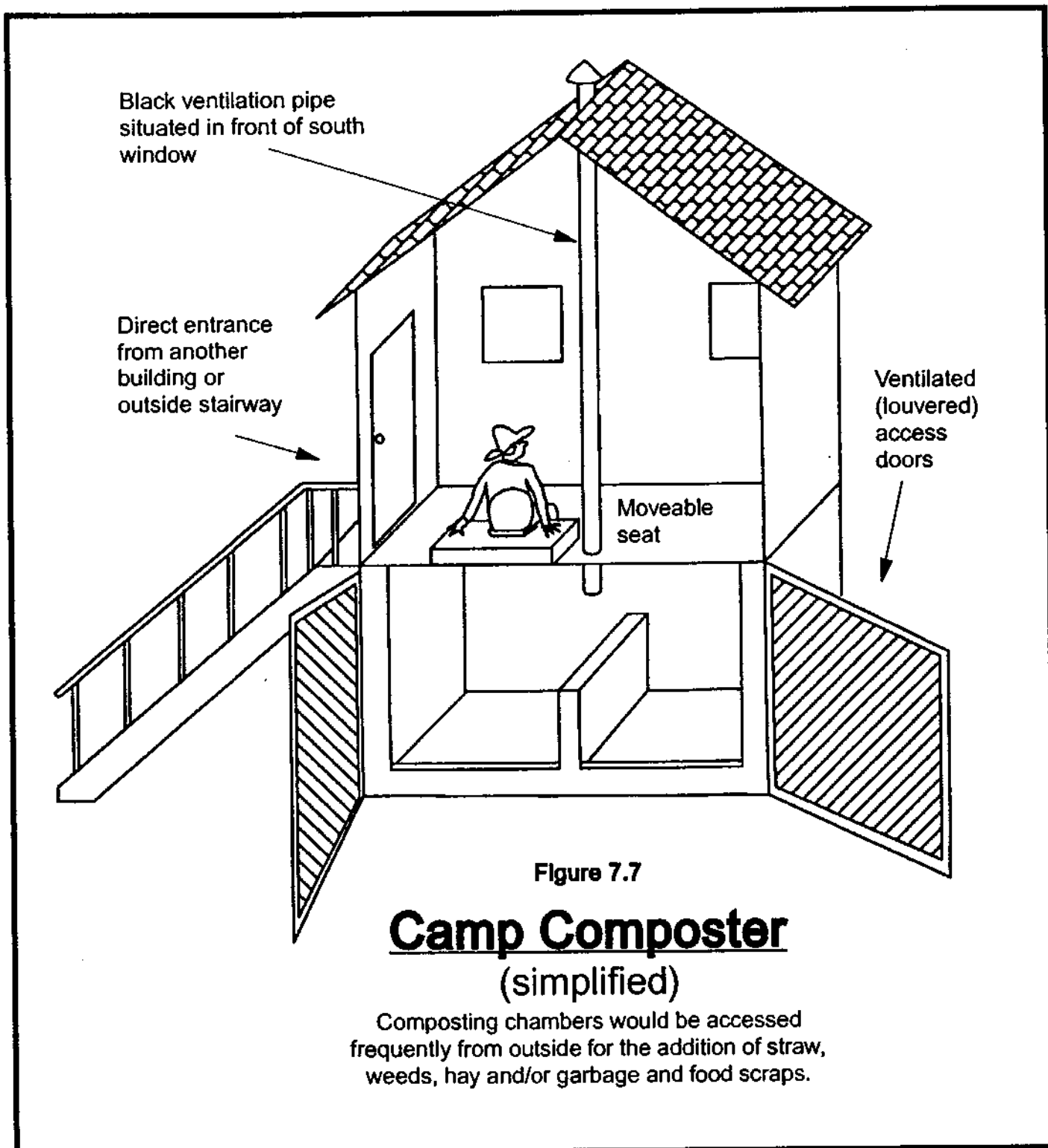

Mazzoni St., Ukiah, CA 95482-9292. The Real Goods thermometer was the best buy (see appendix 1 on page 185 for sources of compost thermometers).

According to Dr. T. Gibson, Head of the Department of Agricultural Biology at the Edinburgh and East of Scotland College of Agriculture, *"All the evidence shows that a few hours at 120 degrees Fahrenheit would eliminate [pathogenic*

microorganisms] completely. There should be a wide margin of safety if that temperature were maintained for 24 hours.” (See The Complete Book of Composting, 1960, J. I. Rodale, p. 650, Rodale Books, Emmaus, PA).

This opinion is corroborated by Feachem et. al. and many others, and is illustrated in figure 6F, page 133, titled “Safety Zone for Pathogen Death”, which is a diagram adapted from Feachem’s work (Appropriate Technology for Water Supply and Sanitation) extensively used as a reference in chapter 6. That diagram indicates that one day at 122°F will kill the human pathogens that can be resident in humanure. A week at 115°F will do the same thing. Higher temperatures kill things faster, lower temperatures take more time. A combination of heating the compost then retaining the heated and cooled compost in storage for a period of months seems to be a good bet for making fine kitchen-garden compost from humanure. That’s the sawdust or biosolids toilet system in a nutshell.

The significance of the aforementioned graph is that it shows the humanure required no coaxing to heat up sufficiently to be rendered hygienically safe. It just did it on its own, having been provided the simple requirements a compost pile needs.

A comparative temperature curve monitored the following spring indicated that the addition of a small amount of chicken manure improved the thermophilic activity of the compost (see appendix 4, p. 187).



AN OUTDOOR SAWDUST TOILET BUILT OF RECYCLED MATERIALS. A REMOVABLE BUCKET LINGERS UNDER THE TOILET SEAT, WAITING TO BE FILLED, EMPTIED AND COMPOSTED.

LEGALITIES

I knew of some local folks, Amish, who had a baby at home a couple of years ago. Babies born at home nowadays are no big deal; most of the Amish have a midwife deliver their babies. All of my six children were born at home. However, a local county health worker decided to put a stop to this practice and *charged the young Amish couple with child abuse for not having their baby born in a hospital.*

Here we have an otherwise happy young couple who just had a beautiful baby, and some poor, deluded authority figure was actually telling them he'd have their baby taken away and put in a foster home if they didn't tell him who delivered the kid. This is a true story. The couple gave him the name of their midwife, a highly respected and eminently qualified woman who has now delivered over one thousand babies. She was promptly arrested. To make a long story short, the local magistrate threw the charge (practicing medicine without a license) out, the authorities actually appealed, then the higher court threw the charges



THIS UNPRETENTIOUS STRUCTURE HOUSES A SAWDUST TOILET. ALTHOUGH CONSIDERED AN "OUT-HOUSE", THERE IS NO PIT UNDERNEATH AND NO LEACHING OF POLLUTION INTO THE GROUND. THE HUMANE IS INSTEAD COLLECTED AND COMPOSTED.

out.

What's that have to do with compost? Composting humanure, is like having babies where and how you want them, or educating your kids alternatively. It's behavior out of the mainstream of Western society. It may be something different, and different things can scare people when they don't know anything about them, especially

those people who have oatmeal for brains and have somehow gravitated into a position of authority. Whether it's legal or not often isn't the issue. The Amish story is one of many in which the basic rights of humans have been subverted by the ignorance and the misuse of authority by others.

Ideally, laws are made to protect society. Laws requiring septic, waste, and sewage disposal systems are supposedly designed to protect the environment, the health of the citizens and the water table. This is all to be commended,

and conscientiously carried out by those who produce *sewage*, a waste material. If you don't produce sewage, you have no need for a sewage disposal system, and laws pertaining to sewage disposal are not your concern. The number of people who produce compost instead of sewage is so minimal, that few, if any, laws have been enacted to regulate the practice. The thermophilic composting of humanure is not a threat to society, it produces no pollution, does not threaten the health of humans or contaminate the ground water or environment. Unfortunately, this fact is not understood by many people, and ignorance is a problem.

It would be hard to intelligently argue that a person who produces no sewage must have a costly sewage treatment system. What would they do with it? That would be like requiring someone who doesn't own a car to have a garage. And it would be very difficult to prove that composting humanure is threatening to society, especially given the facts as presented in this book. On the other hand, Galileo, the astronomer, was arrested as a heretic and forced to renounce his theory that the Earth revolves around the sun. Sure, that was three hundred years ago. But sometimes I think the consciousness of our society as it relates to human manure is still back in the middle

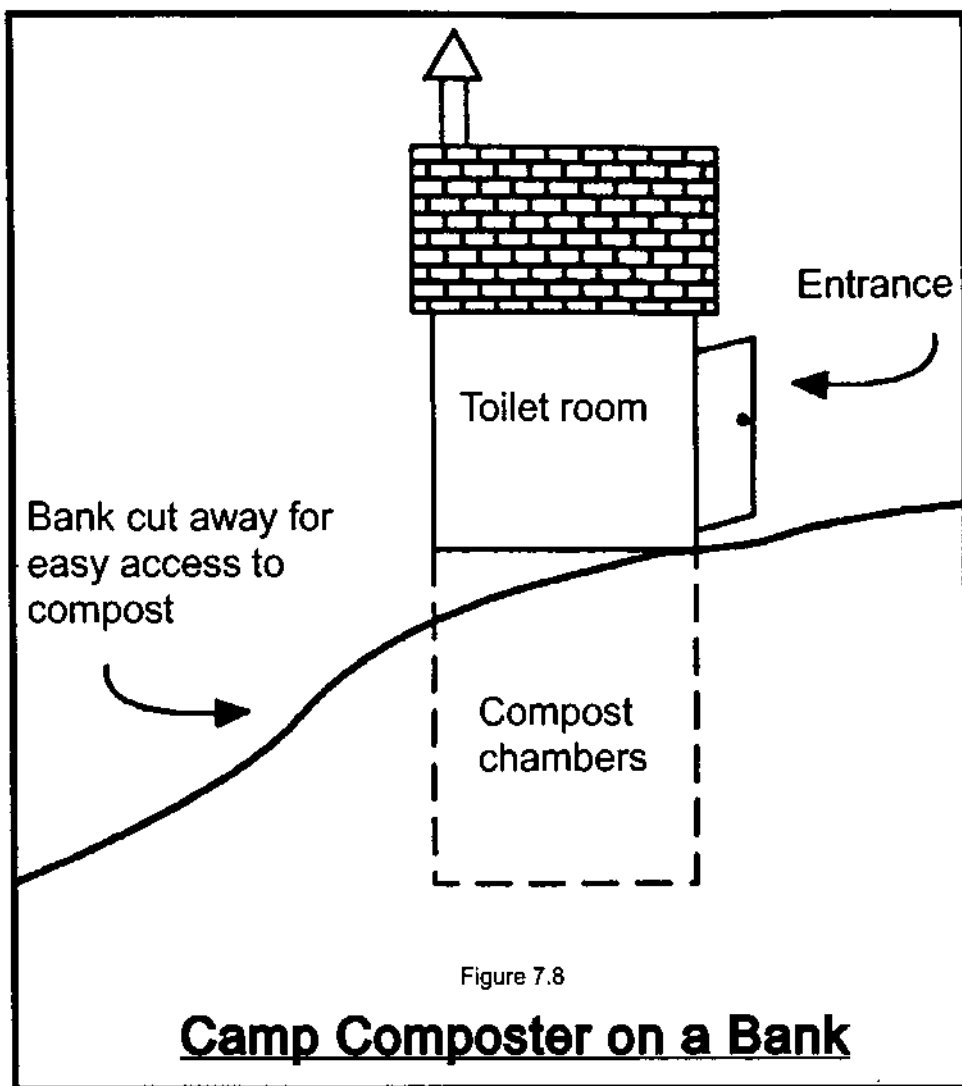

ages.

One way to dispel the darkness of ignorance is with the light of knowledge. Knowledge is best gained by experience. Therefore, I'd like to hear from any of you readers about your composting experiences. You may be able to add to the body of knowledge, and I may someday revise and update this book to include the experiences of others. So don't hesitate at any time to write to the address at the front of this book and let me know how it's going for you. I'd welcome *any* feedback at all.

If you're concerned about your local laws, go to the library and see what you can find about regulations concerning compost. Or also inquire at your county seat or state agency as statutes, ordinances, and regulations vary from locality to locality.* Where I live septic system permits aren't required for new home construction, but the next county is two properties over and people there are required to have septic system permits before they can build a new dwelling. This is largely due to the fact that the water table tends to be high in my area, and septic systems don't always work, so sand mounds are required by law for sewage disposal. Now, if you don't want to dispose of your manure but want to compost it instead (which will certainly keep it out of the water table, not to mention raise a few eyebrows at the local municipal office), you may have to stand up for your rights.

In Pennsylvania, the state legislature has enacted legislation "*encouraging the development of resources recovery as a means of managing solid waste, conserving resources, and supplying energy.*" Under such legislation the term "disposal" is defined as "*the incineration, dumping, spilling, leaking, or placing of solid waste into or on the land or water in a manner that the solid waste or a constituent of the solid waste enters the environment, is emitted into the air or is discharged to the waters of the Commonwealth*" (Pennsylvania Solid Waste Management Act, Title 35, Chapter 29A). Further legislation has been enacted in Pennsylvania stating that "*waste reduction and recycling are preferable to the processing or disposal of municipal waste,*" and further stating "*pollution is the contamination of any air, water, land or other natural resources of this Commonwealth that will create or is likely to create a public nuisance or to render the air, water, land, or other natural resources harmful, detrimental or injurious to public health, safety or welfare. . .*" (Pennsylvania Municipal Waste Planning, Recycling and Waste reduction Act (1988), Title 53, Chapter 17A). In view of the fact that the thermophilic composting of humanure involves recovering a resource, requires no disposal of waste, and creates no environmental pollution, it is unlikely that anyone who *conscientiously* engages in such an activity would be successfully convicted of criminal activity.

If there aren't any regulations concerning compost in your area, then be sure that when you're making your compost, you're doing a good job of it. It's not hard to do it right. The most likely problem you could have is an odor problem, and that's

simply due to not keeping your deposits adequately covered with clean organic material. If you keep it covered, it does not give off offensive odors. It's that simple. Perhaps shit stinks so people will be naturally compelled to cover it with something. That makes sense when you think that thermophilic bacteria are already in the feces waiting for the manure to be layered into a compost pile so they can get to work. Sometimes the simple ways of nature are really profound.

Few people understand that the composting of humanure is a benign method of recycling what would otherwise be a toxic waste material. For that reason, this book is recommended reading for people involved in municipal, county, or township waste treatment or permitting, or resource recovery.

What about gray water? You're still producing gray water and therefore you may still need a septic system or something of the sort as required by law, you may wonder. Maybe, maybe not. Gray water is relatively easy to deal with. A biological treatment system such as an artificial wetland, algae pond, or heck, a patch of woods can effectively absorb gray water, especially if you have sense enough to keep toxic materials and fecal material out of your drains. However, now we're getting beyond the scope of this book. Low-impact gray water treatment systems could involve another whole publication.

And what about flies, could they create a public nuisance? I have never had problems with flies on my compost. Perhaps the compost heats up so fast that flies don't have a chance to enjoy it. And rats? I've never seen one on my homestead. I guess steaming compost doesn't appeal to them. Nor does it appeal to raccoons, dogs or cats.

Concerning flies, F. H. King, who traveled through China, Korea and Japan in the early 1900's when organic material, especially humanure, was the only source of soil fertilizer, stated, *"One fact which we do not fully understand is that, wherever we went, house flies were very few. We never spent a summer with so little annoyance from them as this one in China, Korea and Japan. If the scrupulous husbanding of waste [sic] refuse so universally practiced in these countries reduces the fly nuisance and this menace to health to the extent which our experience suggests, here is one great gain."* He added, *"We have adverted to the very small number of flies observed anywhere in the course of our travel, but its significance we did not realize until near the end of our stay. Indeed, for some reason, flies were more in evidence during the first two days on the steamship out from Yokohama on our return trip to America, then at any time before on our journey."*⁹

If an entire country the size of the United States, but with twice the population (at that time), could recycle all of its organic refuse without the benefit of electricity or automobiles and not have a fly problem, surely we in the United States can recycle a greater portion of our own organic refuse with similar success today.

REFERENCES - CHAPTER SEVEN

- 1 - Thimann, K.V. (1955). The Life of Bacteria: Their Growth, Metabolism, and Relationships. The Macmillan Co., New York. (p.177).
 - 2 - Waksman, S.A. (1952). Soil Microbiology. John Wiley and Sons, Inc., New York. (p.70).
 - 3 - Atlas, R.M. and Bartha, R. (1981). Microbial Ecology: Fundamentals and Applications. Addison-Wesley Publishing Co., Reading, Mass. (p.392)
- also:
- Cooney, D.G. and Emerson, R. (1964). Thermophilic Fungi. W.H. Freeman and Company, San Francisco. (pp.129,142).
- also
- Waksman, Soil Microbiology, (p.71).
- 4 - Lewis, Ricki. (1992). FDA Consumer, September 1992 (p.37)
 - 5 - Lynch, J.M. and Poole, N.L. (Eds.). (1979). Microbial Ecology: A Conceptual Approach. Blackwell Scientific Publications, London. (p.238).
 - 6 - Rodale, R. I. (1960). The Complete Book of Composting. Rodale Books Inc.: Emmaus, PA. (p.192).
 - 7 - Kitto, Dick. (1988). Composting: The Organic Natural Way. Thorsons Publishers Ltd.: Wellingborough, England. (p. 103).
 - 8 - LaMotte Chemical Products Co., Chestertown, MD 21620
 - 9 - King, F.H. (1911). Farmers of Forty Centuries. Rodale Press, Inc., Emmaus, PA 18049. (pp.78, 202).

***Maryland residents (or anyone else) can obtain: "A Farmers' Guide to Maryland Compost Regulations", from Pickering Creek Environmental Center, 27370 Sharp Road, Easton, Maryland 21601.**

"The On-Farm Composting Handbook" is available from The Northeast Agricultural Engineering Service, 152 Riley-Robb Hall, Cooperative Extension, Ithaca, NY 14853-5701.

Two information packages on Farm Scale Composting and Yard Waste Composting are available free from the Appropriate Technology Transfer for Rural Areas, PO Box 3657, Fayetteville, AR 72702, phone: (800) 346-9140.

A journal of composting and recycling which may contain pertinent information is: Biocycle, JG Press, Inc., 419 State Ave., Emmaus, PA 18049.

The Agricultural Composter Newsletter is available from: The Agricultural Composting Association, PO Box 608, Belchertown, MA 01007.

THE END IS NEAR

"If you want to be free, learn to live simply. Use what you have and be content where you are."

J. Heider



Ladies and gentlemen, allow me to introduce you to a new and revolutionary literary device: the *Self-Interview!* [Applause heard in background. Someone whoops.] Today I'll be interviewing myself. In fact here I am now. [Myself walks in.]

Me: Good morning sir. Haven't I seen you somewhere before?

Myself: Cut the crap. It's too early in the morning for this. You see me every time you look in the mirror, which isn't very often, thank God. What, for crying out loud, would possess you to interview yourself anyway?

M: If I don't, who will?

MS: You do have a point there. In fact, that may be a point worthy of contemplation.

M: Well, let's not get off the track. The topic of discussion today is a material substance near and dear to us all. Shall we step right into it?

MS: What the hell are you talking about?

M: I'll give you a hint. It often can be seen with corn or peanuts on its back.

MS: Elephants?

M: Close, but no cigar. In fact, cigar would have been a better guess. We're going to talk about *humanure*.

MS: You dragged me out of bed and forced me to sit here in front of all these people to talk about CRAP?!

M: You wrote a book on it, didn't you?

MS: So what? OK, OK. Let's get on with it. I've had enough of your theatrics.

M: Well first off, do you expect anyone to take your *Humanure Handbook* seriously?

MS: Why wouldn't they?

M: Because nobody gives a damn about humanure. The last thing anyone

wants to think about is a turd, especially their own. Don't you think that by bringing the subject to the fore you're risking something?

MS: You mean like mass constipation? Not quite. I'm not going to put any toilet bowl manufacturers out of business. Like I said, I'd estimate that one in a million people have any interest at all in the topic of resource recovery in relation to human excrement. Nobody thinks of shit as a resource, it's just too bizarre a concept. When I've printed and distributed the 250th copy of the *Humanure Handbook* in the USA, I'll probably consider that market saturated.

M: Then what's the point?

MS: The point is that long-standing cultural prejudices and phobias need to be challenged once in a while by somebody, anybody, or they'll never change. Fecophobia is a deeply rooted fear in the American, and perhaps Western, psyche. But you can't run from what scares you. It just pops up somewhere else where you least expect it. We've adopted the policy of defecating in our drinking water and then piping it off somewhere to let someone else, if anyone, deal with it. So now we're finding that our drinking water sources are becoming increasingly contaminated. What goes around comes around.

M: Oh, come on. I drink water everyday and it's never contaminated. We Americans probably have the most abundant supply of safe drinking water of any country on the planet.

MS: Yes and no. Your water may suffer from no fecal contamination, true, and when I say fecal contamination I mean intestinal bacteria in water. But how much chlorine do you drink instead? Then there's beach pollution. But I don't want to get into all this again. I've already discussed human waste pollution in chapter one.

M: Then you'll admit that American water supplies are pretty safe?

MS: Yes, they are. Even though we defecate in our water, we go to great lengths and expense to clean the pollutants back out of it. We do a good enough job to keep most of our drinking water safe, albeit with chemical additives. However, drinking water supplies are dwindling all over the world, water tables are sinking, and water consumption is on the increase with no end in sight. That seems to be a good reason to not pollute water with our daily bowel movements. And still, that's only *half* the equation.

M: What do you mean?

MS: Well, we're still throwing away the agricultural resources that humanure should be providing us. We're not maintaining an intact human nutrient cycle. By piping sewage into the sea we're essentially dumping grain into the sea. By burying sludge, we're burying a source of food. That's a cultural practice that should be challenged. It's a practice that's not going to change overnight, but will change incremen-

tally if we begin acknowledging it now.

M: So what're you saying? You think everybody should shit in donut buckets?

MS: God forbid. Then you would see mass constipation!

M: Well then, I don't understand. Where do we go from here?

MS: I'm not suggesting a mass cultural revolutionary change in toilet habits. I'm suggesting a change in the way we *understand* our habits. Most people never heard of such a thing as a nutrient cycle. Recycling humanure is just not something anyone ever thinks about. I'm simply suggesting that we begin thinking about new approaches to the age-old problem of what to do with human excrement.

M: That's a beginning, but that's probably all we'll ever see in our lifetime, don't you think?

MS: Don't be so sure about that. Things are changing. I predict that compost toilets and toilet systems will be designed and redesigned in our lifetimes. Eventually, entire housing developments will utilize compost toilet systems. Some municipalities will someday install compost toilet systems in all new homes.

M: You think so? What would that be like?

MS: Well, each home might have a removable container made of recycled plastic that would act as both a toilet receptacle and a garbage disposal.

M: How big a container?

MS: You'd need about five gallons of capacity per person per week. A container the size of a fifty gallon drum should fill in two to three weeks for an average family. Every household will deposit all of its organic refuse except gray water into this glorified donut bucket, including maybe grass clippings and yard leaves. The municipality will provide a cover material for odor prevention of something like ground leaves or rotted sawdust, neatly packaged for each household and possibly dispensed automatically into the toilet after each use. *This would eliminate the production of all garbage and all sewage by human households*, as it would all be collected without water and composted at a municipal compost yard away from town.

M: Who'd collect it?

MS: Once every couple of weeks or so the *Resource Recovery Team* would stop by and take the compost receptacle from your house, sliding it out a side wall in a manner similar to the old coal chutes, using a hand-operated fork lift type machine specially suited for this purpose. A new compost receptacle would then be slid back in to replace the old, and the air-tight gasket joining it to the toilet seat and ventilation pipe would be locked into place. Your manure and your garbage, mixed together with ground leaves and other organic refuse or crop residues would be collected regularly just like your garbage is collected now. Except the destination would not be a landfill, it'd be the compost yard where the organic material would be converted, through

thermophilic composting, into an agricultural resource, and sold to farmers who'd use it to grow food. The natural cycle would be complete, immense amounts of landfill space would be saved, a valuable resource would be recovered, pollution would be reduced, and soil fertility would be enhanced. So would our long-term survival as human beings on this planet.

M: I don't know. . . , how long before Americans will be ready for that?

MS: In Japan today, a similar system is in use, except that, rather than removing the container and replacing it with a clean one, the truck that comes to pick up the humanure suctions it out of the container it's in. Sort of like a truck sucking the contents out of a septic tank. What they do with it after that I don't know. I also don't know whether they mix their garbage with it at home or not. (I need to travel to Asia.)

Such a truck system involves a capital outlay about a third of that for sewers. One study which compares the cost between manual humanure removal and waterborne sewage in Taiwan estimates the manual collection costs to be less than one fifth the cost of waterborne sewage treated by oxidation ponds. That takes into account the pasteurization of the humanure as well as the market value of the resultant agricultural soil additive.¹

We Americans have a long way to go. The biggest obstacle is in understanding and accepting humanure and other organic materials as resource materials rather than waste materials. We have to stop thinking of human excrement and garbage as waste. When we do, then we'll stop defecating in our drinking water and sending our garbage to landfills.

It's critical that we separate water from humanure. As long as we keep defecating in water we'll have a problem that we can't solve. The solution is to stop fouling our water, not to find new ways to clean it up. Don't use water as a vehicle for transporting human excrement or other waste. Humanure must be collected along with other solid (and liquid) organic refuse produced by human beings and composted. We won't be able to do this as long as we insist upon defecating into water. Granted, we can dehydrate the water-borne sewage sludge and compost that. However, this is a complicated, energy-intensive process, and then the sludge is contaminated with all sorts of bad stuff from our sewers which becomes concentrated in the compost.²

M: It'll never happen. Face it. Americans, Westerners, will never stop shitting in water. They'll never, as a society, compost their manure. It's unrealistic. It's against our cultural upbringing. We're a society of Howdy-Doody, hotdogs, hairsprays and Ho-Hos, not composted humanure fer christsake. We don't *believe* in balancing human nutrient cycles! We just don't give a damn. Compost making is unglamorous and you can't get rich doing it. So why bother?!

MS: You're right on one point - Americans will never stop shitting. But don't be so hasty. In 1988 in the United States alone, there were 49 operating municipal sludge composting facilities.³ In Duisberg, Germany, a decades-old plant composts 100 tons of domestic refuse daily. Another plant at Bad Kreuznach handles twice that amount. Many European composting plants compost a mixture of refuse and sewage sludge. A solid waste composting plant in Oregon is designed to handle 800 tons of refuse daily. There are at least three composting plants in Egypt. In Munich, a scheme was being developed in 1990 to provide 40,000 households with "biobins" for the collection of compostable refuse.⁴

It's only a matter of time before the biobin concept is advanced to collect humanure as well. As it is today, much of the compost being produced by the big plants is contaminated with such things as batteries, metal shards, wine bottle caps, paints, heavy metals and the like. As a result, much of it isn't useful for agriculture and has to be used for filler or for other non-agricultural applications, which, to me, is absurd. The way to keep the junk out of the compost is to value the compostable organic refuse enough to collect it separately from the other trash, and to keep the humanure out of the sewers. A household biobin would do the trick. The biobin could be collected regularly, emptied, its contents composted, and the compost sold to farmers and gardeners as a financially self-supporting service provided by independent businesses.

Some entrepreneurs have already got into the sewage composting business in the United States. In 1989, the town of Fairfield, Connecticut contracted to have its yard refuse and sewage sludge composted. The town is said to have saved at least \$100,000 in waste disposal costs in its first year of composting alone. The Fairfield operation, which is just one quarter mile from half million dollar houses, is reported to smell no worse than wet leaves from only a few yards away.⁵

Some say that as much as 50% of all municipal refuse could be converted into compost. However, the problem remains the same: contamination of the compost, largely due to sewage sludge contamination and inadequate or improper collection systems for organic refuse. Americans put someone on the moon in 1969, surely we can figure out the solution to making good compost today.

M: But still, there's the fear of humanure and its capability of causing disease and harboring parasites.

MS: That's right. But y'know, according to the literature, a temperature of 122°F for a period of twenty-four hours is sufficient to kill all of the human pathogens potentially in humanure. When my humanure compost pile thawed out last spring, I put two thermometers in it, one with a long (20") probe and one with a short (8") probe to see what happened with the temperature. Now this was a pile of human

manure, urine, sawdust, kitchen food scraps, and some weeds and hay. This was a pile that I never turned or worked manually in any way, except to occasionally rake the exposed outer surfaces of the pile on to the top of the pile to ensure inclusion of all the compost in the thermophilic process. I also occasionally raked the top of the pile flat, but I never manually aerated the compost. Nor did I add any compost starters or anything else. The pile was outside, exposed to the air and rain in a three sided wooden bin with an earth bottom. As soon as the pile thawed it began to heat. In a few weeks, the entire pile reached and maintained a temperature of over 120°F and stayed there for eight days. Parts of the pile stayed over 120°F for over two weeks. This spring I monitored my compost pile temperature again, after it thawed. This time it stayed above 122° for 25 days. I'm not worried about diseases or parasites in my compost at all. It doesn't seem to me that creating thermophilic compost is difficult or complicated, and that's what we need to do in order to sanitize human excrement without excessive technology and energy consumption. Thermophilic composting is something simple humans all over the world can do whether they have money or technology or not.

M: Why would the heat of a compost pile kill human pathogens anyway? I don't understand that.

MS: Human disease-causing organisms thrive in the human body, which has a temperature of about 98.6°F. They like this temperature. The natural way the body tries to destroy the pathogens is by elevating its own body temperature. That's called a fever, and the temperature rarely exceeds 104°F. Now I understand that the body raises its temperature not only to retard the growth of pathogens, but also to accelerate the growth of disease fighting components of the human bloodstream, such as white blood cells. However, the higher the temperature, the harder it is for human pathogens to survive. Not only does a high compost temperature destroy the pathogens, but it also indicates prolific microbial activity in the compost, and thereby a level of microbial competition that thwarts the growth and reproduction of microscopic animals that would rather be in someone's body than in an over-populated compost pile. When the temperature climbs to 110 or 120°F, the pathogens start rapidly dying off. Our bodies can't achieve that kind of temperature elevation, but thermophilic microorganisms can. A compost pile is like a mass of life that is having a huge fever. Pathogens are comfortable in the human body, but they can't take the heat of the compost. It's a harsh and unnatural environment for them. A killer.

Furthermore, just leaving a compost pile sit for a year will kill off almost all pathogens, *Ascaris* (roundworm) eggs being the exception. They're tough buggers, but heat will do them in. That's why I recommend letting compost heat, like a fever, then letting it sit and age. That's the one-two punch.

M: But how do you know that *all* parts of the compost pile are being subjected to temperatures sufficient to kill potential pathogens? If the pathogens are microscopic and a little piece of fecal material rolls off the pile, why wouldn't billions of pathogens in that little piece then escape the thermophilic process and live on to cause trouble another day?

MS: That's one of the most common questions I'm asked. Frankly, you *don't* know that *all* parts of the compost pile have elevated in temperature sufficiently to kill all pathogens. And you will never know for sure that every cubic centimeter of your finished compost is pathogen-free unless you analyze every cubic centimeter in a laboratory. Which few people can afford to do, and even fewer want to do. There will always be people who will not be convinced that thermophilically composted humanure is pathogen-free unless every tiny scrap of it is analyzed in a laboratory first, with negative results. On the other hand, there will always be people, like myself, who conscientiously compost humanure by maintaining a well-managed compost pile, and who feel that their compost has been rendered hygienically safe as a result. A layer of straw covering the finished compost pile, for example, will insulate the pile and help keep the outer surfaces from cooling prematurely. It's common sense, really. The true test comes with living with the thermophilic composting system for long periods of time. I don't know anyone who has done so besides myself, but after fifteen years I've found that the simple system I use works quite well for me. And I don't do anything special or go to any great lengths to make thermophilic compost other than the simple things I've outlined in this book.*

Perhaps Gotaas (*Composting*, 1956, p.101) hits the nail on the head when he says, "*The farm, the garden, or the small village compost operator usually will not be concerned with detailed tests other than those to confirm that the material is safe from a health standpoint, which will be judged from the temperature, and that it is satisfactory for the soil, which will be judged by appearance. The temperature of the compost can be checked by: a) digging into the stack and feeling the temperature of the material; b) feeling the temperature of a rod after insertion into the material; or c) using a thermometer. Digging into the stack will give an approximate idea of the temperature. The material should feel very hot to the hand and be too hot to permit holding the hand in the pile for very long. Steam should emerge from the pile when opened. A metal or wooden rod inserted two feet (.5 m) into the pile for a period of five to ten minutes for metal and 10-15 minutes for wood should be quite hot to the touch, in fact, too hot to hold. These temperature testing techniques are satisfactory for the smaller village and farm composting operations.*" [Emphasis mine.] In other words, humanure composting can remain a simple process achievable by anyone, and need not become a complicated, hi-tech, expensive process controlled and regulated

by nervous, bespectacled academics in white coats bending over your compost pile shaking their heads and wringing their hands while making nerdy clucking sounds.

I want to make it clear though, that I can't be responsible for what other people do with their compost. If someone who reads this book decides that s/he wants to compost humanure, but wants to go about it in an irresponsible manner, then s/he could run into problems. My guess is that the worst thing that could happen is that the person would end up with a mouldered compost pile instead of a thermophilic one (I see this happen a lot), and the remedy to that would be to let the mouldered pile age for a few years before using it agriculturally, or to use the mouldered compost horticulturally instead.

I can't fault someone for being fecophobic, and I believe that fecophobia lies at the root of most of the concerns about composting humanure. What fecophobes may not understand is that those of us who aren't fecophobes understand the human nutrient cycle and the importance of recycling organic refuse materials. We recycle organic refuse because we know it's the right thing to do, and we aren't hampered by irrational fears. We also make compost because we need it for fortifying our food-producing soil, and we consequently exercise a high degree of responsibility when making the compost. It's for our own good.

Then, of course, there's the composter's challenge to fecophobes: *show me a better way to deal with human excrement.*

M: Sounds to me like you have the final word on the topic of humanure.

MS: Hardly. The *Humanure Handbook* is only a tiny beginning in the dialogue about human nutrient recycling.

M: Well sir, this is starting to get boring and our time is running out so we'll have to wrap up this interview. Besides, I've heard enough talk about the world's most notorious "end" product. So let's focus a little on the end itself, which has now arrived.

MS: And this is it. This is the end?

M: "*This is the end,*" (sung like Jim Morrison). Whatd'ya say folks? [Wild applause, stamping of feet, frenzied whistling, audience members jumping up and down, yanking at their hair, rolls of toilet paper thrown confetti-like through the air, clothes being torn off, cheering and screaming. What's this!?! The audience is charging the stage! The interviewee is being carried out over the heads of the crowd! Hot dang and hallelujah!]

THE END

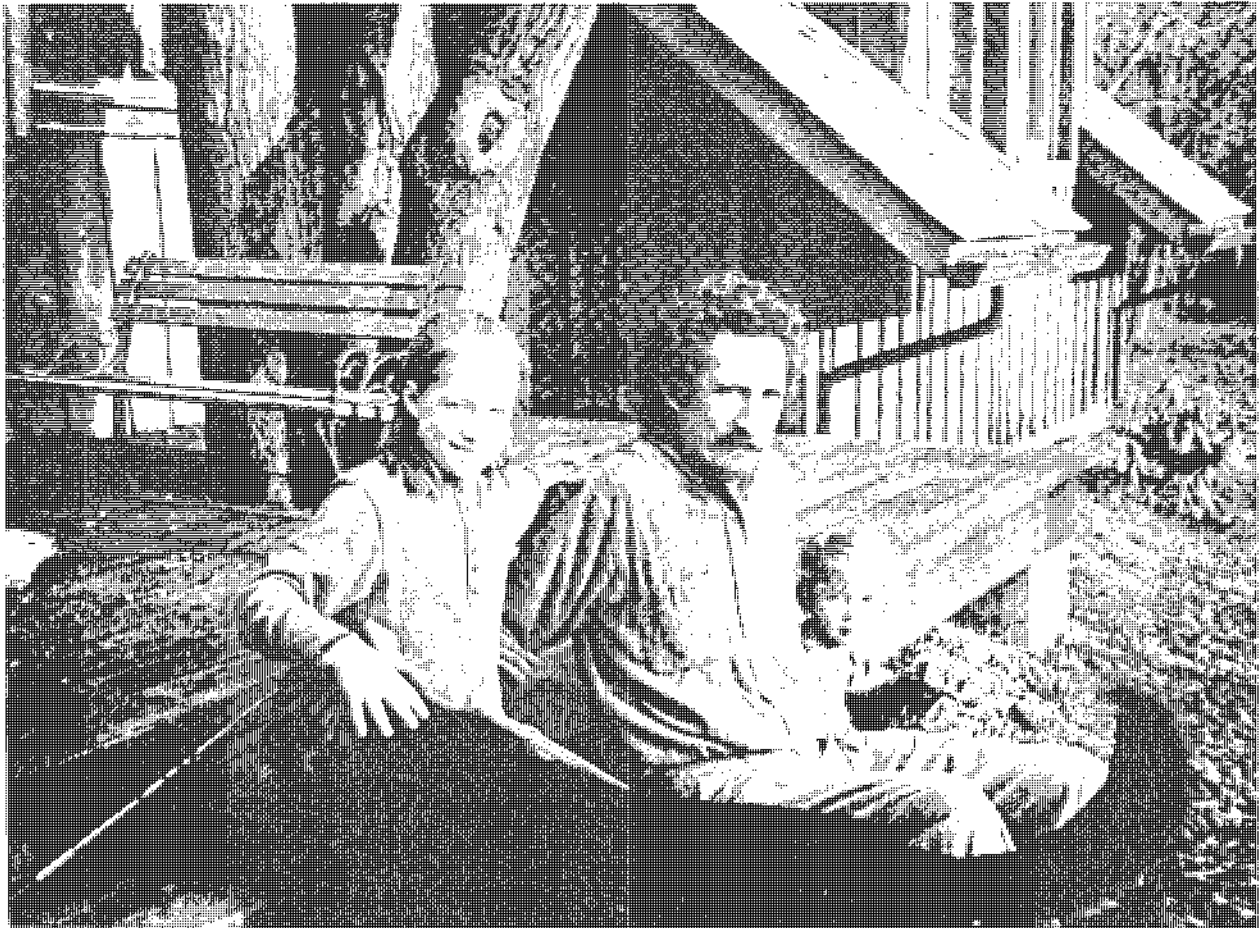

**THE AUTHOR RELAXING AT THE END OF THE DAY WITH TWO
OF HIS CHILDREN (AND A DOG).**

Photo by Jeanine Jenkins

REFERENCES - CHAPTER 8

- 1 - Rybczynski, W. et. al. (1982). Appropriate Technology for Water Supply and Sanitation - Low Cost Technology Options for Sanitation, A State of the Art Review and Annotated Bibliography. World Bank, Geneva. (p. 20).
 - 2 - Johnson, Julie. (1990). "Waste That No One Wants". *New Scientist*. 9/8/90, Vol. 127, Issue 1733. (p.50).
 - 3 - Benedict, Arthur H. et. al. (1988). "Composting Municipal Sludge: A Technology Evaluation". Appendix A. Noyes Data Corporation.
 - 4 - Johnson, Julie. (1990). "Waste That No One Wants". (p. 53) see above.
 - 5 - Simon, Ruth. (1990). "The Whole Earth Compost Pile?" *Forbes*. 5/28/90, Vol. 145, Issue 11. (p. 136).
- * For laboratory analyses of compost contact Woods End Research Laboratory, Inc., Old Rome Road, Rt. #2, Box 1850, Mt. Vernon, Maine 04352; Phone: (207) 293-2457.



Appendix 1: Sources of Compost Thermometers

Real Goods - 966 Mazzoni St., Ukiah, CA 95482-9486 USA, (800)762-7325. [They offer a thermometer with a 20" probe.]

Pinetree Garden Seeds - Box 300, New Gloucester, ME 04260 USA, (207)926-3400. [20" probe.]

The Natural Gardening Co. - 217 San Anselmo Ave., San Anselmo, CA 94960 USA. (707)766-9303. [20" probe.]

Harris Seeds - 60 Saginaw Drive, P.O. Box 22960, Rochester, NY 14692-2960, USA, (716)442-0100. [12 1/2" long probe.]

Johnny's Selected Seeds - Foss Hill Road, Albion, Maine 04910-9731 USA, (207)437-4301. [12" probe.]

W. Atlee Burpee Co. - Warminster, PA 18974 USA, (800)888-1447. [5" probe.]

Edmund Scientific Co. - 101 East Gloucester Pike, Barrington, NJ 08007-1380 USA, (609)547-8880. [8" and 5" probes.]

A. M. Leonard Co. - 241 Fox Dr., P.O. Box 816, Piqua, Ohio 45356 USA. (800)543-8955. [13 1/2" probe.]

Appendix 2: Table of Linear Measures

1 meter =39.37 inches =3.2808 feet

1 foot (12 inches) =0.3048 meter

1 centimeter =1/100 (or 10^{-2}) meters =0.3937 inch

1 millimeter =1/1000 (10^{-3}) meters =0.03937 inch

1 micrometer =1/1,000,000 (10^{-6}) meters

1 mil =001 inch =0.0254 millimeters

1 inch =2.54 centimeters

1 yard (3 feet) =0.9144 meter

Appendix 3: Temperature Conversions

Fahrenheit	Celsius	F°	C°	Celsius	Fahrenheit
-40.....	-40	150	65.55	0	32.00°
-30.....	-34.44	140	60.00	5	41.00°
-20.....	-28.88	130	54.44	10	50.00°
-10.....	-23.33	120	48.8	15	59.00°
0.....	-17.77	110	43.33	20	68.00°
5.....	-15.00	100	37.77	25	77.00°
10.....	-12.22	90	32.22	30	86.00°
15.....	-9.44	80	26.66	35	95.00°
20.....	-6.66	70	21.11	40	104.00°
25.....	-3.88	60	15.55	45	113.00°
30.....	-1.11	50	10.00	50	122.00°
35.....	1.66	40	4.44	55	131.00°
40.....	4.44	30	-1.11	60	140.00°
45.....	7.22	20	-6.66	65	149.00°
50.....	10.00			70	158.00°
55.....	12.77			75	167.00°
60.....	15.55			80	176.00°
65.....	18.33			85	185.00°
70.....	21.11			90	194.00°
75.....	23.88			95	203.00°
80.....	26.66			100	212.00°
85.....	29.44				
90.....	32.22				
95.....	35.00				
98.6.....	36.99				
100.....	37.77				
105.....	40.55				
110.....	43.33				
115.....	46.11				
120.....	48.88				
125.....	51.66				
130.....	54.44				
135.....	57.22				
140.....	60.00				
145.....	62.77				
150.....	65.55				
155.....	68.33				
160.....	71.11				
165.....	73.88				

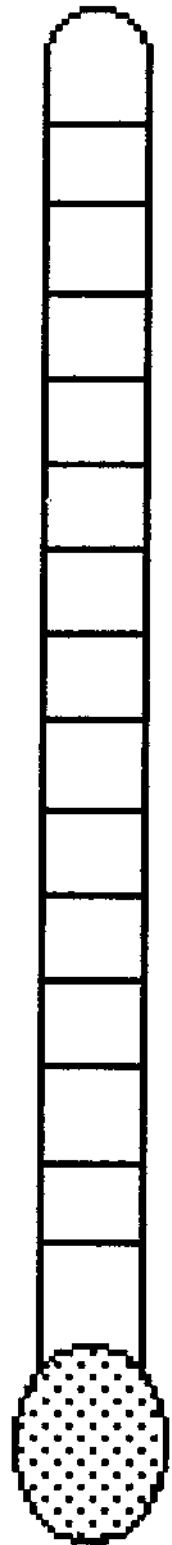

$$F = \frac{9}{5} C + 32$$

APPENDIX 4

Temperature Curve of Humanure Compost After Spring Thaw

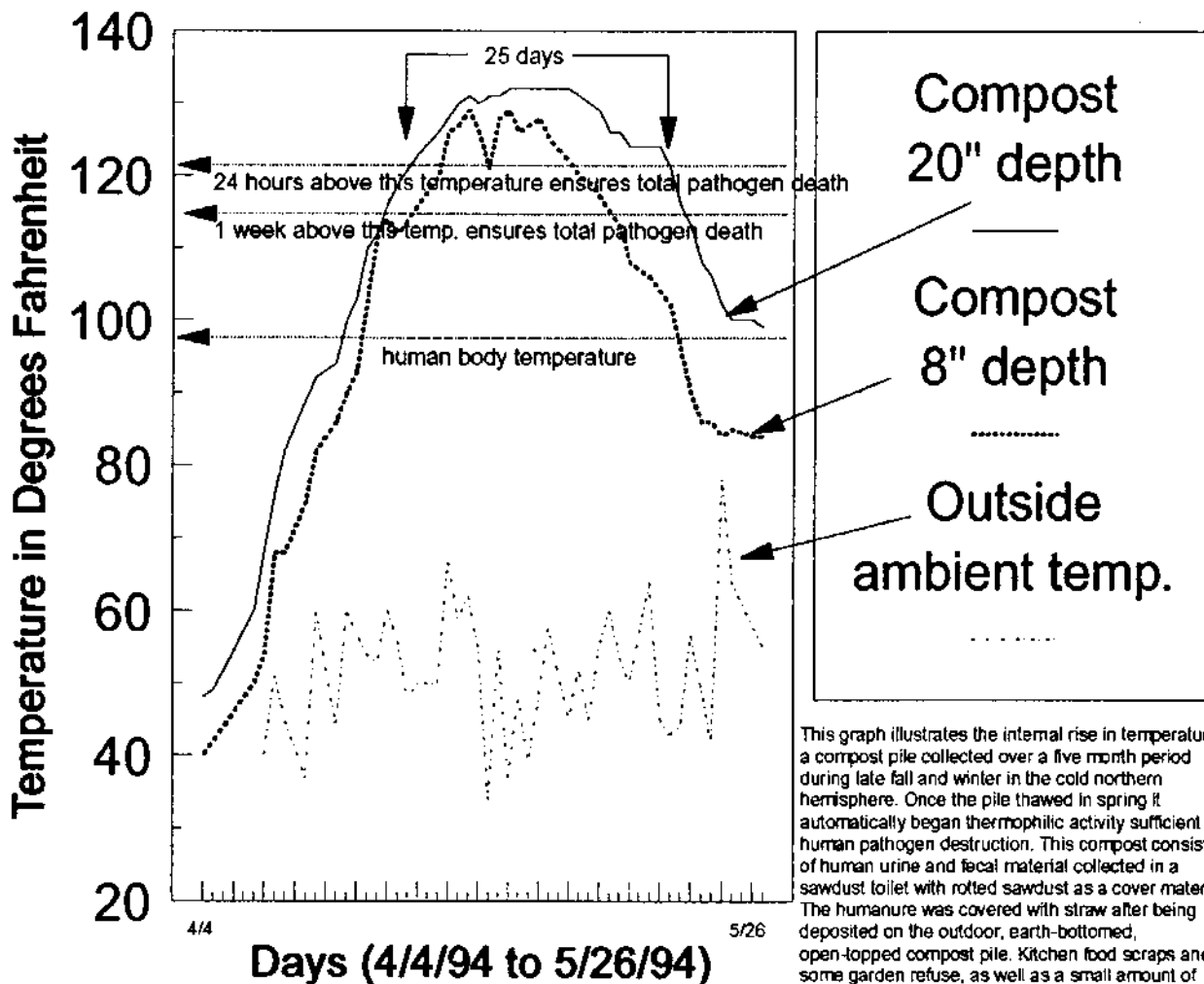

This graph illustrates the internal rise in temperature of a compost pile collected over a five month period during late fall and winter in the cold northern hemisphere. Once the pile thawed in spring it automatically began thermophilic activity sufficient for human pathogen destruction. This compost consisted of human urine and fecal material collected in a sawdust toilet with rotted sawdust as a cover material. The humanure was covered with straw after being deposited on the outdoor, earth-bottomed, open-topped compost pile. Kitchen food scraps and some garden refuse, as well as a small amount of chicken manure were also added to this compost. This pile was not turned or manually aerated in any way. No compost starters whatsoever were used.

The above graph provides an illustration that human fecal material and urine when collected in a sawdust toilet and layered on an outdoor, earth-bottomed, wooden compost bin open to the rain, covered with straw and additional food scraps, a small amount of garden refuse, and a small amount of chicken manure, will undergo thermophilic composting automatically, even after being frozen for months. No turning is necessary, although the pile should be covered with a layer of insulating material after it has thawed, such as straw, animal manures, or earth, to hold in heat. According to Gotaas (*Composting*, 1956, p. 20), disease causing bacteria are unable to survive temperatures of 55-60 degrees C (130-140F) for longer than thirty minutes to one hour. Dr. T. Gibson (*Complete Book of Composting*, J. I. Rodale, 1960, p. 650) states, "All the evidence shows that a few hours at 120 degrees Fahrenheit [approx. 50C] would eliminate [disease causing microorganisms] completely. There should be a wide margin of safety if that temperature were maintained for 24 hours." Franceys, et. al. (*A Guide to the Development of On-site Sanitation*, 1992, p.214) state, "All fecal [pathogenic] microorganisms, including enteric viruses and roundworm eggs, will die if the temperature exceeds 46 degrees C [115F] for one week. Fly eggs, larvae and pupae are also killed at these temperatures." According to Feachem, et. al. (*Appropriate Technology for Water Supply and Sanitation*, 1980), complete pathogen destruction is guaranteed by arriving at a temperature of 62 degrees C [144F] for one hour, 50 degrees C [122F] for one day, 46 degrees C [115F] for one week, or 43 degrees C [110 F] for one month. Westerberg and Wiley (*Applied Microbiology*, December, 1969) found that three days at 116 to 130 degrees Fahrenheit killed all of the polio virus, salmonella, roundworm eggs and *Candida albicans* in infected compost.

THE HUMANURE HANDBOOK PRODUCTION STAFF



GLOSSARY OF TERMS

activated sludge

Sewage sludge that is treated by forcing air through it in order to activate the beneficial microbial populations resident in the sludge.

aerobic

Able to live, grow, or take place only where free oxygen is present, such as *aerobic* bacteria.

anaerobic

Able to live and grow where there is no oxygen.

Ascaris

A genus of round-worm parasitic to humans.

bacteria

One-celled microscopic organisms. Some are capable of causing disease in humans, others are capable of elevating

the temperature of a pile of decomposing refuse sufficiently to destroy human pathogens.

carbonaceous

Consisting of or containing carbon.

C/N ratio

The ratio of carbon to nitrogen in an organic material.

combined sewers

Sewers that collect both sewage and rain water runoff.

compost

A mixture of decomposing vegetable refuse, manure, etc., for fertilizing and conditioning soil.

continuous composting

A system of composting in which organic refuse material is continuously or daily added to the

compost bin or pit.

cryptosporidia

A pathogenic protozoa which causes diarrhea in humans.

enteric

Intestinal

fecophobia

Fear of fecal material, especially in regard to the use of human fecal material for agricultural purposes.

green manure

Vegetation grown to be used as fertilizer for the soil, either by direct application of the vegetation to the soil, by composting it before soil application, or by the leguminous fixing of nitrogen in the root nodules of the vegetation.

heavy metal

Metals such as gold, platinum, lead, mercury, cadmium, etc., having more than five times the weight of water. Some heavy metals, when unnaturally concentrated in the environment, pose a significant health risk to humans.

helminth

A worm or worm-like animal, especially parasitic worms of the human digestive system, such as the roundworm or hookworm.

human nutrient cycle

The endlessly repeating cyclical movement of nutrients from soil to plants and animals, to humans, and back to soil.

humanure

Human feces and urine used for agriculture purposes.

humus

A dark, loamy, organic material resulting from the decay of plant and animal refuse.

hygiene

Sanitary practices, cleanliness.

indicator pathogen

A pathogen whose occurrence serves as evidence that certain environmental conditions, such as pollution, exist.

latrine

A toilet, often for the use of a large number of people.

macroorganism

An organism which, unlike a microorganism, can be seen by the naked eye, such as an earthworm.

mesophile

Microorganisms which thrive at medium temperatures (20-37C or 68-98.6F).

metric ton

A measure of weight equal to 1,000 kilograms or 2,204.62 pounds.

microhusbandry

The cultivation of microscopic organisms for the purpose of benefiting humanity, such as in the production of fermented foods, or in the decomposition of organic refuse materials.

moulder (also molder)

To slowly decay, generally at temperatures below that of the human body.

mulch

Organic material such as leaves or straw spread on the ground around plants to hold in moisture, smother weeds, and feed the soil.

naturalchemy

The transformation of seemingly value-

less materials into materials of high value using only natural processes, such as the conversion of humanure into humus by means of microbial activity.

night soil

Human excrement used raw as a soil fertilizer.

nitrates

A salt or ester of nitric acid, such as potassium nitrate or sodium nitrate, both used as fertilizers, and which show up in water supplies as pollution.

organic

Referring to a material from an animal or vegetable source, such as refuse in the form of manure or food scraps; also a form of agriculture which employs fertilizers and soil conditioners that are primarily derived from animal or vegetable

sources as opposed to mineral or petrochemical sources.

pathogen

A disease-causing microorganism.

pH

A symbol for the degree of acidity or alkalinity in a solution, ranging in value from 1 to 14, below 7 is acidic, above 7 is alkaline, 7 is neutral.

pit latrine

A latrine consisting of a hole or pit in the ground, into which human excrement is deposited. Known as an outhouse or privy when sheltered by a small building.

protozoa

Tiny, mostly microscopic animals each consisting of a single cell or a group of more or less identical cells, and living primarily in water. Some are human

pathogens.

psychrophile

Microorganism which thrives at low temperatures [as low as -10°C (14°F), but optimally above 20°C (68°F)]

schistosome

Any of a genus of flukes that live as parasites in the blood vessels of mammals, including humans.

septic

Causing or resulting from putrefaction (foul-smelling decomposition).

shigella

Rod shaped bacteria, certain species of which cause dysentery.

sludge

The heavy sediment in a sewage or septic tank.

sustainable

Able to be continued

indefinitely without a significant negative impact on the environment or its inhabitants.

thermophilic

Characterized by having an affinity for high temperatures, or for being able to generate high temperatures, such as in regard to thermophilic microorganisms.

virus

Any of a group of submicroscopic pathogens which multiply only in connection with living cells.

waste

A substance or material with no inherent value or usefulness, or a substance or material discarded despite its inherent value or usefulness.

wastewater

Water discarded as

waste, often polluted with human excrements or other human pollutants, and discharged into any of various wastewater treatment systems, if not directly into the environment.

Western

Of or pertaining to the Western hemisphere (which includes North and South America and Europe) or its human inhabitants.

I N D E X**a**

- acid precipitation, 22
- activated sludge, 72-73, 189
- adenovirus, 113
- AlasCan toilet, 107
- aquaculture, 25
- Ascaris lumbricoides*, (see also roundworm, pathogenic worms) 89-90, 105, 114-116, 131, 161, 189
 - Survival in soil, 123, 132
 - Viability of eggs, 116, 118

b

- bacteria, 32, 33, 113, 189
 - Aerobic, 37, 141, 189
 - Anaerobic, 37, 189
 - Fecal, 113-114
 - Indicator, 117, 118, 121
 - Survival in humanure, 122
 - Survival in soil, 118, 120
 - Survival on crops, 118
 - Thermophilic, 138
- BHT, 45
- bins, 36, 99, 148, 157
 - Three-chambered, 159
- biobins, in Germany, 179
- bioregionalism, 140
- Black Death, 59
- BOTVIP latrine, 67
- Brown, Lester, 22
- Buddhism, 56

c

- camp composter, 168, 171
- carbon dioxide, atmospheric, 21
- carbon/nitrogen ratio, 38, 40, 87
 - and Nitrogen loss, 39
- cartage systems, 157
- Celsius/Fahrenheit conversions, 186
- China, 51, 79, 96, 97, 98, 112, 116, 173
- chloramines, 75
- chlorine, 18, 73-74
- cholera, 59, 61, 114, 127
- Christianity, 58, 59
- circadian rhythm, 163
- Clivus Multrum, 87, 93-95, 107
 - Analysis of finished compost, 95
 - Quantity of compost produced, 93
 - Water conserved by, 93
- C/N ratio, 38, 40, 87, 104, 105, 149, 189
- coliforms
 - Fecal, 117, 118
 - Total, 117
- combined sewers, 72, 189
- compost, 32, 33, 189
 - Aeration, 105, 147
 - Asian, 96-99
 - Benefits of, 32-35
 - Bins, 36, 99, 148, 157
 - Capacity to hold water, 32
 - and Chernobyl, 35
 - Continuous, 104, 140, 142, 148, 160, 189
 - Control of plant diseases, 33, 34
 - Covering, 37, 138, 153, 173
 - Defined, 31, 189
 - and Diesel oil, 34
 - Flat-topped, 37, 166
 - Frozen, 37, 164, 187
 - Heavy metals, 79
 - Laboratory analysis of, 181, 184

Layering, 38
Management of, 104, 152, 166
Materials to avoid in, 45
Moisture content of, 35-37, 146-147
Mouldering, 87, 88-95, 150
Necessities for, 146-149
Nitrogen loss, 39
Oxygen, 104, 105, 147-149
Piling of, 35
Pits, 36, 98, 99
Shrinkage, 44
Temperatures, 37, 89, 98, 125, 131,
133, 145, 164-169, 180-81, 187
Thermometers, 46
Thermophilic, 85, 87, 88, 104, 127, 141,
143-145
Time factor, 131, 133, 163
and TNT, 35
Turning of, 104, 140, 142, 148
and Uranium, 35
Urine in, 105, 146
Watering, 146
composting (see also compost), 24
Active, 85
Aeration, 105, 147
Asian, 96-99
Basement, 103
Bin construction, 99, 148, 157, 159
Cartage systems, 158
Continuous, 104, 140, 142, 148, 160
Experimental, 142
Mouldering, 87, 88-95, 150
and Oxygen, 104, 147-148
Passive, 85, 90, 92
Sources of information, 174
Thermophilic, 85, 87, 88, 104, 112,
127, 131, 138, 141, 143-145
Time factor, 131, 133, 163
composting toilets,
Aerobic, 98-99, 104
Anaerobic, 98, 105
Cartage systems, 158
Low-tech, 100
Pathogen transmission through, 125, 127
Plans for, 107-108

Sawdust toilet, 100, 101, 152, 153, 154,
155, 161, 162, 165, 167, 169, 170
Sources of, 107-108

Confucius, 57
cover material, 87, 92, 101, 138, 146,
148, 153, 173
coxsackievirus, 113
cryptosporidia, 189

d

deforestation, 22
diarrhea, 20, 113, 114
dioxin, 74
disposable diapers, 45
dysentery, 114

e

earthworms, 163
echovirus, 113
Egypt, composting of sludge in, 179
Escherichia coli, 114, 117, 144
Europe
Diseases of the middle ages, 59
extinction of plants and animals, 21

f

Fahm, Lattee, 80
Fahrenheit/Celsius conversions, 186
farmland, loss of, 22
feces and urine
Raw use of, 53, 86, 112, 131
Separation of, 41-42, 86, 91, 147
Weight of, 52
fecophobia, 41, 43, 86, 109, 189
fertilizers
Chemical, 18, 19
Pollution from, 19

Flatt, Hugh, 161
flies, 173
food
 Exports, 51
 Refuse generated by American cities, 15
fossil fuels, 22
fungi, 143, 145, 163
fusarium, 34

g

Germany, municipal composting,
 179
 Biobins, 179
Giardia lamblia, 114
Gibson, Dr. T., 168
global warming, 21-22
Gotaas, 43, 181
greenbelt around Asian cities, 112
green manure, 189
Guatemalan mouldering toilet, 91

h

heavy metals, 71, 77, 79-81, 190
 transmutation, 80
helminths, 113, 190
hepatitis A, 113
hepatitis B, 112
Hinduism, 56
hookworms, 121, 127, 129, 131
Horvath, Joseph C., 79-80
Howard, Sir Albert, 35, 36, 48, 140, 141
human nutrient cycle, 11, 12, 13, 88, 190
humanure, 7, 8, 14, 190
 C/N ratio of, 39
 Composition of, 39
 Dollar value, 16
 Per square mile of arable land, 15
human waste, 7, 14, 21, 24, 25, 53-54
humus, 31, 32, 145, 190
Hunzas, 35, 110

i

India, 99, 140, 142
indicator bacteria, 117, 118
 Survival in humanure, 121
indicator pathogens, 116, 190
Indore process, 140, 141
inks, 46, 50

j

jail fever, 59-60
Japan, 51, 173, 178
Jews, torture of, 59

k

Kervran-Effect, 80
King, Dr. F. H., 52, 173
Korea, 51, 65, 173

l

landfills, 15, 78-79
latrine, 190
 double pit, 161
 (see also Vietnamese double vault)
legalities, 170
Leptospires, 120, 127
lime, 38, 47-48, 140, 142, 162
Lovley, Derek, 35
Lubke, Sigfried, 35

m

macroorganisms, 145, 190
Marino toilet, 42

mesophile, 143, 144, 190
metric conversions, 185
 ton, 190
microwave toilet, 81
microhusbandry, 29, 190
Miquel, 144
moulder, 190
mouldering toilets, 29, 86-95
 Commercial, 86, 92, 95
 Guatemalan, 91
 Non-commercial, 86, 88-90
 Transmission of pathogens through, 125, 127
mulch, 30, 190
Multrum toilet, 92-94
 Transmission of pathogens through, 125, 127

n

Native Americans, 60
naturalchemy, 31, 190
newspapers, 45
night soil, 7, 25, 29, 51, 53, 58, 112, 158, 191
nitrates, 18-19, 123, 191
nitrogen, 52, 95, 162
 loss, 39
Norway, 92

O

odor elimination, 37, 87, 101, 151, 156, 172
oil reserves, 51
organic, 191
organic refuse, 31
outhouse, 66
 Pathogen transfer through, 123
oxygen, 38, 104, 105, 125, 147, 148
ozone, 21

p

Pakistan, 110
parasites (see pathogenic worms)
paratyphoid, 113
pathogen, 191
pathogenic worms, 113, 114-116, 118, 126-131, 161
 Eggs, 116, 118, 131
 Fecal, 114, 115
 Survival in humanure, 122
 Survival in soil, 118, 121
pathogens, 29, 111
 Defined, 87
 Eliminating from humanure, 122
 Indicator, 116
 Persistence in crops and humanure, 117
 Persistence in soil, 118
 Survival in thermophilic compost, 127
pH, 33, 47-48, 162, 191
phosphorous, 19, 53, 95, 162
phytophthora, 34
pinworms, 127, 128
 Eggs in feces, 128
pit latrine, 66, 191
 Ventilated improved, 67
 Pollution from, 66, 68
 Pathogen transfer through, 123
Plague, 59
poliovirus, 113, 120
population growth, 22
Postel, Sandra, 21
potassium, 19, 53, 95, 162
pour flush latrine, 67
pressure treated lumber, 156
protozoa, 113, 191
 Fecal, 114
 Survival in humanure, 122
 Survival in soil, 118, 119
 Survival on crops, 118
psychrophile, 143, 191
pythium, 34

r

recycling, 15
reovirus, 113
Rodale, J. I., 48
Rodale, Robert, 140
rotavirus, 113
roundworm, (see also *Ascaris*, pathogenic worms) 89-90, 98, 105, 121, 127, 130, 131, 161
Rumpelstiltskin, 31

s

Salmonella, 113, 114, 118, 127
sand mound, 69
sanitary napkins, 45
sawdust, 40, 41, 44, 151, 155, 156
sawdust toilet, 100-102, 153, 154, 155, 161, 162, 164-165, 167, 169, 170
Quantity of sawdust required for, 155
Scandinavia, 92
schistosome, 131, 191
septic, defined, 70
septic systems, 68-71, 171
Pollution from, 70
and Population density, 71
septic, 70, 191
septic tank
Capacity, 68
Cross-section, 68
Distribution system, 69
Pathogen transfer through, 123
sewage pollution, 16, 17
Beaches, 16
Ocean dumping, 17-18
sewers, (see also wastewater treatment)
Combined, 72
Pollutants in, 77
Cost comparison to manual collection, 178
shigella, 113, 114, 127, 191
Sides, S., 33

sludge, 73, 191
Activated, 72-73
Agricultural use of, 76-78, 83
Bacteria resistant to antibiotics in, 78
Composting in Egypt, 179
Composting in U.S., 178, 179
Forest disposal of, 78-79
Heavy metals in, 77, 79-80
Incineration of, 81
solar greenhouse wastewater treatment, 76
stool analysis, 116-117, 122, 129, 130, 162-163
Streptococci, 120
Sun Mar toilet, 107
sweating sickness, 59
sustainability, 9, 23, 55, 191
synthetic organic compounds, 70, 71

t

Tao, 57
of Compost, 139, 140
temperature conversions, 186
temperature of compost, 37, 89, 98, 125, 131, 133, 145, 164, 168, 169, 180, 181, 187
Required for pathogen death, 145, 125, 133, 187
Tester, Cecil, 48
thermometer
Compost, 46
Sources of, 185
thermophilic, 192
thermophilic bacteria, 138
In humanure, 144
thermophilic composting, 29, 38, 43-44, 58, 138, 143
Conditions required for, 142
Transfer of pathogens through, 125, 127
thermophilic microorganisms, 143, 144
Number in humanure, 144
time factor in compost, 131, 133, 162-163
toilets (see also multrum, mouldering)
Botvip latrine, 67
Double pit, 161

Guatemalan mouldering toilet, 91
Microwave, 81
Marino, 42
Multrum, 92-94
Outhouses (see pit latrines)
Pit Latrines, 66-68 (see also separate list
-ing)
Pour-flush latrines, 67
Sawdust, 100-102, 153, 154, 155, 161,
162, 164-165, 167, 169, 170
Transmission of pathogens through
composting toilets, 127
Water consumption of, 18
toilet paper, 44, 73
topsoil, 33
Loss, 22, 51
Tsu, Lao, 57
turning of compost, 140, 142, 147, 148
typhoid, 59, 113, 120

U

urine (see also feces/urine)
Pathogens in, 112
In compost, 105, 146

V

vaults, 98
vibrios, 114
Vietnam, 96, 98-99
Vietnamese double vault, 99, 161
viruses, 113, 127, 192
Fecal, 113
Survival in humanure, 121
Survival in soil, 118-120
Survival on crops, 128

W

Ward, Barbara, 80

waste, 7, 21, 192
Reduction, 23, 54
Solid waste generated in U.S., 14, 21, 23
waste stabilization ponds, 124-125
Transmission of pathogens through, 125
wastewater, 192
wastewater treatment plants, 72, 73, 123,
124
and Chlorine, 73
Solar greenhouse, 76
Transfer of pathogens through, 124
water
Consumption, 20
Pollution, deaths from, 20
Testing, 117
wetlands, constructed or artificial, 75, 76
whipworms, 130
White, Andrew D., 59
winemaking, 30-31
witches, 59, 109
wood ashes, 47, 162
Wood's End Laboratory, 46, 135, 184
worms (see pathogenic worms, also
Ascaris lumbricoides, hookworm,
roundworm, whipworm, pinworm,
helminths)

y

yeasts, 32
yersinia, 114
Yucatan, 65

Z

Zen, 57

THE ORGANIC WAY TO MULCHING

**by the Editors of
ORGANIC GARDENING and FARMING**

ROBERT RODALE, Editor

JEROME OLDS, Executive Editor

M. C. GOLDMAN, Managing Editor

MAURICE FRANZ, Managing Editor

Compilation Supervised by

GLENN F. JOHNS

The paper in this book has been made from waste paper that normally winds up at the city dump. This reclaimed paper is an example of how today's wastes can be converted into a worthwhile resource, thereby helping to solve the solid waste disposal crisis and preserving the quality of our environment.

RODALE PRESS, INC.

Emmaus, Pa.

CONTENTS

Introduction: There's More To Mulch Than Meets The Eye! . . .

CHAPTER

1. Mulch— Tool of the Best Doggone Organic Gardeners	1
2. Mulch and Your Soil	14
3. Mulch and Your Garden	34
4. Mulching Materials	52
5. Stone Mulching	81
6. Why We Reject One of the Most Common Mulches	101
7. There's Method in This Mulching	115
Appendix I	138
Appendix II	144
Index	187

Standard Book Number 0-87857-009-8
Library of Congress Catalog Card Number 70-170280
Copyright 1971 by Rodale Press, Inc.
All Rights Reserved
Printed in the United States
OB-50
First Printing 1972

INTRODUCTION

There's More To Mulch Than Meets The Eye!

Mulch is a layer of material, preferably organic material, that is placed on the soil surface to conserve moisture, hold down weeds, and ultimately improve soil structure and fertility.

There's more to mulch than meets the eye. Be it a fluffy blanket of hay, a rich brown carpet of cocoa bean shells, or a mantle of sawdust, that "topping" for the vegetable patch and flower bed serves as much more than frosting on the garden cake.

Mulch acts. It performs in several wondrous ways. It fills a role as protector of the topsoil, conserver of moisture, guardian against weather extremes and comfortable, bruise-saving cushioner under ripening produce. It prevents weed growth while enriching the soil and all but eliminates a lot of those time-consuming, back-aching jobs like plowing and cultivating always consid-

ered necessary for a productive garden.

Another important advantage of mulching is regulating the temperature of the soil. The mulch tends to be an insulator, which means that during many periods of the year it moderates the temperature of the soil beneath. In winter a mulched soil can be warmer than other ground, and in summer it can be cooler.

Mulching around trees prevents competition by grass for moisture and nutrients. Trees, and in fact most plants, need a tremendous amount of moisture during hot weather, especially. If grass and other plants are growing right up to the trunk, they will take the moisture first and leave less for the tree. Mulching is the easiest and most attractive way for the average gardener to keep that from happening.

If you're serious about your garden, you've long ago thrown away your bags of commercial fertilizer and have started to build real productivity into your soil. And the fertility of your soil depends upon how you're able to get humus into it. That's really what mulching is all about.

Most mulching benefits can be obtained by any kind of ground cover—even the plastic sheets which are such a detriment to the welfare of our environment. But when it comes to improving the soil, nothing can do it like an organic mulch—not aluminum foil, not plastic, not polyethylene film. Organic mulches have a plus—they decompose into the essential life-giving elements of a rich, dark humus.

Plants themselves literally demand to be mulched because that's the way they've been able to survive repeated disasters through the ages. Spontaneous mulch-

ing has been going on for a long time—millions of years—by the time man first began to raise a few favored crops about 15,000 years ago.

Snow is not the only mulch that Nature has been using for all those centuries. We also know that leaves cover forest and woodland areas to protect the soil and feed its inhabitants. As the leaves fall to the forest floor, forming the basis of nature's mulch protection, they also decompose into a compost that makes up a rich soil-rebuilding program of nature. Out in the open fields, dead tops and foliage of the annual plants fall over to cover the ground and protect it from the rigors of winter.

This fact is important: composting and mulching go hand-in-hand and are, in many instances inseparable. Remember that in dealing with your soil. The aim is to build and maintain nature's complete soil pattern as far as possible. That demands a good organic mulch. The soil in your garden, whether you know it or not, is a world teaming with living things, whose combined activity enables the soil to grow plants.

In nature's scheme of things, as the dead remains of once living things gradually decompose, they return to the earth to be used again in a continuous cycle of life. Our soil will find itself undergoing conservation much more extensively and will be used more efficiently when we see Nature's pattern of natural mulching with its benefits according to the levels of soil fertility concerned. Mulching alone, as a mechanical ministrations, cannot offset completely the shortage of fertility in the soil. Conversely, building up the fertility can be all the more reason for mulching also, a combination with dou-

bled benefits because of the more efficient use of both the soil and the mulch that covers it. Of course, Mother Nature doesn't till or disturb her soil, except by using earthworms, insects and plant roots.

So, it's pretty apparent today that you're missing out on a lot of good gardening if you don't mulch—and mulch with whatever is cheap and handy. Leaves contain twice as much plant food as barnyard manure—pound for pound. Buckwheat hulls are fine, but so is hay. Sawdust will keep the weeds down and the soil moist, but be sure you add some form of nitrogen if you're going to raise a crop right away.

Our cumulative experience—and we already have well over a quarter of a century of it—and the experience of our readers has taught us to use whatever is cheap and abundant locally, to use it to get practical results and to solve our own gardening problems. We have learned to be our own “experts” and to think for ourselves.

And we've learned to mulch!

So, keep on mulching with whatever comes to hand—leaves, straw, hay, grass clippings, weeds, crop residues. Remember that the more humus you get into your soil, the better the crops you grow—while you're knocking the pesticides and herbicides out of your soil that somebody else put there.

Better break out the organic covering and start mulching—*now!*

Chapter One

MULCH—TOOL of the BEST DOGGONE ORGANIC GARDENERS

Constant correspondence with people who garden the organic way tells us they all agree that mulch is a must—and each for his own reasons. A Michigan gardener discovered it prevents weed takeovers. Another likes the hardiness it gives her plants against storms, while a desert-dweller lauds its ability to retain moisture for his garden.

Harold Fleck, the Michigan resident, found he could leave his garden unattended for periods of time during the summer without adverse effect. His mulch prevented weeds from crowding out his plants.

He was fortunate in that his garden area lay adjoining a field that was combined for clover seed the previous fall. After passing through the combine, the hay lay on the ground over winter. Fleck decided to use this handy supply of material for mulching. Early in the spring the

garden was plowed as usual. Then it was worked with a rotary tiller. As the various seeds were planted, the hay was placed between the rows of planted seeds. When the small seedlings came up, the hay was moved nearer to them. Finally, the whole garden was covered with hay.

"This new type of gardening has restored my once flagging interest in gardening," Fleck said, "The benefits were far more numerous than I had dreamed. The following are a few of the advantages I discovered:

"Neatness. It was always a problem to have a neat borderline between the grass of the lawn and the garden. Mulching solved this. Running the rotary mower right up to the mulch leaves no line of unmowed grass between the grass and the mulch. That narrow line of unmowed grass was always a problem before mulching.

"No drought effects. Although we had some very dry weather last summer our mulched garden did not show the effects of it. Our sweet corn did not 'roll' during the hottest days of the dry-weather period.

"Pests subdued. Before mulching, the beetles would ruin our lima and string beans. Last summer it was different. There were a few beetles, but they were too few to damage our production. No chemicals were used.

"It is wonderful to be able to walk out into the garden without getting dirt and dust in your shoes. The mulch is a soft and clean carpet to walk on. It is also a blessed relief to be free from the battle with weeds."

Fleck's experience also taught him that his mulch offered protection for his plants during bad weather and frost. When he feared an early frost was in the offing, he merely covered his plants with some straw in the

evening, removing it in the morning. But Dorothy Schroeder's experience with mulch as a plant saver was more extensive. Hers involved a heavy storm.

"We should have known that it would happen after a completely rainless spring and early summer," she explained.

"Well, the day arrived when the rain came, a cloud-burst pouring down four inches of water in a little over an hour. It roared down the canyon east of the house in a white curtain, egged on by a 70-mile wind. During the worst of it, hail pelted the garden. Cracking branches of the old cottonwood trees were inaudible in the greater noise of the storm, so that we were surprised to find tree-sized limbs blocking both exits when the tempest stopped," she continued.

"After we had sawed a path through, we found what looked like complete devastation. The corn was flattened to the ground; the beautiful big crisp leaves of the summer squash and zucchini we'd been so proud of were broken and mud covered, soaked into the ground. The tomato supports had been broken or pulled out, and many tomato branches were broken off. Pepper plants were bent in the middle, their blooms stuck in the mud. The crisp green lettuce was reduced to mush.

"The first comfort I found in this devastation was that no water had run off my garden," Mrs. Schroeder said.

"Although our home is on a fairly steep hillside, the rain soaked into the mulch-covered soil while my neighbors's topsoil ran away in brown streams, clogging the drains and making extra work for the street department, and pointing out a valuable lesson. My neighbors

complained that the rain was like the pounding of hammers on their soil; nothing soaked in and the ground was left like asphalt. My soil was cushioned by the mulch and there was no pounding.

“In general I learned from that storm that what seemed like complete devastation could be only a few days’ setback if I moved in quickly”, she continued. “I learned, too, that the plants growing in the best soil, richest in compost and most heavily covered with mulch, suffered least. That was brought home to me by the two potato patches. I planted one in the ‘new’ part of the garden, not yet prepared organically. For the other I used decayed leaf mold, planting the potatoes in a heap of it 18 inches above the level of the garden, between two thick layers. These potato plants weren’t injured at all, but stood straight and tall after the storm. The others were beaten down to the ground,” Mrs. Schroeder said.

“I also learned a lesson from a stone-mulched tomato. I had set the plant in a slight depression in the ground, and instead of staking it I had killed two birds with one stone by piling around it the rocks that I would have otherwise had to cart away, both to mulch it and to keep the branches off the ground. That was the first of the tomatoes to recover, with more of its leaves returning to their former healthy condition than I’d have thought possible. I was surprised, too, at how little the injured leaves affected the fruit bearing. Fruit bore better with their leaves whole, it’s true, but production went on when they were ragged and full of holes,” she explained.

Even more telling, Mrs. Schroeder said, was something that didn’t immediately occur to her. “The roots weren’t hurt at all. That, of course, accounted for the quick recovery of so many of our injured plants.”

Ruth Tirell, a longtime organic gardener from Massachusetts, found through experience that a mulch works its wonders as well in the opposite extreme of weather—drought. Although the drought she experienced was unusually long and severe, no crop was a total loss. But the contrast between the plants that grew in bare, exposed soil and those that had been mulched was revealing. The favored crops which were mulched—tomatoes, summer squash, cucumbers and melons—all flourished and grew as if there were no drought.

The beans were another story. Compared to tomatoes, they have simple requirements—moderately good soil, some extra nourishment like compost in the furrow. She planted beans in late May. A little of the winter mulch was still visible; she didn’t add to it—her beans had always done well enough.

June that year brought scant rain, only sprinkles. While, for various reasons, Mrs. Tirell didn’t have much time for the garden, she did notice that the beans weren’t growing fast. Still, she didn’t water them. At maturity in July, the bean plants were stunted and the yield small, so she pulled them up. Usually her beans go into a second—and sometimes a third—blossoming and bearing.

Beets and carrots planted early in May were another example. Getting some quick growth before the drought

started, they then seemed literally to stand still in the dry, baked, unmulched ground. All she got at harvest time were stunted, tough beets.

By contrast, the tomato patch was lush and green. Under the permanent mulch, the soil actually felt moist. The beans, the beets and carrots had all been planted in the same small garden, got the same treatment as the tomatoes—up to a point. All her crops, when planted, were given compost in the hole or furrow. But to nourish a plant, compost must be made soluble. During that long period when there were practically no rains, only the few crops she had kept mulched were really being fed.

In mid-July Mrs. Tirell made a test planting with summer squash, which she always starts at that time to take over in September when the early-planted crop is pulled up. She has found the new plants bear better fruit. She made two hills, treating both alike at first, digging in plenty of dried manure and compost, soaking the hills thoroughly on the day before and again on planting day.

Sowing the Seneca Buttercrunch hybrid, she left one hill bare but mulched the other with grass clippings. The next day she watered again, lifting the mulch on the second hill. She continued to water until the seeds sprouted at about the same time for both hills.

The mulched hill got no water from then on, except when she added to the mulch, while the bare-soil hill was watered every other day. Despite this neglect, the mulched plant grew faster during a period of practically no rain than the unmulched-but-watered-hill. It matured sooner, was bigger, leafier and more prolific—7 to

8 little squashes forming at one time and growing into healthy, big but tender, maturity. By contrast, the fruit from the unmulched hill were rather small and stringy.

At the height of the drought, about August 1, she made another test planting, this time with lettuce seedlings. While all were dressed with compost and the soil was soaked, half the seedlings were mulched and half were not.

When the unmulched lettuce was watered every day, the encrusted soil had to be broken with a hoe—which meant lots more work—so it would absorb the water. But the mulched lettuce was practically no trouble. Grass clippings were added once or twice, first soaking the old mulch which was dry on top but moist underneath. The unmulched lettuce succeeded—after all the care it had received—but the mulched plants succeeded even more, forming bigger, thicker, and more tender hearts to live up to Buttercrunch's reputation.

Like other organic gardeners, Ruth Tirell had known that mulches conserve moisture, but until that summer of abnormal drought, she hadn't seen with her own eyes the difference mulches do make at harvest time. From now on, she's joining other converts, like Arizona dweller Harold Rawson, and keeping her garden mulched year-round. Rawson joined the corps of converts when he found a combination of composting and mulching to be the best solution to the problem of gardening in a desert.

"Our mulch performs best when moist," Rawson said. "Evaporation cools the soil and plants just as our inexpensive evaporators cool many homes. But the mulch loses its moisture quickly in the desert sun, and

this beneficial effect is lost. I've found that a screen wire held above smaller plants with a simple frame makes an excellent sun filter. The screen also offers considerable protection from the hot winds that blow in from the desert. Its only drawback is that it is not very attractive. Most of our garden takes a needed rest during the summer. Otherwise, we have no problems with our annual beds or the vegetable garden. During the enforced



A mulch of lawn clippings decomposes, converts to humus and enriches soil.

siesta, we thoroughly soak the soil to a depth of two or three feet, and then add compost, spading it in deeply and watering it. Anything that will add humus to the rather sparse earth is used—table scraps, composted crop residues and manure which we also use as a mulch. Thanks to our soil rebuilding program, the rows and beds are alive with earthworms most of the year," he added.

"With this preparation we have magnificent displays of flowers during March, April and May," Rawson continued, "And we do have delicious vegetables during the winter, plus some tomatoes and sweet corn in early summer.

"Growing roses and some shrubs creates perplexing problems here. Considerable composted material is used in the planting hole as a soil conditioner. Plants do very well for a couple years, then trouble starts. The acid reaction is lost as time passes, drainage may be impaired, and the leaves show salt damage. How do we restore healthy soil balance and functioning?

"We apply new mulch in liberal amounts, removing the old and spreading it around the garden," Rawson said. "Then we water deeply to wash the harmful salts down and out of the root zone. Since the bushes need more fertilizers to replace lost nutrients, I add manure and liquid fish solutions.

"When we came here five years ago, I was a bit confused by the problems confronting the desert gardener. While I may still be confused, one thing I'm firm about is this—mulching and composting combined is the surest way to gardening success in this hardpan country."

The grand old lady of mulching is without a doubt Ruth Stout. Ever since she moved to Redding, Connecticut back in 1929, Miss Stout has been dazzling her neighbors with her gardening technique. It's a unique one, because it succeeds despite the fact that she doesn't plow, harrow, spade, hoe, weed or cultivate.

Just what is this gal's secret? Very briefly, it's an over-all year-round mulch, and a thick one at that. Six to eight inches of hay, weeds, paper and garden wastes placed around every flower and vegetable, shrub and tree. It is never turned under, never disturbed; it is, in effect, a constantly decomposing compost pile spread over all the places where rich earth should abound.

"Right under the mulch you'll find earthworms crawling around in the moist earth in the driest weather," she said. "It defeats the drought; it does away with all the heavy work of gardening. And it can improve your garden's appearance.

"Now let's say you want to start a garden in a spot which is now sod, or full of perennial weeds," she explained. "If you mulch it heavily in early fall it will be rotted sufficiently by spring so that you can put in a garden without bothering to plow. It's possible that for small seeds you may have to do a bit of sod-shaking but nothing like what has to be done if one plows sod in spring and then tries to plant.

"For tomatoes, or any other crop which calls for putting in plants instead of seeds, nothing could be simpler," she said. "Pull back the mulch a bit and stick the plant in the ground. And for things grown from seed but which should be thinned to 12 or 18 inches apart, such as the cabbage family—well, you can plant these

in hills, a few seeds in each spot, thinning them later to one plant.

"Onion sets may just be scattered around on last year's mulch, then covered with a few inches of loose hay; by this method you can 'plant' a pound of them in a few minutes, and you may do it, if you like, before the ground thaws. Lettuce seeds, too, will germinate if merely thrown on frozen earth—but not on top of mulch. And this, of course, can't be done if you plow before planting.

"Many people," Miss Stout said, "have discovered that they can lay seed potatoes on last year's mulch, or on the ground or even on sod, cover them with about a foot of loose hay, and later simply pull back the mulch and pick up the new potatoes.

"A few weeds may come through your mulch here and there; this will be because you didn't apply it thickly enough to defeat them. They are easy to pull if you want to take the trouble, but the simplest thing is to just toss a bit of hay on top of them," she said. "And if a row of something needs thinning, this can be done effectively by simply covering the plants you want to get rid of with a little mulch."

There are other benefits, too. She hasn't sprayed her garden for years but hasn't had pest problems. The crows, she said, are nonplussed by the heavy layer of mulch over her corn. And she hasn't used fertilizer for years, either. "After you have mulched for a year to two," she said, "you will need no fertilizer of any kind except perhaps for a little meal (cottonseed, soybean—whatever you can buy) for nitrogen. The rotting mulch supplies all the nourishment your plants should have.

“A word of caution: after your soil has become so nearly perfect because of so much rotting mulch in it, you may be swamped with the quantity of your crops.”

It was just this sort of Ruth Stout warning that got Dorothy Anderson, a Wisconsinite, moving. She decided that if Ruth Stout could garden from her couch, so could she. At any rate, she had nothing to lose by giving it a try.

“In our garden, head lettuce was tennis-ball size; cucumbers, exhausted fending off the cucumber beetles, stretched only to fountain-pen length. And strawberries—well, it might take 50 to fill one English teacup,” Mrs. Anderson explained. But after she and her family started mulching, it seemed that she was merely replacing one evil with another.

“Pleasure driving through the country ceased to exist,” she explained. “My eye spied any spoiled hay within a block of the highway. After hectic dickering with the owner, we loaded the car with mulch. It’s heavy, dirty and scratchy—but what does that matter compared to salvaging two whole bales of spoiled hay?”

“The first two bales spread in the middle of the garden looked as lonesome as a fly in the middle of a duck pond. When we tried to cover our 30-by-80 foot garden with mulch, it suddenly expanded to city-park size.

“Mulching took on the attributes of a nightmare. The garden opened its jaws and gulped down mulch far faster than we could provide it. When we walked down the rows of mulch it snapped, crackled and shrank. When it rained, the mulch became soft and gushy and shrank. When the sun dried it, it shriveled and shrank. Under the winter snow it all but disappeared,” she said.

“In the spring the need for more mulch to cover the garden’s nakedness was renewed. The old nightmare chugged and chased our heels. If Ruth Stout could do it, why couldn’t we? We hauled in sawdust, spoiled hay, more sawdust, marshgrass, wood chips, spoiled hay. We salvaged the cut grass along the roadside. Every leaf that blew in the wind was gathered and added to the mulch. Every blade of grass, every weed, was pounced on for mulch.

“After 5 years of constant mulching my temperature has subsided to normal. I, too, lie on my couch by the window and anticipate the first head of lettuce sprouting a blue ribbon from its leaves, and I picture a new garden cart sturdy enough to haul to the house the 30-pound Blue Hubbard squash,” she continued.

“My anticipation of a beautiful garden has truly been realized. The giant heads of Boston lettuce actually did bring in a blue ribbon. With the drought we’ve had in Wisconsin for the last 7 summers, this would have been impossible without mulching.”

Dorothy spoke for all mulchers when she concluded, “The proof of its value is under the mulch. The earth is soft, moist and full of earthworms (just as Ruth Stout said). I have longed for a garden soil so soft that I could scoop out a trench for seeds with my hands.

“My dream has come true; *the mulch made it possible.*”

Chapter Two

MULCH and YOUR SOIL

Mulching will improve any type of soil, generally speaking. But before using fertilizers you should know something about the make-up of *your* soil.

What kind of soil do you have? That's an easy question to ask, a difficult one to answer. Replies could vary from "hard as a rock" or "a sandy loam with a pH of 6.5" to "a deep soil of podzolic origin."

To some people, soil is nothing more than dirt that's perfectly okay as long as it allows flowers and most of the lawn to grow, and when muddy, doesn't get the house or patio too messed up.

Fortunately, to the majority of us, our soil represents a great deal more than that. Unscientific as it may be, we still regard soil as a living, breathing organism with definite likes and dislikes. It has a personality all its own

—depending upon its past history, treatment and present environment.

In the *Yearbook of Agriculture*, published by the U.S. Department of Agriculture, Roy Simonson writes:

"Soil is related to the earth much as the rind is related to an orange. But this rind of the earth is far less uniform than the rind of an orange. It is deep in some places and shallow in others. It may be red, as soils are in Hawaii, or it may be black, as they are in North Dakota.

"Be it deep or shallow, red or black, sand or clay, the soil is the link between the rock core of the earth and the living things on its surface. It is the foothold for the plants we grow. Therein lies the main reason for our interest in soil.

"Every soil consists of mineral and organic matter, water and air. The proportions vary, but the major components remain the same."

All soils have a profile—a succession of layers in a vertical section down into loose, weathered rock. The individual layers are called horizons. The upper layers of the soil profile, known as the "A" horizon, generally contain the most organic matter, bacteria and fungi, and are darkened as a result. This upper layer is the surface soil with which we are most familiar.

The subsoil, or "B" horizon, lies directly below, and is also markedly weathered but usually contains little or no organic matter. In temperate-region soils, the subsoil layers average between three and four feet deep.

The layers where the subsoil merges into the original soil material is known as the "C" horizon. It's usually

weathered, and the upper portion is about to become a part of the lower subsoil.

Soil is a natural body; its formation depends mostly on climate, living organisms, parent rocks, topography and time. Because of the variations in these five factors, soils in any one region are far from identical.

Although soil composition is complex, regard it—and the entire process of soil formation—as a marvelous work of nature rather than saying: “It’s a mystery to

me, so let’s get on with the actual gardening work.” Once we have the attitude that we *can* learn more about our soils, we’ll be going a long way to finding out its needs, and what should be done to improve it.

Your home grounds probably consist of a lawn, shrubs, trees, flowers and vegetables—all supported by the soil beneath them. The goal is to learn what general type of soil you have, if it has enough of the major nutrient elements and whether it’s acid or alkaline. The answers to these questions will tell you how to plant an effective soil build-up program and what plants will grow best in it.

There are two ways to find out the nutritional deficiencies of the soil. A soil sample may be sent to a commercial laboratory or to a state agricultural experiment station. Or a home testing kit may be acquired and the necessary tests made on the spot.

A home test kit is particularly valuable since it makes periodic testing of the soil practical. Indeed, the more it is used, the less costly it becomes on a per-test cost basis. Most of the kits are simple to use and require no knowledge of chemistry or laboratory procedure. And they’ll quickly reveal the deficiencies of the soil.

All soils are composed of particles varying greatly in size and shape. In order to classify them by texture as well as physical properties, four fundamental soil groups are recognized: gravels, sands, loams and clays. (The last three make up most of the world’s arable lands.)

The sand group includes all soils of which the silt and clay make up less than 20 percent by weight. Its mineral particles are visible to the naked eye and are irregular

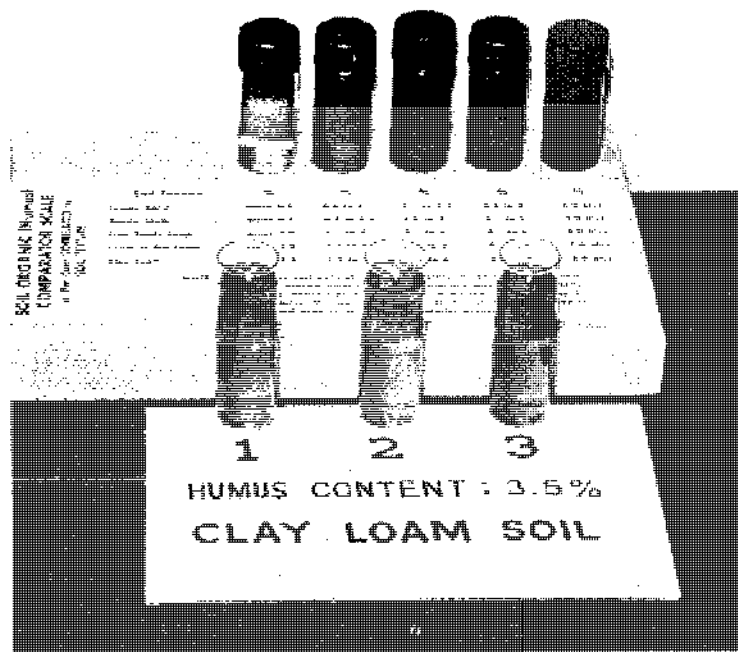

Soil type must be determined according to information provided in kits before the test for humus content is made.

in shape. Because of this, their water-holding capacity is low, but they possess good drainage and aeration and are usually in a loose, friable condition.

In contrast, particles in a clay soil are very fine (invisible under ordinary microscope) and become sticky and cement-like.

Texture of the loam class cannot be as clearly defined, since its mechanical composition is about midway between sand and clay. Professors T. Lyon and Harry Buckman in their excellent book, *The Nature and Properties of Soils*, describe loams “as such a mixture of sand, silt and clay particles as to exhibit light and heavy properties in about equal proportions . . . Because of this intermixture of coarse, medium and fine particles, usually they possess the desirable qualities both of sand and clay without exhibiting those undesirable properties, as extreme looseness and low water capacity on the one hand and stickiness, compactness, and very slow air and water movement on the other.”

Fortunately for the gardeners and farmers in the United States, most soils are in the loam classification. The majority of soils are mixtures; the more common class names appear below: (Combinations are given when one size of particles is evident enough to affect the texture of the loam. For example, a loam in which sand is dominant will be classified as a sandy loam of some kind.)

Sandy Soils

Gravelly sands
Coarse sands

Medium sands
Fine sands
Loamy sands

Loamy Soils

Coarse sandy loams
Medium sandy loams
Fine sandy loams
Silty loams and stony silt loams
Clay loams

Clayey Soils

Stony clays
Gravelly clays
Sandy clays
Silty clays
Clays

You can get a good idea of your soil’s texture and class by merely rubbing it between the thumb and the fingers or in the palm of the hand. Sand particles are gritty; silt has a floury or talcum-powder feel when dry, and is only moderately plastic when moist, while the clayey material is harsh when dry and very plastic and sticky when wet.

Professors Lyon and Buckman observe: “This method is used in all field operations, especially in soil survey, land classification and the like. Accuracy . . . can be acquired by the careful study of known samples.” If you’re interested in developing an ability to classify soils, we suggest your contacting the local

county agent for soil samples that are correctly classified.

While on the subject of soil characteristics, let's take a look at how the structure of your soil influences gardening results. Structure refers to the arrangements or groupings of the soil particles. The two extremes are "single-grained", as loose sand, and "massive", where the soil masses are very large, irregular and featureless.

The ideal structure is granular, where the rounded aggregates (or clusters) of soil lie loosely and readily shake apart. When the granules are especially porous, the term crumb is applied.

How can you change your soil's structure to a granular condition? The answer is clearly given by Lyon and Buckman:

"The major agency in the encouragement of granulation probably is organic matter, especially as it undergoes decay and is synthesized into humus. Not only does it bind but it lightens and expands, making possible the tremendous porosity so characteristic of individual soil crumbs. Plant roots probably promote granulation as much or more by the decay of the distributed organic matter as by the disruptive actions of the root material. The electrochemical properties of humus, no doubt, are fully effective in the organization and the later stabilization of the aggregates.

". . . At the same time organic matter promotes ready air and water movement and, not only does it lower the plasticity and cohesion of the soil mass, but it also localizes the influence of clay, since this constituent seems to be concentrated in the newly formed aggregates. . . . In fact, the granulation of a clay soil cannot

be promoted adequately without the presence of a certain amount of humus. The maintenance of organic matter, therefore, is of great practical concern . . ."

Of course, the two soil experts were speaking chiefly in terms of the physical characteristics of soil. But maintenance of organic matter in soil is beneficial chemically and biologically as well as physically. Soil scientists working for the U.S. Department of Agriculture have tested the effects of organic matter in soil. They tried it on rotation. They tried it on tillage. They tried it on fertility. In every case, they found that organic matter improves the soil and helps plants to grow fat and nutritious.

A number of interesting concepts on the value of organic matter in soil were suggested to the Nebraska Crop Improvement Association by T. M. McCalla, a bacteriologist with the agriculture department's Soil Conservation Service in Lincoln, Nebraska.

McCalla said that organic matter is indispensable to plant growth. However, he said most of our food is produced by plants grown on soils with organic matter in them. And soils with more organic matter in them produce higher yields than soils with less organic matter.

This is about the same as saying that humans don't have to have solid food to live on. We don't! But who wants to live on soup and milk for the rest of their lives, when such things as steak, mashed potatoes, gravy, and fresh fruit are available? And don't you feel like you can do a better day's work when you have a good meal in your stomach? The same way with plants. They have been found to do better when raised on soils with plenty

of organic matter present. Even such plants as tomatoes and gardenias which have been raised on nutrient solutions have been found to do better on a good soil.

Organic matter benefits the soil in numerous ways, McCalla pointed out, through its biological, chemical, and physical effects. One important benefit, he said, comes from its influence on the activities of soil microorganisms which release plant nutrients. Other benefits come from soil nitrogen tied up in organic matter, and the ability of organic matter to stabilize soil structure, increase aggregation, aeration, water-holding capacity, and decrease soil erosion and runoff. All of these increase crop yields.

Soil organic matter, he said, is that part of the soil which originates from plants, animals and microbes. Humus is the dark organic matter of the soil that has undergone decomposition until it can no longer be recognized as the original organic material. Mix any plant residue with soil and it becomes a part of the soil organic matter. When it decomposes it becomes humus.

This is the miracle substance that makes life possible. Without it there would be little or no plant life on earth. Proper use of humus can make soil more fertile, yields more abundant, and foods more nutritious.

One way humus builds up soil and brings abundant yields of healthy, nourishing vegetables and fruits to your dinner table is by making minerals available. Humus does this primarily by chelation, solvation, and storage.

Chelation is the word scientists use to describe the claw-like action of the organic compounds in humus. Some of these compounds stretch out like an earth-

worm. As they swim around in the soil water they come into contact with minerals in rocks. When they do, both ends swing close together and grab hold of the mineral. The claw that is formed is so strong that it can yank an atom of mineral right out of a piece of rock. This gets the mineral out in the open where plants can use it for food. Soil scientists in the University of Illinois' agronomy department have explained that "the availability of plant nutrients may be greatly affected by the chelating ability of organic matter."

They also explained another trick humus has for making soil minerals available to plants. It is called solvation. "During the decomposition of plant residues," the scientists explained, "certain acids, particularly carbonic acid, are formed that dissolve soil minerals and make the nutrients more available to the plant."

One of the most important properties of humus is its ability to store mineral nutrients. Department of Agriculture soil scientists have said that "humus is like a sponge in absorbing water and helps hold mineral elements in the upper soil layers. It is the seat of the greatest microbiological activity and acts as a nutrient reservoir." Agricultural experiments have shown that humus supplies plants with 95 per cent of the nitrogen they need, up to 60 per cent of the phosphorus, up to 80 per cent of the sulphur and similar amounts of other minerals. These minerals are supplied to the plant as the plant needs them for food.

But is it organic matter in itself or its decay that is important to soils?

As soon as organic matter is incorporated with soil

or applied to the surface of it, it is immediately attacked by a host of microbes of every kind and description. These are the microorganisms that cause the organic matter to decay and be dissipated in a short time under normal garden or field conditions. These microorganisms are so active that any average soil is able to handle easily many times the amount of organic matter usually applied to it.



A "packed", mud-pie soil can be made workable with mulch.

Since the microorganisms readily attack the organic matter and soon convert it into humus and other decay products, the question comes up of whether it is desirable to have at least some undecomposed organic matter in the soil. "Yes," is the answer to that. The undecomposed organic matter continues to furnish food for the microorganisms. It also acts as a rough conditioner to open up and aerate the soil. It allows rain to



Soil mulched consistently is well aerated, easily worked and full of nutrients.

soak down into the soil and helps to prevent wind and rain erosion. Hence, it is necessary to keep applying organic matter to soils, regardless of whether they are garden or farmland. And regardless of whether the organic matter is available or not, it is still needed by soil microorganisms.

But what about the benefits other than from the rough organic matter? There is no question about benefits. The principal benefit is the release of plant nutrients caused by the microbial action and the chelating action of the organic matter. Of particular importance are the nitrogen and phosphorous released during the decomposition of the organic matter. These help dissolve minerals in the soil such as phosphorous, potash, calcium, magnesium and other essential plant nutrients. Chelation occurring when decomposing organic matter comes into contact with the minerals in the soil make iron, copper and other metals available to plants.

Since microorganisms are most active during the period of plant growth due to warmer temperatures, essential plant nutrients are also made most available during this period. In other words, the dynamic life of the soil is most active when it is most needed.

Another little considered effect of the decomposition of organic materials in soil is the production of "auximones" and other growth-promoting substances. There is also the production of toxic or antibiotic substances when green manures are added to the soil. Strangely enough, these toxic substances do not harm the growing plants. They appear to help in controlling root-rot and damping-off fungi.

The benefits from organic matter, then, are due

primarily to the activity of the microorganisms which decompose the organic matter and to the products they form. But the organic matter is also important to the chemical composition of the soil.

"Soil organic matter contains the things that plants have taken from the soil, air and water, as well as products resulting from the decomposition of plants and animal materials by soil microorganisms," McCalla noted in his report. "It contains generally about 56 per cent carbon, 5 per cent nitrogen, and oxygen, hydrogen, phosphorus, sulphur, calcium, magnesium, potassium, iron, zinc, manganese, copper and boron. Organic matter also contains numerous organic compounds. A ton of wheat straw will produce about one and one-half tons of carbon dioxide. Decomposition of soil organic matter results in the gradual production of mineral elements in forms that are available to plants. A storehouse of plant nutrients, organic matter is almost a fool-proof fertilizer.

How much organic matter do good farm soils contain? The better farm soils, McCalla said, contain from four to five per cent organic matter. How to maintain this is the big problem. Continuous cropping to cultivated plants reduces the organic matter content of the soil. However, organic matter was maintained at about the same level or higher in experiments by the liberal use of manure, sod crops, and wise crop rotations, McCalla said.

Soil scientists recommend adding a generous supply of organic matter to soil at frequent intervals. This keeps biodynamic activity at its peak. Compost may be added any time. Undecomposed materials such as grass

clippings, leaves, shredded corn stalks, alfalfa, clover and so on are best turned under after the fall harvest. If you do three things—give plants plenty of sunshine, plenty of water and add generous amounts of compost—you will be sure of supplying the basic nutritional requirements of plants. The net result will be a better soil more capable of growing larger crops of more nutritious fruits and vegetables.

But how does mulch fit into the picture?

Well, most obviously, it is a constant supply of organic matter for the soil. As it decomposes, it provides the important microbiological activity. And as it decomposes, it becomes humus.

An important benefit of mulch is its improvement of soil structure and tilth. As the decaying organic matter works down into the soil, it becomes more friable, is better penetrated by water and its aeration is improved, thus stimulating root and biological activity. If organic mulch is mixed into the upper soil layer, it will dilute the soil and usually increase root growth. When mulches such as crushed corn cobs, sphagnum peat moss, or sawdust are used, the effect of the addition of this material to the soil is almost immediate. On clay soils, aeration is increased. Water holding capacity is increased in a sandy soil, an important function of mulch which is often overlooked. A mulch of leaves, grass or dead plant residues cuts down evaporation, helps to hold moisture in the soil and lowers the soil temperature. Sandy soils mulched with grass and leaves in November have shown 2 to 3 per cent more moisture the following May than unmulched soil. While this is a small amount, it is sufficient to make the difference

between good plant growth and little or no growth.

Plant roots extend down into the soil in search of moisture. In so doing, ordinarily, they grow away from the highest concentration of the mineral plant food elements. With a good mulch of organic matter the surface soil is kept moist, promoting the development of feeder roots near the surface of the soil, the zone of highest fertility. The improved moisture condition and increased plant food constituents result in increased vigor and better plant growth. A mulch will prove beneficial on heavy textured soils as well as on light textured ones, but the benefit from improved moisture conditions will be greatest on sandy soils.

Mulches improve and stabilize soil structure or the arrangement of soil articles. Because of the mulch layer, the soil structure is not disturbed by pelting rain, or coarse streams or drops of water from irrigation devices. Some gardeners do not realize that cultivation of the soil when it is too wet destroys good soil structure. When mulches are used, the danger of cultivation at the wrong time is eliminated since very little, if any, cultivation is necessary. Another way to harm the soil structure is walking on the soil when it is wet. If there is a mulch on the soil, this will serve as a cushion and the compaction of the soil is reduced.

If the mulch is not well-decomposed but is a decomposable material, it will promote granulation of soil particles just as Lyon and Buckman said. During decomposition of the organic material, soil microorganisms secrete a sticky material which promotes the granulation of the soil. This is especially true of heavy soil types. Materials like sphagnum peat moss, which

decompose slowly, have little effect on granulation. Straw, hay, fresh leaves, or manure, which decompose rather rapidly, do have an effect on granulation.

A valuable organic matter is formed during the decomposition or rotting of a mulch cover. Decomposition is not an undesirable process, but rather one that recirculates necessary plant food elements for additional crops. In addition to the release of mineral elements such as nitrogen, phosphorus, iron, carbon dioxide and water are released.

All mulch covers do not decompose at the same rate. More resistant substances in the mulch cover, such as lignin, undergo relatively slow change because of their complex nature. Lignin, together with cellulose, forms the chief part of woody tissue. Carbohydrates, such as plant sugars and cellulose, on the other hand, are rapidly attacked yielding carbon dioxide and water. The resistant materials like lignin are not wholly inert nor are they readily identified in the soil. If this were not so, organic mulch would accumulate until ultimately the surface of the earth would be covered by it.

When an organic mulch decomposes, it is similar to a wood fire which dies down from a bright blaze to smoldering embers, glowing for a long time.

The composition of organic matter from different locations is surprisingly uniform despite the wide variations in type of plants and microorganisms that are responsible for its formation. Recent investigations indicate that three classes of compounds dominate soil organic matter. They are substances produced by the alteration of lignin of plants, compounds related to carbohydrates (bacterial gums, slimes and molds) and

material probably derived from proteins. The last is probably the principal carrier of nitrogen.

The lignin of the organic mulch undergoes change when first mixed in the soil. After the initial attack a resistant portion remains that is so greatly altered as not to be properly spoken of as lignin. This portion is usually resistant to further degradation.

The carbohydrate-like materials in an organic mulch are largely substances of microbial origin, as, slimes, gums and organic salts of uronic, teichoic, muramic fulvic and humic acids.

There are, of course, many other benefits derived from mulching. Not all are as complex as those involving chelation and solvation and other processes in the soil. But they are vital to growth of nutritious fruits and vegetables. They are vital to the maintenance of a good, fertile soil. They can be stated briefly.

—Mulching conserves soil moisture by reducing the evaporation of water from the soil.

—Mulching prevents crusting of the soil surface, thus improving absorption and percolation of water to the soil areas where the roots are growing.

—Mulching maintains a more uniform soil temperature by acting as an insulator that keeps the soil warm during cool spells and cooler during the warm months of the year.

—Mulching reduces weed problems when the mulch material itself is weed-free and is applied thickly enough to prevent weed seed germination or smother existing smaller weeds. Mulching thus considerably reduces the time and labor expended in weeding garden areas.

—Mulching adds to the beauty of the landscape by

providing a cover of uniform color which can be neutral or non-detracting and may add an interesting texture to an otherwise drab surface.

—Mulching can prevent fruit and plants from becoming mud-splashed and reduce losses to soil-borne diseases.

—Mulching can prevent freezing injuries caused by late spring or early fall frosts if a light layer of mulch material is placed on top of the plants in the evening and removed in the morning.

It is important to remember that mulching should be done only with natural, organic materials. And for good reason. The soil, basically, is made up of weathered rock particles and organic matter, closely associated and intermixed.

In the organic method of gardening, we attempt to feed the soil so its natural constitution is not disturbed, basing our procedures and techniques on the study of the makeup of the soil. Knowing how it was originally formed, we can better understand what kind of food will suit it.

The soil's basic elements—inorganic minerals from rock fragments, organic matter, water and air—logically lead us to the best formula for its sustenance. If we restore the used-up mineral and organic matter, and if we see to it that there is an adequacy of water and air, the fertility of the soil will continue to maintain itself. The great forests, the huge groves of trees and masses of vegetation which we know exist unaided by man, are all growing within the scope of this simple formula—straight, unadulterated mineral matter, organic matter, water and air. The great redwood trees of the western

coast which tower into the clouds depend on nothing more than these four things.

Therefore, when we mulch the earth with only the elements of which it is naturally constituted, we are not gambling. And since the gardener will soon discover that he can secure a greater harvest of vegetables by following the organic system, he will realize how wrong the chemical method is.

Chapter Three

MULCH and YOUR GARDEN

Mulching will do as much for your garden as it will for your soil, for there are as many benefits of mulching above-ground as there are in-ground.

While the mulch is stimulating and feeding aeration, microbiological activity and granulation in your soil, it will be preserving moisture and soil structure, maintaining a fairly constant temperature, quelling weeds, disease and insects, making your garden something worth looking at and its produce worth eating.

Mrs. Robert Smith of Fort Wayne, Indiana, praises the mulch system. She and her husband, both practitioners of the organic way of gardening, tried the mulch system for the first time several years ago when they were planning a four-week vacation far from the vegetable patch. Mrs. Smith planted the garden to coincide

with their return and thoroughly mulched about three-quarters of the plot.

"My husband was rather disgruntled that I spent money for the mulch," she said, "but on our return he had to admit I had been wise. Needless to say, the area I did not mulch was stunted in growth although there was a great harvest of weeds. The rest of the garden was a veritable jungle of beans, corn, cucumbers, and a dozen other vegetables, with few weeds showing. Our yields were fantastic—the best year we'd ever had in growing a garden!" she continued.

"Later, in talking to my neighbors, they said not one drop of rain had fallen during our month's absence, and they couldn't understand why my garden had survived and was so luxurious and rich in color as well as crops while their gardens either dried up or were badly stunted.

"This year we plan to be gone again for 4 to 5 weeks, so we'll again be mulching heavily and expect a bumper crop waiting our return. It's really been a pleasure gardening organically and seeing our production outdo itself each year," she concluded.

Mrs. Smith's testimonial is typical for the mulch-it-and-virtually-forget-it way of gardening. Ruth Stout has been practicing it for years. And mulching has been around for many more years than Ruth Stout—and that's a lot of years.

The fact that the effects of mulching are seldom simple complicates the search for precise information. Certain patterns of behavior of soils and plants under mulch, however, have been observed in studies conducted in the United States and abroad. These studies

have determined the effects of mulch on the soil, as outlined in the previous chapter. They have determined that mulching affects such gardening conditions as moisture, soil structure, temperature, weed growth, plant disease and insect infestation. Further, mulch can be a factor in the appearance of a garden, although appearance isn't the sort of thing you pin down with a scientific test or study.

Temperature and moisture or a combination of the two frequently appear to be the most critical factors in determining the effect of mulch on crop yield. For Mrs. Smith, for example, the moisture holding qualities of a good mulch were critical not just to a good yield, but to the simple survival of her garden.

Farmers who use mulches generally do because it is the best way to make most efficient use of the available moisture in producing crops. In most cases, the moisture content of the surface soil under mulch is higher than when soil is clean-cultivated.

But where does this moisture come from if—as in Mrs. Smith's case—there is no rainfall for a substantial period of time? The moisture comes from the dew. Dew is the condensation of moisture from the air in the soil. Most of the dew is a complete waste as far as plant growth is concerned—unless there is something on the surface to catch it and prevent it from evaporating. A mulch is a wonderful dew-catcher. A mulch of rocks or wooden boards catches more dew than any other because no air or moisture can pass through it.

While much of the Northeast was enduring its fourth consecutive summer of searing drought several seasons ago, and worried communities began placing more re-

strictions on water use, the helpful role that a mulch can play became increasingly apparent. A notable instance was the attractive Brooklyn Botanical Gardens, where regular irrigation was curtailed completely in the midst of New York's drive to conserve water. Instead, mulching was employed around the many gardens and plantings. The dampness underneath could be felt as well as seen and an increase of earthworms resulted in the soil where areas were mulched.

Experiments in a number of states have shown the efficiency of mulch in holding down evaporation. The amount of moisture savings attributable to reduced evaporation under a straw mulch varied widely with climate and other varying test conditions. In experiments in Tennessee and Michigan, for example, indirect measurements showed that, in humid areas, evaporation losses may be reduced by the use of mulch. The reductions ranged from around 12 or 16 per cent to as much as 50 per cent or more.

Other experiments in North Carolina showed that wheat straw mulch at three tons per acre increased moisture in the soil and markedly increased corn yields during drought conditions. The increases averaged 21 bushels per acre in eight experiments, with a close ratio between corn yields and moisture content of the soil. In 10 experiments conducted under good moisture conditions, mulching did not greatly affect yields.

Similarly with tobacco, there is a close correlation between drought conditions and the effect of mulching on crop yields. Agricultural researchers working in Maryland found that tobacco grown under four to six tons of straw mulch per acre gave yields as good as

those from cultivated fields during five years when rain was normal or less than normal—but crop values were reduced during two years of above normal rainfall.

On land where excess moisture is a problem because of poor drainage and heavy rainfall, mulching could obviously have an adverse effect.

The second most critical factor appears to be temperature. A mulched plant is not subjected to the extremes of temperature that an exposed plant is. Unmulched roots are damaged by the heaving of soil brought on by sudden thaws and frosts. The mulch acts as an insulating blanket, keeping the soil warmer in winter and cooler in summer.

Soil heaving damage, brought on by a winter of sudden, deep freezes alternated with abrupt thaws, should be no threat. Safe under a protective mulch, plants and topsoil can wait out the severest winter weather with an absolute minimum of injury.

The penalty for not mulching can be high at any time. But the advent of winter can bring real trouble to the thinly mulched or unmulched flower beds and vegetable patch. Winter-hardy perennials can be lifted literally out of the ground by frost action and their roots exposed. Wheat plants are frequently completely heaved out of the soil, taprooted legumes such as alfalfa can be badly injured, while entire fall-planted beds of strawberries may be found dead or dying above the ground.

It generally is not known that the type of soil has more to do with soil heaving than the prevailing climate. Sandy soils rarely heave because they are well-drained and the free water is below the three-foot mark—which is as deep as the soil freezes. Soil heaving is not

caused by the expansion of water freezing in the soil but by the formation of more ice from water moving up through the soil.

Heaving occurs when the surface layer of the soil freezes and is pushed upward by pure ice columns of “lenses” which develop just below the layer of frozen earth. The pillars of ice are formed by water that swells upward from below to the lower side of the frozen layer, moving by capillary action through pores or voids in the soil structure.

Control of heaving may not be possible under really severe circumstances, but the place of mulching in maintaining control is nevertheless secure. Good drainage reduces the chances of heaving injury by removing free water near the surface. A good blanket of mulch further reduces the possibility of heaving by controlling the action of the water in the soil—preventing it from alternately freezing and thawing and freezing again.

A good mulch has a similarly tempering effect on the soil's reaction to the change of seasons. It soothes the swing into spring and blunts the first bitter blows of fall and winter weather.

In experiments using mulches on vegetables, researchers of the Pennsylvania State Agricultural Experiment Station concluded that reduced temperatures under mulches in the early spring might partly explain smaller early yields and greater total yields in midsummer when lower soil temperatures would have a favorable result. The mulch tempers day-to-day temperature changes and even the rise and fall of the temperature in the course of the day.

There are a number of factors which enter into the

mulch's ability to temper temperature, one of which is the color of the mulch material. Light-colored materials tend to reflect heat rays while dark-colored mulches tend to absorb them.

This was brought out in a Kansas study which showed that the darkening of a straw mulch by humification influenced the effect the mulch had on the soil's summer temperature. Under a light-colored, fresh mulch the soil temperature was 2.8° C. lower than in bare soil, while soil under a dark gray, partially decomposed mulch was only 0.2° C. lower than bare soil. Reflection from the fresh, light-colored mulch was about three times as great as from the dark, partially decomposed mulch: 32 candles of light per square foot as compared to 11 candles.

To a degree, the moisture preserving and temperature controlling characteristics of mulches are tied to their ability to maintain good soil structure. A mulch prevents—largely by preserving the moisture in the ground—crusting of the earth. A crusted earth is more subject to erosion by wind and rain and is less capable of absorbing the moisture of a brief shower. Indeed, such showers even contribute to the crusting of the earth by compacting it.

Mulches protect the soil from the direct impact of rainfall. Raindrops fall with tremendous force. When this force strikes on bare ground, much of the energy is expended by breaking up soil aggregates and sealing and compacting the surface soil. This decreases the infiltration capacity of the soil and increases runoff and erosion. By breaking the force and size of the falling

raindrops, surface mulches maintain soil porosity and conserve soil and water.

The preservation of porosity was demonstrated in U. S. Department of Agriculture tests in Ohio. The results of the tests indicated that the greater penetration of water generally occurring in mulched soils was primarily due to the protection that the cover affords to an existing favorable soil structure. But when the soil wasn't permeable to begin with, putting mulch on the surface did not cause the water to penetrate. After cultivating the soil to a one-inch depth to break surface crust, however, the infiltration rate under mulching after 60 minutes was 2.10 inches an hour as compared to 0.28 inches an hour on similar unmulched plots.

Similarly, the value of mulches in controlling erosion is widely recognized and has been test proven. Mulches do this by reducing runoff, by maintaining the porosity of the soil and by providing conditions favorable to the activity of organisms which can result in more stable soil aggregates. These all interrelate and all contribute to the soil-saving effect of the mulch.

The extent of this effect has been measured in numerous studies. In Illinois tests, for example, soil losses after an hour's rain of 1-3/4 inches were 3,225 pounds per acre from bare ground as compared to 205 pounds from ground mulched with cornstalks.

In studies recently conducted in cooperation with the Georgia Agricultural Experiment Station, researchers found that a mulch of pine needles, straw, or any other cheap mulching material applied at the rate of around two tons per acre could be used successfully to prevent

erosion on steep road banks until a cover of vegetation could be established. The chief landscape architect for the Ohio Department of Highways has said that mulch is a primary part of his state's successful seeding operation. He said that straw mulch was first used on highway seeding to protect sloping areas from erosion. Its use has been continued because the straw successfully extended the seeding season. As a result, seeding is done at any time of the year that a proper seed bed can be secured. Usually a thicker amount of straw is required if the project is to go through a dormant seeding period, he noted.



Soybeans on the right, grown with an oat straw mulch, are almost weed-free, in marked contrast to unmulched beans at left.

Public Works magazine observed that "the best thinking has found that mulch is of great benefit because it reduces erosion; it reduces the force of rain-drops; it reduces evaporation; it keeps the seed bed loose and at a more even soil temperature; and it eventually adds organic matter to the soil. Mulch shades the seedlings, allowing some sunlight to penetrate and air to circulate, and it encourages and hastens native growth in areas that have not been seeded."

But there's even more of a case for mulching than that, because mulching protects plants from weeds, insects and soil-borne diseases.

Ruth Stout is most outspoken on the value of mulches for weed-control. In her recent book *The Ruth Stout No-Work Garden Book*, she explained why mulches are good for controlling weed growth.

"If the mulch is thick enough, the weeds can't come through," she wrote. "When I say this, people then invariably ask why it is that the vegetable seeds come through and weed seeds don't; this is because heavy mulch is on top of the latter, but not the former . . .

"A few weeds may come through your mulch here and there; this will be because you didn't apply it thickly enough to defeat them," she continued. "They are easy to pull if you want to take the trouble, but the simplest thing is to just toss a bit of hay on top of them."

A good mulch will also deter garden pests. Ruth Stout has reported that corn-hungry crows are "non-plussed" by her mulch. She and other mulchers, like Harold Fleck, have lauded the freedom from insects that a thick mulch brings. "Before mulching", Fleck said, "the beetles would ruin our lima and string beans.

Last summer it was different." He had mulched for the first time. "There were a few beetles, but they were too few to damage our production."

Or as Ruth Stout puts it, "I haven't sprayed for 18 years and have no bug problems at all except for a few Japanese beetles which go for soybeans and raspberries. No bean beetles, no aphids, not a potato bug, no corn worms."

Plants, fruits and vegetables are also protected from soil-borne diseases. Mud is less of a problem when walking on mulched rows. Low-growing plants aren't splashed with mud. Free from this, they are also apt to be free from diseases that mud splashed on them might carry.

At harvest time, vegetables which sprawl on the ground, such as cucumbers, squash or strawberries, often become mildewed, moldy or even develop rot. A mulch prevents this damage by keeping the vegetables clean and dry.

Tests have shown that mulches sometimes support microbiological life which fights organisms deleterious to plants. Several scientists made a study of a lemon grove which almost quadrupled its yield after being mulched with wood shavings.

Since healthy root systems are associated with high citrus yields, they tried to determine what factors were involved in bringing about such an improved yield. Their approach to the problem included a study of the soil flora to determine whether there was a build-up in the mulch of some organism known to be antagonistic or parasitic to citrus root pathogens.

They found there was a fungus in the wood shavings

that parasitized two other fungi, which together or separately can cause citrus root rot, crown rot and fruit rot. Following this lead, repeated attempts were made to recover the harmful fungi from roots and soil in this mulched grove. Although the grove had a history of brown rot, the fungus was difficult to locate, indicating that it did not prosper there.

During this study of the flora in the shavings mulch, the researchers encountered other fungi which were capturing, killing and digesting free-living nematodes. Since citrus nematodes are a serious problem in many groves, the men tried to determine if these helpful fungi were capable of attacking the citrus nematode. They found that the fungi, when grown in culture and fed the larvae of the citrus nematode, readily captured and killed these root parasites.

Studies like this one have demonstrated time and again the disease fighting qualities of mulches. But a tree, shrub or plant won't get sick in the first place if it is vigorously healthy. It is most susceptible to disease when it is poorly nourished and lacking in vigor.

Avid organic orchardist Alden Stahr has demonstrated this by saving nine of the last 10 orchards he's dealt with. Stahr has moved from farm to farm, and at many of his different homes he's struggled "with remnants of old orchards, given up in past seasons as being past bearing age. But because of sentimentality, or from sheer determination," he said, "I experimented with the old trees until at last I came upon what I believe is a fountain of youth for fruit trees."

He found his discovery was similar to that of researchers at the Beltsville (Md.) Agriculture Plant In-

dustry Station of the Department of Agriculture. In experiments there, 18-year-old apple trees with injured roots and in very poor condition made a phenomenal recovery after being mulched for two to three years with nitrogen-rich orchard hay grass.

Each tree received about 20 pounds of air dried hay, applied in June, which provided sufficient mulch to extend a foot or two beyond the spread of the branches and was about six inches in depth after being packed down by rain. No supplementary fertilizer of any kind was added to the hay-mulched trees.

High nitrogen hay mulches decompose rapidly, releasing nutrients to the roots and carbohydrates to the soil. Under these mulches, many tree roots grow in immediate contact with the decomposing hay and receive a continuous supply of nutrients. This is a dynamic process and although the mulch almost disappears each year the desirable changes have been effected.

Improvement in growth and foliage color in the Beltsville experiment was evident the year after the first application was made. Marked improvement was evident the second season; and during the third growing season after the experiment's beginning, the trees were outstandingly vigorous and productive. Unmulched trees in the same orchard location remained in poor vigor irrespective of fertilizer treatment. Trees receiving supplementary nitrogen in quantity equivalent to that supplied by the orchard grass were more vigorous than unmulched trees, but in no instance did they compare in vigor with those mulched with high-nitrogen orchard grass hay. The response to hay mulch was characterized

by luxuriant dark green foliage, increased terminal and spur growths, and heavy set of fruit.

"In conjunction with our studies on tree response," the Beltsville researchers noted, "chemical analyses were made to determine the rate and total amount of the various nutrient elements released by the orchard grass mulch during the process of decomposition. These analyses showed that this mulch will provide a complete supply of nutrients for ideal growth and production, if the nitrogen content of the hay is relatively high and the rainfall adequate for decomposition and extraction."

They were orchards that were saved, but they could easily have been rose gardens or vegetable patches. Mulching makes the difference.

But mulches are more than practical—they're like frosting on the cake. While they're keeping everything beneath them cool and moist and in the proper structural relationships they're providing taste and visual appeal. Without the frosting, you still have a cake, but it isn't as good as it could be. It doesn't look as good and it doesn't taste as good. So it is with mulches. There are gardens and orchards without them, but they don't look as good as they could. Nor does the produce of unmulched orchards and gardens taste as good as it could.

Several years ago, Lewis Hill tried some experiments in hopes of coming up with a method of producing cultivated raspberries with flavor comparable to wild ones. Initially, he believed that fertilizers and soils were the keys to flavor. The principal experiment lasted several years, Hill said. It consisted, he continued, "of a dozen or so of large established Latham raspberry

clumps, each of which was fertilized or mulched in a different way, to find how the different types of culture affected plant growth, and principally their influence on variances in flavor.

"In the spring, 6 clumps were treated with fertilizer as follows: (a) fresh cow manure, (b) well-age cow and horse manure, (c) finished compost, (d) dirt gathered from maple woods, (e) 5-10-10 chemical fertilizer, (f) liquid chemical fertilizer.

"Six clumps received various mulches: (g) coarse wood chips (maple), (h) sawdust (fir and spruce), (i) old hay, (j) green grass clippings, (k) maple leaves, and (l) paper mulch consisting of ordinary newspapers and magazines. The final clump, (m) received no mulch or fertilizer. None of the plants were irrigated or given additional plant food, organic or otherwise. Soil was ordinary, unimproved field soil not particularly high in humus or fertility," Hill continued.

"Results were quicker than we expected. Even the first summer there was a noticeable difference in fruit flavor, and subsequent years increased it. Since flavor cannot be measured like size or weight, and is only a matter of opinion, we called on numerous customers and visitors to our nursery to sample our berries, and compare flavor. Without knowing the details of our tests, nearly all confirmed our findings.

"The berries grown with fresh manure had a strong taste, and a handful of them together had an unpleasant smell. This was not too surprising. More than once, we had checked out complaints from customers concerning bad-flavored apples, only to find the trees had been planted near their septic tank drains!

"Berries grown with chemical fertilizers, both granular and liquid, had less fragrance, and a flat, duller taste. Well-rotted manure, woods dirt, and compost all had much better flavor and odor; but quite surprisingly ran second, in our opinion, to the mulch-grown ones," he said.

"Since the soil was not especially fertile, the quicker-rotting mulches—hay, grass, maple leaves, and paper—came closest to producing the flavor we were seeking. Soil under these mulches improved in texture much faster than in any of the other treatments, too; though in following years, those with the slower-rotting sawdust and wood chip mulch did well, falling only a little short of the others in producing vigorous plants with highly flavored fruit.

"For uniform comparison in all tests, berries were picked only when completely ripe, and nearly ready to fall off.

"The result? Mulches went on the currants, gooseberries, apples, cherries, plums, strawberries, and the rest of the raspberries. Our compost pile collected mostly garbage from then on; all else went into mulch material—like garden waste on the bottom, better-looking hay on top. Soil tilth improved vastly, staying loose and moist even during the driest part of the summer. All the trees and plants showed impressive increase in growth. Some of the young trees grew nearly twice as much in a year as before mulching, since they kept growing all season, not just after rains. Quality of fruit was much improved, too. Furthermore, now we never feel the large cultivated berries are playing second violin to any wild ones in flavor," he said.

“We found that mulching saves hard work, also. Applying mulch is certainly much easier than making and turning large compost piles, keeping them moist, and later having to work them into the soil. Now we let Nature, her bacteria, and earthworms do the job right on the spot!

“When we started our experiments, we fully expected to prove how compost produces superior flavor in berries. Instead we became convinced that to all the other arguments in favor of garden mulch, another may be added: mulching means better flavor.”

Mulch means better looks, too. A mulch is visually appealing.

Picture a garden section devoted to shrub roses or other flowering perennials. In bare, uncovered soil their appeal is limited to upper levels alone. But add a layer of auburn cocoa bean hulls nestling around them, and a whole new outlook comes into view—a vista of rich color, of eye-pleasing textures and tones. Then, too, a dimension of depth completes the comfortable “carpeted” look. In bloom and out, your plants—and garden—look better right from the ground up.

Or shift the scene to the vegetable patch, where backyard eye-appeal and practical benefits go hand in hand with a cushion of thick hay or straw. Glance over to the fruit trees, which cast a far more attractive spell on the homeground horizon when they’re circled with things like rough-grained bark and wood chips or ringed by a deep bed of crushed rock. And look at plantings set around the foundation of your home; invariably they fit more naturally and invitingly when a layer of pine needles, shells or leaves makes them snug.

Given a variety of mulches to work with, a gardener eager to do some “outdoor decorating” has a tool for being as creative as the fussiest of the indoor breed. At every turn of the yard and garden, mulch can help contrast the shapes and hues of plants or blossoms, highlighting backgrounds and vertical lines, or simply blending neatly with them where desirable. From a distance, the effect of certain mulches can be one that dramatically enhances any size or form of growing area. Up close, they easily perk up the mood of plant sites, transforming drab or detractive ground into handsome settings for every sort of growth.

Best of all, they prepare that handsome setting for some of the best growing you’ve ever seen. For while a mulch is working in the soil, sparking microbiological activity, promoting better aeration and granulation, it’s working atop the soil, too. It’s providing a cover to prevent the sun from baking out the moisture, creating a crust and making the land privy to runoff and erosion. It’s preventing the growth of weeds and other ground cover which would compete for the moisture and nutrients in the soil. It’s tempering the temperature, limiting the radical range of temperatures which beset plants.

“There is the secret”, said Alden Stahr. “Mulch will do the trick. Drainage and feeding are important, but mulch is the real fountain of youth.”

Or, as Mrs. Smith put it: “Our yields were fantastic. . . . so we’ll again be mulching heavily . . .”

Chapter 4

MULCHING MATERIALS

When you set out to mulch a home garden of any size, the first thing you ask is, what should I use?

There are almost as many different kinds of mulching materials as there are gardeners to use them. Mulch is a personal thing—if you ask 20 gardeners what their favorite material is and why, you may get 20 different answers. There is no one perfect mulch, but many good materials are suitable for mulching your garden. Perhaps the best way to start is to use what's easily available. There's not much sense spending hard-earned money for exotic mulches if easily found leaves will do the job you want done. Most gardeners solve their own individual gardening problems by using what is cheap and abundant locally and gets practical results for them. They have learned by experimenting to think for themselves.

Take Bob Wandzell, for example. He's a resident of Alaska where growing seasons are short and wet. Wandzell solved his gardening problems by tapping the ocean's resources. Seaweed combined with sawdust brought satisfying results in an otherwise marginal growing area.

Not long after moving to Wrangell, Alaska, Bob yearned for the fresh fruits and vegetables he had enjoyed so much in the continental United States. He decided to start his own garden. Upon checking around, he discovered that others had unsuccessfully attempted to garden in Alaska. They attributed their failure to heavy rainfall, short growing seasons, high-acid soils, non-existent local supplies of animal fertilizers, and high commercial fertilizer costs.

How did Wandzell overcome these problems to become the most successful berry and vegetable grower in southeast Alaska? Well, the first thing he did was to plot his garden on a hill, in hopes the sloped runoff would solve the excess moisture trouble. (Wrangell averages over 150 inches of rain every year.) His first garden did poorly, though—just as others had predicted. But pictures of ripe vegetables on the seed boxes, the sweat spent in preparing the patch, and the sight of weak plants struggling to mature fired up Wandell's determination and whetted his appetite for fresh produce.

The moisture problem licked, he tackled the soil deficiencies. There were no barnyard animals around Wrangell, so manure was out. He tried several commercial fertilizers without success. Then he thought waste materials from the fish canneries might do the job, but the canneries seemed to have a can for everything the

fish had to offer, and there was no waste.

Finally one spring, lacking anything else to try, Wandzell mixed some seaweed—found on the beach across the street from the garden—in with his soil and planted strawberries. Late that summer the family enjoyed their fill of fresh strawberries. For some reason unknown to him, the seaweed had given the soil what it needed.

He collected five soil samples from around the garden—one of which had a high seaweed content—and sent them to the Alaska Division of Agriculture to be tested for fertilizer needs. He soon received word that four of the samples were low in phosphorus and had too high an acid content. The fifth sample, he was informed, contained everything necessary for ordinary gardening!

That fall the Wandzells gathered a large crop of seaweed that had washed ashore above the high-tide mark and dried in the sun. Wet seaweed contains 70 to 80% water—which they didn't need—so they harvested in the fall when dry weed is abundant on the beaches. They stored their ocean "crop" like hay all winter, then added it to the soil in the spring. That summer the Wandzells' garden produced the best vegetables ever grown in Wrangell.

Their rhubarb is first-class evidence of how kelp influences green leafy plants. It grows like it's trying to push back the whole Alaskan rain forest. From one short row Wandzell sold 30 to 40 pounds before the first of June last year, which is something to brag about when one considers Alaska's late springs and short growing seasons.

Even without the seaweed, sawdust makes real good

mulch, if that's what is cheap and abundant locally. Such was the case for Morton Binder. He estimated the cost of manure, peat or beanstraw and mixed the wholesale use of it in his gardening program. But he needed something to aid his rock-hard soil.

Located on a coastal plain, his soil is an extremely compacted, very fine sand over an impervious yellow clay subsoil. When he started on the yard, he began to dig a post-hole and thought he had hit a rock. Even a pick refused to chip off more than bite-sized chunks. He filled the hole with water and the next day had to bail it out to continue digging.

Then he remembered that in a nursery where he had worked a lot of old shavings from the sawdust bins had been used. "A lumber mill is close by," Binder explained. "I went up to look over the situation. There were literally thousands of yards of coarse mill sawdust chips free for the taking. I carried sufficient back with me in a few trips to heap a foot deep over the entire future garden area. The deep surface mulch held the irrigation water without runoff, and within two or three days the fine sand was ready to spade. It took three times over to get a good mix. This could have been done much more simply with a hand tractor, but it was in an inaccessible position," he explained.

The upshot of his labors was a better soil. He said it became "increasingly friable and plants are responding well." He continued, "I ran a pH on the sawdust and found it to be 4.5, or about that of peat moss. In an alkaline soil this would be fine, but in my 5.5–6 soil I had to add lime.

"Weeds pull readily when the soil is mulched with

sawdust. The water bill has been negligible, even though our water rates are high. Humidity is maintained at all times. The ground looks and feels good, and caking is a thing of the past. Cultivation has been reduced to minimum and the angleworms are becoming more prevalent," he said.

"The amount of manure, organic matter, and lime used was no greater than if I had been working with a friable soil in the first place. I estimate my total soil-

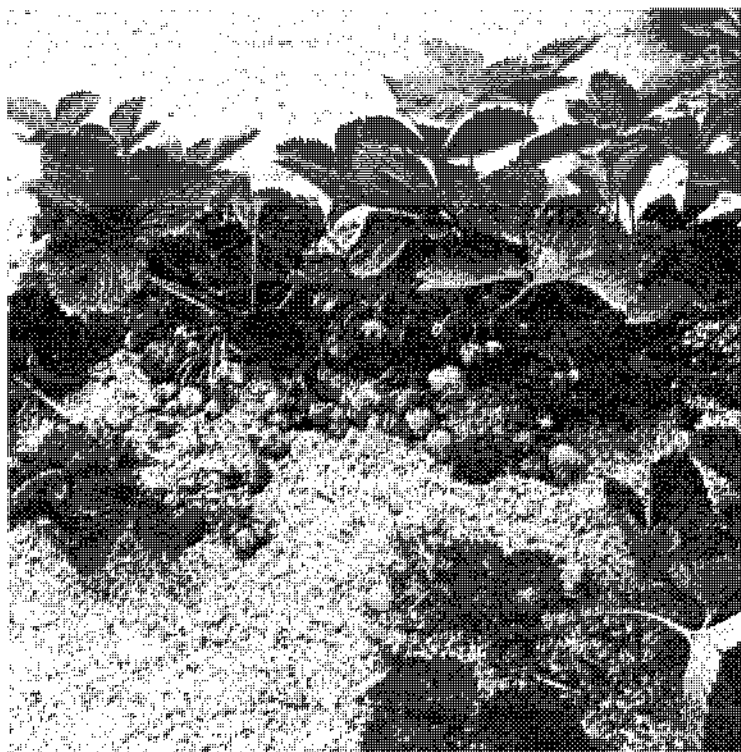

Sawdust, available free from the lumber yard, is one of the most inexpensive soil builders.

building cost at two gallons of gas, although it did take a lot of hard work," he concluded.

Another sawdust mulcher, Mary Leister, reaped similar benefits with a similar outlay. She was able to get sawdust to mulch her garden "at the expenditure only of time and physical effort." Unlike the variety Binder used, however, Mrs. Leister's sawdust was well rotted from having spent 20 years lying in a shady woods.

"This sawdust was," she explained, "moist and very heavy to handle, but its dark color was most pleasing to the eye. Even the lightest of rains seemed to go directly through to the garden soil and very little additional water was needed throughout the summer by the herbaceous annuals and perennials protected by it, nor did they show any overt need for additional fertilizers during the growing season. The vegetable garden grew lushly, and strawberries, raspberries and rhubarb all produced prodigiously surrounded and protected by this sawdust mulch.

"No replenishing of the mulch was necessary from spring to fall," she continued. "Not one garden weed penetrated the three inches of sawdust, and only an amazing few of the broken roots of the creeping woods plants gave rise to new growth that had to be pulled from the loose, unresisting medium.

"On the same July day when the soil beneath the dried grass registered 94 degrees F., that beneath the rotted sawdust registered only 82 degrees. These temperature readings were taken in the same test bed, in the same direct rays of the sun, and within four feet of each other.

"In early November, checking the decomposition

and/or loss of the sawdust, I found approximately two inches of loose mulching material, while the first inch or so of soil immediately beneath was so mixed with the sawdust as to be inseparable one from the other. It was, in effect, a rich, black, moist soil, brought about, probably, by the action of rain water, soil bacteria, and little earth animals," she said.

Mrs. Leister, in the course of her gardening, has had the opportunity to try some other mulch materials. She approached her mulching endeavors with these other materials with the same observant care she applied to her test of rotten sawdust. The others she tried were grass clippings, a material available to anyone with a lawn; shredded pine bark, a commercially-available mulch, and ground cork, a relatively little-used mulch. Each was spread on the Leister garden and "checked for its desirability as a mulch."

"Our lawn, green, healthy and practically devoid of weeds, has always provided a more than abundant supply of clippings to cover, thin layer by thin layer, every bed and border in our garden," she said. The pale gray-green color of the drying grass deepens to brown and is not unpleasant. It readily permits raindrops to penetrate to the soil beneath, while its decomposition enriches the soil, and its shady protection keeps the earth beneath it both cooler and damper than cultivated soil exposed to the elements. On a day in July when the air temperature was 98 degrees F. and the temperature, in direct sunlight, at the surface of the mulch registered 120, the surface of the soil beneath the dried grass mulch was 94 degrees.

"These grass clippings, however, require almost

weekly replenishment in order to keep the mulching depth a preferred 3 inches. This rapid decomposition necessitates the constant addition of organic fertilizers rich in nitrogen, to the soil; and the protected plants, even in a season of fairly normal rainfall, are very often in need of additional moisture. Furthermore, by freeze-up time very little dried grass is ever left for use as a winter mulch," she continued.

"One of the most striking things about shredded pine bark," she explained, "is the woody fragrance that rises when the bark is spread. It is," she said, "so heavenly that the gardener is apt to feel that even if its mulching capabilities are nil it is worth its price in nostril-tingling value alone. But, fortunately for the garden, it is an excellent mulch. Its pine-woods aroma vanishes after a few weeks' exposure to the elements, but its dark color remains pleasing to the eye for at least the two years I have used it," she reported.

"It does not rob the soil of moisture but instead appears to allow every falling drop to penetrate to the earth. Its fine, dusty particles are, of course, quickly absorbed by the soil, but this is such an extremely small percentage of the mulch that its disappearance is scarcely noted, either in the depth of the mulch on the ground or in the bulk recovered if it is raked up for storage during the winter months. The dust absorbed presumably increases, to a slight degree, the acidity of the soil, but does not noticeably increase the demand for nitrogen.

"Possibly because the larger pieces and consequent greater unevenness of the shredded pine bark mulch allow some moisture to escape, but more likely because

the foundation planting suffers from being in the rain shadow of the house, a considerable amount of additional moisture was required by these large evergreens. So, too, the smaller-rooted cuttings in the test bed required a great deal of additional water, but this need not necessarily be laid at the door of the pine bark mulch."

She continued, "When the surface temperature of this mulch was 120 degrees F., the temperature of the soil directly beneath it was 86 degrees, while a temperature of 90 degrees was registered in medium shade with the soil beneath it registering 82 degrees F.

"The other mulching material tested was ground cork—not yet, to my knowledge, on the open market.

"This material was so light and so easy to handle that a 90-pound woman could spread it with ease. It was also so light that I feared the first breeze would blow it across the countryside and that even the moderate force of an ordinary raindrop would dislodge it from place. But I was wrong.

"Scarcely had we spread this mulch when an early-summer thunderstorm raced across the land," she said. "Preceded by violent winds, it let loose a volley of pounding, outsize raindrops, and then sluiced down veritable waterfalls upon the earth. The storm passed, the sun shone, and we went out to view the end of the mulch test that had not yet fairly begun; and there lay the ground cork, smoothly and evenly spread upon the ground, completely unruffled by either wind or water. The cork itself was damp, the ground beneath it soaked, and from that moment through the entire growing season that section of the test garden relied solely on nature for its watering.

"This ground cork is reported, authoritatively, to test one per cent nitrogen, a fairly negligible amount; but its deterioration is so unbelievably slow that it appears almost to be an inert material and its effect for good or ill on the nitrogen content of the soil is not observable except probably by highly scientific testing methods. Measured by bulk, there appears to be exactly as much cork in November as there was in May.

"Well known for its insulating qualities, there should be no surprise that where its surface registered the same 120 degrees F. mentioned before, the temperature of the surface of the soil directly beneath was 82 degrees; and in light shade where the mulch surface showed 94 degrees, the soil beneath showed 78 degrees F.," she said.

"Dry or wet it is completely odorless. Its only drawback—and it is no doubt quibbling to mention it in view of its other excellences—is its pale-tan color which does not enhance the beauty of a planting as a darker color would do."

If a pale tan color is a drawback, you'd never know from listening to hay mulchers. These gardeners spread that pale tan substance over, around and through their gardens with nary a thought that it should be darker to best enhance the garden. For Fred Eaton, for example, hay mulching has too many practical advantages for him to be concerned about whether its color appeals to him. He's been using a hay-mulch for years and finds it a fine labor-saver.

"Make the right start in hay-mulch gardening by making the best choice of the hay itself," he recommended. "*Make every effort to get baled hay.* It's neater, and is much easier to manage than loose hay. It's a

better weed smotherer, and stays in place even in high spring winds.

“Don’t depend on a mulch for a complete soil nutrient provider” he continued. “It’s main value, after decomposition, is as a soil conditioner. It does contain some nutrient value, however, so try to get it organically-grown, if possible. Well-fed hay will return a greater percentage of nutrients to your soil and crops. A rich and early-cut grass hay often contains more nutrient value than a starved clover or alfalfa.

“Before you start to mulch, apply fertilizer in the usual way as you always do. Compost, manures, rock powders, and other organic materials will tend to decompose more quickly under a cooling, moisture-holding hay mulch, so even if you’ve never tried surface fertilizing (or sheet composting) before, don’t be afraid to try it now. We don’t hesitate to use lots of phosphate rock, granite stone meal (good for potash and mineral supply), and a magnesium limestone (only when needed to raise pH.) This general fertilizing program is far from scientific, but it works wonders with plants, probably because, unlike chemicals, it is ‘nature-balanced’ in its original form. All the many trace minerals lacking in straight chemical formulas are present in almost every organic and rock fertilizer,” Eaton continued.

It should be pointed out that such a program of fertilizing is the best, regardless of the nature of mulch you use. But there are some pitfalls in using unrotted organic materials and planting at the same time. These are explained in chapter seven.

“Fertilizing over and done, let’s start to plant. Again, there is nothing special here, and you may proceed to

plant as you have always done,” he explained. “First drop in or sow your first row of seeds. Then go to your bale of hay, and peel off a two-inch layer ‘book.’ Place it alongside of the seed row. Continue peeling off books, until the entire row is flanked by straw. Then repeat this process on the other side of the row. A medium to large field-baled bale should cover about 40 feet of row. Now, if you’ll stand back and look at the results of your efforts, you’ll see a newly-planted row of seed running parallel in between hay books, laid end to end. Who said mulching is untidy?

“Your second seed row should be placed just outside of the second row of books you laid for the first row. Confused? Just lay out seed rows and place one row of books between each seed row.

“By midsummer, the hay should be pretty well on the way to decomposition, and the books should have been compressed to half their original thickness. By this time, some weeds and grass will have fought their way through the hay. There’s no need to hand-weed, however. This is the time to apply a second layer right on top of the first. In late autumn, while closing out the garden season, you should re-cover any bare or thin spots in the mulch rows.

“Next year, you’ll really reap all the benefits of this system. Take a rake or a potato hook, and pull the remaining mulch to one side for a distance of half a book width, so that you expose the ground for a planting row right in the middle of where the path or row of hay was before. Get it? You are now to plant in the richest area, that was the middle of your mulch strip last year. And you are covering last year’s row space to

kill weeds and grass, and make rich soil for a third year," Eaton said.

"You'll find it unnecessary to dig or cultivate this ground before seeding. It will be loose, rich, humus-full, and abounding with earthworms. Just loosen enough ground with the corner of a hoe to get your seed in to proper depth, cover, and tamp. From now on, Mother Nature takes over many of your former duties.

"With this system," Eaton said, "we don't have to cultivate any more. We don't water, except in extreme drought; we do no weeding except at the first thinning or transplanting of the seedlings. Because we applied our minerals (granite dust and phosphate rock) liberally at first, we haven't been adding any fertilizing materials either.

"Only two and a half years of the book system has converted our depleted, packed, humus-lacking soil into a rich, soft, mellow garden that certainly does grow good vegetables. And this land has probably been used and abused for over 250 years.

"In only three years, we have seen our soil consistently in tilth and productivity. The hay mulch, constantly in contact with the soil, not only gives us the usual advantages of a mulch (which would be reason enough to use it), but actually conditions the soil with practically no effort on our part," Eaton said.

Another gardener who believes in a good hay mulch is John Krill. His garden is constantly covered with a mulch of old hay, weeds, straw and leaves. The mulch must be constantly renewed, however, because decomposition reduces its depth quickly. The Ohioan decided

that the best way to handle the renewal was "to grow my mulch right where I wanted it. That would be right over the mulch already spread out over the garden. I bought a bushel of oats and sowed them by broadcasting over the brown mulch," he explained. "Oats are cheap and a bushel sows one heck of a big area. I scattered the oats thickly because I wanted a good and heavy stand.

"What happened? I noticed next day that a few sparrows were gorging on the oats. So what? What could a few tiny birds do to all those oats scattered out there? Next day there were more, and on each succeeding day their numbers increased until I felt sure there were more birds than oats in the garden. I looked skyward for some signs of rain. A good wetting would cause the oats to sprout quickly with the sprouts preventing the birds from eating them. No rain. And very quickly there were no oats," he continued.

"When the rains came much later, the few handfuls of oats that had worked down out of reach deep in the mulch sprouted. They grew lushly, relishing the cool weather. But as I had planned, they never matured. Winter stormed over the land and the tender oats were killed by continuing freezing temperatures.

"The blades that had stood up so erectly were now flat on the surface of the mulch. Snow came and buried them. When spring arrived and the snow had vanished, I found a thick layer of flattened oat blades. This much of my idea had worked. I was determined to beat the birds the following fall. I used two methods, both of them good. Both are practical and may be used almost

anywhere that oats will grow. Oats like cool weather, hence for this purpose must be seeded in the fall.

“The following autumn turned out to be nearly as dry. It seemed to me the birds were already gathering in anticipation of more free oats. I did broadcast the oats, but the birds did not disturb them. There was one prime difference in them this time.

“I had emptied the oats into a tub. Then I poured enough water over them to give them a good soaking. The tub was covered with burlap and placed in a cool, shady place. A garage or cellar provides ideal conditions for this purpose. Everyday I would stir the damp oats, adding water if they appeared to be drying out,” Krill said.

“Then the oats showed signs of sprouting. I kept watering and stirring them to keep rot from setting in. Finally the tub was a tangle of greenish-white oat sprouts. When they were two or more inches long, I waited until evening and then broadcast them over the garden. True, the birds did come down and searched out every grain that they could swallow. But these were grains that had not sprouted for some reason. Those with the sprouts they left alone.

“The sprouts fell in every nook and cranny in the not yet compacted mulch. The blades turned a healthy green and shot upward rapidly. Late September became late October and the sprouts thickly covered the garden with a sturdy growth. But before the blades could set their heads of seed, the constantly intensifying cold slowly withered them.

“Snow buried the fallen oats. The weight of the snow, plus the hard beating of a number of rains flattened

them flush with the mulch out of which they grew. Spring found my garden already mulched with mulch right in place.

“I seeded oats by a second method without going through the process of sprouting them. It is equally good and equally simple to use. I had quite a quantity of old hay which was to be spread in the garden as mulch. Again you must wait until late September or the early weeks of October to use oats.

“I broadcast the oats thickly over the garden. (I must add that sprouting the oats will not interfere with gathering any vegetables which may be growing up until a killing frost arrives.) Over the scattered oats I spread the hay. It makes little difference how thickly the mulch is applied, for by the time it has compacted, the oats will have sprouted through it,” he continued.

“This method also defied the birds, for they could not poke deep enough in the protective mulch cover to reach the grains. A rain soaked the garden thoroughly and in a few days spears of green wove a mosaic over the brown mulch. Once started, the oats grew with a gratifying abandon. Soon they were so thick that the mulch could scarcely be seen.

“Before they could head, winter destroyed them and they fell wilted to the mulch, adding themselves to it. Again snows and rains beat the blades flat. Spring came and the garden was a mat of flattened and dense oat grasses that covered the original mulch,” Krill concluded.

Krill liked the results of his experiment. Years later, he's still using the method. But one man's passion is another's poison, or at least not his passion. Lee Shields,

an Indiana resident, uses another material for his mulch, a material abundant locally, and one he doesn't have to plant. Shields uses old leaves. He gets them from the city during each year's fall cleanup.

The city street department dumps from two to four truckloads on his garden each year when they are removing them from the streets in his neighborhood—all free. This may sound like a tremendous amount of leaves, but since they are wet when dumped by the trucks they immediately start to "heat" and break down. By the following summer, the "mountains" of leaves have been reduced to about one-third of the original bulk. He does not "turn" the piles—they are only handled once. (Other gardeners find that wet leaves tend to "wad" up into layers and resist bacterial action unless stirred and turned occasionally.)

Each year he takes leaves directly from the piles that were heaped up the previous fall, and works them into the soil to steadily improve its tilth and structure. Such application is usually made before the dry, hot summer days set in, preserving valuable growing moisture.

Shields likes to cultivate at least once before applying mulch, and give the soil a chance to warm up well. Then, a heavy application is made right up close to the plants, which will also help prevent them from blowing over during wind and rainstorms. By the following spring, most of the leaves are decayed enough so the rotary tiller effectively incorporates them with the soil.

Using leaf mulches is practical for the gardener since the supply is generally boundless in most communities. And it's practical for the community, which usually doesn't know what to do with its boundless supply of

leaves. In most areas, the leaves are simply burned, which wastes good mulch and puts more smoke into air which doesn't need it.

Waste is the key. Most mulches are waste, to everyone but the mulcher. Dave Shaw uses wood chips, for example. Wood chips would be a waste material to most people, but to Shaw they're nutrients in his soil.

Like Shields, Shaw, a southern New Jersey resident, likes to thoroughly turn his old mulch and sod into the soil each spring.

When first planting a new section of his garden that formerly was sod, Shaw goes back and forth with the



Wood chip mulch retains moisture, controls weeds and creates handsome background for rhododendron plant.

tiller about four times, working it down to about eight inches deep. He then applies a new four-inch layer of chips, adding cottonseed meal and dried chicken manure at the same time. Shaw tried mulching without tilling to break up new ground prior to planting, but discovered it took longer to eliminate weeds and grasses.

At spring planting time, Shaw moves the chips aside, makes a furrow with the hoe, drops in the seed, covers and tamps. As the plants grow, the chips are replaced around them. After crops are harvested in fall, the entire garden area gets several truckloads of chips to maintain the 4-inch depth.

When growing potatoes, Shaw plants them in about 12 inches of chips and straw, pressing the seed into the soil surface. Clean potatoes are picked merely by separating chips and breaking them off plants.

Although for most plants it makes no difference what kind of wood is used, Shaw does apply only pine chips and pine needles to his strawberry rows because of their acid reaction. Ordinary chips are close enough to neutral to cause no problem. The only potential problem with the constant chip mulch is an occasional nitrogen deficiency, evident when foliage begins to yellow. When this happens, Shaw applies cottonseed or bone meal, but, he said, "As long as you keep the chips above ground and don't mix them with the soil, you don't have nitrogen deficiency."

Shaw is proud of the lawn-building job he did at his Godparents' home along the Jersey shore. The soil there was just sand and gravel when he applied 3 inches of chips and 2 inches of old chicken manure. He worked

the mixture in well before planting. "Now that lawn is one of few in the area to have done so well with so little extra care."

He actually has sold so many people on the advantages of chips that "there's almost not enough to go around for everybody who wants to use the chips." In fact, he's glad to have his own chopper. Whenever his supply from tree-trimming crews gets low, he can always make his own chips from his farm's timber supply.

Shaw's primary source of the wood chips is a good source of mulching material for anyone: tree trimming operations. Utility companies and many cities have crews which annually trim branches which overhang their wires and other overhead facilities.

Ohio Edison Company, for example, does this. Instead of burning tree limbs that have been cut down, the Ohio Edison crews put them into chipping machines that shred leaves and limbs alike into small bits of material. This matter, when it decomposes, makes excellent mulch and top dressing. And Ohio Edison gives it away.

The leaves in the material contribute the most to its decomposition. They break down first and help to decompose the bits of wood, a process that does not occur quickly.

Archer Martin got a pile of the material in July. For several weeks it smelled like new ensilage and continued to be warm for two and a half months, showing that decomposition still was occurring. He expected that by the next summer they would be broken down completely and would do much to improve the consistency of the soil. Meanwhile, he used some of the material to

protect his roses and other perennials over the winter.

“I did not give the chips any special treatment,” Martin explained, “merely piling them in a mound with a depression at the top to catch rainfall. I wet down the pile frequently during dry periods and added wood ashes and grass cuttings atop it for no other reason than that the pile was a convenient place to put them. (To be truly effective, the ashes should have been mixed through the pile when I built it. I shall do that before I use it.)”

Ervin Steinmetz, an Ohio Edison tree foreman, has used the shredded material for winter protection of his

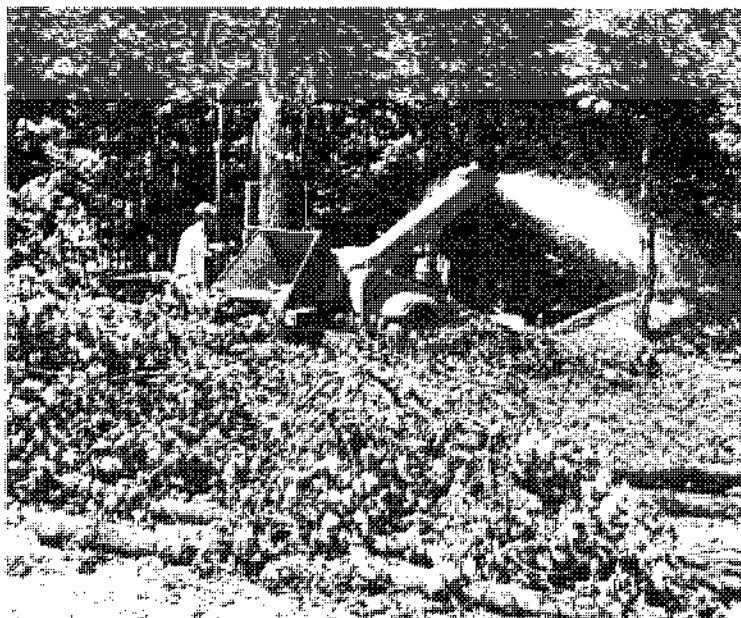

Utility company shredders quickly convert sawed-off limbs and leaves into free-for-the-asking mulch.

roses. He applied it after frost, though, and then spaded it into the soil early the next spring. The mulch shouldn't be put down while still green during the growing season, for it will rob the plants of nitrogen during its decomposition.

A farmer who lives near Steinmetz has been allowing the Ohio Edison Company to dump as many chips as it wants into an old gravel pit on his farm, with the idea in mind that he eventually will use the decomposed material for top dressing his fields.

Ohio Edison considers the use of chippers to be more economical than the old practice of piling whole limbs on trucks to be hauled away.

The utility firm almost always has men clearing limbs away from its lines during the growing season. If they are working in particularly heavy growth, they will fill a truck with shredded matter every hour or so. They haul the stuff to dumps, or to nurserymen and farmers who can use it in unlimited quantities.

The hauling, however, takes time and costs money, so Ohio Edison people are pleased when someone—usually a gardener—comes with truck or trailer to where the men are working and asks for the material. If your utility firm, whether electric or telephone, does not use chippers, a suggestion to the management might open up a new supply of free mulch for your community's gardeners.

And while you're checking the utilities, try calling other local industries, such as lumberyards, milling firms or food processing firms. Mulch is where you find it, and a little scouting around is generally worth the effort.

According to Robert Mead, thousands of tons of sawdust and shavings are used each year as bedding for the booming dairy industry in Vermont, for example. In addition to the natural fertilizer value of the sawdust and shavings, they absorb much of the fertilizer value from the cow manure that would otherwise be lost. Some mills gladly give this away to get it out of their way. At others there is a charge, a common cost being one cent a bushel. Some shavings are baled, with the usual price being 50 to 75 cents a bale.

Many other wood by-products are freely or cheaply available for use as mulch. In addition to the sawdust and wood chips and shavings that have already been mentioned, one can use bark and packing materials; such as shredded paper or excelsior. Peat moss, too, is good mulch.

The by-products of your own or others' gardening activities can be used as mulch. Use those weeds for mulch. And the grass clippings, pine needles, rotted pine wood, corn cobs and stalks and tobacco stems.

In Kentucky, for example, the tobacco remedy is the first thing people think of when their lawns are doing poorly. If it works for them, it should for anyone who has access to the tobacco stems. The remedy is really a mulch of tobacco stems. After the last leaves are raked in the fall, the Kentuckians spread a thick layer of tobacco stems over the lawn. Winter rains and snows leach the nutrients from the stalks into the soil. In the spring, the stalks are raked up. The tobacco farmers themselves use the stalks in some areas, usually tilling them into the soil.

In corn country, widely-used mulches are corn cobs

and corn stalks. Ground into one-inch bits, the cobs have many uses. The sugar content of them will benefit the microorganisms in the soil and will promote better soil granulation. Shredded corn stalks—provided the stalks weren't infested with borers—make a well-aerated winter mulch.

In the southern states, rice hulls, cotton burrs and hulls and pecan and peanut shells are readily available as mulch materials. Most of these materials are rich in nitrogen and potash. They are unusually attractive as a mulch, too. If you happen to live in the northern areas of the country, you may find the nut shells available commercially.

If you live near a brewery, check the availability of spent hops and grain used in the beer-making process. These are good as mulch.

Gardeners in Florida and Georgia often use excess hyacinth plants as mulch. The plants abound in these states. They can be used as is or ground to a pulp.

It all depends, again, on what is cheaply and abundantly available locally. In the Canary Islands, to use a far off example, an old custom, dating back 100 years or more, is to mulch with picon, which are small volcanic pebbles. Picon farming, as it is called, is a variation on stone mulching, which is covered more fully in the next chapter. Its biggest advantage, according to practitioners, is that it conserves, as do most mulches, fertilizer and water, both in short supply on the barren islands.

The custom dates back to the last major volcanic eruption in the islands. When they could get back to their homes, the farmers found their fields covered with

volcanic rock. But it was planting time, and they could do nothing else but dig holes through the pebbles and plant. To their amazement, they had record crops that year and in subsequent years developed the following procedure of protecting the ground with the small pebbles left by the lava flow.

First, furrows are cleared away, and animal manure placed in the soil is covered over, and a top layer of from one to three inches of picon is put on. The row is watered, and when it seasons well, it is planted through holes made in the picon for insertion of seeds or seedlings.

Farmers say a picon covering can be left undisturbed for 20 to 30 years, with only small additions of fertilizer needed from time to time, put in through the holes in the picon at planting time. Watering is unnecessary, for the picon not only holds in what moisture there is, but collects additional moisture from the atmosphere during the short rainy and foggy seasons, and stores it in the ground below. Weeding is minimal, another saving in time and labor.

Chief beneficiaries of the picon treatment are cactus farms, which produce sisal fibers for rope and cochineal insects for carmine and like dyes. But without picon, home gardeners would find it impossible to grow tomatoes, corn, melons, cucumbers, squash or potatoes.

Without a somewhat similar material, Ruth Bixler would have found it impossible to keep her flowers growing. Mrs. Bixler had had tremendous problems keeping anything growing in the shaley soil at her Pennsylvania home. An intensive mulch program saved her vegetable patch and stone mulches—explained in the

next chapter—saved her trees. Nothing worked for her flowers, however, until she discovered and tried a picon-like material.

“One Saturday,” she explained, “I stopped at the feed store to get some feed for our pet rabbit, and right in front of me I saw the answer—bags of ground oyster shell. I bought bag after bag and started shaking it over the beds. I really put it on thick and it was beautiful for the summer; not even a heavy shower disturbed it.

“To my surprise the few weeds that came up pulled right out as if the ground underneath was wet. It cut my weeding time down to once a month (before that every week). The roses were never more beautiful and bloomed until the first snow. I also used it thick on my Mimosa trees and they got through the severe winter without a single loss.”

What this all means is that to succeed in the mulching system of gardening, you have to be what Owen M. Voigt calls a “pack rat.” He figures that’s what he is. Voigt has toured and explored Virginia’s Shenandoah Valley countless times in search of mulch materials for his garden.

“I have become an expert in our county’s various industries, have memorized hundreds of miles of scenic back roads, and have made the acquaintance of many interesting people,” he said. “I now feel I am truly a citizen—almost a native—of the area to which we migrated several years ago.

“Luckily, mulching poses the need for more common sense than funds, so we were able to utilize our limited resources to good advantage. The nooks and corners where our search for material took us were fascinating,

and in the long run as educational and rewarding as the improvement wrought by our horticultural endeavors.

“People everywhere were considerate of our needs. They recognized the basic common sense behind our methods, and were always ready to give us what we needed.

“When I visited a furniture factory for sawdust, the manager took me on a tour of inspection and showed me the sawdust pile which loomed imposingly in an



Shredded pine bark mulch around fruit trees holds in moisture, promotes new root growth.

adjacent field. But he pointed out that it was an overfine residue of many woodworking operations and was prone to cake. He suggested a local sawmill which cuts logs and rough lumber—much better for my uses. I located the mill which was operated part-time by a genial farmer. Here, for just a few cents, I was able to acquire large amounts of good red oak sawdust—enough to mulch my lengthy 500-foot hedge, and to add to my compost heap.

“However, my farmer-sawmill operator passed me on to another and larger mill which uses a debarker system on their logs. They gave me a very generous amount of shredded bark, which I found to be the most successful evergreen mulch I have tried,” Voigt said.

“The soil beneath an inch or slightly more of this shredded bark never showed signs of extreme drying, although we had some very hot suns during the severe droughts. Through it all, the shrubs retained a healthy deep green, while the soil, unrobbed of nutrients and nitrogen, was alive with beneficial insects, fungi and earth worms. I would also like to add that it gives a very professional finish to your vegetable rows and ornamental beds and borders, very pleasing to the eye, while it keeps the weeds down rigorously.

“In the fall of the year, trucks of the sanitation department roam the streets collecting huge piles of leaves with a suction pump. I contacted the chief engineer of the town waste disposal system who told me they were dumped on a public fill project, and were available to all who chose to collect them. Here indeed was a bonanza overlooked by almost all of the local horticulturists, many of whom still burn their leaves. The action

of the pump in sucking up the leaves grinds them up into a powder, so I was able to collect close to a ton easily. Last year when I made the mistake of spreading them in the spring, the ground was very slow in heating up. So this year I plowed them under in the fall, letting the now-abundant worms and bacteria consume them through the winter.”

As Voigt toured the valley looking for mulch materials, he also kept his eyes open for organic fertilizers. “I consider a large supply of burlap bags in the car’s trunk an absolute necessity,” he said. “It’s also advantageous, I find, to keep a small notebook which lists places and areas cited by friendly advisers as possible sources for more and different organic complements.

“Trouble, and time-consuming? Yes, I guess it is if you mark down each moment to drudgery. But what are adventures into the back roads and bypassed nooks of your community? And what is that pioneer’s satisfaction that comes with building a really fine garden from a square of waste soil? Is this trouble, is it pleasure, or is it achievement?

“Two years ago, local gardeners considered my methods a little nutty—to say the least. But this fall I caught my neighbor quietly sneaking in a load of leaves to cover his garden.

“It looks as if being a pack rat is contagious!”

Chapter Five

STONE MULCHING

When “Pack rat” Owen Voigt first started roaming the Shenandoah Valley in search of mulching materials, one of his first specific desires was stones—big ones, little ones, round ones, jagged ones—just stones.

“If you have never used a rock mulch,” he said, “I heartily recommend it.” For Voigt, a big factor was that rocks aren’t too hard to find and are used just as they are found. All he had to do was find a rock, plunk it in place and he had mulch. Moreover, rocks are free.

Rock mulching is pretty much like every other kind of mulching. Rocks do everything that other mulches do. In some instances, they do it better. They are, for example, exceptionally good for conserving moisture and moderating daily temperature fluctuations and particularly good at maintaining soil structure. And when

was the last time you saw a weed sprout through a stone?

Most any vegetation can be stone mulched, but it works particularly well for trees and it looks particularly good with flowers and other decorative vegetation. L. T. Servais, a Green Bay, Wisconsin, gardener and rock collector, uses his functional stone mulches to show off his collection.

"I have been using rock mulches around fruit trees for 20 years now with good results," he said. "As a rock collector, I at first kept my collection of specimens from a dozen states and Canada in the house. But when they really began to get in the way, cluttering up closets,



A mulch of rocks combines neatness with moisture conservation while it discourages weeds.

shelves and cabinets, I moved them outdoors and put them to work around my trees. I have replaced the more drab stones now with rose quartz, gleaming obsidian, and shining feldspar to add a bit of glamour to my tree plantings while helping them to grow better."

While a rock mulch's ability to make a garden look better might be a matter of opinion, its ability to make plants grow better appears to be a historical fact. Evidence of stone mulching in ancient Rome has been found in the writings of Virgil, the great Roman poet. His agricultural directives included the following instructions:

"Finally, put your rooted grape cuttings firmly down in the ground, be sure to add sufficient earth and sprinkle rich manure over it. Also dig in some stones, perhaps pumice, perhaps rounded sea shells; for, between these, water will seep down and the air will gently penetrate and inspire growth in your plants. I have even found some who loaded heavy fieldstones on top or considerable weights of broken pots; this is protection against cloudbursts and against the hot summer heat which cracks the thirsty fields."

Columella, who was the best prose writer on agriculture in Roman times, related that stones were placed even between the roots. Similar practices prevailed in olive groves. The olives like lime stones particularly. The olive was planted in trenches four feet deep into which it was the custom to deposit stones for encouraging moisture around the roots.

Stone mulching has been used to great advantage on the Organic Gardening Experimental Farm. Author

and publisher J. I. Rodale did quite a bit of successful experimenting with stone mulches.

"Somewhere in the 1940's," he wrote some years ago, "I got the idea of growing vegetables in a stone garden, with alternate layers of soil and stone . . . For almost 20 years we have planted vegetables in this garden with excellent results. It seems that something about the stones communicates itself into the plants to make them grow faster and be healthy . . .

"The one bad feature of this kind of a garden was that the weeds would grow between the stones and could not be cleaned out as with a weeding tool in a conventional garden. They would have to hand-picked. So one day . . . while my wife Anna and I stood looking at a stone section overgrown with weeds, she observed, 'Perhaps if we would put another layer of stones over the existing ones, it would be more difficult for the weeds to poke their way through them.' No sooner said than done."

That experiment turned out to be as successful as the original test of the stone-mulched garden itself. Rodale reported some of the more unusual and unexpected benefits of rock mulching. It is, for example, a good method of plowless farming, that is, farming in which the upper layer of soil isn't disturbed. He reported that plowing can be used, but that it isn't necessary to plow deeply. In the spring, the upper four or five inches of soil is merely stirred about a bit before seeding. This stirring is easy because the earth is soft and moist between the stones. If some organic fertilizer is being used, the shallow plowing keeps it close to the surface where it will be more accessible to oxygen and will decay faster.

"A stone mulch causes the earth under it to be well-aerated, usually more so than exposed soil, strange as it may seem," he wrote. "You can verify this by merely looking at a stone resting above the soil. The rain causes a shallow channel to form in the soil under the outer rim of each rock, permitting air to enter, whereas the baking action of the sun on exposed soil and blowing of wind over it harden the surface into crusts that can be lifted up bodily.

"The conditions under stones are ideal for bacteria, earthworms and other burrowing insects," he continued. "A dampened darkness prevails that is favorable for the working of bacteria and beneficial insects.

"Groves of sickly limes, citrus trees and other fruits have been revived when rocks were piled high around the trunks to help keep the bark from scorching and the roots from becoming dry and hot. The vigor and growth of both ornamental and fruit orchard trees is increased by rock mulching when teamed with sound organic care. Consistently better yields and quality of plums, peaches, apples and cherries have been reported by many gardeners and farmers using the rock-mulch system. Young fruit trees have been especially benefited in getting a strong start," he wrote.

Margaret L. Wood is a stone mulcher whose experience with the system tested it to an extreme. She had read about the system and its results at the Organic Gardening Experimental Farm and elsewhere. She viewed it as something of a last resort. Mrs. Wood and her family live in Arizona's Mojave Desert. Since every drop of water used by the Woods, their dogs and cats, horse, cattle and sheep and their plants must be trucked

in, the moisture conserving qualities of a good rock mulch were on the line.

“We took possession of our new home in a July following an unusually wet period in May and June,” Mrs. Wood explained. “The trees and shrubs were green and lovely. Then the weather returned to normal. In Arizona that means *hot* and *dry*. The ground baked until a hoe just bounced off it, and you couldn’t dig a hole without first soaking it for an hour or so. Hauling water became a daily, not weekly chore, but even so the shrubs and shade trees drooped and shed most of their leaves. The tips of branches on the fruit trees died back. The evergreens looked limp and actually seemed to shrink. Everything wilted, including us. The situation looked hopeless,” she said.

Then she remembered Rodale’s stone mulch. “If there was any one thing we had lots of on our desert land it was rocks—big rocks, little rocks, granite, quartz, turquoise, sandstone, limestone—we had them all. From then on, every morning and evening, and even some afternoons, found the children and me out hauling rocks in a wheelbarrow and garden cart. Judging by the expressions on their faces as they drove by, the neighbors must have been pretty certain that the sun had gone to our heads.

“The first thing we tackled was the shrubs and bedding plants against the west side of the house. Afternoons they were broiling and mornings, when it was shady, the seven kittens were literally tearing them to bits. We gave the whole bed a quick overall cover of fist-sized rocks which the contractor had obligingly left pushed up nearby, soaked the covered bed for a couple

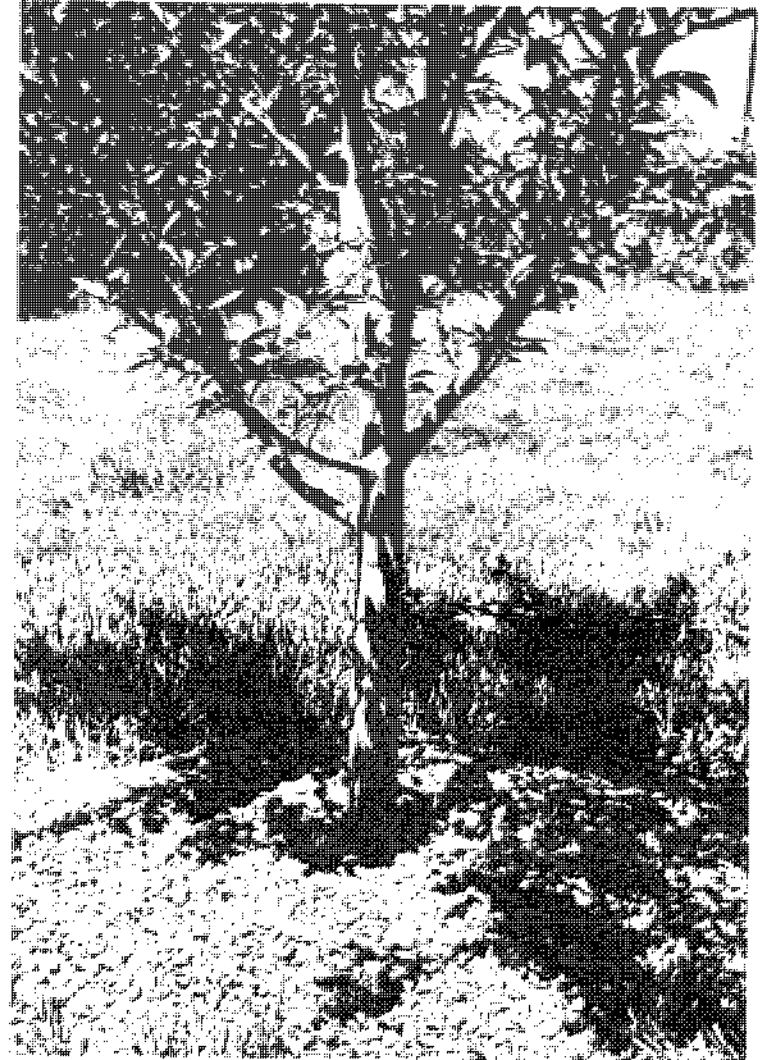

Stones in a rainbow of colors prove mulch can be decorative as well as protective.

of hours with a sprinkler hose turned upside down, and as simply as that the flowers and bushes stopped dying and actually began to grow. A few even bloomed. Now don't misunderstand me. I didn't say that suddenly we had a lovely flower bed. This was still the desert in July and the soil in the spot was hard and barren, but these plants were now at least holding their own, and they continued to do so if watered lightly with the sprinkler hose once a week," she continued.

"By now it was obvious that the foundation planting in the front (the east side) was losing its battle with the dogs and the heat, so we worked on it next. We were now able to scrape up a few wheelbarrow loads of manure in the corral, so we could do a more thorough rescue job here.

"First we made a manure dike a foot high, a foot across, and 18 inches from the plants the full length of the beds and across the ends. This was then shored up on both sides with the biggest rocks we could manage to get into the wheelbarrow. The top of the dike was covered with smaller rocks to keep it from weathering away.

"When we had finished, the two beds in front had become, in effect, two rock-bottomed reservoirs bounded on two sides by the manure-rock dikes and on the other two by the foundation and the cement steps," she explained. "We filled them with water to a depth of eight to 10 inches and let it soak into the ground, and these bushes grew and flowered and the little pyracantha set a full crop of large, well-colored berries.

"Again, this was no lovely flower bed. These were small shrubs two to three feet apart, and partially hid-

den this first year by the big rocks—but they grew, despite the heat, on only one watering a month from then on.

"Our next project was the rhubarb and shrubs along the north side of the house. They received the same treatment, and the rhubarb continued to send up new growth all summer," Mrs. Wood continued.

"By this time our backs were stronger and our manure pile bigger, and we decided to see what we could do for the trees, grapevines, and rose bushes which were too widely separated for that sort of treatment. Since we had finally run out of readily available rocks, we began by building circular manure dikes two to three feet from the tree trunks, wetting them down with the hose and letting them "bake" in the hot sun. These were then filled to the top with water every 10-14 days and the trees began to grow. Some of the Scotch pines grew more than a foot through August and September, and later the fruit trees began forming blossom buds for spring. The roses appeared blighted or diseased, so they were pruned back almost to the ground after diking, then responded with fresh, healthy new growth and a few perfect blossoms for Christmas.

"Meanwhile, we hauled in rocks whenever we could. As each tree was rocked up, a six to eight inch layer of trash from around the hay stack was placed between the tree trunk and the dike to make it easier to tuck in sprigs of myrtle and sweet alyssum and a few bulbs here and there," she said.

It took muscle, some perseverance and lots of a cheap and locally abundant material—rock—but the Woods finally got their little chunk of the desert blooming like

an oasis. And it wasn't a mirage, either.

Another stone mulcher is Georgia Montfort. She didn't find herself in a do-or-die situation such as the Woods. For her it was a matter of developing a rock garden for show and watching—somewhat amazed—as her plants slowly gravitated to the areas best suited to their health. Those areas happened to be on a 50-foot sandstone terrace located between the rock garden and the lawn.

“First, drifts of my favorite wild red poppy appeared in two or three places, blooming more vigorously and colorfully than they had before. Next, portulaca—normally quite difficult to establish in beds—put in a surprise appearance on the sunniest part of the terrace. Then alyssum cascaded onto the sunny terrace,” she said.

“By now the floral migration was on, and the penstemon, which had been unhappy in a well-tended bed, marched boldly out into the flat sandstone to flourish brilliantly. Evening primrose appeared, growing to fantastic proportions and far excelling anything found in its normal habitat, while another wild specimen—the little blue violet—became a permanent resident, cropping out between the cracks in blue masses.

“Since the development of the first terrace-dwellers far exceeded anything that had been planted in the nearby beds, I soon began to plan and regulate flower growth on the terrace, obtaining added beauty and color with practically no extra effort, and without interfering too much with what was going on. I also began to realize with increasing clarity the numerous advantages offered by the stone-mulched terrace and why my

plants were seeking them out without being particularly invited or encouraged.

“Contrary to my expectations, the terrace newcomers did not wither for lack of moisture, nor was their growth stunted during the hot season. Because the porous sandstone seems to reduce evaporation, I found it necessary to water only when flower growth was dense and tall. Sometimes, when a stone broke or chipped, I lifted it to find the soil moist and pliant, well-aerated and teeming with active angleworms beneath. Capillary root growth became so pronounced that, in many instances, the tiny but vigorous root systems penetrated the stones themselves. Another growth-promoting factor came from the slow disintegration of the rocks which deposited rich minerals in the soil. In addition, most of the wild flowers prefer the slightly acid condition created by the sandstone,” Mrs. Montfort said.

“Although I had long been aware of the many advantages of rock gardening, I now realized that a flat sandstone terrace offers the same benefits but on a much wider scale. Besides moisture storage and weed control, the stones moderate extremes of temperature, keeping the soil below them cool against the heat of the sun. Root growth is steady and vigorous, low foliage is protected against spattering when it rains, and a clean, attractive background is provided for creeping, low-lying blooms.

“It wasn't necessary to plant seeds deliberately on the terrace because other flower combinations occurred quite spontaneously as highly welcome additions. Among these, the delphiniums established themselves in thick profusion—their curled green crowns appear-

ing consistently between the cracks long before my regular beds even thawed.

“Such are the advantages of terrace gardening—however unintentional!—that early germination is now counted upon with confidence. Long before the frost was out of the ground in the garden, my poppies and portulaca put in a startlingly early appearance. Despite the freezing nights, cold winds and even intermittent snows, they continued to develop—hardy wild pioneers who know what’s best for them and where to find it. Anyway, the snow melted quickly on the sunheated terrace before it could do any lasting harm.

“So,” said Mrs. Montfort, “don’t be dismayed if some of your favorite plants insist on wandering through your garden, away from the spots you have prepared so carefully and lovingly for them. They know what they’re doing and what they’re looking for, so don’t fight ’em—encourage them. That’s what I did, and the entire garden benefitted when my wild flowers insisted on moving over to my stone-mulched terrace.”

Ruth Bixler’s trees benefitted when she turned to stone mulching. It was for her—like for the Woods—something of a last hope. After she and her husband acquired a small tract near Allentown, Pennsylvania, and constructed a home, she discovered their proposed garden plot was shale. A period of composting and mulching cured the gardening problems. But her flowers failed and her trees started to follow suit.

“When all my spruce trees died but one,” she said, “I decided to do something about it. My fruit trees had a struggle to get rooted, too. A Chinese walnut tree gave

up and died. I also realized then that the sprinkling system was not the answer.

“Why, I asked myself, does a tree grow high and handsome in the woods under the same sun, with no surplus water, and in my yard refuse to grow? Finally, I made a trip to the woods and the first thing I noticed was the stones under the trees. And then I knew that it was the stones that helped hold the moisture.

“In July of that year we spent our vacation along Lake Erie. The grade going down to the beach was full of round, flat stones. The day we started home, our car trunk was half full of these. That week I laid the last spruce thick with stone. In a month the tree started growing and stayed green all summer in spite of the hot, dry weather and few showers,” she continued. “It never stopped growing and is now a beautiful specimen. The next year I brought more stones home and started putting them around the fruit trees. A Yellow Transparent apple tree grew quickly after the stones were put around, and has been bearing very heavily ever since.”

Without realizing it, Mrs. Bixler may have been doing more for her trees than merely providing a handy reservoir. A. P. Thompson, a Shenandoah Valley orchardist, has been growing apples the organic way for years. Part and parcel of his method is mulching, with a generous number of stones included in the mulch. He cites not only the moisture conserving qualities of the stones as a reason, but others as well.

Thompson uses what he calls the “fortress method” of stone mulching, claiming it has four benefits. It gives the trees greater anchorage in strong winds. Further, it

acts as a heat sink by absorbing a great deal of the sun's heat during the day. On frosty nights, this heat sets off minor convection currents that provide some protection to bud and bloom. The fortress also provides protection for the tree's roots from burrowing mice, which oftentimes damage or kill trees. And finally, the rocks provide calcium and magnesium for the tree as they weather.

The fortress method, one of the most unusual of Thompson's many offbeat orchard management practices, involved erecting a six-inch high wall of half-inch dolomitic rock around the base of each tree. About 500 pounds of stone goes into each five or six foot diameter wall.

Servais, the Wisconsin rock collector, developed a similar technique for nurturing young trees. He explained his mulch, saying, "Last year I placed 100 pounds of rocks around two young pear trees and a blue plum as soon as I planted them, and then gave them a heavy soaking. I didn't want to lose them because of air pockets around their tender young roots—which has happened in the past.

"My trees all came through the summer in good, healthy condition, justifying my theory that the weight of the rocks gradually squeezes the air out of the newly worked, dampened soil," he said.

The experience of John S. MacManes with sick trees offers further evidence in support of J. I. Rodale's conclusion that rock mulches greatly benefit trees. Even the fertile ground of the Finger Lakes region of upstate New York couldn't do much for MacManes' sick peach tree.

"If we were going to save it all," MacManes decided, "we would have to rock-mulch it, we agreed, at the same time giving it plenty of compost, leaf mold and wood ashes in order to sustain its will to live. Otherwise, the tree looked bad on the following counts:

"1) It was too old, well past its prime;

"2) Leaf curl had blighted its foliage almost completely;

"3) It was suffering from gummosis, was ill-shaped and worm infested;

"4) The northwest wind hit it full blast throughout the winter.

" 'Cut it down,' the neighbors said, but we were stubborn. We had noted some timid and sparse new growth and felt that 'where there's life, there's hope.' So we pitched in, and I began my own private battle to save our tree," he continued.

"First I applied a booster dose of finely pulverized limestone right under the tree, and then added a generous top-dressing of good wood ashes. Next, starting at the drip line and working to within a few inches of the trunk, I heaped poultry droppings, leaf mold and compost. And finally, I worked over the entire area, setting a good ground cover of rock mulch to regulate soil temperature and moisture, to encourage extra bacterial growth in the soil, and also to supply the trace minerals which our tree obviously lacked. Then we sat back, eager with expectation, to see the results and reap our reward.

"Nothing happened. The tree didn't die and it didn't seem to be getting any better.

“But the spring and summer of the following year told a much different story, as the magic in stone mulching began to assert itself.

“The season came on extremely dry, which tended to slow up growth everywhere—what our tree needed was rain. But, despite the baking sun and drying winds, new growth took place before our eyes, and we were agreeably surprised and pleased with the richly vibrant bloom at blossom time. A beautiful green again enfolded our tree, leaf curl was reduced drastically, gummosis practically ceased.

“That harvest time we picked bushels of lusciously big peaches—each a handful in its own right—from our once-dying tree,” he concluded.

Michigan planter Walter J. Muilenberg discovered that even the frail Canadian Hemlock tree can survive out of its element with a good rock mulch. In Muilenberg’s area, the tree is never found in pure stands. It’s always mixed in with hardwoods which protect it from wind and sun.

It seems impossible to transplant them and make them grow under ordinary conditions. Muilenberg was clearing land and pulling out stumps when he came upon three hemlocks. He decided to let them grow and cleaned out everything else around them. A lot of stones accumulated and by sheer accident they were piled under one of the hemlocks. That is the only one that lived. The other two died in a few years. The peculiar thing is that the one with the stone mulch became a wonderful specimen, far superior to the twisted and scraggly hemlocks usually seen in the forest.

“It is my guess that the third hemlock survived be-

cause of the rock, a weight of several tons, which had been piled around it,” Muilenberg said. “It had grown up in heavy woods, which consequently helped to make it more shallow-rooted, and in heavy shade, which helped to keep the soil cool and moist. Later, when the rest of the trees were removed, rock gave the tree a good grip on the soil and made for a cool, moist root-run, as rock always does. It would seem that the top of the tree will get along in good shape so long as the roots have protection.”

Stone mulches, of course, needn’t be accidental, haphazard or last resorts. They can be tremendous additions to an existing garden or the center of a new one. A stone mulch can be exactly what you want it to be, because you can make the stones, as Robert Rodale once explained.

“My father, J. I. Rodale, has had the idea for many years that mulches don’t have to be dull, and they don’t have to be just organic either. Many a day in my youth was spent hauling rocks from quarry and fence row to make stone mulches for around trees, and even for lining the rows in a special vegetable garden. A stone mulch has certain advantages over any other kind. It lasts, for one thing. As the stone ‘decays’, it also adds minerals to the soil. But stone mulches have disadvantages, too. Their biggest problem is the odd sizes of stones, which make them difficult to fit together into a neat, flat surface. It can be done by an expert mason—but a person who isn’t a mason might have trouble making a geometric pattern out of rock.

“The idea of making different-shaped concrete segments that would fit together into unusual stone mul-

ches came to my father several years ago. He had some concrete molds made in square and rectangular shapes, and cast enough of the blocks to make several different beds. One of his concrete mulch variations is now an herb garden. The most-noticed one, though, is the round 'target' garden along the highway in front of my house.

"These concrete mulch gardens have turned out to be one of those unusual garden features which attract attention year after year. They are something you can make yourself, if you are handy with tools and can make the molds. The concrete work is simplicity itself, because no fine finishing is required. You can even make them in different colors by adding dye to the mix," he said.

The most commonly used shape in the Rodale garden is a triangle. In the mixture for the cement slabs are included some crushed rock and some mineral fertilizer powders like phosphate rock, granite dust and dolomite. These minerals slowly leach out into the soil. The recipe for the cement includes one part cement, one and a half part sand, one and a half part stone, a half part dolomite and a half part phosphate rock.

"We also add finely powdered coal dust to the mixture, not only for its minerals, especially sulphur, but also to darken the triangles, in order to make them retain heat better," J. I. explained.

"There are three different sizes of triangles, so that they can be made to fit together in a circular pattern. The sizes are 12 by 12 by 12 inches, 10 by 10 by 12 inches and 10 by 10 by 14 inches. The larger one is made with a pool-table billiard ball rack triangle. This was the

idea of John Keck, our farmer-technician, who went at this project with great enthusiasm and who practically worked the whole thing out by himself. He made the slabs a few at a time, in his spare time, but it's surprising how little by little things add up.

"One of the advantages of this method is that once a year the slabs can easily be taken up and the soil given a complete working over," J.I. continued. "The most interesting thing about it is its beauty, and the fact that a person with some imagination can vary the designs. Almost any shape of metal form for the molds can be made by a welder or blacksmith."

"A lot of people get in a mulch rut," said the younger Rodale. "Perhaps they have one kind of mulch material available to them, and use it year after year. While that is the easy way, it can't be counted on to give the maximum in beauty to a garden. We should think more that the mulch around trees, shrubs and flowers is a dynamic feature of the garden, and not just something to hold down weeds, preserve moisture and feed the soil. Of course, those are the big reasons for mulching, but we shouldn't forget beauty as well.

"Mulches of small stones and gravel are becoming more popular lately, spurred perhaps by the Japanese school of landscape architecture which features such things as raked areas of sand and boulders artistically scattered throughout a garden," he said. "One of the most popular of these mulches is river gravel, the small stones collected from stream beds, where they have been washed and rolled by the waters for perhaps hundreds of years. Those stones all have rounded edges and are of a variety of colors. Best application for them is

along a building or near areas of concrete such as walks or patios. They provide a welcome visual relief from flat, uninteresting pavement or big walls.”

A stone mulch is, as Servais the rock collector said, adding “a bit of glamour” to your plants, “while helping them to grow better.”

Chapter Six

WHY WE REJECT ONE of the MOST COMMON MULCHES

Extensive experimentation has shown marked increases in vegetable yields resulting from the use of black, polyethylene plastic mulches. Many gardeners have enthusiastically adopted the use of such mulches. It seems like such a good idea. But it's not.

Most people overlook one important fact. They see that plastic mulches are cheap, effectively control weeds and efficiently conserve moisture. And they fail to see that a plastic mulch contributes nothing to the fertility of the soil. It's only shelter, not food, too. An organic mulch is both.

When you stop to think about it, what could be more unnatural than a product like plastic mulch? Plastics are non-organic substances which add nothing to the soil except trouble if you try to grow crops where they

have been buried. There is, in fact, some reason to believe that the formaldehyde given off in small amounts by some plastics can actually kill soil bacteria and thus interfere with plant growth.

The durability of plastic, at first counted as its prime virtue, has become instead a monumental pollution problem, for unless it is burned, plastic is virtually indestructible. Since burning certain kinds of plastic, particularly polyvinyl chloride, gives off toxic fumes such as hydrochloric acid—labeled by the New York City Commissioner of Air Resources as a “serious environmental hazard”—burning is not a safe disposal method. Even the DuPont Company, famed for creating “Better Living Through Chemistry,” and a leading plastics manufacturer, has found no more satisfactory method of disposing of plastics than to bury them. Should we continue at our present pace, there will hardly be a square inch of land on the continent in which some form of plastic doesn’t lurk six inches beneath the surface.

Studies into methods of degrading plastics have been conducted in the United States, Sweden, Great Britain and the Netherlands. No answer has been found, and many authorities are beginning to recognize that we are coming face to face with a very serious problem.

Ironically, organic gardeners, dedicated to preserving a healthful and attractive environment, are nevertheless unwittingly contributing their share to the nation’s reputation as a plastic society. Without giving it a thought, most of us end up with at least half a dozen disposable but indestructible plastic packages every

time we go to the supermarket. But more than that, some actually use plastics deliberately in their gardening!

Plastics are convenient, quick and durable. That they are a labor-saving mulch is plausible. After all, they don’t have to be replaced periodically as do those organic mulches which keep disappearing into the soil. But the fact that the non-organic plastic mulch doesn’t disappear—ever—is its prime drawback.

It should be noted that another increasingly popular non-organic mulch—if handled properly—doesn’t have this drawback. That mulch is aluminum foil, which can be recycled. Aluminum foil mulch has many of the advantages of plastic mulch, plus some it doesn’t have—such as an insect-repelling, photosynthesis-boosting reflectivity. But, like plastic, it won’t ever boost the fertility or tone up the condition of your soil. If you must use a non-organic mulch, use aluminum foil. And when you’re through with it, recycle it.

But before you do, read what Ruth Stout, that mulching pioneer, has to say about plastic mulches. Most of what she says will apply to aluminum foil mulches as well. Despite the plausibility of claims that plastic mulches cut the labor in mulch gardening, Miss Stout plans to stick with her tried and true methods.

“A month or so after my first book about year-round mulch was published in 1955, I got a letter from a business firm in New Jersey, asking permission to send me a gift of black plastic, which was, of course, to be used for mulching my garden,” she said. “My reply was, in effect, as follows: ‘Thank you very much for your offer, and since I never refuse a present, I will

accept the plastic. However, I think it only fair to add that I may never use it. And if I do (just to try it out), I will almost certainly write about it and speak of it, not for it, but against it, comparing it unfavorably with the kind of mulch I use.'

"Needless to say, that New Jersey firm didn't send me any plastic.

"In writing about gardening, and giving talks on the subject, I try very hard to stick to my own experiences. However, all one needs, in my opinion, in order to be able to figure out what's wrong with plastic mulching is a little imagination and a little common sense.

"Let's say that a person who was rather short-changed when imagination was being passed around decides to use a plastic mulch instead of hay on a garden the size of mine (45 x 50); he figures that, for one thing, the plastic will cost less, since it lasts forever. Well, here's news for him. Plastic won't be cheaper because, since it doesn't supply the nourishment needed to keep a garden producing, he will also have to buy fertilizer each year to make sure that his plants get what a mulch of hay gives them; the hay rots and provides the soil with all the required nutrients" she continued.

"And of course all other vegetable and organic matter that rots—straw, leaves, corncobs, wood chips, kitchen garbage—will nourish your soil; cornstalks and the tomato, bean, asparagus plants should all be left on your plot, in order to do their share of providing nutrients.

"I have heard it said that there is less to do in a garden if you use a plastic mulch rather than an organic one, and I wonder how growers operate when using the

former. Since it seems to be less work, I suppose they just spread the plastic on their plot in strips, then ignore the whole thing.

"For the moment I am going to pretend that for some odd reason I've decided to use plastic for mulch on my 45-by-50 plot. Let's say that I put down strips of plastic, leaving a small space between, and I drop the seeds in the exposed area. But first I must do something about enriching the soil, and maybe buy some organic fertilizer. But what? Manure? And do I make a compost pile? I'll certainly skip that, for it's quite a lot of work to get the materials together. Then, when the pile has become rich soil, I'd have to load a wheelbarrow with it and distribute it all around. Well, that whole routine is 'out of bounds' as far as I'm concerned," she continued.

"Now I go ahead and put in the seeds in my plastic-mulched garden and the plants show up and so do the weeds—in the spaces between the plants right in the rows which have to be made rather far apart. That is, the corn does, and potatoes, and squash, and tomatoes and, in fact, almost all the plantings. The question of weeds isn't a problem, of course, if you use an organic mulch. The hay, or whatever you use, is lying there in the row, as well as alongside it, and will keep just about all weeds from getting anywhere.

"At last, the first summer of plastic-mulching my plot is over, and finally another spring shows up—time to plant early crops. But when I go out to the garden, I'm nonplussed; I can't get rid of the idea that the plastic which was supposed to save me a lot of work, should certainly be moved to other areas. Why do I feel that? Well, I keep thinking of that good earth under the

plastic, and it seems absurd not to make any use of it. And the small open space, which I used for planting last season, doesn't seem to be adequate now, so the only thing to do is to move those black strips to other spots, and that would certainly be a tedious job. (I will admit that maybe I am being unreasonable, and that it may be quite all right to cover up a lot of your soil with plastic and never produce anything in those areas, but the whole idea sounds goofy to me.)

"However, if a person is wise enough to use organic matter for mulch, all he has to do in early spring if he wants to plant some lettuce and parsley in whatever spot he may choose, is just pull the hay aside (if he hasn't already done that in the fall) and put in the seeds.

"About asparagus, I just can't believe that anyone at all familiar with how this vegetable operates would use plastic in that bed. Asparagus likes to wander around and come up wherever it pleases. And it likes a rich soil—just as weeds do, unfortunately. But an organic mulch will, as I said, dispose almost entirely of the latter. As you may know, asparagus stalks can, and will, push up through a hay mulch, which they could of course never be able to do if your plot is mulched with plastic.

"You also may know that air, rain, dew and sun reach the soil right through organic mulch. A plastic covering keeps all of these beneficial things from reaching the earth, although it's true that plastic will keep the ground damper than it would be if the soil stayed bare. But hay and leaves not only keep the earth moist, but also let dew and rain enter the soil, and help to hold the moisture in.

"Since I started to use organic mulch, we have had several seasons with long droughts—one summer no rain at all for three consecutive months. Although I can't water any plants in dry weather because my well is very shallow, yet I didn't lose one vegetable through those dry spells. Squash needs lots of water but despite that season with a three-months drought, I had an over-supply—one of the Blue Hubbards weighed 51 pounds," she said.

"When one of my neighbors (a confirmed organic gardener and mulcher) dropped in, I spoke of this plastic. Although I knew she didn't use it, I asked her if she could think of anything at all in favor of it as a mulch.

"My neighbor said that plastic is supposed to warm up the soil more quickly than hay. When I asked why she thought this, she hesitated for a moment then said that someone must have told her it did. 'Well, even if it does, what's so important about that?' I asked. 'You can, for instance, plant lettuce on frozen ground, and it doesn't seem to mind. After all, it's only early plantings that need warmed-up soil; the sun does the job for later crops. So for parsley, lettuce, peas, all you need do is take the hay off those areas in the fall and, in my experience, the ground is then never too cold to interfere with desired results.'

"She had one more suggestion which she thought might be favorable, and that was that since squash plants take up so much room in a garden, black plastic might make it easier to keep down weeds between the hills. However, I plant squash between my two rows of asparagus, and I've already said why I wouldn't use

plastic for the latter, even if I went a little haywire and wanted to do so," she concluded.

If you are concerned about producing those abundant, nutritional crops next year and next decade and next generation, you, like Ruth Stout, won't mulch with plastic. You'll find it cheaper to spend once—if at all—for a good organic mulch which will rot and fertilize your soil in time. You'll find you can do as well or better without plastic, the indestructible, non-nutritional mulch.

... AN ALTERNATIVE TO PLASTIC MULCH

So now the whole mulch idea has been ruined for you. Plastic mulch was all you were looking for in a mulch. Using it, you didn't have to scour the world for lumberyards with excess sawdust or farmers with spoiled hay or harrass your neighbors for leaves and grass clippings—they were beginning to think you daft, right?—or even continually spend money for more, since that organic stuff *did* keep disappearing. You could be completely respectable and order some from your local plastic mulch store, put it down in the garden and forget it. Well, maybe those shiny black indestructible strips in your garden lacked the visual appeal of a variety of rocks mulching away, or the warm richness of a layer of cocoa bean shells, some other natural mulch. But it could be acquired without people giving you funny looks and it didn't mess up the inside of the car and . . .

But it's ruined, right? Okay, try this. Use newspapers.

After you've read all the news, go out and throw it on the ground. It's one of the most effective ground coverings around. And it's organic. Even the ink provides trace elements vital to healthy plant life. Chances are, you have stacks of newspapers in your basement, just sitting there gathering dust and creating a fire hazard when they could be in the garden decomposing busily and creating good, rich soil.

Environmentally-minded mulchers have found that mulching with newspapers not only provides a great way to safely recycle as much as 50 per cent of our refuse but also to control weeds, improve soil texture and regulate moisture and temperature in the garden. They have been using newspapers for years to create a humus which is readily incorporated into the soil.

Here are some of the ways they've been doing it.

1) Laying them out in varying thicknesses of unfolded sheets, leaving space for rows or planting in holes punched through the paper;

2) Shredding or tearing the sheets into a fine aggregate which can be easily handled in beds and borders, also around trees and shrubs;

3) Using them as a liner under materials to conserve moisture;

4) Burying them with the family garbage in selected areas after tearing them into very small fragments;

5) Converting them into a highly mobile, flowing slurry by combining them with water in a pulping machine.

Mrs. Sherrelle Ault slides unfolded newspapers under "poultry netting" one foot wide. Number 9 wire or

coat-hanger wire cut about eight inches long, is bent into a "U" which goes on each side about three feet apart, and is pushed into the soil.



Newspapers eight layers thick keep trees and shrubs free from weeds.

"To renew the newspapers each year—and you must as they decompose underneath," the Missourian said, "take out the wire U's on one side, slide fresh newspapers under the wire, and replace the U's. I don't try to do the whole garden at once, but just go along—150 feet of wire costs \$5 here. But I don't need to buy it again because it lasts and lasts.

"The appearance is fine," she said. She also explained how she used newspaper and waste pulp to tame her stubborn hardpan garden soil.

"I have gumbo cement for a garden, and lots of luck to anyone who tries to plow on that site—no telling what else was buried there by a bulldozer. This was the only way to go ahead. Not being able to dig down deeper than one inch, and being on low ground which stands in water, the only thing to do was to build on top.

"This is also a great way to dispose of all your paper trash. Fold everything to about the size of a folded newspaper. This goes for cereal boxes and containers of all sizes (tear them open), wrappings—everything—because the wire holds them down and keeps them from blowing all over the landscape. Paper egg cartons—practically wood pulp—should be torn up and worked into the soil."

"I hope that mulching your garden with newspapers will be a continuing and growing movement," said Mrs. Margaret Hunter of Lake Worth, Florida. "I have been doing it for years, with more than one good result, the re-use of newspapers," she continued. She asserted that, "newspapers control some of the garden pests.

"I tried it with very good results on some pests including white fly, some scales and aphids. At first I just

put down three-or-four-inch-thick piles of folded papers, held down with just a piece of wood or rock around shrubs. With time, I began tearing the paper into strips, and covering the ground with them which permitted more uniform watering from the hose or the rain. I also found that the torn strips stayed put better and didn't blow around.

"As horticulture chairman of the garden club, I talked about the advantages of paper mulch to the members. After they came and saw my torn paper borders, many of them followed my example and I later received reports that they had obtained good results from using newspaper as a mulch."

Newspapers, dampened and torn into 30-inch long strips, will "tangle good when stirred lightly," Mrs. Hunter said. Method of dampening is not important just as long as the paper "flutters down in limp strips and no longer clings together in clumps.

"My garden is quite small," she reported. "I put the paper around the 'up' squash hills and along the newly planted okra row. When the okra was up and large enough to thin, I pulled the paper together with the plants. Considering the poor soil in this place, the okra is doing quite well as are most of the other vegetables and herbs. I am building up a good organic soil and the paper mulch is proving a big help."

Robert F. DeVoe, Sr., has followed organic gardening methods in eight different homesteads since he got started back in 1923. Today, he lives in Meadowvale, "a small town east of Louisville, Kentucky," where he mulches his vegetable garden and his strawberries with newspapers.

"I spread newspapers three to six thicknesses with

three-inch overlaps on all four sides over my vegetable garden," he said. "I covered this with the mulch pile which consisted of kitchen refuse, wood bark, weeds, grass clippings, flower and bush trimmings and cottonseed meal. I wet this down for several days before planting.

"I started with a few bush beans, and corn in peat pots, and placed them in rows. But at the east end I dug holes in the mulch and newspaper and placed the plants and seeds in the soil. Along the fence, I set out strawberry plants in newspapers with grass clippings on top and brick edging to make everything look neat and keep the papers from blowing."

Still another newspaper mulcher is Paul Graybill, who gathers grass cuttings, wood chips, fallen leaves, hay, weeds and vegetable refuse—garbage included—and then returns them to the soil together with a paper mulch.

"Without all the nutrients that organic materials add to the soil, my fruit and vegetables would have very little taste and practically no food value," said the Connecticut homesteader.

The surface mulching Graybill worked out overcomes many problems he's encountered in other methods. When plants reach a height of two or three inches and the ground is thoroughly warmed, he scatters fine organic material such as heap-prepared compost, grass clippings, shredded leaves or fine hay between the rows.

Next, he folds newspapers about four papers thick, places them in the rows and between or against the plants on each side, then scatters an inch or so of grass clippings, hay or other organic material on top to hold them in place. This type of mulch lasts through the

season—without further work. Additional fine material may be added during the growing period. Very few weeds come up, Graybill said, except a few now and then directly in the plant row, which can be easily pulled because the soil stays so moist and friable. Another advantage: the fruit and leaves of plants are kept clean, and the compost below the papers disintegrates fast. The paper itself decomposes by fall, ahead of preparations for the cover crop seeding.

When setting out young plants like tomatoes and cabbage, Graybill tears a slot in the paper, making it fit snugly around the stem, then covers the entire area about the plant before adding compost over the paper. He says he likes the paper-mulched method much better than plastic sheets, since it allows free moisture passage during rains and also allows some “breathing”, where plastic—unless perforated—allows no passage of water or air.

The paper-mulch plan is effective in the strawberry patch, Graybill said. Runners can be controlled by placing folded papers of 10 or more thicknesses between the rows in spring and covering this with hay. This leaves exposed a bed of strawberries about eight inches to a foot wide in the row itself. And it kills the runners which are covered, holds moisture, and keeps the strawberries clean during the bearing season. He thins these narrow beds by pulling out plants after picking season.

Newspaper mulching works two-fold wonders. It is a good organic mulch in the garden. It relieves the community of a portion of its increasingly heavy burden of solid waste. So send that plastic back to its maker and mulch instead with newspapers.

Chapter Seven

THERE'S METHOD in THIS MULCHING

Hopefully, you've been convinced. And you've run out and gathered up all the mulching materials you could lay your hands on. Now you're standing beside the garden, hay in hand, with a slightly quizzical expression. There're a couple of questions.

“When do I mulch? How much do I use? How often should I mulch?” you're asking. “What about fertilizers? Don't I need fertilizers at all? Are you sure this is as easy as it sounds? I'm going to goof it up, right? Because there's something you forgot to tell me, right?”

Just relax. Mulching is as easy as it sounds. You won't goof it up as long as you are careful and follow a few guidelines. We won't give you the steps of the perfect way to mulch your garden, because such a way doesn't exist. We will point out mulching guidelines and a few of the most common pitfalls. A good organic

gardener, of course, always likes to experiment a bit and develop a specially-adapted method. Thus the variations on when and how to mulch are as numerous as the materials you can use. We'll give you the maps. You'll have to select your own route.

The answer that Ruth Stout always gives to the first question—when should the mulching begin?—is “NOW, whatever the date may be.” That's as good an answer as you can expect. There are, basically, three kinds of mulching—summer, winter and continuous. Miss Stout is of the continuous school of mulching. Other experienced mulchers find fault with a continuous covering and opt for covering their garden soil only a part of the year.

The chief reason for a mulch in winter is to prevent damage to plants from alternate freezing and thawing which causes soil to heave and expose and break roots. Winter mulches, too, protect the more tender plants not perfectly suited to rougher climates. And they protect plants against rapid changes of temperature. In many sections the temperature often ranges from 15 to 20 degrees in 24 hours. Under a mulch the temperature remains more constant.

The mulch should be applied *after* the first hard frost to prevent alternate thaws and freezes from heaving soil, roots or bulbs. Its purpose once winter sets in is to hold the lower temperature *in* the soil, avoiding thaw and subsequent refreezing which shifts the earth and plants, often exposing enough roots to cause winter-killing. To protect young shrubs, and particularly roses, mound several inches of earth around them early in autumn, then mulch after the first freeze with several

more inches of leaves, straw, yard trimmings, or other mulch materials.

The winter carpet of organic matter also helps condition the whole garden area for the next spring.

A summer mulch, applied as soon as plants are established, allows the temperature under it to rise and fall gradually, to remain uniform and about 10 to 15 degrees cooler than that of unmulched areas close by during normal air temperatures.

The more even, cooler temperature under a mulch helps to maintain a better balance between the plant's loss of water (transpiration) and its absorption of water. It does this even during hot, dry days when transpiration exceeds absorption and causes unmulched plants to wilt. A mulch acts as a reservoir. It conserves water by providing a greater area for absorption and an uneven textured surface which prevents water from running off.

After you've planted most of your vegetables your primary concern will be how to protect these plants from the coming summer's hot, dry weather. What should you do? Mulch.

The third kind of mulch, the continuous mulch, serves the dual purpose of both the summer and winter mulch. It protects whatever plants are in the ground and steadily works to condition the soil. A mulch used the year around serves to control weeds, conserve moisture and provide plants with protection against the extremes of weather. If it is one of the coarse materials with rough, irritating surfaces, it will discourage slugs and snails from crawling over plants and damaging them.

A continuous mulch around thick-stemmed perenni-

als, shrubs, trees, evergreens should be of a coarse, heavy material not subject to rapid decay. Straw, hay or cotton bolls may not appeal to you for this purpose because they break down fast and must be replenished regularly.

Woody materials and coarsely ground cobs are ideal. They last from three to five years, when applied to a depth of three to four inches, and relieve the gardener of the chore of cultivation and worries concerning drought and heaving of soil. The only maintenance such mulches need is a nitrogenous fertilizer in spring and midsummer and a raking, when necessary, to open them up to air and water.

Most of the hard-core mulchers—like those whose experiences with mulching have been related—use a continuous mulch. But they generally have some reservations about the continuousness of the cover.

There *can* be too much of a good thing. There can be advantages to pulling back the mulch on certain occasions to allow the ground to warm. And while a year-round mulch does the job on sandy soil, it can defeat the purpose on heavy clay.

Most gardeners agree that mulch timing is important to produce bumper crops and have learned by their own mistakes or experiences to abide by a few general rules.

Seedlings planted in very moist soil should not be mulched immediately. The addition of any organic matter which keeps the soil at a high humidity encourages damping-off of young plants. Damping-off is a disease caused by a fungus inhabiting moist, poorly ventilated soil, and can be 90 per cent fatal. Allow seedlings to become established then, before mulching.

It is wise, too, to consider the danger of crown-rot in perennials. This disease is also caused by a fungus. If there have been especially heavy rains, postpone mulching until the soil is no longer water-logged. Do not allow mulches composed of peat moss, manure, compost, or ground corn cobs to touch the base of these plants. Leave a circle several inches in diameter. The idea here is to permit the soil to remain dry and open to the air around the immediate area of the plant.

Do not mulch a wet, low-lying soil, or at most, use only a dry, light type of material, such as salt hay or buckwheat hulls. Leaves are definitely to be avoided as they may mat down and add to the sogginess.

The heavy mulching method described by Ruth Stout stands a better chance of success if the soil contains some humus (well-decayed organic matter) and is fairly high in nitrogen content.

Where the soil is poor and mostly clay in composition, it is well to test the soil and apply the needed elements, as nitrogen, phosphate and potash, according to test results. Then spread the mulch in thin layers without packing, so as to permit air and moisture to start breaking down the raw materials. When the first layer of mulch shows signs of decay, sprinkle some cottonseed meal, blood meal or other nitrogen-rich material and apply another thin layer of mulch. By this method, any danger of the heavy mulch taking too much nitrogen from the soil is avoided.

Some vegetables, like tomatoes and corn, need a thoroughly warmed soil to encourage ideal growth. A mulch applied too early in the spring, before ground temperatures have had a chance to climb a little in

frost-zone areas, may slow up such crops. Once plants are well started, though, and the weather levels off, mulch is definitely in order to conserve needed water, stimulate topsoil microorganisms and generally condition the soil.

Author-gardener John Krill pinpointed the importance of logical mulch timing for tomatoes, for example. His experiments—and the experiences of others—show that early ripening of tomatoes cannot be expected if the spring-thawing ground is cloaked too soon.

“Mulch can be a hindrance instead of a benefit under certain conditions. The deeper the mulch, the greater the drawback,” he said. “I’m a mulch addict for more years than I care to name. If I named how many people would say ‘He’s too old to know better’. Yet I will venture that many mulch enthusiasts have undergone the same experiences I have.

“With the coming of the true spring weather, I’d be in the garden planting tomatoes. The plants were set properly and lovingly in their holes. Then I’d carefully mulch them with any suitable substance available,” he said. “The plants never failed to respond and grow sturdily. Their color was a green to delight the eye of the most critical gardener. As the mulch would compact itself, I would busily add more. There wasn’t a weed to be found because the mulch prevented them from coming up.

“Ah! That part of growing tomatoes was simply unbeatable. But guess who had the first *ripe* tomatoes? None other than the people across the street. They didn’t mulch because they had not yet learned of its tremendous value. They weren’t the only ones. Friends

living miles away and scattered in every direction also had ripe tomatoes sooner than I.

“What hurt me the worst was that I had given tomato plants to them from my hotbeds. Why did their tomatoes ripen ahead of mine since they were of the same identical stock? Sure, I couldn’t help noting that their unmulched plants did not produce as much. Nor did they last until frost finally destroyed them, as was the case with my own mulched plants. Hot and dry weather withered and destroyed their plants long before a frost came, while mine were just coming into heavy production of ripe fruit.

“There had to be a connection between mulched and non-mulched plants. A little serious thinking prompted me to conduct a simple, but extremely illuminating experiment. When spring once more arrived, I had my experiment ready to try. I set out three rows of tomatoes. All the plants came from the same hot-bed. The first row I covered with mulch as I had always done. I left the second row bare. No mulch was applied. And during the growing season I kept this row well cultivated. I did not water these unmulched plants because I had never watered those I did mulch. The only thing I did was keep the soil loose and weed-free. It turned out that it was a season of ample rains and watering would have been totally unnecessary. The natural moisture was a definite help in the experiment.

“The third row was also left unmulched—up to a point. As soon as the tomato blossoms appeared, I gave up clean cultivation of this row and covered it with a straw mulch. The other row which I had left clean and without mulch also showed a good set of blossom. But

the mulched row was just showing signs of developing buds. It would take 10 to 15 days to produce the blossoms that were already in bloom on the two unmulched rows.

“The mystery was clearing up. Sure enough, the unmulched row produced the first ripe fruit. Almost neck-and-neck with it ripened the fruit in the row I had mulched after flowers had appeared. The fruit was heavier, juicier and far better shaped than in the row which had been left unmulched. The mulched row? It was the same old story. The plants were beautifully

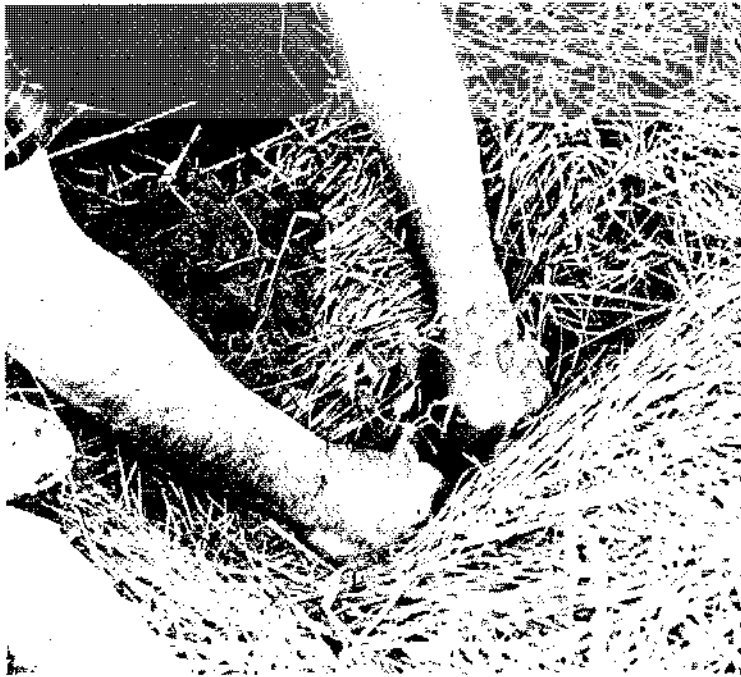

Mulching of tomato plants too early in the season can slow ripening.

green and just loaded with fine-shaped green tomatoes. There wasn't a single ripe tomato among them. It would be two weeks or more before there would be any ripe ones," he said.

“But I had the key to the whole thing. By mulching the tomatoes when I had set them out in the spring, I had slowed down their growth. It takes a lot of heat to warm the soil in the spring to where it will stay warm. The mulch I had applied so soon had simply insulated the soil against absorbing warmth from the sun and air. Tomatoes like plenty of warmth. With the mulch keeping the soil from warming thoroughly, the plants were late in setting their blossoms. Consequently the fruit developed and ripened tardily. That this was so was easily proved. I laid my hand on the bare ground. It felt warm. I thrust my hand under the mulch. The sensation was one of soft coolness, something that the plants would tolerate, but which would not accelerate rapid development.

“How about the row I had mulched after the blossoms appeared? It was a dandy. By the time the flowers had developed, the soil was thoroughly warmed by the advancing heat of summer. The thin mulch now acted to prevent the warmth from leaving if sudden cool days and nights arrived. With heat under the mulch and more heat beaming on top of the mulch, these plants set heavy and well-shaped fruit that ripened practically as soon as that of the unmulched row,” he said.

“About the middle of August the unmulched row began to shrivel and dry from a prolonged spell of heat and drought. The plants soon died. But the remaining two rows with their mulch coverings seemed to wax

even more vigorously, with the row that had been mulched from the very start now coming into full ripening. Both of these rows produced good tomatoes until frost.

"I have learned this lesson: that if mulch is applied before the earth is thoroughly warmed, it will delay the ripening of tomatoes. I apply mulch now only when flowers are profuse, or even wait until the fruit sets before mulching the plants. Then the mulch seals the heat in instead of sealing it out. Thus it pays to know when to mulch.

"For late-ripening tomatoes I mulch my plants heavily when I set them out. For the earliest possible I set out enough to get ripe fruit in unmulched soil until the juicier and better-flavored tomatoes are ripened in the mulched rows. By the wise use of mulch you can prevent tomatoes ripening all at one time.

Bart Burdick confirmed Krill's conclusion.

"My garden was located approximately four miles south of Cornucopia, Wisconsin, which is Wisconsin's northernmost village," he said. "Temperatures drop to 20 to 30 degrees below zero—and occasionally to 40 below in midwinter. In spring the ground is slow to warm up.

"I set out my tomato plants in peat pots. My brother-in-law set out his plants a week later, minus peat pots. I mulched mine; he didn't. His tomatoes ripened seven to 10 days before mine. His ran out faster due to frost. Mine kept ripening for another week," Burdick explained.

"My conclusion as to the difference in time of

maturity: the same as John Krill. I should have left the mulch off *until* the soil had warmed sufficiently, then applied my mulch" he said.

In North Carolina Vernon Ward plowed and harrowed, then mulched the ground with about six to eight inches of wheat straw. Then, using Rutgers plants, he set his tomato plants through the mulch at a distance of four feet apart each way. To set the plants he pulled the mulch apart and set the roots in the prepared ground, then pushed the mulch back together around the stems. This was the end of his work. He did nothing else the entire season but pick tomatoes. Dark green vines soon completely covered and obliterated the mulch. No weeds grew. There was an immense set of fine tomatoes which remained large, with hardly any culls throughout the growing season, and the vines were still full of tomatoes at frost.

Ruth Stout mulches continuously and heavily. Unlike some gardeners, she doesn't differentiate between summer and winter mulches. She doesn't plow under the winter covering in spring, although many gardeners do this successfully. She doesn't plow at all. She is a strong believer in the continuous mulch, but she doesn't quarrel with the likes of John Krill and even admits to pulling back the mulch from ground slated to receive certain plants—like tomatoes—in spring. She has advice on the best ways to use mulches around your plants at spring planting time.

For spinach, lettuce and peas you should place six to eight inches of mulch. Shade the lettuce if you can. For beets, carrots, parsnips and kohlrabi: first thin the

plants; then water thoroughly and put mulch all around them at once, six inches deep between rows. If the mulch is wet, so much the better. For bush beans: if already planted, thin, water and mulch. If you haven't planted them already, make a drill four inches deep; plant the beans sparsely; cover with two inches of soil; water; cover with a board or cardboard and mulch. Remove the board as soon as beans sprout. For corn: if planted already, thin to two plants in a hill instead of customary three. Water and put down six inches of mulch. (If you're running out of mulch, use as many layers of wet cardboard as you can collect. The cardboard is only an emergency measure; it is not as satisfactory as hay or leaves, because the latter provide more valuable nutrients to the soil as they decompose.) Each time you plant corn soak the seed overnight, make four-inch drills and cover the seed with two inches of soil. Water thoroughly, put a board over the seed and mulch immediately.

For late cabbage, broccoli, cauliflower, peppers, and tomatoes: if not planted yet, put very deep and four feet apart, mulching heavily. If peppers and tomatoes aren't in, put them very deep and farther apart than customary. If already planted, water and mulch heavily (six to eight inches).

For flowers: "All flower beds should be under a constant mulch, drought or no drought." Miss Stout said that you can easily do this without making them look ugly. Peonies can be mulched with dead leaves and their own tops. Well-rotted hay, mixed with crushed leaves, makes an excellent cover for roses. Put it on six inches deep and then scatter soil on top. It all looks like soil

then, but the mulch is so deep that weeds can't sprout. The same method works well for large annuals, such as zinnias.

For small, low-growing annuals, Miss Stout used a fine mulch. "Since I keep my whole vegetable garden mulched constantly, there is always material there, not quite rotted enough to be rich soil, but rotted enough to look like it. I put this round my small annuals. If you don't have such material, you can use crushed leaves mixed with a little soil and wood ashes. This may sound like quite a job, but you have to do it just once a season."

The catch in mulching—if really there is one—lies in deciding on the amount of mulch to use. Should a good mulch always be the same depth? Must it be measured to slide-rule accuracy to function right? Do any other considerations influence the proper quantity? In other words, how much mulch is enough?

Generally, gardeners mulch crops that are in the garden for most of the summer. How much? During the growing season, the thickness of the mulch should be sufficient to prevent the growth of weeds. A thin layer of finely shredded plant materials is more effective than unshredded loose material. For example, a four to six-inch layer of sawdust will hold down weeds as well as eight or more inches of hay, straw or a similar loose, "open" material. So will one or two inches of buckwheat or cocoa bean hulls, or a two-to-four inch depth of pine needles. Leaves and corn stalks should be shredded or mixed with a light material like straw to prevent packing into a soggy mass. In a mixture, unshredded leaves can be spread eight to 12 inches deep for the winter. To offset the nitrogen shortage in sawdust and

other low-nitrogen materials, add some compost, soybean or cottonseed meal.

Ground corncobs are highly recommended. Light and bulky, they help to “fluff up” the soil, thus preventing crust formation. Peat moss, an old stand-by, can be spread an inch or more in vegetable gardens and flower beds or used as a half-inch top-dressing twice a year on established lawns. Other good materials which can be used in the same manner include cotton gin wastes shredded cotton burrs, oat, rice and cottonseed shells and sphagnum moss.

How much mulch do you need? For her system of year-round mulching, Miss Stout says, you should put down, “more than you would think. You should start with a good eight inches of it. Then I’m asked: ‘How can tiny plants survive between eight-inch walls?’ And the answer to that is: the mulch is trampled on, rained on and packed down by the time you are ready to plant. It doesn’t stay eight inches high.”

Once you’ve put the basic mulch down, it is going to start decomposing and it will need replenishing periodically. How often do you replenish? That’s something you will have to determine by observing the breakdown and compaction of your mulch. According to Miss Stout, the time to add to the cover is “whenever you see a spot that needs it. If weeds begin to peep through, don’t bother to pull them; just toss an armful of hay on them.”

Speaking simply, the amount of mulch to use is the amount that does the best job for you, your soil and your plants. Working out an ideal mulch program takes some experimenting, some trials with various materials

and depths. It’s only common sense to check on the most plentiful free and reasonable sources, to test the effects of different mulches in your climate locale, your own soil type and timing.

Are mistakes ever made in mulching? Of course. But with simple precautions you can avoid them. Before tossing armfuls of hay around, remember to use a partly rotted mulching material. New mulch will sometimes rob the soil of nitrogen. If you have only a small amount of decomposed material, put just a thin layer of it on the ground, then sprinkle some nitrogen-rich fertilizer such as bone meal, manure, cottonseed meal or tankage on the topsoil first. Another important thing is that mulch will be more effective if put on after a good rain—for it is difficult for water to penetrate a thick covering. If the ground is dry to start with, it will stay dry the rest of the summer unless the skies really open up.

“As wonderful as mulching is, it must be done right or the results may be disappointing,” said Lucille Shade. “During my first few years I made many mistakes. For instance, I mulched corn with bright new hay and wondered why it didn’t do well—without realizing that this brought a temporary nitrogen shortage as the hay started to decompose. I mulched other crops with oat straw and got a fine but unwanted crop of green oats between the rows of vegetables. I used timothy hay as a winter mulch for strawberries—and the following spring I had timothy coming up all over the strawberry bed. Nothing is harder to discourage when it’s up close around the plants. I finally gave up and started a new strawberry patch,” explained the Ohioan.

“Over the years I’ve learned some techniques that

make for successful mulching every time.

“First, if it is at all possible, use partly rotted mulching material. New mulch will rob your soil of nitrogen, which explains why my corn did so poorly under a mulch the first time I tried it. If you have only a small amount of partly decomposed material, put just a thin layer of it on the ground, then cover it with a thick layer of new stuff. If you must use all new mulch, then sprinkle some nitrogen-rich fertilizer such as blood meal, manure, cottonseed meal or tankage on the topsoil first. The only place I use new mulch without extra nitrogen is in covering large areas of ground—such as in the melon, cucumber and tomato patches—with rotted mulch up close around the plants.

“To age baled hay or straw in a hurry, soak it thoroughly with water, then give it six to eight weeks to start decaying,” she said.

“A second important thing I’ve learned is that mulch will be much more effective if I wait until we’ve had a good rain, and then put it on—for it is difficult for water to penetrate a thick covering. If the ground is dry to start with, it will stay dry the rest of the summer unless the skies really open up. My spring gardening season is divided into dry and wet days. On wet days I concentrate on mulching, leaving all other chores for dry days.

“I’ve also discovered that simply pulling the mulch apart in the spring and planting my seed doesn’t work on my heavy clay soil. I must open up a space about a foot wide in order to let the sun warm up the soil. I’m especially careful not to hurry mulching of such warm-weather lovers as tomatoes and melons. I start at the outer edges of my melon patch, for instance, and keep

covering the ground until I get within about a foot of the vines. Then—once the weather is good and warm and the melons are off to a good start—I finish the job, mulching in close around the vines. In my climate, I’ve



Best time to mulch is after a shower. Small weeds are smothered out with hay.

found it's best to hold off close-up mulching of tomatoes until they have started to set fruit," she said.

"If your mulch starts sprouting—as my oat straw did—simply turn it over. It takes only a few minutes to walk down a row flipping it upside down.

"I am more careful now in selecting hay for a winter covering on strawberries. The trick is to use hay that was cut early, before the timothy became ripe enough to shed its seed. You can do this by opening up a bale and shaking it. If fine, chaff-like seed falls out, don't use it for this purpose.

"Nothing you can do to your garden will benefit it more than mulching," Mrs. Shade concluded. "It can substitute for the chemical gardener's watering, fertilizing, soil conditioning, and hours of weeding. What else can do so much for you?"

Morton Binder ran into nitrogen problems similar to those of Mrs. Shade. Binder, you may recall, turned to a mulching program to solve his soil problems. While still in the soil conditioning stage of his program, Binder wanted to set out some canned fuchsia without waiting.

"I dug the holes," he said, "and added two shovels of leaf mold from the woods to the sawdust soil mixture. As soon as the fuchsias were set out, I mulched them with manure to begin to offset the lack of available nitrogen during the rotting-down process of the sawdust. The results were as follows—and, I think the moral of the story and the lessons learned may prove valuable to others attempting the same trick:

"In spite of the manure, the fuchsias rather quickly developed nitrogen starvation symptoms. I gave them a handful of processed sewage and a tablespoon of blood

meal, but it wasn't until three months had elapsed that the color returned and the results became satisfactory.

"The other portion of the bed was not planted until four months after the first. These plants developed no chlorosis, and normal feeding brought out good color. Four months later both groups of plants appeared quite healthy, and no different in final results," Binder said.

"It proves again what has often been said. 'Don't plant immediately in freshly prepared soil where unrotted organic material has been used in large quantities. Wait until the breakdown process has had time to work.'"

The reason for these gardeners' woes is that substantial amounts of nitrogen are required for decomposing plant residues. When an organic mulching material does not contain all the nitrogen required for decomposition, the mulch tends to "borrow" nitrogen from the soil or fertilizer applied to the soil, leaving less nitrogen available for plant growth during the decomposition process. Consequently, signs of nitrogen deficiency are frequently observed in plants grown under heavy mulches, unless sufficient nitrogen fertilizer is added to compensate for the soil or fertilizer nitrogen required in the decomposition process. The amount of additional nitrogen fertilizer needed to compensate for the nitrogen tieup varies with the type of mulch and its state of decomposition.

Duration and severity of the nitrogen depression sometimes observed following application of organic mulches is affected by a number of factors in addition to the kind of mulching material used and its nitrogen content. Soil fertility—particularly the amount of nitro-

gen in the soil—is a significant factor in determining whether or not crop yields will be affected adversely under mulching. This is illustrated by studies of wheat grown in various sections of the west. Although yields grown under a system of mulch farming tended to be less than under moldboard plowing in most areas studied, no depressing effect on grain yields was observed in areas where the nitrate content of the soil was high.

Increases in the amount of soil nitrate following application of mulch occur under some conditions. In fact, such an increase has been reported in the majority of studies in which “inert” mulches such as plastic were used.

When decomposable mulches such as straw or hay or manure are used, the rate of decomposition and the proportion of carbon to nitrogen are significant factors in determining whether mulching will increase or decrease the nitrate content of the soil.

The point is that mulched crops must have an abundant nitrogen fertilizer supply, else the crop will show temporary nitrogen starvation. This is true because soil bacteria stimulated by the better growth conditions under the mulch tend to gobble up available soil nitrogen. Of course, these tiny motes of vegetable life soon die and decay, and give back to the soil quickly available higher-plant food. But there is a lag when you first mulch during which they need to be fed extra nitrogen.

This is why experienced mulchers like Ruth Stout sprinkle a bit of cottonseed meal or blood meal on the soil before planting. The soil can be treated with compost or manure, but Miss Stout doesn't go in for the

extra work and doesn't recommend the process unless the soil is deficient and really needs conditioning. The soil in her garden, for example, is in proper condition and is kept that way continually by her mulch. A soil test is a good way of determining whether or not your soil has deficiencies.

Another deficiency that'll do in your plants is a lack of water. As Mrs. Shade learned, the best time to mulch is after a rain. Or, failing that, after the soil has been watered. A mulch is a good moisture conserver, but it can't conserve what isn't there.

By the same token, however, too much water isn't good either. This is why good drainage is important. A too-wet soil is trouble for a garden, and mulching a too-wet garden is just compounding the problem. If you can't solve the problem of an overabundance of water naturally—as Bob Wandzell did by selecting a slope for his garden to promote runoff—a few drainage ditches might help. This is the solution Cynthia Williamson chose.

“Ruth Stout had been talking about mulching humus-rich sandy land,” said the Michigan mulcher, “and I was going to mulch humus-poor, heavy soil. Although I realized it would take two or three years for the mulch to condition the earth, I failed to realize that my heavily compacted soil was badly in need of drainage ditches in the lower end.

“Our part of Michigan has had extremely heavy rainfall. After a 4-inch downfall, when the water stood in pools around my transplants of lettuce, tomatoes, peppers and cabbages, it dawned on me I had problems. At

the site of an old compost pile, the soil crumbled like moist, light cake; but in the lower end of my 50-by-100-foot garden, the soil was extremely heavy and fell off the spade in tight, wet clods.

“This lower area of the garden had grown tomatoes for two years. The vines had been beautiful and lush with fruit, but frost had hit before a majority could ripen. Previously I had blamed their late maturity on a heavy layer of mulch, but after reading that tomatoes ripen faster on a light, humusy soil I began to wonder. Green peppers had the same trouble. There was plenty of fruit on the vines, but they just didn’t grow or ripen rapidly. Perhaps I was too hasty in mulching the entire garden without first enriching the soil’s humus content.

“Although tomatoes and peppers had plagued me, other vegetables did well in this area surrounded by mulch. Green peas planted in mid-July stretched up and bore heavily. Late cabbages did well, even though I fed them nothing but a little compost at the start. Now that the area is well-drained, my head lettuce and leaf lettuce grow in abundance, unaffected by the heavy soil, and mulched thickly,” she said.

Are there mistakes you can make? Sure there are. But the biggest one you can make is to refuse or to neglect to mulch your garden—or to give up on mulching after one less than abundantly successful try. There’s more to mulch than meets the eye. A successful mulch garden may not come overnight. Humus-poor soil won’t be rejuvenated in one growing season, so don’t expect too much that first year, or the second, for that matter.

Rather, weigh the experiences of others. Test your soil, study its strengths and weaknesses. Consider your climate. Investigate the various mulch material available to you locally in abundance. Then, observing the guidelines and existing conditions, set up a program.

Then get out there and mulch!!!

Appendix I

CALENDAR GUIDE for SEASONAL MULCHING

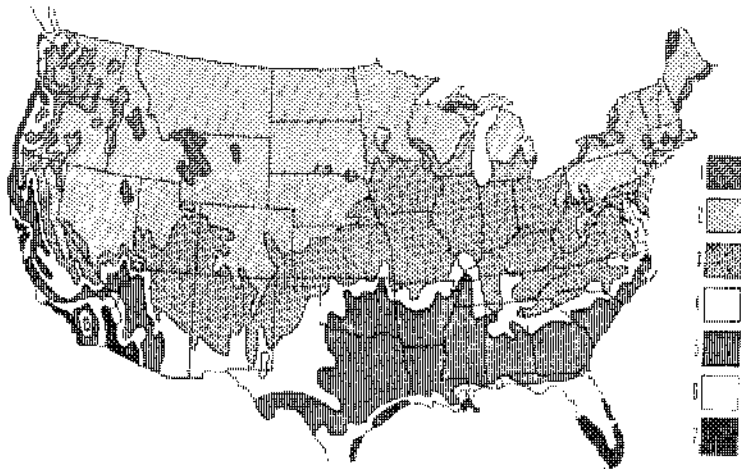

Average date of last expected spring frosts: Zone 1, June; zone 2, May 10-30; zone 3, April 10 to May 10; zone 4, March 20 to April 10; zone 5, February 28 to March 10; zone 6, February 8-23; zone 7, January 30 to February 8.

FEBRUARY: Turn over cover crops and spring weeds and cover the soil with mulch immediately if you are in an arid or drought area. In all other areas the spring

crop will grow faster if you leave the soil uncovered for a week or two to warm up before you apply the spring mulch.

After the snow melts in the northern areas, check the mulch in your flower gardens and loosen it where it has become packed down during the winter.

In Zones 2 and 3, start removing the mulch from spring-flowered bulb beds.

In Zone 6, remove mulch from roses, and allow the soil to bake for a couple of weeks before you apply a mulch of new materials. Use the old mulch to enrich the compost pile.

MARCH: In Zone 4 and northward, shred old asparagus plants with either the lawn mower or shredder and return them as a mulch. Mulch half the asparagus bed heavily with a fine material such as cocoa bean shells, well ground corncobs or partly broken down leaf mold. Let the other half of the bed unmulched until shoots begin to break through the mulched half. This extends the asparagus season, because the unmulched part of the bed will begin to bear one to two weeks earlier than the mulched part.

In orchards, pulverized rock fertilizers can be spread below the trees and berry bushes. Work the materials into the top layer of soil before covering it with the summer mulch.

In northern perennial beds, loosen the leaf mulch as soon as the snow has melted, but don't remove this winter mulch too soon. One of its purposes is to keep the ground frozen until it will remain permanently thawed. In Zone 4, work into the soil any manure that remains on the surface around roses, and allow the sun

to bake the soil for a couple of weeks before you apply the summer mulch.

APRIL: The winter mulch should be off your planting rows by now, even if you had a dry, snowless winter. Give the spring sun a chance to warm the soil and bring it to life. Later, as the season advances, pull this rather thin mulch back to the row, and add to it as much as you can.

Be shrewd about your mulching. Delay it as long as you safely can in order to warm the soil, without losing too much moisture.

Mulch is more important in the hot Southwest than possibly elsewhere. Residents there should mulch their azaleas and camellias thoroughly with compost or leaf mold, keeping them well watered, especially while they are putting forth new growth after flowering.

In Zone 3, when tomatoes can safely be set out without protection, draw a hay mulch up to the stem of each plant.

In all sections of the country, use the early grass clippings for mulch. These are very rich in nitrogen in this season.

In the orchard spread nitrogen-rich fertilizers around fruit trees and berry bushes if you have not already done so. Cover the fertilizer with a thick mulch of hay, preferably alfalfa.

MAY: Planting will be underway by now and your mulching should be, too. In Zones 4–7, planting must be done immediately for summer crops. When plants are four to five inches high, apply a mulch at least three inches deep. Use old sawdust, hay, leaves, pine needles, or rocks to hold moisture, lessen weed growth and cut

down on labor. For these zones, the importance of mulching cannot be overstressed. Continue to gather mulching materials to replenish the ground cover.

In Zones 1 and 2, the winter mulch will have come off a bit later, but the spring soil conditioning program should be nearing completion and some hardier plants should be planted by mid-month. Almost all planting should be done by the beginning of June.

JUNE: Vegetables should be mulched heavily before the dry summer days arrive. You can speed growth for hardier plants by sprinkling cottonseed meal before the new mulch goes on.

JULY: If weeds are starting to push up through your spring mulch, the time has come to spread a few extra bales of hay. The best time to do this is right after a thundershower, when you have fresh moisture to protect. Tiny weeds can be smothered out with hay—no need to pull them first. Draw the mulch up close to the stems of plants like tomatoes, peppers, eggplant and corn. When spreading it next to lettuce, cover the ground first with newspaper and save yourself an extra-difficult washing job later.

AUGUST: Even if you started with newspaper, you may find it pays now to tuck straw and hay around the plants in the row. As for the paths and middles, you can use whatever comes handy to keep the soil from crusting and becoming trodden.

In the vegetable garden, check the mulch in the planting rows and patches to make sure it is not running too thin. Shade the compost pile this month with a thick layer of straw mulch.

Tomatoes may need a fresh layer of mulch at this

time. In the orchard, if a thick mulch has been maintained under the trees all season, it might help the pest situation to rake it away and supply a fresh mulch.

SEPTEMBER: Start now to collect organic materials for winter mulching or for sheet composting. As fast as garden rows are emptied, cover them with layers of materials that will break down during the winter, and that can be turned under in spring. Shredded leaves, fresh manure, hops, apple and castor bean pomace, ground corn cobs, bean and peanut shells are among the materials obtainable in the fall.

OCTOBER: In the North, azaleas and rhododendrons should be mulched with leaves. Central states gardeners should haul back the mulch six to eight inches from the trunks of fruit trees and grapevines.

Mulch Jerusalem artichokes with a thick layer of leaves as soon as soil has a frozen crust. The leaves will prevent hard freezing, and you should be able to push back any snow and to dig tubers at any time during the coming winter. Fall carrot plantings may be treated the same way in all but the very coldest areas.

New strawberry beds can be started at any time from now until midwinter in Zones 5, 6, and 7. Mulch the rows with clean, new straw after planting.

In Zones 1 and 2, mulch peonies with rich manure as soon as the ground freezes. Also cover the rock garden with evergreen boughs as soon as cold weather arrives to stay. This will anchor the snow, so essential to the health of Alpines.

In the orchard, push back mulch six to eight inches from the bases of the fruit trees to discourage rodents that plan to build their winter nests there.

NOVEMBER: Mulch heeled-in fruit trees that have arrived too late from the nursery to be planted. Mulch with straw after the soil is frozen ringing hard, so that the mulch does not harbor field mice.

Clear up all fallen fruit and old leaves, before applying a new fall mulch of leaves. Allow the ground cover to extend beyond the drip-line, but leave a bare area one foot wide around the trunk of each tree to foil the mice. Weigh down the new mulch with large, flat rocks. This procedure is particularly recommended for stone fruits suffering from gummosis.

Otherwise, spread rich manure under the trees and shrubs when they are dormant, covering it immediately with straw, hay or wood-chip mulch. This prevents ammonia from escaping, and will also give winter rains or melting snow a chance to leach it down to the plant roots. Again, leave a one-foot center well open around each tree trunk to prevent damage.

Give the berry bushes a good layer of wood chips, manure, sawdust, or shredded leaves. Blueberries must have an acid mulch—oak leaves are fine—but the others are not so particular.

Compost piles in Zones 4 and 5 can be kept active all winter by mulching them heavily with hay or straw.

For roses whose hardiness may be doubtful, build an overcoat of burlap stretched around 4 posts to surround each bush, and fill the enclosure with a mulch of chopped corn cobs.

Be sure to inspect winter mulches after each heavy windstorm.

Appendix II

MULCHING SOME SPECIFIC PLANTS

Vegetables

ARTICHOKE

Artichokes, Jerusalem or otherwise, thrive under a good light mulch with lots of nitrogen and a moist, well-drained soil. Any nitrogen-rich mulch material will do. Its thickness should be increased as the growing season progresses. The tops can be used as a winter mulch after the vegetables are harvested.

ASPARAGUS

Like most garden plants, asparagus thrives when properly mulched. In the spring you might want to take your nitrogen-rich grass clippings and save them for the asparagus bed. Sometimes it's a good idea to divide your asparagus bed in half. Mulch half the bed heavily with a fine material such as cocoa bean shells, ground corn

cobs or partly decomposed leaf mold. Leave the other half unmulched until shoots begin to break through the mulched half. This technique will extend the asparagus season, because the unmulched part of the bed will begin to bear one or two weeks earlier than the mulched part.

At any rate, mulching your asparagus bed will keep it weed free if you use available organic material such as old hay, leaves, straw, salt hay and dried grass clippings—about eight inches for a season. If you want a steady, yearly supply of thick, delicious spears, you repeat that practice every spring.

When you finish your asparagus planting, sometime in late spring or early summer, weed the bed thoroughly, feed it and give it a thick mulch blanket. For the winter, mulch asparagus thickly with fresh manure or compost and allow the top to stand until spring.

One organic gardener, Brownson Malsch of Texas, tried experimenting with cotton-burr mulch on his asparagus beds. It's a material that's handy there and, like most natural materials, it breaks down readily and turns to a mellow compost. The material's obtained directly from the cotton gin, spread several inches deep making for easier maintenance of the planting site. It's rich brown appearance gives an attraction to the planting area while it controls weed growth at the same time.

BEANS

Like most plants in the garden, beans will respond favorably when mulched. Perhaps the most serious cultivating problem in growing beans is the control of weeds. The bean roots are often close to the surface and

any deep or extensive cultivation to halt the weeds will result in undesirable root pruning. But a heavy mulch will work for you in keeping down the weeds and give you an added plus in preserving moisture in times of drought. Gardeners have mulched beans successfully with grass clippings and oat straw. The result will be some healthy looking plants and some mighty good eating.

BEETS

Beets are alkaline soil plants, and won't grow in acid soil. It is wise, then, to load your mulch with alkaline materials or use some ground limestone. A light mulch should be applied immediately after planting to conserve moisture and prevent the sun from baking the soil. When sprouts appear, pull the mulch back somewhat. As the growing season progresses, increase the thickness of the mulch and tuck it in close to the maturing plants. Beets thrive in a humus-rich soil, and a continuous mulch will contribute to this condition in your soil.

BROCCOLI

Broccoli should be well-mulched to preserve moisture. Organic gardener Joan Pierson used matted leaves with excellent results. She applied forkfuls of the leaves between the rows of plants, checked a substantial weed and insect problem and produced superb broccoli. Another Joan—Lindeman in this case—uses hay mulch with similar results.

CABBAGE

Spread some mulch on your cabbage bed and watch the cabbage respond. Near the Grand River in Eaton

Rapids, Michigan, Charles Carter grew 18 jumbo heads of cabbage—one of them a real tape measure gem. Carter used rabbit manure as fertilizer and irrigated with river water he brought to his garden with a small electric pump. The mulching was supplied by a nearby sawmill which gave out sawdust just for the asking. When the Carters began harvesting their cabbages, they discovered one head measured 52 inches around and tipped the scale at 35 pounds.

Others have used grass clippings and hay on cabbages with good results.

One of the most surprising mulches that's good for cabbages is aluminum foil. Investigation at Connecticut and other university experimental stations indicated that cabbage mulched with strips of aluminum foil were able to repel disease-carrying aphids and return the increased yields over unprotected plants.

If you live in a warm climate location and one that normally experiences mild winters you might like to plant seeds of cabbages and cover the beds with a coarse mulch during the early winter months like November or early December. Recover the bed with a coarse mulch such as twigs or pine boughs as soon as seedlings appear. In spring when you uncover them, you will have some hardy babies for early transplanting.

CARROTS

When you sow carrots you will probably want to place some mulch over the beds to prevent the soil surface from crusting so that sprouting seeds can't break through. Cover the soil with a little loose hay or other mulch (not so deep as you might normally use it), and water it carefully so that the fine seeds will not wash

away. When the slender seedlings come up be certain the mulch doesn't interfere with them.

If you're tired of the pesky brown worm that spoils your carrots you might be able to foil it with a coffee break. Mix your package of carrot seed with one cup of fresh unused coffee grounds. Plant the coffee with your seeds. It percolates enough coffee odor during the growing season to foil the noisiest of carrot flies. And it won't flavor the carrots as sprays and other poisonous substances do. Because coffee grounds are acid, they are good for plants that like that kind of treatment. Often it is best to mix ground limestone with the grounds before using it as a mulch or top-dressing. They seem to have a remarkable effect on stimulating the growth and health of certain plants. Chemical analyses show that the grounds contain small amounts of all sorts of minerals—including trace elements—plus carbohydrates, sugars and even some vitamins, as well as caffeine.

One gardener has found that he likes to leave carrots in the ground during the winter months. By covering them well with a thick mulch he finds that the carrots may be kept that way. At any rate, he prefers it to the frozen or canned carrots that are available in most supermarkets.

CELERY

Ohio gardener Lucille Eisman reports that leaf celery protected with a deep mulch almost covering the plants, will produce crisp, tender hearts until Thanksgiving time or later. Recently she took eight or ten celery plants, complete with roots and a clump of soil and

stacked them upright in an unused cold frame. Dried leaves were packed around and between the big plants and gave full protection from the cold.

CORN

When it comes to planting delicious sweet corn, organic gardeners are of one accord—mulching is important. Often it may be best to mulch sparingly—if at all—early, because it's best to let the corn get a good start and allow the soil to warm up. However, if the weather is very dry at planting time you might want to mulch each hill with a handful of old hay or dry grass clippings and remove it as soon as there are signs of germination. Another reason for early mulching could be an abundance of crows in your vicinity. Crows will pull small corn plants nearly as fast as they show above ground. The solution is a thorough mulch that will give the plants a chance to get well started before the crows can spot them. By that time, any plant pulled will yield disappointing results to the average crow, who is after the tender young kernels below the plants.

C. E. Chamberlain of Tacoma, Washington is one of the advocates of mulching growing corn. Chamberlain uses grass clippings that have rotted all winter and mixes them with peat moss and foil. After planting the corn he tops the bed by filling it with a ring of fresh, green grass clippings. He surrounds the plants with 24" circles of inexpensive aluminum grass edging. Edward P. Morris uses a more standard technique of hilling the corn six to eight inches high. Then he uses baled or old spoiled hay which he has shaken out in the area to make a continuous mulch five to six inches deep. He claims

it is always wise to work with the wind at your back to keep the dust and seeds away. Sometimes the hay separates quickly and easily into one inch pads or slates which are equal to five or six inches of shaken hay.

CUCUMBERS

Leaves, grass clippings, old hay, leaf mold or other organic mulch all rank high in controlling cucumbers, as does aluminum foil. In fact, mulch could be the way to control the old cucumber nemesis, the cucumber beetle. E. M. Watson of Chardon, Ohio, knows the difference that mulching makes in that regard. "One year I was setting watermelon plants and was driven in by the rain before I could finish," he said. "I had all but one hill mulched with compost. I didn't get back for two days and the unmulched hill was literally destroyed by striped cucumber beetles. The others were not bothered. I had this experience with other things I have mulched; they appeared to be less susceptible to pests."

Down in Houston, Texas, Pat Patterson has found that cucumbers benefit greatly from an organic mulch. When the cucumbers are about three inches in height, Patterson spreads a reservoir of leaves around the tiny plants. Every few days he will add another thin layer of leaves until the mulch is about four inches thick. When an occasional indomitable weed pokes through the mulch, it is easily plucked from the loose soil. If you use lawn clippings as a mulch, let them dry a few days, then apply a four-inch thick layer down the whole row of cucumbers. Actually, any organic mulch will serve as well. It is a good idea to provide mulch wherever cucumber roots might extend, even on the other side of

a fence or tree. Look for big improvements in your cucumber patch after you begin to use an organic mulch.

EGGPLANT

Mulches are valuable to the eggplant because it cannot be disturbed if it is to have proper development. Besides smothering the weeds, a good organic mulch will help to conserve a uniform supply of moisture which in turn will enable the roots to feed in the top, moist two inches of soil with which they are surrounded.

GARLIC

Add garlic to the list of plants that get a boost from mulch. Harry Scoth of Corvallis, Oregon grows giant garlic, and he knows the value of using organic material. Scoth welcomes all the grass clippings, weeds and leaves his neighbors care to donate in the fall. Then he maintains two big piles of grass clippings available as mulch during the dry August months. When his garlic is six to eight inches high, Scoth works compost into the soil and mulches with grass clippings between the rows.

KOHLRABI

Moisture is of the greatest importance in feeding kohlrabi for the best growth. A thick mulch should be drawn up to the seedlings as soon as they are tall enough, and the soil beneath the mulch should be kept moist. One experienced kohlrabi grower, Dexter Raymond, uses hay, grass clippings and pulled weeds to

mulch his plants. Ruth Stout uses hay rather successfully.

LEEKS

Leeks profit from mulches of all sorts, including peat, straw, compost, wood shavings and autumn leaves. Be certain that when mulching young seedlings the mulch doesn't interfere with them as they sometimes come up rather thick in the seed bed.

LETTUCE

Lettuce is a plant which needs a coarse mulch material such as twigs or pine burrows in the seedling bed. If you already have a planting area that has seen the mulch break down a bit in early summer, scatter some lettuce seed there. The lettuce appreciates the semi-shade as well as the rich, rotting mulch.

If you have to plant your lettuce after the chill of early spring, apply a thin straw mulch around and right up underneath the lettuce leaves. This does three things: holds soil moisture; keeps the large leaves off damp soil to prevent rot; maintains the cool root run that many plants (especially cool season vegetables) require for best production. Aluminum foil also has been used successfully as a lettuce mulch.

OKRA

In growing okra, a good mulch is important if your soil is heavy and rain abundant. Before the plants bloom, work the aisles. Hill the growing plants and mulch between the rows heavily with straw, old hay or

well-rotted cow manure. Mulch the rows themselves lightly—just enough to discourage weeds but not the okra—since this plant needs plenty of warmth. Grass clippings are ideal for this light mulch. Other gardeners have found that leaves—even oak leaves—are good for mulching okra.

ONIONS

Mulch will aid the first stages of onion growth and maintain the plants during cold weather. Don't put much stock in the rumors that onions don't appreciate mulching. Mrs. Paul Gillette of Shelton, Washington reports that she put several inches of fresh fir sawdust on her onions and had the biggest and best she ever saw. Gordon Snyder of Glidden, Wisconsin plants his onions in spring—plowed ground under a two-inch mulch of kiln-dried hardwood shavings. That's all the work he does and he has been taking first prize for onions at the local country fair for several years. Ruth Stout has always claimed that her hay mulched onions are extremely mild and good eating. Walter Starns of Bethel, New York, echoes Mr. Snyder's statement on kiln-dried sawdust and shavings with Spanish onions. "It will", he says, "definitely produce larger winter onions."

PARSNIPS

To prolong the use of fresh garden parsnips, heap leaves high over the rows as cold weather moves in. These leaves will prevent the soil from freezing, and enable you to pull fresh vegetables from the ground long after the rest of the garden freezes solid.

PEAS

Trying to grow peas all summer is a rather hopeless gamble unless the most important growing principle is observed—mulch early and mulch deeply. Use straw or any material that's handy but be sure it is put on as soon as the seeds are sown—rather thin at first, then more heavily as the plants get started. Provide a deep buffer of mulch between the heat of the atmosphere and the soil. The cool, moist root run is the important difference between success or failure of summer-long peas.

Ruth Tirrell knows that peas must go in early, and the soil has to be ready to receive them. That's why an early mulching program includes plenty of organic material that gets incorporated into the soil usually the autumn before. Leaves or other clean debris are dug in and a mulch of similar material is put down for the winter. The result is enriched, productive soil that yields high quality vegetables. After the peas are planted she draws back the winter mulch to the furrow. It could cover the latter loosely. Because peas are a coarse plant they will come up through it. By the time the peas are pulled up the winter mulch will have just about disappeared. If you can, renew the mulch. Use grass clippings, hay, straw, weeds or the nitrogen-rich pea vines themselves. The mulch of organic material will prevent root rot, a disease to which peas on poorly drained land are susceptible.

PEPPERS

Peppers respond well to mulching. Most any good organic material, such as hay or grass clippings will do. But if you want early-ripening peppers, use a tar-paper

mulch in conjunction with glass cloches to permit planting the peppers two to three weeks earlier than you normally would. Use a good-quality tar paper since this will be a mulch to use and reuse for years. Cut 18-inch squares of the tar paper and put a five inch hole in the center of each. Place the tar paper over the ground with the plant growing through the hole. Cover the plant with the cloche, which can be made by cutting the bottoms of one-gallon clear glass jugs.

The tar paper mulch will collect the heat of the day and help maintain it through the night. It will keep the ground moist, although it won't contribute anything nutritional to the soil. The individual greenhouses will allow the peppers to get the sunlight and still be protected from late spring frosts.

When the pepper plant fills the cloche, remove it and the tar paper and put down an organic mulch.

POTATOES

Probably no other garden plant is more synonymous with mulching than potatoes. You can grow potatoes under mulch, in mulch, on top of mulch—almost any way in fact—and get satisfactory results.

Generally, planting potatoes on top of any mulch remaining from last season is effective. After they are set in rows, cover the eyed pieces with at least 6 to 8 inches of hay, straw or other loose material. If soil stays cold in your area during early spring, try a delayed mulch. To harvest early potatoes, remove hay or straw carefully when blossoms start falling, separate small potatoes from stems, and generally replace mulch. One organic gardener planted potatoes on top of the ground

in a cover of leaves. The leaves are piled over the potato patch the previous fall to a depth of three feet and left there for the winter. By spring they are packed down and earthworms are working through them. Potatoes are planted by laying the pieces directly on the leaves in rows where they are to grow. The seed is then covered with 12 to 14 inches of hay or straw. More mulch is added later, if tubers appear through the first. When harvest time comes, the mulch is pulled back and



Early potatoes are harvested from their thick bed of mulch, then covering is replaced.

potatoes are picked and put into their sacks with no digging necessary.

Don Tillung of Deerfield, Wisconsin, uses a method of raising potatoes on top of the ground which eliminates a lot of labor. His mulch cover is eight inches of marsh hay—usually the cheapest type. If the soil is high in nitrogen content, the hay on the bottom of the mulch will tend to decay rapidly which may require more to maintain a minimum of eight inches. Advantages are that you don't have to cultivate and you don't have bothersome potato bugs.

Edith Sarwell of Lake Forest, Illinois uses a straw mulch to plant her potatoes. The mulch keeps the soil cold and could cause a late maturity—if that's what you are after. Or, why not try two plantings—a very early one for a good head start and another in July for winter and spring harvesting. If hay or leaves are not available in your locality, try to cover each potato row with an eight-inch layer of pine needles. It makes a light, airy mulch and keeps moisture down under the needles. That will make the earthworms mighty happy and the potatoes mighty good eating.

There's one sure mulching method that controls the potato bug. It was conceived and tested at the Organic Gardening Experimental Farm. The potato seeds must be planted and the soil covered with a one-foot layer of hay or straw mulch. Through experiments it was determined that the hay is the better of the two. The plants, of course, will grow through this mulch, but the potato bug, whose egg winters in the soil, cannot climb up on the potato stem through the heavy mulch. This method of heavy mulching proved so effective that not a single

potato bug could be found on the potato plant. At the end of the season the mulch is plowed under, thus enriching the soil with valuable organic matter and giving it a better structure. The plants also benefit from this highly successful method, for they obtain a greater health and resistance to insects and disease.

Kenneth Polscer discovered that potatoes planted in soil and mulched with hay give better results than potatoes mulched with plastic. The hay keeps down the weeds, and can be turned under to decompose in the soil and provide added nutrients, something plastic can never do.

PUMPKINS

Pumpkins will profit from hay from a newly-mowed field. Mulch around each hill. Before laying down the mulch, work in a feeding of cow manure.

In Troy, New York a group of youngsters discovered that composted leaves, old hay, straw, cow manure and bone meal gave forth insect-free pumpkins that had no trouble from dryness. "From now on," says Joe Miller, "we're growing everything in the garden in organic compost."

RADISHES

Donald Shaw of Colona, Illinois planted white winter radishes on the Fourth of July, and mulched them with chopped, partly-decayed clover hay as soon as they were high enough. The results more than pleased Shaw, as one of the radishes scaled 6 pounds and measured 28 inches long.

"We ate the smaller ones—those that weighed only a pound or two each!" Shaw said.

RHUBARB

Thick stalks of rhubarb result from continuous heavy feeding. To keep the soil up to the standard necessary, spread a thick mulch of strawy manure over the bed after the ground freezes in winter. Nutrients will be leached into the soil during the winter. In spring, rake the residue aside to allow the ground to warm and the plants to sprout. Then draw the residue together with a thick new blanket of straw mulch up around the plants. Hay, leaves or sawdust also make excellent mulches for rhubarb. A side benefit of the sawdust and leaves is that they contribute to the acidity of the soil, and rhubarb thrives in an acid soil.

SPINACH

Spinach can be mulched with grass clippings, hay or ground corncobs and it will be the better for it. Inez Grant of Columbia, Maine has used hay successfully. Since spinach doesn't grow well in acid soil, acidic mulches such as sawdust or leaves shouldn't be used. Summer mulches shouldn't be applied until the leaves have made a good growth.

SQUASH

Squash needs an extra special dose of mulch, particularly during hot, dry summers. Try a heavy dousing of compost and rotted sawdust. Make your mulch as much

as four inches deep. Aluminum foil mulch has been found to repel aphids from squash plants.

SWEET POTATOES

Sweet potatoes are heavy feeders, and they grow well when they have sufficient moisture. A good mulch cover with compost will fill both of those requirements. Old leaves and grass clippings on the sides of the rows make an adequate mulch, as do the old standbys—hay and straw. If you make a hill for your sweet potatoes, be sure you mulch them well, allowing plenty of room for them to develop. At season's end, work the mulch deeply into the soil to build up humus content.

TOMATOES

Deep mulching and delicious tomatoes go hand in hand. Organic gardeners have been experiencing great results for years with mulching. Take the case of Robert E. English of Baltimore, Maryland. He mulches his plants when they reach sufficient size. If leaves are handy, they are used to a height of four inches or more, but with grass clippings or sawdust the plants may be somewhat smaller. Much of his mulching is done following a storm, using leaves, since they are not shredded. Either grass, sawdust or old rugs are used to hold the leaves in place. With every passing year English has found his soil easier to spade and the number of earthworms on the increase. He believes his use of mulch has contributed greatly to the soil fertility. Frank and Cecile Fiederlein of Cape Cod have found success in mulching their tomato plants with leaves and pine needles. "The tomatoes were the envy of the neighborhood. Besides having enough for our family and friends, my

wife put up fifty-five quarts for the winter," Fiederlein said.

Fruits

BANANAS

Oliver R. Franklin of Fort Myer, Florida, showed his neighbors that organic mulch methods could revive banana growing. "They told me that bananas did poorly here," he said, "and from the looks of those growing in nearby yards, it appears believable. However, I planted mine in the same kind of soil, but shocked the neighbors by capturing islands of water hyacinths floating by in the river, and pitching them ashore with a hay fork and mulching the bananas a foot deep with them. I figured that the rains had washed a lot of soluble minerals and trace elements into the river to be captured by the weeds, and I wanted some of it back.

"When the hyacinths decayed around the bananas, I mulched them deeply with the most aged shavings and sawdust I could find. The plants responded by growing twice as tall as their parent stock, with none of the usual root rot and no insect pests."

BLUEBERRIES

Although blueberry plants, like most other harborages of the garden, profit from mulch, it's best to be a bit wary about how much and what you use. When setting out blueberries, the soil pH should be between 4.5 and 5.0. By applying organic mulches—never any lime—you'll be able to keep it that way. Peat moss, hard wood, leaves, pine needles, and similar materials decompose into an acid compost-mulch. Also good is sphagnum moss or shredded oak leaves. If the pH is

unusually low, the mulch may be composed of shredded corn cob. Use saw dust as a mulch only if it has been composted with manure for at least a year.

Don't go hog wild mulching blueberries. When plants are first set out, a three to four inch mulch around the plant or about one inch over the whole plot is adequate. Increase the depth as the plants grow to a maximum of six to eight inches. Although mulching may prevent many bacterial and fungus diseases, over-mulching could open a Pandora's box of problems, particularly if the soil is poorly drained, making blueberries more susceptible to disease.

Frank Fiederlein of Cape Cod is a blueberry mulcher who has had success using pine needles, sawdust, some decayed leaves and sand. Around the roots he uses a mixture of sand, loam and peat moss. Each year he adds a two inch layer of pine needles. He reports that his yields are getting bigger all the time.

BOYSENBERRIES

Ethel M. Stephens of California has found that boysenberries profit from organic mulch. Because boysenberries are terrific feeders, a mulch of well rotted compost or leaves does a good job. Ethel has found that after many years of that treatment, her soil has become a deep, soft mass of organic material that holds moisture like a sponge. In hot, dry weather she mulches partially rotted sawdust to further conserve moisture and humus surrounding the roots.

CANTALOUPE

Cantaloupes and other melons need lots of moisture from the time they come up until they are nearly full-

grown. For this reason, they'll do better under a thick mulch. The best materials to use include hay, grass clippings, shells and hulls and newspapers. Stay away from sawdust and leaves, since these materials may add too much acid to the soil for the alkaline-loving melons.

The mulch should be put down before the fruit develops, since handling may damage the tender melons. Once the melons do develop, they'll be resting on a clean carpet of mulch and won't be prone to rot.

CITRUS TREES

Mulch under a citrus tree should be kept at least eight inches from the base of the tree so it doesn't foster root rot. Keep the mulch pulled well back and don't allow any irrigation water to stand at the foot of the tree.

Bearing this caution in mind, there are few things more beneficial for a citrus tree than a good mulch. One California orchardist allows the trees to mulch themselves. He just never rakes up the leaves that fall from the trees. Other orchardists grow the mulch material within the orchard itself. Summer cover crops that may be planted in the orchard and cut for mulching material include soybeans, cowpeas, millet, sudan grass and buckwheat. Winter cover crops that can be cut for mulching include rye, wheat, vetch, clover, alfalfa and kudzu beans.

Growing the mulching material in the orchard is a practice which stemmed from the large amount of material needed to properly mulch such an area. An orchardist thus doesn't have to reserve areas free of trees for cultivating mulching materials, nor does he have to purchase materials. Both of these practices con-

tinue, however. Besides the various grasses that may be used for mulching materials, you can use sawdust, weeds, peat, corncobs, brewery and canning wastes, rotten wood and leaves and, of course, stones.

Tests in New Zealand have indicated that citrus trees under mulch are healthier and produce better fruit than those not mulched. In addition, the mulched trees need only half as much fertilizer as unmulched ones. Similar tests in the United States have demonstrated that mulched trees come into bearing sooner than trees under clean cultivation. Mulches are particularly beneficial for trees between one and four years old, since these trees are most sensitive to competition from other vegetation.

FIGS

Like all fast-growing tropical plants, the fig responds quickly to a good mulch. A heavy mulch in summer to retain moisture, and in the winter to protect against the weather, plus a spring application of good compost, will usually guarantee even growth. A tree so treated needs no cultivation.

FRUIT TREES

Organic mulches are highly recommended in starting and growing fruit trees, particularly the dwarf variety. After the trees begin to grow, add a shovelful of well-rotted manure around each tree. Then mulch thoroughly. Apply the mulch to conserve moisture and aid new root growth. If you use straw, apply one half to one bale per tree. Other materials that can be used include compost and leaf mold or hay. Keep all mulches

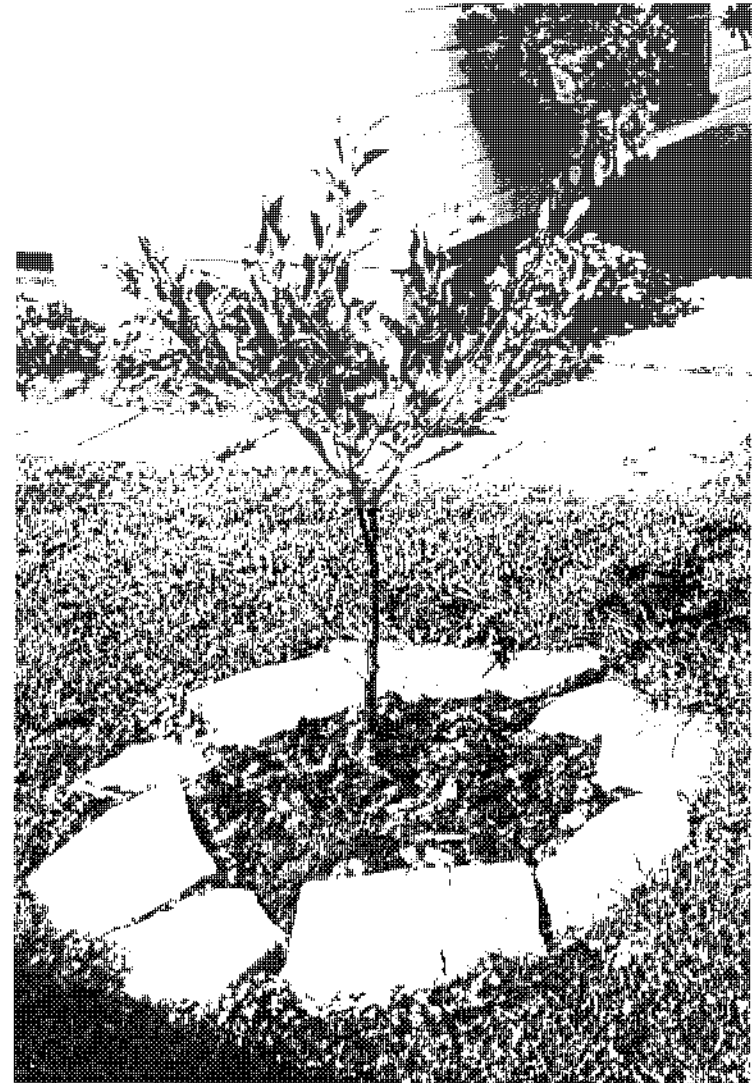

Flat stones should be used to anchor mulch around young fruit trees.

away from the base of the trunk to discourage rodents which can damage trees severely. Stone or stone chips might make an effective mulch, keep weeds down and deter animal pests. If your fruit trees are growing in a bare, recently pulled orchard, spread a mulch over the root area in late fall before temperatures tumble. You may not be able to regulate the winter blasts that sweep the branches and kill the bugs, but you can preserve your orchard for another year.

Keep in mind that your soil needs to be kept moist (not wet). A soil kept wet invites stagnation which leads to root rot. Water once, then get down to the business of mulching. The mulch is especially important during the first growing season, whether transplanting is done in autumn or spring. The mulch conserves soil moisture, but it also keeps the soil cool under the hot summer sun. Moisture and coolness are equally important in promoting vigorous root growth. Whenever rainfall is scant (naturally or unusually) a thorough soaking of the soil every two or three weeks will keep the trees growing as if there were no drought.

And if you have summer showers, you can make better use of them by mulching. This prevents thorough drying for a time. If you have scattered large rocks on top of the soil under the mulch, they act as condensers to return rising moisture to the depths. But the greatest soil moisture loss is through transpiration of the leaves, and this is one thing that you do not want to prevent, because it is necessary for their growth.

Mrs. C. F. Brock of Jay, Oklahoma has found that mulching her peach trees with maple leaves was just what they needed. "In the fall two years ago, I carried

six sacks of maple leaves and dumped them into the place I had spaded out along the peach trees, (mixing several spadefuls of rotted manure in the soil), and since I did not have rocks to cover the leaves, I used old brick on top and around the edges.

"My husband laughed at me—but when the peaches were ripe, he didn't laugh any more. He never saw such large well formed peaches and the nice part about it was there were no webs. Those mouth-watering luscious peaches made a believer out of him. He mulched all his fruit trees this fall."

GRAPES

Grapes deserve mulching, even the first year. Alfalfa hay and sand-straw-steer manure mixture rank high on the list of mulch-fertilizer combinations. Before the rainy season is the best time for the overall spread of mulches and various manures. If you choose hay or shredded leaves, work additional nutriment into the soil. It might be best to use compost, wood ashes or granite dust as fertilizer.

LOGANBERRIES

Sawdust mulching greatly increases cane growth and yields as compared to clean cultivation.

MOCK ORANGE

During the hot days of summer, it is well to use a mulch three to four inches thick for the mock orange tree. Put it on after a thorough watering and use different materials. Whether it be composed of vegetable matter from a compost pile, manure or leaf mold, all would

be suitable. Although some mulches are at the same time top dressings, they also prevent over-rapid evaporation, and enrich the soil by furnishing new food to the shrub.

PAPAYA

Edwin H. Avrimis saved an untreated papaya tree by using a large quantity of mulch. The tree had been uprooted by a heavy wind and it was decided to destroy the tree as its roots were largely out of the ground. But instead, the tree was propped up at an angle of some 30 or 40 degrees and loads of compost and garden soil placed over the roots until it was well covered. When it was found that the tree was still alive and even putting out new branches while burring heavily, more and more mulch was added from time to time, and it made a surprising comeback. It not only matured a large crop of food that it carried when overthrown, but actually put out several tree limbs and grew a large crop of good-sized fruit on these in addition.

RASPBERRIES

Sawdust and wood chips make an excellent mulch for raspberries and have increased production in Canadian tests as much as 50 per cent. Apply a sawdust or chip mulch about three or four inches thick to the base of the plants. The mulch will save moisture, cut down weeds and raise yields. Browned corn stalks and poultry litter also make a good raspberry mulch as do decomposed leaves when used as deep as five inches.

Jean Bowman of Pennsylvania says that she hasn't needed direct fertilizer applications in many years.

“But,” she writes, “we have mulched at one time or another with pine needles, sawdust, grass clippings, oak leaves and wood chips. These have decomposed and have enriched the soil, conserved moisture, shaded the ground and smothered most of the weeds. Beth Criteser of Roseburg, Oregon uses grass clippings and leaves as a mulch and fertilizes all of her garden that way. She had berries more than nine feet up the vine and managed to pick enough for dessert on Thanksgiving Day.

STRAWBERRIES

The very nature of a strawberry makes it both responsive to organic methods and most sadly vulnerable to poisonous sprays. The root system fans out below the crown in a perpendicular pattern rather than a horizontal as so many other plants do. Tiny hair roots scatter in all directions from the main roots in search of nutrition and moisture. Mulch should be well dug in to keep the bottom leaves clear so air can circulate around the plants, otherwise berries will mold on the stem.

If the mulch is allowed to remain fairly late in the spring, the plants will be protected from starting into growth so soon that their blossoms may be frosted. When the weather starts to warm up, watch the plants under the mulch. They will show definite signs of wanting to grow, and the leaves will begin to yellow when they need the sun. This is the time when the mulch should be pulled back, leaving enough straw around the plants to cover the bare soil. Leaves will grow up through this light mulch, which will help to smother the weeds and to keep the berries clean. If a late frost threat-

ens after blossoms have begun to develop, draw the winter mulch back over the plants for the night and remove it in the morning.

The best materials for mulching strawberries are wheat straw, cotton hulls, crushed corncobs, peat moss, wood shavings, pine needles or spoiled hay. Leaves make a good mulching material, particularly if corn stalks or tomato vines are applied first to prevent matting.

Although a good thick mulch will prolong the growing season, all good things have to end sometime. When the pickings dwindle down, spread an inch of young, rich compost around the remaining plants and mulch the beds heavily with clean straw. Draw the mulch up to the plants and, as new runners develop, tuck the most promising under the mulch. When the ground is frozen in fall, recheck your mulch and be sure it is thick enough. If you are using straw or hay, a depth of six inches is not too much, particularly in north central states.

WATERMELON

Watermelon vines may be mulched to keep down the weeds and retain the large amounts of moisture needed by the maturing plants. The mulch shouldn't be applied before the soil has warmed, however. Hoeing will keep the weeds down until the soil is warmed sufficiently to permit mulching. Using straw, hay or chopped leaves, spread a six-inch mulch over the entire watermelon patch, drawing the covering up to the bases of the vines. This should be done before the fruit is formed, since it is tender and easily damaged. The best time to apply the

mulch is when the soil is thoroughly dampened. As the watermelons develop, they'll be kept dirt-free by the mulch and won't be prone to rot on the vines.

Ornamentals

ARBORVITAE

As every arborvitae lover knows, winter injury can be a real nemesis. It causes a browning of the previous season's growth in late winter or early spring due to drying winds or hot sun. Trees in exposed locations are more severely affected. This discoloration is due to evaporation of moisture from the leaves or needles faster than the roots can pick up water and it is very apt to occur on newly transplanted trees. A thorough mulching of some heavy material like straw or hay will maintain moisture in the ground and help prevent this disease.

AZALEAS

The importance of mulching azaleas cannot be over-emphasized. The roots are extremely shallow—most of them lie within three or four inches of the surface—and they must be kept moist at all times. Thus a mulch of at least four inches is necessary.

Pine needles, oak leaves and sawdust from oak, cypress or hemlock make excellent mulches. A mixture of materials is preferable since the mulch in decaying continually adds food to the soil. Many growers find that a combination of pine needles and oak leaves is especially good. The needles keep the leaves from blowing and are high in acidity but slow in decaying. The oak

leaves decay more rapidly and, while lower in acidity, are higher in food value. Seaweed added to the mulch from time to time adds trace minerals. Manure is not recommended for azaleas because of its alkaline reaction.

Some gardeners have found they're able to bring their azaleas through the winter with much less loss by applying winter mulch early in the fall. One gardener uses four inches of bark dust or sawdust and tills it under every spring. By adding mulch before freezing, he has found most of his plants come up from the roots even if peripheral ones are killed.

Victor A. Carley of Berryville, Arkansas, uses mold or shredded leaves—mostly oak—to revitalize his otherwise hard to handle azaleas and wild orchards. The finely shredded leaves keep the soil conditioned if they are packed around the roots. Robert Couldwig reports that azaleas can be transplanted after being mulched like that, "and you would hardly know they had been moved." The leaves are neat, have no weed seeds, and hold moisture like a sponge, keeping the growth zone cooler in hot weather.

Mulching can be a plus if you are stricken by azalea petal blight, a disease that produces small pale spots on the inner surfaces of the petals of the colored flowers and brown spots on the white flowers. The spots rapidly enlarge until the whole flower collapses. A good preventative technique is covering the azalea beds with several inches of mulching material. That helps keep the arresting structures free of the spores. Avoid overhead watering while the plants are in flower and rely upon the deep mulching instead.

BEGONIAS

Buckwheat hulls are an especially good mulch for tuberous begonias when these moisture-lovers are put into the open ground rather than pots. Tuberous begonias are tender, naturally cool-weather plants, and are heavy feeders. The soil should be cool and moist to make nutrition constantly available, but the soil should not be soggy, which may cause rotting of the tubers. Buckwheat hulls improve the appearance of the begonia bed, and prevent the blossoms from becoming mud-splattered.

BOXWOOD

Boxwood profits from mulching particularly in the fall. Like most evergreens, boxwoods prefer a straw, leaf mold or rotted manure mulch. Such mulches prevent wide fluctuation in soil temperature and help the soil hold moisture. The mulch can be left on all winter, and then worked into the soil in the spring. A newly-planted bush should be mulched to the same depth that prevailed in the nursery or woods.

CHRYSANTHEMUMS

If your winters are not too severe and your mums are hearty, you may want to mulch heavily with straw or hay and leave them out over the winter. The object of this protection is prevention of soil heaving and the resulting root damage. If you leave your mums outdoors over winter, do not confine them to pots, but allow them to bloom naturally in October and November.

DAHLIAS

Dahlias will profit from a mulch of dried grass clippings or old hay about six inches deep. Buds form quickly after mulch is applied, so keep that in mind for planting your garden color.

DAISIES

Some nurserymen claim you can carry daisies through the coldest winter if you mulch them with eight inches of straw after the ground freezes. It might be a good technique particularly for gardeners up north who have a tendency to lose these vibrant flowers.

DELPHINIUMS

Delphiniums need a thick mulch of straw and clipped grass to keep the roots cool through the hot summer and to conserve moisture. You might also like to apply a generous amount of wood ashes, particularly if slugs or snails seem overly fond of your new delphinium shoots.

DOGWOODS

Dogwoods profit from a pine straw or leaf mulch three or four inches thick. Avoid making a mound of mulch or soil around the plant, which will shed water away from it, as dogwoods can often use a good drink during dry summer months.

EVERGREENS

Small evergreens, like any other planting, benefit from regular watering, frequent cultivation, or most

important, a mulch to help control weeds. You probably will find a heavy mulch between the trees of either compost or rotted manure to be effective. Even as seedlings, evergreens are tough, but the first winter it might be a good idea to tuck a deep layer of straw around each tree. If the straw is sufficiently moist in the fall, they should come through the first winter in fine shape. One organic gardener has found that a heavy mulch of equal parts of leaf mold and cow manure does a good job of preventing deep freezing and also supplies adequate and continuous water. Normally, a heavy leaf mulch, preferably oak leaves which last longer and contribute more to an acid condition, will give your evergreen trees the shot in the arm they need.

FERN

A woody location, with shade, moisture, and an organic soil high in leaf mold is perfect for the majority of the ferns. Oak leaves and compost are good substitutes for the leaf mold. Peat moss is also an excellent choice because it contributes to the neatness of the beds and ferns just love its acidity.

FLOWERS

Flowers make up a big category, but generally you may use a mulch to alter the soil texture to suit specific plants. Bulbs like Alpines which require a gritty soil may be accommodated by spreading a fine rock chip mulch over the soil surface. Damp meadow conditions may be simulated by laying perforated water pipes below the surface of the soil. A chopped leaf compost mixed with plenty of rotted manure or cottonseed meal

has approximately the texture and nutrients of rich wood soil. If acid spring water is available on the site, a planting of sphagnum moss in it will bring a fine bed for picture plants or bogged orchids. During the June growing months you want to be certain that all your flowers are under mulch. Ground corn cobs are fine for roses, while coffee grounds mixed with about an inch of sawdust make a handsome flower bed mulch. The coarser screenings from the compost heap can also be spread evenly around the flowers.

Texas gardeners have found that cotton burr mulching makes the difference between success and failure. Of course, in that region the material is plentiful as well as effective and it produces humus on the spot. Spread the dried burrs several inches deep around the base of the plants. Cotton burr mulch is light in weight and sufficiently porous so that it will not smother. When spread on flowering plants, the rich brown composted burrs give a neat, attractive appearance to the beds, and control weed growth at the same time.

Most annuals like a late fall planting, even though they are particularly hardy. After the first thaw in your area has penetrated the ground about an inch or so, try a mulch three to six inches thick depending on the severity of your winters. It's probably best to make it a light mulch, such as compost, straw, manure, pine needles, fresh or partly decayed leaves, peat moss or salt hay.

In early spring give consideration to mulching your perennials. If there is plenty of spring rainfall in your area, rake back the mulch to allow the furrow to warm up. But if you are in an area of skimpy rainfall, leave

the mulch in place and content yourself with later warming. Before it gets too hot be sure to mulch your perennials with compost and rock fertilizers. To keep the weeds out you might use peat moss—a material which contributes to flower bed neatness as well as making the soil on the acid side.

GLADIOLUS

Do you want to experiment with materials to mulch gladiolus? Florence M. Chase has found that hay is the most satisfactory mulch material since it does not mat and allows the spikes to push through easily, eliminating their chance of being deformed. Normally she mulches to a depth of about five inches, and has had excellent results with discouraging thrip infestation. Cornell University experimenters at Farmingdale, New York have discovered that aluminum foil protects gladiolus from attack by aphids. The researchers have found it highly effective in combating the cucumber mosaic virus, a disease carried from plant to plant by aphids which cause "color break" in flowers and streaking of leaves.

HEATHS

Heaths demand an acid material mulch and will thrive in it. That means you probably should choose an oak leaf mold, sawdust or pine needle mulch and apply it during the early growing season.

HOLLY

Because hollies love water and moisture, be certain to apply a yearly surface mulch of well rotted oak leaf

compost or wood leaf mold. Hollies also benefit from a tobacco stem mulch placed over the root area underneath the entire branch spread of the tree. The tobacco stems are rich in nutrients and perhaps detrimental to insects. When fed with a mulch of tobacco stems, hollies respond with darker green leaves and more berries.

In New Jersey, Earl Dilatush reports that oak leaf mulches are essential in growing the bright red-berried holiday greenery. He reports many cases where a heavy mulch of oak leaves has revived and restored failing holly trees.

HYDRANGEA

Pearl Wright has found that plenty of mulch—enough to protect the entire root system of a hydrangea—will get even the most pampered house pet safely through the rigors of a Mid-Illinois winter. She first mulched her hydrangea heavily with straw, working it well along the stem and adding a heavy layer of cow manure. Figuring the manure would act “just as it does in a hot bed”, she then covered the whole thing with sacks. When her straw-mulched plant survived, she added potato, apple, pear and banana peelings—in fact, all the kitchen left-overs including meat and egg scraps. It was no wonder that hordes of earthworms could be seen in her hydrangea beds digging around the plant and aerating the soil. If you want to grow good hydrangeas, especially in an area where the temperatures drop to twenty below and stay there, put enough mulch around your plant so that you protect the entire root system. The results of Pearl Wright’s growings can’t be topped—one fabulous shrub bore 240 blossoms at once.

IRIS

Iris mulch should be applied to the base of the plant where it can control weeds growing in the flower beds. Use any organic matter on hand—sometimes strawberry plants from the old bed or just dry grass clippings. Ruth Stout disproved the old theory that bearded iris can’t be mulched. She mulched her iris with loose hay and had profuse blooms as beautiful as any around. If the sun’s rays can get through a layer of loose hay to make potatoes green, she concluded, it can obviously penetrate the same mulch on a bed of iris and give the rhizomes the needed treatment. It may be best not to use anything heavy—such as peat moss—she admits, but loose hay is a natural.

LAWNS

There seems to be little doubt that grass seed newly sown will benefit from a cover of mulch. Often straw or old hay maintains enough moisture to allow the seed to germinate. The covering shouldn’t be so thick as to prevent the grass from sprouting through as seedlings. Even a light covering of green grass clippings will help grass seed germinate.

The mulching status of already established lawns becomes more controversial, however, because a lawn can mulch itself as it is mowed and there is a great temptation to allow the grass clippings to deteriorate and turn into humus. The theory is that letting the grass clippings remain uncollected will provide for a more fertile soil and a more luxuriant bed of sod. Some gardeners argue, however, that the practice of not collect-

ing grass clippings produces a sick thatch that inhibits grass growth and development.

Actually, both schools of thought bear the seeds of truth. If you do the same thing with your grass clippings all the time, you're wrong. Occasionally allow your grass clippings to go back into the soil for added enrichment. But never allow them to accumulate so thickly as to form the underlying thatch.

LILACS

When spring rolls around, spread a six-inch layer of well rotted compost around the lilac bush and out far enough to take in most of the branch spread. Dig that in well, being careful not to injure the root, and cover with a mulch of hay or leaves with ashes, or pine needles if the soil is not acid enough. The lilacs, like most shrubs, grow best in slightly acid soil. If it is too acid, an application of agricultural lime is recommended. In the late fall work that mulch into the soil and remulch with leaves or grass clippings for the winter. That will prevent heaving of roots when the ground freezes and thaws.

LILIES

Lily bulbs must be kept well drained, and yet remain cool and moist. That condition demands a good mulch. Manure may be used over the top of the soil, if it is sufficiently decayed. A deep mulch of leaf mold over the lily bed will be appreciated during the hot weather, although the lilies may be planted among low growing annuals or bushes that will keep the soil shaded. After the first frost, cut your lily plants back to the ground

and cover with a light mulch of sawdust to protect new bulbs that are growing on the stem. Later, when the ground is frozen hard, cover with a very thick mulch of hay to pull them through the winter.

PANSY

Pansies want a cool, moist soil and a rich mulch, for they are gluttons. Use manure, compost, woods soil, leaf mold, or sawdust and shavings mixed with sheep or poultry manure. The mulch feeds them richly—they are surface feeders—and keeps the roots cool in summer and warm in winter.

PEONIES

Peonies can profit from a mulch of seaweed if it is available. If not, you might want to use a pine-bark mulch which will leave a nice, red-brown appearance. The pine bark will provide added nutrients to the soil and if you add pigeon manure over the winter you should have all the ingredients necessary for productive peonies.

POINSETTIAS

If you're transferring poinsettias out of doors, be sure you mulch them heavily. Be sure to keep them well mulched with lawn clippings or other good organic mulching material.

ORIENTAL POPPIES

Oriental poppies must be mulched in the fall. However, remove that mulch in the spring and stake them. By removing the mulch in springtime, you allow the soil

to warm up and the poppies to provide rich early blooms that will dot your spring garden.

RHODODENDRONS

Leaves and sawdust make excellent mulches for the rhododendron bed, chiefly because these plants need an acidic soil. These plants are subject to chlorosis, which stems from too basic a soil condition. The leaves will turn yellow or brown. An acidic mulch is an excellent preventative for this condition, or a good cure, should it occur.

It's usually best to add a winter mulch to rhododendrons before the temperature drops too far. By adding the mulch before freezing, you will help your plants to come up from the roots in spring. Rhododendron roots are fairly delicate and sensitive to soil heaving in winter. Add about four inches of sawdust or leaves in the fall and turn them under in spring.

ROSES

How important is mulch for roses? Frankly, it probably is rather foolhardy to attempt to grow roses without mulching. Horticulturist H. P. Rosen of Wright University in Arkansas says, "One cannot overemphasize the importance of a thick mulch, applied anew each spring as a sanitary measure. Such a mulch acts as an insulating layer that prevents soil-born infectious material from reaching new growth. Perhaps the best mulch is a thick layer of rotted cow manure."

Most roses will probably do twice as well with a mulch as without it, and often with roses a mulch may mean the difference between life and death.

Think about your mulching campaign early in the spring. Perhaps you will want to remove some of the old mulch that has been left to lie from last season. If you buried the top of the roses for winter protection under the mulch, resurrect them gradually. Then tear off the



Mulch can often mean the difference between life or death for roses, here being covered with a blanket of sugar cane.

old mulch entirely and work the tired old straw, leaves or whatever you used after it is half decayed into new compost heaps along with the winter's kitchen wastes and some fresh manure. Or if your rose soil is workable, turn the old mulch under right there. It will break down quickly, worked over by all the awakening and newly hatched soil animals, insects and bacteria. Earthworms begin to stir, slugs and snails chew up and break down any coarse mulch, and the spring cleaning of the rose bed is under way. When everything is operating efficiently, blanket the roses with a layer of fresh mulch, and the life of the soil continues to percolate under its brand new cover. Grass clippings from the earliest spring mowings will provide a nitrogen-rich cover. Freshly ground corncobs are fine for roses, while coffee grounds, mixed with about an inch of sawdust, make a handsome flower bed mulch. Shredded pine bark or cocoa bean hull, applied to approximately a two-inch level after spring pruning and seeding have produced excellent results. Even newspaper or sawdust on the rose beds has given excellent results.

Leaves are an excellent mulch for the rose beds, as they prevent alternate thawing and freezing that can destroy delicate root systems. But be careful they do not mat over the crowns, or crown rot will result. When leaves are used, the plants should be four or more inches in height; when using grass clippings or sawdust, the plants can be somewhat smaller. It's a good idea to mulch following a storm, using leaves, unless they are shredded. Use either grass, sawdust, or even old rugs to hold the leaves in place. Where sawdust is placed directly on the soil, pigeon manure should be put down

first to alleviate any nitrogen robbery by the sawdust. Some gardeners have experimented with mushroom compost and redwood sawdust. Others have used shredded pine bark or cocoa bean hull not more than two inches in depth. Put the mulch on after the soil has warmed up in the spring and keep it piled high during the growing season.

Gardeners have found that a well mulched bush doesn't invite predators. A good thick mulch and adequate ventilation are also the best preventative for the old nemesis, black spot.

When winter finally rolls around, you can prevent winter injury of roses from heaving and thawing. A proper application of a good mulch around the plants prevents the soil from freezing too deep and acts as an insulator. You might like to try a four to five inch mulch of ground corn cobs, manure, straw or peat moss. Put it on in the fall after the ground has been partially frozen, or not later than December. If your roses have been mulched during the summer, simply add two or three inches more of mulch material. That will keep the soil temperature more constant and prevent damage. Some rose growers prefer to mound their plants with soil to a depth of six to eight inches, but this is hard work and unnecessary.

SHRUBBERY

Established shrubs, like most other plants, should receive a good mulch during the growing season. Strawy manure makes an excellent mulching material during the early summer months. A leaf mulch under most shrubs will also replenish organic matter in the

soil. Unless fungus disease is a problem, leaves should be left where they fall and should be supplemented by liberal mulching with grass clippings, peat, corn cobs, straw, composted sawdust, or leaf mold. Leaves are an excellent mulch for shrubbery, and you might want to use it as a winter covering. Be sure to keep it well away from the trunk and apply only after the ground freezes to prevent the nesting of rodents.

INDEX

- A**
- Acid, 17, 159, 161, 177
 Acid reaction, 9, 148
 Acids,
 carbonic, 23
 fulvic, 31
 humic, 31
 muramic, 31
 teichoic, 31
 uronic, 31
 Aeration, 18, 22, 25, 28, 34
 Aggregates, 20, 22, 40
 Alaska Division of Agriculture, 54
 Alfalfa, 28, 38, 140, 163, 167
 Alkaline, 17
 Aluminum foil, viii, 147, 149, 150, 152, 160, 177
 Anderson, Dorothy, 12-13
 Antibiotic substances, 26
 Apples, 46, 49, 85, 93
 Apple pomace, 142
 Arborvitae, 171
 Artichoke, 142, 144
 Asparagus, 104, 106, 139, 144-145
 Ault, Mrs. Sherreille, 109
 Auximones, 26
 Avrims, Edwin H., 168
 Azaleas, 140, 142, 172-172
- B**
- Baterial gums, 30
 Bananas, 161
 Beans, 5, 35, 104, 113, 125, 145-146
 lima, 2, 43
 string, 2, 43
 Beets, 5, 6, 125, 146
 Begonias, 173
- Beltsville, (Md.) Agriculture Plant Industry Station, 45-46
 Binder, Morton, 55, 132
 Biodynamic activity, 27
 Bixler, Ruth, 76, 92
 Blood meal, 119, 130, 132-133, 134
 Blueberries, 143, 161-162
 Bone meal, 70, 129, 158
 Boron, 27
 Bowman, Jean, 168-169
 Boxwood, 173
 Boysenberries, 162
 Broccoli, 126, 146
 Brock, Mrs. C.F., 166-167
 Brooklyn Botanical Gardens, 37
 Buckman, Professor Harry, 18-20, 29
 Buckwheat hulls, x, 119, 127, 173
 Burdick, Bart, 124
- C**
- Cabbage, 126, 135, 136, 146-147
 Calcium, 26, 27
 Camellias, 140
 Canary Islands, 75
 Cantaloupe, 162-163
 Carbohydrates, 30
 Carbon, 27
 Carley, Victor A., 172
 Carter, Charles, 147
 Carrots, 5, 125, 147-148
 Carter, Charles, 147
 Castor bean pomace, 142
 Cauliflower, 126
 Celery, 148
 Cellulose, 30
 Chamberlain, C.E., 149
 Chase, Florence M., 177
 Chelation, 22, 26, 31

Cherries, 49, 85
 Chrysanthemums, 173
 Citrus trees, 44, 85, 163
 Clover, 28
 Cocoa bean shells, viii, 50, 139, 144
 Coffee grounds, 148, 176
 Columella, 83
 Commercial fertilizer, viii, 48, 49, 53
 Compost, ix, 6, 7, 9, 27, 28, 48, 49, 62, 95, 127, 135, 140, 141, 143, 150, 151, 152, 158, 162, 168, 176, 178, 180, 181, 184, 185, 186
 Copper, 26, 27
 Corn, 3, 9, 11, 35, 37, 113, 119, 125, 129, 130, 141, 147, 150
 cobs, 28, 74, 104, 118, 128, 139, 143, 144, 162, 164, 170, 176, 184, 185, 186
 shredded stalks, 28, 41, 74, 75, 127, 176
 Cotton burrs, 75, 128, 176
 Cottonseed meal, 11, 70, 119, 127, 129, 130, 134, 141, 175
 Couldwig, Robert, 172
 Critser, Beth, 169
 Crop residues, 9
 Crows, 11, 43, 149
 Cucumbers, 5, 35, 130, 150-151
 Cultivation, 10, 29, 56, 118, 174
 Currants, 49

D

Dahlias, 174
 Daisies, 174
 Damping-off, 118
 Decay, 20, 23, 24, 28
 Decayed leaf mold, 4
 Decomposition, ix, 22, 23, 26, 27, 29, 30, 47, 57, 59, 62, 64, 71, 128, 133, 161
 Delphiniums, 174
 DeVoc, Robert F., 112
 Dew, 36, 106
 Dogwoods, 174
 Drainage, 18, 38, 39
 Drought, 2, 5, 7, 10, 13, 36, 37, 118, 123
 DuPont Company, 102

E

Earthworms, x, 9, 13, 22-23, 37, 50, 64, 79, 85, 157, 178, 184
 Eaton, Fred, 61
 Eggplant, 141, 151
 Eisman, Lucille, 148
 English, Robert E., 160
 Erosion, 22, 26, 41, 42, 43, 51
 Evergreens, 60, 86, 118, 142, 174-175

F

Fern, 175
 Fiederlein, Frank and Cecile, 160-161, 162
 Figs, 164
 Fleck, Harold, 1, 43-44
 Flowers, 9, 175-176
 Franklin, Oliver R., 161
 Frost, 2, 38, 67, 116, 119, 120, 136, 169, 180
 Fruits, 161-171
 Fruit trees, 50, 82, 85, 86, 92, 142, 143, 164-165
 Fungi, 15, 26, 44-45, 79, 118
 Fuschias, 132

G

Garlic, 151
 Georgia Agricultural Experiment Station, 41
 Gillette, Mrs. Paul, 153
 Gladiolus, 177
 Gooseberries, 49
 Grapes, 167
 Grass clippings, x, 7, 27-28, 48, 49, 58, 74, 144, 145, 147, 151, 153, 154, 160, 163
 Graybill, Paul, 113
 Ground cork, 58, 60, 61
 Gums, 31

H

Hay, vii, x, 10, 11, 12, 30, 46, 48, 49, 54, 61, 63, 67, 104, 125, 126, 128, 129, 130, 134, 140, 141, 143, 145, 146,

147, 150, 152, 158, 160, 163, 171, 174, 179

Heaths, 177
 Heaving, 38-39
 Hemlocks, 96-97, 171
 Herbaceous annuals, 57
 Herbicides, x
 Hill, Lewis, 47
 Holly, 177
 Hops, 75, 142
 Humus, viii, 20, 21, 25, 28, 48, 64, 135, 136, 146, 179
 Hunter, Mrs. Margaret, 111-112
 Hyacinth plants, 75, 161
 Hydrangea, 178
 Hydrogen, 27

I

Iris, 179
 Iron, 26, 27, 30

K

Keck, John, 99
 Kohlrabi, 125, 151-152
 Krill, John, 64-67, 120, 125

L

Lawns, 179
 Leaves, x, 9, 28, 30, 48, 49, 50, 64, 68, 71, 79, 80, 95, 117, 119, 125, 126, 127, 140, 142, 143, 145, 149, 150, 151, 152, 153, 154, 156, 158, 160, 162, 163, 164, 167, 169, 171, 173, 178, 182, 184, 186
 Leeks, 152
 Leister, Mary, 57
 Lettuce, 3, 7, 11, 12, 13, 107, 125, 135, 136, 141, 152
 Lignin, 30, 31
 Lilacs, 180
 Lilies, 180-181
 Lime, 56
 Lindeman, Joan, 146
 Liquid fish solutions, 9
 Loganberries, 167
 Lyon, Professor T., 18-20, 29

M

MacManes, John S., 94
 Magnesium, 26, 27, 62
 Malsch, Brownson, 145
 Manganese, 27
 Manure, 9, 26, 27, 30, 48, 49, 53, 55, 56, 62, 70, 76, 88, 89, 105, 129, 130, 134, 139, 142, 143, 147, 153, 159, 167, 172, 173, 175, 176, 180, 181, 182, 184, 185
 Marshgrass, 13
 Martin, Archer, 71
 McCalla, T.M., 21, 27
 Mead, Robert, 74
 Melons, 5, 130, 163
 Microbes, 22, 24
 Microbial action, 26, 34
 Microbiological life, 23, 44, 51
 Miller, Joe, 158
 Minerals, 17, 22, 23, 26, 30, 32, 62, 98
 Mock Orange, 167-168
 Molds, 30
 Montfort, Georgia, 90-92
 Morris, Edward P., 149
 Mulenberg, Walter J., 96-97
 Mulch,
 amount of to use, 127
 continuous, 10, 116, 117, 149
 dark, 40
 light, 40
 nature's, ix
 organic, viii, 23-33
 permanent, 6, 10
 spring, 139
 summer, 116, 117
 when to, 115-117, 130-132
 winter, 116, 140, 141, 143
 Mulching,
 benefits, of, 28-29, 31-33, 34, 43, 45
 book system of, 63-64
 materials, 52-80
 mistakes, 129, 136
 questions about, 115
 spontaneous, viii-ix
 Mulching specific plants, 144 (see plant name)

N

Nature and Properties of Soils, The, 18
 Nebraska Crop Improvement Association, 21
 Nematodes, Citrus, 45
 Newspapers, 48, 109-114, 141, 163, 184
 ways to use, 109
 New York City Commission of Air Resources, 102
 Nitrogen, x, 11, 22, 26, 27, 30, 31, 59,
 61, 75, 79, 119, 129, 130, 132, 140,
 144, 157, 185
 deficiency, 127-128, 133
 Nutrients, 9, 17, 22, 23, 26, 47, 62, 79,
 176

O

Oats, 65, 128, 129
 Ohio Department of Highways, 42
 Ohio Edison Company, 71, 73
 Okra, 152-153
 Onions, 11, 153
 Organic Gardening Experimental
 Farm, 83, 85, 157
 Organic material, vii, 20-24, 26, 27, 29,
 30, 32, 43, 56
 Organic salts, 31
 Oriental poppies, 181
 Ornamentals, 171-186
 Oxygen, 27
 Oyster shell, 77

P

Pansy, 181
 Papaya, 168
 Paper, 10, 48, 49
 Parsnip, 125, 153
 Patterson, Pat, 150
 Peaches, 85, 94, 95
 Peanut shells, 75, 142
 Peas, 125, 136, 154
 Peat moss, 55, 74, 128, 149, 152, 161,
 162, 164, 170, 175, 176, 179, 185,
 186
 Pennsylvania State Agricultural Ex-
 periment Station, 39
 Peonies, 126, 142, 181

Peppers, 3, 125, 135, 136, 141, 154-
 155
 Perennials, 50, 57, 72, 117-118, 119,
 139, 177
 Pesticides, x
 pH, 14, 55, 62, 161
 Phosphorous, 26, 27, 30
 Picon, 75-76
 Pierson, Joan, 146
 Pine chips, 58-59, 70
 Pine needles, 41, 50, 74, 127, 140, 157,
 161, 162, 169, 171, 176, 177
 Plant roots, x, 20, 29
 Plastic mulch, 101-108, 158
 drawbacks, viii, 101
 Ruth Stout on, 103-108
 toxic fumes from, 102
 Podzolic, 14
 Poinsettias, 181
 Polser, Kenneth, 158
 Potash, 26, 62, 75, 119
 Potassium, 27
 Potatoes, 4, 11, 70, 155-158
Public Works, 43
 Pumpkins, 158

R

Radishes, 158-159
 Raspberries, 44, 47-48, 49, 57, 168-
 169
 Rawson, Harold, 7-9
 Raymond, Dexter, 151
 Rhododendrons, 142, 182
 Rhubarb, 54, 57, 89, 159
 Rice hulls, 75, 128
 Rodale, J.I., 84, 94, 98, 99
 Rodale, Robert, 97-99
 Root zone, 9
 Rosen, H.P., 182
 Roses, 9, 50, 72, 77, 89, 139, 143, 176,
 182-185
 Rot, 152
 brown, 45
 crown, 45, 119
 fruit, 45
 root, 26, 45
 Rotation, 21, 27
 Ruth Stout No-Work Garden Book,
 The, 43

S

Salt damage, 9
 Sarwell, Edith, 157
 Sawdust, viii, 13, 28, 48, 49, 53, 54, 55-
 56, 57, 58, 74, 78, 127, 132, 140,
 143, 147, 153, 159, 160, 161, 162,
 163, 164, 167, 168, 169, 171, 177,
 181, 182, 184, 186
 Schoth, Harry, 151
 Schroeder, Dorothy, 3
 Seasonal mulching calendar, 138
 Seaweed, 53, 54, 172
 Seneca Buttercrunch, 6
 Servais, L.T., 82, 94, 100
 Shade, Lucille, 129-130, 135
 Shaw, Dave, 69
 Shaw, Donald, 158
 Shields, Lee, 67
 Shrubbery, 9, 185-186
 Simonson, Roy, 15
 Slimes, 30, 31
 Smith, Mrs. Robert, 34-36, 51
 Snyder, Gordon, 153
 Sod, 10, 27
 Soil,
 balance, 9
 clays, 17, 18, 20, 28, 119
 composition of, 16-18
 crumb, 20
 flora, 44
 friability of, 18, 28, 55
 granular, 20, 29
 gravels, 17
 heaving, 38, 116, 118
 home testing kit for, 17
 horizons, 15
 loams, 17, 18
 microorganisms, 22, 24-25, 26, 27, 29
 nutritional deficiencies in, 17
 pattern, ix
 porosity, 41
 profile, 15
 sample, 17, 20
 sands, 17-19, 28, 38
 structure, vii, 20, 22, 29, 36, 81
 temperature, viii, 28, 34, 36, 38-40,
 43, 51, 57, 61, 81
 Soil Conservation Service, 21
 Solvation, 22, 23, 31

Soybean meal, 11, 128
 Soybeans, 44, 163
 Sphagnum peat moss, 28, 29, 128, 161
 Spinach, 125, 159
 Spoiled hay, 12, 13
 Squash, 3, 7, 13, 107, 159-160
 Stahr, Alden, 45, 51
 Starns, Walter, 153
 Steinmetz, Ervin, 72, 73
 Stephens, Ethel M., 162
 Stone mulching, 81-100
 as decoration, 83, 99-100
 concrete molds for, 98
 disadvantages of, 97
 fortress method, 93-94
 for sick trees, 85, 94
 Stout, Ruth, 10-13, 35, 43-44, 103-108,
 116, 119, 125, 134, 135, 153, 159,
 179
 Straw, x, 27, 41, 104, 117, 127, 129, 130,
 132, 134, 141, 143, 145, 151, 152,
 154, 155, 158, 160, 170, 171, 173,
 174, 175, 176, 178, 185, 186
 Strawberries, 49, 54, 57, 114, 129, 169-
 170
 Sulphur, 23, 27
 Sweet Potatoes, 160

T

Terrace gardening, 92
 Thompson, A.P., 93
 Tillage, 21
 Tilling, Don, 157
 Tilth, 28, 49, 64, 68
 Tirell, Ruth, 5-7, 154
 Tobacco, 37, 74, 178
 Tomatoes, 3-6, 9, 10, 22, 104, 119, 120-
 125, 126, 130, 132, 135, 136, 141,
 160-161

U

University of Illinois, 23
 U.S. Department of Agriculture, 15, 21,
 23, 41

V

Vegetables, 144-161

INDEX

Virgil, 83
Voigt, Owen M., 77-81

W

Wandzell, Bob, 53
Ward, Vernon, 125
Watermelon, 150, 170-171
Watson, E.M., 150
Wood, Margaret L., 85-90
Wood chips, 13, 44-45, 48, 49, 69-74,
143, 152, 168, 169, 170

Wright, Pearl, 178
Wright University, 182
Williamson, Cynthia, 135-136

Y

Yearbook of Agriculture, 15

Z

Zinc, 27
Zinnias, 127

FENCE PLANNER

for the COMMON SENSE FENCE™

Fencing technology in the U.S. has evolved from the first use of barbed wire in the late 1800's and woven wire soon after. This, along with steel and wood posts were the main means of animal control until electric fencing was introduced in the 1940's. Electric fencing was a wonderful invention in that it kept livestock both contained and away from the fence. Unfortunately, steel and wood posts continued to be used and insulators needed to be added. The cost of the insulator was always an important consideration and in an effort to keep insulators for farm fences affordable materials were chosen that typically had a short life span plus if dirt and moisture collected

on the surfaces, shorts occurred. Thus electric fencing was only used for temporary fencing. In another development in the 1970's, high-tensile wire was developed to get away from barbed wire. This wire needed to be installed close together and at high tension which required both extremely strong corners and line posts spaced close together, thus high cost. In the 1980's, the "COMMON SENSE FENCE" product line was introduced which combined the advantages of high tensile wire and electricity with "never to short out" Fiberglass Posts that could now be spaced at greater intervals. THIS IS THE PRODUCT WE ARE PRESENTING HERE.

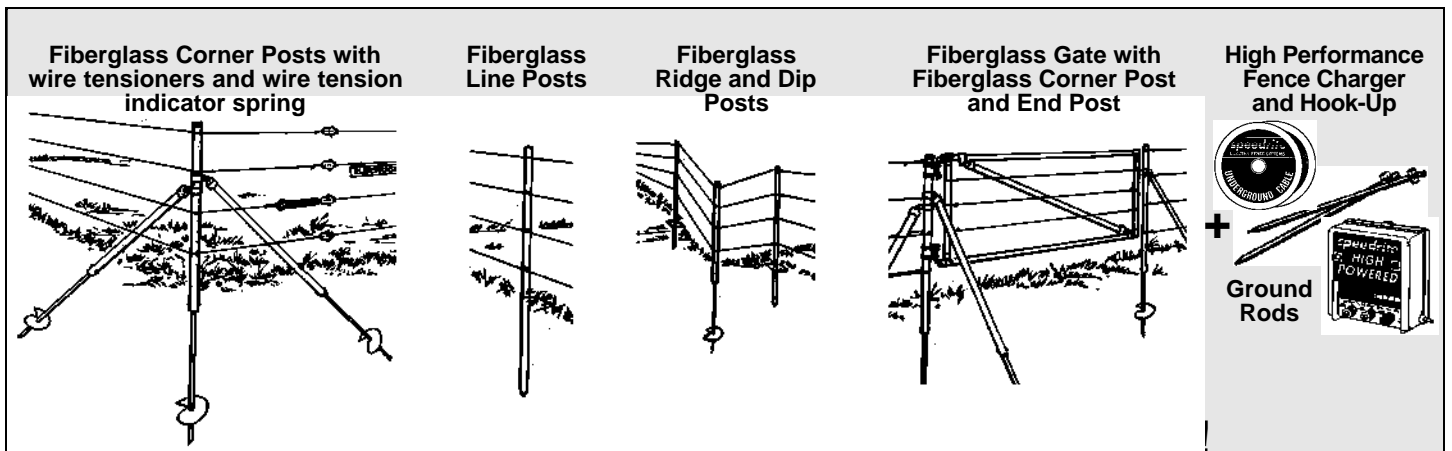

The easiest to install, safest, most dependable, longest lasting and most cost effective fence you can build, PERIOD!

TAKE TIME TO PLAN. The installation of any fencing system begins long before the first post is driven or wire is strung. The secret of getting the most from each dollar spent on fencing is to take the time to thoroughly plan, and then construct carefully. Any time that may be saved by incomplete planning, construction shortcuts or poor safety practices will only reduce the efficiency and life of the fence and will ultimately cost much more than is saved. NO ONE is better suited to plan the "Common Sense Fence" and construct it than the person who will use it...you. You know which animals are to be controlled and the lay of the land.

CHECK LOCAL LAWS AND ORDINANCES. Laws governing placement of fences and electric fencing vary from county to county. It is important to understand what your local ordinances have to say about electric fencing BEFORE you start. Questions such as: "How far must a fence be from a roadway?", "Can electric

fencing be used in suburban areas?" and "Are warning signs required?" must be answered. If in a rural area, check with your County Extension Office and if in town, check with the City Clerk's Office.

CHECK YOUR PROPERTY LINES. The first step in planning any fence is to check your property survey. In rural areas, adjoining fences are generally built on the property line with each owner paying half the cost. Within city limits, fences must generally be entirely on your own property and you pay all the costs. Again, check your local laws.

TALK WITH YOUR NEIGHBORS. It is a good idea to talk over fencing plans with the neighbor whose property will be next to the fence. Your neighbors may have questions about the "Common Sense Fence".

A. Sketch a Map and Choose your End, Corner, Dip and Ridge Posts

Begin by drawing a map of your property including all major features such as: buildings, roads, fields, swamps, woods, hills, gullies, streams and other features that might require special consideration during construction. Be sure to include: power and telephone lines, gas and oil pipelines and underground cables.

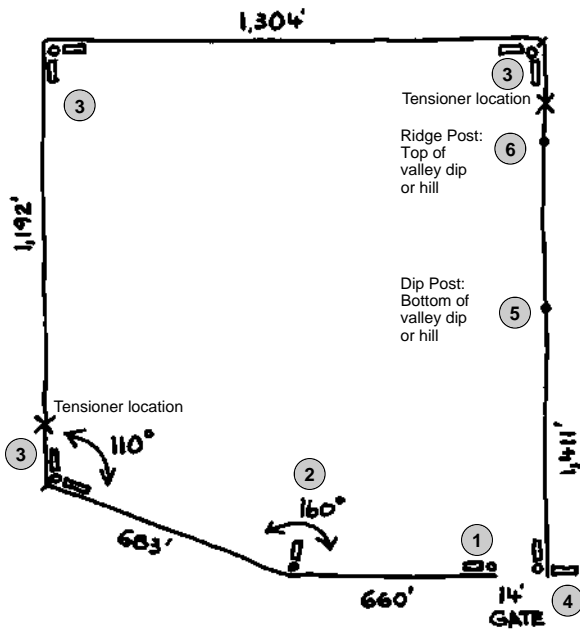

STEP 1.

Screw in anchors.

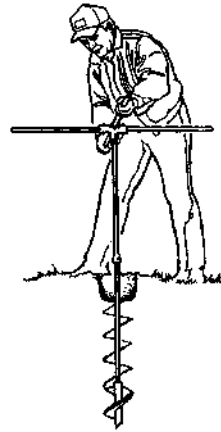

STEP 2.

Secure fiberglass corner posts and braces to anchors.



4, 5 & 6 FOOT HIGH MULE

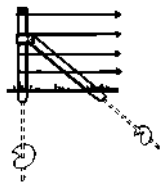

End Post - 1 Post, 1 brace and 2 augers to be used in two situations:

1. Where the fence will end and a gate will not be hung on that post.

2. For slight changes in wire direction and where a full corner is not required. Generally less than 60° and more than 120°.

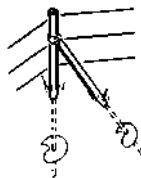

Corner and Gate Posts - 1 Post, 2 Braces and 3 Augers

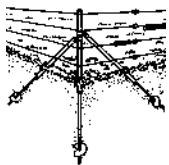

3. For all corners near 90° or

4. Where the fence will end and a gate will be hung on that post.

Note: Be sure to measure gate opening correctly to allow for gate hinges and latch.

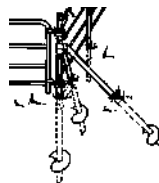

DIP AND RIDGE POSTS

5. Dip Post

To be used where the ground rises causing a lot of upward pull on the post. Use at the bottom of a valley dip or hill.

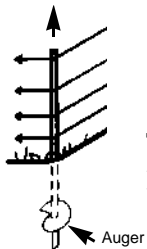

6. Ridge Post

To be used where the ground slopes down and tension on the wires will want to force the post into the ground. Use at the top of a valley dip or hill.

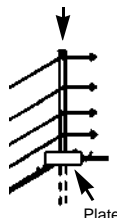

3 FOOT HIGH MULE

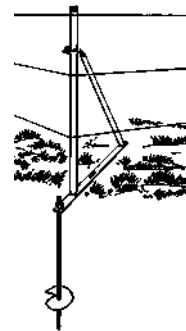

Single brace can be used as an end or a corner.

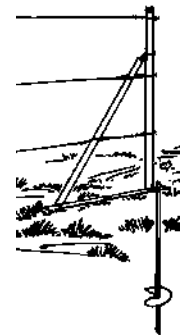

Install tool is built into bottom metal strap.



Double brace can be used for all ends and corners.

When pulling sideways on a gate post, you may prefer to use the double brace for more side stability.

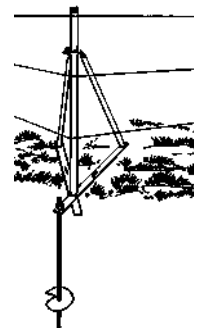

ANCHOR OPTIONS:

The 6" x 36" auger anchor is the standard and works in over 80 percent of the situations. However, for very hard, rocky ground, we have the 4" x 24" auger and for soft, deep sand, peat and swampy soils we have the 10" x 36" auger. In addition, 12" and 24" extensions are available to handle unexpected conditions that may require deeper penetration into the ground. We have not uncovered conditions to date that one of our Mule™ anchors can't handle. If one has solid rock, one can drill a 1 1/4" hole in the rock, insert the 3/4" x 12"

extension, add grout, let it harden and install the corner system.



B. Wire, Tensioners and Crimp Sleeves

12 1/2 gauge, 200,000 min. psi, high tensile, class III galvanized steel wire should be used. Its strength and elasticity will assure you of a fence that lasts for years. Care must be taken when uncoiling high tensile wire as it acts like a coiled spring and can easily become entangled. A "spinning jenny", as shown in the photo should be used to hold the wire in place as it's being uncoiled. Install in-line wire tensioners and secure wire as shown in illustrations below. Secure just ONE wire prior to driving line posts in. This should be the second wire up from the ground. Tighten wire with in-line wire tensioners so it stays straight and provides a guide for installing the line posts.



CRIMP SLEEVES

It is recommended that all wire connections be made using crimp splice sleeves and the special crimp tool. Use of the crimp sleeves will result in a splice equal to the strength of the wire.

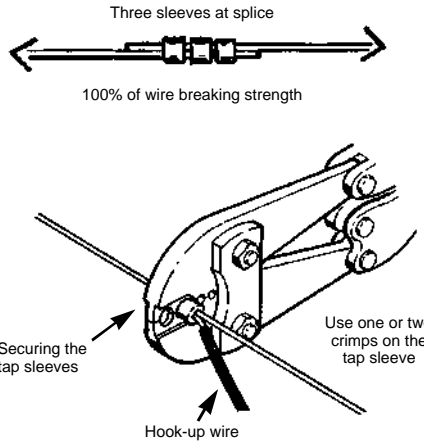
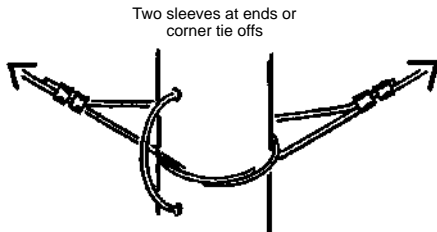

12 1/2 gauge high tensile wire can be tied off as illustrated below. However, it is difficult to do and one does not achieve a splice strength equal to the strength of the wire.

SPLICE KNOTS

FIGURE EIGHT

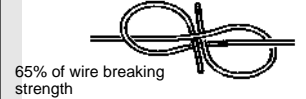

65% of wire breaking strength

DOUBLE LOOP



30% of wire breaking strength

THREADED THROUGH

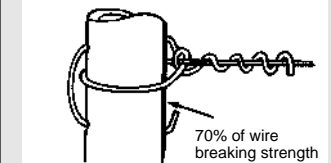

70% of wire breaking strength

SIMPLE TWIST

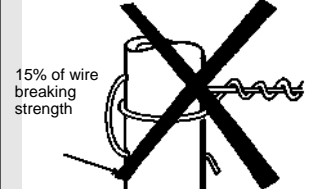

15% of wire breaking strength

IN-LINE WIRE TENSIONER

(X) shows location of wire tensioner	Maximum feet of wire per wire tensioner
STRAIGHT LINE 	5,000 ft. max. Additional wire tensioners per wire are required if braced ends are over 5,000 ft. apart.
ONE CORNER 	5,000 ft. max. each Use two wire tensioners for angles less than 45° (one on each straight line)
TWO CORNERS 	3,000 ft. max. You can pull around one corner in each direction.

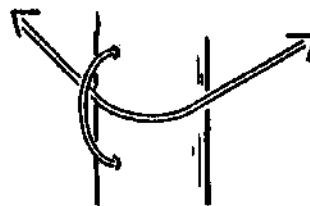

NOTE: Fence line wires may "flow" around corners allowing longer runs and the use of fewer tensioners. See chart.

(X) WIRE TENSIONER

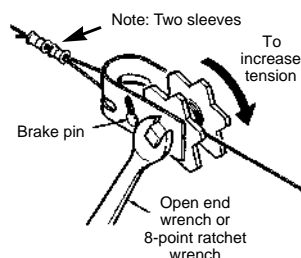

C. Drive in Line Posts and Install Clips

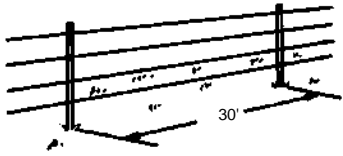

Suggested spacing for line posts is 30 feet.

See pages 6 and 7 for suggested wire spacing.

SECURE WIRE TO POSTS

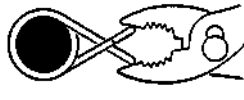

Squeeze hooks together. Slip clip onto post with longer hook down, release.



Pull wire up into bottom hook – rotate wire up and around until it is inside the upper hook. Release.

WIRE U-CLIPS

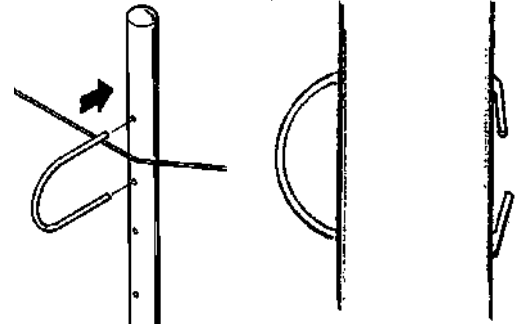

Push u-clip through two holes and use hammer for 2" posts to bend wires and pliers for other posts.

D. Tension Indicator Spring

Recommended wire tension is between 100 and 150 pounds for 12½ gauge wire. The springs are marked to show load. Generally, the wires need to be tightened so they do not have excessive sag and thus not likely to touch the wire above or below. Remember, **ITS THE ELECTRICITY THAT IS CONTROLLING THE ANIMALS**, not the wire tension.

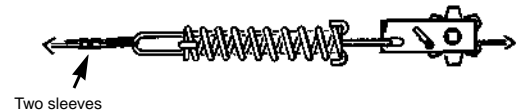

Two sleeves

Gates

POLYETHYLENE TUBING

The "Common Sense Fence"™ System uses insulated hook-up wire inserted through polyethylene tubing to conduct fence line current underground. Polyethylene tubing provides additional insulation from the soil as well as protecting the insulation from the soil as well as protecting the insulation on the wires. The use of overhead wires is not recommended. Transfer wires that run overhead (conventional electric fencing) from controllers to fence lines and across gateways, are "high targets" for lightning strikes or may be damaged by farm equipment.

Underground use of insulated hook-up wire requires proper installation:

- Never have spliced insulated hook-up wires inside the polyethylene tubing.
- The ends of the polyethylene tubing must be made water resistant.
- Maximum distance recommended for underground wires is 200 feet. For longer distances, run a fence above the ground or install the controller closer to the fence. Spliced joints in the polyethylene tubing are not recommended.

WATER RESISTANT END FOR POLYETHYLENE TUBING

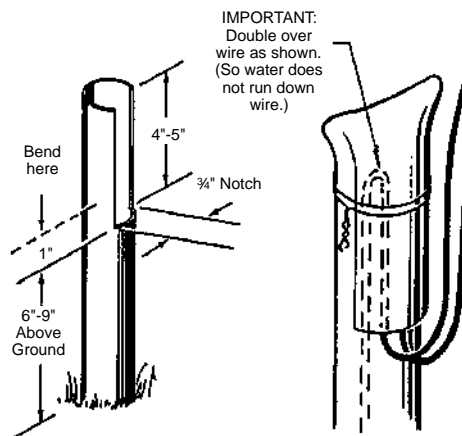

IMPORTANT: Double over wire as shown. (So water does not run down wire.)

GATE BRACKET AND GATE HOOK PIN

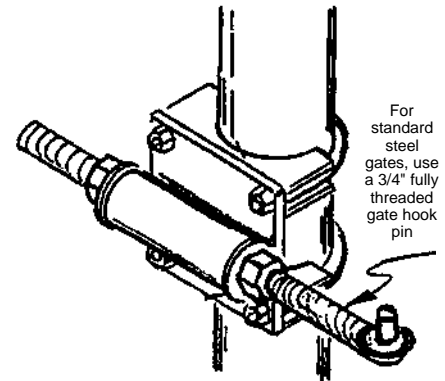

For standard steel gates, use a 3/4" fully threaded gate hook pin

GATE LATCH BRACKET

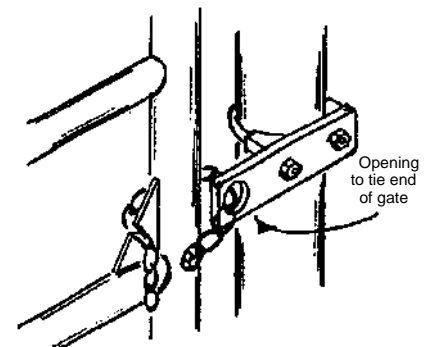

Opening to tie end of gate

E. Fence Controller and Ground System

ALL HOT SYSTEM

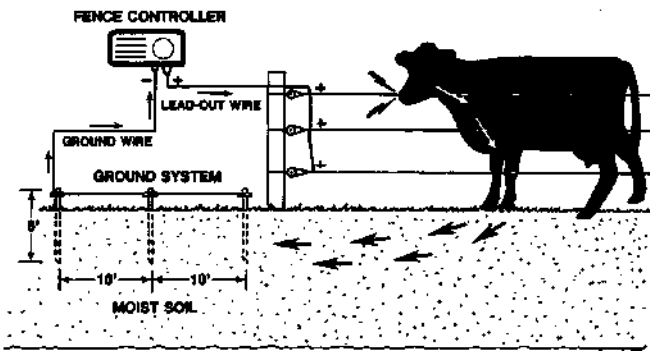

In an all hot system, the animal receives a shock by touching a hot wire which transfers the electrical charge through the animal, through the earth to the ground rods and back to the controller which completes the circuit. **This system relies on good ground rods and moist, unfrozen earth conditions.**

HOT/GROUND SYSTEM

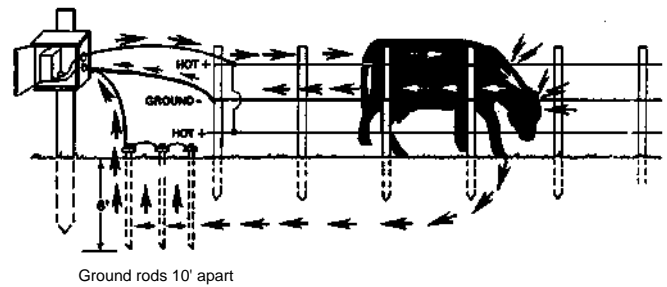

In the hot/ground system, the animal can receive a shock the same as the All Hot System and also by touching a hot (+) and ground (-) wire at the same time to complete the circuit. **For best results in all soil conditions, use a hot/ground system.**

DO NOT install ground rods within 50 feet of a utility ground rod, buried telephone line, or buried water-line (they may pick up stray voltage).

WARNINGS

SAFETY: Although modern fence controllers approved by recognized safety standard organizations pose no direct safety concern, indirect accidents can happen so it's important to be aware of the following **WARNINGS** before constructing your fence.

- WARN ALL PERSONS, ESPECIALLY CHILDREN, ABOUT YOUR ELECTRIC FENCE AND SHOW THEM HOW TO DISCONNECT THE CONTROLLER IN CASE OF EMERGENCY. If you permit hunters or other visitors to use your land, be sure they have been warned and that all of your electric fences are marked.
 - USE AMPLE WARNING SIGNS. This is especially true around buildings or locations where you expect people to be. Warning signs should be used every 300 feet or less. In some states warning signs are required by law.
-
- ONLY USE CONTROLLERS WHICH HAVE BEEN APPROVED BY NATIONALLY KNOWN AND RECOGNIZED SAFETY STANDARD ORGANIZATIONS.
 - BEFORE THUNDER OR ELECTRICAL STORMS, IT IS BEST TO DISCONNECT A CONTROLLER FROM THE FENCE WIRES AND REMOVE THE PLUG FROM THE LINE OUTLET.
 - DO NOT FENCE DURING ELECTRICAL STORMS.
 - NEVER GRASP A SUSPECTED LIVE FENCE WIRE.
 - DO NOT TAMPER WITH OR ATTEMPT TO REPAIR CONTROLLERS. Controllers must be sent back to the factory or an authorized service shop for repairs.
 - DO NOT USE MORE THAN ONE CONTROLLER FOR THE SAME SECTION OF FENCE.
 - ALWAYS DISCONNECT THE CONTROLLER BEFORE HANDLING FENCE WIRES.
 - WHEN WORKING NEAR OR TESTING ELECTRIC FENCES, KEEP FEET AND HANDS DRY.

- DO NOT USE BARBED WIRE WITH ELECTRIC FENCING.
 - DO NOT STRING ELECTRIC FENCE WIRES OVER OR CLOSE TO WATER TANKS OR ANY WATER THAT MIGHT BE USED FOR SWIMMING.
 - DO NOT ERECT AN ELECTRIC FENCE UNDER OR NEAR OVERHEAD POWER LINES. Because electric fence lines are well insulated from the ground, fallen power lines can send lethal amounts of electrical power for much greater distances than can non-electric fences. Check with your local power authority so see if this is a potential problem. The following illustration shows one method of safely passing under a power line with an electric fence.
-
- BE SURE THAT YOUR ELECTRIC FENCE WIRES (both wire return and hot) DO NOT COME IN CONTACT WITH YOUR BUILDING.
 - NEVER USE YOUR POWER LINE GROUND RODS OR YOUR PLUMBING SYSTEM AS A GROUND FOR YOUR ELECTRIC FENCE.
 - KEEP GROUND RODS FOR THE ELECTRIC FENCE AT LEAST 20 FEET AWAY FROM ANY:
 - Utility company rods.
 - Telephone company ground rods.
 - Underground metal pipes
 - Metal supports for structures which lie upon, or have been driven into, the earth.

Suggested Wire Spacings:

The designs shown are for general reference and may be modified for your own specific containment needs.

3 Foot High MULE

HORSES, CATTLE

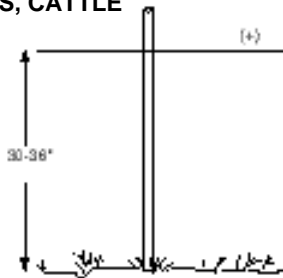

Figure 1

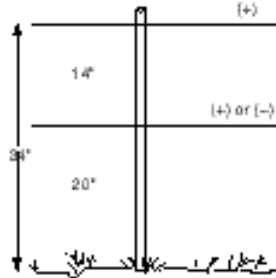

Figure 2

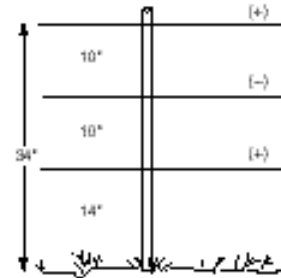

Figure 3

SHEEP, GOATS, HOGS

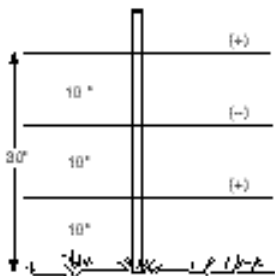

Figure 4

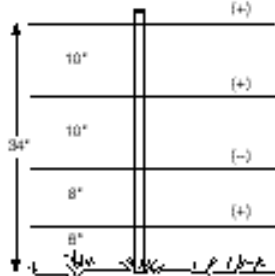

Figure 5

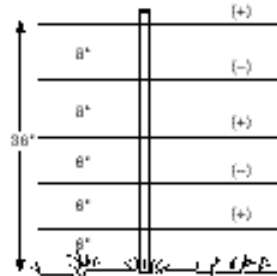

Figure 6

RABBITS, RACCOONS

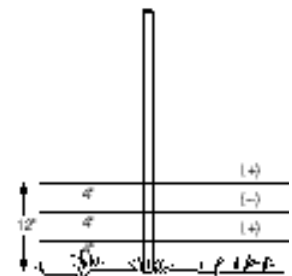

Figure 7

4 Foot High Heavy Duty MULE

HORSES, BEEF, DAIRY

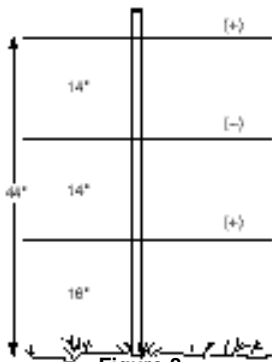

Figure 8

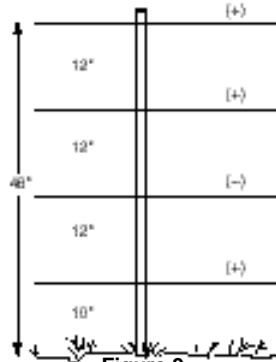

Figure 9

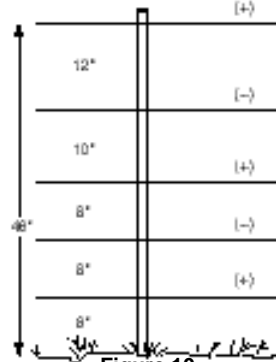

Figure 10

SHEEP, GOATS, HOGS

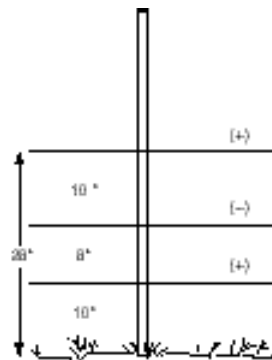

Figure 11

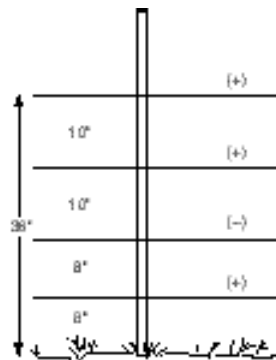

Figure 12

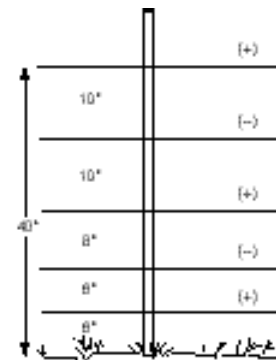

Figure 13

5 Foot High Heavy Duty MULE

BUFFALO, DEER, DAIRY, HORSES, BEEF, PREDATORS, LLAMA

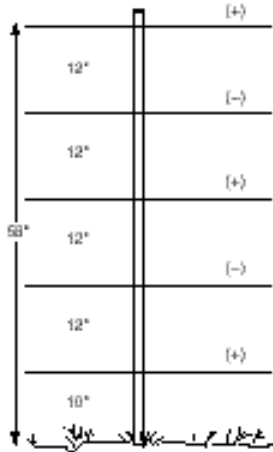

Figure 14

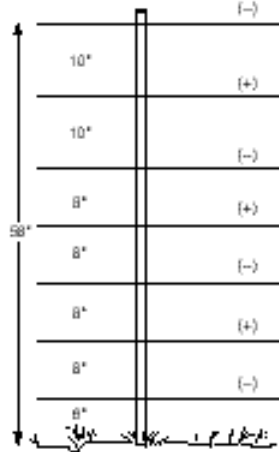

Figure 15

PREDATOR CONTROL – COYOTES, DOGS, WOLVES, ETC.

Fencing requirements are generally greater for the control of wild animals. This is because of their more aggressive behavior towards fences and barriers. Just as with livestock, it is important to consider the physical and behavioral characteristics of the wild animals which you are going to control. Dogs and their relatives are of particular interest because they have no sweat glands. This greatly reduces the moisture on their skins, making electrical flow more difficult and thus a less effective shock. A fence for these predators must be high enough to keep them from jumping over, wire spacing close enough to keep them from squeezing through. The 9-wire general-purpose predator fence shown in Figure 17 forces the predator to climb the fence. This insures simultaneous contact by two or more of its padded paws between the (+) hot and the (-) wire return producing the most effective shock to control these predators.

6 Foot High Heavy Duty MULE

BUFFALO, DEER, PREDATORS, BEAR

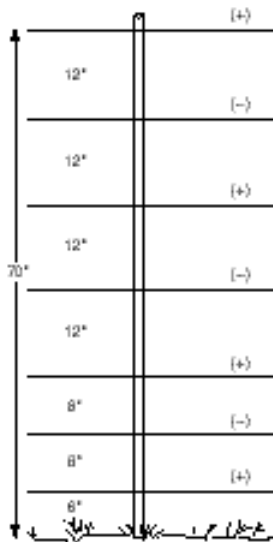

Figure 16

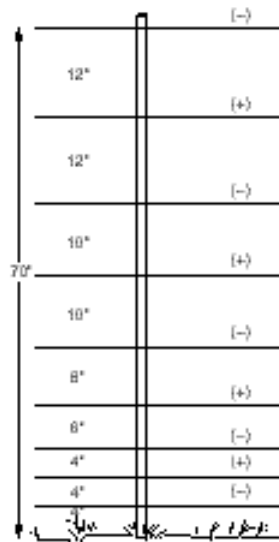

Figure 17

4 Foot High Electric Rail MULE

1 1/4" RAIL, 2" POST



Figure 18

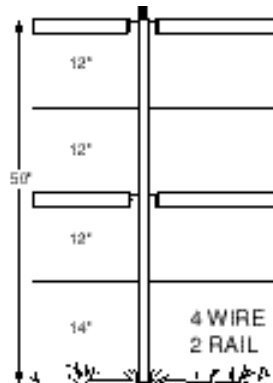

Figure 19

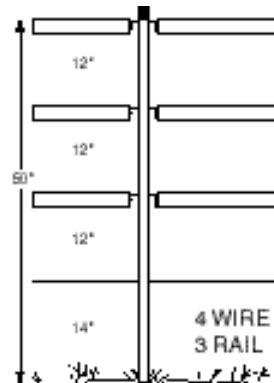

Figure 20

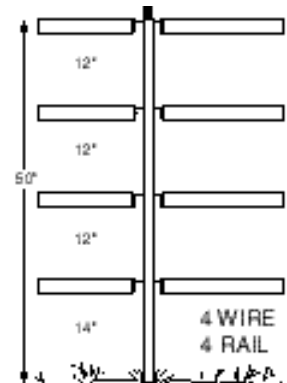

Figure 21

Embedded Secure Document

The file *file:///C:/CDROMs/SCDR-2/Prophecykeepers/POST-NUCLEAR-WAR/b_recovery/2_farm_recovery/ftpfiles/oilseed.pdf* is a secure document that has been embedded in this document. Double click the pushpin to view.



Individual Agricultural Recovery After Nuclear Holocaust

"The Farmer Comes First in the Reconstruction of Society"
(Techniques for Agriculture Recovery)

bruce@webpal.org

[Bruce M. Beach](#)

Table of Contents:

Prolog: [and about the Author](#)

For over forty years the author has proclaimed the necessity of nuclear survival preparedness. These pages, however, are concerned with the next step - recovery after nuclear holocaust. It is the author's recognition that "*the farmer must come first*" that has led him to develop these pages.

Introduction: [What the Farmer Needs](#)

The societal importance of the farmer
and how society needs to be reconstructed
to reflect that importance.

LETS: [How to operate without money](#)

This will be one of the major problems facing the farmer - and here is the solution. Barter is good - but this is much better. This webpage is actually in another section - but it is so important that it is again listed and linked from here.

Radiation: [Fallout and Radiation *IN FOOD* after a Nuclear War.](#)

There is so much information on this subject that this links to a separate Table of Contents where you will find information on everything including:

Overviews and explanations for the Layman
Fallout on the Farm.

Measuring Radiation in Food
Removing radiation from food and milk
Highly technical documents for health professionals

For much more detailed information about the effect of nuclear weapons, the measurement of radiation, radiation measuring instruments, and so forth, for *other* than in food see: [the Resources Section in the Root Web page](#)

[Agriculture: Farming After a Nuclear War](#)

There is so much here also that a separate Table of Contents is provided. Because many people may be returning to farming after several generations - basic farming skills are covered here but there are also some techniques that modern mechanized farmers may have ignored (such as seed saving and the use of humanure) and that may be of use to the experienced farmer.

There is also a lot about simplified farming in the separate Table of Contents linked from the Pioneering section below:

[Energy: Alternate resources.](#)

There are covered here a variety of alternate energy resources:

Stills for making an alternate to diesel fuel.
Generating electricity with home made generators made from:
Truck brakedrums using:
 Windpower
 Waterpower
 Bicycle power
 Small engines, etc.
Old electric motors
Homemade solar power heating systems

[Technology: Simplified Machines and how to make things work.](#)

Explanations of how many machines work and alternate approaches where they can't be fixed.

[Pioneer: The way they did it in the old days.](#)

Many skills that have been practically lost but that may be needed for a time during recovery.

What ???: **What else might someone recommend for this series?**

What things will farmers need to know that I have not covered here?

Prolog: **About the Author**

The purpose of this web page, as with many others that I written, is to assist mankind in the restoration of society after a nuclear holocaust, which I strongly anticipate to be its destiny.

The sub-title of this essay "*The Farmer Comes First in the Reconstruction of Society*" is self explanatory. Not only is it an obvious truth, it is also a subject dear to the author's roots. While it is true that he is the first generation in his family to be born off the farm, his wife was born on the farm and mostly for the exception of educational years and military service, he has lived in farming communities and among relatives that have remained in that industry.

While the author is particularly suited to deal with the problems of societal reconstruction, having been formally trained as an institutional economist, these subjects that he has written upon for many decades seriously suffer from the defect that there is almost total lack of dialog or critique because they are a subject in which there is practically absolutely no interest on the part of others. If you wish, you may:

click here to see my [bio](#).

and you may click here to learn more about [Ark Two](#)

and click here for more [nuclear recovery info](#).

Click here to return to the
[Table of Contents](#)

Introduction: **What the Farmer Needs**

For the farmer to accomplish his task,
he must have three things.

security

incentive

resources

While confiscation, plundering, theft, exorbitant taxation, forced labor, and other similar forms of social transfer can accomplish short term goals of acquisition, in the long run they are very inefficient. As well as are over-centralization of authority and bureaucratic overburdens.

Free competitive markets, individual initiative, entrepreneurship, private ownership of the means of production, and the other accretions of a free society boundlessly demonstrated their worth in the productivity of the North American farmer when combined with plentiful fertile land, semi-stable markets and revolutionary advances in technology and the biosciences. These permitted, in the last two centuries, an inversion of 90% of the population living on the farm and 10% off to 10% living on the farm and 90% off with there still being great surpluses of production for export.

With all that - the often instability of many of the food product pricing markets, the machinations of the banking and finance industry, along with the vagaries of weather and pestilence combined with the oft-time seeming burden of government regulations to make farm life one of turmoil as society struggled to find a just method of reallocation of resources from an overproductive industry to other fields which were also struggling with problems of oversupply.

The concern for justice, both for the farm community suppliers and the non-farm community consumers, must ever remain the foremost consideration of those who try to regulate the agricultural field at any time. Pure *laissez faire* is not the answer, as evidenced by what happened to the farm community in the Great Depression, and there is no question but that the instability of completely free markets can be equally detrimental to producer and consumer alike.

Scale of production, scale of processing plants, the means of transportation and distribution, costs for machinery, fuel, fertilizer, seed and other resources are all matters that have often been outside the control of the individual farmer or even the farm community as a whole. Any concept that individual farm families can retreat to an isolated unit on their own is totally unrealistic. The great productivity that was achieved in North America was achieved through efficiencies arising out of social organization, specialization and economies of scale.

While there was bounty, there were also many undesirable effects. Styles of life that were not pleasant to those entrapped in them - such as migrant labor, or often what amounted in fact to even slave labor for many producers in the world market. There was the expense of high production at the cost of an often onerous burden to the environment in the destruction of resources that would sometimes take centuries to replace, if they were replaceable at all, and there was reasonable suspicion that some of the methods of production resulted in product that was not as healthy for the end user as it should have been.

To the survivor's of a nuclear holocaust, many of the above points will seem to be but quibbles, and they will simply wish for the "good old days" before the nuclear war. However, we must remember that it was the power of the over centralized bureaucracies and the gigantic soulless corporations that created the problem in the first place. It was their unjust international transfer of resources and products of labor and the lack of universal concern for justice in economic exchange between all nations of the world in both agriculture and other economic spheres that created the social unrest, and eventual holocaust. It is not that institutional greed is more evil than individual greed, it is just that it is less amendable to rectification. Over the last two centuries the resulting terrible cost to the farm community has not been just an economic one but also, for untold tens of thousand families, personal loss of loved ones who were drawn up in the maelstrom of international conflicts, far beyond their personal interest, never to be seen again.

There is no question but that in time, productivity can be restored. However, the real question is - can justice be established - because that is something that has never been achieved. Justice, in this world, has always been, and always will be relative. Because there is always a better way and a worse way, we should try to find the better way. If we decide that we don't like peace, then we can always go back to war. And there is no question, that if we work at it, we can be ready for another nuclear war in twenty years.

Top down design has been the problem. Direction by gigantic entities of power, influence and control. The rule of power politics and special interest groups. The solution is bottom up selection WITHOUT POLITICS. The top will then reflect the aspirations of the bottom. All of this, I explain in the

[LETS](#) system.

Also, under LETS, no matter how misguided or mistaken the policies in the higher echelons may be, there still remains a degree of autonomous local control that permits the amelioration of what could otherwise be intolerable suffering.

Click here to return to the
[Table of Contents](#)

MENU: [HOME](#) » [Reconstruction](#) » [Recovery](#) » [Renewal](#) » [Survival](#)

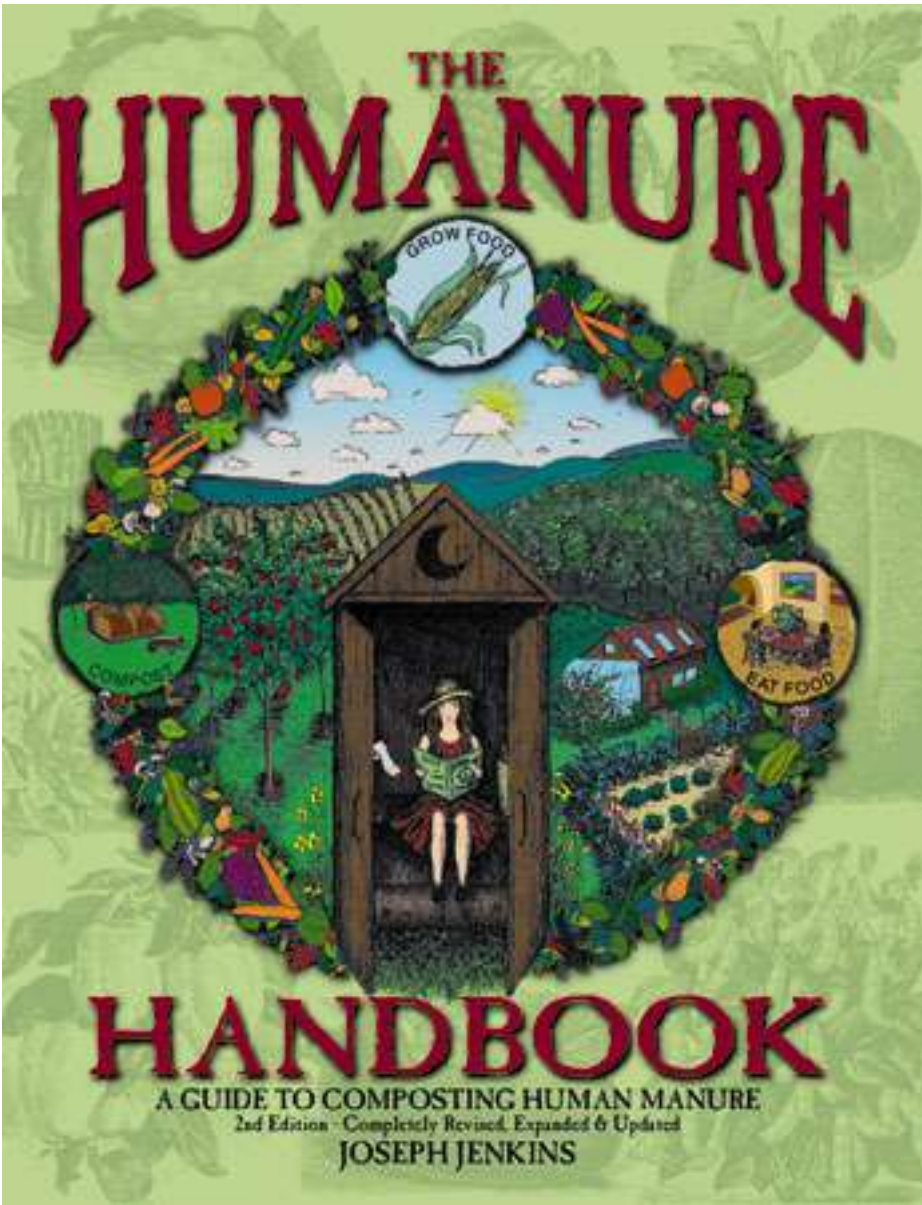

**2nd EDITION
COMPLETELY REVISED
EXPANDED AND UPDATED**

A book of great environmental importance.
302 Pages, 29 Photographs, Over 100 Tables and Figures,
Index, Glossary, Appendices, and a few bad jokes.

The Humanure Handbook

Now in dozens of countries worldwide • Amazon.com category #1 best seller

COMMENTS FROM READERS AND REVIEWERS:

- "World-shaking."
- "The perfect self-published book."
- "One book that could save the world."
- "Almost certain to become a classic in its field."
- "One of the most important books ever written."
- "Should be required reading for everyone on the planet."
- "You have answered questions I have held open since childhood."
- "After reading this book, you will never flush a toilet with indifference again."
- "Answers every question anyone could have about managing a compost toilet and compost pile."

Humanure: waste or resource? Joseph Jenkins boldly steps where no author has gone before. Considered by many a "moving" book, The Humanure Handbook will surprise you with its timely relevance, delight you with its humor, and impress you with its thorough research. Brilliantly simple, profoundly mundane, this is one book you will never forget. Full of "eye-candy" illustrations, practical information, history, philosophy, and science, it addresses an issue relevant to each and every human being on Planet Earth.



ISBN 0-9644258-9-0



9 780964 425897

\$19.00 US

Distributed by Chelsea Green

The Humanure Handbook

A Guide to Composting Human Manure

[Front Cover](#) - [Back Cover](#)

Table Of Contents:

[Show Chapters Only](#) - [Awards](#)

[Reader Feedback From The First Edition](#)

0 - [The Beginning](#)

1 - [Crap Happens](#)

2 - [Waste Not Want Not](#)

- [Human Nutrient Cycle](#)
- [Soiled Water](#)
- [Waste Vs. Manure](#)
- [Recycling Humanure](#)

3 - [Microhusbandry](#)

- [Vintage Compost](#)
- [Compost Defined](#)
- [Naturalchemy](#)
- [Solar Power in a Bananna Peel](#)
- [Gomer The Pile](#)
- [Four Necessities for Good Compost](#)

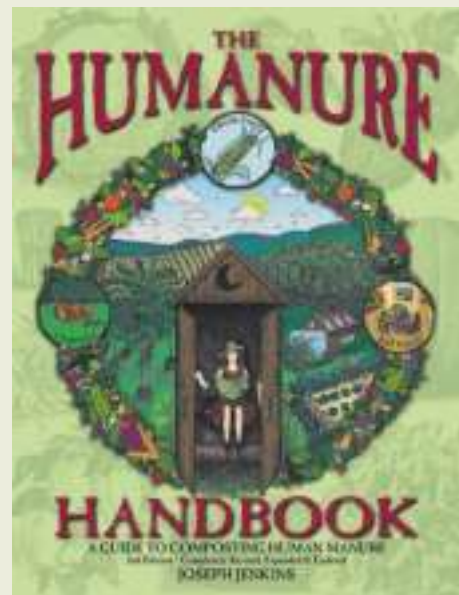

- [The Carbon / Nitrogen Ratio](#)
- [Thermophilic Microorganisms](#)
- [Four Stages of Compost](#)
- [Compost Biodiversity](#)
- [Compost Myths](#)
- [Compost Miracles](#)
- [Vermicomposting](#)
- [Practice Makes Compost](#)

4 - [Deep Sh*t](#)

- [The Ego Vs. The Eco](#)
- [Asian Recycling](#)
- [The Advances of Science](#)
- [When the Crap Hit the Fan](#)
- [Asian Update](#)

5 - [A Day In The Life Of A Turd](#)

6 - [Composting Toilets And Systems](#)

- [Composting Toilets Must Be Managed](#)
- [Fecophobia and the Pathogen Issue](#)
- [Owner Built Composting Toilets](#)
- [Asian Composting](#)
- [Commercial Composting Toilets](#)
- [Worldwide Sources of Composting Toilets](#)

7 - [Worms And Disease](#)

8 - [The Tao Of Compost](#) (*how to do it!)

- [Primal Compost](#)
- [The Sawdust Toilet](#)
- [The Compost Bins](#)
- [Normal Composting Bin Sequence](#)
- [Normal Composting Bin Sequence \(Continued 1\)](#)
- [Normal Composting Bin Sequence \(Continued 2 - Not Available\)](#)

- [Pathogenic Populations and a Two Year Retention Time](#)
- [Analyses](#)
- [Monitoring Compost Temperature](#)
- [Fecofrigginfobia](#)
- [Legalities](#)
- [Environmental Potty Training 101](#)

9 - [Alternative Grey Water Systems](#)

10 - [The End Is Near](#)

[References](#)

APPENDICES

Appendix 1: Temperature Conversions (Not Available)

Appendix 2: Sources of Wetland Plants (Not Available)

[Appendix 3: US State Regulations](#)

[Glossary](#)

Other Goodies:

[Join a discussion](#) with your fellow humanure composters!

PalmOS file in DOC format: [Chapter 8: Tao of Compost](#)

Copyright 1999, Joseph C. Jenkins

The following information may be reproduced subject to the following three conditions:

- 1) The information must not be changed or altered
- 2) The following information must accompany all copies:

Source: The Humanure Handbook. Jenkins Publishing, PO Box 607, Grove City, PA 16127. To order, phone: 1-800-639-4099.

<http://www.jenkinspublishing.com/>

- 3) The reproduction is not done for profit. Persons wanting to use excerpts or artwork from this book for a profit venture must contact the publisher for permission.

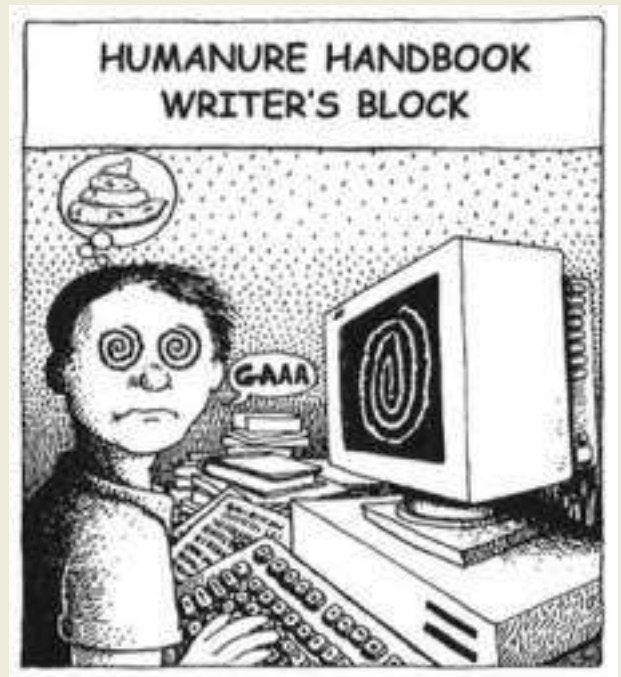

MENU: [HOME](#) » [Reconstruction](#) » [Recovery](#) » [Renewal](#) » [Survival](#) » [Humanure Content](#)

MENU: [HOME](#) » [Reconstruction](#) » [Recovery](#) » [Renewal](#) » [Survival](#) » [Humanure Content](#)

REAPING THE REWARDS OF RECYCLING

'Humanure' an Amazon.com #1 Category Bestseller Two Years Running, ForeWord Magazine Book of the Year finalist; Finalist in the Ben Franklin Awards for Excellence in Publishing



UPDATE! May 22, 2000: The Independent Publisher Book Awards 2000 has selected its winners, which include:

THE TEN OUTSTANDING BOOKS OF THE YEAR:

Most Likely To Save the Planet: *The Humanure Handbook (2nd Edition)*, by Joseph Jenkins; [Jenkins Publishing](#)

These results [have been posted](#) on the [Independent Publisher](#) website in time for the start of BookExpo. Award plaques and certificates were delivered on Friday morning, June 2, at BookExpo, or mailed to those who didn't attend. Specific title judging reports were sent to all publishers. Thanks to all 550 publishers that entered, and congratulations to you all for your excellent work.

Who would have ever thought that a book about composting --especially one proposing how to safely recycle human excrement -- would run to the top of Amazon.com's bestseller lists two years in a row? Or become a finalist in ForeWord Magazine's 1999 Book of the Year competition and in the Ben Franklin Awards for Excellence in Publishing?

Certainly not Joseph Jenkins, author and tradesperson, whose success with *The Humanure Handbook: A Guide to Composting Humanure* has earned him some dubious titles such as "King of Compost" and other unmentionables, and placed him on the receiving end of some pretty off-color jokes, but has also gained him some recognition as both an author and publisher.

"I never expected it [*Humanure*] to go anywhere," Jenkins said. "I didn't know how anybody would react, so I expected the worst. I estimated that maybe one person in a million would be interested."

However, since 1994, when the book was first published, *Humanure* has sold out four printings and is now in its fifth printing and second edition, having over thirteen thousand copies in circulation. In fact, Jenkins quickly sold out his first print run of 660 books, which, he thought, would "last him a lifetime;" he now sells approximately 500 of his books every month.

He has been contacted by hundreds of people all over the United States, and has sold his *Humanure* books in over 31 different countries around the world. The book has been written up by many media, including the *Associated Press*, *Mother Earth News*, *Natural Health* magazine, and *Whole Earth Review* and has been talked about on Canadian Broadcast radio, British Broadcast radio, Radio America, and even the Howard Stern show.

Using a biological, low-technology system of thermophilic composting, Jenkins has successfully recycled his own family's organic material for over twenty years. The end product: hygienic, nutrient-rich humus, is used to amend the soils in his food garden. *Humanure* was the inevitable result of Jenkins' two decades of practical experience with composting and organic gardening paired with extensive research

gleaned from scientific journals and texts.

But this is much more than a book on composting. In it, Jenkins exposes many environmental problems that have resulted from our view of organic materials as "wastes," and reveals what he feels are the underlying reasons why our relationship with the Earth is so dysfunctional. A review in *HortIdeas* (September 1999) touted *Humanure* as "one of the most important environmental exposés of all time," ranking right up there with Rachel Carson's *Silent Spring*.

Most recently, however, *Humanure* has received accolades through Amazon.com, an on-line bookstore that is, without argue, probably the largest on-line bookseller in the world, offering 4.7 million books for sale. For two years running, *Humanure* has achieved Amazon.com #1 bestseller status in the category of Soil Science (1998), and this year, in the Nature and Ecology: Recycling category. Jenkins' other self-published book, *The Slate Roof Bible*, was an Amazon.com #1 bestseller in 1998, in the Roofing category, and ranked #2 in 1999.

Humanure was one of seven finalists in ForeWord Magazine's Book of the Year Award program. More than 1,000 titles were entered in the 1999 competition, and award-winners were selected in twenty-three categories. ForeWord Magazine established this award in 1998 to recognize the vital books published by small, independent and university presses.

The *Handbook* is also one of three finalists in the Gardening/Agriculture category for the 2000 Benjamin Franklin Awards for Excellence in Publishing, a prestigious national award sponsored by the Publisher's Marketing Association, a non-profit trade association of 3,400 publishers. This year, over 1,600 entries were submitted, of which 165 were chosen as finalists. Award winners will be announced in June at the Book Expo America, the largest publishing trade fair in the world, which will be hosted in Chicago at the McCormick Place.

Source: Jenkins Publishing, PO Box 607, Grove City, PA 16127. To order, phone: 1-800-639-4099.
<http://www.jenkinspublishing.com/>

MENU: [HOME](#) » [Reconstruction](#) » [Recovery](#) » [Renewal](#) » [Survival](#) » [Humanure](#)
[Content](#)

Pot Luck Literary Appetizers

Reader Feedback from the First Edition

The first edition of this book was self-published on a meager budget and was expected, by the author, to require a total lifetime print run of about 250 copies. It was assumed that there was little, if any, interest in the topic of composting human manure, but the degree and nature of feedback that resulted from this unlikely book was surprising. The first edition of Humanure eventually amounted to over 10,000 copies in circulation. Excerpts from a sampling of the letters sent to the author are presented below. Some of the writers offer insight about their own composting experiences, which you, the reader, may find useful or interesting. At the very least, the following testimonials are inspiring, and they indicate that more than a few people care about our planet, and how we live on it.

“Thank you so much for your book. I believe that it is one of the most important books ever written. (I also enjoyed your web site very much.) I finished reading your book less than a month ago and have already participated in building two compost bins and am currently in the process of building the toilets to go with them.” S.U. in ME

“The potential of the ideas in Humanure is so great in problems such as hollow food, landfill capacities, population densities . . . that I feel rather evangelical about the book and hope that others will also.” R.S. in OH

“If this short sentence, ‘We are defecating in our drinking water,’ was put in front of our eyes frequently enough, more and more people would realize that this absurd behavior can’t go on much longer.” S.A. at BioLet International “You have done the world a great service, and I thank you from the bottom of my (heart)!!” B.F. in NV

“I’m so glad you wrote this book - one lady told us it should be required reading for everyone on the planet!” D.W. in PA

“My husband and I own a small sawmill with plenty of leftover sawdust needing to be put to use. Also, my 74-year old father thinks human waste should not be used in a garden, and I want to prove him wrong.” A.M. in WA

“Your book is pure gold, just what I needed to give to my County Health Department head who is willing to go along with my desire for alternative systems.” M.T.

“Your discovery of the proper small scale of the operation is world-shaking, together with the exemplary continuous-by-small-increments rate of production.” F.A. in DE

“I enjoyed your book immensely. It clarified several technical and practical points. My mother is appalled that we would put one of ‘those things’ in the new house we’re building, certain it can’t be legal. Now that you’ve put the point in print we’ve been reduced from lawbreakers to just crazy. Pleasing me and irritating my mother, you score big in my two favorite categories.” K.L.

“This wonderful book fits right into my COMPOST=REDEMPTION religious philosophy. You have answered questions I have held open since childhood.” R. in MA

“May I join the chorus, too? The most exciting book I’ve read in a long, long time is yours. What a gem! Fun! A bumper sticker ad for the book should read, ‘The Humanure Handbook Proves It: People Are Smarter than Shit!’ Some people, anyway. ‘Fecophobia’: A new word for me and one that speaks volumes. As E.O. Wilson discovered ‘biophilia,’ so there is such a thing in humans as ‘biophobia,’ and you’ve discovered and named very appropriately one of its roots: fecophobia. It’s a real problem, and its solution, I think, is biophilia, fecophilia. Your discovery of appropriate shit technology, including an appropriate ‘throne,’ makes the billions we spend so we can shit in drinking water appear finally and totally absurd.” V.L. in FL

“I should have written this letter sooner. I would like to say that it is relatively rare to read a book of the calibre of the Humanure Handbook. A book that is enjoyable to read, empowering, hilarious, and has eye-candy pictures throughout. It’s an unbeatable combination.” J.D. in CA

“My budget is limited, so I don’t buy many books. This one, however, I really had to have for my personal library. I borrowed your book via interlibrary loan and have already read it twice, but I wanted one to keep! Please send the Humanure Handbook!” L.M.

“I really celebrate your book and your willingness to step forward and break the crystallizations of fear around composting human manure. I know for a fact I would not be taking the steps toward taking responsibility for managing the feces and urine within our community without this book.” L.F.

“After having finished your book, the Humanure Handbook, I’m more convinced than ever that those in charge of our society have no idea what the hell they’re doing.” J.R. in ME

“I knew nothing about this topic and by chance I purchased your book. Before reading I felt a little reluctance. However, once I started reading, I couldn’t stop. As English is not my mother language, it took a lot of time (all the words I didn’t understand I looked up in

my dictionary). You are doing a great service to humanity by having the courage to publish your book. It is said that example is the best teacher.” B.E. in Belgium

“Your book proved to be not only entertaining but also an invaluable source of information and reference. Thank you! At the hostel, your book has made it to the ‘shelf of recommended literature.’ On this shelf we display books we recommend our guests to read. Your book is placed between Thoreau’s *Walden* and *The Encyclopedia of Organic Gardening*.” J.N. in GA

“I just wanted to thank you for your valuable research you have done on the sawdust toilets. I enjoyed your book very much and have loaned it to many friends who seemed too embarrassed (or cheap) to buy it themselves. There must be quite a few readers of your book out there because I am seeing quite a few sawdust toilet and human manure discussions going on in the various straw bale and homesteaders news groups.” D.K. in IL

“I’m just reading the *Humanure Handbook* and kicking myself for a fool! I’ve been composting for a long time. I’ve been buying everything I can on composting — old and new — especially on composting toilets and have been banging on about it for years, but have never managed (apart from the mouldering *Clivus*) to use one. Now the solution is so simple I shall simply remove our existing W.C. under the stairs and replace it with a sawdust toilet and everything else is in place! At the moment, I’ve been saving all my urine, which I add to the woodchip piles and that steams along merrily enough. Thanks for your book and providing the missing link! Yours steamingly,” N.S. in UK

“My wife and I found a copy of your *Humanure* book last year, and have been living well with a sawdust toilet since then. (A blessing, after having spent gobs of time and money putting together a 150 gallon fly-breeding solar toilet — nothing like feeling little crawlies on your bum!)” P.U. in NM

“One thing you’ll get a perplexing kick out of regarding *Humanure* and Papua New Guinea is a problem. Shit is part of you, goes local tradition. There it is, wasn’t there before, dropped out of you. Therefore, it is you. Now with witchcraft being a major player here, all one has to do is pick up some of your shit and do nasty things with it (incantations or who knows what) and voila! you’re done for. When I asked one very devout Seventh Day Adventist lady how her father died, she said, ‘The traditional way. Someone didn’t like him and made magic against him.’ Joe, I don’t think *Humanure* stands a ghost of a chance here, although I’ve mentioned it several times to the living. Go figure on this one.” D.B. in New Guinea

“I am working as a development advisor to the Minister for Agriculture and Livestock here in Papua New Guinea, and [am] working on ways of encouraging people to shifting agriculture practices to site stable agriculture, which will require the input of more organic

material as Papua New Guineans generally have insufficient finance to purchase chemical inputs. Some time ago I purchased . . . a copy of the Humanure Handbook, and I found it quite fascinating. Thanks for the information you put together in the Humanure Handbook.” P.H. in Papua New Guinea

“I’m wracking my brain, trying to find a compelling way to tell you how great I think your book is. Here are some stabs: By the time I got to page 61, I had a mud bucket and a bag of sawdust set up in my bathroom.” K.W. in WI

“Just finished reading your book, and I’m glad. Seeing Mr. Turdly dancing around the compost pile wasn’t my ideal dream. Overall, I think your simple, low-cost and safe thermophilic system is a fantastic solution I’ve been looking for. I’ve been composting and using my own waste the past 20 years. Most of my friends think it odd. I counter that not even barbarians piss and shit in their drinking water.” E.S. in WA

“Please send me two copies of your beautiful book. I live and work at an International Youth Hostel . . . and we’re using your sawdust toilets.” B.S. in GA

“For 22 years, I have used scarab beetle larvae . . . they eat my shit in 5 minutes flat.” C.M. in SC

“I really appreciate the fact that someone finally did their research and put it together in a pleasant, readable form. I have felt strongly about our absence in the food nutrient cycle for a long time, but lack the talent of articulation that you have shown. We have been recycling our humanure since 1979.” S.C. in WI

“Great book! Thanks so much for writing it! I had to call my dear heart long distance immediately to read her what may be the most hopeful environmental news I’ve heard in my 35 years, that something can transmute horrible toxins. Why aren’t all the environmentalists raving about this and demanding major research on the applications?” C. in VT

“Your recently published book, the Humanure Handbook, is one of the most serious and humorous, well-researched yet humble, and motivating works I have read in a while. My personal research for some time now has focused on how to maintain soil fertility with minimal or no reliance on synthetic fertilizers. While I have focused on soil attributes that provide native fertility, I have known all along that a chunk of the cycle was absent. If you could claim credit for engineering the thermophilic decomposers, you would probably win the Nobel Peace Prize.” T.C. in AZ

“From the squatting position, I request a copy of the Humanure Handbook.” E.P. in RI

“I already knew that composting human waste made sense, and I had been looking for more practical information. Your book was exactly the information I was looking for, and it inspired me to put the ideas into action.” B.C. in NYC, NY

“Thank you for putting the time, energy, [and] money into creating this unique, needed book. Your wit, wisdom, factual references and above all, your personal experience, make it a great and encouraging work.” C.L. in NY

“Thank you for providing the information on dealing with shit in a responsible manner. As you know, the simple logic and responsible actions outlined in your book are rare in our society.” J. in AK

“I recently read and thoroughly enjoyed your Humanure Handbook. I am an engineer who currently designs services, including sewers, for new developments. In recent years, however, I have become convinced that the way we deal with humanure, as you call it, is not far short of ridiculous. So, I have begun to educate myself about alternative ways of treatment and reuse.” D.C. in Canada

“Thank you for your wonderful book about an environmental threat most people are unwilling to discuss, yet contribute to daily.” P.K. in NH

“I have taken three dumps since finishing the Humanure Handbook, and all of them have been in plastic buckets and have been covered with sawdust.” M.W. in WA

“You’re right, it is the shittiest book I’ve ever read — but it’s great! Have been a composter for a long time, but you showed me some new tricks.” R.H. in WY

“I want to thank you all so much for the ‘pioneering’ work you have done with humanure and writing the Humanure Handbook . . . with the information you have provided I can complete the cycle.” R.B. in FL

“I . . . spied an ad for your book, the Humanure Handbook . . . up until that point, it had only been a dream to somehow use my waste for fueling something that is necessary for my way of life. Now I have hope for a better future for myself, my family, and for the generations that will live on in this world after me.” O.M. in CA

“A little over a year ago . . . I was in Guatemala . . . when I came upon a certain Humanure Handbook being carried around. I only had access to the book for less than one day, but . . . I devoured it, became a proselytizing devotee of the composting method and thermophilic bacteria and I am forever grateful to you for your amazingly thorough research and easily readable and digestible book.” R.T. in CT

“Thank you for putting out such an important book . . . it feels good to know that there are fellow humans out there that realize that there is a way, a healthy way, to our actions that is good for all.” D.D. in Canada

“Really enjoyed your book! As a public health person and 25 years as an organic gardener, the content was great.” J.P.

“I am stupefied after reading your turdly book! What a masterpiece of modern literature. A real wake-up call for human types. In the future, I intend to follow all of your sensible suggestions and have a sawdust toilet.” W.K. in AZ

“Your book was extremely well-written and answered all the questions I had been having for several years. I knew that somehow there was some missing info about what to do with all the ‘do-do’.” R.L. in FL

“I just picked up the Humanure Handbook. It is full of humor, pluck, good advice and spirit. Someone I know locally has been championing your system for the past year. I’ll have to try it myself.” M.Z. in CA

“I’m almost done reading your book. Terrific. It definitely goes on a shelf next to How to Keep Your Volkswagon Alive and a few other ‘anybody-can-do-this’ type treasures. You’ve got me convinced. I’m partway through building a new house, and I’ve penciled in where the bucket will go.” D.B. in MN

“For many years, I have wondered why we can use cow and horse and pig manure for our gardens, but not human manure. I showed this article to my father who was raised on a farm and he almost gagged. He couldn’t even finish reading the article. I guess you’d call him a fecophobic. Could you mail the handbook in a wrapper that has no mention of ‘humanure’? I live with my parents.” M.C. in CO (future composter)

“I recently purchased your Humanure Handbook. It is fabulous. I want to give it to EVERYONE. Please send me four more.” L.F. in CA

“I have just finished your book . . . and I’m still wiping the tears off my face from laughing so hard. I never thought a book about human excretion could be so humorous, as well as very informative!” A.R. in OH

“I heard so many good things about the book while in the United States for summer holiday . . . that I combed all the bookstores for a copy of it. I am happy to report I have suffered no buyer’s remorse since the purchase. The book is extremely moving, in all sorts of ways. When I leave the urban desert, I plan to practice what you preach in the book. Even more exciting is the prospect that your book has darn near sold my wife on the idea,

too. When she sees the system you describe in action, I know she'll make the final step onto the bandwagon." D.G. in Abu Dhabi (United Arab Emirates)

"We had been looking for some info about safely composting our do-do for some time. Your book was a blessing and please know that it was an easy, fun read. Got the toilet installed day before yesterday and built a bin yesterday. Thank you for all of your hard work in doing the research and letting us all know that we are not alone in our way of living a more civilized way than the present barbaric generation we find ourselves among. What you have given us is the info we have been seeking, which empowers us to make an almost perfect circle with our resources." R.L. in FL

"Two things you might be interested in: a more natural way to eliminate is in the squatting position (supports the colon and all that shit). Maybe you might show (or offer the thought to future readers) of raising the knees higher — a step (simple block of wood, or big rock might be one solution). Also, more (food?) for thought. Urine is not a waste product. It is from the blood in our body. The excess nutrients and minerals that the body does not need at that moment has been filtered out (how marvelous). Taking urine internally has been going on for some time (1000s of years) and by many is considered a wonderful medicine. (Reading: 'Your Own Perfect Medicine') I take my first urine daily. Also, urine is used today in Murine's Ear Wax Removal, hand creams and other [products]. Now is that full of crap . . . or is it?" W.E. in OH

"Your book saved my butt at a town council meeting yesterday. Thank you for writing it." D.W. in CO

"With raised beds and numerous compost piles, it was only natural to be loaned a copy of the Humanure Handbook (carefully handed to me in a plain brown paper bag at church last spring). Great research, clear writing and terrific humor! I really should return that copy, so please send me one." L.U. in WV

"For over 40 years we have lived a more 'natural' way of life. Now the 'Authorities' are making it known we must conform to more (according to their beliefs) appropriate ways. He is 88 and I'm 77 — we need this help now! Please send us a copy of the Humanure Handbook." E.P. in NH

"As parasites attached to the Earth, it would seem that the only conscious thing we do that isn't killing the host, is manuring in the woods, fields or [in] a composting toilet." D.G. in MN

"In the past month I've made two humanure converts, both single women (living separately), both organic gardeners, both professional cooks. The biggest lure for them was the quality of my garden, and the opportunity to avoid purchasing fertilizer and soil

amendments. Now they're hooked, preaching to their friends. Could be the start of a Big Movement." L.W. in WA

"I have just finished your book, which I found in somebody's house near Plettenberg Bay in South Africa. It took me four hours, cover to cover, and it's 3 a.m." A. M-J. in South Africa

"I just got your Humanure book and want more! We are trying to educate the Commissioners and public regarding doing the right thing and your book is timely!" T.P. in NJ

"Could you send me a copy all the way to Guatemala? Communities are ready to start a composting toilet project . . . send it as soon as you can." T.B. in Guatemala

"I liked your book. Putting back nutrients after taking them away makes sense as well as the image of dropping a turd in a five gallon toilet filled with pure drinking water seems crazy." T.O. in NH

"I work in a number of ways with state agencies that 'regulate' compost and land applications of biosolids. I will read your book with an eye toward putting copies in numerous hands — from bureaucrats to legislators to environmentalists — and more." D.R. in TX

"We are just beginning on the adventure of 'recycling' all of our human waste, including manure. And there is so little written that is available — I'm really glad that you took the time to write about your experience." D.P. in CA

"We're a couple of kids (late 60s-early 70s) pursuing composting. It's the only sensible and logical way to go." C. K-L. in OR

"I found your book entertaining, informative, and a great motivating force compelling us to start recycling our 'humanure' immediately. Having grown up with outhouses . . . I always thought there had to be a better way." B.W. in TX

"I'm the graduate student you just sent a copy of your handbook to. The book and resource list have both been just what I needed. I'm trying to get my parents thinking about composting their 'reusable' body materials (they already compost kitchen scraps, as I do). They are in the country with a very shallow well. They are already short of water and their troughs used to catch rain are dry. Dad is a Parasitologist, so you know he'll want to make sure the stuff heats up right. I would like to buy them one of your books. That'll make a good birthday present for Pops." S.M.

“We have a cabin in the mountains of North Central Washington that is off the grid, off the road and off just about everything. My wife and I spent Thanksgiving there and at this time of the year the outhouse is very uncomfortable. I believe your book will allow us to move it to more comfortable quarters.” L.V. in WA

“I’ve spent my whole life recycling, reducing and reusing everything but my own shit and I [am] ecstatically grateful to have your directions reach my lap.” W.

“Thank you for your work in the Humanure Handbook. Your ideas have been a real encouragement to me to give composting a try in my sustainable home project. I was impressed by your research, the depth and scope of your study.” J.D.

“The reason I’m writing is because I believe worm-egg phobia is overblown. I’ve been a pig farmer for decades, had probably literally tons of pig manure dumped on me over the years, have had pig manure get inside open bleeding wounds, have had it ‘splash’ into my mouth, and I can say that I’ve never gotten ill from it nor have I had any intestinal problems except when I got my divorce (ulcer). But I can say quite accurately that I’ve gotten ill a few times from eating in restaurants. I ask you, which is more dangerous, restaurant food or hog manure?” R.T. in WI

“Our son’s Pa . . . was the one who tracked down your book . . . got our head librarian to order one for the Islands library and then created his own techniques. He feeds his bucket to several worm bins. They keep up with it . . . and it smells just fine. He also lines his bucket with a brown paper bag. It keeps clean-up easier — and is a great use for a bag that’s had several uses but isn’t fire starter yet. He found an antique porcelain receptacle with a toilet seat half buried in a vacant lot next to us and gifted me with it. A four gallon square bucket fits nicely and gives me over two weeks of use. When its full, I strap the plastic bucket onto my custom-made bike cart and off I go to our neighboring 10 acres where we are moving to this spring. I’ve got a bin set up using pallets on four sides — three narrow pieces of plywood overlapping on top with rubber tires to hold them down (all recycled, naturally). We’ve got huge piles of straw, manure, sawdust matter from the fairgrounds, bales of hay, bags of leaves and then I’ll occasionally bring some kitchen scraps over. My serious winter sprouting gives me root mats after harvesting buckwheat lettuce, wheatgrass, and sunflowers. They are a great layering agent in our worm bins. I must say — this is very exciting to us — and I can’t wait to dip my probe down into my pile in say, two years. I had to chuckle last week when I came around the corner on my bike with cart and bucket in tow. There was my neighbor directing this huge septic tank down into an excavated hole right next to his house. Everything about his ‘new’ home says toxic to me!” B.L. in WA

“Ah hah!! There is an intelligent lifeform out there. My husband and I have seen your book advertised in Countryside magazine for a good while. I finally came across it at the

local library, checked it out and will eventually add it to our library. Great reading, common sense information, very well researched. We started your sawdust toilet idea at once. We are old dogs, but not too old to know a logical thing when we read it. Thanks, and bless you and yours.” E. & J.C. in OH

“Thank you so much for your book, humorous and well written. We are enjoying it. We have just received it yesterday. We will be posting you the pictures of our composting toilet on the beach this week. And again many thanks.” G.F. in Indonesia

“Humanure and the potential for large-scale . . . even a city size composting collection (apartment building toilets into a central collection dumpster), along with the crimes of the so-called ‘septic system,’ has become one of my most favored topics of conversation and promotion. Often through direct exposition at our farm. Many thanks for your noble work of art and contribution to this stinky species of ape.” R.T. in CT

“I couldn’t resist writing you to say how much I enjoyed your book. Normally I can’t absorb the written word very easily, but I soaked yours up, which I guess is rather appropriate. I’ve been composting for several years now. Robotically and indifferently at first, but gradually developing to a level which I can only describe as obsessive. I bore everyone silly talking about it — except my fellow composters, that is, and there are several around here. As I got more into it, I found myself thinking about the possibility of composting bodily harvests, until it got so every time I sat on the loo and performed, I was begrudging every turd! Becoming more and more conscious of the waste and stupidity of the whole system with every plop, the idea slowly formed in my mind that perhaps I could do something about it. Reading your book clinched it. I have resolved to pull out of the mainstream sewage system, hence the ordering of the most capacious compost bin I could find. As the rest of my family find the idea abhorrent (ha, ha — in their lifetime it will most likely become law!), I’m forced to go it alone.” J.M. in England

“As a small publisher and writer, I don’t often take the time to write fan letters and testimonials, but this is both. We’ve lived on a small island in the Pacific coastal rainforest for 20 years and have been composting/mouldering our shit since we moved here. We’re glad to have some new arguments to use from your book as, over the years, a few guests weren’t too enthusiastic about our system.” C.H. in Canada

“We’ve read your book from cover to cover and are planning to implement it this summer when we move to our paid-for place in the country. Thanks for the great information. I publish a Christian Homesteading magazine. We will [also] be publishing a special newsletter devoted to Y2K problems . . . deal[ing] with the nitty-gritty, how-to preparedness topics and Humanure compost toilets will fit right in.” J.E.

“We live in Mexico in the high desert of San Miguel de Allende where the water is

precious and the soil is lousy. You've solved two of our biggest problems . . . My husband is so FECOPHOBIC, that he swears he neither shits nor farts. Getting him sold on the idea will be a problem. Any suggestions? I, of course, will be the one to empty the bucket." L. in Mexico

"Recently a friend of mine lent me a copy of your book *The Humanure Handbook*. To say that I enjoyed and found useful the contents and message of the book would be a considerable understatement. And in short i would very much like to purchase a copy of my own. Thank you for all your time and effort in making this information available." Rev. H.G. in CA

"Great book! I really loved it. We are soon to move to a new house. I can't wait to start composting humanure. Thank you for all the information in the book. It will sit on a special shelf in the bathroom — reading material for those occupied in communing with nature!" B.C.

"Twelve years ago, I designed and built a solar powered home, and have been repeatedly told (so I now believe) that I am a very creative person. So, as I was reading your incredibly inspiring, well-written, humorous, and innovative book, I kept asking myself . . . Why didn't I think of this? You are truly a gift from — and to — Mother Earth. Thank you, thank you." O.B. in ID

"I continue to be moved to hilarity by your writing, and the cartoons are pretty good too. Best of all is that your method of killing pathogens and parasite eggs and returning nutrients to the soil is virtually free. We are an environmental education center as well as a land trust community. So far we focus mainly on sustainable building, biointensive gardening, and wildlife management. I have a particular interest in a very simple lifestyle — sort of a radical eco-luddite anarchist type myself. Thanks again for the book!" M.M. in TX

"Your book came up in a search on Amazon.com and here I am, having just finished it, feeling like a man whose universe, at least one little corner of it, has condensed and collapsed, fallen into effortlessness, into rightness like a neutron star, like a compost pile. eureka! refinement! My shit makes sense! at last! Thank you." R.P. (fellow common-senser) in MA

Source: The Humanure Handbook. Jenkins Publishing, PO Box 607, Grove City, PA 16127. To order, phone: 1-800-639-4099.

<http://www.jenkinspublishing.com/>

MENU: [HOME](#) » [Reconstruction](#) » [Recovery](#) » [Renewal](#) » [Survival](#) » [Humanure Content](#)

A word with the Author

"The balance of nature is . . . a complex, precise, and highly integrated system of relationships between living things which cannot be safely ignored any more than the law of gravity can be defied with impunity by a man perched on the edge of a cliff."

Rachel Carson - *Silent Spring*

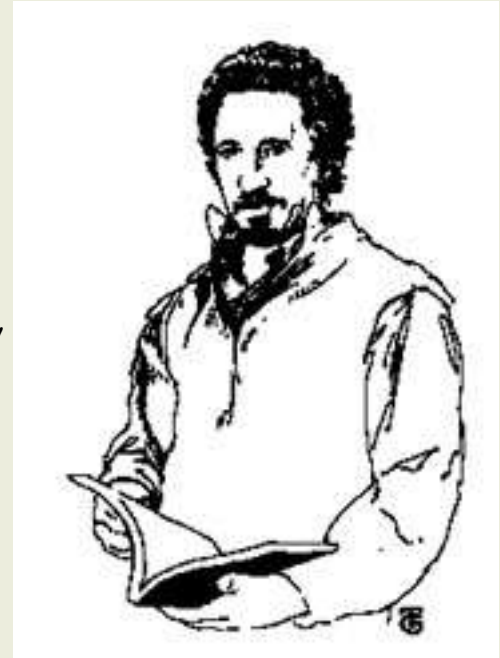

As I was writing this second edition of *Humanure*, I got a phone call from a fellow who was working on a national Community Disaster Preparedness Manual, a project with a federal mandate and federal funding. This project was precipitated by the concerns surrounding the “Y2K” (Year 2000) scenario, which was supposed to be fraught with the wholesale collapse of civilization due to pervasive computer design flaws. Computers would not be able to recognize the beginning of the new century and would just crash. This could result in wide-ranging and possibly prolonged disruptions of electrical, water, food, and fuel supplies, among other things. Or so we were warned.

The authors of this manual had to assume these disruptions could occur for two days, two weeks, or even two months, and the manual had to include instructions for all three of these contingencies.

The people working on this problem seemed to be able to come up with stop-gap solutions for every potential obstacle: food shortages (food can be stored), fuel shortages (wood or kerosene stoves can be used as backup heaters), or no lights (candles would work). There was one problem, however, for which no solution could be found. In fact, the fellow on the phone confided that they were considering abandoning the project altogether, because, in the words of many experts in the field, “it can’t be done.”

What exactly was this impossible problem, you may wonder? In a word — sewage. What do you do when the toilets won’t flush? What happens when the water doesn’t pump and the drains don’t drain? Conveniences like flush toilets are totally dependent upon the electrical grid and completely reliant on a constant water supply. When the electricity is out and water is unavailable, how do you flush a toilet? Answer — you don’t.

When this question was posed to the professionals in the field — wastewater treatment managers, waste management people, and sewage experts, they all drew a blank. One suggested that gravity drains would still work; sewage could be dumped down those drains, eventually reaching a wastewater treatment plant. It could then be heavily chlorinated before being discharged directly into the environment. He admitted this would only work for about two weeks until the chlorine supply ran out, after which the sewage would be released directly into surface waters, totally untreated. He also admitted that wastewater treatment plants only keep about a two week supply of chlorine because it is such a dangerous chemical. After two weeks, in a disaster scenario, raw sewage would be dumped into the environment — a situation that usually precedes the spread of deadly epidemic diseases.

Two things came to mind when I talked to the disaster-manual fellow. First, people need to realize that life as we know it won't continue forever. The environmental repercussions of our consumptive, throw-away lifestyles may catch up to us sooner than we think. Computers crashing may look like a Girl Scout picnic compared to global climate changes, cancer, new epidemics, and other calamities that can now be directly linked to our excesses. People also need to realize how fragile their lifestyles are, hanging by a thinner thread than they can imagine. Some power outages and food/fuel shortages could be a wake-up call for many.

Second, I never cease to be amazed at how thoroughly our society has ignored any constructive alternatives to sewage. We've put all our eggs in the flush toilet basket, and when the toilets won't flush, we're clueless. Ironically, it's this squeamish refusal to look at our own excrement that makes it such a threat to our health and safety. If we can't flush it, since we've developed few alternatives, we just dump it. This is a big mistake, not only because we're discarding valuable organic resource materials, but also because we're polluting our environment in the process, perhaps dangerously so.

So I told the disaster-manual fellow that two five gallon buckets and a large bag of peat moss or sawdust will make an emergency toilet for one person for two weeks. If a compost bin and a steady supply of sawdust or peat is available, that toilet could last indefinitely. With proper oversight and management, that person could be in a Chicago high-rise or in a Boston suburb. But I'm getting ahead of myself.

The point is that we don't know how to deal with human excrement because we don't see it for what it is. It's not a waste material, it's a resource material. When we see it as a resource, we can understand how to recycle it. When we adamantly insist upon seeing it only as a waste material, we're painting ourselves into a corner. By believing we have to *dispose* of that waste, we burden ourselves with an increasingly impossible challenge.

The first edition of *Humanure* went through four printings and around the world to at least 31 countries. It was discussed on British, Canadian, and US airwaves, and on US network TV. It was written up by the Associated Press, and in various national magazines. These are small accomplishments in the publishing world, but significant for a self-published author's first book. Yes, I did say *self-published*. That means I, the author, and I alone, take full responsibility for creating this book, designing it, getting it into print,

marketing it, and making sure it is distributed. I am not a person with deep pockets or an inheritance. I'm a person who writes during the winter months in a small office off my bedroom, at home, in Pennsylvania.

I first published *Humanure* with some degree of hesitancy. After all, composting humanure in America can be as bizarre a concept to some people as the sacrificing of small animals for religious purposes. I wondered how wise it was to publicly admit that I had shat in a bucket for decades. I knew I risked being considered some kind of crank. I imagined Merle at the local hardware store no longer wanting to shake my hand, or making haste to the washroom to scrub his hands immediately thereafter. I wasn't sure I even wanted anyone to *read* the book, and although I knew some people would be fascinated, I just didn't know who or where they were. I estimated that maybe there were 250 people in the US interested in the topic of humanure composting (one in a million), so I printed a small number of books the first time around and assumed they would sit in my garage for the rest of my life until I discovered, one by one, those 250 potential readers.

Was I ever wrong! No sooner had I printed the first batch of books than a friend wanted one. He showed it to his girlfriend, a newspaper reporter, and she showed up at my door — with a camera. In a matter of days, the story of a man composting his family's you-know-what in his backyard was out on the Associated Press, with a huge photo of me poking around in a compost pile with a pitchfork. The TV stations thought this story was newsworthy enough to broadcast, and a friend called to say he saw the book mentioned on the TV morning news. He laughed out loud as he told me of the lady news anchor stuttering when she had to say the word “turd” on TV. Someone should have warned her one of *Humanure's* chapters was titled, “*A Day in the Life of a Turd.*”

Next I got a call from a group of nuns wanting me to do a presentation about humanure at their convent. I never would have expected anything like this, but I obliged them, and they taught me something about spirituality and humility, which is mentioned in Chapter Four. As more time passed, I learned more and more new things from others. In the meantime, I kept selling out of books and doing larger and larger reprints. More speaking engagements popped up. Then the Pennsylvania Department of Environmental Protection told me *Humanure* was nominated for an environmental award. Even the BBC called from London and wanted to do an interview. I seemed to be getting a lot of publicity for a guy who didn't want anyone to read his book.

Then I started to get reader feedback. I suppose people won't write to you if they *don't* like your book, because all of the feedback has been positive. And a lot of it was intriguing enough that I have included “*Reader Feedback*” excerpts throughout this second edition.

Why *did* I write this book, anyway? Probably because I have personally recycled all of my family's humanure since 1979 (twenty continuous years at the time of this writing) using very simple methods. The resulting compost has always been used in our food garden. We have never produced any sewage from our home. Instead, all of our organic residues are carefully recycled by composting and are then returned to the soil, humanure included, thereby maintaining the fertility of our food gardens and

eliminating organic waste altogether.

As I wrote this second edition, I was interviewed by yet another newspaper reporter about my books. The young lady came to my home for the interview and asked, innocently enough, after we were well into the interview, “What do you do with your sewage?”

“We don’t have any sewage,” I replied, matter-of-factly. “I’ve lived here twenty years and we’ve never had any sewage.” The blank look of utter incomprehension on the young lady’s face was worth photographing. She didn’t have a clue, and I don’t blame her. I briefly explained to her that sewage results from the disposal of waste into water, and that when organic materials are instead collected without water and composted, there simply is no sewage. She vowed to cultivate her fledgling understanding of this new concept by actually reading my book. And that, it seems to me, is a good reason for me to have written it.

The more research I did on this topic, the more I realized there was precious little information about humanure recycling in print. It’s no wonder people’s faces go blank when confronted with the concept. Although bits and pieces of information were available, they were scattered about in hard-to-find, obscure references. I knew that where there is ignorance, there is misunderstanding. So I have compiled this information and written this book to try to shed a small ray of light onto what is otherwise a dearth of information. I do not claim, by any means, to have all the answers, but I do hope to be able to provide at least a *starting point* for those who seek information about the topic.

I do not consider myself an “expert.” I make no pretense along those lines. But with 24 years of organic gardening and composting experience, I’ve learned a thing or two which may be of interest to the average reader. I’m sharing those things with you now, and you can digest what you want, and, well, you know what to do with the rest.

By the way, Merle at the hardware store still shakes my hand. And I’m even getting used to his rubber gloves.

JCJ, Winter 1999

Source: The Humanure Handbook. Jenkins Publishing, PO Box 607, Grove City, PA 16127. To order, phone: 1-800-639-4099.

<http://www.jenkinspublishing.com/>

MENU: [HOME](#) » [Reconstruction](#) » [Recovery](#) » [Renewal](#) » [Survival](#) » [Humanure Content](#)

CRAP HAPPENS

Something's About to Hit the Fan

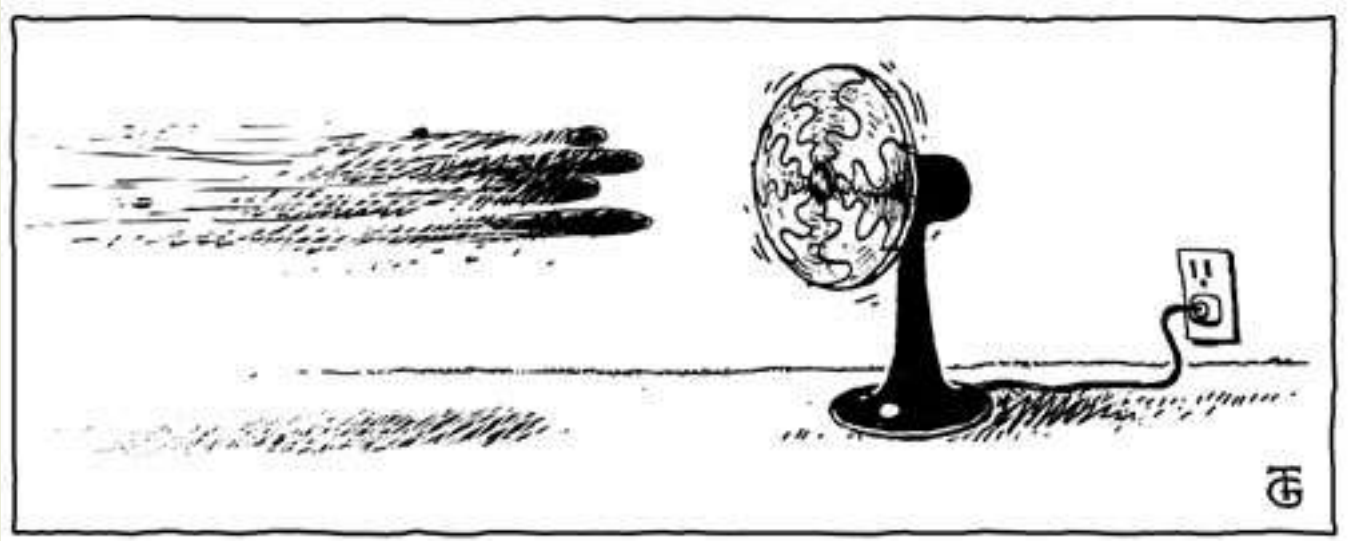

“Human beings and the natural world are on a collision course . . . No more than one or a few decades remain before the chance to avert the threats we now confront will be lost and the prospects for humanity immeasurably diminished.”

1600 Senior Scientists from 71 countries, including half of all Nobel Prize winners, November 18, 1992
World Scientists Warning to Humanity

There is a disturbing theory about the human species that has begun to take on an alarming level of reality. It seems that the behavior of the human race is displaying uncanny parallels to the behavior of pathogenic, or disease-causing, organisms.

When viewed at the next quantum level of perspective, from which the Earth is seen as an organism and humans are seen as microorganisms, the human species looks like a menace to the planet. In fact, the human race is looking a lot like a disease-causing pathogen, which is an organism excessively multiplying, consuming, and producing harmful waste, with no regard for the health and well-being of its host — in this case, planet Earth.

Pathogenic organisms are a nasty quirk of nature, it seems, although they do have their constructive

purposes, namely killing off the weak and infirm and ensuring the survival of only the fittest. They do this by overwhelming their hosts, by essentially sucking the vitality out of them and leaving poisonous wastes in their wake. Pathogens do not give a damn about their host organisms, and they often kill them outright.

This may seem a silly way for a species to maintain its own existence — after all, if you kill the host upon which you feed and upon which your life depends, then you must also die. But pathogens have evolved a special survival tactic that allows them to carry on the existence of their own species even after their host has died. They simply travel to another host, sending out envoys to seek out and infect other organisms even as their main pathogenic population succumbs along with their original host. A man dying of tuberculosis coughs on his deathbed, an act instigated by the infecting pathogen, ensuring that the disease has a chance to spread to others. A child defecates on the dirt outside her home, unwittingly satisfying the needs of the parasites inhabiting her intestines, which require time in the soil as part of their life cycle. A person stricken with cholera defecates in an outhouse which leaches tainted water into the ground, contaminating the village well-water and allowing the disease to spread to other unsuspecting villagers.

In the case of pathogenic organisms that kill their host, the behavior is predictable: multiply without regard for any limits to growth, consume as if there were no tomorrow, and excrete waste products that grievously harm the host. When this is translated into human terms, it rings with a disquieting familiarity, especially as we relentlessly equate human success with growth, consumption, material wealth, and profit.

Suppose we humans are, in fact, exhibiting disease behavior: we're multiplying without regard for limits, consuming natural resources as if there were no tomorrow, and producing waste products that are distressing the planet upon which our very existence depends. Well, there are two factors which we, as a species, are not taking into consideration. First is the survival tactic of pathogens, which requires additional hosts to infect. We do not have the luxury of that option, at least not yet. If we succeed at continuing our dangerous behavior, we also succeed in marching straight toward our own demise. In the process, we can also drag many other species down with us, a dreadful syndrome that is already underway. This is evident by the threat of extinction that hangs, like the sword of Damocles, over an alarming number of the Earth's species.

Second, however, there is one remaining consideration: infected host organisms fight back. As humans become an increasing menace, can the Earth try to defend itself? Absolutely, and in several ways. Number one is climate change, also known as global warming. When a disease organism infects a human

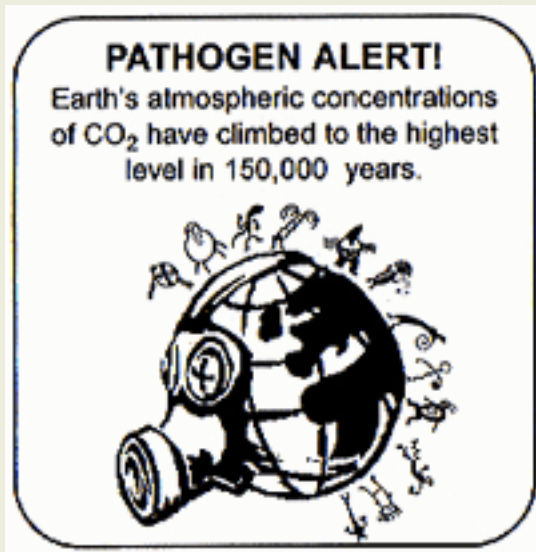

being, for example, one of the defense mechanisms our body deploys is the elevation of its own temperature. This rise in temperature not only inhibits the growth of the infecting pathogen, but also greatly enhances the disease fighting capability within the body. Global warming may be the Earth's way of inducing a fever — as a reaction to human pollution of the atmosphere and human over-consumption of fossil fuels. Sound ludicrous? Don't laugh — read on.

When the internal human body temperature rises, the microclimate of the body changes, allowing for the sudden and rapid proliferation of antibodies, T-cells, white blood cells, and other defenders against disease. As the *global* climate changes, and as the natural environment chokes with pollution, we humans do

have an idea of what sort of organisms nature can and will suddenly unleash to confront us. They're already beginning to show themselves as insect pest population booms, as well as new strains of deadly bacteria, viruses, and algae particularly toxic to humans.

So Earth's temperature slowly and inexorably rises, and, despite the potentially perilous consequences, humans try to ignore it. Global carbon emissions from fossil fuels are expected to reach nine billion tons per year by 2010,¹ and are expected to raise the Earth's temperature by two to six degrees Fahrenheit in the next century.² The Earth's temperature in 1998 was the highest ever recorded and exhibited the largest annual increase, setting "*a new record by a wide margin,*" according to NASA scientists.³ The 15 warmest years on record have occurred since 1980.⁴ The highest ever sea temperature in the North Atlantic was recorded in 1995, the same year that twice the normal number of tropical storms occurred. Today, ecologists are shocked to see large portions of Antarctica melting, breaking off, and falling into the Southern Sea.⁵ All the while, spokespersons for the fossil fuels industry, the largest economic enterprise in human history, dismiss the frightening evidence as merely environmentalist scare tactics, unsubstantiated by valid scientific proof.

As the planet's temperature rises, it gains a momentum that cannot be stopped, no matter how desperate or repentant we humans may eventually become. The Earth's "fever," like a spinning flywheel, will only subside in *its* own time. With global warming and climate change, we may have created a Frankenstein's monster of astronomical proportions. Unless, of course, we are pathogenic organisms. If so, then we really don't care, do we?

"A great change in our stewardship of the Earth and life on it is required, if vast human misery is to be avoided and our global home on this planet is not to be irretrievably mutilated."

World Scientists Warning to Humanity

Pathogens can often dwell for quite some time within the host organism without causing disease symptoms. Then something happens to spark their growth — they gain a sudden foothold and begin proliferating rapidly. It is at this point that disease effects begin to undeniably show themselves.

Humans began to *strongly* show their pathogenic potential toward the planet during the 1950s, ravenously devouring natural resources and discarding waste into the environment with utter carelessness. Since then, for example, our fish catch has increased by a factor of five, paper consumption by a factor of six, grain consumption tripled, fossil fuel burning quadrupled and atmospheric concentrations of CO₂ have reached the highest level in 150,000 years.⁶

Human consumption can be roughly measured by our output of material goods. Since 1950, the global output of human goods and services grew sixfold. Between 1990 to 1997, human global output grew as much as it did from the beginning of civilization until 1950. In fact, the global economy grew more in 1997 alone than during the entire 17th century.⁷

Now, at the end of the 20th century, our consumptive and wasteful lifestyles have painted a critical global picture. Almost half of the world's forests are gone. Between 1980 and 1995, we lost areas of forestland larger than the area of Mexico, and we are still losing forests at a rate of 16 million hectares a year.⁸ Water tables are falling on every continent from one to three meters per year. Fisheries are collapsing, farmland is eroding, rivers are drying, wetlands are disappearing, and species are becoming extinct.⁹ Furthermore, the human population is now increasing by 80 million people each year (roughly the population of ten Swedens). Such population growth virtually guarantees increased consumption as well as increased waste with each passing year.¹⁰

The damage of human over-consumption shows itself in other ways. Today, half of the coastlines and nearly 60% of the coral reefs on the planet are threatened with overdevelopment, pollution, and overfishing. Although almost no species of ocean fish was overexploited in 1950, now nearly 70% of fish species are either fully exploited or overexploited by humans.¹¹ Oceans and other bodies of water have long been used as dumps by the human species. For example, since 1950, mercury contamination has increased by a factor of five in the Baltic Sea. In the Black Sea, 85% of the marine species have disappeared.¹²

What about extinctions? The natural background rate of extinctions is estimated to be about one to ten species per year. Currently, it's estimated that we're instead losing *1,000 species per year*. More than 10% of all bird species, 25% of all mammals, and 50% of all primates are threatened with extinction. Freshwater fish now face a 37% extinction rate in America, 42% in Europe, and 67% in South Africa.¹³

Plant life is not immune to the forces of destruction that are threatening so many species either. Of 242,000 plant species surveyed by the World Conservation Union in 1997, one out of every eight (33,000

species) was threatened with extinction.¹⁴

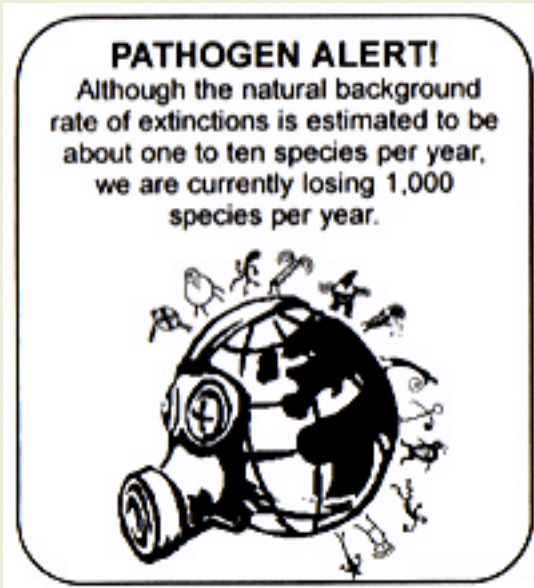

What would drive a species to damage its life support system in this way? Why would we humans disregard our host organism, the Earth, as if we were nothing more than pathogens intent upon its destruction? One answer, as we have seen, is consumption. Somewhere along the line we learned to embrace the idea that more is better, measuring success with the yardstick of material wealth. Some startling statistics bear this out: the 225 richest people in the world (0.000003% of the world's population) have as much acquired wealth as the poorest *half* of the entire human race, while the wealth of the world's three richest people is equivalent to the total output of the poorest 48 countries. We in the United States certainly can raise our hands and be counted when it comes to consumption — our intake of energy, grain, and

materials is the highest on the planet. We Americans can admit to using three tons of materials per month, each of us, and that's not counting food and fuel. Despite the fact that we are only 1/20 of the globe's population, we use 1/3 of the globe's resources. To sustain the entire world at this level of consumption would require no less than three planet Earths.¹⁵

“There is an exceptional degree of agreement within the scientific community that natural systems can no longer absorb the burden of current human practices.”

World Scientists Warning to Humanity

Wanton consumption breeds wanton wastefulness. Since the 1950s, more than 750 million tons of toxic chemical wastes have been dumped into the environment.¹⁶ By the end of the 1980s, production of human-made synthetic organic chemicals linked to cancer had exceeded 200 billion pounds per year, *a hundred-fold increase in only two generations.*¹⁷ By 1992, in the US alone, over 435 billion pounds of carbon-based synthetic chemicals were being produced. In 1994, well over a million tons of toxic chemicals were released into the ¹⁸ environment. Of these, 177 million pounds were known or suspected carcinogens.¹⁹

There are now about 75,000 chemicals in commercial use, and 3,750 to 7,500 are estimated to be carcinogenic (cancer-causing) to humans. That means that one out of every ten commercial chemicals may be cancer-causing — chemicals dispensed into your home via such common household items as aerosols, air fresheners, deodorizers, furniture polish, or the lumber used in the construction of your picnic table.

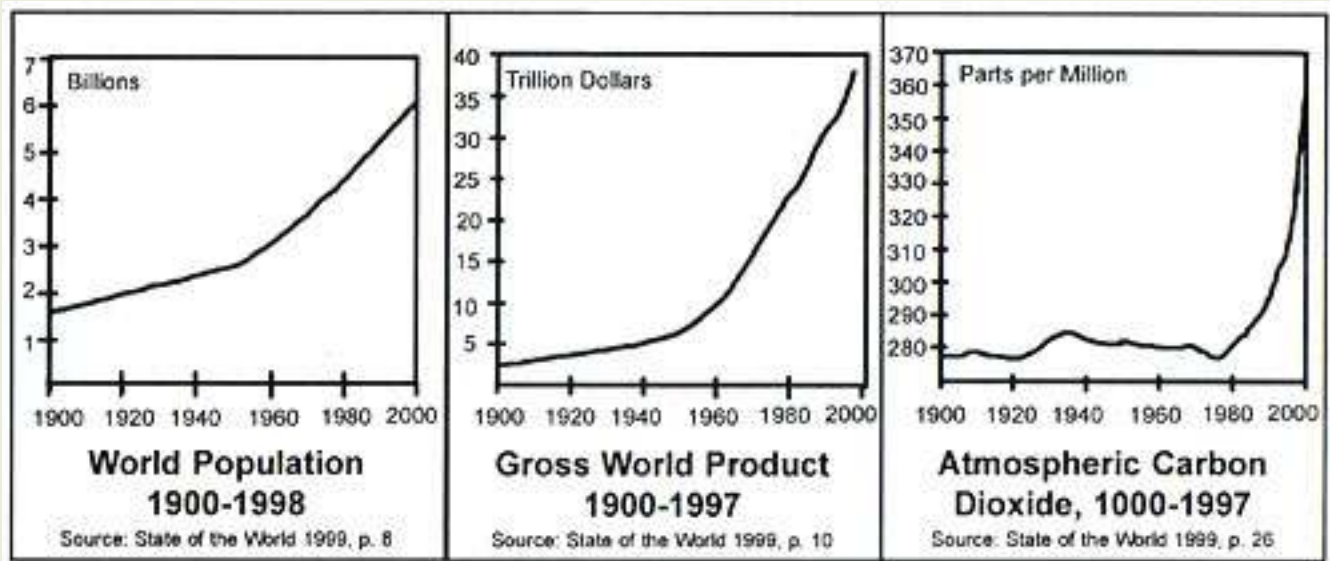

Toxic chemicals have been carelessly dumped into the environment since their creation. Forty thousand of the most notorious dump sites and hazardous waste landfills have been termed Superfund sites. Of these, there are 1,231 “priority” sites, with 40 million people (one in every six Americans) living within four miles of one.²⁰

Today, as a result, 40% of Americans can expect to contract cancer in their lifetimes. I can think of quite a few people, personal friends, who have contracted cancer in the past few years. Marcia, an artist in her mid-forties, got breast cancer a couple years ago and had to have part of one breast removed. Kristin, a school teacher in her mid-forties, and a lifetime organic gardener, also contracted breast cancer last year. Nina (mid-forties) got breast cancer a few years ago and now she has no breasts at all. Kaye (mid-forties), a healthy, Bach Flower Remedy practitioner and natural food advocate, suddenly came down with breast cancer and died. She left several beautiful daughters behind. Sandy, another apparently healthy, slender school teacher in her forties, got cancer of the uterus and had it removed. She never had any children. My mother had lung cancer. Two of my aunts died of cancer. Several of my friend’s fathers have died of cancer, as well as several of my father’s friends. Other friends or their parents have had bouts with cancer, but survived. Some of these were people who lived healthy lifestyles, ate nutritious food, and were active. They still developed cancer. But then, so do animals in the wild, so do fish and sea mammals. Lifestyle seems to have little effect on whether one comes down with the disease. Why? Because there is no escape from the cancer-causing chemicals that now pervade our environment and enter our bodies through the food we eat, the air we breathe, and the water we drink. Even household pets are not immune.

The World Health Organization has concluded that at least 80% of all cancer is attributed to environmental influences. One glaring example of this lies in the fact that industrialized countries have a lot more cancers than countries with little or no industry. Breast cancer rates are thirty times higher in the United States than in parts of Africa, for example. Childhood cancers have risen by one third since 1950, and now one in every four hundred Americans can expect to develop cancer before the age of fifteen. Between 1950 and 1991, incidences of all types of cancer combined have risen 49.3% in the United

States. Cancer is now the second leading cause of death overall, and the leading cause of death among Americans between the ages of 35 to 64. Furthermore, the US EPA projects that tens of thousands of additional fatal skin cancers will result from the ozone depletion that has already occurred over North America.²¹

Cancer is not the only issue associated with the synthetic organic chemicals that we humans have created and have carelessly allowed to pollute the environment. Disturbing new evidence indicates that some of these pollutants mimic natural hormones and can wreak havoc with the endocrine (hormone) systems of many animals, including humans. Male fish are being found with female egg sacs, male alligators with shriveled penises, and *human* male sperm counts are plummeting. Some of these common organic chemical pollutants mimic estrogen, a powerful natural hormone governing the female reproductive system, an excess of which has been linked to cancer. Other chemical pollutants interfere with testosterone, the male sex hormone, or with thyroid metabolism. These chemical pollutants lodge in animal fat cells, traveling up the food chain to concentrate in higher animals — like us. They are becoming increasingly concentrated in human mother's milk, and they cross the placental barrier to enter developing fetuses. It's a well-documented fact that synthetic organic chemical pollutants have traveled far enough to pervade every corner of the world — you may have heard some of their names: dioxin, PCBs, DDT, 2,4-D. *The average person can now expect to find at least 250 of these chemical contaminants in his or her body fat.*²²

Are cancer and endocrine disruption two of Mother Nature's defense mechanisms against organisms that have rudely gone awry? Are they not-so-subtle ways nature tells us that we're doing something wrong? Perhaps, and unfortunately the victims are often the innocent ones who bear no responsibility for the diseased state of the environment.

Our environmental misdeeds may be sowing the seeds of our own destruction in other ways as well. Damaging environmental changes seem to be contributing to the emergence of new toxic organisms, as well as the proliferation of old menaces such as malaria. Fifty new diseases have emerged since 1950, including Ebola, Lyme's Disease, Hantavirus, and HIV.²³ The World Health Organization reports that AIDS (HIV virus) is approaching epidemic proportions in several countries in Africa, and is spreading to India and China.²⁴ Researchers warn of the epidemic potential of the malarial mosquito population should global warming continue.²⁵ Others report epidemic levels of coastal algal blooms, some of which are highly toxic to humans as well as fish, and are directly linked to excessive human pollution.²⁶ Are these disease organisms some of nature's defense mechanisms, emerging in order to attack the human race? Although this is a chilling thought, it's not so chilling as the theory that this is just the beginning of the appearance of new diseases targeting the human race, and that future viruses may be as deadly as the plague and transmitted as easily as is the common cold.

“In effect, we are behaving as if we have no children, as though there will not be a next generation.”

Lester R. Brown

Some would say that it looks like our environment is going to hell in a handbasket. Others would

postulate that the human race is going along with it. Yet there are still those who would scoff at the idea that a tiny organism such as humanity could affect such an ancient and immense being as Mother Earth. This is a ludicrous concept, they argue; the very idea that the human species can be powerful enough to inflict illness on a planetary being is nothing more than egotism. Perhaps. After all, where is there any evidence that a planet can get sick and die? Where could we ever witness a planet that had once possibly teemed with life, where rivers flowed on its surface but long since dried up? Well, how about Mars?

What did happen to Mars, anyway? Our next door neighbor, the Red Planet, apparently was once covered with flowing rivers. What happened to them? Rivers suggest an atmosphere. Where is it? Was Mars once a vital, thriving planet? If so, why does it now appear dead? Could a lifeform on its surface have proliferated so abundantly, so profligately, and so recklessly that it deleteriously altered the planet's atmosphere, thereby knocking it off-kilter, and, in time, killing it? Is that what's happening to our own planet? Is it our legacy in this solar system to leave behind another dead rock to revolve around the sun? Or will we simply destroy ourselves while the Earth, stronger than her Martian brother, overcomes our infection and survives to flourish another billion years?

The answer, if I may wildly speculate, is neither — we will destroy neither the Earth nor ourselves. Instead, we will learn to live in a symbiotic relationship with our planet. To put it simply, the human species has reached a fork in the road of its evolution. We can continue to follow the way of disease-causing pathogens, or we can chart a new course as dependent and respectful inhabitants. The former requires only an egocentric lack of concern for anything but ourselves, living as if there were no tomorrow, as if there will be no future human generations. The latter, on the other hand, requires an awareness of ourselves as a *dependent* part of a Greater Being. This may require a hefty dose of humility, which we can either muster up ourselves, or wait until it's meted out to us, however tragically, by the greater world around us. Either way, we have to collectively make a decision, and the time is running out.

Fortunately, many competent people are already aware of and working on the problems touched upon in this chapter. Each of these problems is a piece to a puzzle, and each of them, when addressed individually, adds up to an overall solution. Like ants, we each work away at our particular areas of concern, doing our tiny bit to be a part of the solution to these problems, whether they be toxic waste, water pollution, global warming, cancer, or species extinctions.

It is ironic, however, that we humans have consistently ignored one problem that is very near to each of us — one waste issue that all of us contribute to each and every day — an environmental problem that has stalked our species from our genesis, and which will accompany us to our extinction. Perhaps one reason we have taken such a head-in-the-sand approach to the recycling of human *excrement* is because we can't even talk about it. If there is one thing that the human consumer culture refuses to deal with constructively, it's body excretions. This is the taboo topic, the unthinkable issue. It's also the one we are about to dive headlong into. For *waste* is not found in nature — it's strictly a human concept, a result of our own ignorance. It's up to us humans to unlock the secret to its elimination. Nature herself provides us with the key, and she has held it out to us for many thousands of years.

Source: The Humanure Handbook. Jenkins Publishing, PO Box 607, Grove City, PA 16127. To order, phone: 1-800-639-4099.

<http://www.jenkinspublishing.com/>

MENU: [HOME](#) » [Reconstruction](#) » [Recovery](#) » [Renewal](#) » [Survival](#) » [Humanure Content](#)

WASTE NOT WANT NOT



“WASTE: . . . Spoil or destruction, done or permitted, to lands, houses, gardens, trees, or other corporeal hereditaments, by the tenant thereof, to the prejudice of the heir, or of him in reversion or remainder . . . Any unlawful act or omission of duty on the part of the tenant which results in permanent injury to the inheritance . . .”

Black’s Law Dictionary

America is not only a land of industry and commerce, it’s also a land of consumption and waste, producing between 12 and 14 *billion* tons of waste annually. Approximately 210 million tons of that total constitutes our annual production of Municipal Solid Waste (MSW), which is the trash each of us personally throws “out” every day.¹

Much of our waste consists of *organic* material including food residues, municipal leaves, yard materials, agricultural residues, and human and livestock manures, all of which should be returned to the soil from which they originated. These organic materials are very valuable agriculturally, a fact well known among organic gardeners and farmers.

What does “organic” mean? The answer is interesting, as there are two opposing sides to this issue. Organic farmers and gardeners contend the word “organic” means that synthetic chemicals are not used

in farming or gardening processes. Chemists chuckle at this interpretation of the word, because in chemistry, “organic” is defined simply as any molecule containing carbon atoms. Many synthetic chemicals are therefore considered “organic” by the chemists of the world, simply because they contain carbon. When a chemist really wants to irk an organic gardener, he simply argues that his synthetic organic compounds (pesticides, for example) are “organic” by definition, and that his chemical garden therefore qualifies as “organic” as well. Technically, both sides are correct, although there is a huge distinction that must be taken into consideration.

Carbon is the basic building block of life. When the plant life of millions of years ago became extinct and settled into the earth, it was transformed into “fossil fuels” such as coal, oil, and gas, leaving plenty of carbon embedded in these fuels. These ancient resources have become the basic stock for the petro-chemical industry, which manufactures many synthetic “organic” (i.e., carbon-bearing) chemicals, including the 2.23 billion pounds of synthetic organic pesticides Americans use each year.² Technically, these chemicals *are* “organic” because they’re derived from what was once plant life.

The ancient chemical stocks are altered and synthesized in laboratories to be *similar* to the physiological chemicals of today, which is why they work so well at killing insects and plants — they can enter their living systems and wreak havoc. Many synthetic organic chemicals make their way into human bodies as well, accumulating in the fat cells and fooling the body into thinking they belong there. They don’t.

Unfortunately, synthetic organic chemicals can mimic natural human hormones, thereby dangerously interfering with the body’s normal functioning. They can also damage human chromosomes, and cause cancer and numerous other diseases. Although technically “organic” because they contain carbon and are derived from ancient life, synthetic organic chemicals have become an environmental disaster due to their persistence (they hang around a long time in the environment), their pervasiveness (they have spread all over the world), and their ability to interfere with the normal functioning of the bodies of many animals (not just humans). For example, human mother’s milk has consistently shown contamination from synthetic organic chemicals since 1951,³ and the incidence of human breast cancer has risen dramatically since then.

In a nutshell, that is why organic gardeners and farmers won’t touch synthetic organic chemicals with a ten foot tomato stake. Instead, they use only organic materials agriculturally that are from the *current* era (i.e., from things that were recently alive, such as trees, lawns, and animals, although peat may be an exception). Therein lies the difference in definitions of the word “organic.” To a chemist, any molecule that contains carbon is organic, no matter how altered it is from its natural state, but to an organic agriculturist, organic material must be benign and beneficial, not toxic and cancer-causing.

WASTE desperdicios مہملات ゴミ袋 垃圾袋 कृड़ा - कम्कट

ELIMINATING WASTE

“It is difficult to overstate the urgency of reversing the trends of environmental deterioration.”

Feces and urine are examples of natural, beneficial, organic materials excreted by the bodies of animals after completing their digestive processes. They are only “waste” when we discard them. When recycled they are resources, and are often referred to as manures, but never as waste, by the people who do the recycling.

We do not recycle waste. It’s a common misuse of semantics to say that waste is, can be, or should be recycled. Resource materials are recycled, but waste is never recycled. That’s why it’s called “waste.” Waste is any material with no inherent value that is discarded and has no further use. We humans have been so wasteful for so long that the concept of waste *elimination* is new to us. Yet, it is an important concept that must become imbued into human consciousness.

When a potato is peeled, the peels aren’t kitchen waste — they’re still potato peels. When they’re collected for recycling as a resource, no waste is produced. Those of you who separate your organic material for recycling are creating no organic waste — a small but highly satisfying achievement.

Many people, especially compost, municipal, and academic professionals, nevertheless adamantly insist upon referring to these recycled materials as “waste.” This is called the “waste mentality.” Many of the people who are developing municipal composting programs came from the waste management field, a field in which refuse has always been waste. Today, however, refuse is increasingly becoming recognized as the resource it always was. Those of us who recycle are eliminating waste, and the term “waste” should not be associated with us. The use of the term “waste” to describe recycled materials is an unpleasant semantic habit that must be abandoned. If we’re eliminating waste, we should talk like it, and be proud of it.

FUN FACTS

Waste Not — Want Not

America is a land of waste. Of the top fifty municipal solid waste producers in the world, America is fifth in line, being outranked only by Australia, New Zealand, France, and Canada. Although the US population increased by 18% between 1970 and 1986, its trash output increased by 25% during that time period, indicating that as time passes, we become more wasteful as a nation. Today, every individual in America produces about four pounds of trash daily, which will add up to 216 million tons per year by the year 2000, almost ten percent more than in 1988. If this sounds like a lot, sit down for a minute: municipal solid waste (the 210 million tons per year just mentioned) makes up only one percent of the total solid waste created annually in the US. The rest

comes from industry, mining, utilities, and other sources.



Source: Hammond, A., et al. (Eds.) (1993). 1993 Information Please Environmental Almanac.

Compiled by World Resources Institute.
Houghton Mifflin Co. New York. (pp.50-51 and 339).

Following the semantics of the waste mentality, one would refer to leaves in the autumn as “tree waste,” because they are no longer needed by the tree and are discarded. Yet, when one walks into the forest, where does one see waste? The answer is “nowhere,” because the organic material is recycled naturally, and no waste is created. Ironically, leaves and grass clippings are referred to as “yard waste” by some compost professionals, another example of the persistent waste mentality plaguing our culture. Many of

us humans are trying to mimic nature by eliminating waste *as well* as the mentality that accompanies it, and many of us are succeeding. Hopefully the composting professionals who are stuck in the waste mindset will eventually jump on the “resource recycling” bandwagon. They should, after all, because compost professionals are the front line of an emerging army of people intent upon eliminating waste. Our species has created the concept of waste. It is up to us to avoid it altogether.

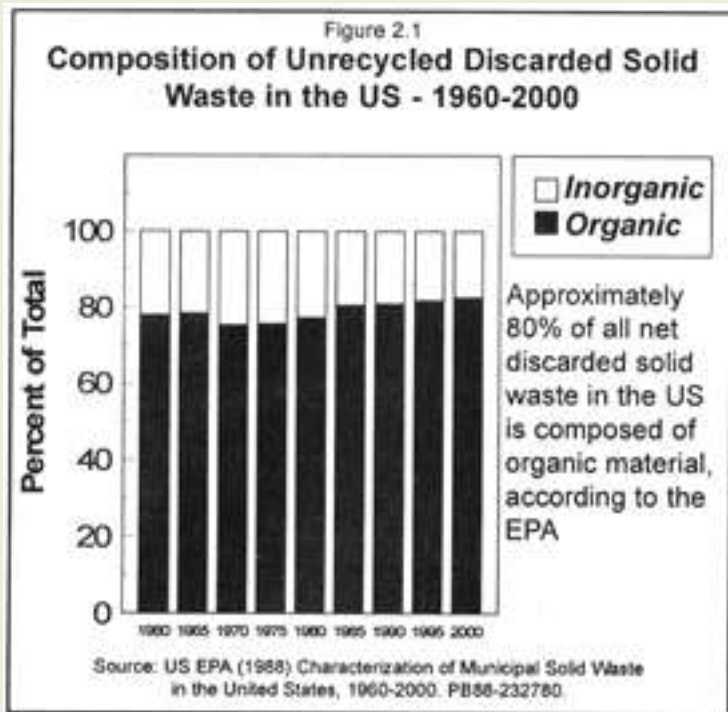

For many years in the United States, when people mowed their lawns, they raked the cut grass, stuffed it into large plastic garbage bags, and set it out on the curbside to be picked up by a garbage truck. The grass was then hauled away and buried in landfills along with the deodorant cans, disposable diapers,

magazines, and the host of other objects of America’s throw-away obsession. Having lived in the country for many years and having had a compost pile since I was first able to dig the earth, I was not aware of this cult-like fanaticism among American suburbanites.

Then one day I visited some friends in the small town near where I live. They were a young couple; he had a Ph.D. and was a professor at the local university and his wife was just finishing her Ph.D.

dissertation. They had just mowed their lawn and had the green bags of grass clippings sitting out along the curb, open, with the contents plainly visible. I looked at the bags, but the sight of *grass clippings* being thrown out as if they were trash was so incongruous to me that, at first, it didn't register, until I did a double-take. "Why are you throwing out these grass clippings?" I asked incredulously.

"We've always done that."

"Why would you do that?"

"That's what you're supposed to do."

"Don't you have a compost pile, for heaven's sake?"

"What's a compost pile? Oh, you mean those big smelly heaps that rats get into? We don't have room for that."

"You can use the grass clippings for mulch," I suggested, as I glanced around their roomy garden, seeing lots of places for compost bins. "Look, see those roses over there? They would love these grass clippings spread around them."

"Nah, we'll just let the municipality take care of our yard waste (emphasis mine)."

At that moment, I realized my poor friends had been working so hard at becoming experts, that they didn't have time to learn about the value of grass clippings. I also suspected that our educational system has been rather remiss in its responsibilities by ignoring fundamental basics of life, such as the need for organic material recycling. After some gentle persuasion, I took the bags and spread the grass around the roses, creating a lovely green carpet, while explaining the benefits of mulch and the powerful soil nutrients resident in grass clippings. My friends watched nervously, but soon relaxed after they realized no one was going to get hurt and no rats were going to jump out at them. I think maybe they learned something valuable that day, but would certainly get no credit for it at their university.

I must give credit where credit is due, however. Many people have realized that the disposal of organic yard and garden material in landfills is unwise, and now, in the US, many states have completely banned the dumping of these materials into landfills. Some of the people who've been responsible for these policies were highly educated, yet they *still* managed to figure it out.

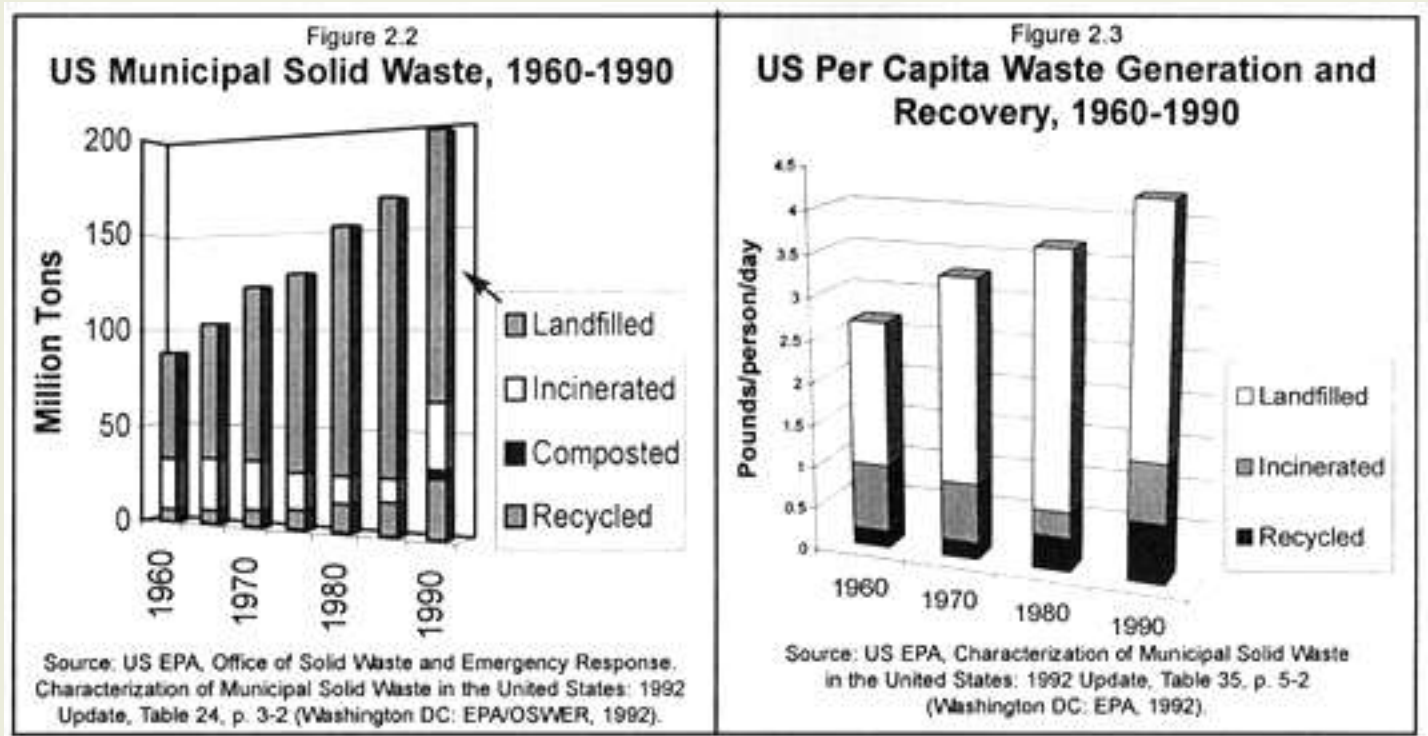

Regardless of the benefits or the hindrances of one's education, we still find no waste in nature. One organism's excrement is another's food — it's that simple. Everything is recycled through natural systems so waste doesn't exist. Humans create waste because we insist on ignoring the natural systems that we are dependent upon. We are so adept at doing so that we take waste for granted and have given the word a prominent place in our vocabulary. We have kitchen "waste," garden "waste," agricultural "waste," human "waste," municipal "waste," "biowaste," and on and on. Yet, our long-term survival as a species requires us to learn to live in harmony with our host planet. This also requires that we understand natural cycles and incorporate them into our day to day lives. In essence, this means that we humans must eliminate waste altogether. As we progressively eliminate waste from our living habits, we can also progressively eliminate the word "waste" from our vocabulary. We can start with the term "human waste."

"Human waste" is a term that has traditionally been used to refer only to human excrements, namely fecal material and urine, which are by-products of the human digestive system. When *discarded*, these materials are colloquially known as human *waste*. When *recycled* for agricultural purposes, however, they're known by various names, including night soil (when applied raw to fields in Asia) and human manure or *humanure*. Humanure is not waste — it is a valuable organic resource material rich in soil nutrients, in contrast to human *waste*, which is a dangerous discarded pollutant. Humanure originated from the soil and can be quite readily returned to the soil, especially if converted to humus through the composting process. Admittedly, humanure is not as benign and easy to work with as grass clippings, but when properly recycled, it makes a wonderful soil additive.

Human *waste* (*discarded* feces and urine), on the other hand, creates significant environmental problems, provides a route of transmission for disease, and deprives humanity of valuable soil fertility. It's also one of the primary ingredients in sewage, and is largely responsible for much of the world's water pollution.

A clear distinction must be drawn between humanure and sewage. Sewage can include waste from many sources (industries, hospitals, and garages, for example) as well as the host of contaminants that seep from these sources (industrial chemicals, heavy metals, oil, and grease, for example). Humanure is strictly human fecal material and urine.

What, in truth, *is* human waste? Human waste is cigarette butts, plastic six-pack rings, styrofoam clamshell burger boxes, deodorant cans, disposable diapers, worn out appliances, unrecycled pop bottles, wasted newspapers, junk car tires, spent batteries, most junk mail, nuclear contamination, food packaging, shrink wrap, toxic chemical dumps, exhaust emissions, the five billion gallons of drinking water we flush down our toilets every day, and the millions of tons of organic material discarded into the environment year after year after year.

Source: The Humanure Handbook. Jenkins Publishing, PO Box 607, Grove City, PA 16127. To order, phone: 1-800-639-4099.

<http://www.jenkinspublishing.com/>

MENU: [HOME](#) » [Reconstruction](#) » [Recovery](#) » [Renewal](#) » [Survival](#) » [Humanure Content](#)

MICROHUSBANDRY

Harnessing the Power of Microscopic Organisms

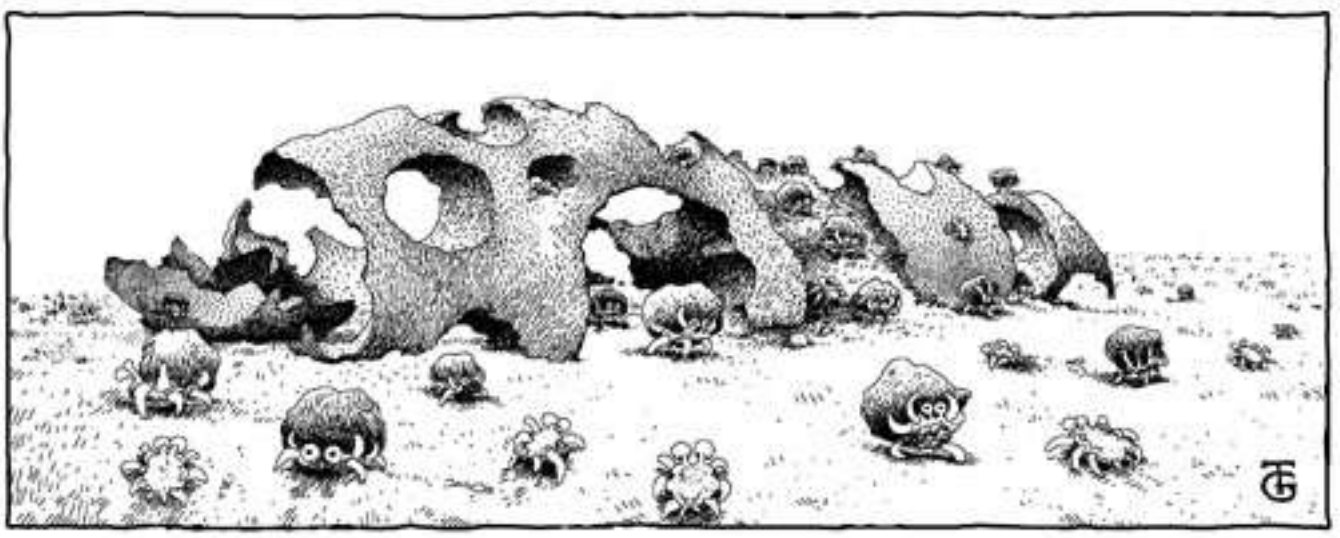

“Anyone starting out from scratch to plan a civilization would hardly have designed such a monster as our collective sewage system. Its existence gives additional point to the sometimes asked question, Is there any evidence of intelligent life on the planet Earth?”

G. R. Stewart

There are four general ways to deal with human excrement. The first is to *dispose of it* as a waste material. People do this by defecating in drinking water supplies, or in outhouses or latrines. Most of this waste ends up dumped, incinerated, buried in the ground, or discharged into waterways.

The second way to deal with human excrement is to *apply it raw to agricultural land*. This is popular in Asia where “night soil,” or raw human excrement, is spread on fields. Although this keeps the soil enriched, it also acts as a vector, or route of transmission, for disease organisms. In the words of Dr. J. W. Scharff, former chief health officer in Singapore, *“Though the vegetables thrive, the practice of putting human [manure] directly on the soil is dangerous to health. The heavy toll of sickness and death from various enteric diseases in China is well-known.”* The World Health Organization adds, *“Night soil is sometimes used as a fertilizer, in which case it presents great hazards by promoting the transmission of food-borne enteric [intestinal] disease, and hookworm.”* ¹ (It is interesting, incidentally, to note Dr. Scharff’s only alternative to the use of raw night soil: *“We have been inclined to regard the installation*

of a water-carried system as one of the final aims of civilization.”)² This book, therefore, is *not* about recycling night soil by raw applications to land, which is a practice that should be discouraged when sanitary alternatives, such as composting, are available.

The third way to deal with human excrement is to *slowly compost it over an extended period of time*. This is the way of most commercial composting toilets. Slow composting generally takes place at temperatures below that of the human body, which is 37°C or 98.6°F. This type of composting eliminates most disease organisms in a matter of months, and should eliminate all human pathogens eventually. Low temperature composting creates a useful soil additive that is at least safe for ornamental gardens, horticultural, or orchard use.

Thermophilic composting is the fourth way to deal with human excrement. This type of composting involves the cultivation of heat-loving (thermophilic) microorganisms in the composting process. Thermophilic microorganisms, such as bacteria and fungi, can create an environment in the compost which destroys disease organisms that can exist in humanure, converting humanure into a friendly, pleasant-smelling, humus safe for food gardens. Thermophilically composted humanure is *entirely different* from night soil. Perhaps it is better stated by the experts in the field: “*From a survey of the literature of night soil treatment, it can be clearly concluded that the only fail-safe night soil method which will assure effective and essentially total pathogen inactivation, including the most resistant helminths [intestinal worms] such as Ascaris [roundworm] eggs and all other bacterial and viral pathogens, is heat treatment to a temperature of 55° to 60°C for several hours.*”³ The experts are specifically referring to the heat of the *compost pile*.

Source: *The Humanure Handbook*. Jenkins Publishing, PO Box 607, Grove City, PA 16127. To order, phone: 1-800-639-4099.

<http://www.jenkinspublishing.com/>

MENU: [HOME](#) » [Reconstruction](#) » [Recovery](#) » [Renewal](#) » [Survival](#) » [Humanure Content](#)

DEEP SH*T

(*Philosophy and Speculation)



“From the Latin word humus for earth, true humility grounds the seeker in truth.”

Edward Hayes - Prayers for a Planetary Pilgrim
(Special thanks to Sister Barbara of Villa Maria, PA)

Composting humanure is an act of humility, and the practice of humility is an exercise that strengthens one’s spirit. The Earth provides us with life; it gives us our children, allows us to pursue our dreams. All of the beauty and joy that makes up our lives ultimately springs from her breasts to nurture and strengthen us. We suckle from her — and then we give back feces and urine — usually in the form of surface and water pollutants.

Shortly after the first edition of this book was published, I was invited to speak to a group of nuns at a convent. It was my first speaking invitation, and I still remember the phone call:

“Mr. Jenkins, we recently bought a copy of your book, *Humanure*, and we would like to have you speak at our convent.”

At this time, I was still doubtful that anyone was even interested in the topic of humanure composting, so I responded, “What about?”

“About the topic of your book.”

“Composting?”

“Yes, but specifically, *humanure* composting.” At this point I was somewhat speechless. I couldn’t understand exactly why a group of nuns would be interested in composting their own shit. Somehow I couldn’t imagine standing in front of a room full of nuns in habits, speaking about turds. But I kept the stammering to a minimum and accepted the invitation.

It was Earth Day, 1995. The presentation went well. After I spoke, the group showed slides of their gardens and compost piles, and then we toured the compost area and poked around in the worm compost boxes. A delightful lunch followed, during which time I asked them why they were interested in humanure, of all things.

“We are the Sisters of Humility,” they responded. *“The words ‘humble’ and ‘humus’ come from the same semantic root, which means ‘earth.’ We also think these words are related to the word ‘human.’ Therefore, as part of our vow of humility, we work with the earth. We make compost, as you’ve seen. And now we want to learn how to make compost from our toilet material. We’re thinking about buying a commercial composting toilet, but we want to learn more about the overall concepts first. That’s why we asked you to come here.”*

A light bulb went off in my head. Of course, composting is an act of humility. The people who care enough about the earth to recycle their personal by-products do so as an exercise in humility, and not because they’re going to get rich and famous for it. That makes them better people. Some people go to church on Sunday, others make compost. Still others do both. Others go to church on Sunday, then throw all their garbage out into the environment. The exercising of the human spirit can take many forms, and the simple act of cleaning up after oneself is one of them. Carelessly dumping waste out into the world is a self-centered act of arrogance.

Humanure composters can stand under the stars at night gazing at the heavens, and know that, when nature calls, their excretions will not foul the planet. Instead, those excretions are humbly collected, fed to microorganisms, and returned to the Earth as healing medicine for the soil. Although today’s religious leaders may scoff at anyone who does not kowtow to the men at the top of their hierarchy, humble composters can ignore the pressures of religious conformity, and instead hold a grain of pure spiritual truth in the palm of their hand.

Source: The Humanure Handbook. Jenkins Publishing, PO Box 607, Grove City, PA 16127. To order, phone: 1-800-639-4099.

<http://www.jenkinspublishing.com/>

MENU: [HOME](#) » [Reconstruction](#) » [Recovery](#) » [Renewal](#) » [Survival](#) » [Humanure Content](#)

A DAY IN THE LIFE OF A TURD

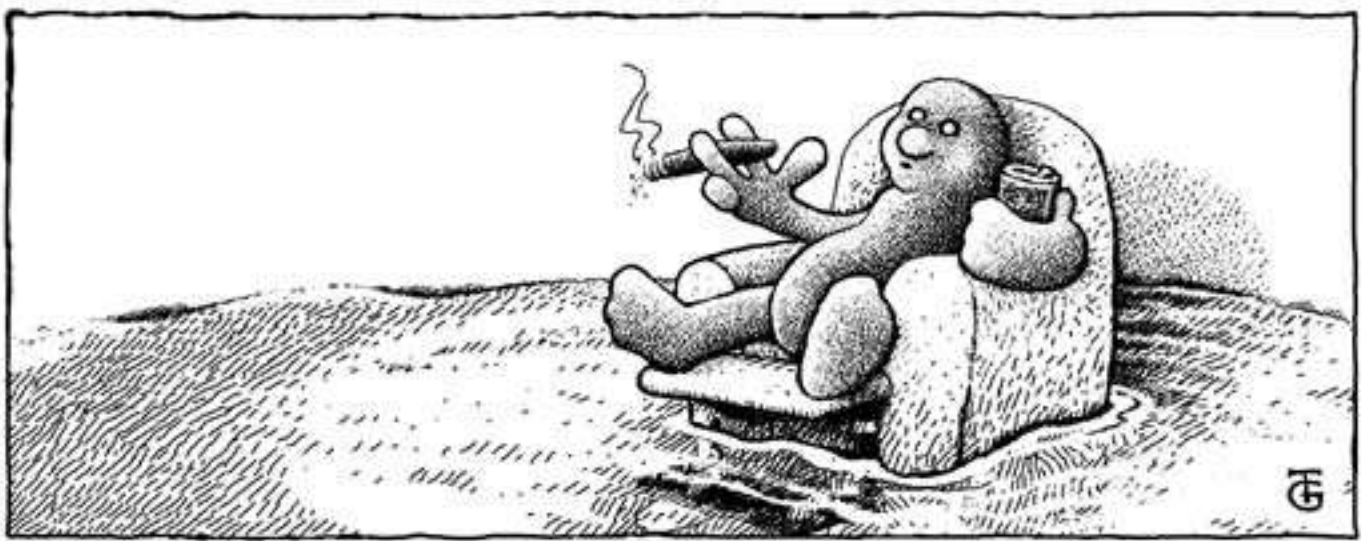

“If I urinated into a pitcher of drinking water and then proceeded to quench my thirst from the pitcher, I would undoubtedly be considered crazy. If I invented an expensive technology to put my urine and feces into my drinking water, and then invented another expensive (and undependable) technology to make the same water fit to drink, I might be thought even crazier. It is not inconceivable that some psychiatrist would ask me knowingly why I wanted to mess up my drinking water in the first place.”

Wendell Berry

When I was a kid, I listened to veterans talking about their stints in the Korean War. Usually after a beer or two, they’d turn their conversation to the “outhouses” used by the Koreans. They were amazed, even mystified about the fact that the Koreans tried to lure passersby to use their outhouses by making the toilets especially attractive. The idea of someone wanting someone else’s crap always brought out a loud guffaw from the vets. Only a groveling, impoverished, backward gink would stoop so low as to beg for a turd. Haw, Haw.

Perhaps this attitude sums up the attitudes of Americans. Humanure is a waste product, plain and simple. We have to get rid of it and that’s all there is to it. Only fools would think otherwise. One of the effects of this sort of attitude is that Americans don’t know and probably don’t care where their humanure goes after it emerges from their backsides, as long as they don’t have to deal with it.

MEXICAN BIOLOGICAL DIGESTER

Well, where it goes depends on the type of “waste disposal system” used. Let’s start with the simplest: the Mexican biological digester, also known as the stray dog. In India, this may be known as the stray pig (see Figure 5.1). I spent a few months in southern Mexico in the late 1970s in Quintana Roo on the Yucatan peninsula. There, toilets were not available; people simply used the sand dunes along the coast. No problem, though. One of the small, unkempt, and ubiquitous Mexican dogs would wait nearby with watering mouth until you’ve done your thing. Burying your excrement in that situation would have been an act of disrespect to the dog. No one wants sand in their food. A good, healthy, steaming turd at the crack of dawn on the Caribbean coast never lasted more than 60 seconds before it became a hot meal for a human’s best friend. Yum.

THE OLD-FASHIONED OUTHOUSE

Next up the ladder of sophistication is the old-fashioned outhouse, also known as the pit latrine (see Figures 5.2-5.5). Simply stated, one digs a hole and defecates in it, and then does so again and again until the hole fills up, after which it’s covered with dirt. It’s nice to have a small building (privy) over the hole to provide some privacy and to keep off the elements. However, the concept is simple: dig a hole and bury your excrement. Interestingly, this level of sophistication has not yet been surpassed in America. We still bury our excrement, in the form of sewage sludge, in landfill holes.

The first farmhouse I lived in during the mid-seventies had an outhouse behind it and no plumbing whatsoever. What I remember most about the outhouse is the smell, which could be described as quite undesirable, to say the least. The flies and wasps weren’t very inviting either, and of course the cold weather made the process of “going to the bathroom” uncomfortable. When the hole filled up, I simply dug another hole twenty feet away from the first and dragged the outhouse from one hole to the other. The dirt from the second hole was used to cover the first. The excrement was left in the ground, probably to contaminate groundwater. Of course, I didn’t know I might be contaminating anything because I had just graduated from college and was quite ignorant about practical matters. Therefore, I plead not guilty to environmental pollution on the grounds of a college education.

Outhouses create very real health, environmental, and aesthetic problems. The hole in the ground is accessible to flies and mosquitoes which can transmit disease over a wide area. The pits leak pollutants into the ground even in dry soil. And the smell — *hold your nose*.

SEPTIC SYSTEMS

Another step up the ladder one finds the septic tank, a common method of human waste disposal in rural and suburban areas of the United States. In this system the turd is deposited into a container of water, usually pure drinking water, and the whole works are flushed away (see Figures 5.6 and 5.7).

After the floating turd travels from the house inside a sewage pipe, it plops into a fairly large

underground storage tank, or septic tank, usually made of concrete and sometimes of fiberglass. In Pennsylvania (US), a 900 gallon tank is the minimum size allowed for a home with three or fewer bedrooms.¹ The heavier solids settle to the bottom of the tank and the liquids drain off into a leach field, which consists of an array of drain pipes situated below the ground surface allowing the liquid to seep out into the soil. The wastewater should be undergoing anaerobic decomposition while in the tank. When septic tanks fill up, they are pumped out and the waste material is supposed to be trucked to a sewage treatment plant (sometimes they're illegally dumped).

SAND MOUNDS

In the event of poorly drained soil, one with a high clay content or else low-lying, a standard leach field will not work very well, especially when the ground is already saturated with rain water or snow melt. One can't drain wastewater into soil that is saturated with water. That's when the *sand mound* sewage disposal system is employed. When the septic tank isn't draining properly, a pump will kick in and pump the effluent into a pile of sand and gravel above ground (although sometimes a pump isn't necessary and gravity does the job). A perforated pipeline in the pile of sand allows the effluent to drain down through the mound. Sand mounds are usually covered with soil and grass. In Pennsylvania, sand mounds must be at least one hundred feet downslope from a well or spring, fifty feet from a stream, and five feet from a property line.² According to local excavating contractors, sand mounds cost \$5,000 to \$12,000 to construct. They must be built to exact government specifications, and aren't usable until they pass an official inspection (see Figure 5.8).

GROUND WATER POLLUTION FROM SEPTIC SYSTEMS

We civilized humans started out by defecating into a hole in the ground (outhouse), then discovered we could float our turds out to the hole using water and never have to leave the house. However, one of the unfortunate problems with septic systems is, like outhouses, they pollute our groundwater.

There are currently 22 million septic system sites in the United States, serving one fourth to one third of the US population. They are leaching contaminants such as bacteria, viruses, nitrates, phosphates, chlorides, and organic compounds such as trichloroethylene into the environment. An EPA study of chemicals in septic tanks found toluene, methylene chloride, benzene, chloroform, and other volatile synthetic organic compounds related to home chemical use, many of them cancer-causing.³ Between 820 and 1,460 *billion* gallons of this contaminated water are discharged per year to our shallowest aquifers.⁴ In the US, septic tanks are reported as a source of ground water contamination more than any other source. Forty-six states cite septic systems as sources of groundwater pollution; nine of these reported them to be the primary source of groundwater contamination in their state (see Figures 5.9 and 5.10).⁵

The word "septic" comes from the Greek "septikos" which means "to make putrid." Today it still means "causing putrefaction," putrefaction being "the decomposition of organic matter resulting in the formation of foul-smelling products" (see Webster). Septic systems are not designed to destroy human pathogens that may be in the human waste that enters the septic tank. Instead, septic systems are

designed to collect human wastewater, settle out the solids, and anaerobically digest them to some extent, leaching the effluent into the ground. Therefore, septic systems can be highly pathogenic, allowing the transmission of disease-causing bacteria, viruses, protozoa, and intestinal parasites through the system.

One of the main concerns associated with septic systems is the problem of human population density. Too many septic systems in any given area will overload the soil's natural purification systems and allow large amounts of wastewater to contaminate the underlying watertable. A density of more than forty household septic systems per square mile will cause an area to become a likely target for subsurface contamination, according to the EPA.⁶

Toxic synthetic organic chemicals are commonly released into the environment from septic systems because people dump toxic chemicals down their drains. The chemicals are found in pesticides, paint and coating products, toilet cleaners, drain cleaners, disinfectants, laundry solvents, antifreeze, rust proofers, septic tank and cesspool cleaners, and many other cleaning solutions. In fact, over 400,000 gallons of septic tank cleaner liquids containing synthetic organic chemicals were used in one year by the residents of Long Island alone. Furthermore, some synthetic organic chemicals can corrode pipes, thereby causing heavy metals to enter septic systems.⁷

In many cases, people who have septic tanks are forced to connect to sewage lines when the lines are made available to them. A US Supreme Court case in 1992 reviewed a situation whereby town members in New Hampshire had been forced to connect to a sewage line that simply discharged untreated, raw sewage into the Connecticut River, and had done so for 57 years. Despite the crude method of sewage disposal, state law required properties within 100 feet of the town sewer system to connect to it from the time it was built in 1932. This barbaric sewage disposal system apparently continued to operate until 1989, when state and federal sewage treatment laws forced a stop to the dumping of raw sewage into the river.⁸

WASTEWATER TREATMENT PLANTS

“Over 90% of all sewage in third world countries is discharged completely untreated; in Latin America the figure is 98%.” Ecological Sanitation, p.2

There's still another step up the ladder of wastewater treatment sophistication: the wastewater treatment plant, or sewage plant. The wastewater treatment plant is like a huge, very sophisticated septic tank because it collects the waterborne excrement of large numbers of humans. Inevitably, when one defecates or urinates into water, one pollutes the water. In order to avoid environmental pollution, that “wastewater” must somehow be rendered fit to return to the environment. The wastewater entering the treatment plant is 99% liquid because all sink water, bath water and everything else that goes down one's drain ends up at the plant too, which is why it's called a *water* treatment plant. In some cases, storm water runoff also enters wastewater treatment plants via *combined sewers*. Industries, hospitals, gas stations, and any place with a drain add to the contaminant blend in the wastewater stream.

Many modern wastewater plants use a process of activated sludge treatment whereby oxygen is vigorously bubbled through the wastewater in order to activate microbial digestion of the solids. This aeration stage is combined with a settling stage that allows the solids to be removed (see Figures 5.11 and 5.12). The removed solids (sludge) are either used to reinoculate the incoming wastewater, or they're dewatered to the consistency of a dry mud and buried in landfills. Sometimes the sludge is applied to agricultural land, and now, sometimes, it's composted. The microbes that digest the sludge consist of bacteria, fungi, protozoa, rotifers, and nematodes.⁹ US sewage treatment plants generated about 7.6 million dry tons of sludge in 1989.¹⁰ New York City alone produces 143,810 dry tons of sludge every year.¹¹ In 1993, the amount of sewage sludge produced annually in the US was 110-150 million wet metric tons. The water left behind is treated (usually with chlorine) and discharged into a stream, river, or other body of water. Sewage treatment water releases to surface water in the United States in 1985 amounted to nearly *31 billion gallons per day*.¹² Incidentally, the amount of toilet paper used (1991) to send all this waste to the sewers was 2.3 million tons.¹³

WASTE STABILIZATION PONDS

Perhaps one of the most ancient wastewater treatment methods known to humans are waste stabilization ponds, also known as oxidation ponds or lagoons (see Figure 5.13). They're often found in small rural areas where land is available and cheap. Such ponds tend to be only a meter to a meter and a half deep, but vary in size and depth, and may be three or more meters deep.¹⁴ They utilize natural processes to "treat" waste materials, relying on algae, bacteria, and zooplankton to reduce the organic content of the wastewater. A "healthy" lagoon will appear green in color because of the dense algae population. These lagoons require about one acre for every 200 people served. Mechanically aerated lagoons only need 1/3 to 1/10 the land that unaerated stabilization ponds require. It's a good idea to have several smaller lagoons in series rather than one big one; normally, a minimum of three "cells" are used. Sludge collects in the bottom of the lagoons, and may have to be removed every five or ten years and disposed of in an approved manner.¹⁵

CHLORINE

Wastewater leaving wastewater treatment plants is often treated with chlorine before being released into the environment. Therefore, besides contaminating water resources with feces, the act of defecating into water often ultimately contributes to the contamination of water resources with *chlorine*.

Used since the early 1900s, chlorine is one of the most widely produced industrial chemicals. About 10 million metric tons are manufactured in the US each year — \$72 billion worth.¹⁶ Annually, approximately 5%, or 1.2 billion pounds of the chlorine manufactured is used for wastewater treatment and drinking water "purification." The lethal liquid or green gas is mixed with the wastewater from sewage treatment plants in order to kill disease-causing microorganisms before the water is discharged into streams, lakes, rivers, and seas. It is also added to household drinking water via household and municipal water treatment systems. Chlorine kills microorganisms by damaging their cell membranes, which leads to a leakage of their proteins, RNA, and DNA.¹⁷

Chlorine (Cl₂) doesn't exist in nature. It's a potent poison which reacts with water to produce a strongly oxidizing solution that can damage the moist tissue lining of the human respiratory tract. Ten to twenty parts per million (ppm) of chlorine gas in air rapidly irritates the respiratory tract; even brief exposure at levels of 1,000 ppm (one part in a thousand) can be fatal.¹⁸ Chlorine also kills fish, and reports of fish kills caused chlorine to come under the scrutiny of scientists in the 1970s.

The fact that harmful compounds are formed as *by-products* of chlorine use also raises concern. In 1976, the US Environmental Protection Agency (EPA) reported that chlorine use not only poisoned fish, but could also cause the formation of cancer-causing compounds such as chloroform. Some known effects of chlorine-based pollutants on animal life include memory problems, stunted growth and cancer in humans; reproductive problems in minks and otters; reproductive problems, hatching problems, and death in lake trout; and embryo abnormalities and death in snapping turtles.¹⁹

In a national study of 6,400 municipal wastewater treatment plants, the EPA estimated that two thirds of them used too much chlorine, exerting lethal effects at all levels of the aquatic food chain. Chlorine damages the gills of fish, inhibiting their ability to absorb oxygen. It also can cause behavioral changes in fish, thereby affecting migration and reproduction. Chlorine in streams can create chemical "dams" which prevent the free movement of some migratory fish. Fortunately, since 1984, there has been a 98% reduction in the use of chlorine by sewage treatment plants, although chlorine use continues to be a widespread problem because a lot of wastewater plants are still discharging it into small receiving waters.²⁰

Another controversy associated with chlorine use involves "dioxin," which is a common term for a large number of chlorinated chemicals that are classified as possible human carcinogens by the EPA. It's known that dioxins cause cancer in laboratory animals, but their effects on humans are still being debated. Dioxins, by-products of the chemical manufacturing industry, are concentrated up through the food chain where they're deposited in human fat tissues. A key ingredient in the formation of dioxin is chlorine, and indications are that an increase in the use of chlorine results in a corresponding increase in the dioxin content of the environment, even in areas where the only dioxin source is the atmosphere.²¹

In the upper atmosphere, chlorine molecules from air pollution gobble up ozone; in the lower atmosphere, they bond with carbon to form organochlorines. Some of the 11,000 commercially used organochlorines include hazardous compounds such as DDT, PCBs, chloroform, and carbon tetrachloride. Organochlorines rarely occur in nature, and living things have little defense against them. They've been linked not only to cancer, but also to neurological damage, immune suppression, and reproductive and developmental effects. When chlorine products are washed down the drain to a septic tank, they're producing organochlorines. Although compost microorganisms can degrade and make harmless many toxic chemicals, highly chlorinated compounds are disturbingly resistant to such biodegradation.²²

"Any use of chlorine results in compounds that cause a wide range of ailments," says Joe Thornton, a Greenpeace researcher, who adds, *"Chlorine is simply not compatible with life. Once you create it, you*

can't control it." ²³

There's no doubt that our nation's sewage treatment systems are polluting our drinking water sources with pathogens. As a result, chlorine is also being used to disinfect *the water we drink* as well as to disinfect discharges from wastewater treatment facilities. It is estimated that 79% of the US population is exposed to chlorine.²⁴ According to a 1992 study, *chlorine is added to 75% of the nation's drinking water* and is linked to cancer. The results of the study suggested that at least 4,200 cases of bladder cancer and 6,500 cases of rectal cancer each year in the US are associated with consumption of chlorinated drinking water.²⁵ This association is strongest in people who have been drinking chlorinated water for more than fifteen years.²⁶

In December, 1992, the US Public Health Service reported that pregnant women who routinely drink or bathe in chlorinated tap water are at a greater risk of bearing premature or small babies, or babies with congenital defects.²⁷

According to a spokesperson for the chlorine industry, 87% of water systems in the US use free chlorines; 11% use chloramines. Chloramines are a combination of chlorine and ammonia. The chloramine treatment is becoming more widespread due to the health concerns over chlorine.²⁸ However, EPA scientists admit that we're pretty ignorant about the potential by-products of the chloramine process, which involves ozonation of the water prior to the addition of chloramine.²⁹

Of course, we don't have to worry. The government will take care of us, and if the government doesn't, then industry will. Won't they? Well, not exactly. According to a US General Accounting Office report in 1992, consumers are poorly informed about potentially serious violations of drinking water standards. In a review of twenty water systems in six states, out of 157 drinking water quality violations, the public received a timely notice in only 17 of the cases.³⁰

ALTERNATIVE WASTEWATER TREATMENT SYSTEMS

New systems are being developed to purify wastewater. One popular experimental system today is the *constructed, or artificial wetlands system*, which runs wastewater through an aquatic environment consisting of aquatic plants such as water hyacinths, bullrushes, duckweed, lilies, and cattails (see Figure 5.14). The plants act as marsh filters, and the microbes which thrive on their roots do most of the work, breaking down nitrogen and phosphorous compounds, as well as toxic chemicals. Although they don't break down heavy metals, the plants absorb them; they can then be harvested and incinerated or landfilled.³¹

According to EPA officials, the emergence of constructed wetlands technology shows great potential as a cost effective alternative to wastewater treatment. The wetlands method is said to be relatively affordable, energy efficient, practical, and effective. Scientists don't yet have the data to determine with assurance the performance expectations of wetlands systems, or contaminant concentrations released by these systems into the environment. However, the treatment efficiency of properly constructed wetlands

is said to compare well with conventional treatment systems.³² Unfortunately, wetlands systems don't recover the agricultural resources available in humanure.

Another system uses solar powered greenhouse-like technology to treat wastewater. This system uses hundreds of species of bacteria, fungi, protozoa, snails, plants and fish, among other things, to produce advanced levels of wastewater treatment. These Solar Aquatics systems are also experimental, but appear hopeful.³³ Again, the agricultural resources of humanure are lost when using any disposal method or wastewater treatment technique instead of a humanure recycling method.

When a household humanure recycling method is used, however, and sewage is not being produced, most households will still be producing graywater. Graywater is the water that is used for washing, bathing, and laundry, and it must be dealt with in a responsible manner before draining into the environment. Most households produce sewage (blackwater). Households that produce *only* graywater are rare, and may even be beyond the comprehension of many government authorities who may insist that every household have a sewage system (e.g., septic system) whether they produce sewage or not. Yet, households which compost their humanure may produce no sewage at all; these households are prime candidates for *alternative* graywater systems. Such alternative systems are discussed in [Chapter 9](#).

AGRICULTURAL USE OF SEWAGE SLUDGE

Now here's where a thoughtful person may ask, "Why not put *sewage sludge* back into the soil for agricultural purposes?"

One reason: government regulation. When I asked the supervisor of my local wastewater treatment plant if the one million gallons of sludge the plant produces each year (for a population of 8,000) was being applied to agricultural land, he said, "*It takes six months and five thousand dollars to get a permit for a land application. Another problem is that due to regulations, the sludge can't lie on the surface after it's applied, so it has to be plowed under shortly after application. When farmers get the right conditions to plow their fields, they plow them. They can't wait around for us, and we can't have sludge ready to go at plowing time.*" It may be just as well.

Problems associated with the agricultural use of sewage sludge include groundwater, soil, and crop contamination with pathogens, heavy metals, nitrate, and toxic and carcinogenic organic compounds.³⁴ Sewage sludge is a lot more than organic human refuse. It can contain DDT, PCBs, mercury, and other heavy metals.³⁵ One scientist alleges that more than 20 million gallons of used motor oil are dumped into sewers every year in the United States.³⁶

America's largest industrial facilities released over 550 million pounds of toxic pollutants into US sewers in 1989 alone, according to the US Public Interest Research Group. Between 1990 and 1994, an additional 450 million pounds of toxic chemicals were dumped into sewage treatment systems, although the actual levels of toxic discharges are said to be much higher than these.³⁷

Of the top ten states responsible for toxic discharges to public sewers in 1991, Michigan took first prize with nearly 80 million pounds, followed in order by New Jersey, Illinois, California, Texas, Virginia, Ohio, Tennessee, Wisconsin and Pennsylvania (around 20 million pounds from PA).³⁸

An interesting study on the agricultural use of sludge was done by a Mr. Purves in Scotland. He began applying sewage sludge at the rate of 60 tons per acre to a plot of land in 1971. After fifteen years of treating the soil with the sludge, he tested the vegetation grown on the plot for heavy metals. On finding that the heavy metals (lead, copper, nickel, zinc and cadmium) had been taken up by the plants, he concluded, “*Contamination of soils with a wide range of potentially toxic metals following application of sewage sludge is therefore virtually irreversible.*”³⁹ In other words, the heavy metals don’t wash out of the soil, they enter the food chain, and may contaminate not only crops, but also grazing animals.⁴⁰

Other studies have shown that heavy metals accumulate in the vegetable tissue of the plant to a much greater extent than in the fruits, roots, or tubers. Therefore, if one must grow food crops on soil fertilized with sewage sludge contaminated with heavy metals, one might be wise to produce carrots or potatoes instead of lettuce.⁴¹ Guinea pigs experimentally fed with swiss chard grown on soil fertilized with sewage sludge showed no observable toxicological effects. However, their adrenals showed elevated levels of antimony, their kidneys had elevated levels of cadmium, there was elevated manganese in the liver and elevated tin in several other tissues.⁴²

Estimated to contain 10 billion microorganisms per gram, sludge may contain many human pathogens.⁴³ “*The fact that sewage sludge contains a large population of fecal coliforms renders it suspect as a potential vector of bacterial pathogens and a possible contaminant of soil, water and air, not to mention crops. Numerous investigations in different parts of the world have confirmed the presence of intestinal pathogenic bacteria and animal parasites in sewage, sludge, and fecal materials.*”⁴⁴

Because of their size and density, parasitic worm eggs settle into and concentrate in sewage sludge at wastewater treatment facilities. One study indicated that roundworm eggs could be recovered from sludge at all stages of the wastewater treatment process, and that two-thirds of the samples examined had viable eggs.⁴⁵ Agricultural use of the sludge can therefore infect soil with 6,000-12,000 viable parasitic worm eggs, per square meter, per year. These eggs can persist in some soils for five years or more.⁴⁶ Furthermore, *Salmonellae* bacteria in sewage sludge can remain viable on grassland for several weeks, thereby making it necessary to restrict grazing on pastureland for several weeks after a sludge application. Beef tapeworm (*Taenia saginata*), which uses cattle as its intermediate host and humans as its final host, can also infect cattle that graze on pastureland fertilized with sludge. The tapeworm eggs can survive on sludged pasture for a full year.⁴⁷

Another interesting study published in 1989 indicated that bacteria surviving in sewage sludge show a high level of resistance to antibiotics, especially penicillin. Because heavy metals are concentrated in sludge during the treatment process, the bacteria that survive in the sludge can obviously resist heavy metal poisoning. These same bacteria also show an inexplicable resistance to antibiotics, suggesting that somehow the resistance of the two environmental factors are related in the bacterial strains that survive.

The implication is that sewage sludge selectively breeds antibiotic-resistant bacteria, which may enter the food chain if the agricultural use of the sludge becomes widespread. The results of the study indicated that more knowledge of antibiotic-resistant bacteria in sewage sludge should be acquired before sludge is disposed of on land.⁴⁸

This poses somewhat of a problem. Collecting human excrement with wastewater and industrial pollutants seems to render the organic refuse incapable of being adequately sanitized. It becomes contaminated enough to be unfit for agricultural purposes. As a consequence, sewage sludge is not highly sought after as a soil additive. For example, the state of Texas sued the US EPA in July of 1992 for failing to study environmental risks before approving the spreading of sewage sludge in west Texas. Sludge was being spread on 128,000 acres there by an Oklahoma firm, but the judge nevertheless refused to issue an injunction to stop the spreading.⁴⁹ Considering that the sludge was from New York City, who can blame the Texans?

Now that ocean dumping of sludge has been stopped, where's it going to go? Researchers at Cornell University have suggested that sewage sludge can be disposed of by surface applications in forests. Their studies suggest that brief and intermittent applications of sludge to forestlands won't adversely affect wildlife, despite the nitrates and heavy metals that are present in the sludge. They point out that the need to find ways to get rid of sludge is compounded by the fact that many landfills are expected to close over the next several years and ocean dumping is now banned. Under the Cornell model, one dry ton of sludge could be applied to an acre of forest each year.⁵⁰ New York state alone produces 370,000 tons of dry sludge per year, which would require 370,000 acres of forest each year for their sludge disposal. Consider the fact that forty-nine other states produce 7.6 million dry tons of sludge. Then there's figuring out how to get the sludge into the forests and how to spread it around. With all this in mind, a guy has to stop and wonder — the woods used to be the only place left to get away from it all.

The problem of treating and dumping sludge isn't the only one. The costs of maintenance and upkeep of wastewater treatment plants is another. According to a report issued by the EPA in 1992, US cities and towns need as much as \$110.6 billion over the next twenty years for enlarging, upgrading, and constructing wastewater treatment facilities.⁵¹

Ironically, when sludge is *composted*, it may help to keep heavy metals *out* of the food chain. According to a 1992 report, composted sludge lowered the uptake of lead in lettuce that had been deliberately planted in lead-contaminated soil. The lettuce grown in the contaminated soil which was amended with composted sludge had a 64% lower uptake of lead than lettuce planted in the same soil but without the compost. The composted soil also lowered lead uptake in spinach, beets, and carrots by more than 50%.⁵²

Some scientists claim that the composting process transforms heavy metals into benign materials. One such scientist who designs facilities that compost sewage sludge states, “*At the final product stage, these [heavy] metals actually become beneficial micro-nutrients and trace minerals that add to the productivity of soil. This principle is now finding acceptance in the scientific community of the USA and is known as biological transmutation, or also known as the Kervran-Effect.*” Composted sewage sludge

that is microbiologically active can also be used to detoxify areas contaminated with nuclear radiation or oil spills, according to the same researcher. Clearly, the composting of sewage sludge is a grossly underutilized alternative to landfill application, and it should be strongly promoted.⁵³

Other scientists have shown that heavy metals in contaminated compost (such as sludge compost) are *not* biologically transmuted, but are actually *concentrated* in the finished compost. This is most likely due to the fact that the compost mass shrinks considerably during the composting process showing reductions of 70%, while the amount of metals remains the same. Some researchers have shown a decrease in the concentrations of *some* heavy metals and an increase in the concentrations of others, for reasons that are unclear. Others show a considerable decrease in the concentrations of heavy metals between the sludge and the finished compost. Results from various researchers “*are giving a confusing idea about the behavior of heavy metals during composting. No common pattern of behavior can be drawn between similar materials and the same metals . . .*”⁵⁴ However, metals concentrations in finished compost seem to be low enough that they are not considered to be a problem, perhaps largely because metal-contaminated sludge is greatly diluted by other clean organic materials when composted.⁵⁵

GLOBAL SEWERS AND PET TURDS

Let’s assume that the whole world adopted the sewage philosophy we have in the United States: defecate into water and then treat the polluted water. What would that scenario be like? Well, for one thing it wouldn’t work. It takes between 1,000 and 2,000 tons of water at various stages in the process to flush one ton of humanure. In a world of just five billion people producing a conservative estimate of one million metric tons of human excrement daily, the amount of water required to flush it all would not be obtainable.⁵⁶ Considering the increasing landfill space that would be needed to dispose of the increasing amounts of sewage sludge, and the tons of toxic chemicals required to “sterilize” the wastewater, one can realize that this system of human waste disposal is far from sustainable and cannot serve the needs of humanity in the long term.

According to Barbara Ward, President of the International Institute for Environment and Development, “*Conventional ‘Western’ methods of waterborne sewerage are simply beyond the reach of most [of the world’s] communities. They are far too expensive. And they often demand a level of water use that local water resources cannot supply. If Western standards were made the norm, some \$200 billion alone [early 1980s] would have to be invested in sewerage to achieve the target of basic sanitation for all. Resources on this scale are simply not in sight.*”

To quote Lattee Fahm, “*In today’s world [1980], some 4.5 billion people produce excretal matters at about 5.5 million metric tons every twenty-four hours, close to two billion metric tons per year. [Humanity] now occupies a time/growth dimension in which the world population doubles in thirty five years or less. In this new universe, there is only one viable and ecologically consistent solution to the body waste problems — the processing and application of [humanure] for its agronutrient content.*”⁵⁷ This sentiment is echoed by World Bank researchers, who state, “[I]t can be estimated that the backlog of over one billion people not now provided with water or sanitation service will grow, not decrease. It

has also been estimated that most developing economies will be unable to finance water carriage waste disposal systems even if loan funds were available.” ⁵⁸

In other words, we have to understand that humanure is a natural substance, produced by a process vital to life (human digestion), originating from the earth in the form of food, and valuable as an organic refuse material that can be returned to the earth in order to produce more food for humans. That’s where composting comes in.

But hey, wait, let’s not be rash. We forgot about incinerating our excrements. We can dry our turds out, then truck them to big incinerators and burn the hell out of them. That way, instead of having fecal pollution in our drinking water or forests, we can breathe it in our air. Unfortunately, burning sludge with other municipal waste produces emissions of particulate matter, sulfur dioxide, nitrogen oxides, carbon monoxide, lead, volatile hydrocarbons, acid gases, trace organic compounds, and trace metals. The leftover ash has a high concentration of heavy metals, such as cadmium and lead.⁵⁹ Doesn’t sound so good if you live downwind, does it?

How about microwaving it? Don’t laugh, someone’s already invented the microwave toilet.⁶⁰ This just might be a good cure for hemorrhoids, too. But heck, let’s get serious and shoot it into outer space. Why not? It probably wouldn’t cost too much per fecal log after we’ve dried the stuff out. This could add a new meaning to the phrase “the Captain’s log.” Beam up another one, Scotty!

Better yet, we can dry our turds out, chlorinate them, get someone in Taiwan to make little plastic sunglasses for them, and we’ll sell them as pet turds! Now that’s an entrepreneurial solution, isn’t it? Any volunteer investors out there?

Source: The Humanure Handbook. Jenkins Publishing, PO Box 607, Grove City, PA 16127. To order, phone: 1-800-639-4099.

<http://www.jenkinspublishing.com/>

MENU: [HOME](#) » [Reconstruction](#) » [Recovery](#) » [Renewal](#) » [Survival](#) » [Humanure Content](#)

COMPOSTING TOILETS AND SYSTEMS

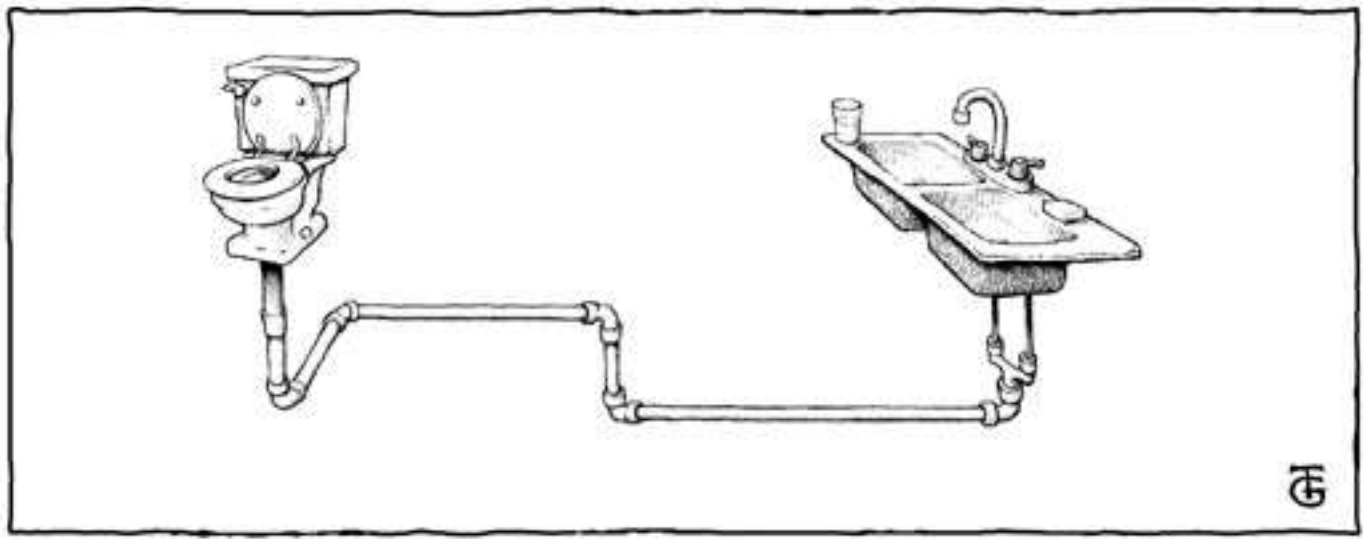

“Simplicity of life, even the barest, is not misery but the very foundation of refinement.”

William Morris

Technically, a “composting toilet” is a toilet in which composting takes place. Usually, the composting chamber is located under the toilet. Other toilets are simply collection devices in which humanure is deposited, then removed to a separate composting location away from the toilet area. These toilets are components of “composting toilet systems,” rather than composting toilets, *per se*.

Humanure composting toilets and systems can generally be divided into two categories based on the composting temperatures they generate. Some toilet systems produce thermophilic (hot) compost; others produce low-temperature compost. Most commercial and homemade composting toilets are low-temperature composting toilets, sometimes called “mouldering toilets.”

The most basic way to compost humanure is simply to collect it in a toilet receptacle and add it to a compost pile. The toilet acts only as a collection device, while the composting takes place at a separate location. Such a toilet requires little, if any, expense, and can be constructed and operated by people of simple means in a wide range of cultures around the world. It is easy to create thermophilic (hot) compost with such a collection toilet. This type of toilet is discussed in detail in [Chapter 8, “The Tao of](#)

Compost.”

The toilets of the future will also be collection devices rather than waste disposal devices. The collected organic material will be hauled away from homes and composted under the responsibility of municipal authorities, perhaps under contract with a private sector composting facility. Currently, other recyclable materials such as bottles and cans are collected from homes by municipalities; in some areas organic food materials are also collected and composted at centralized composting facilities. The day will come when those collected organic materials will include toilet materials.

In the meantime, homeowners who want to make compost rather than sewage must do so independently by either constructing a composting toilet of their own, buying a commercial composting toilet, or using a simple collection toilet with a separate composting bin. The option one chooses depends upon how much money one wants to spend, where one lives, and how much involvement one wants in the compost-making process.

A simple sawdust toilet (a collection toilet) with a separate compost bin is the least expensive, but tends to be limited to homes where an outdoor compost bin can be utilized. Such a toilet is only attractive to people who don't mind the regular job of emptying containers of compost onto a compost pile, and who are willing to responsibly manage the compost to prevent odor and to ensure thermophilic conditions.

Homemade composting toilets, on the other hand, generally include a compost bin underneath the toilet and do not involve carting humanure to a separate compost pile. They tend to be less expensive than commercial composting toilets, and they can be built to whatever size and capacity the household requires, allowing for some creativity in their design. They are usually permanent structures located under the dwelling in a crawl space or basement, but they can also be free-standing outdoor structures. The walls are typically made of a concrete material, and the toilets are most successful when properly managed. Such management includes the regular addition to the toilet contents of sufficient carbon-based bulking material, such as sawdust, peat moss, straw, hay, or weeds. Homemade composting toilets generally do not require water or electricity. Commercial composting toilets come in all shapes, types, sizes, and price ranges. They are usually made of fiberglass or plastic, and consist of a composting chamber underneath the toilet seat. Some of them use water and some of them require electricity. Some require neither. A list of commercial compost toilet manufacturers follows this chapter.

Source: The Humanure Handbook. Jenkins Publishing, PO Box 607, Grove City, PA 16127. To order, phone: 1-800-639-4099.

<http://www.jenkinspublishing.com/>

MENU: [HOME](#) » [Reconstruction](#) » [Recovery](#) » [Renewal](#) » [Survival](#) » [Humanure Content](#)

MENU: [HOME](#) » [Reconstruction](#) » [Recovery](#) » [Renewal](#) » [Survival](#) » [Humanure Content](#)

COMPOSTING TOILETS AND RELATED PRODUCTS: MANUFACTURERS AND SUPPLIERS

(Special Thanks to the World of Composting Toilets Website at:
<http://www.compostingtoilet.org/>)

This list is provided for informational purposes only. Inclusion on this list does not constitute an endorsement by the author.

[AUSTRALIA](#) | [BELGIUM](#) | [CANADA](#) | [CHILE](#) | [DENMARK](#) | [FINLAND](#) | [GERMANY](#) | [IRELAND](#) | [ISRAEL](#) | [KOREA](#) | [LATVIA](#) | [NETHERLANDS](#) | [NEW ZEALAND](#) | [NORWAY](#) | [SOUTH AFRICA](#) | [SPAIN](#) | [SWEDEN](#) | [SWITZERLAND](#) | [UK](#) | [USA](#) | [OWNER BUILT](#) | [COMPOST THERMOMETERS](#) | [BACKYARD COMPOST BINS](#) | [COMPOST TESTING LABS](#) | [AUDIO TAPES](#) | [INTERNET LINKS](#)

AUSTRALIA

CLIVUS MULTRUM AUSTRALIA

115 Railway Avenue, Strathpine, Qld 4500, Australia

Phone: 61 7 3889 6144

Fax: 61 7 3889 6149

Mobile phone: 0419 657851

Website: <http://www.earthlink.com.au/clivus>

Email: www.ats.com.au

Contact: Tony Rapson

Sells the Clivus Multrum range of toilets and graywater systems as well as toilet buildings for use in National Parks and Public areas. Also acts as agent for Separett and EnviroLet composting toilets.

CLIVUS MULTRUM TOILET SYSTEMS (Agent)

9 Holland Street, Fremantle 6160, Western Australia, Australia

Phone: (08) 9430 7777

Fax: 61 8 9430 4305

Email: gaiagnet@cygnus.uwa.edu.au

Agent for Clivus Multrum composting toilets in western Australia.

CLOSET DEPOSIT

3 Redash Place, Cabarita Beach, NSW 2488 Australia;

Contact: Graham Clements;

Supplies own design, inclined base, fibreglass composting chamber. Improved ventilation system for reduced tank size. Also supplies artificial wetlands graywater system in ferro-cement or HDPE plastic with flowform water conditioners.

DOWMUS

Pty Ltd PO Box 400, Mapleton Qld, 4552, Australia

Phone: 61 7 5499 9828

Fax: 61 7 5499 9688

Email: dowmus@ozemail.com.au

Website: <http://www.dowmus.com/>

Supply and install single batch tank system with compost extortion auger. Emphasis on worm and compost fauna treatment. Also incorporating graywater treatment.

GARRY SCOTT COMPOST TOILET SYSTEMS

Mullumbimby NSW, 2482, Australia

Phone: 61 2 6684 3468

FAX: 61 2 6684 4567

Email: maito:enquires@composttoilets.com.au

Website: <http://www.composttoilets.com.au/>

Design, manufacture, supply and service of a wide range of waterless compost toilets. Independent agent for systems manufactured by Clivus Multrum, Natureloo, Envirolet, Separett and selected others. Manufacture of lowcost PBD and Wheelie Batch systems. Ownerbuilder assistance with consultation, components, plans and books. Agent for the Hybrid toilet system, a septic system, with no flush, secondary treatment and excellent performance.

NATURE-LOO

Savannah Environmental Pty Ltd, 74 Brisbane Street, Bulimba, QLD 4171, Australia

Postal Address: P.O. Box 150, Bulimba, Queensland, Australia 4171

Phone: 61 7 3395 6800

Fax: 61 7 3395 5322

Email: info@nature-loo.com.au

Website: <http://www.nature-loo.com.au/>

Contact: Carla Gregg

Patented market-leader in domestic composting toilets: inexpensive, aerated tank, odour-free, batch system. Classic model easily owner-installed in space under floor. Self-contained Compact model can be installed on slab floor, and is suitable for temporary accommodation, holiday cabins, building sites, camp

grounds, etc. Also markets toilet buildings suitable for golf courses, building sites, etc.

ROTA-LOO COMPOSTING TOILET

41A Jarrah Drive or PO Box 988, Braeside, Victoria 3195 Australia

Phone: 61 3 9587 2447

Fax: 61 3 9587 5622

Website: <http://www.rotaloo.com/>

E mail: buzzburrows@rotaloo.com

General info: enquiry@rotaloo.com

Contact: Buzz Burrows (General Manager)

Domestic models, Mini 650, Standard 950 all with removable compost bins. Commercial models, Maxi 1200 (Fiberglass) Maxi 2000, all with removable compost bins. Soltran buildings, remote location Public Toilet Facilities, supplied in kit form in any configuration with combinations of two cubicles either standard or disabled. Graywater systems, plans available for passive systems or electropurification system will clean graywater to potable standard. Other products: Bacterial agents to speed up the decomposition rate. Bacterial agents that terminate odour problems in bad installations. Full range of accessories, fiberglass and ceramic pedestals. Urinals that don't need water for cleaning.

BELGIUM

ECOSAVE SEPRETT (Agent)

Flierenbos 67, 2370 Arendonk, Belgium Ph/Fax: 32 14 67 20 04; Agent for Septum and Separett urine separating composting toilets.

CANADA

CLIVUS MULTRUM CANADA LIAISON OFFICE

1911 Lorraine Place, Ann Arbor, MI 48104-3607

Contact: Laurence Scott

Phone: 734-995-4767

Fax: 734-994-1292

Email: mailto:naylorscott@compuserve.com

CLIVUS MULTRUM CANADA LTD.

1558 Queen Street, East Toronto, Ontario, M4L 1E8 or P.O.Box 783 - Station A, Windsor, Ontario, N9A 6N8

Phone: 800-645-4767

Fax: 416-466-0635 Attn: L H Scott

Email: naylorscott@compuserve.com

CANADA-USA LIAISON

Phone : 734-995-4767

Fax: 734-994-1292

COMPOSTING TOILETS WESTERN (Agent)

1278 Inglewood Avenue, West Vancouver, B.C. B7T 1Y6, Canada

Phone: 1-604-926-3748

Fax: 1-604-926-4854

Contact: Bob Tapp

COMPOSTING TOILETS WESTERN

23646 16th Avenue, Langley B.C.V2Z 1K9, Canada

Phone/Fax: 1-604-533-5207

Contact: J. Rockandel

Supply and install Clivus Multrum composting toilets and Sum-mar composting toilets.

SANCOR

140-30 Milner Ave., Toronto, Ontario M1S 3R3 Canada

USA Toll-Free: 1-800-387-5126

CDA Toll-Free: 1-800-387-5245

International: 1-416-299-4818

Fax: 1-416-299-3124

Email: info@envirolet.com

Website: <http://www.envirolet.com/>

Online Store: <http://www.sancor.net/>

Manufacturer of Envirolet Composting Toilet Systems. The systems include Waterless Self-Contained, Waterless Remote and Low Water Remote models. Available in Non-Electric, 12v Battery, Solar and 110v Electric. Available for purchase online.

SUNERGY SYSTEMS LTD.

Box 70, Cremona, AB T0M 0R0, Canada

Phone: 403-637-3973

Email: sunergy@telusplanet.net

Website: <http://www.compostingtoilet.com/>

Contact: Michael Kerfoot

Also at: SUNERGY'S B.C. OFFICE

2945 Haliday Crescent, Nanaimo, B.C. V9T 1B2 Canada

Phone: 250-751-0053

Fax: 250-751-0063

Sunergy distributes Phoenix composting toilet systems in Canada for residential and public facility applications. Installations from coast to coast include National Parks, Provincial Parks, roadside rest areas, golf courses, responsible housing, etc. Design integrates solar/energy/resource efficiency with a natural whimsy.

SUN-MAR CORPORATION

5035 N Service Rd C9, Burlington Ontario L7L 5V2 Canada

Phone: 1-905-332-1314

Fax: 1-905-332-1315

For a Free Catalogue Call: 1-800-461-2461

Email: compost@sun-mar.com

Website: <http://www.sun-mar.com/>

Long time successful suppliers of bathroom installed composting toilets. Large range of models available for differing situations; both residential and cottage use toilets available.

CHILE

MINIMET

S.A. Av. 11 de Septiembre 1860, Of. 106, Santiago, Chile

Contact: Jaime Arancibia

Phone: 56-2-233-53 69 Fax: 56-2-232-11 95

Email: ggminimet@entelchile.net

Manufactures and sells Clivus Multrum products under license from Clivus Multrum, USA.

DENMARK

A & B BACKLUND APS (Agent)

Ordrupvej 101, DK-2920 Charlottenlund, Denmark

Phone: 45 39 63 33 64

Fax: 45 39 63 64 55

Email: backlund@backlund.dk

We work with ecological environmental engineering and waste to energy subjects. We sell no-mixing composting toilets in plastic, pine wood, metal or china. Our big composting units are made of stainless steel or glassfiber with geotextile sacks. The toilets are either without flushing, with single flushing for urine, double flushing for both urine and feces (but separate), or with vacuum for feces and gravitation for urine. Agent for Separett, Septum, Mullis, WM-Ekologen.

B & O BYGGEINDUSTRI A/S

Pakhus 12, Sdr. Frihavn, Dampfaergevej 8, 2100 Kobenhaun 0, Denmark

Contact: Dany Vandy

Phone : 45 35 43 01 01

Fax: 45 35 43 25 22

Website: <http://www.bobyg.dk>

Email: info@bobyg.dk

Sells and markets Clivus Multrum products as agent for Clivus AB, Sweden.

FINLAND

EKOLET (Biolett)

Estetie 3, FIN-00430 Helsinki, Finland

Phone: +358 40 546 4775, Fax: +358 9 563 5056

Email: ekolet@ekolet.com

Website: <http://www.ekolet.com/>

The Ekolet composting toilet is the manufacturer's own design for domestic and cottage use. Good experience and test results for over 10 years. Requires no water, no additives, low or no el. requirements, cleans the liquid biologically so it can be piped along with graywater. Consists of a toilet seat and a 4 chamber rotating composting tank (polyethene, stainless steel) under the floor. The end-product is ready-to-use odorless fertilizer.

LUONTO-LAITE OY

Kasiniemenraitti 229, Fin-17740 Kasiniemi, Finland

Phone: +358 (0)3 556 8132

Fax +358 (0)3 556 8133

Email: luontola@sci.fi

Marketing: NEXET OY

Ravurinkatu 11 FIN-20380 Turku, Finland

Phone: +358 (0)2 276 0250

Fax: +358 (0)2 276 0251

Email: nexet@nexet.fi

Website: <http://www.saunalahti.fi/luontola>

The Composting Naturum Toilet. Bathroom installed, urine separating, rotary drum, composting toilet. Stylish design toilet in non-PVC plastic.

GERMANY

BIOTECHNIK (Agent)

Sigrid Habel, Lessingstr.6, D-04109 Leipzig Germany

Phone: 49 342 234 8657

Fax: 49 341 980 3391

Agent for Biolett (Ekolet) composting toilets.

PEUSER GMBH (Agent)

Siloweg 1, D-56479 Neunkirchen/Ww Germany

Phone: 49 6436 35 45

Fax: 49 6436 64 99

Agent for Septum toilets and products.

PEUSER GMBH (Agent)

Stollberger Strasse 31 D-09221 Neunkirchen/bei Chemnitz, Germany

Phone: 49 371 281 21 70

Fax: 49 371 281 21 50

Agent for Septum and Separett composting toilets and products.

SANITÄR U. HEIZUNG (Agent)

Uwe Reimer, Hallesche Strasse 9, D-04509 Delitzsch, Germany

Phone: 49 342 025 9281

Fax: 49 177 275 0928

Agent for Biolett (Ekolet) composting toilets.

C. & M. SCHÖNBERGER GBR (Agent)

Blumenstrasse 11; D-61239 Langenhain

Phone: 49 6002-92990

Fax: 49 6002-92980

Agent for Separett Toilets

SOLTEC GMBH (Agent)

Wichmannstrasse 4, Bldg. 10, D-22607 Hamburg, Germany

Phone: +49 40 89 50-25

Fax: +49 40 89 50-28

Email: <mailto:soltec@enbil.de>

Agent for Biolett (Ekolet) composting toilets.

IRELAND

THE OLD RECTORY ROBERT FORRESTER, EASKEY, CO.

Sligo Republic of Ireland

Phone/Fax: 353 96 49 181

Email: adlib@tinet.ie

Agent for Septum and Separett servicing both UK and Ireland.

ISRAEL

ECONET ENVIRONMENTAL TECHNOLOGIES & PROJECTS LTD

Dr. Amram Pruginin, 11 Bialik St, Jerusalem, Israel

Phone/Fax: (972) 2-653 61 71

Email: <mailto:msamram@pluto.mscc.huji.ac.il>

Agent for Clivus Multrum in Israel.

KOREA

CLIVUS KOREA INC.

701 Marco Polo Building, 720-20 Yeoksam-Dong, Kangnam-Ku, Seoul, 135-080 Korea
Phone: 82-2-501-4794/5
Fax: 82-2-568-4631
Contact: J.H. Um
Manufacture and market Clivus Multrum under license from Clivus Multrum USA.

LATVIA

SIA APRITE (Agent)
Gaujas iela 56, Cesis LV-4101, Latvia
Phone/Fax: 371 41 25 033
Agent for Septum toilets and products.

NETHERLANDS (HOLLAND)

CLIVUS MULTRUM ECOSAVE - Mr. Danny Vandy
Noorderbaan 25, 8256 PP Biddinghuizen, Holland
Phone: (31)-321-332-038
Fax: (31)-321-330-975
Agent for Clivus Multrum composting toilets, Septum and Separett.

TECHNISCH BUREAU HAMAR

Heykampsweg 6, 7642 LP Wierden, Netherlands
Phone: 31 546 575697

Email: tbhamar@xs4all.nl

Website: <http://www.xs4all.nl/~tbhamar>

Contact: Hans Baarslag; Makes and sells composting toilets for camping, temporary dwellings and replacement in normal houses. The designs are simple and utilize common materials in their manufacture. They are designed for economic treatment of toilet deposits and some household organic material.

NEW ZEALAND

ECOTECH (Agent)
RD 1 Masters Access Rd., Kaitaia, 0500 New Zealand
Phone/Fax: 64 9 409 4993
Website: <http://www.ecotech.co.nz/>

Email: ecotech/nzed@xtra.co.nz

Contact: J. Douglas Donnell.
Distributors of Sun-Mar composting toilets.

NORWAY

IMPERIAL ENGOS AS

Langgaten 71 A, Postboks 98 N 4301 Sandnes, Norway

Phone: 47 51 66 44 92

Fax: 47 51 62 36 07

Agent for Separett.

VERA VERA MILJO A/S

Postboks 2036, N-3239 Sandefjord Norway

SOUTH AFRICA

DRYLOO

PO Box 75619, Gardenview 2047, South Africa

Phone/Fax: 2711 615 5328

Mobile: 2782 463 0674

Email: theboys@netactive.co.za

Dryloo waterless collapsible low cost composting toilets. Six catchment bags on rotatable piping carousel. No mechanical parts. Suitable for hot conditions. Prov. Pat. 99/1278. Also solar toilet extraction fans. Available from Michael Mayers and Associates. The specialist in African non-flush toilets.

ENVIROLOO ENVIRO OPTIONS (PTY) LTD

P.O. Box 27356, Benrose, 2011, South Africa

Phone: 27 11 6181350

Fax: 27 11 6181838

Established composting toilet maker/installer.

SPAIN

CLIVUS MULTRUM WILLI KNACKSTEDT

Phone /Fax: (34)-95-266 60 25

Mobile: 989 82 22 30

Email: carl@websida.com

SWEDEN

AQUATRON INTERNATIONAL BJORNNASVAGEN

21, S-113 47 Stockholm, Sweden

Phone: 46-8-790 9895

Fax: 46-8-15 7504

Email: info@aquatron.se

Website: <http://www.aquatron.se/>

Contact: Rolf Kornemark or Torgny Sundin.

Systems that use standard flush toilets connected to composting chambers via a centrifugal separator. The composting chamber is either inclined base, single batch or 4 chamber carousel. Graywater is treated with UV prior to drainage to a Graywater infiltration bed..

CLIVUS MULTRUM AB

Ålberga Boställe, 61050 Jönåker, Sweden

Phone: (46)-155-72310

Fax: (46)-155-72390

Email: torb@clivus-multrum.se

Main office in Europe for Clivus Multrum Composting Toilets

EKOLOGEN AB

Box 11162 - 10061, Stockholm, Sweden

Phone: 46 8 641 4250

Fax: 46 8 798 5650

Urine separating composting toilet systems.

MULLIS - THE BIOLOGICAL TOILET

Luxgatan 1, 119 69 Stockholm, Sweden

Phone: 46 8 656 54 56

Fax (?): +46 8 184 71 8

Email: mullis@hem3.passagen.se

Website: <http://hem3.passagen.se/mullis>

Contact: Uno Finnstrom

Supplies an inclined base composting toilet with 4 air tracks, built in rustfree sheet metal. Can be ordered made in desired length for capacity required.

SERVATOR SEPRETT AB

Skinnebo, S-330 10 Bredaryd, Sweden

Phone: 46 371 712 20

Fax: 46 371 712 60

Email: mailto:servator@mbox200.swipnet.se

Website: <http://www.seprett.com/>

Suppliers of Lectrolav and Separett toilets, and now Septum composting toilets.

SVEN LINDEN AB

Ludvigsborg, 24394 Hoor, Sweden

Phone: 46-415-51335

Fax: 46-415-51115

Mobile: 070 584 76 52

Contact: Sven Linden

Produce a number of capacity tanks based on the single batch system with or without inclined base. Also a wheeled bin system is available.

SWEDISH ECOLOGY AB

Klippan 1A, S-414 51 Goteborg, Sweden

Phone: 46 31 42 29 30

Fax: 46 31 42 49 08

Contact: Harry Lejgren

Agent for the MullToa and Separera systems. These are the equivalent Scandinavian names for the Biolet and UFA toilets supplied by Biolet International.

SWITZERLAND

BIOLET INTERNATIONAL

Weidstrasse 18a, 6300 Zug, Switzerland

Phone : 41 41 710 4728

Fax: 41 41 710 4683

Website: <http://www.biolet.com/>

E-mail: info@biolet.com

Established, world-wide suppliers of 9 models of unit compost toilets for bathroom and under-house installation.

UK

BARTON ACCESSORIES

Morleigh Road, Harbertonford, Totnes, Devon TQ9 7TS, England

Phone/Fax: 44 1803 732878

Supplies the WEB toilet, a waterless electronic/biological toilet unit that fits in bathroom. In-built heat treatment in composting cycle. Is able to supply world-wide. New model: 12/24v DC, small enough for recreational vehicles, boats, motor coaches, domestic; can be run from solar cells, batteries, or wind generator.

EASTWOOD SERVICES

Kitty Mill, Wash Lane, Wenhasston, Halesworth, Suffolk, IP19 9DX, England

Phone/Fax: 44 1502 478165

Contact: Adam East.

UK agent for Sun-Mar composting toilets and low flush systems. Supplier of gray and rain water recycling systems.

EKOLOGEN/NATRUM/SEPTUM EASTWOOD SERVICES

c/o Kitty Mill, Wash Lane Wenhasston Halesworth, Suffolk IP19 9DX England

Phone: 44 1502 478249

Fax: 44 1502 478165

ELEMENTAL SOLUTIONS

Oaklands Park, Newnham-on-Severn Gloucestershire, GL14 1EF, UK

Phone: 01594 516063

Fax: 01594 516821

Email <mailto:mark.es@aecb.net>

Contact: Mark Moodie

Incorporates 'Camphill Water' and 'Nick Grant Ecological Engineering'; responsible for over 100 reed bed sites and compost toilet installations. Ceramic composting toilet pedestals. Own design and site specific composting toilet kits. UK and Ireland agents for 'Aquatron' toilet systems. Co writers of "Sewage Solutions; Answering the Call of Nature" and "Septic Tanks." Low water use fittings. Sewage courses, and rainwater harvesting. Genuine enquiries only please.

KINGSLEY CLIVUS ENVIRONMENTAL PRODUCTS LTD.

Kingsley House, Woodside Road, Boyatt Wood Trading Estate, Eastleigh, Hampshire S050 4ET Great Britain

Phone: 44 01703 615680

Fax: 44 01703 642613

Contact: Viv Murley

Sells and markets Clivus Multrum products as agent for Clivus Multrum USA.

MAURICE MOORE

26 St Mary's Rd, Long Ditton, Surrey KT6, England

Phone: 44 181 398 7951

Agent for Soltrna/ Rota-loo in United Kingdom.

WENDAGE POLLUTION CONTROL LTD (Agent)

Rangeways Farm, Conford, Liphook, Hants UK GU30 7QP

Phone: 44 1428 751296

Fax: 44 1428 751541

Contact: Nigel Mansfield.

Agent for Biolet self-contained electrical compost toilets, in several varieties for home, caravans and portacabins. Also consultants in water, sewage and pollution control.

USA

ADVANCED COMPOSTING SYSTEMS

195 Meadows Road, Whitefish, MT, 59937, USA

Phone: 1 406 862 3855

Fax: 1 406 862 3855

Email: phoenix@compostingtoilet.com

Website: <http://www.compostingtoilet.com/>

Contacts: Glenn Nelson, James Conner

Manufactures the Phoenix Composting Toilet, a continuous throughput system featuring odorless, waterless operation, and built-in liquid respray of the composting pile. Very low energy requirements (five watts). Options include microflush toilets, auxillary evaporators, and photovoltaic systems for off-grid installations. Residential and public facility models available.

ALASCAN CLEARWATER SYSTEM

3498 St. Albans Road, Cleveland Heights, OH 44121 USA

Phone: 1 216 382 4151

Contact: David Kern

Email: Drewid@star21.com

Originally developed, tested and supplied in Alaska. The system uses either one cup per flush, or foam flush toilets, and a basement system comprised of one composting tank, one graywater treatment tank, & optional recycling system. System effluents are topsoil & potable water. They have a 15 minute video about the system, available for \$15 US including S&H.

ALASCAN OF MINNESOTA, INC.

8271 - 90th Lane, Clear Lake, MN 55319 USA

Marketing Manager: Jerry L. Carter

Phone: (320) 743-2909

Fax: (320) 743-3509

Email: [mailto:mail@alascanofmn.com](mailto:mail@mail@alascanofmn.com)

Website: <http://www.alascanofmn.com/>

ARCHITERRA ENTERPRISES, INC.

0186 SCR 1400, BRR, Silverthorne, CO 80498 USA

Phone/Fax: 970-262-6727

Email: <mailto:natural@colorado.net>

Website: <http://thenaturalhome.com/>

Catalog: The Natural Home Building Source (24 pages)

We sell and install graywater system packages, and Clivus Multrum and Sun-Mar composting toilet systems.

BIOLET U.S.A.

45 Newbury Street, Boston, MA 02116 USA

Phone: (617) 578-0435

Fax: (617) 578-0465

E-mail: info@biolet.com

Website: <http://www.biolet.com/>

Established manufacturer (since 1972) and worldwide supplier of BioLet composting toilets. Self

contained, remote and non electric units are available.

BIO-RECYCLER CORP.

5308 Emerald Drive, Sykesville, MD 21784 USA

Phone: 1 410 795-2607

Fax: 1 410 549 1445

Contact: Jeremy Criss

Vermiculture based remote processing unit to which toilet deposits are delivered, using minimal water, by vacuum assisted toilet units. The resultant product is high nutrient worm castings used for soil amendment.

BIO-SUN SYSTEMS INC.

RR#2 Box 134A, Route 549, Jobs Corners, Millerton, PA 16936, USA

Toll free: (800) 847-8840

Phone: 1-717 537 2200

Fax: 1 717 537 6200

Email: bio-sun@ix.netcom.com

Contact: Becky Heffner, Al White

Composting toilet system based on the use of in-situ built tank and intermittent compressed air blown through composting pile.

CENTRE FOR ECOLOGICAL POLLUTION PREVENTION

P.O. Box 1330, Concord, MA 01742-1330 USA

Phone 978-369-9440

Email: mailto:cepp@hotmail.com

The CEPP develops, promotes and demonstrates innovative lower-impact technologies and systems, with an emphasis on utilization and zero-discharge approaches. Their most important successes have been the development of low cost net composting systems that are suitable for developing countries and the development of planted treatment systems for graywater utilization.

CLIVUS MULTRUM US

15 Union Street, Lawrence MA, 01840, USA

Phone: 1 978 725 5591;

Toll Free: 1 800 4 CLIVUS

Fax: 1 978 557 9658

Email: forinfo@clivusmultrum.com

Webpage: <http://clivusmultrum.com/>

Contact: Don Mills

Sole manufacturer of the Clivus Multrum, original design of inclined base composting toilet. Residential models as well as commercial systems. Also sell toilet buildings and graywater treatment systems.

CLIVUS NEW ENGLAND

P.O. BOX 127, North Andover, MA 01845 USA
Phone: 978-794-9400
Fax: 978-794-9444

CLIVUS MULTRUM GREAT LAKES, INC.
P.O. Box 1025, Ann Arbor, MI 48106 USA
Phone: 734-995-4767
Fax: 734-994-1292

COTUIT DRY TOILET
Conrad Geysler, PO Box 89, Cotuit, Massachusetts 02635 USA
Phone: 508-428-8442
Email: <mailto:conradg@cape.com>
Website: <http://www.cape.com/cdt>

"CTS" TOILET
Composting Toilet Systems, PO Box 1928, Newport, Washington 99156-1928, USA
Phone: 1 509 447 3708;
Toll Free: 888 786 4538
Fax: 1 509 447 3708
Email: <mailto:cts@povn.com>
Contact: Joel Jacobsen
Inclined base composting toilet system built from fibreglass. 5 models offered with NSF International certification. Also offer pre-engineered toilet buildings and agent for Sun-Mar composting toilets.

ECOLOGY SERVICES
PO Box 76, Delafield, WI 53018 USA
Phone/Fax: 262-646-4664
Contact: Mike Mangan
Sell and install composting toilets, graywater systems, and rainwater collection systems. Sunmar and Phoenix toilets.

ECO-TECH/VERA ECOS, INC.
P.O. Box 1313, Concord, MA 01742-1313 USA
Phone: 978-369-3951
Fax: 978-369-2484
Email: watercon@igc.org
Website: <http://www.ecologicalengineering.com/>

"Tools for low-water living since 1972." Sell a range of products: EcoTech Carousel compost ECO-TECH/VERA (cont.) ing toilet system, as well as composting toilet models from Vera Toga, BioLet, CTS and Sun-Mar; plans for site-built composting toilets; the Septic Protector, vacuum and micro-flush toilets; Washwater Garden graywater system; and related low-water products. Catalog \$2.

JADE MOUNTAIN INC (Agent)

P.O. Box 4616, 717 Poplar, Boulder, CO 80306, USA

Phone: 1 800 442 1972 or 303 449 6601

Fax: 1 303 449 8266

Email: <mailto:info@jademountain.com>

Website: <http://www.jademountain.com/>

You can now download the complete catalog and order online. Supplies a wide range of appropriate technology products (over 6000) and information which includes composting toilets and graywater treatment systems.

LEHMANS HARDWARE AND APPLIANCES (Agent)

One Lehman Circle, P.O. Box 41, Kidron, Ohio 44636, USA

Phone: 330 857 5757

Fax: 330 857 5785

Email: info@lehmans.com

Website: <http://www.lehmans.com/>

Agent for Sunmar, Biolet and Alaskan systems. Store and catalogue mail order sales of products for self-sufficiency. "Serving the Amish and others without electricity with products for simple, self sufficient living since 1955."

MOUNTAIN LION TRADING CO. (Agent)

Sales office: 2404 North Columbus Street Spokane, WA 99207-2126, USA

Phone: 1 509-487-0765 (Voice or Fax)

Email: cj@mtlion.com

Website: <http://www.mtlion.com/sunmar>

Sell a range of products including Sunmar composting toilets.

REAL GOODS TRADING CO. (Agent)

555 Leslie St, Ukiah, CA. 95482, USA

Phone: 1 707 468 9292

Fax: 1 707 468 9394

Email: <mailto:realgoods@realgoods.com>

Website: <http://www.realgoods.com/>

Sun-mar and Biolet composting toilet agents. Stores in Hopland, CA, Eugene, OR and Amherst, WI.

SMARTER WATER COMPANY

Atlanta, GA USA

Email: email@smarterwater.com

Website: <http://www.smarterwater.com/>

Southeastern U.S. distributor of composting toilet systems. Agents for Sunmar composting toilet

systems.

SOILTECH (Agent)

607 East Canal St, Newcomerstown, Ohio, 43832-1207, USA

Phone: 1 614 498 5929

Email: <mailto:soiltech@tusco.net>

Website: <http://web.tusco.net/soiltech>

Contact: Kevin Mills; Distributors of Biolet composting toilets. Also have related products including a mulch starter.

SOLAR COMPOSTING ADVANCED TOILETS (S.C.A.T.)

Larry Warnberg, PO Box 43, Nahcotta, WA 98637, USA

Phone: 360-665-2926

Email: warnberg@pacifier.com

The Solar Composting Advanced Toilet — S.C.A.T. — is a freestanding complete toilet facility designed to recycle human excrement and urine into a relatively dry and deodorized compost which can be safely and easily applied to the immediately surrounding landscape. The S.C.A.T. is suitable for recreational campsites, vacation cabins, construction sites, agricultural and nursery settings.

SUN-MAR CORPORATION

600 Main St., Tonawanda, NY 14150-0888 USA

For a Free Catalogue Call: 1 800 461 2461

Email: compost@sun-mar.com

Website: <http://www.sun-mar.com/>

SUPER TOILETS USA

John Flaherty, 10 Seaside Place, Norwalk, CT 06855 USA

Phone/Fax: 203-831-9810

OWNER BUILT

APPALACHIA SCIENCE IN THE PUBLIC INTEREST

50 Lair St., Mt. Vernon, KY 40456 USA

Phone: 606 256 0077 (main office)

Fax: 606 256 2779

Email: aspi@kih.net

Website: <http://www.kih.net/aspi>

Contact: Jack Kiefer

ASPI has technical bulletins on composting toilets and constructed wetlands including schematics for a compost toilet which ASPI designed, and for a constructed wetland.

BIG BATCH COMPOSTING TOILET EKAT (East Kentucky Appropriate Technologies)

Executive Director, 150 Gravel Lick Branch Road Dreyfus, KY 40385, USA

Phone: 606 986-6146

Contact: Robert J. Fairchild

Another owner-build system that utilizes readily available materials. It is designed around a large rolling polyethylene dump cart with air pipes of PVC placed into it. Two are used, one 'resting' while the other is filled. EKAT is a non-profit organization which provides engineering assistance with appropriate technology projects to families and groups in central Appalachia. The 'Big batch composting toilet' plans are \$7.

ECO-TECH/VERA ECOS, INC.

P.O. Box 1313, Concord, MA 01742-1313 USA

Phone: 978-369-3951

Fax: 978-369-2484

Email: watercon@igc.org

Website: <http://www.ecologicalengineering.com/>

Plans for site-built composting toilets (see previous US listing).

ELEMENTAL SOLUTIONS

Oaklands Park, Newnham-on-Severn Gloucestershire, GL14 1EF, UK

Phone: 01594 516063

Fax: 01594 516821

Email: mark.es@aecb.net

Contact: Mark Moodie

Kits include plans of the chamber recommended for a domestic situation in the UK climate. Includes ceramic pedestal, internal fittings of the tank, water proof 12V or 230V fan (uses ~3W) and power supply where necessary, construction and maintenance manual.

GARRY SCOTT COMPOST TOILET SYSTEMS

Mullumbimby NSW, 2482, Australia

Phone/Fax: 61 2 6684 3468

Email: mailto:compost@mullum.com.au

Ownerbuilder assistance with consultation, components, plans and books.

LONG BRANCH ENVIRONMENTAL EDUCATION CENTER

Big Sandy Mush Creek; POB 369; Leicester, NC 28748 USA

Contact: Paul Gallimore, Director

Phone: 828-683-3662

Fax: 828-683-9211

Email: paulg@buncombe.main.nc.us

Website: <http://main.nc.us/LBEEC>

SOLAR COMPOSTING ADVANCED TOILET (S.C.A.T.)

Larry Warnberg, PO Box 43, Nahcotta, WA 98637, USA

Phone: 360 665 2926

Email: warnberg@pacifier.com

Solar composting toilet plans ([see previous US listing](#))

STAN SLAUGHTER 55 GALLON DRUM COMPOST TOILET - GUIDEBOOK AND PLANS

Stan Slaughter, Tall Oak Productions, Pilar Route, Box 11B, Embudo, NM 87531, USA

Phone: 888 484 4477

Fax: 505 758 0201

Website: <http://www.stanslaughter.com/>

Also has a great audio tape: Rot N' Roll. Offers music/educational programs and a new card game, "Compost Gin."

"SUNNY JOHN" SOLAR MOLDERING TOILET CONSTRUCTION PLANS - \$20/POSTPAID

John Cruickshank, 5569 North County Road 29, Loveland CO 80538

Email: hobbitouse@compuserve.com

Website: <http://ourworld.compuserve.com/homepages/hobbitouse>

COMPOST THERMOMETERS

REOTEMP

11568 Sorrento Valley Road, Suite 10 San Diego, CA 92121 USA

Phone: 619 481 7737

Toll free: 1-800-648-7737

Fax: 619 481 7415

Email: reotemp@reotemp.com

Website: <http://www.reotemp.com/>

BACKYARD COMPOST BINS

COVERED BRIDGE ORGANIC

PO Box 91, Jefferson, OH 44047 USA

Phone: 440 576 5515

GARDNER EQUIPMENT

PO Box 106, Juneau, WI 53039 USA

Toll Free: 800 393 0333

GEDYE COMPOST BINS

555 S. Sunrise Way, Ste. 200, Palm Springs, CA 92262 USA

Phone: 760 325 1035

Fax: 760 778 5383

HARMONIOUS TECHNOLOGIES

PO Box 1716, Sebastopol, CA 95437 USA

Phone: 707 823 1999

Fax: 707 823 2424

Website: <http://www.homecompost.com/>

Bins made from 100% recycled plastic.

PALMOR PRODUCTS

PO Box 38, Thorntown, IN 46071 USA

Phone: 800 872 2822

Fax: 765 436 2490

Website: <http://www.trac-vac.com/>

PLASTOPAN NORTH AMERICA, INC.

812 E 59th St., Los Angeles, CA 90001 USA

Phone: 323 231 2225

Fax: 323 231 2068

Website: <http://www.plastopan.com/>

PRECISION-HUSKY

Equipment Division POD 507, Leeds, AL 35094 USA

Phone: 205 640 5181

Fax: 205 640 1147

Website: <http://www.precisionhusky.com/>

PRESTO PRODUCTS CO.

PO Box 2399, Appleton, WI 54913 USA

Phone: 920 738 0986

Fax: 920 738 1458

RECYCLED PLASTICS MARKETING, INC.

2829 152nd Ave. NE, Redmond, WA 98052 USA

Phone: 800 867 3201

Fax: 425 867 3282

Website: <http://www.rrpm.com/>

C.E. SHEPHERD CO., INC.

PO Box 9445, Houston, TX 77261 USA

Phone: 713 928 3763

Fax: 713 928 2324

Website: <http://www.ceshepherd.com/>

SMITH AND HAWKEN

117 East Strawberry Dr., Mill Valley, CA 94941 USA

Phone: 415 383 4415

Fax: 415 383 8010

Website: <http://www.smithandhawken.com/>

SWING AND SLIDE CORPORATION (SHAPE PRODUCTS)

1212 Barberry Dr., Janesville, WI 53545 USA

Phone: 800 888 1232

Fax: 608 755 4763

THE WILMARC CO.

225 W Grant St., Thorntown, IN 46071 USA

Ph: 765 436 7089

Fax: 765 436 2634

COMPOST TESTING LABS

WOODS END AGRICULTURAL INSTITUTE, INC.

PO Box 297, Mt. Vernon, ME 04352 USA

Phone: 207-293-2457

Toll Free: 800-451-0337

Fax: 207-293-2488

Email: info@woodsend.org

Website: <http://www.woodsend.org/>

Ascaris and coliform testing as well as full nutrient tests. Sells the Solvita(R) Maturity Test Kit which is now approved in CA, CT, IL, MA, ME, NJ, NM, OH, TX, and WA. Has developed a soil-respiration test kit that is approved by the USDA for soil quality investigations.

WOODS END EUROPE AUC

Agrar und Umwelt-Consult GmbH: Augustastrasse 9 D-53173 Bonn, Germany

Phone: 049 0228 343246

Fax: 049 0228 343237

Officially certified for pathogen survival testing. Sells the Solvita(R) Maturity Test Kit which is now approved in CA, CT, IL, MA, ME, NJ, NM, OH, TX, and WA.

CONTROL LAB. INC.

42 Hangar Way, Watsonville, CA 95076 USA

Phone: 831 724 5422

Fax: 831 724 3188

AUDIO TAPES

ROT 'N ROLL

Stan Slaughter, Tall Oak Productions, Pilar Route, Box 11B, Embudo, NM 87531 USA

Phone: 888 484 4477

Fax: 505 758 0201

Website: <http://www.stanslaughter.com/>

SONGS FOR THE COMPOST PILE

Dreams and Bones Performance Company, Jake Weinstein, Rainbow Recycling, 810 State St., New Haven, CT 06511 USA

Phone: 203 865 6507

INTERNET LINKS

EARTHWISE PUBLICATIONS

High Walk House, Kirkby Malzeard, Ripon HG4 3RY England

Phone + 44 01765 658786

Fax on request.

Email: earthwise@earthwise.nwnet.co.uk

World of Composting Toilets: <http://www.compostingtoilet.org/>

International Composting Toilet News: <http://www.nwnet.co.uk/earthwise/journal>

Rot Web: http://net.indra.com/~topsoil/Compost_Menu.html

Compost Resource Page: <http://www.oldgrowth.org/compost/humanure.html>

Humanure Forum: http://www.oldgrowth.org/compost/forum_humanure1

Canadian Composting Toilet Website: <http://www.cityfarmer.org/comptoilet64.html#toilet>

Composting council: <http://www.compostingcouncil.org/>

Others of interest:

http://www.cfe.cornell.edu/compost/Composting_homepage.html

<http://www.composter.com/>

<http://www.history.rochester.edu/class/compost/compost.html>

Vermicomposting:

<http://www.humic.com/>

<http://www.wormdigest.org/>

<http://www.wormwoman.com/>

<http://www.vermint.com.au/>

<http://www.wormpage.com/>

<http://www.allthingsorganic.com/>

<http://www.worm-publications.com/>

<http://www.vermitechnology.com/>

Source: The Humanure Handbook. Jenkins Publishing, PO Box 607, Grove City, PA 16127. To order, phone: 1-800-639-4099.

<http://www.jenkinspublishing.com/>

MENU: [HOME](#) » [Reconstruction](#) » [Recovery](#) » [Renewal](#) » [Survival](#) » [Humanure Content](#)

WORMS AND DISEASE

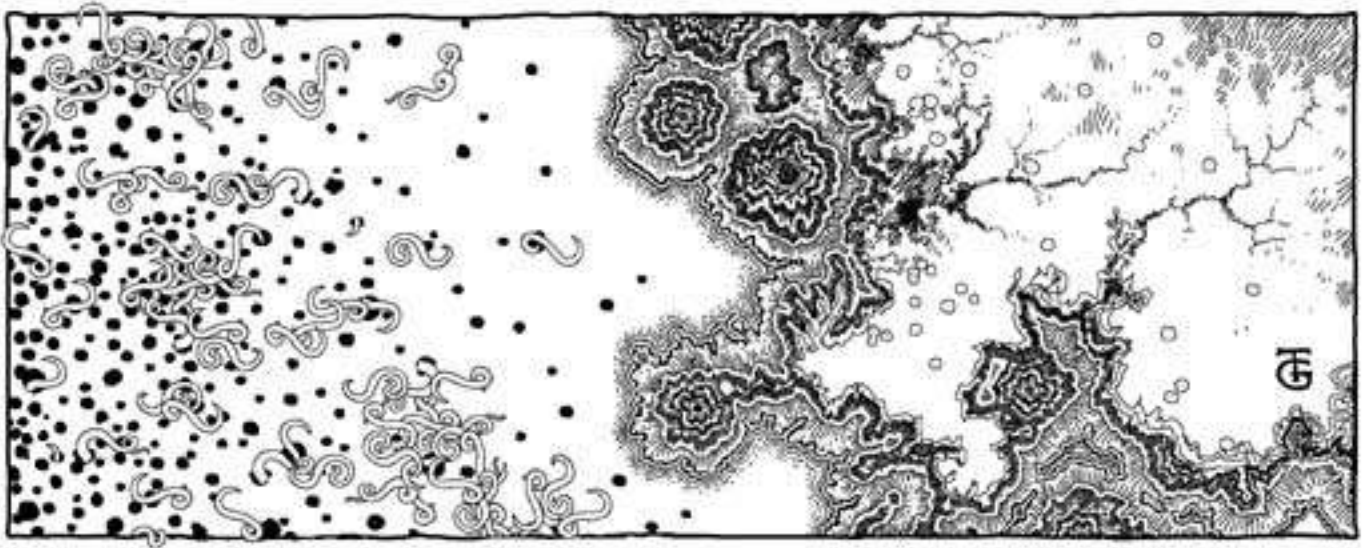

“A well-made compost heap steams like a tea kettle and gets hot enough to destroy all pathogens that may be present when one uses human sewage. An extraordinary device when one thinks about it. Thermophilic bacteria. Bacteria that can live and flourish in temperatures hot enough to cook an egg. How can they survive in such heat? Truly the tricks of nature are extraordinary!”

Robert S. deRopp

I well remember in early 1979 when I first informed a friend that I intended to compost my own manure and grow my own food with it. *“Oh my God, you can’t do that!”* she cried.

“Why not?”

“Worms and disease!”

Of course. What else would a fecophobe think of when one mentions using humanure as a fertilizer?

A young English couple was visiting me one summer after I had been composting humanure for about six years. One evening, as dinner was being prepared, the couple suddenly understood the horrible reality of their situation: the food they were about to eat was *recycled shit*. When this “fact” dawned upon them, it seemed to set off some kind of instinctive alarm in their minds, possibly inherited directly from Queen Victoria. *“We don’t want to eat shit!”* they informed me (that’s an exact quote), as if in preparing dinner I

was simply defecating on plates and setting them on the table. Never mind that the food was delicious. It was the *thought* of it that mattered.

Fecophobia is alive and well and currently afflicting about a billion westerners. One common misconception is that fecal material, when composted, remains fecal material. *It does not.* Humanure comes from the earth, and through the miraculous process of composting, is converted back into earth. When the composting process is finished, the end product is humus, not crap, and it is useful in growing food. My friends didn't understand this; despite my attempts to clarify the matter for their benefit, they chose to cling to their misconceptions. Apparently, some fecophobes will always remain fecophobes.

Allow me to make a radical suggestion: humanure is not dangerous. More specifically, it is not any more dangerous than the body from which it is excreted. The danger lies in what we *do* with humanure, not in the material itself. To use an analogy, a glass jar is not dangerous either. However, if we smash it on the kitchen floor and walk on it with bare feet, we will be harmed. If we use a glass jar improperly and dangerously, we will suffer for it, but that's no reason to condemn glass jars. When we discard humanure as a waste material and pollute our soil and water supplies with it, we are using it improperly, and that is where the danger lies. When we constructively recycle humanure by composting, it enriches our soil, and, like a glass jar, actually makes life easier for us.

Not all cultures think of human excrement in a negative way. For example, swear-words meaning excrement do not seem to exist in the Chinese language. The Tokyo bureau chief for the New York Times explains why: "*I realized why people [in China] did not use words for excrement in a negative way. Traditionally, there was nothing more valuable to a peasant than human waste.*" ¹ Calling someone a "humanure head" just doesn't sound like an insult. "Humanure for brains" doesn't work either. If you told someone they were "full of humanure," they'd probably agree with you. "Shit," on the other hand, is a substance that is widely denounced and has a long history of excoriation in the western world. Our ancestor's historical failure to responsibly recycle the substance caused monumental public health headaches. Consequently, the attitude that humanure *itself* is terribly dangerous has been embraced and promulgated up to the present day.

For example, a recently published book on the topic of recycling "human waste" begins with the following disclaimer: "*Recycling human waste can be extremely dangerous to your health, the health of your community and the health of the soil. Because of the current limits to general public knowledge, [we] strongly discourage the recycling of human waste on an individual or community basis at this time and cannot assume responsibility for the results that occur from practicing any of the methods described in this publication.*" The author adds, "*Before experimenting, obtain permission from your local health authority since the health risks are great.*" The author then elaborates upon a human "waste" composting methodology which includes segregating urine from feces, collecting the manure in 30 gallon plastic containers, and using straw rather than sawdust as a cover material in the toilet.² All three of these procedures are ones I would discourage based on my 20 years of humanure composting experience (no need to go to the bother of segregating urine; a 30 gallon container is way too big and heavy to be able to easily handle; and *sawmill* sawdust does, in fact, work beautifully in a composting toilet. These issues will be thoroughly discussed in the next chapter).

I had to ask myself why an author writing a book on recycling humanure would “*strongly discourage the recycling of human waste,*” which seems counterproductive, to say the least. If I didn’t already know that recycling humanure was easy and simple, I might be totally petrified at the thought of attempting such an “*extremely dangerous*” undertaking after reading that book. And the last thing anyone wants to do is get the local health authorities involved. If there is anyone who knows nothing about composting humanure, it’s probably the local health authority, who receives no such training. I had to read between the lines of the book to find an explanation.

It seems that the author was somehow associated with the “Bio-Dynamic” agricultural movement, founded by Dr. Rudolf Steiner. Dr. Steiner has quite some following around the world, and many of his teachings are followed almost religiously by his disciples. The Austrian scientist and spiritual leader had his own opinions about the recycling of humanure, based as it were on intuition rather than on experience or science. He insisted that humanure must only be used to fertilize soil used to grow plants to feed animals *other* than humans. The manure from those animals can then be used to fertilize soil to grow plants for human consumption. According to Steiner, humans must *never* get any closer to a direct human nutrient cycle than that. Otherwise, they will suffer “brain damage and nervous disorders.” Steiner further warned against using “lavatory fluid,” including human urine, which “should never be used as a fertilizer, no matter how well-processed or aged it is.”³ Steiner, quite frankly, was ill-informed, incorrect, and severely fecophobic, and that fecophobia has, unfortunately, rubbed off on some of his followers. It is unfortunate that sensational, fear-motivated warnings regarding humanure recycling continue to be published.

But, it’s nothing new, and it has historically been based upon ignorance, which is a widespread problem. At one time, for example, doctors insisted that human excrement should be an important and necessary part of one’s personal environment. They argued that, “*Fatal illness may result from not allowing a certain amount of filth to remain in [street] gutters to attract those putrescent particles of disease which are ever present in the air.*” At that time, toilet contents were simply dumped in the street. Doctors believed that the germs in the air would be drawn to the filth in the street and therefore away from people. This line of reasoning so influenced the population that many homeowners built their outhouses attached to their kitchens in order to keep their food germ-free and wholesome.⁴ The results were just the opposite — flies made frequent trips between the toilet contents and the food table.

By the early 1900s, the US government was condemning the use of humanure for agricultural purposes, warning of dire consequences, including death, to those who would dare to do otherwise. A 1928 US Department of Agriculture bulletin made the risks crystal clear: “*Any spittoon, slop pail, sink drain, urinal, privy, cesspool, sewage tank, or sewage distribution field is a potential danger. A bit of spit, urine, or feces the size of a pin head may contain many hundred germs, all invisible to the naked eye and each one capable of producing disease. These discharges should be kept away from the food and drink of [humans] and animals. From specific germs that may be carried in sewage at any time, there may result typhoid fever, tuberculosis, cholera, dysentery, diarrhea, and other dangerous ailments, and it is probable that other maladies may be traced to human waste. From certain animal parasites or their eggs that may be carried in sewage there may result intestinal worms, of which the more common are the*

hookworm, roundworm, whipworm, eelworm, tapeworm, and seat worm.

Disease germs are carried by many agencies and unsuspectingly received by devious routes into the human body. Infection may come from the swirling dust of the railway roadbed, from contact with transitory or chronic carriers of disease, from green truck [vegetables] grown in gardens fertilized with night soil or sewage, from food prepared or touched by unclean hands or visited by flies or vermin, from milk handled by sick or careless dairymen, from milk cans or utensils washed with contaminated water, or from cisterns, wells, springs, reservoirs, irrigation ditches, brooks, or lakes receiving the surface wash or the underground drainage from sewage-polluted soil.”

The bulletin continues, *“In September and October, 1899, 63 cases of typhoid fever, resulting in five deaths, occurred at the Northampton (Mass.) insane hospital. This epidemic was conclusively traced to celery, which was eaten freely in August and was grown and banked in a plot that had been fertilized in the late winter or early spring with the solid residue and scrapings from a sewage filter bed situated on the hospital grounds.”*

And to drive home the point that human waste is highly dangerous, the bulletin adds, *“Probably no epidemic in American history better illustrates the dire results that may follow one thoughtless act than the outbreak of typhoid fever at Plymouth, Pa., in 1885. In January and February of that year the night discharges of one typhoid fever patient were thrown out upon the snow near his home. These, carried by spring thaws into the public water supply, caused an epidemic running from April to September. In a total population of about 8,000, 1,104 persons were attacked by the disease and 114 died.”*

The government bulletin insisted that the use of human excrement as fertilizer was both “dangerous” and “disgusting.” It warned that, *“under no circumstances should such wastes be used on land devoted to celery, lettuce, radishes, cucumbers, cabbages, tomatoes, melons, or other vegetables, berries, or low-growing fruits that are eaten raw. Disease germs or particles of soil containing such germs may adhere to the skins of vegetables or fruits and infect the eater.”* The bulletin summed it up by stating, *“Never use [human] waste to fertilize or irrigate vegetable gardens.”* The fear of human excrement was so severe it was advised that the contents of bucket toilets be burned, boiled, or chemically disinfected, then buried in a trench.⁵

This degree of fecophobia, fostered and spread by authoritative government publications and by spiritual leaders who knew of no constructive alternatives to waste disposal, still maintains a firm grip on the western psyche. It may take a long time to eliminate. A more constructive attitude is displayed by scientists with a broader knowledge of the subject of recycling humanure for agricultural purposes. They realize that the benefits of proper humanure recycling “far outweigh any disadvantages from the health point of view.”⁶

THE HUNZAS

It’s already been mentioned that entire civilizations have recycled humanure for thousands of years. That

should provide a fairly convincing testimony about the usefulness of humanure as an agricultural resource. Many people have heard of the “Healthy Hunzas,” a people in what is now a part of Pakistan who reside among the Himalayan peaks, and routinely live to be 120 years old. The Hunzas gained fame in the United States during the 1960s health food era, at which time several books were written about the fantastic longevity of this ancient people. Their extraordinary health has been attributed to the quality of their overall lifestyle, including the quality of the natural food they eat and the soil it’s grown on. Few people, however, realize that the Hunzas also compost their humanure and use it to grow their food. They’re said to have virtually no disease, no cancer, no heart or intestinal trouble, and they regularly live to be over a hundred years old while *“singing, dancing and making love all the way to the grave.”*

According to Tompkins (1989), *“In their manuring, the Hunzakuts return everything they can to the soil: all vegetable parts and pieces that will not serve as food for humans or beast, including such fallen leaves as the cattle will not eat, mixed with their own seasoned excrement, plus dung and urine from their barns. Like their Chinese neighbors, the Hunzakuts save their own manure in special underground vats, clear of any contaminable streams, there to be seasoned for a good six months. Everything that once had life is given new to life through loving hands.”* ⁷ (emphasis mine)

Sir Albert Howard wrote in 1947, *“The Hunzas are described as far surpassing in health and strength the inhabitants of most other countries; a Hunza can walk across the mountains to Gilgit sixty miles away, transact his business, and return forthwith without feeling unduly fatigued.”* Sir Howard maintains that this is illustrative of the vital connection between a sound agriculture and good health, insisting that the Hunzas have evolved a system of farming which is perfect. He adds, *“To provide the essential humus, every kind of waste [sic], vegetable, animal and human, is mixed and decayed together by the cultivators and incorporated into the soil; the law of return is obeyed, the unseen part of the revolution of the great Wheel is faithfully accomplished.”* ⁸ Sir Howard’s view is that soil fertility is the real basis of public health.

A medical professional associated with the Hunzas claimed, *“During the period of my association with these people I never saw a case of asthenic dyspepsia, of gastric or duodenal ulcer, of appendicitis, of mucous colitis, of cancer . . . Among these people the abdomen over-sensitive to nerve impressions, to fatigue, anxiety, or cold was unknown. Indeed their buoyant abdominal health has, since my return to the West, provided a remarkable contrast with the dyspeptic and colonic lamentations of our highly civilized communities.”*

Sir Howard adds, *“The remarkable health of these people is one of the consequences of their agriculture, in which the law of return is scrupulously obeyed. All their vegetable, animal and human wastes [sic] are carefully returned to the soil of the irrigated terraces which produce the grain, fruit, and vegetables which feed them.”* ⁹

The Hunzas composted their organic material, thereby recycling all of it. This actually enhanced their personal health and the health of their community. The US Department of Agriculture was apparently unaware of the effective natural process of composting in 1928 when they described the recycling of

humanure as “dangerous and disgusting.” No doubt the USDA would have confused the Hunzas, who had for centuries safely and constructively engaged in such recycling.

PATHOGENS

[Much of the following information is adapted from Appropriate Technology for Water Supply and Sanitation, by Feachem et al., World Bank, 1980.¹⁰ This comprehensive work cites 394 references from throughout the world, and was carried out as part of the World Bank’s research project on appropriate technology for water supply and sanitation.]

Clearly, even the primitive composting of humanure for agricultural purposes does not necessarily pose a threat to human health, as evidenced by the Hunzas. Yet, fecal *contamination* of the environment certainly can pose a threat to human health. Feces can harbor a host of disease organisms which can contaminate the environment to infect innocent people when human excrement is discarded as a waste material. In fact, even a healthy person apparently free of disease can pass potentially dangerous pathogens through their fecal material, simply by being a carrier. The World Health Organization estimates that 80% of all diseases are related to inadequate sanitation and polluted water, and that half of the world’s hospital beds are occupied by patients who suffer from water-related diseases.¹¹ As such, the composting of humanure would certainly seem like a worthwhile undertaking worldwide.

The following information is not meant to be alarming. It’s included for the sake of thoroughness, and to illustrate the need to *compost* humanure, rather than to try to use it raw for agricultural purposes. When the composting process is side-stepped and pathogenic waste is issued into the environment, various diseases and worms can infect the population living in the contaminated area. This fact has been widely documented.

For example, consider the following quote from Jervis (1990): “*The use of night soil [raw human fecal material and urine] as fertilizer is not without its health hazards. Hepatitis B is prevalent in Dacaiyuan [China], as it is in the rest of China. Some effort is being made to chemically treat [humanure] or at least to mix it with other ingredients before it is applied to the fields. But chemicals are expensive, and old ways die hard. Night soil is one reason why urban Chinese are so scrupulous about peeling fruit, and why raw vegetables are not part of the diet. Negative features aside, one has only to look at satellite photos of the green belt that surrounds China’s cities to understand the value of night soil.*”¹²

On the other hand, “worms and disease” are not spread by properly prepared compost, nor by healthy people. There is no reason to believe that the manure of a healthy person is dangerous unless left to accumulate, pollute water with intestinal bacteria, or breed flies and/or rats, all of which are the results of negligence or bad customary habits. It should be understood that the breath one exhales can also be the carrier of dangerous pathogens, as can one’s saliva and sputum. The issue is confused by the notion that if something is potentially dangerous, then it is always dangerous, which is not true. Furthermore, it is generally not understood that the carefully managed thermophilic composting of humanure converts it into a sanitized agricultural resource. No other system of fecal material and urine recycling or disposal can achieve this without the use of dangerous chemical poisons or a high level of technology and energy

consumption.

Even urine, usually considered sterile, can contain disease germs (see Table 7.1). Urine, like humanure, is valuable for its soil nutrients. It is estimated that one person's annual urine output contains enough soil nutrients to grow grain to feed that person for a year.¹³ Therefore, it is just as important to recycle urine as it is to recycle humanure, and composting provides an excellent means for doing so.

The pathogens that can exist in human feces can be divided into four general categories: *viruses*, *bacteria*, *protozoa*, and *worms (helminths)*.

VIRUSES

First discovered in the 1890s by a Russian scientist, viruses are among the simplest and smallest of life forms. Many scientists don't even consider them to be organisms. They are much smaller and simpler than bacteria (some viruses are parasitic to bacteria), and the simplest form may consist only of an RNA molecule. By definition, a virus is an entity which contains the information necessary for its own replication, but does not possess the physical elements for such replication — they have the software, but not the hardware. In order to reproduce, therefore, viruses rely on the hardware of the infected host cell, which is re-programmed by the virus in order to reproduce viral nucleic acid. As such, viruses cannot reproduce outside the host cell.¹⁴

There are more than 140 types of viruses worldwide that can be passed through human feces, including polioviruses, coxsackieviruses (causing meningitis and myocarditis), echoviruses (causing meningitis and enteritis), reovirus (causing enteritis), adenovirus (causing respiratory illness), infectious hepatitis (causing jaundice), and others (see Table 7.3). During periods of infection, one hundred million to one trillion viruses can be excreted with each gram of fecal material.¹⁵

BACTERIA

Of the pathogenic bacteria, the genus *Salmonella* is significant because it contains species causing typhoid fever, paratyphoid, and gastrointestinal disturbances. Another genus of bacteria, *Shigella*, causes dysentery. Mycobacteria cause tuberculosis (see Table 7.4). However, according to Gotaas, pathogenic bacteria “are unable to survive temperatures of 55°-60°C for longer than 30 minutes to one hour.”¹⁶

PROTOZOA

The pathogenic protozoa include *Entamoeba histolytica* (causing amoebic dysentery), and members of the Hartmanella-Naegleria group (causing meningo-encephalitis) (see Table 7.5). The cyst stage in the life cycle of protozoa is the primary means of dissemination as the amoeba die quickly once outside the human body. Cysts must be kept moist in order to remain viable for any extended period.¹⁷

PARASITIC WORMS

Finally, a number of parasitic worms pass their eggs in feces, including hookworms, roundworms (*Ascaris*), and whipworms (see Table 7.6). Various researchers have reported 59 to 80 worm eggs in sampled liters of sewage. This suggests that billions of pathogenic worm eggs may reach an average wastewater treatment plant daily. These eggs tend to be resistant to environmental conditions due to a thick outer covering,¹⁸ and they are extremely resistant to the sludge digestion process common in wastewater treatment plants. Three months exposure to anaerobic sludge digestion processes appears to have little effect on the viability of *Ascaris* eggs; after six months, 10% of the eggs may still be viable. Even after a year in sludge, some viable eggs may be found.¹⁹ In 1949, an epidemic of roundworm infestation in Germany was directly traced to the use of raw sewage to fertilize gardens. The sewage contained 540 *Ascaris* eggs per 100 ml, and over 90% of the population became infected.²⁰

If there are about 59 to 80 worm eggs in a liter sample of sewage, then we could reasonably estimate that there are 70 eggs per liter, or 280 eggs per gallon to get a rough average. That means approximately 280 pathogenic worm eggs per gallon of wastewater enter wastewater treatment plants. My local wastewater treatment plant serves a population of eight thousand people and collects about 1.5 million gallons of wastewater daily. That means there could be 420 million worm eggs entering the plant each day and settling into the sludge. In a year's time, over 153 *billion* parasitic eggs can pass through my local small-town wastewater facility. Let's look at the worst-case scenario: all the eggs survive in the sludge because they're resistant to the environmental conditions at the plant. During the year, 30 tractor-trailer loads of sludge are hauled out of the local facility. Each truckload of sludge could theoretically contain over 5 *billion* pathogenic worm eggs, en route to maybe a farmer's field, but probably a landfill.

It is interesting to note that roundworms co-evolved over millennia as parasites of the human species by taking advantage of the long-standing human habit of defecating on soil. Since roundworms live in the human intestines, but require a period in the soil for their development, their species is perpetuated by our bad habits. If we humans never allowed our excrement to come in contact with soil, and if we instead thermophilically composted it, the parasitic species known as *Ascaris lumbricoides*, a parasite that has plagued us for perhaps hundreds of thousands of years, would soon become extinct. The human species is finally evolving to the extent that we are beginning to understand compost and its ability to destroy parasites. We need to take that a step further and entirely prevent our excrement from polluting the environment. Otherwise, we will continue to be outsmarted by the parasitic worms that rely on our ignorance and carelessness for their own survival.

INDICATOR PATHOGENS

Indicator pathogens are pathogens whose detectable occurrence in soil or water serves as evidence that fecal contamination exists.

The astute reader will have noticed that many of the pathogenic worms listed in Table 7.6 are not found in the United States. Of those that are, the *Ascaris lumbricoides* (roundworm) is the most persistent, and can serve as an indicator for the presence of pathogenic helminths in the environment.

A single female roundworm may lay as many as 27 million eggs in her lifetime.²¹ These eggs are protected by an outer covering that is resistant to chemicals and enables the eggs to remain viable in soil for long periods of time. The egg shell is made of five separate layers: an outer and inner membrane, with three tough layers in between. The outer membrane may become partially hardened by hostile environmental influences.²² The reported viability of roundworm eggs (*Ascaris ova*) in soil ranges from a couple of weeks under sunny, sandy conditions,²³ to two and a half years,²⁴ four years,²⁵ five and a half years,²⁶ or even ten years²⁷ in soil, depending on the source of the information. Consequently, the *eggs* of the roundworm seem to be the best indicator for determining if parasitic worm pathogens are present in compost. In China, current standards for the agricultural reuse of humanure require an *Ascaris* mortality of greater than 95%.

Ascaris eggs develop at temperatures between 15.5°C (59.90° F) and 35°C (95° F), but the eggs disintegrate at temperatures above 38°C (100.40° F).²⁸ The temperatures generated during thermophilic composting can easily exceed levels necessary to destroy roundworm eggs.

One way to determine if the compost you're using is contaminated with viable roundworm eggs is to have a stool analysis done at a local hospital. If your compost is contaminated and you're using the compost to grow your own food, then there will be a chance that you've contaminated yourself. A stool analysis will reveal whether that is the case or not. Such an analysis cost about \$41.00 in Pennsylvania (USA) in 1993, and \$33 in 1999. I subjected myself to two stool examinations over a period of two years as part of the research for this book. I had been composting humanure for fifteen years at the time of the testings, and I had used all of the compost in my food gardens. Hundreds of other people had also used my toilet over the years, potentially contaminating it with *Ascaris*. Yet, both stool examinations were completely negative.

Indicator bacteria include fecal coliforms, which reproduce in the intestinal systems of warm blooded animals (see Table 7.7). If one wants to test a water supply for fecal contamination, then one looks for fecal coliforms, usually *Escherichia coli*. *E. coli* is one of the most abundant intestinal bacteria in humans; over 200 specific types exist. Although some of them can cause disease, most are harmless.²⁹ The absence of *E. coli* in water indicates that the water is free from fecal contamination.

Water tests often determine the level of *total coliforms* in the water, reported as the number of coliforms per 100 ml. Such a test measures *all* species of the coliform group and is not limited to species originating in warm-blooded animals. Since some coliform species come from the soil, the results of this test are not always indicative of fecal contamination in a stream analysis. However, this test can be used for ground water supplies, as no coliforms should be present in ground water unless it has been contaminated by a warm-blooded animal.

Fecal coliforms do not multiply outside the intestines of warm-blooded animals, and their presence in water is unlikely unless there is fecal pollution. They survive for a shorter time in natural waters than the coliform group as a whole, therefore their presence indicates relatively recent pollution. In domestic sewage, the fecal coliform count is usually 90% or more of the total coliform count, but in natural

streams, fecal coliforms may contribute 10-30% of the total coliform density. Almost all natural waters have a presence of fecal coliforms, since all warm-blooded animals excrete them. Most states in the U.S. limit the fecal coliform concentration allowable in waters used for water sports to 200 fecal coliforms per 100 ml.

Bacterial analyses of drinking water supplies are routinely provided for a small fee (in 1994 around \$20.00) by agricultural supply firms, water treatment companies, or private labs.

PERSISTENCE OF PATHOGENS IN SOIL, CROPS, MANURE, AND SLUDGE

According to Feachem et al. (1980), the persistence of fecal pathogens in the environment can be summarized as follows:

IN SOIL

Survival times of pathogens in soil are affected by soil moisture, pH, type of soil, temperature, sunlight, and organic matter. Although fecal coliforms can survive for several years under optimum conditions, a 99% reduction is likely within 25 days in warm climates (see Figure 7.1). *Salmonella* bacteria may survive for a year in rich, moist, organic soil, although 50 days would be a more typical survival time. Viruses can survive up to three months in warm weather, and up to six months in cold. Protozoan cysts are unlikely to survive for more than ten days. Roundworm eggs can survive for several years.

The viruses, bacteria, protozoa, and worms that can be passed in human excrement all have limited survival times outside of the human body. Let's take a look at their survival times when deposited raw into soil (refer to Tables 7.8 through 7.12).

SURVIVAL OF PATHOGENS ON CROPS

Bacteria and viruses cannot penetrate undamaged vegetable skins. Furthermore, pathogens are not taken up in the roots of plants and transported to other portions of the plant.³⁰ However, pathogens can survive on the surfaces of vegetables, especially root vegetables. Sunshine and low air humidity will promote the death of pathogens. Viruses can survive up to two months on crops but usually live less than one month. Indicator bacteria may persist several months, but usually only last less than one month. Protozoan cysts usually survive less than two days, and worm eggs usually last less than one month. In studies of the survival of *Ascaris* eggs on lettuce and tomatoes during a hot, dry summer, all eggs degenerated enough after 27 to 35 days to be incapable of infection.³¹

Lettuce and radishes in Ohio sprayed with sewage inoculated with Poliovirus I showed a 99% reduction in pathogens after six days; 100% were eliminated after 36 days. Radishes grown outdoors in soil fertilized with fresh typhoid-contaminated feces four days after planting showed a pathogen survival period of less than 24 days. Tomatoes and lettuce contaminated with a suspension of roundworm eggs showed a 99% reduction in eggs in 19 days and a 100% reduction in four weeks. These tests indicate that

if there is any doubt about pathogen contamination of compost, the compost should be applied to long-season crops at the time of planting so that sufficient time ensues for the pathogens to die before harvest.

PATHOGEN SURVIVAL IN SLUDGE AND FECES/URINE

Viruses can survive up to five months, but usually less than three months in sludge and night soil. Indicator bacteria can survive up to five months, but usually less than four months. Salmonellae survive up to five months, but usually less than one month. Tubercle bacilli survive up to two years, but usually less than five months. Protozoan cysts survive up to one month, but usually less than ten days. Worm eggs vary depending on species, but roundworm eggs may survive for many months.

PATHOGEN TRANSMISSION THROUGH VARIOUS TOILET SYSTEMS

It is evident that human excrement possesses the capability to transmit various diseases. For this reason, it should also be evident that the composting of humanure is a serious undertaking and should not be done in a frivolous, careless, or haphazard manner. The pathogens that may be present in humanure have various survival periods outside the human body and maintain varied capacities for re-infecting people. This is why the *careful management* of a thermophilic compost system is important. Nevertheless, there is no proven, natural, low-tech method for destroying human pathogens in organic refuse that is as successful and accessible to the average human as well-managed thermophilic composting.

But what happens when the compost is not well-managed? How dangerous is the undertaking when those involved do not make an effort to ensure that the compost maintains thermophilic temperatures? In fact, this is normally what happens in most owner-built and commercial composting toilets. Thermophilic composting does not occur in owner-built toilets because the people responsible often make no effort to create the organic blend of ingredients and the environment needed for such a microbial response. In the case of most commercial composting toilets, thermophilic composting is not even intended, as the toilets are designed to be dehydrators rather than thermophilic composters.

On several occasions, I have seen simple collection toilet systems (sawdust toilets) in which the compost was simply dumped in an outdoor pile, not in a bin, lacking urine (and thereby moisture), and not layered with the coarse organic material needed for air entrapment. Although these piles of compost did not give off unpleasant odors (most people have enough sense to instinctively cover odorous organic material in a compost pile), they also did not necessarily become thermophilic (their temperatures were never checked). People who are not very concerned about working with and managing their compost are usually willing to let the compost sit for years before use, if they use it at all. Persons who are casual about their composting tend to be those who are comfortable with their own state of health and therefore do not fear their own excrement. As long as they are combining their humanure with a carbonaceous material and letting it compost, thermophilically or not, for at least a year (an additional year of aging is recommended), they are very unlikely to be creating any health problems, despite the rantings of fecophobes. What happens to these casually constructed compost piles? Incredibly, after a couple of years, they turn into quite lovely humus and, if left entirely alone, will simply become covered with

vegetation and disappear back into the earth. I have seen it with my own eyes.

A different situation occurs when humanure from a highly pathogenic population is being composted. Such a population would be the residents of a hospital in an underdeveloped country, for example, or any residents in a community where certain diseases or parasites are endemic. In that situation, the composter must make every effort necessary to ensure thermophilic composting, adequate aging time, and total pathogen destruction.

The following information illustrates the various waste treatment methods and composting methods commonly used today and shows the transmission of pathogens through the individual systems.

OUTHOUSES AND PIT LATRINES

Outhouses have odor problems, breed flies and possibly mosquitoes, and pollute groundwater. However, if the contents of a pit latrine have been filled over and left for a minimum of one year, there will be no surviving pathogens except for the possibility of roundworm eggs, according to Feachem. This risk is small enough that the contents of pit latrines, after twelve months burial, can be used agriculturally. Franceys et al. state, “*Solids from pit latrines are innocuous if the latrines have not been used for two years or so, as in alternating double pits.*” [32](#)

SEPTIC TANKS

It is safe to assume that septic tank effluents and sludge are highly pathogenic (see Figure 7.2). Viruses, parasitic worm eggs, bacteria, and protozoa can be emitted from septic tank systems in viable condition.

CONVENTIONAL SEWAGE TREATMENT PLANTS

The only sewage digestion process producing a guaranteed pathogen-free sludge is batch thermophilic digestion in which all of the sludge is maintained at 50°C (122°F) for 13 days. Other sewage digestion processes will allow the survival of worm eggs and possibly pathogenic bacteria. Typical sewage treatment plants instead use a continuous process where wastewater is added daily or more frequently, thereby guaranteeing the survival of pathogens (see Figure 7.3).

I took an interest in my local wastewater treatment plant when I discovered that the water in our local creek below the wastewater discharge point had ten times the level of nitrates that unpolluted water has, and three times the level of nitrates acceptable for drinking water.[33](#) In other words, the water being discharged from the water treatment plant was polluted. We knew the pollution included high levels of nitrates, although we didn’t test for pathogens or chlorine levels. Despite the pollution, the nitrate levels were within legal limits for wastewater discharges.

WASTE STABILIZATION PONDS

Waste stabilization ponds, or lagoons, large shallow ponds widely used in North America, Latin America, Africa and Asia, involve the use of both beneficial bacteria and algae in the decomposition of organic waste materials. Although they can breed mosquitoes, they can be designed and managed well enough to yield pathogen-free waste water. However, they typically yield water with low concentrations of both pathogenic viruses and bacteria (see Figure 7.4).

COMPOSTING TOILETS AND MOULDERING TOILETS

Most mouldering and commercial composting toilets are relatively anaerobic and compost at a low temperature. According to Feachem et al., a minimum retention time of three months produces a compost free of all pathogens except possibly some intestinal worm eggs. The compost obtained from these types of toilets can theoretically be composted again in a thermophilic pile and rendered suitable for food gardens (see Figure 7.5 and Table 7.14). Otherwise, the compost can be moved to an outdoor compost bin, layered and covered with straw (or other bulky organic material such as weeds or leaf mould), moistened, and left to age for an additional year or two in order to destroy any possible lingering pathogens. Microbial activity and earthworms will aid in the sanitation of the compost over time.

WELL-MANAGED THERMOPHILIC COMPOSTING SYSTEM

Complete pathogen destruction is guaranteed by arriving at a temperature of 62°C (143.6°F) for one hour, 50°C (122°F) for one day, 46°C (114.8°F) for one week, or 43°C (109.4°F) for one month. It appears that no excreted pathogen can survive a temperature of 65°C (149°F) for more than a few minutes. A compost pile containing entrapped oxygen may rapidly rise to a temperature of 55°C (131°F) or above, or will maintain a temperature hot enough for a long enough period of time to thoroughly destroy human pathogens that may be in the humanure (see Figure 7.6). Furthermore, pathogen destruction is aided by microbial diversity, as discussed in Chapter 3. Table 7.14 indicates survival times of pathogens in a) soil, b) anaerobic decomposition conditions, c) composting toilets, and d) thermophilic compost piles.

MORE ON PARASITIC WORMS

This is a good subject to discuss in greater detail as it is rarely a topic of conversation in social circles, yet it is important to those who are concerned about potential pathogens in compost. Therefore, let's look at the most common of human worm parasites: pinworms, hookworms, whipworms, and roundworms.

PINWORMS

A couple of my kids had pinworms at one time during their childhood. I know exactly who they got them from (another kid), and getting rid of them was a simple matter. However, the rumor was circulated that they got them from our compost. We were also told to worm our cats to prevent pinworms in the kids (these rumors allegedly originated in a doctor's office). Yet, the pinworm life cycle does not include a stage in soil, compost, manure, or cats. These unpleasant parasites are spread from human to human by

direct contact, and by inhaling eggs.

Pinworms (*Enterobius vermicularis*) lay microscopic eggs at the anus of a human being, its only known host. This causes itching at the anus which is the primary symptom of pinworm infestation. The eggs can be picked up almost anywhere; once in the human digestive system they develop into the tiny worms. Some estimate that pinworms infest or have infested 75% of all New York City children in the three to five year age group, and that similar figures exist for other cities.³⁴

These worms have the widest geographic distribution of any of the worm parasites, and are estimated to infect 208.8 million people in the world (18 million in Canada and the U.S.). An Eskimo village was found to have a 66% infection rate; a 60% rate has been found in Brazil, and a 12% to 41% rate was reported in Washington D.C.

Infection is spread by the hand to mouth transmission of eggs resulting from scratching the anus, as well as from breathing airborne eggs. In households with several members infected with pinworms, 92% of dust samples contained the eggs. The dust samples were collected from tables, chairs, baseboards, floors, couches, dressers, shelves, window sills, picture frames, toilet seats, mattresses, bath tubs, wash basins and bed sheets. Pinworm eggs have also been found in the dust from school rooms and school cafeterias. Although dogs and cats do not harbor pinworms, the eggs can get on their fur and find their way back to their human hosts. In about one-third of infected children, eggs may be found under the fingernails.

Pregnant female pinworms contain 11,000 to 15,000 eggs. Fortunately, pinworm eggs don't survive long outside their host. Room temperature with 30% to 54% relative humidity will kill off more than 90% of the eggs within two days. At higher summer temperatures, 90% will die within three hours. Eggs survive longest (two to six days) under cool, humid conditions; in dry air, none will survive for more than 16 hours.

A worm's life span is 37-53 days; an infection would self-terminate in this period, without treatment, in the absence of reinfection. *The amount of time that passes from ingestion of eggs to new eggs being laid at the anus ranges from four to six weeks.*³⁵

In 95% of infected persons, pinworm eggs aren't found in the feces. Transmission of eggs to feces and to soil is not part of the pinworm life cycle, which is one reason why the eggs aren't likely to end up in either feces or compost. Even if they do, they quickly die outside the human host.

One of the worst consequences of pinworm infestation in children is the trauma of the parents, whose feelings of guilt, no matter how clean and conscientious they may be, are understandable. However, if you're composting your manure, you can be sure that you are not thereby breeding or spreading pinworms. Quite the contrary, any pinworms or eggs getting into your compost are being destroyed.³⁶

HOOKWORMS

Hookworm species in humans include *Necator americanus*, *Ancylostoma duodenale*, *A. braziliense*, *A. caninum*, and *A. ceylanicum*.

These small worms are about a centimeter long, and humans are almost the exclusive host of *A. duodenale* and *N. americanus*. A hookworm of cats and dogs, *A. caninum*, is an extremely rare intestinal parasite of humans.

The eggs are passed in the feces and mature into larvae outside the human host in favorable conditions. The larvae attach themselves to the human host usually at the bottom of the foot when they're walked on, and then enter their host through pores, hair follicles, or even unbroken skin. They tend to migrate to the upper small intestine where they suck their host's blood. Within five or six weeks, they'll mature enough to produce up to 20,000 eggs per day.

Hookworms are estimated to infect 500 million people throughout the world, causing a daily blood loss of more than 1 million liters, which is as much blood as can be found in all the people in the city of Erie, PA, or Austin, TX. An infection can last two to fourteen years. Light infections can produce no recognizable symptoms, while a moderate or heavy infection can produce an iron deficiency anemia. Infection can be determined by a stool analysis.

These worms tend to be found in tropical and semi-tropical areas and are spread by defecating on the soil. Both the high temperatures of composting and the freezing temperatures of winter will kill the eggs and larvae (see Table 7.16). Drying is also destructive.³⁷

WHIPWORM

Whipworms (*Trichuris trichiura*) are usually found in humans, but also may be found in monkeys or hogs. They're usually under two inches long and the female can produce 3,000 to 10,000 eggs per day. Larval development occurs outside the host, and in a favorable environment (warm, moist, shaded soil), first stage larvae are produced from eggs in three weeks. The lifespan of the worm is usually considered to be four to six years.

Hundreds of millions of people worldwide, as much as 80% of the population in certain tropical countries, are infected by whipworms. In the US, whipworms are found in the south where heavy rainfall, a subtropical climate, and feces-contaminated soil provide a suitable habitat.

Persons handling soil that has been defecated on by an infected person risk infection by hand-to-mouth transmission. Infection results from ingestion of the eggs. Light infections may not show any symptoms. Heavy infections can result in anemia and death. A stool examination will determine if there is an infection.

Cold winter temperatures of -8°C to -12°C (17.6°F to 10.4°F) are fatal to the eggs, as are the high temperatures of thermophilic composting.³⁸

ROUNDWORMS

Roundworms (*Ascaris lumbricoides*) are fairly large worms (10 inches in length) which parasitize the human host by eating semi-digested food in the small intestine. The females can lay 200,000 eggs per day for a lifetime total of 26 million or so. Larvae develop from the eggs *in soil* under favorable conditions (21°C to 30°C / 69.8°F to 86°F). Above 37°C (98.6°F), they cannot fully develop.

Approximately 900 million people are infected with roundworms worldwide, one million in the US. The eggs are usually transmitted hand to mouth by people, usually children, who have come into contact with the eggs in their environment. Infected persons usually complain of a vague abdominal pain. Diagnosis is by stool analysis.³⁹ An analysis of 400,000 stool samples throughout the US by the Center for Disease Control found *Ascaris* in 2.3% of the samples, with a wide fluctuation in results depending on the geographical location of the person sampled. Puerto Rico had the highest positive sample frequency (9.3%), while samples from Wyoming, Arizona, and Nevada showed no incidence of *Ascaris* at all.⁴⁰ In moist tropical climates, roundworm infection may afflict 50% of the population.⁴¹

Eggs are destroyed by direct sunlight within 15 hours, and are killed by temperatures above 40°C (104°F), dying within an hour at 50°C (122°F). Roundworm eggs are resistant to freezing temperatures, chemical disinfectants, and other strong chemicals, but thermophilic composting will kill them.

Roundworms, like hookworms and whipworms, are spread by fecal contamination of soil. Much of this contamination is caused and spread by children who defecate outdoors within their living area. One sure way to eradicate fecal pathogens is to conscientiously collect and thermophilically compost all fecal material. Therefore, it is very important when composting humanure to be certain that all children use the toilet facility and do not defecate elsewhere. When changing soiled diapers, deposit the fecal material into the humanure receptacle with toilet paper or another biodegradable material. It's up to adults to keep an eye on kids and make sure they understand the importance of *always using a toilet facility*.

Fecal environmental contamination can also be caused by using raw fecal material for agricultural purposes. *Proper thermophilic composting of all fecal material is essential for the eradication of fecal pathogens.*

TEMPERATURE AND TIME

There are two primary factors leading to the death of pathogens in humanure. The first is *temperature*. A compost pile that is properly managed will destroy pathogens with the heat it generates.

The second factor is *time*. The lower the temperature of the compost, the longer the subsequent retention time needed for the destruction of pathogens. Given enough time, the wide biodiversity of microorganisms in the compost will destroy pathogens by the antagonism, competition, consumption, and antibiotic inhibitors provided by the beneficial microorganisms. Feachem et al. state that three

months retention time will kill all of the pathogens in a low-temperature composting toilet except worm eggs, although Table 7.14 (also from Feachem) indicates that some additional pathogen survival may occur.

A thermophilic compost pile will destroy pathogens, including worm eggs, quickly, possibly in a matter of minutes. Lower temperatures require longer periods of time, possibly hours, days, weeks, or months, to effectively destroy pathogens. One need not strive for extremely high temperatures such as 65°C (150°F) in a compost pile to feel confident about the destruction of pathogens. It may be more realistic to maintain lower temperatures in a compost pile for longer periods of time, such as 50°C (122°F) for 24 hours, or 46°C (115°F) for a week. According to one source, “*All fecal microorganisms, including enteric viruses and roundworm eggs, will die if the temperature exceeds 46°C (114.8°F) for one week.*”⁴² Other researchers have drawn similar conclusions, demonstrating pathogen destruction at 50°C (122°F), which produced compost “completely acceptable from the general hygienic point of view.”⁴³

A sound approach to pathogen destruction when composting humanure is to thermophilically compost the organic refuse, then allow the compost to sit, undisturbed, for a lengthy period of time after the thermophilic heating stage has ended. The biodiversity of the compost will aid in the destruction of pathogens as the compost ages. If one wants to be particularly cautious, one may allow the compost to age for two years after the pile has been built, instead of the one year that is normally recommended.

In the words of Feachem et al., “*The effectiveness of excreta treatment methods depends very much on their time-temperature characteristics. The effective processes are those that either make the excreta warm (55°C/131°F), hold it for a long time (one year), or feature some effective combination of time and temperature.*” The time/temperature factor of pathogen destruction is illustrated in Figure 7.7.

In short, the combined factors of temperature and time will do the job of “turning turds into tomatoes.”

CONCLUSIONS

Humanure is a valuable resource suitable for agricultural purposes and has been recycled for such purposes by large segments of the world’s human population for thousands of years.

However, humanure contains the potential for harboring human pathogens, including bacteria, viruses, protozoa, and parasitic worms or their eggs, and thereby can contribute to the spread of disease when improperly managed or when discarded as a waste material. When pathogenic raw humanure is applied to soil, pathogenic bacteria may continue to survive in the soil for over a year, and roundworm eggs may survive for many years, thereby maintaining the possibility of human reinfection for lengthy periods of time.

However, when humanure is *thermophilically* composted, human pathogens are rapidly destroyed, and the humanure is thereby converted into a hygienically safe form, suitable for soil applications for the purpose of human food production.

Thermophilic composting requires no electricity and therefore no coal combustion, no acid rain, no nuclear power plants, no nuclear waste, no petrochemicals, and no consumption of fossil fuels. The composting process produces no waste, no pollutants, and no toxic by-products. Thermophilic composting of humanure can be carried out century after century, millennium after millennium, with no stress on our ecosystems, no unnecessary consumption of resources, and no garbage or sludge for our landfills. And all the while it will produce a valuable resource necessary for our survival while preventing the accumulation of dangerous and pathogenic waste. If that doesn't describe *sustainability*, nothing does.

Source: The Humanure Handbook. Jenkins Publishing, PO Box 607, Grove City, PA 16127. To order, phone: 1-800-639-4099.

<http://www.jenkinspublishing.com/>

MENU: [HOME](#) » [Reconstruction](#) » [Recovery](#) » [Renewal](#) » [Survival](#) » [Humanure Content](#)

MENU: [HOME](#) » [Reconstruction](#) » [Recovery](#) » [Renewal](#) » [Survival](#) » [Humanure Content](#)

THE TAO OF COMPOST

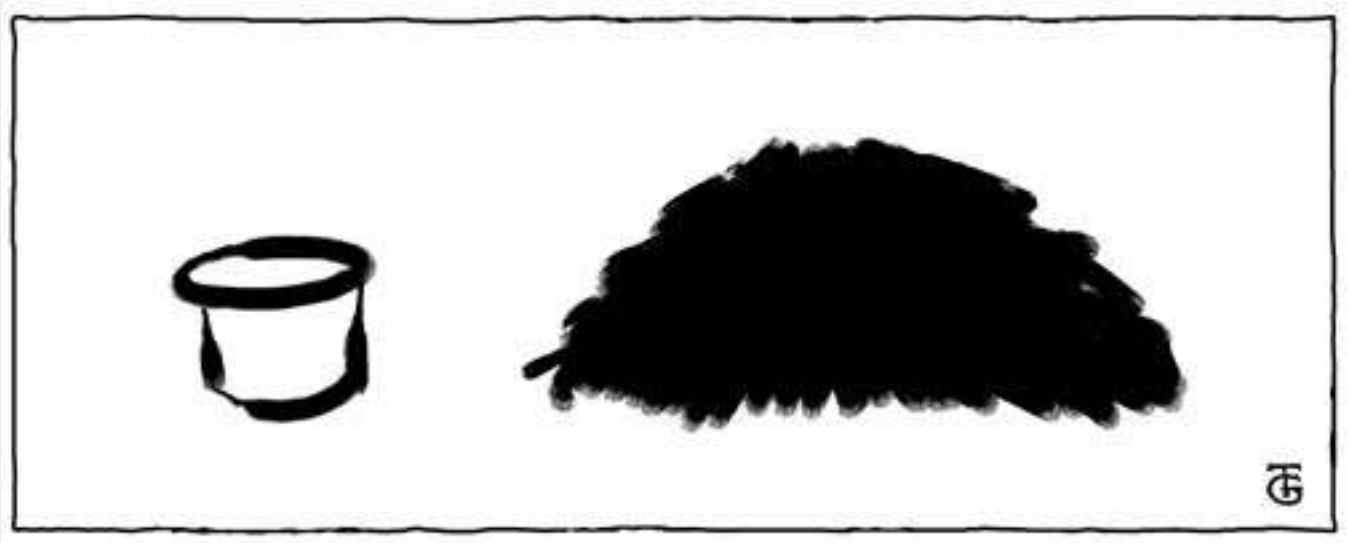

"Aspire to simple living? That means, aspire to fulfill the highest human destiny."

Charles Wagner

Organic material should be recycled by every person on the planet, and recycling should be as normal and integral to daily life as brushing teeth or bathing. Organic materials can be collected by municipalities and composted at central composting facilities. This is now done in many parts of the world where food scraps are composted for urban communities. Toilet materials are not yet being collected and centrally composted in very many places, although such collection will undoubtedly increase as time passes.

However, people can compost their own organic material in their own personal compost bins, in their own backyards. This is already becoming commonplace, and compost bins are now popping up in backyards everywhere like mushrooms after a rain. Composting need not cost money, and it can be practiced by anyone in the world at probably any location where plants can grow. Therefore, it is important that people everywhere learn to understand what compost is and how it can be made.

It is also important that we understand how to compost our toilet materials in a safe and simple manner. A low-cost composting toilet system can be very useful as a back-up toilet in an emergency situation when electrical or water services are disrupted, or when the water supply is diminished as during a

drought, when flushing drinking water down toilets becomes especially ridiculous. It can also be very useful in any area where water or electricity is scarce or non-existent, as well as in developing countries where there may be many people with little or no money to buy commercial composting toilets. Finally, a simple, low-cost composting toilet system is attractive to anyone seeking a low-impact lifestyle, and who is willing to make the minimal effort to compost their organic materials. This chapter details how to compost toilet materials by using a simple, easy, low or no-cost method (a sawdust toilet) which my family and I have used for twenty years at the time of this writing.

The organic materials our bodies excrete can be composted much the same as any apple core or potato peel — by being added to a compost pile. There are essentially two ways to do this. The first is to construct or purchase a toilet which deposits directly into a composting chamber. This is discussed and illustrated in Chapter 6. Such toilets must be properly managed if thermophilic conditions are desired; most commercial composting toilets do not achieve such conditions, and are not meant to.

The second, less expensive, and simpler method is to use one's toilet as a collection device, much the same as any compost bucket, and then compost the contents in a separate compost pile on a regular basis. This simple technique can be done without unpleasant odors, and the toilet can be quite comfortably situated inside one's home. Moving toilet material to a compost bin, however, is an activity that many individuals have no interest in doing, usually not because it is a burdensome task (for a family of four it would involve a twenty minute trip to a compost bin about every three days), but because it's *shit*, for god's sake.

A friend of mine who wanted to use a compost toilet once told me she could never carry “a shit bucket” to a compost bin. She just could not do it, she said, shaking her head. I asked her how often she fed her dog, which was chained about a hundred yards from her house. “Every day,” was her reply.

“How is it that you can carry a container of dog food out to your dog, every day, and not a container of soil nutrients to a compost pile once a week?” (A single person only needs to make a trip to a compost bin once a week.) No reply. “If the ‘shit bucket,’ as you call it, were full of roses, would you be able to carry it to a compost pile once a week?”

“Sure.”

“Then why wouldn't you be able to carry a bucket of other organic material?”

Again, no reply. And none needed. The problem is not practical, it is psychological. I understand perfectly that many people consider the idea of composting their own excrement to be beneath them. In India, such a task was relegated to the “untouchables,” the lowest caste of society. The act of carrying a container of one's own excrement to a recycling bin is an act of humility, and humility is sometimes in short supply. Eventually, toilets in general will be redesigned as collection devices and their contents will be collected and composted as a service by municipal workers. Until then, however, those of us who want to make compost rather than sewage must do it by our own humble selves.

I will never forget the day I introduced a close relative to my composting system. She came to visit me at my newly established homestead one spring day and I gave her a tour of my garden, which was already quite vibrant. A fresh pile of aged compost had been dumped from a wheelbarrow onto one of the raised garden beds and, as we passed, I reached down and scooped up a big handful, thrusting it toward her face. "Smell this," I said. So she put her nose right up to the black earth I held out before me and took a deep breath.

"Boy, that smells good!" she said, inhaling the rich, sweet-smelling aroma of fertile soil, and smiling.

"*This is my alternative to a septic system,*" I proudly informed her, still holding the compost out in front of me as I watched her smile freeze. I will always remember that shocked look on her face, cloaked behind a huge smile. My friend, although very open-minded, had not, prior to that moment, had the experience of so intimately communing with composted humanure. The compost did smell and look wonderful, if I have to say so myself, just like a rich soil from the woods, and I was *proud* of it.

People ask me when I'm going to install a septic system, as if composting is a phase you go through until you become mature and civilized enough to use a flush toilet. Others take one look at my compost toilet and say things like "*I respect the way you're living, but I could never do it.*" Well, I could install a septic system, as I have running water and electricity (when I started using a composting toilet system I lived "off the grid," without electricity, and did so for a period of twelve years). However, a septic system would create environmental pollution and threaten the quality of my ground water, which I drink. It is a *waste disposal* system, collecting and storing waste and allowing the waste to slowly seep into the environment. I'd much rather engage in resource recovery instead of waste disposal, however unfashionable. My compost is my reward — it helps me to grow my food, and that's too valuable for me to be willing to sacrifice.

Source: The Humanure Handbook. Jenkins Publishing, PO Box 607, Grove City, PA 16127. To order, phone: 1-800-639-4099.

<http://www.jenkinspublishing.com/>

MENU: [HOME](#) » [Reconstruction](#) » [Recovery](#) » [Renewal](#) » [Survival](#) » [Humanure Content](#)

MENU: [HOME](#) » [Reconstruction](#) » [Recovery](#) » [Renewal](#) » [Survival](#) » [Humanure Content](#)

ALTERNATIVE GREY WATER SYSTEMS

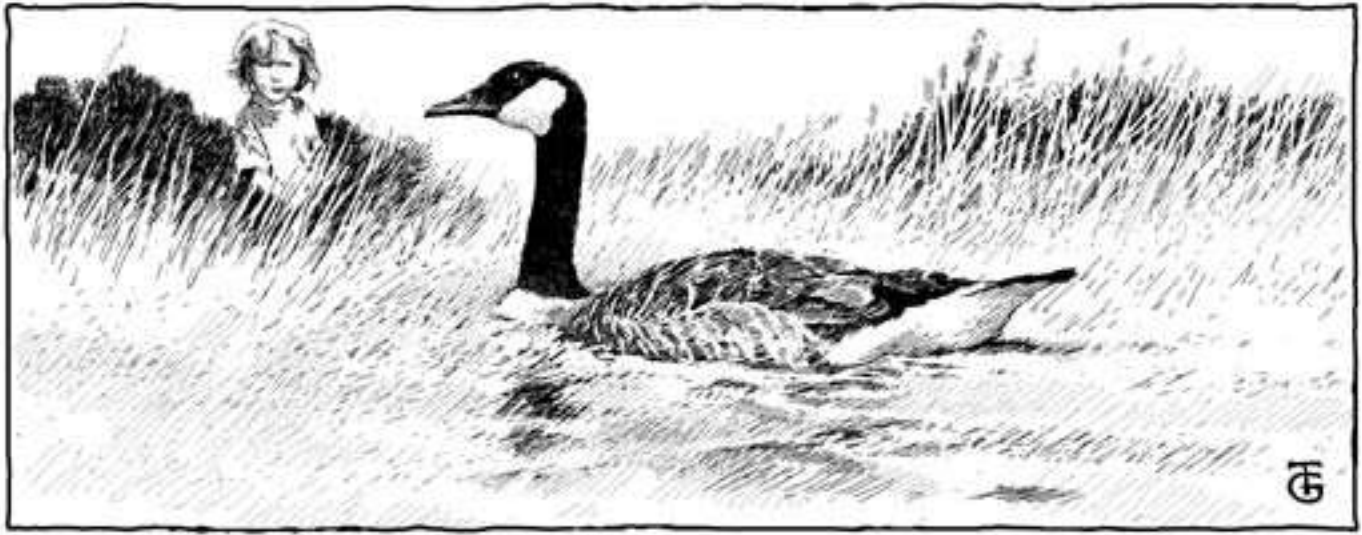

“When dealt with appropriately, graywater is a valuable resource which horticultural and agricultural growers, as well as home gardeners, will increasingly come to appreciate.”

Carl Lindstrom

There are two concepts that sum up this book: 1) one organism’s excretions are another organism’s food, and 2) there is no waste in nature. We humans need to understand what organisms will consume our excretions if we are to live in greater harmony with the natural world. Our excretions include humanure, urine, and *other* organic materials that we discharge into the environment, such as “graywater,” which is the water resulting from washing or bathing. Graywater should be distinguished from “blackwater,” the water that comes from toilets. Graywater contains recyclable organic materials such as nitrogen, phosphorous, and potassium. These materials are pollutants when discarded into the environment. When responsibly recycled, however, they can be beneficial nutrients.

My first exposure to an “alternative” wastewater system occurred on the Yucatan Peninsula of Mexico in 1977. At that time, I was staying in a tent on a primitive, isolated, beach-front property lined with coconut palms and overlooking the turquoise waters and white sands of the Caribbean. My host operated a small restaurant with a rudimentary bathroom containing a toilet, sink, and shower, primarily reserved for tourists who paid to use the room. The wastewater from this room drained from a pipe, through the

wall, and directly into the sandy soil outside, where it ran down an inclined slope out of sight behind the thatched pole building. I first noticed the drain not because of the odor (there wasn't any that I can remember), but because of the thick growth of tomato plants that cascaded down the slope where the drain was located. I asked the owner why he would plant a garden in such an unlikely location, and he replied that he didn't plant it at all — the tomatoes were volunteers; the seeds sprouted from human excretions. He admitted that whenever he needed a tomato, he didn't have to go far to get one. This is not an example of sanitary wastewater recycling, but it is an example of how wastewater can be put to constructive use, even by accident.

From there, I traveled to Guatemala, where I noticed a similar wastewater system, again at a crude restaurant at an isolated location in the Peten jungle. The restaurant's wastewater drain irrigated a small section of the property separate from the camp sites and other human activities, but plainly visible. That section had the most luxurious growth of banana plants I had ever seen. Again, the water proved to be a resource useful in food production, and in this case, the luxurious growth added an aesthetic quality to the property, appearing as a lush tropical garden. The restaurant owner liked to show off his "garden," admitting that it was largely self-planted and self-perpetuating. "That's the value of drain water," he was quick to point out, and its value was immediately apparent to anyone who looked.

All wastewater contains organic materials, such as food remnants and soap. Microorganisms, as well as plants and macroorganisms, consume these organic materials and convert them into beneficial nutrients. In a sustainable system, wastewater is made available to natural organisms for their benefit. Recycling organic materials through living organisms naturally purifies water.

In the US, the situation is quite different. Household wastewater typically contains all the water from toilet flushings (blackwater) as well as water from sink, bathtub, and washing machine drains (graywater). To complicate this, many households have in-sink garbage disposals. These contraptions grind up all of the organic food material that could otherwise be composted, then eject it out into the drain system. Government regulators assume the worst case scenario for household wastewater (lots of toilet flushings, lots of baby diapers in the wash, and lots of garbage in the disposal unit), then they draft regulations to accommodate this scenario. Wastewater is considered a public health hazard which must be quarantined from human contact. Typically, the wastewater is required to go directly into a sewage system, or, in suburban and rural locations, into a septic system.

A septic system generally consists of a concrete box buried underground into which household wastewater is discharged. When the box fills and overflows, the effluent drains into perforated pipes that allow the water to percolate into the soil. The drain field is usually located deep enough in the soil that surface plants cannot access the water supply.

In short, conventional drainage systems isolate wastewater from natural systems, making the organic material in the water unavailable for recycling. At wastewater treatment plants (sewage plants), the organic material in the wastewater is removed using complicated, expensive procedures. Despite the high cost of such separation processes, the organic material removed from the wastewater is often buried in a

landfill.

The alternatives should be obvious. Albert Einstein once remarked that the human race will require an entirely new manner of thinking if it is to survive. I am inclined to agree. Our “waste disposal” systems must be rethought. As an alternative to our current throw-away mentality, we can understand that organic material is a resource, rather than a waste, that can be beneficially recycled using natural processes.

In pursuing this alternative, the first step is to *recycle* as much organic material as possible, keeping it away from waste disposal systems altogether. We can eliminate all blackwater from our drains by composting all human manure and urine. We can also eliminate almost all other organic material from our drains by composting food scraps. As such, one should never use an in-sink garbage disposal. As an indication of how much organic material typically goes down a household drain, consider the words of one composting toilet manufacturer, “*New regulations will soon demand that septic tanks receiving flush toilet and garbage disposal wastes be pumped out and documented by a state certified septage hauler every three years. When toilet and garbage solids and their associated flush water is removed from the septic system, and the septic tank is receiving only graywater, the septic tank needs pumping only every twenty years.*”¹ According to the US EPA, household garbage disposals contribute 850% more organic matter and 777% more suspended solids to wastewater than do toilets.²

The second step is to understand that a drain is not a waste disposal site; it should *never* be used to dump something to “get rid of it.” This has unfortunately become a bad habit for many Americans. As an example, a friend was helping me process some of my home-made wine. The process created five gallons of spent wine as a by-product. When I had my back turned, the fellow dumped the liquid down the sink drain. I found the empty bucket and asked what happened to the liquid that had been in it. “I dumped it down the sink,” he said. I was speechless. Why would anyone dump five gallons of food-derived liquid down a sink drain? But I could see why. My friend considered a drain to be a waste disposal site, as do most Americans. This was compounded by the fact that he had *no idea* what to do with the liquid otherwise. My household effluent drains directly into a constructed wetland which consists of a graywater pond. Because anything that goes down that drain feeds a natural aquatic system, I am quite particular about what enters the system. I keep all organic material out of the system, except for the small amount that inevitably comes from dishwashing and bathing. All food scraps are composted, as are grease, fats, oils, and every other bit of organic food material our household produces (every food item compost educators tell you “not to compost” ends up down a drain or in a landfill otherwise, which is foolish; in our household, it all goes into the compost). This recycling of organic material allows for a relatively clean graywater that can be easily remediated by a constructed wetland, soilbed, or irrigation trench. The thought of dumping something down my drain simply to dispose of it just doesn’t fit into my way of thinking. So I instructed my friend to pour any remaining organic liquids onto the compost pile. Which he did. I might add that this was in the middle of January when things were quite frozen, but the compost pile still absorbed the spent wine. In fact, that winter was the first one in which the active compost pile did not freeze. Apparently, the 30 gallons of liquid we doused it with kept it active enough to generate heat all winter long.

Step three is to eliminate the use of all toxic chemicals and non-biodegradable soaps in one’s household.

Chemicals could find their way down the drains and out into the environment as pollutants. The quantity and variety of toxic chemicals routinely dumped down drains in the US is both incredible and disturbing. We can eliminate a lot of our wastewater problems by simply being careful what we add to our water. Many Americans do not realize that most of the chemicals they use in their daily lives and believe to be necessary are not necessary at all. They can simply be eliminated. This is a fact that will not be promoted on TV or by the government (including schools), because the chemical industry might object. I am quite sure that you, the reader, don't care whether the chemical industry objects or not. Therefore, you willingly make the small effort necessary to find environmentally benign cleaning agents for home use.

Cleaning products that contain boron should not be used with graywater recycling systems because boron is reportedly toxic to most plants. Liquid detergents are better than powdered detergents because they contribute less salts to the system.³ Water softeners may not be good for graywater recycling systems because softened water reportedly contains more sodium than unsoftened water, and the sodium may build up in the soil, to its detriment. Chlorine bleach or detergents containing chlorine should not be used, as chlorine is a potent poison. Drain cleaners, and products that clean porcelain without scrubbing should not be drained into a graywater recycling system.

Step four is to reduce our water consumption altogether, thereby reducing the amount of water issuing from our drains. This can be aided by collecting and using rainwater, and by recycling graywater through beneficial, natural systems.

The "old school" of wastewater treatment, still embraced by most government regulators and many academics, considers water to be a vehicle for the routine transfer of waste from one place to another. It also considers the accompanying organic material to be of little or no value. The "new school," on the other hand, sees water as a dwindling, precious resource that should not be polluted with waste; organic materials are seen as resources that should be constructively recycled. My research for this chapter included reviewing hundreds of research papers on alternative wastewater systems. I was amazed at the incredible amount of time and money that has gone into studying how to clean the water we have polluted with human excrement. In all of the research papers, without exception, the idea that we should simply stop defecating in water is never suggested.

The change from a water polluting, waste-disposal way of life to an environmentally benign, resource-recovery way of life will not occur from the "top down." Many government authorities and scientists take our wasteful, polluting way of life for granted, and even defend it. Those of us who are courageous enough to be different and who insist upon environmentally friendly lifestyles represent the first wave in the emerging lifestyle changes which we must all inevitably embrace. As our numbers increase, our cumulative impact will become more and more significant.

GRAYWATER

"The question of residential water conservation is not one of whether it will occur, but rather a question of how rapidly it will occur."

It is estimated that 42 to 79% of household graywater comes from the bathtub and shower, 5 to 23% from laundry facilities, 10 to 17% from the kitchen sink or dishwasher, and 5 to 6% from the bathroom sink. [By comparison, the flushing of toilets (creating blackwater) constitutes 38 to 45% of all interior water use in the US, and is the single largest use of water indoors. On average, a person flushes a toilet six times a day.^{6]}

Various studies have indicated that the amount of graywater generated per person per day varies from 25 to 45 gallons (96 to 172 liters), or 719 to 1,272 gallons (2,688 to 4,816 liters) per week for a typical family of four.⁴ In California, a family of four may produce 1300 gallons of graywater in a week.⁵ This amounts to nearly a 55 gallon drum filled with sink and bath water by every person every day, which is then drained into a septic or sewage system. This estimate does not include toilet water. Ironically, the graywater we dispose of can still be useful for such purposes as yard, garden, and greenhouse irrigation. Instead, we dump the graywater into the sewers and use drinking water to irrigate our lawns.

Reuse of graywater for landscape irrigation can greatly reduce the amount of drinkable water used during the summer months when landscape water may constitute 50-80% of the water used at a typical home. Even in an arid region, a three person household can generate enough graywater to meet all of their irrigation needs.⁷ In Tucson, Arizona, for example, a typical family of three uses 123,400 gallons of municipal water per year.⁸ It is estimated that 31 gallons of graywater can be collected per person, per day, amounting to almost 34,000 gallons of graywater per year for the same family.⁹ An experimental home in Tucson, known as Casa del Aqua, reduced its municipal water use by 66% by recycling graywater and collecting rainwater. Graywater recycling amounted to 28,200 gallons per year, and rainwater collection amounted to 7,400 gallons per year.¹⁰ In effect, recycled graywater constitutes a “new” water supply by allowing water that was previously wasted to be used beneficially. Water reuse also reduces energy and fossil fuel consumption by requiring less water to be purified and pumped, thereby helping to reduce the production of global warming gases such as carbon dioxide.

Because graywater can be contaminated with fecal bacteria and chemicals, its reuse is prohibited or severely restricted in many states. Since government regulatory agencies do not have complete information about graywater recycling, they assume the worst-case scenario and simply ban its reuse. This is grossly unfair to those who are conscientious about what they put down their drains and who are determined to conserve and recycle water. Graywater experts contend that the health threat from graywater is insignificant. One states, “*I know of no documented instance in which a person in the US became ill from graywater.*”¹¹ Another adds, “*Note that although graywater has been used in California for about 20 years without permits, there has not been one documented case of disease transmission.*”¹² The health risks from graywater reuse can be reduced first by keeping as much organic material and toxic chemicals out of your drains as possible, and second, by filtering the graywater into a constructed wetland, soilbed, or below the surface of the ground so that the graywater does not come into direct human contact, or in contact with the edible portions of fruits and vegetables.

In November of 1994, legislation was passed in California that allowed the use of graywater in single family homes for subsurface landscape irrigation. Many other states do not currently have any legislation regulating graywater ([see Appendix 3](#)). However, many states are now realizing the value of alternative graywater systems and are pursuing research and development of such systems. The US EPA, for example, considers the use of wetlands to be an emerging alternative to conventional treatment processes.

PATHOGENS

Graywater can contain disease organisms which originate from fecal material or urine entering bath, wash, or laundry water. Potential pathogens in fecal material and urine, as well as infective doses, are listed in [Chapter 7](#).

Indicator bacteria such as *E. coli* reveal fecal contamination of the water, as well as the possible presence of other intestinal disease-causing organisms. Fecal coliforms are a pollution indicator. A high count is undesirable and indicates a greater chance of human illness resulting from contact with the graywater. Plant material, soil, and food scraps can contribute to the *total* coliform population, but fecal coliforms indicate that fecal material is also entering the water system. This can come from baby diapers, or just from bathing or showering.

More microorganisms may come from shower and bath graywater than from other graywater sources. Studies have shown that total coliforms and fecal coliforms were approximately ten times greater in bathing water than in laundry water (see Figure 9.1).¹³

One study showed an average of 215 total coliforms per 100 ml and 107 fecal coliforms per 100 ml in laundry water; 1810 total coliforms and 1210 fecal coliforms per 100 ml in bath water; and 18,800,000 colony forming units of total coliforms per 100 ml in graywater containing household garbage (such as when a garbage disposal is used).¹⁴ Obviously, grinding and dumping food waste down a drain greatly increases the bacterial population of the graywater.

Due to the undigested nature of the organic material in graywater, microorganisms can grow and reproduce in the water during storage. The numbers of bacteria can actually increase in graywater within the first 48 hours of storage, then remain stable for about 12 days, after which they slowly decline (see Figure 9.2).¹⁵

For maximum hygienic safety, follow these simple rules when using a graywater recycling system: don't drink graywater; don't come in physical contact with graywater (and wash promptly if you accidentally do come in contact with it); don't allow graywater to come in contact with edible portions of food crops; don't allow graywater to pool on the surface of the ground; and don't allow graywater to run off your property.

PRACTICAL GRAYWATER SYSTEMS

The object of recycling graywater is to make the organic nutrients in the water available to plants and microorganisms, preferably on a continuous basis. The organisms will consume the organic material, thereby recycling it through the natural system.

It is estimated that 30 gallons of graywater per person per day will be produced from a water-conservative home. This graywater can be recycled either indoors or outdoors. Inside buildings, graywater can be filtered through deep soil beds, or shallow gravel beds, in a space where plants can be grown, such as in a greenhouse.

Outdoors, in colder climates, graywater can be drained into leaching trenches that are deep enough to resist freezing, but shallow enough to keep the nutrients within the root zones of surface plants. Freezing can be prevented by applying a mulch over the subsurface leaching trenches. Graywater can also be circulated through evapotranspiration trenches (Figure 9.3), constructed wetlands (Figures 9.4, 9.5, 9.6, and 9.7), mulch basins (Figure 9.10), and soilbeds (Figures 9.11, 9.12, 9.13, and 9.14).

EVAPOTRANSPIRATION

Plants can absorb graywater through their roots and then transpire the moisture into the air. A graywater system that relies on such transpiration is called an Evapotranspiration System. Such a system may consist of a tank to settle out the solids, with the effluent draining or being pumped into a shallow sand or gravel bed covered with vegetation. Canna lilies, iris, elephant ears, cattails, ginger lily, and umbrella tree, among others, have been used with these systems. An average two bedroom house may require an evapotranspiration trench that is three feet wide and 70 feet long. One style of evapotranspiration system consists of a shallow trench lined with clay or other waterproof lining (such as plastic), filled with an inch or two of standard gravel, and six inches of pea gravel. Plants are planted in the gravel, and no soil is used.

Other systems, such as the Watson Wick (Figure 9.3), may be deeper and may utilize topsoil.

CONSTRUCTED WETLANDS

The system of planting aquatic plants such as reeds or bulrushes in a wet (often gravel) substrate medium for graywater recycling is called a “constructed wetland” or “artificial wetland.” The first artificial wetlands were built in the 1970s. By the early 1990s, there were more than 150 constructed wetlands treating municipal and industrial wastewater in the US.

According to the US Environmental Protection Agency, “Constructed wetlands treatment systems can be established almost anywhere, including on lands with limited alternative uses. This can be done relatively simply where wastewater treatment is the only function sought. They can be built in natural settings, or they may entail extensive earthmoving, construction of impermeable barriers, or building of containment such as tanks or trenches. Wetland vegetation has been established and maintained on

substrates ranging from gravel or mine spoils to clay or peat . . . Some systems are set up to recharge at least a portion of the treated wastewater to underlying ground water. Others act as flow-through systems, discharging the final effluent to surface waters. Constructed wetlands have diverse applications and are found across the country and around the world. They can often be an environmentally acceptable, cost-effective treatment option, particularly for small communities.” ¹⁶

A wetland, by definition, must maintain a level of water near the surface of the ground for a long enough time each year to support the growth of aquatic vegetation. Marshes, bogs, and swamps are examples of naturally occurring wetlands. Constructed wetlands are designed especially for pollution control, and exist in locations where natural wetlands do not.

Two types of constructed wetlands are in common use today. One type exposes the water's surface (Surface Flow Wetland, Figure 9.6), and the other maintains the water surface below the level of the gravel (Subsurface Flow Wetland, Figures 9.4, 9.5, and 9.7). Some designs combine elements of both. Subsurface flow wetlands are also referred to as Vegetated Submerged Bed, Root Zone Method, Rock Reed Filter, Microbial Rock Filter, Hydrobotanical Method, Soil Filter Trench, Biological-Macrophytic Marsh Bed, and Reed Bed Treatment.¹⁷

Subsurface flow wetlands are considered to be advantageous compared to open surface wetlands, and are more commonly used for individual households. By keeping the water below the surface of the gravel medium, there is less chance of odors escaping, less human contact, less chance of mosquito breeding, and faster “treatment” of the water (due to more of the water being exposed to the microbially populated gravel surfaces and plant roots). The subsurface water is also less inclined to freeze during cold weather.

Constructed wetlands generally consist of one or more lined beds, or cells. The gravel media in the cells should be as uniform in size as possible and should consist of small to medium size gravel or stone, from one foot to three feet in depth. A layer of sand may be used either at the top or the bottom of a gravel medium, or a layer of mulch and topsoil may be applied over the top of the gravel. In some cases, gravel alone will be used with no sand, mulch, or topsoil. The sides of the wetlands are bermed to prevent rainwater from flowing into them, and the bottom may be slightly sloped to aid in the flow of graywater through the system. A constructed wetland for a household, once established, requires some maintenance, mainly the annual harvesting of the plants (which can be composted).

In any case, the roots of aquatic plants will spread through the gravel as the plants grow. The most common species of plants used in the wetlands are the cattails, bulrushes, sedges, and reeds. Graywater is filtered through the gravel, thereby keeping the growing environment wet, and bits of organic material from the graywater become trapped in the filtering medium. Typical retention times for graywater in a subsurface flow wetland system range from two to six days. During this time, the organic material is broken down and utilized by microorganisms living in the medium and on the roots of the plants. A wide range of organic materials can also be taken up directly by the plants themselves.

Bacteria, both aerobic and anaerobic, are among the most plentiful microorganisms in wetlands and are

thought to provide the majority of the wastewater treatment. Microorganisms and plants seem to work together symbiotically in constructed wetlands, as the population of microorganisms is much higher in the root areas of the plants than in the gravel alone. Dissolved organic materials are taken up by the roots of the plants, while oxygen and food are supplied to the underwater microorganisms through the same root system.¹⁸

Aquatic microorganisms have been reported to metabolize a wide range of organic contaminants in wastewater, including benzene, naphthalene, toluene, chlorinated aromatics, petroleum hydrocarbons, and pesticides. Aquatic plants can take up, and sometimes metabolize, water contaminants such as insecticides and benzene. The water hyacinth, for example, can remove phenols, algae, fecal coliforms, suspended particles, and heavy metals including lead, mercury, silver, nickel, cobalt, and cadmium from contaminated water. In the absence of heavy metals or toxins, water hyacinths can be harvested as a high-protein livestock feed. It can also be harvested as a feedstock for methane production. Reed-based wetlands can remove a wide range of toxic organic pollutants.¹⁹ Duckweeds also remove organic and inorganic contaminants from water, especially nitrogen and phosphorous.²⁰

When the outdoor air temperature drops below a certain point (during the winter months in cold climates), wetland plants will die and microbial activity will drop off. Therefore, constructed wetlands will not provide the same level of water treatment year round. Artificial wetlands systems constitute a relatively new approach to water purification, and the effects of variables such as temperature fluctuations are not completely understood. Nevertheless, wetlands are reported to perform many treatment functions efficiently in winter. One source reports that the removal rates of many contaminants are unaffected by water temperature, adding, “*The first two years of operation of a system in Norway showed a winter performance almost at the same level as the summer performance.*” Some techniques have been developed to insulate wetland systems during the colder months. For example, in Canada, water levels in wetlands were raised during freezing periods, then lowered after a layer of ice had formed. The cattails held the ice in place, creating an air space over the water. Snow collected on top of the ice, further insulating the water underneath.²¹

It is estimated that one cubic foot of artificial wetland is required for every gallon per day of graywater produced. For an average single bedroom house, this amounts to about a 120 square foot system, one foot deep. However, it is better to overbuild a system than to underbuild. Some constructed wetland situations may not have enough drainage water from a residence to keep the system wet enough. In this case, extra water may be added from rain water collection or other sources.

WETLAND PLANTS

Aquatic plants used in constructed wetland systems can be divided into two general groups: microscopic and macroscopic. Most of the microscopic plants are algae, which can be either single cell (such as *Chlorella* or *Euglena*) or filamentous (such as *Spirulina* or *Spyrogyra*).

Macroscopic (larger) plants can grow under water (submergent) or above water (emergent). Some grow

partially submerged and some partially emerged. Some examples of macroscopic aquatic plants are reeds, bulrushes, water hyacinths, and duckweeds (see Figure 9.8 and Table 9.1). Submerged plants can remove nutrients from wastewaters, but are best suited in water where there is plenty of oxygen (water with a high level of organic material tends to be low in oxygen due to extensive microbial activity).

Examples of floating plants are duckweeds and water hyacinths. Duckweeds can absorb large quantities of nutrients. Small ponds that are overloaded with nutrients such as farm fertilizer run-off can often be seen choked with duckweed, appearing as a green carpet on the pond's surface. In a two and a half acre pond, duckweed can absorb the nitrogen, phosphorous, and potassium from the excretions of 207 dairy cows. The duckweed can eventually be harvested, dried, and fed back to the livestock as a protein-rich feed. Livestock can even eat the plants directly from a water trough.²²

Algae work in partnership with bacteria in aquatic systems. Bacteria break down complex nitrogen compounds and thereby make the nitrogen available to algae. Bacteria also produce carbon dioxide which is utilized by the algae.²³

SOILBOXES OR SOILBEDS

A soilbox is a box designed to allow graywater to filter through it while plants grow on top of it (Figure 9.14). Such boxes have been in use since the 1970s. Since the box must be well-drained, it is first layered with rocks, pea gravel, or other drainage material. This is covered with screening, then a layer of coarse sand is added, followed by finer sand; two feet of top soil is added to finish it off. Soilboxes can be located indoors or outdoors, either in a greenhouse, or as part of a raised-bed garden system.²⁴

Soilboxes (soilbeds) located in indoor greenhouses are illustrated in Figures 9.11 and 9.13. An outdoor soilbed is illustrated in Figure 9.12.

PEEPERS

At one point in the development of my homestead, I had to decide what to do with my graywater. My household produced no blackwater or sewage, and we composted all of our organic material. We only had a hand pump at the kitchen sink, and we carried our drinking water from a spring out behind the house. Nevertheless, we still had a sink and bathtub with drains, and the water had to go somewhere.

The choices I had were pretty limited: install an underground septic tank and drain the graywater into it; run the graywater through some sort of biofilter (such as sawdust) and then compost the sawdust on occasion; or try some sort of constructed wetland. I decided to experiment with the last option, mainly because I had an acid-mine-drainage spring running past my house, and I thought the graywater, which tends to be alkaline because of soap, would help neutralize the acid water. I also thought a pond would provide insurance against a drought, when rain water collection for watering a garden isn't reliable.

The acid spring flowed past my house from an abandoned surface coal mine, and when I first started

living beside it, it was choked with long, slimy, green algae. I introduced ducks to the algae-choked water, and quite by accident, I found that the algae disappeared as long as I kept ducks on the water. Whether the ducks were eating the algae or just breaking it up with their feet, I don't know. In any case, the water changed from ugly to beautiful, almost overnight, by the simple addition of another lifeform to the biological system. This indicated to me that profound changes could occur in ecological systems with proper (even accidental) management. Unfortunately, constructed wetland systems are still new and there is not much concrete information about them that is applicable to single family dwellings. Therefore, I was forced, as usual, to engage in experimentation.

I built a naturally clay-lined pond near my house about the size of a large swimming pool, then diverted some of the acid mine water to fill the pond. I directed my graywater into this "modified lagoon" wastewater system via a six inch diameter drain pipe with an outlet discharging the graywater below the surface of the pond water. I installed a large drainpipe to act as a pre-digestion chamber where organic material could collect and be broken down by anaerobic bacteria en route to the lagoon, like a mini septic tank. I add septic tank bacteria to the system annually by dumping it down the household drains. I assumed that the small amount of organic matter that entered the pond from the graywater drain would be consumed by the organisms in the water, thereby helping to biologically remediate an extensively damaged source of water. The organic material settles into the bottom of the pond, which is about five feet at the deepest point, thereby being retained in the constructed system indefinitely. I also lined the bottom of the pond with limestone to help neutralize the incoming acid mine water.

The ducks, of course, loved the new pond. They still spend countless hours poking their heads under the water, searching the pond bottom for things to eat. Our house is located between our garden and the pond, and the water is clearly visible from the kitchen sink, as well as from the dining room on the east side of the house, while the nearby garden is visible from the west windows. Shortly after we built the pond, my family was working in our garden. Soon we heard the loud honking of Canada geese in the sky overhead, and watched as a mating pair swooped down through the trees and landed on our new, tiny pond. This was quite exciting, as we realized that we now had a place for wild waterfowl, a bonus we hadn't really anticipated. We continued working in the garden, and were quite surprised to see the geese leave the pond and walk past our house toward the garden where we were busy digging. We continued to work, and they continued to walk toward us, eventually walking right past us through the yard, and on to the far end of the garden. When they reached the orchard, they turned around and marched right past us again, making their way back to the pond. To us, this was equivalent to an initiation for our new pond, a way that nature was telling us we had contributed something positive to the environment.

Of course, it didn't end with the two Canada Geese. Soon, a Great Blue Heron landed in the pond, wading around its shallow edges on stilt-like legs. It was spotted by one of the children during breakfast, a mere fifty feet from the dining room window. Then, a pair of colorful wood ducks spent an afternoon playing in the water. This was when I noticed that wood ducks can perch on a tree branch like a songbird. Recently, I counted 40 Canada geese on the little pond. They covered its surface like a feathery carpet, only to suddenly fly off in a great rush of wings.

We raise our own domesticated ducks for algae control, for eggs, and occasionally for meat. At one point

we raised some Mallard ducks, only to find that this wild strain will fly away when they reach maturity. One of the female Mallards became injured somehow, and developed a limp. She was certainly a “lame duck,” but the children liked her and took care of her. Then one day she completely disappeared. We thought a predator had killed the defenseless bird, and we never expected to see her again. To the children’s delight, the following spring a pair of wild Mallard ducks landed on our little pond. We watched them swim around for quite some time, until the female came out of the water and walked toward us. Or, I should say, “limped” toward us. Our lame Mallard duck had flown away for the winter only to come back in the spring with a handsome boyfriend! Our new graywater pond was the point of reference for her migration.

My youngest daughter, Phoebe, was given a Canada goose to raise by one of the neighbors. The tiny gosling couldn’t have been more than a day or two old when it was discovered wandering lost along the road. I’m not sure why Phoebe was asked to take care of the goose, other than she loves animals and she had a pond in her backyard, but she enthusiastically accepted the responsibility. She named the goose “Peepers,” and everywhere Phoebe went, Peepers followed. The two of them spent many a day at the graywater pond, Peepers splashing around in the water while Phoebe sat on the shore watching. Soon Peepers was a full grown goose, and everywhere Peepers went, large piles of goose droppings followed. The goose doo situation finally became so intolerable (to Dad, who renamed the goose “Poopers”) that Peepers was furtively exported to the wild. Phoebe was heartbroken.

This spring, as I write this, ten years after our graywater pond was constructed, a pair of honking Canada geese once again flew overhead. Except this time, only the female landed in our little pond. Phoebe went running to the pond when she heard that familiar honking, yelling “Peepers! Peepers!” Peepers had come back to say hello to Phoebe. How did I know it was Peepers? I didn’t. But somehow, Phoebe did. She stood on the pond bank for quite some time talking to the majestic goose, and the goose, also standing on the bank, talked back. They carried on a conversation that is rarely witnessed. Finally, Peepers flew off, and this time, Phoebe was happy.

I have more stories to tell about our graywater pond, and no doubt will have many more in the future. A buried, quarantined, septic tank for graywater, on the other hand, is pretty boring. I believe I made the right decision in deciding to construct a pond for our graywater. The benefits of such a system can go far beyond what one may imagine.

Source: The Humanure Handbook. Jenkins Publishing, PO Box 607, Grove City, PA 16127. To order, phone: 1-800-639-4099.

<http://www.jenkinspublishing.com/>

MENU: [HOME](#) » [Reconstruction](#) » [Recovery](#) » [Renewal](#) » [Survival](#) » [Humanure Content](#)

THE END IS NEAR

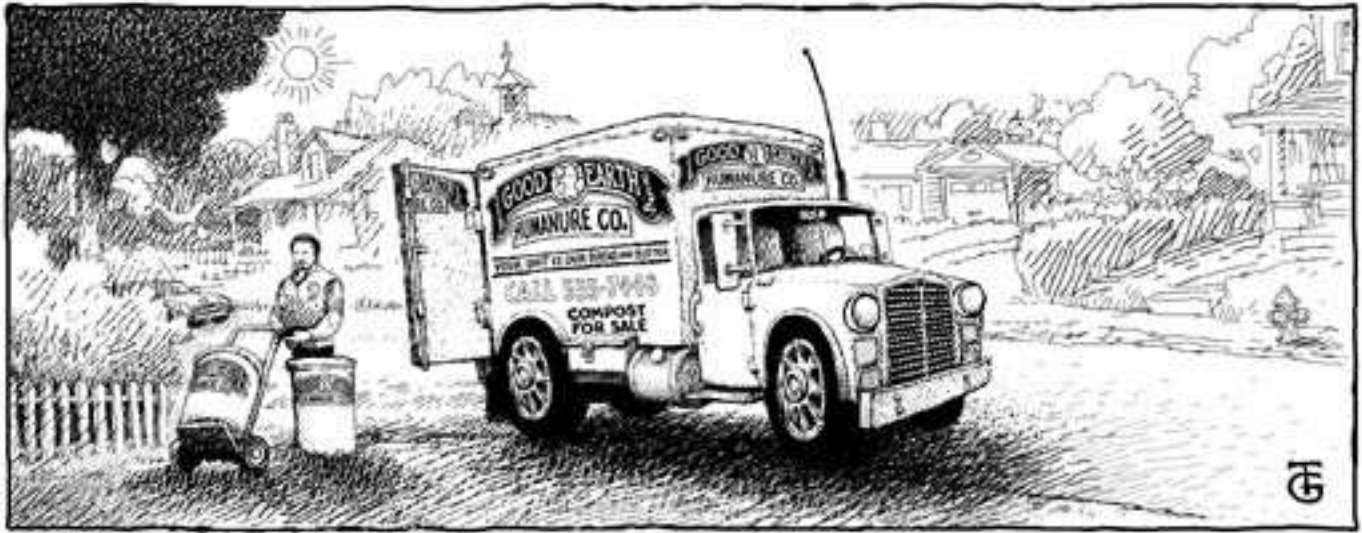

*“If you want to be free, learn to live simply.
Use what you have and be content where you are.”*

J. Heider

Ladies and gentlemen, allow me to introduce you to a new and revolutionary literary device known as the *self-interview*! (Applause heard in background. Someone whoops.) Today I'll be interviewing myself. In fact, here I am now. (Myself walks in.)

***Me:** Good morning, sir. Haven't I seen you somewhere before?*

Myself: Cut the crap. It's too early in the morning for this. You see me every time you look in the mirror, which isn't very often, thank god. What, for crying out loud, would possess you to interview yourself, anyway?

***M:** If I don't, who will?*

MS: You do have a point there. In fact, that may be an issue worthy of contemplation.

M: *Well, let's not get off the track. The topic of discussion today is a substance near and dear to us all. Shall we step right into it?*

MS: What the hell are you talking about?

M: *I'll give you a hint. It often can be seen with corn or peanuts on its back.*

MS: Elephants?

M: *Close, but no cigar. Actually, cigar would have been a better guess. We're going to talk about humanure.*

MS: You dragged me out of bed and forced me to sit here in front of all these people to talk about CRAP?!

M: *You wrote a book on it, didn't you?*

MS: So what? OK, OK. Let's get on with it. I've had enough of your theatrics.

M: *Well, first off, do you expect anyone to take the Humanure Handbook seriously?*

MS: Why wouldn't they?

M: *Because nobody gives a damn about humanure. The last thing anyone wants to think about is a turd, especially their own. Don't you think that by bringing the subject to the fore you're risking something?*

MS: You mean like mass constipation? Not quite. I'm not going to put any toilet bowl manufacturers out of business. I'd estimate that one in a million people have any interest at all in the topic of resource recovery in relation to human excrement. Nobody thinks of human manure as a resource; the concept is just too bizarre.

M: *Then what's the point?*

MS: The point is that long-standing cultural prejudices and phobias need to be challenged once in a while by somebody, anybody, or they'll never change. Fecophobia is a deeply rooted fear in the American, and perhaps Western, psyche. But you can't run from what scares you. It just pops up somewhere else, where you least expect it. We've adopted the policy of defecating in our drinking water and then piping it off somewhere to let someone else deal with it. So now we're finding that our drinking water sources are dwindling and becoming increasingly contaminated. What goes around comes around.

M: *Oh, come on. I drink water every day and it's never contaminated. We Americans probably have the*

most abundant supply of safe drinking water of any country on the planet.

MS: Yes and no. True, your water may not suffer from fecal contamination, meaning intestinal bacteria in water. But how much chlorine do you drink instead? Then there's water pollution from sewage in general, such as beach pollution. But I don't want to get into all this again. I've already discussed human waste pollution in Chapter Two.

M: *Then you'll admit that American drinking water supplies are pretty safe?*

MS: From disease-causing microorganisms, generally yes, they are. Even though we defecate in our water, we go to great lengths and expense to clean the pollutants back out of it. The chemical additives in our water, such as chlorine, on the other hand, are not good to drink. And let's not forget that drinking water supplies are dwindling all over the world, water tables are sinking, and water consumption is on the increase with no end in sight. That seems to be a good reason to not pollute water with our daily bowel movements. Yet, that's only half the equation.

M: *What do you mean?*

MS: Well, we're still throwing away the agricultural resources that humanure should be providing us. We're not maintaining an intact human nutrient cycle. By piping sewage into the sea, we're essentially dumping grain into the sea. By burying sludge, we're burying a source of food. That's a cultural practice that should be challenged. It's a practice that's not going to change overnight, but will change incrementally if we begin acknowledging it now.

M: *So what're you saying? You think everybody should shit in a five-gallon bucket?*

MS: God forbid. Then you would see mass constipation!

M: *Well then, I don't understand. Where do we go from here?*

MS: I'm not suggesting we have a mass cultural change in toilet habits. I'm suggesting that, for starters, we need to change the way we understand our habits. Most people have never heard of such a thing as a nutrient cycle. Many people don't even know about compost. Recycling humanure is just not something people think about. I'm simply suggesting that we begin considering new approaches to the age-old problem of what to do with human excrement. We also need to start thinking a bit more about how we live on this planet, because our survival as a species depends on our relationship with the Earth.

M: *That's a beginning, but that's probably all we'll ever see in our lifetime, don't you think? Some people, like you for example, will think about these things, maybe write about them, maybe even give them some lip service. Most people, on the other hand, would rather have a bag of cheese puffs in one hand, a beer in the other, and a TV in front of them.*

MS: Don't be so sure about that. Things are changing. There are more than a few people who will turn off their TVs, pick the orange crumbs out of their teeth, and get busy making the world a better place. I predict, for example, that composting toilets and toilet systems will continue to be designed and redesigned in our lifetimes. Eventually, entire housing developments or entire communities will utilize composting toilet systems. Some municipalities will eventually install composting toilets in all new homes.

M: You think so? What would that be like?

MS: Well, each home would have a removable container made of recycled plastic that would act as both a toilet receptacle and a garbage disposal.

M: How big a container?

MS: You'd need about five gallons of capacity per person per week. A container the size of a fifty gallon drum would be full in about two weeks for an average family. Every household would deposit all of its organic material except graywater into this receptacle, including maybe some grass clippings and yard leaves. The municipality could provide a cover material for odor prevention, consisting of ground leaves, rotted sawdust, or ground newsprint, neatly packaged for each household and possibly dispensed automatically into the toilet after each use. This would eliminate the production of all organic garbage and all sewage, as it would all be collected without water and composted at a municipal compost yard.

M: Who'd collect it?

MS: Once every couple of weeks or so, your municipality or a business under contract with your municipality would take the compost receptacle from your house. A new compost receptacle would then replace the old. This is already being done in the entire province of Nova Scotia, Canada, and in areas of Europe where organic kitchen materials are collected and composted.

When toilet material is added to the collection system, your manure, urine, and garbage, mixed together with ground leaves and other organic refuse or crop residues, would be collected regularly, just like your garbage is collected now. Except the destination would not be a landfill, it'd be the compost yard where the organic material would be converted, through thermophilic composting, into an agricultural resource and sold to farmers, gardeners, and landscapers who'd use it to grow things. The natural cycle would be complete, immense amounts of landfill space would be saved, a valuable resource would be recovered, pollution would be prevented, and soil fertility would be enhanced. So would our long-term survival as human beings on this planet.

M: I don't know . . . how long before people will be ready for that?

MS: In Japan today, a similar system is in use, except that rather than removing the container and replacing it with a clean one, the truck that comes to pick up the humanure suctions it out of a holding

tank. Sort of like a truck sucking the contents out of a septic tank.

Such a truck system involves a capital outlay about a third of that for sewers. One study which compares the cost between manual humanure removal and waterborne sewage in Taiwan estimates manual collection costs to be less than one-fifth the cost of waterborne sewage treated by oxidation ponds. That takes into account the pasteurization of the humanure, as well as the market value of the resultant agricultural soil additive.¹

M: But that's in the Far East. We don't do stuff like that in America.

MS: One of the most progressive large scale examples I have seen is in Nova Scotia, Canada. On November 30, 1998, Nova Scotia banned all organic material from entering its landfills. The municipality provides free receptacles for every household to deposit their food scraps into. So when a banana peel or burnt pop-tart gets pitched into the trash, it goes into the *green cart* along with egg shells, coffee grounds, and even cereal boxes, waxed paper, and file folders. Then, every two weeks, a truck comes around, just like the standard garbage trucks we're used to seeing, and picks up the organic material. From there, it goes to one of many central composting yards, where the material gets run through a grinder and shoved into a giant composting bin. Within 24 to 48 hours, the thermophilic microorganisms in the garbage have raised the temperature of the organic mass to 60-70°C (140-158°F). And it's a natural process.

The Netherlands was one of the first countries to mandate large scale source separation of organic material for composting, having done so since 1994; in at least five European countries, such separation is common.² Since 1993, in Germany, for example, discarded waste material must contain less than 5% organic matter, otherwise the material has to be recycled, mainly by composting.³ In England and Wales, a target has been set to compost a million tonnes of organic household material by the year 2000.⁴

M: But those are not toilets.

MS: Can't you see? This is only one small step away from collecting toilet materials and composting them, too. Toilets will be redesigned as collection devices, not disposal devices. We've developed the art, science, and technology of composting enough to be able to constructively recycle our own excrement on a large scale.

M: So why don't we?

MS: Because humanure doesn't exist, as far as most compost professionals are concerned. It's not even on the radar screen. Human manure is seen as human waste, something to be disposed of, not recycled. When I was visiting composting operations in Nova Scotia, one compost educator told me there were 275,000 metric tonnes of animal manures produced annually in his county suitable for composting. He did not include human manure in his assessment. As far as he was concerned, humans are not animals and they don't produce manure.

To give you an example of how clueless Americans are about composting humanure, let me tell you about some missionaries in Central America.

M: Missionaries?

MS: That's right. A group of missionaries was visiting an indigenous group in El Salvador and they were appalled by the lack of sanitation. There were no flush toilets anywhere. The available toilet facilities were crude, smelly, pit latrines that bred flies. When the group returned to the United States, they were very concerned about the toilet problem they had seen, and decided they should help. But they didn't know what to do. So they shipped a dozen portable toilets down there, at great expense.

M: Portable toilets?

MS: Yeah, you know, those big, plastic outhouses you see at rest stops along the highways, at construction sites, and festivals. The ones that smell bad, and are filled with a blue liquid choked with floating turds and toilet paper.

M: Oh yeah.

MS: Well, the village in El Salvador got the portable toilets and the people there set them up. They even used them — until they filled up. The following year, the missionaries visited the village again to see how their new toilets were working.

M: And?

MS: And nothing. The toilets had filled up and the villagers stopped using them. They went back to their pit latrines. They had a dozen portable toilets sitting there filled to the brim with urine and crap, stinking to high heaven, and a fly heaven at that. The missionaries hadn't thought about what to do with the toilets when they were full. In the US, they're pumped out and the contents are taken to a sewage plant. In El Salvador, they were simply abandoned.

M: So what's your point?

MS: The point is that we don't have a clue about constructively recycling humanure. Most people in the US have never even had to think about it, let alone do it. If the missionaries had known about composting, they may have been able to help the destitute people in Central America in a meaningful and sustainable way. But they had no idea that human manure is as recyclable as cow manure.

M: Let me get this straight. Now you're saying that humans are the same as cows?

MS: Well, all animals defecate. Many westerners simply won't admit it. But we're starting to. We

Americans have a long way to go. The biggest obstacle is in understanding and accepting humanure and other organic materials as resource materials rather than waste materials. We have to stop thinking of human excrement and organic refuse as waste. When we do, then we'll stop defecating in our drinking water and stop sending our garbage to landfills.

It's critical that we separate water from humanure. As long as we keep defecating in water we'll have a problem that we can't solve. The solution is to stop fouling our water, not to find new ways to clean it up. Don't use water as a vehicle for transporting human excrement or other waste. Humanure must be collected and composted along with other solid (and liquid) organic refuse produced by human beings. We won't be able to do this as long as we insist upon defecating into water. Granted, we can dehydrate the waterborne sewage sludge and compost that. However, this is a complicated, expensive, energy-intensive process. Furthermore, the sludge can be contaminated with all sorts of bad stuff from our sewers which can become concentrated in the compost.⁵

M: Composting sewage sludge is bad?

MS: No. In fact, composting is probably the best thing you can do with sludge. It's certainly a step in the right direction. There are many sludge composting operations around the world, and when the sludge is composted, it makes a useful soil additive. I've visited sludge composting sites in Nova Scotia, Pennsylvania, Ohio, and Montana, and the finished compost at all of the sites is quite impressive.

M: It'll never happen (shaking his head). Face it. Americans, westerners, will never stop shitting in water. They'll never, as a society, compost their manure. It's unrealistic. It's against our cultural upbringing. We're a society of Howdy-Doody, hotdogs, hairspray, and Ho-Hos, not composted humanure, fer chrissake. We don't believe in balancing human nutrient cycles! We just don't give a damn. Compost making is unglamorous and you can't get rich doing it. So why bother?!

MS: You're right on one point — Americans will never stop shitting. But don't be so hasty. In 1988, in the United States alone, there were 49 operating municipal sludge composting facilities.⁶ By 1997, there were over 200.⁷ A solid waste composting plant in Oregon is designed to handle 800 tons of refuse daily.

In Duisberg, Germany, a decades-old plant composts 100 tons of domestic refuse daily. Another plant at Bad Kreuznach handles twice that amount. Many European composting plants compost a mixture of refuse and sewage sludge. There are at least three composting plants in Egypt. In Munich, a scheme was being developed in 1990 to provide 40,000 households with "biobins" for the collection of compostable refuse.⁸

It's only a matter of time before the biobin concept is advanced to collect humanure as well. In fact, some composting toilets already are designed so that the humanure can be wheeled away and composted at a separate site. Eventually, municipalities will assume the responsibility for collecting and composting all organic material from urban and suburban human populations, including toilet materials.

M: Yeah, right.

MS: And you are now revealing the main obstacle toward a sustainable society. Personal attitude. Everything we take for granted today — shoes, clothing, metal tools, electronic equipment, heck, even toilet paper, exists for one reason, and one reason only: because someone in the past cared about the future. You'd be running around naked today chasing rabbits with a stick if people in the past hadn't made things better for us in the present. We all have an obligation to our future generations. That's what evolution is, and that's what survival of the species requires. We have to think ahead. We have to care about our descendants too, and not just about ourselves. That means we have to understand that waste is not good for us, or for future generations. When we dump endless amounts of garbage into the environment with the attitude that someone in the future can deal with it, we are not evolving, we're *devolving*.

M: What's that supposed to mean?

MS: It's simple enough. OK, you have trash. You don't throw the trash "out." There is no "out." It has to go somewhere. So you simply sort the trash into separate receptacles in your home, and that makes it easy to recycle the stuff. When it's recycled, it's not wasted. A chimpanzee could figure that out. It's easy to understand and it's easy to do.

A lot of compost that's been produced by big composting plants has been contaminated with things like batteries, metal shards, bottle caps, paints, and heavy metals. As a result, much of it hasn't been useful for agriculture. Instead, it's been used for filler or for other non-agricultural applications, which, to me, is absurd. The way to keep junk out of compost is to value compostable material enough to collect it separately from other trash. A household biobin would do the trick. The biobin could be collected regularly, emptied, its contents composted, and the compost sold to farmers and gardeners as a financially self-supporting service provided by independent businesses.

The trick to successful large-scale compost production can be summed up in two words: *source separation*. The organic material must be separated at the source. This means that individual families will have to take some responsibility for the organic material they discard. They will no longer be permitted to throw it all in one garbage can with their plastic Ho-Ho wrappers, pop bottles, broken cell phones, and worn out toaster ovens. Organic material is too valuable to be wasted. The people in Nova Scotia have figured that out, as have many others throughout the world. Americans are a little slow.

M: But they're not composting toilet materials, are they?

MS: They're composting sewage sludge, which is a big step in the right direction. Some entrepreneurs are in the sewage composting business in the United States, too. In 1989, the town of Fairfield, Connecticut, contracted to have its yard material and sewage sludge composted. The town is said to have saved at least \$100,000 in waste disposal costs in its first year of composting alone. The Fairfield operation is just a quarter mile from half million dollar homes and is reported to smell no worse than wet

leaves from only a few yards away.⁹

In Missoula, Montana, all of the city's sewage sludge is composted, and the entire composting operation is funded by the tipping fees alone. All of the compost produced is pure profit, and all of it is sold. Composting is a profitable venture when properly managed.

M: But still, there's the fear of humanure and its capability of causing disease and harboring parasites.

MS: That's right. But according to the literature, a biological temperature of 50°C (122°F) for a period of 24 hours is sufficient to kill the human pathogens potentially in humanure. EPA regulations require that a temperature of 55°C (131°F) be maintained for three days when composting sewage sludge in bins. Thermophilic microorganisms are everywhere, waiting to do what they do best — make compost. They're on grass, tree branches, leaves, banana peels, garbage, and humanure. Creating thermophilic compost is not difficult or complicated, and thermophilic composting is what we need to do in order to sanitize human excrement without excessive technology and energy consumption. Thermophilic composting is something humans all over the world can do whether or not they have money or technology.

There will always be people who will not be convinced that composted humanure is pathogen-free unless every tiny scrap of it is first analyzed in a laboratory, with negative results. On the other hand, there will always be people, like me, who conscientiously compost humanure by maintaining a well-managed compost pile, and who feel that their compost has been rendered hygienically safe as a result. A layer of straw covering the finished compost pile, for example, will insulate the pile and help keep the outer surfaces from cooling prematurely. It's common sense, really. The true test comes in living with the composting system for long periods of time. I don't know anyone else who has done so, but after twenty years, I've found that the simple system I use works well for me. And I don't do anything special or go to any great lengths to make compost, other than the simple things I've outlined in this book.

Perhaps Gotaas hits the nail on the head when he says, *“The farm, the garden, or the small village compost operator usually will not be concerned with detailed tests other than those to confirm that the material is safe from a health standpoint, which will be judged from the temperature, and that it is satisfactory for the soil, which will be judged by appearance. The temperature of the compost can be checked by: a) digging into the stack and feeling the temperature of the material; b) feeling the temperature of a rod after insertion into the material; or c) using a thermometer. Digging into the stack will give an approximate idea of the temperature. The material should feel very hot to the hand and be too hot to permit holding the hand in the pile for very long. Steam should emerge from the pile when opened. A metal or wooden rod inserted two feet (0.5 m) into the pile for a period of 5-10 minutes for metal and 10-15 minutes for wood should be quite hot to the touch, in fact, too hot to hold. These temperature testing techniques are satisfactory for the smaller village and farm composting operations.”*

[10](#)

In other words, humanure composting can remain a simple process, achievable by anyone. It does not

need to be a complicated, high-tech, expensive process controlled and regulated by nervous people in white coats bending over a compost pile, shaking their heads and wringing their hands while making nerdy clucking sounds.

I want to make it clear though, that I can't be responsible for what other people do with their compost. If some people who read this book go about composting humanure in an irresponsible manner, they could run into problems. My guess is the worst thing that could happen is they would end up with a mouldered compost pile instead of a thermophilic one (I see this happen a lot). The remedy for that would be to let the mouldered pile age for a couple years before using it agriculturally, or to use it horticulturally instead.

I can't fault someone for being fecophobic, and I believe that fecophobia lies at the root of most of the concerns about composting humanure. What fecophobes may not understand is that those of us who aren't fecophobes understand the human nutrient cycle and the importance of recycling organic materials. We recycle organic refuse because we know it's the right thing to do, and we aren't hampered by irrational fears. We also make compost because we need it for fortifying our food-producing soil, and we consequently exercise a high degree of responsibility when making the compost. It's for our own good.

Then, of course, there's the composter's challenge to fecophobes: *show us a better way to deal with human excrement.*

M: *Sounds to me like you have the final word on the topic of humanure.*

MS: Hardly. The Humanure Handbook is only a tiny beginning in the dialogue about human nutrient recycling.

M: *Well, sir, this is starting to get boring and our time is running out, so we'll have to wrap up this interview. Besides, I've heard enough talk about the world's most notorious "end" product. So let's focus a little on the end itself, which has now arrived.*

MS: And this is it. This is the end?

M: *"This is the end." (Sung like Jim Morrison.) What d'ya say folks? (Wild applause, stamping of feet, frenzied whistling, audience jumping up and down, yanking at their hair, rolls of toilet paper thrown confetti-like through the air, clothes being torn off, cheering and screaming. Someone starts chanting "Source separation, Source separation!" What's this!?! The audience is charging the stage! The interviewee is being carried out over the heads of the crowd! Hot dang and hallelujah!)*

Source: The Humanure Handbook. Jenkins Publishing, PO Box 607, Grove City, PA 16127. To order, phone: 1-800-639-4099.

<http://www.jenkinspublishing.com/>

MENU: [HOME](#) » [Reconstruction](#) » [Recovery](#) » [Renewal](#) » [Survival](#) » [Humanure Content](#)

THE HUMANURE HANDBOOK -- REFERENCE CITATIONS

[CHAPTER ONE](#) | [TWO](#) | [THREE](#) | [FOUR](#) | [FIVE](#) | [SIX](#) | [SEVEN](#) | [EIGHT](#) | [NINE](#) | [TEN](#)

REFERENCES - CHAPTER ONE - CRAP HAPPENS

- 1 - Brown, Lester R., et al. (1998). State of the World 1998. New York: W. W. Norton and Co., p. 115.
- 2 - Brown, Lester R., et al. (1999). State of the World 1999. New York: W. W. Norton and Co., p. 15.
- 3 - Associated Press. (1999 January 12).
- 4 - State of the World 1999, p. 14.
- 5 - State of the World 1999, p. 88.
- 6 - State of the World 1998, p. 3, 10.
- 7 - State of the World 1999, p. 10; State of the World 1998, p. 3.
- 8 - Brown, Lester R., et al. (1998). Vital Signs 1998. New York: W. W. Norton and Co., p. 20.
- 9 - State of the World 1998, p. 4, 5.
- 10 - State of the World 1998, p. 14.
- 11 - State of the World 1999, p. 79, 83.
- 12 - State of the World 1999, p. 87.
- 13 - State of the World 1998, p. 11, 41; State of the World 1999, p. 97.
- 14 - State of the World 1999, p. 13, 97.
- 15 - State of the World 1999, p. 20, 21, 41, 46.

- 16 - Steingraber, Sandra. (1997). Living Downstream. Reading, MA: Perseus Books, p. 70.
- 17 - Living Downstream, p. 90.
- 18 - Colborn, Theo, Dumanoksi, Diane and Myers, John Peterson. (1996). Our Stolen Future. New York: Penguin Books, p.137.
- 19 - Living Downstream, p. 103.
- 20 - State of the World 1999, p. 49; Living Downstream, p. 70.
- 21 - Living Downstream, p. 38, 40, 49, 59, 60.
- 22 - Our Stolen Future, p. 137.
- 23 - Ryan, Frank, M.D. (1997). Virus X. New York: Little, Brown and Co., p. 383-390.
- 24 - State of the World 1999, p. xix.
- 25 - Gelbspan, Ross. (1997). The Heat is On. Reading, MA: Addison-Wesley Publishing Co., Inc., p. 148, 157.
- 26 - Barker, Rodney. (1998). And the Waters Turned to Blood. New York: Touchstone.

REFERENCES - CHAPTER TWO - WASTE NOT WANT NOT

- 1 - Hershkowitz, Allen. (1997). Too Good to Throw Away: Recycling's Proven Record. Washington, D.C.: Natural Resources Defense Council, Chapter 2.
- 2 - Steingraber, Sandra. (1997). Living Downstream. Reading, MA: Perseus Books, p. 95.
- 3 - Living Downstream, p. 238.
- 4 - Too Good to Throw Away, Chapter Two.
- 5 - Brown, Lester R., et al. (1998). State of the World 1998. New York: W. W. Norton and Co., p. 106.
- 6 - Kantor, Linda S., et al. (1997, January - April). "Estimating and Addressing America's Food Losses." Food Review. Washington, D.C.: US Department of Agriculture, Commodity Economics Division, Economic Research Service.
- 7 - US Environmental Protection Agency. (May 1998) Characterization of Municipal Solid Waste in the United States: 1997 Update. Report # EPA530-R-98-007. Washington, D.C.: US Environmental Protection Agency, p. 29, 45.

- 8 - State of the World 1998, p. 102.
- 9 - State of the World 1998, p. 101, 166.
- 10 - State of the World 1998, p. 101.
- 11 - Environment Reporter. (1996 September 27)
- 12 - Too Good to Throw Away, Chapter Two.
- 13 - Too Good to Throw Away, Chapter Two.
- 14 - World Resource Foundation. (1998, April). Warmer Bulletin Information Sheet - Landfill.
- 15 - Hammond, A., et al. (Eds.) (1993). 1993 Information Please Environmental Almanac. New York. Houghton Mifflin Co., p. 60-64.
- 16 - Brown, Lester R., et al. (1999). State of the World 1999. New York: W. W. Norton and Co., p. 141.
- 17 - Daniel, J.E., et al., (Eds.). 1992 Earth Journal. Boulder, CO: Buzzworm Books, p. 94.
- 18 - Fahm, Lattee A. (1980). The Waste of Nations: The Economic Utilization of Human Waste in Agriculture. Montclair, NJ: Allenheld, Osmun & Co., p. 45.
- 19 - Golden, Jack, et al. (1979). The Environmental Impact Data Book. Ann Arbor, MI: Ann Arbor Science Publishers, Inc., p. 495.
- 20 - US Department of Commerce, National Oceanic and Atmospheric Administration, Office of Ocean Resources, Conservation and Assessment. (1987). The National Coastal Pollutant Discharge Inventory Database. Silver Spring, MD: DOC/NOAA/ORCA.
- 21 - Environment Reporter. (1991 November 22) p. 1799.
- 22 - Environment Reporter. (1992 January 3) p. 2103.
- 23 - Environment Reporter. (1992 February 14) p. 2373.
- 24 - Environment Reporter. (1991 December 27) p. 2072.
- 25 - Environment Reporter. (1992 January 17) p. 2144.
- 26 - Environment Reporter. (1992 May 1) p. 13.
- 27 - US Environmental Protection Agency. (September 1997). Beach Program, EPA#820-F-97-002. Washington, D.C.:

US Environmental Protection Agency, p. 5.

28 - Environment Reporter. (1992 July 31). Washington D.C.: Bureau of National Affairs, Inc., p. 1110.

29 - Paul, Elizabeth. (1998). Testing the Waters VIII: Has Your Vacation Beach Cleaned Up Its Act?. Washington, D.C.: Natural Resources Defense Council, Inc.; NRDC Worldview News. (1998). Pollution Persists at US Beaches. Washington, D.C.: Natural Resources Defense Council, Inc.

30 - Bitton, Gabriel. (1994). Wastewater Microbiology. New York: Wiley-Liss, Inc., p. 368-369.

31 - National Resources Defense Council. (1997). Bulletin: Stop Polluted Runoff - 11 Actions to Clean up Our Waters. <http://www.nrdc.org/nrdcnp/fppubl.html>

32 - Wastewater Microbiology, p. 86.

33 - Ralof, Janet. (1998 March 21). "Drugged Waters--Does it Matter that Pharmaceuticals are Turning Up in Water Supplies?" Science News, Vol. 153 (No. 12), p. 187-189.

34 - State of the New England Environment. (1996). Preserving New England Natural Resources. <http://www.epa.gov/region01/soe/coastal.html>

35 - Environment Reporter. (1991 November 8) p. 1745-46; (1992 January 31) p. 2299.

36 - Toward Organic Security: Environmental Restoration or the Arms Race?. Peace and Environment Platform Project, c/o World Citizens Assembly, Suite 506, 312 Sutter St., San Francisco, CA 94018.

37 - Vital Signs 1998, p. 156.

38 - Courier. (1985, January). UNESCO. 7 Place de Fentenoy, 75700 Paris, France.

39 - State of the World 1999, p. 137.

40 - Vital Signs 1998, p. 156.

41 - Vital Signs 1998, p. 156, 157.

42 - Wastewater Microbiology, p. 79-80.

43 - Wastewater Microbiology, p. 261.

44 - Associated Press. (1993 April 10). Observer-Reporter. Washington and Green Counties, PA, p. A2; Carrolton, GA statistics from Wastewater Microbiology, p. 97.

45 - Goldstein, Debra. (1997). "Your drinking water: H₂O+what else?." e-Amicus. Washington, D.C.: National

- Resources Defense Council, <http://www.nrdc.org/eamicus/index.html>; US Environmental Protection Agency. Indicator 2: Population Served by Unfiltered Surface Water Systems at Risk from Microbiological Contamination. Washington, D.C.: US Environmental Protection Agency.
- 46 - Gever, John, et al. (1986). Beyond Oil: The Threat to Food and Fuel in the Coming Decades, A Summary Report. Cambridge, MA: Ballinger Publishing Co.
- 47 - Solley, Wayne B., et al. (1990). "Estimated Water Use in the United States in 1990." US Geological Survey Circular 1081, Table 31. Denver, CO. United State Geological Service, p. 65.
- 48 - National Resources Defense Council. (1996 December 24). Population and Consumption at NRDC: US Population Scorecard. Washington, D.C.: National Resources Defense Council.
- 49 - The Waste of Nations, p. xxiv.
- 50 - Stoner, Carol (Ed.). (1977). Goodbye to the Flush Toilet. Emmaus, PA: Rodale Press, Inc., p. vii.
- 51 - 1993 Information Please Environmental Almanac, p. 340-341.
- 52 - Environment Reporter. (1992 April 24) p. 2877-78.
- 53 - State of the World 1998, p. 100.
- 54 - Sides, S. (1991, August/September). "Compost." Mother Earth News, Issue 127, p. 50.
- 55 - Environment Reporter. (1992 February 28) p. 2439.
- 56 - Brown, Lester R., et al. (1998). Vital Signs 1998. New York: W. W. Norton and Co., p. 44-45.
- 57 - Vital Signs, p. 44.
- 58 - Vital Signs, p. 132.
- 59 - Vital Signs 1998, p. 132.
- 60 - US Environmental Protection Agency. PA IRIS Substance File: Nitrate, CASRN 14797-55-8. Washington, D.C.: US Environmental Protection Agency.
- 61 - 1992 Earth Journal, p. 159.
- 62 - US Environmental Protection Agency. (1990). National Survey of Pesticides in Drinking Water Wells. Washington, D.C.: US Environmental Protection Agency.
- 63 - State of the World 1999, p. 135.

64 - State of the World 1990, p. 184.

65 - Rybczynski, Witold, et al. (1982). Low Cost Technology Options for Sanitation - A State of the Art Review and Annotated Bibliography. Washington, D.C.: World Bank, p. 23.

66 - Cannon, Charles A. (1997 September 3-5). "Life Cycle Analysis and Sustainability Moving Beyond the Three R's -- Reduce, Reuse, and Recycle -- to P2R2 -- Preserve, Purify, Restore and Remediate." In E.I. Stentiford (Ed.), Proceedings of the 1997 Organic Recovery and Biological Treatment International Conference. Harrogate, UK, p. 252-253. Available from Stuart Brown, National Compost Development Association, PO Box 4, Grassington, North Yorkshire, BD23 5UR UK (stuartbrown@compuserve.com)

REFERENCES - CHAPTER THREE - MICROHUSBANDRY

1 - Shuval, Hillel I., et al. (1981). Appropriate Technology for Water Supply and Sanitation - Night Soil Composting. p.2. International Bank for Reconstruction and Development (World Bank), Washington DC, 20433, USA.

2 - Shuval, Hillel I. et al. (1981). Appropriate Technology for Water Supply and Sanitation - Night Soil Composting. p.2. International Bank for Reconstruction and Development (World Bank), Washington DC, 20433, USA.

3 - Shuval, Hillel I. et al. (1981). Appropriate Technology for Water Supply and Sanitation - Night Soil Composting. p.ii. International Bank for Reconstruction and Development (World Bank), Washington DC, 20433, USA.

4 - Rodale, J. I. (1960). The Complete Book of Composting. p. 9. Rodale Books, Inc., Emmaus, PA.

5 - Sides, S. (1991). Compost. *Mother Earth News*. Issue 127, Aug/Sept 1991 (pp.49-53).

6 - Bem, R., (1978). Everyone's Guide to Home Composting. Van Nostrand Reinhold Co., NY (p.4).

7 - Haug, Roger T. (1993). The Practical Handbook of Compost Engineering. p. 2. CRC Press, Inc., 2000 Corporate Blvd. N.W., Boca Raton, FL 33431 USA.

8 - Cannon, Charles A., (1997). *Life Cycle Analysis and Sustainability Moving Beyond the Three R's - Reduce, Reuse, and Recycle - to P2R2 - Preserve, Purify, Restore and Remediate*. As seen in the 1997 Organic Recovery and Biological Treatment Proceedings, Stentiford, E.I. (ed.). International Conference, Harrogate, United Kingdom. 3-5 September, 1997. P. 253. Available from Stuart Brown, National Compost Development Association, PO Box 4, Grassington, North Yorkshire, BD23 5UR UK (stuartbrown@compuserve.com).

9 - Howard, Sir Albert, (1943). An Agricultural Testament. Oxford University Press: New York.

10 - Bhamidimarri, R. (1988). Alternative Waste Treatment Systems. Elsevier Applied Science Publishers LTD., Crown House, Linton Road, Barking, Essex, IG11 8JU, England. (p.129).

11 - Rynk, Robert, ed. (1992). On-Farm Composting Handbook. Northeast Regional Agricultural Engineering Service. Ph:

(607) 255-7654. p. 12.

12 - Haug, Roger T. (1993). The Practical Handbook of Compost Engineering. p. 2. CRC Press, Inc., 2000 Corporate Blvd. N.W., Boca Raton, FL 33431 USA.

13 - Palmisano, Anna C. and Barlaz, Morton A. (Eds.) (1996). Microbiology of Solid Waste. P. 129. CRC Press, Inc., 2000 Corporate Blvd., N.W., Boca Raton, FL 33431 USA.

14 - Howard, Sir Albert, (1943). An Agricultural Testament. (p.48).

15 - Ingham, Elaine (1998). *Anaerobic Bacteria and Compost Tea*. *Biocycle*, June 1998, p 86. The JG Press, Inc., 419 State Avenue, Emmaus, PA 18049.

16 - Stoner, C.H. (Ed.). (1977). Goodbye to the Flush Toilet. Rodale Press: Emmaus, PA, 1977. (p.46).

17 - Rodale, J.I. et al. (Eds.). (1960). The Complete Book of Composting. Rodale Books Inc.: Emmaus, Pa (pp.646-647).

18 - Gotaas, Harold B., (1956). Composting - Sanitary Disposal and Reclamation of Organic Wastes. p.39. World Health Organization, Monograph Series Number 31. Geneva.

19 - *Mixing Browns and Greens For Backyard Success*. *Biocycle*, Journal of Composting and Recycling, January 1998. p. 20 (Regional Roundup). JG Press, Inc., 419 State Ave., Emmaus, PA 18049 USA.

20 - Brock, Thomas D. (1986). Thermophiles - General, Molecular, and Applied Biology. p.4. John Wiley and Sons, Inc.

21 - Madigan, Michael T. et al. (1997). Brock Biology of Microorganisms, Eighth edition. Pp. 150, 167. Information about water heaters, as well as temperature ranges of bacteria.

22 - Waksman, S.A. (1952). Soil Microbiology. John Wiley and Sons, Inc., New York. (p.70).

23 - Rynk, Robert, ed. (1992). On-Farm Composting Handbook. Northeast Regional Agricultural Engineering Service. Ph: (607) 255-7654. p. 55.

24 - Thimann, K.V. (1955). The Life of Bacteria: Their Growth, Metabolism, and Relationships. The Macmillan Co., New York. (p.177).

25 - Wade, Nicholas (1996). *Universal Ancestor*. The New York Times, as seen in the Pittsburgh Post-Gazette, Monday, August 26, 1996, p. A-8.

26 - Brock, Thomas D. (1986). Thermophiles - General, Molecular, and Applied Biology. p.23. John Wiley and Sons, Inc.

27 - Bitton, Gabriel (1994). Wastewater Microbiology. p. 81. Wiley-Liss, Inc. 605 Third Avenue, New York, NY 10518-0012.

28 - Bitton, Gabriel (1994). Wastewater Microbiology. p. 212. Wiley-Liss, Inc. 605 Third Avenue, New York, NY 10518-

0012.

29 - Palmisano, Anna C. and Barlaz, Morton A. (Eds.) (1996). Microbiology of Solid Waste. P. 123. CRC Press, Inc., 2000 Corporate Blvd., N.W., Boca Raton, FL 33431 USA.

30 - Lynch, J.M. and Poole, N.L. (Eds.). (1979). Microbial Ecology: A Conceptual Approach. Blackwell Scientific Publications, London. (p.238).

31 - Sterritt, Robert M. (1988). Microbiology for Environmental and Public Health Engineers. P. 53. E. & F. N. Spon Ltd., New York, NY 10001 USA.

32 - Palmisano, Anna C. and Barlaz, Morton A. (Eds.) (1996). Microbiology of Solid Waste. Pp. 124, 125, 129, 133. CRC Press, Inc., 2000 Corporate Blvd., N.W., Boca Raton, FL 33431 USA.

33 - Ingham, Elaine (1998). Replacing Methyl Bromide with Compost. *Biocycle*, Journal of Composting and Recycling, December 1998. p. 80. JG Press, Inc., 419 State Ave., Emmaus, PA 18049 USA.

34 - Curry, Dr. Robin (1977). Composting of Source Separated Domestic Organic Waste by Mechanically Turned Open Air Windrowing. As seen in the 1997 Organic Recovery and Biological Treatment Proceedings, Stentiford, E.I. (ed.). International Conference, Harrogate, United Kingdom. 3-5 September, 1997. P. 184.

35 - *Applied Microbiology*, December 1969.

36 - Gotaas, Harold B., (1956). Composting - Sanitary Disposal and Reclamation of Organic Wastes (p.20). World Health Organization, Monograph Series Number 31. Geneva.

37 - Curry, Dr. Robin (1977). Composting of Source Separated Domestic Organic Waste by Mechanically Turned Open Air Windrowing. As seen in the 1997 Organic Recovery and Biological Treatment Proceedings, Stentiford, E.I. (ed.). International Conference, Harrogate, United Kingdom. 3-5 September, 1997. P. 183.

38 - Palmisano, Anna C. and Barlaz, Morton A. (Eds.) (1996). Microbiology of Solid Waste. P. 169. CRC Press, Inc., 2000 Corporate Blvd., N.W., Boca Raton, FL 33431 USA.

39 - Palmisano, Anna C. and Barlaz, Morton A. (Eds.) (1996). Microbiology of Solid Waste. Pp. 121, 124, 134. CRC Press, Inc., 2000 Corporate Blvd., N.W., Boca Raton, FL 33431 USA.

40 - Rodale, J. I. (1960). The Complete Book of Composting. p. 702. Rodale Books, Inc., Emmaus, PA.

41 - Curry, Dr. Robin (1977). Composting of Source Separated Domestic Organic Waste by Mechanically Turned Open Air Windrowing. As seen in the 1997 Organic Recovery and Biological Treatment Proceedings, Stentiford, E.I. (ed.). International Conference, Harrogate, United Kingdom. 3-5 September, 1997. P. 183.

42 - Brock, Thomas D. (1986). Thermophiles - General, Molecular, and Applied Biology. p.244. John Wiley and Sons, Inc.

43 - Rynk, Robert, ed. (1992). On-Farm Composting Handbook. Northeast Regional Agricultural Engineering Service. Ph:

(607) 255-7654. p. 13.

44 - *Biocycle*, November 1998, p.18.

45 - Rodale, J. I. (1960). The Complete Book of Composting. p. 932. Rodale Books, Inc., Emmaus, PA.

46 - Smalley, Curtis (1998). *Hard Earned Lessons on Odor Management*. *Biocycle*, Journal of Composting and Recycling, January 1998. p. 59. JG Press, Inc., 419 State Ave., Emmaus, PA 18049 USA.

47 - Brinton, William F. Jr. (date unknown). *Sustainability of Modern Composting - Intensification Versus Cost and Quality*. Woods End Institute, PO Box 297, Mt. Vernon, Maine 04352 USA.

48 - Brinton, William F. Jr. (date unknown). *Sustainability of Modern Composting - Intensification Versus Cost and Quality*. Woods End Institute, PO Box 297, Mt. Vernon, Maine 04352 USA.

49 - Palmisano, Anna C. and Barlaz, Morton A. (Eds.) (1996). Microbiology of Solid Waste. P. 170. CRC Press, Inc., 2000 Corporate Blvd., N.W., Boca Raton, FL 33431 USA.

50 - *Researchers Study Composting in the Cold*. *Biocycle*, Journal of Composting and Recycling, January 1998. p. 24 (Regional Roundup). JG Press, Inc., 419 State Ave., Emmaus, PA 18049 USA.

51 - Gotaas, Harold B., (1956). Composting - Sanitary Disposal and Reclamation of Organic Wastes. p.77. World Health Organization, Monograph Series Number 31. Geneva.

52 - Regan, Raymond W. (1998). *Approaching 50 years of Compost Research*. *Biocycle*, Journal of Composting and Recycling, October 1998. p. 82. JG Press, Inc., 419 State Ave., Emmaus, PA 18049 USA.

53 - Howard, Sir Albert (1943). An Agricultural Testament. Oxford University Press: New York. (p.44). Also see: Rodale, J.I. (1946). *Pay Dirt*. The Devon-Adair Co.: New York.

54 - Rodale, J.I. et al. (Eds.) (1960). The Complete Book of Composting. Rodale Books Inc.: Emmaus, PA (p.658).

55 - Regan, Raymond W. (1998). *Approaching 50 years of Compost Research*. *Biocycle*, Journal of Composting and Recycling, October 1998. p. 82. JG Press, Inc., 419 State Ave., Emmaus, PA 18049 USA.

56 - Poncavage, J. and Jesiolowski, J. (1991). Mix Up a Compost and a Lime. *Organic Gardening*. March 1991, Vol. 38, Issue 3. (p.18).

57 - Gotaas, Harold B., (1956). Composting - Sanitary Disposal and Reclamation of Organic Wastes. p.93. World Health Organization, Monograph Series Number 31. Geneva.

58 - Palmisano, Anna C. and Barlaz, Morton A. (Eds.) (1996). Microbiology of Solid Waste. P. 132. CRC Press, Inc., 2000 Corporate Blvd., N.W., Boca Raton, FL 33431 USA.

59 - US EPA (1998). An Analysis of Composting as an Environmental Remediation Technology. EPA530-B-98-001,

March 1998.

60 - Haug, Roger T. (1993). The Practical Handbook of Compost Engineering. p. 9. CRC Press, Inc., 2000 Corporate Blvd. N.W., Boca Raton, FL 33431 USA.

61 - US EPA (October 1997). *Innovative Uses of Compost - Bioremediation and Pollution Prevention*. EPA530-F-97-042.

62 - US EPA (1998). An Analysis of Composting as an Environmental Remediation Technology. EPA530-B-98-001, March 1998.

63 - Cannon, Charles A., (1997). Life Cycle Analysis and Sustainability Moving Beyond the Three R's - Reduce, Reuse, and Recycle - to P2R2 - Preserve, Purify, Restore and Remediate. As seen in the 1997 Organic Recovery and Biological Treatment Proceedings, Stentiford, E.I. (ed.). International Conference, Harrogate, United Kingdom. 3-5 September, 1997. P. 253. Available from Stuart Brown, National Compost Development Association, PO Box 4, Grassington, North Yorkshire, BD23 5UR UK (stuartbrown@compuserve.com).

64 - US EPA (October 1997). *Innovative Uses of Compost - Bioremediation and Pollution Prevention*. EPA530-F-97-042.

65 - Logan, W.B. (1991). "Rot is Hot." *New York Times Magazine*. 9/8/91, Vol. 140, Issue 4871. (p.46).

66 - *Compost Fungi Used to Recover Wastepaper*. Biocycle, Journal of Composting and Recycling, May 1998. p. 6 (Biocycle World). JG Press, Inc., 419 State Ave., Emmaus, PA 18049 USA.

67 - Young, Lily Y., and Cerniglia, Carl E. (Eds.) (1995). Microbial Transformation and Degradation of Toxic Organic Chemicals. Pp. 408, 461, and Table 12.5. Wiley-Liss, Inc. 605 Third Avenue, New York, NY 10518-0012.

68 - Palmisano, Anna C. and Barlaz, Morton A. (Eds.) (1996). Microbiology of Solid Waste. P. 127. CRC Press, Inc., 2000 Corporate Blvd., N.W., Boca Raton, FL 33431 USA.

69 - Logan, W.B. (1991). "Rot is Hot." *New York Times Magazine*. 9/8/91, Vol. 140, Issue 4871. (p.46).

70 - Lubke, Sigfried. (1989). Interview: All Things Considered in the Wake of the Chernobyl Nuclear Accident. *Acres U.S.A.* December 1989. (p. 20) [also contact Uta and Sigfried Lubke, A4722 Peuerbach, Untererleinsbach 1, Austria]

71 - US EPA (1998). An Analysis of Composting as an Environmental Remediation Technology. EPA530-B-98-001, March 1998.

72 - Cannon, Charles A., (1997). *Life Cycle Analysis and Sustainability Moving Beyond the Three R's - Reduce, Reuse, and Recycle - to P2R2 - Preserve, Purify, Restore and Remediate*. As seen in the 1997 Organic Recovery and Biological Treatment Proceedings, Stentiford, E.I. (ed.). International Conference, Harrogate, United Kingdom. 3-5 September, 1997. P. 254. Available from Stuart Brown, National Compost Development Association, PO Box 4, Grassington, North Yorkshire, BD23 5UR UK (stuartbrown@compuserve.com).and Schonberner, Doug (1998). *Reclaiming Contaminated Soils*, as well as Block, Dave (1998). *Composting Breaks Down Explosives*. Biocycle, Journal of Composting and Recycling, September 1998, 36-40.

73 - US EPA (1998). An Analysis of Composting as an Environmental Remediation Technology. EPA530-B-98-001,

March 1998.

74 - Block, Dave (1998). *Degrading PCB's Through Composting*. Biocycle, Journal of Composting and Recycling, December 1998. p. 45-48. JG Press, Inc., 419 State Ave., Emmaus, PA 18049 USA.

75 - US EPA (October 1997). *Innovative Uses of Compost - Bioremediation and Pollution Prevention*. EPA530-F-97-042.

76 - US EPA (October 1997). *Innovative Uses of Compost - Bioremediation and Pollution Prevention*. EPA530-F-97-042.

77 - Rynk, Robert, ed. (1992). On-Farm Composting Handbook. Northeast Regional Agricultural Engineering Service. Ph: (607) 255-7654. p. 83.

78 - Hoitink, Harry A. J. et al., (1997). Suppression of Root and Foliar Diseases Induced by Composts. As seen in the 1997 Organic Recovery and Biological Treatment Proceedings, Stentiford, E.I. (ed.). International Conference, Harrogate, United Kingdom. 3-5 September, 1997. p. 95.

79 - US EPA (October 1997). *Innovative Uses of Compost - Disease Control for Plants and Animals*. EPA530-F-97-044.

80 - US EPA (1998). An Analysis of Composting as an Environmental Remediation Technology. EPA530-B-98-001, March 1998.

81 - Logan, W.B. (1991). "Rot is Hot". *New York Times Magazine*. 9/8/91, Vol. 140, Issue 4871. (p.46).

82 - US EPA (1998). An Analysis of Composting as an Environmental Remediation Technology. EPA530-B-98-001, March 1998.

83 - Trankner, Andreas, and Brinton, William (date unknown). *Compost Practices for Control of Grape Powdery Mildew (Uncinula necator)*. Woods End Institute, PO Box 297, Mt. Vernon, Maine 04352 USA.

84 - Quote from Elaine Ingham as reported in: Grobe, Karin (1998). *Fine-Tuning the Soil Web*. Biocycle, Journal of Composting and Recycling, January 1998. p. 46. JG Press, Inc., 419 State Ave., Emmaus, PA 18049 USA.

85 - Sides, S. (1991). Compost. *Mother Earth News*. Issue 127, Aug/Sept 1991 (p.50).

86 - US EPA (October 1997). *Innovative Uses of Compost - Disease Control for Plants and Animals*. EPA530-F-97-044.

87 - Biocycle, Journal of Composting and Recycling, October 1998. p. 26. JG Press, Inc., 419 State Ave., Emmaus, PA 18049 USA.

88 - US EPA (October 1997). *Innovative Uses of Compost - Disease Control for Plants and Animals*. EPA530-F-97-044.

89 - Brodie, Herbert L., and Carr, Lewis E. (1997). Composting Animal Mortality. As seen in the 1997 Organic Recovery and Biological Treatment Proceedings, Stentiford, E.I. (ed.). International Conference, Harrogate, United Kingdom. 3-5 September, 1997. Pp. 155-159.

- 90 - McKay, Bart (1998). *Com-Postal-Ing in Texas*. Biocycle, Journal of Composting and Recycling, May 1998. p. 44-46. JG Press, Inc., 419 State Ave., Emmaus, PA 18049 USA.
- 91 - *Garbage: the Practical Journal for the Environment*. May/June 1992, p.66, Old House Journal Corp., 2 Main St., Gloucester, MA 01930.
- 92 - Logan, W.B. (1991). "Rot is Hot." *New York Times Magazine*. 9/8/91, Vol. 140, Issue 4871.
- 93 - Biocycle, Journal of Composting and Recycling, November 1998. p. 18. JG Press, Inc., 419 State Ave., Emmaus, PA 18049 USA.

REFERENCES - CHAPTER FOUR - DEEP SH*T

- 1 - Bulletin of the Atomic Scientists. September/October 1998.
- 2 - Wilson, N.W., (1966). Three Ways of Asian Wisdom. Simon and Shuster: New York. (p.11-12).
- 3 - Ibid. (p.77-78).
- 4 - Ibid. (p.137).
- 5 - Ibid. (p.145).
- 6 - Ibid. (p.140).
- 7 - Lao Tsu. Tao Te Ching. Vintage Books Edition, 1972. Vintage Books (Random House): New York. (#57).
- 8 - Holy Bible. King James Version. The World Publishing Co.: New York. (p.9).
- 9 - Rodale, J. I., (1946). Paydirt, Devon-Adair Co.: NY, (p.vi).
- 10 - *Beyond Oil: The Threat to Food and Fuel in the Coming Decades, A summary Report*. November 1986. Carrying Capacity Inc., 1325 G. Street, NW, Suite 1003, Wash. D.C. 10005.
- 11 - King, F.H., (1911). Farmers of Forty Centuries. Rodale Press: Emmaus, PA 18049.
- 12 - Ibid. (p.193, 196-7).
- 13 - Ibid. (p.10).
- 14 - Ibid. (p.19).
- 15 - Ibid. (p.199).

- 16 - White, A.D. (1955). The Warfare of Science with Theology. George Braziller: New York. (pp.68,70).
- 17 - Ibid. (p.69).
- 18 - Ibid. (p.71).
- 19 - Ibid. (p.73).
- 20 - Ibid. (pp.76-77).
- 21 - Ibid. (p.84).
- 22 - Ibid. (p.85).
- 23 - Reyburn, Wallace (1989). Flushed with Pride - The Story of Thomas Crapper. Pavilion Books Limited, 196 Shaftesbury Avenue, London WC2H 8JL. pp. 24-25.
- 24 - Seaman, L.C.B. (1973). Victorian England. Methuan & Co.: London. (pp. 48-56).
- 25 - Shuval, Hillel I. et al. (1981). Appropriate Technology for Water Supply and Sanitation - Night Soil Composting. Abstract. World Bank, Washington DC 20433, USA.
- 26 - Winblad, Uno, and Kilama, Wen (1985). Sanitation Without Water. Macmillan Education Ltd., London and Basingstoke. p. 12.
- 27 - Edmonds, Richard Louis (1994). Patterns of China's Lost Harmony - A Survey of the Country's Environmental Degradation and Protection. p. 9, 132, 137, 142, 146, 156. Routledge, 11 New Fetter Lane, London EC4P 4EE and 29 West 35th Street, New York, NY 10001.
- 28 - Hoitink, Harry A. J. et al., (1997). *Suppression of Root and Foliar Diseases Induced by Composts*. As seen in the 1997 Organic Recovery and Biological Treatment Proceedings, Stentiford, E.I. (ed.). International Conference, Harrogate, United Kingdom. 3-5 September, 1997. p. 97.
- 29 - Farmers of Forty Centuries. (p.198).

REFERENCES - CHAPTER FIVE - A DAY IN THE LIFE OF A TURD

- 1 - Mancini, K. *Septic Tank - Soil Absorption Systems*. Agricultural Engineering Fact Sheet SW-44. Penn State College of Agriculture Cooperative Extension, University Park, PA 16802.
- 2 - Mancini, K. *Mound Systems for Wastewater Treatment*. SW-43. Same as above.

- 3 - Stewart, John G. (1990). Drinking Water Hazards: How to Know if There Are Toxic Chemicals in Your Water and What to Do If There Are. Envirographics: Hiram, Ohio. (pp.177-178).
- 4 - van der Leeden, F. et al. (1990). The Water Encyclopedia. Lewis Publishers Inc.: Chelsea, Michigan, 48118. (p.526).
- 5 - Ibid. (p.525).
- 6 - Stewart, John G. (as in #3 above, same pages).
- 7 - Ibid.
- 8 - Environment Reporter. 2/28/92. The Bureau of National Affairs, Inc., Washington D.C., (pp. 2441-2).
- 9 - Gray, N.F. (1990). Activated Sludge Theory and Practice. Oxford University Press: New York. (p.125).
- 10 - Journal of Environmental Health. July/August 1989. "EPA Proposes New Rules for Sewage Sludge Disposal". (P.321).
- 11 - Logan, W.B. (1991). "Rot is Hot." New York Times Magazine. 9/8/91 Vol. 140, Issue 4871, p.46.
- 12 - van der Leeden, F. et al. (1990). The Water Encyclopedia Second Edition. Lewis Publishers, 121 South Main Street, Chelsea, Michigan 48118 (p. 541).
- 13 - Garbage. February/March 1993. Old House Journal Corp., 2 Main St., Gloucester, MA 01930. (p.18).
- 14 - Pickford, John (1995). Low-Cost Sanitation - A Survey of Practical Experience. p. 96. IT Publications, 103-105 Southampton Row, London WC1B 4HH, UK.
- 15 - US EPA (1996). Wastewater Treatment: Alternatives to Septic Systems (Guidance Document). EPA/909-K-96-001. US Environmental Protection Agency, Region 9, Drinking Water Program (W-6-3). p. 16-19. and:US EPA (1987). It's Your Choice - A Guidebook for Local Officials on Small Community Wastewater Management Options. EPA 430/9-87-006. United States Environmental Protection Agency, Office of Municipal Pollution Control (WH-595), Municipal Facilities Division, Washington DC 20460. p.55.
- 16 - Manahan, S.E. (1990). Hazardous Waste Chemistry, Toxicology and Treatment. Lewis Publishers, Inc.: Chelsea, Michigan. (p.131).
- 17 - Bitton, Gabriel (1994). Wastewater Microbiology. p. 120. Wiley-Liss, Inc. 605 Third Avenue, New York, NY 10518-0012.
- 18 - Ibid. (pp. 148-49).
- 19 - Baumann, Marty. USA Today. Feb 2, 1994, p. 1A, 4A. USA Today (Gannet Co. Inc.) 1000 Wilson Blvd., Arlington, VA 22229.

- 20 - "The Perils of Chlorine." *Audubon Magazine*, 93:30-2. Nov/Dec 1991.
- 21 - Liptak, B.G. (1991). Municipal Waste Disposal in the 1990's. Chilton Book Co.: Radnor, PA. (pp.196-8).
- 22 - Bitton, Gabriel (1994). Wastewater Microbiology. p. 312. Wiley-Liss, Inc. 605 Third Avenue, New York, NY 10518-0012.
- 23 - Stiak, J. "The Trouble With Chlorine." *Buzzworm*. Nov/Dec 1992. (p.22).
- 24 - Bitton, Gabriel (1994). Wastewater Microbiology. p. 121. Wiley-Liss, Inc. 605 Third Avenue, New York, NY 10518-0012.
- 25 - Environment Reporter. 7/10/92. (p.767).
- 26 - Bitton, Gabriel (1994). Wastewater Microbiology. p. 121. Wiley-Liss, Inc. 605 Third Avenue, New York, NY 10518-0012.
- 27 - *Buzzworm*. March/April 1993. (p.17).
- 28 - *Environment Reporter*. 7/10/92. (p.767).
- 29 - Ibid. 4/24/92. (p.2879).
- 30 - Ibid. 8/7/92. (p.1155).
- 31 - Burke, W.K. "A Prophet of Eden." *Buzzworm*. Vol. IV, Number 2, March/April 1992. (pp.18-19).
- 32 - Environment Reporter. 8/7/92. (P.1152).
- 33 - Ibid. 5/15/92. (p.319).
- 34 - Bitton, Gabriel (1994). Wastewater Microbiology. p. 352. Wiley-Liss, Inc. 605 Third Avenue, New York, NY 10518-0012.
- 35 - Ibid. 3/6/92 (p. 2474) and 1/17/92 (p.2145).
- 36 - Ibid. 1/3/92 (p.2109).
- 37 - Ibid. 11/1/91 (p.1657) and 9/27/96 (p. 1212).
- 38 - Hammond, A. et al. (Eds.) (1993). The 1993 Information Please Environmental Almanac. Compiled by the World Resources Institute. Houghton Mifflin Co.: New York. (p.41).
- 39 - Purves, D. (1990). "Toxic Sludge." *Nature*. Vol. 346, 8/16/1990 (pp. 617-18).

- 40 - Bitton, Gabriel (1994). Wastewater Microbiology. p. 352. Wiley-Liss, Inc. 605 Third Avenue, New York, NY 10518-0012.
- 41 - Rybczynski, W. et al. (1982). Appropriate Technology for Water Supply and Sanitation - Low Cost Technology Options for Sanitation, A State of the Art Review and Annotated Bibliography. World Bank. (p. 124).
- 42 - Ibid. (p. 125).
- 43 - Sterritt, Robert M. (1988). Microbiology for Environmental and Public Health Engineers. P. 160. E. & F. N. Spon Ltd., New York, NY 10001 USA.
- 44 - Fahm, L.A. (1980). The Waste of Nations. Allanheld, Osmun & Co.: Montclair, NJ (p.61).
- 45 - Shuval, Hillel I. et al. (1981). Appropriate Technology for Water Supply and Sanitation - Night Soil Composting. p.5. International Bank for Reconstruction and Development (World Bank), Washington DC, 20433, USA
- 46 - Bitton, Gabriel (1994). Wastewater Microbiology. p. 166, 352. Wiley-Liss, Inc. 605 Third Avenue, New York, NY 10518-0012.
- 47 - Sterritt, Robert M. (1988). Microbiology for Environmental and Public Health Engineers. P. 242, 251-2. E. & F. N. Spon Ltd., New York, NY 10001 USA.
- 48 - Radtke, T.M., and Gist, G.L. (1989). "Wastewater Sludge Disposal: Antibiotic Resistant Bacteria May Pose Health Hazard." *Journal of Environmental Health*. Vol 52, No.2, Sept/Oct 1989. (pp.102-5).
- 49 - *Environment Reporter*. 7/10/92. (p.770).
- 50 - *Environment Reporter*. 11/1/91. (p.1653).
- 51 - Ibid. 1/17/92. (p.2154).
- 52 - Damsker, M. (1992). "Sludge Beats Lead." *Organic Gardening*. Feb, 1992, Vol. 39, Issue 2, p.19.
- 53 - Contact JCH Environmental Engineering, Inc., 2730 Remington Court, Missoula, MT 59801-7121. Phone (406) 721-1164.
- 54 - Miller, T. L. et al., (1992). *Selected Metal and Pesticide Content of Raw and Mature Compost Samples from Eleven Illinois Facilities*. Illinois Department of Energy and Natural Resources. and: Manios, T. and Stentiford, E.I. (1998). Heavy Metals Fractionation Before, During, and After Composting of Urban Organic Residues. As seen in the 1997 Organic Recovery and Biological Treatment Proceedings, Stentiford, E.I. (ed.). International Conference, Harrogate, United Kingdom. 3-5 September, 1997. p. 227-232.
- 55 - US EPA, (1989) - Summary Report: In-Vessel Composting of Municipal Wastewater Sludge. pp. 20, 161. EPA/625/8-89/016. Center for Environmental Research Information, Cincinnati, OH.

56 - Fahm. (1980). The Waste of Nations. (p.xxiv).

57 - Ibid. (p.40).

58 - Shuval, Hillel I. et al. (1981). Appropriate Technology for Water Supply and Sanitation - Night Soil Composting. (summary). International Bank for Reconstruction and Development (World Bank), Washington DC, 20433, USA.

59 - Rivard, C.J. et al. (1989). "Waste to Energy." *Journal of Environmental Health*. Vol 52, No.2, Sept/Oct 1989. (p.100).

60 - See *Garbage*, Oct/Nov 1992, (p.14).

REFERENCES - CHAPTER SIX - COMPOSTING TOILETS & SYSTEMS

1 - Rybczynski, W. et al. (1982). Appropriate Technology for Water Supply and Sanitation - Low Cost Technology Options for Sanitation, A State of the Art Review and Annotated Bibliography. World Bank. Transportation and Water Department, 1818 H Street N.W., Washington D.C. 20433 USA.

2 - Franceys et al. (1992). A Guide to the Development of On-Site Sanitation. World Health Organization, Geneva. (p. 213).

3 - McGarry, Michael G., and Stainforth, Jill (eds.) (1978). Compost, Fertilizer, and Biogas Production from Human and Farm Wastes in the People's Republic of China. International Development Research Center, Box 8500, Ottawa, Canada, K1G 3H9 (pages 9, 10, 29, 32).

4 - Rybczynski, W. et al. (1982). Appropriate Technology for Water Supply and Sanitation - Low Cost Technology Options for Sanitation, A State of the Art Review and Annotated Bibliography. World Bank. Transportation and Water Department, 1818 H Street N.W., Washington D.C. 20433 USA. (p. 114).

5 - McGarry, Michael G., and Stainforth, Jill (eds.) (1978). Compost, Fertilizer, and Biogas Production from Human and Farm Wastes in the People's Republic of China. International Development Research Center, Box 8500, Ottawa, Canada, K1G 3H9.

6 - Winblad, Uno, and Kilama, Wen (1985). Sanitation Without Water. Macmillan Education Ltd., London and Basingstoke. pp. 20-21.

7 - Winblad, Uno (Ed.) (1998). Ecological Sanitation. Swedish International Development Cooperation Agency, Stockholm, Sweden. p. 25.

8 - Rybczynski, W. et al. (1982). Appropriate Technology for Water Supply and Sanitation - Low Cost Technology Options for Sanitation, A State of the Art Review and Annotated Bibliography. World Bank. Transportation and Water Department, 1818 H Street N.W., Washington D.C. 20433 USA.

9 - Ibid.

10 - Clivus Multrum Maintenance Manual, Clivus Multrum, Inc., 21 Canal St., Lawrence, Mass. 01840. (Also contact Hanson Assoc., Lewis Mill, Jefferson, MD 21755).

11 - Ibid.

12 - Ibid.

13 - Source: Pickford, John (1995). Low-Cost Sanitation, Intermediate Technology Publications, 103-105 Southampton Row, London WC1B 4HH, UK. p. 68.

14 - Sun Mar Corp., 900 Hertel Ave., Buffalo, NY 14216 USA; or 5035 North Service Road, Burlington, Ontario, Canada L7L 5V2.

15 - AlasCan, Inc., 3400 International Way, Fairbanks, Alaska 99701, phone/fax (907) 452-5257 [as seen in *Garbage*, Feb/Mar 1993, p.35].

16 - Composting Toilet Systems, PO Box 1928 (or 1211 Bergen Rd.), Newport, WA 99156, phone: (509) 447-3708; Fax: (509) 447-3753.

REFERENCES - CHAPTER SEVEN - WORMS AND DISEASE

1 - Kristof, Nicholas D. (1995). *Japanese is Too Polite for Words*. Pittsburgh Post Gazette, Sunday, September 24, 1995. P. B-8.

2 - Beeby, John (1995). The Tao of Pooh (now titled Future Fertility). Disclaimer, and pp. 64-65. Ecology Action of the Midpeninsula, 5798 Ridgewood Road, Willits, CA 95490-9730.

3 - Beeby, John (1995). The Tao of Pooh (now titled Future Fertility). Pp. 11-12. Ecology Action of the Midpeninsula, 5798 Ridgewood Road, Willits, CA 95490-9730.

4 - Barlow, Ronald S. (1992). The Vanishing American Outhouse. P. 2. Windmill Publishing Co., 2147 Windmill View Road, El Cajon, California 92020 USA.

5 - Warren, George M. (1922 - revised 1928). Sewage and Sewerage of Farm Homes. US Department of Agriculture, Farmer's Bulletin No. 1227. As seen in: Barlow, Ronald S. (1992). The Vanishing American Outhouse. Pp. 107-110. Windmill Publishing Co., 2147 Windmill View Road, El Cajon, California 92020 USA.

6 - Shuval, Hillel I. et al. (1981). Appropriate Technology for Water Supply and Sanitation - Night Soil Composting. p.8. International Bank for Reconstruction and Development (World Bank), Washington DC, 20433, USA.

7 - Tompkins, P., and Boyd, C. (1989). Secrets of the Soil. Harper and Row: New York. (pp.94-5).

8 - Howard, Sir Albert. The Soil and Health: A Study of Organic Agriculture. Schocken: New York. 1947. (pp. 37-38).

9 - Ibid. (p.177).

10 - Feachem, et al. (1980). Appropriate Technology for Water Supply and Sanitation. The World Bank, Director of Information and Public Affairs, Washington D.C. 20433.

11 - Sterritt, Robert M. (1988). Microbiology for Environmental and Public Health Engineers. P. 238. E. & F. N. Spon Ltd., New York, NY 10001 USA.

12 - Jervis, N. "Waste Not, Want Not". *Natural History*. May, 1990 (p.73).

13 - Winblad, Uno (Ed.) (1998). Ecological Sanitation. Swedish International Development Cooperation Agency, Stockholm, Sweden. p. 75.

14 - Sterritt, Robert M. (1988). Microbiology for Environmental and Public Health Engineers. Pp. 59-60. E. & F. N. Spon Ltd., New York, NY 10001 USA.

15 - Palmisano, Anna C. and Barlaz, Morton A. (Eds.) (1996). Microbiology of Solid Waste. Pp. 159. CRC Press, Inc., 2000 Corporate Blvd., N.W., Boca Raton, FL 33431 USA.

16 - Gotaas, Harold B., (1956). Composting - Sanitary Disposal and Reclamation of Organic Wastes. p.20. World Health Organization, Monograph Series Number 31. Geneva.

17 - Sopper, W.E. and Kardos, L.T. (Eds.). (1973). Recycling Treated Municipal Wastewater and Sludge Through Forest and Cropland. The Pennsylvania State University, University Park, PA (pp. 248-51).

18 - Ibid. (pp. 251-252).

19 - Shuval, Hillel I. et al. (1981). Appropriate Technology for Water Supply and Sanitation - Night Soil Composting. p.4. International Bank for Reconstruction and Development (World Bank), Washington DC, 20433, USA.

20 - Sterritt, Robert M. (1988). Microbiology for Environmental and Public Health Engineers. P. 252. E. & F. N. Spon Ltd., New York, NY 10001 USA.

21 - Cheng, Thomas C. (1973). General Parasitology. Academic Press, Inc., 111 Fifth Avenue, New York, NY 10003 (p. 645).

22 - Shuval, Hillel I. et al. (1981). Appropriate Technology for Water Supply and Sanitation - Night Soil Composting. p.6. International Bank for Reconstruction and Development (World Bank), Washington DC, 20433, USA.

23 - Feachem et al. (1980). Appropriate Technology for Water Supply and Sanitation: Health Aspects of Excreta and Sullage Management. Energy, Water and Telecommunications Department of the World Bank, 1818 H Street N.W., Washington D.C. 20433. This comprehensive work cites 394 references from throughout the world, and was carried out as part of the World Bank's research project on appropriate technology for water supply and sanitation.

24 - Ibid.

- 25 - Olson, O. W. (1974). Animal Parasites - Their Life Cycles and Ecology. University Park Press, Baltimore, MD (p. 451-452).
- 26 - Crook, James (1985). "Water Reuse in California." *Journal of the American Waterworks Association*. v77, no. 7. as seen in The Water Encyclopedia by van der Leeden et al. (1990), Lewis Publishers, Chelsea, Mich. 48118.
- 27 - Boyd, R. F. and Hoerl, B. G. (1977). Basic Medical Microbiology. Little, Brown and Co., Boston Mass. (p. 494).
- 28 - Cheng, Thomas C. (1973) General Parasitology. Academic Press Inc., 111 Fifth Ave., New York, NY 10003. (p. 645).
- 29 - Sterritt, Robert M. (1988). Microbiology for Environmental and Public Health Engineers. Pp. 244-245. E. & F. N. Spon Ltd., New York, NY 10001 USA.
- 30 - Epstein, Elliot (1998). "Pathogenic Health Aspects of Land Application." *Biocycle*, September 1998, p.64. The JG Press, Inc., 419 State Avenue, Emmaus, PA 18049.
- 31 - Shuval, Hillel I. et al. (1981). Appropriate Technology for Water Supply and Sanitation - Night Soil Composting. p.5. International Bank for Reconstruction and Development (World Bank), Washington DC, 20433, USA.
- 32 - Franceys, R. et al. (1992). A Guide to the Development of On-Site Sanitation. World Health Organization, Geneva. p. 212.
- 33 - Schoenfeld, M., and Bennett, M. (1992). Water Quality Analysis of Wolf Creek. (Unpublished manuscript). Slippery Rock University, Applied Ecology Course, PREE, Fall Semester. (Prof. P. Johnson), Slippery Rock, PA 16057
- 34 - Pomeranz, V.E. and Schultz, D., (1972). The Mother's and Father's Medical Encyclopedia. The New American Library, Inc., 1633 Broadway, New York, NY 10019. (p.627).
- 35- Chandler, A.C. and Read, C.P. (1961). Introduction to Parasitology. John Wiley and Sons, Inc.: New York.
- 36 - Brown, H.W. and Neva, F.A. (1983). Basic Clinical Parasitology. Appleton-Century-Crofts/Norwalk, Connecticut 06855. (pp.128-31). Pinworm destruction by composting mentioned in: Gotaas, Harold B., (1956). Composting - Sanitary Disposal and Reclamation of Organic Wastes . p.20. World Health Organization, Monograph Series Number 31. Geneva.
- 37 - Brown, H.W. and Neva, F.A. (1983). Basic Clinical Parasitology. Appleton-Century-Crofts/Norwalk, Connecticut 06855. (pp.119-126).
- 38 - Ibid.
- 39 - Ibid.
- 40 - Haug, Roger T. (1993). The Practical Handbook of Compost Engineering. p. 141. CRC Press, Inc., 2000 Corporate Blvd. N.W., Boca Raton, FL 33431 USA.
- 41 - Shuval, Hillel I. et al. (1981). Appropriate Technology for Water Supply and Sanitation - Night Soil Composting. p.4.

International Bank for Reconstruction and Development (World Bank), Washington DC, 20433, USA.

42 - Franceys, R. et al. (1992). A Guide to the Development of On-Site Sanitation. World Health Organization, Geneva. p. 214.

43 - Shuval, Hillel I. et al. (1981). Appropriate Technology for Water Supply and Sanitation - Night Soil Composting. p.7. International Bank for Reconstruction and Development (World Bank), Washington DC, 20433, USA.

REFERENCES - CHAPTER EIGHT - THE TAO OF COMPOST

1 - LaMotte Chemical Products Co., Chestertown, MD 21620

2 - Rodale, J. I., (1960). The Complete Book of Composting. P. 650, Rodale Books, Emmaus, PA.

3 - Kitto, Dick. (1988). Composting: The Organic Natural Way. Thorsons Publishers Ltd.: Wellingborough, England. (p. 103).

4 - World of Composting Toilets Forum Update No. 3, Monday, November 2, 1998. Reply to: earthwise@earthwise.nwnet.co.uk.

5 - Del Porto, David, and Steinfeld, Carol (1999). The Composting Toilet System Book - editor's draft. Center for Ecological Pollution Prevention, PO Box 1330, Concord, MA 01742-1330.

6 - Olexa, M. T. and Trudeau, Rebecca L., (1994). *How is the Use of Compost Regulated?* University of Florida, Florida Cooperative Extension Service, Document No. SS-FRE-19, September 1994.

7 - Pennsylvania Solid Waste Management Act, Title 35, Chapter 29A.

8 - Pennsylvania Municipal Waste Planning, Recycling and Waste Reduction Act (1988), Title 53, Chapter 17A.

9 - King, F.H. (1911). Farmers of Forty Centuries. Rodale Press, Inc., Emmaus, PA 18049. (pp.78, 202).

REFERENCES - CHAPTER NINE - ALTERNATIVE GREY WATER SYSTEMS

1 - Waterless Toilets as Repair for Failed Septic Tank Systems. Bio-Sun Systems, Inc., RR #2, Box 134A, Millerton, PA 16936. Ph: 717-537-2200. Email: Bio-sun@ix.netcom.com

2 - US EPA (1992). Wastewater Treatment/Disposal for Small Communities. P. 42. EPA/625/R-92/005. US EPA Office of Research and Development, Office of Water, Washington DC 20460 USA.

3 - Bennett, Dick (1995). *Graywater, An Option for Household Water Reuse*. Home Energy Magazine, July/August, 1995.

- 4 - Gerba, Charles P. et al. (1995). *Water Quality Study of Graywater Treatment Systems*. Water Resources Bulletin, February, 1995, Vol. 31, No. 1, p. 109. American Water Resources Association.
- 5 - Rose, Joan B. et al. (1991). *Microbial Quality and Persistence of Enteric Pathogens in Graywater from Various Household Sources*. Water Resources, Vol. 25, No. 1, pp. 37-42, 1991.
- 6 - Karpiscak, Martin M. et al. (1990). *Residential Water Conservation: Casa del Agua*. Water Resources Bulletin, December 1990, p. 945-946. American Water Resources Association.
- 7 - Gerba, Charles P. et al. (1995). *Water Quality Study of Graywater Treatment Systems*. Water Resources Bulletin, February, 1995, Vol. 31, No. 1, p. 109. American Water Resources Association.
- 8 - Karpiscak, Martin M. et al. (1990). *Residential Water Conservation: Casa del Agua*. Water Resources Bulletin, December 1990, p. 940. American Water Resources Association.
- 9 - Rose, Joan B. et al. (1991). *Microbial Quality and Persistence of Enteric Pathogens in Graywater from Various Household Sources*. Water Resources, Vol. 25, No. 1, p. 40, 1991.
- 10 - Karpiscak, Martin M. et al. (1990). *Residential Water Conservation: Casa del Agua*. Water Resources Bulletin, December 1990, p. 940. American Water Resources Association.
- 11 - Ludwig, Art (1994). Create an Oasis with Greywater. Oasis Design, 5 San Marcos Trout Club, Santa Barbara, CA 93105-9726. Phone: 805-967-9956.
- 12 - Bennett, Dick (1995). *Graywater, An Option for Household Water Reuse*. *Home Energy Magazine*, July/August, 1995.
- 13 - Rose, Joan B. et al. (1991). *Microbial Quality and Persistence of Enteric Pathogens in Graywater from Various Household Sources*. Water Resources, Vol. 25, No. 1, p. 40, 1991.
- 14 - Rose, Joan B. et al. (1991). *Microbial Quality and Persistence of Enteric Pathogens in Graywater from Various Household Sources*. Water Resources, Vol. 25, No. 1, pp. 37-38, 1991.
- 15 - Rose, Joan B. et al. (1991). *Microbial Quality and Persistence of Enteric Pathogens in Graywater from Various Household Sources*. Water Resources, Vol. 25, No. 1, pp. 39, 41, 1991.
- 16 - Bastian, Robert K. (date unknown). Needs and Problems in Sewage Treatment and Effluent Disposal Facing Small Communities; The Role of Wetland Treatment Alternatives. US EPA, Office of Municipal Pollution Control, Washington DC 20460.
- 17 - Hoang, Tawni et al. (1998). Greenhouse Wastewater Treatment with Constructed Wetlands. *Greenhouse Product News*, August 1998, p.33.
- 18 - Golueke, Clarence G. (1977). *Using Plants for Wastewater Treatment*. *Compost Science*, September/October 1977, p. 18.

- 19 - Berghage, R.D. et al. (date unknown). "Green" Water Treatment for the Green Industries: Opportunities for Biofiltration of Greenhouse and Nursery Irrigation Water and Runoff with Constructed Wetlands. and: Gupta, G.C. (1980). *Use of Water Hyacinths in Wastewater Treatment*. Journal of Environmental Health. 43(2):80-82. and: Joseph, J. (1978). *Hyacinths for Wastewater Treatment*. Reeves Journal. 56(2):34-36.
- 20 - Hillman, W.S. and Culley, D.D. Jr. (1978). *The Uses of Duckweed*. American Scientist, 66:442-451
- 21 - Pries, John (date unknown, but 1996 or later). *Constructed Treatment Wetland Systems in Canada*. Gore and Storrie Ltd., Suite 600, 180 King St. S., Waterloo, Ontario, N2J 1P8. Ph: 519-579-3500.
- 22 - Golueke, Clarence G. (1977). *Using Plants for Wastewater Treatment*. Compost Science, September/October 1977, p. 18.
- 23 - Golueke, Clarence G. (1977). *Using Plants for Wastewater Treatment*. Compost Science, September/October 1977, p. 17.
- 24 - For more information, contact Carl Lindstrom at: <http://www.greywater.com/>

REFERENCES - CHAPTER TEN - THE END IS NEAR

- 1 - Rybczynski, W. et. al. (1982). Appropriate Technology for Water Supply and Sanitation - Low Cost Technology Options for Sanitation, A State of the Art Review and Annotated Bibliography. World Bank, Geneva. (p. 20).
- 2 - Kugler, R. et al. (1998). *Technological Quality Guarantees for H.Q. Compost from Bio-Waste*. As seen in the 1997 Organic Recovery and Biological Treatment Proceedings, Stentiford, E.I. (ed.). International Conference, Harrogate, United Kingdom. 3-5 September, 1997. P. 31. Available from Stuart Brown, National Compost Development Association, PO Box 4, Grassington, North Yorkshire, BD23 5UR UK (stuartbrown@compuserve.com).
- 3 - Vorkamp, Katrin et al. (1998). *Multiresidue Analysis of Pesticides and their Metabolites in Biological Waste*. As seen in the 1997 Organic Recovery and Biological Treatment Proceedings, Stentiford, E.I. (ed.). International Conference, Harrogate, United Kingdom. 3-5 September, 1997. p. 221. Available from Stuart Brown, National Compost Development Association, PO Box 4, Grassington, North Yorkshire, BD23 5UR UK (stuartbrown@compuserve.com).
- 4 - Wheeler, Pat (1998). *Results of the Environment Agency Research Programme into Composting of Green and Household Wastes*. As seen in the 1997 Organic Recovery and Biological Treatment Proceedings, Stentiford, E.I. (ed.). International Conference, Harrogate, United Kingdom. 3-5 September, 1997. p. 77. Available from Stuart Brown, National Compost Development Association, PO Box 4, Grassington, North Yorkshire, BD23 5UR UK (stuartbrown@compuserve.com).
- 5 - Johnson, Julie. (1990). "Waste That No One Wants." *New Scientist*. 9/8/90, Vol. 127, Issue 1733. (p.50).
- 6 - Benedict, Arthur H. et. al. (1988). "Composting Municipal Sludge: A Technology Evaluation." Appendix A. Noyes Data Corporation.

7 - Biocycle, January 1998, p. 71.

8 - Johnson, Julie. (1990). *Waste That No One Wants*. (p. 53) see above.

9 - Simon, Ruth. (1990). *The Whole Earth Compost Pile?* Forbes. 5/28/90, Vol. 145, Issue 11. p. 136.

10 - Gotaas, Harold B., (1956). Composting - Sanitary Disposal and Reclamation of Organic Wastes. p.101. World Health Organization, Monograph Series Number 31. Geneva.

Source: *The Humanure Handbook*. Jenkins Publishing, PO Box 607, Grove City, PA 16127. To order, phone: 1-800-639-4099.

<http://www.jenkinspublishing.com/>

MENU: [HOME](#) » [Reconstruction](#) » [Recovery](#) » [Renewal](#) » [Survival](#) » [Humanure Content](#)

APPENDIX 3

State Regulations (US), Compiled in 1999: Composting Toilets, Graywater Systems, and Constructed Wetlands

[AL](#) | [AK](#) | [AZ](#) | [AR](#) | [CA](#) | [CO](#) | [CT](#) | [DE](#) | [FL](#) | [GA](#) | [HI](#) | [ID](#) | [IL](#) | [IN](#) | [IA](#) | [KS](#) | [KY](#) | [LA](#) | [ME](#) | [MA](#) | [MD](#) | [MI](#) | [MN](#) | [MS](#) | [MO](#) | [MT](#) | [NC](#) | [NE](#) | [NV](#) | [NH](#) | [NJ](#) | [NM](#) | [NY](#) | [ND](#) | [OH](#) | [OK](#) | [OR](#) | [PA](#) | [RI](#) | [SC](#) | [SD](#) | [TN](#) | [TX](#) | [UT](#) | [VT](#) | [VA](#) | [WA](#) | [WV](#) | [WI](#) | [WY](#) | [CANADA](#) | [OTHER INFO](#)

Notes: 1. Although many states do not have formal design standards or regulations concerning composting toilets, graywater systems, and/or constructed wetlands as they pertain to on-site sewage management for residences, many of the rules and regulations do contain a section allowing “experimental” and/or “alternative” systems which may be permitted by individual application to the regulating agency. Individuals interested in these systems should check with their state agency for more information.

2. When the phrase “no existing regulations,” is used it is not meant to imply that those systems may be used without prior approval from the local or state permitting agency. In all cases, check with your local or state permitting agency to see what their permitting requirements are.

Alabama: Alabama Department of Public Health, Division of Community Environmental Protection, RSA Tower, Suite 1250, PO Box 303017, Montgomery, AL 36130-3017; Ph. (334) 206-5373; Contact: John Paul O’Driscoll.

REGULATION(S): Chapter 420-3-1: Onsite Sewage Disposal and Subdivision-Onsite Sewage Systems, Water Supplies and Solid Waste Management (23 December 1998). Composting Toilets: As of December 23, 1998, no regulations exist for composting toilets.

Composting toilets are not expressly forbidden, but the homeowner does have to show adequate sewage disposal for graywater. Alabama is working on a set of new regulations, as the current rules have been overcome by time, and are not adequate for many of the situations that the regulated community faces today. The main shortcoming of the current regulations is that they do not adequately address the large systems and alternative technologies that are present today.¹ In the proposed regulations, composting toilets are discussed in Chapter 420-3-1-.59 under Non-Waterborne Systems: Pit Privies, Portable, Composting, and Incinerating Toilets. A composting toilet is defined as a dry closet which combines toilet and urinal waste with optional food waste in an aerobic vented environment. Decomposition of the waste is accomplished by the dehydration and digestion of organic matter, yielding a composted residue which is removed for sanitary disposal.² Conditions which justify the use of non-waterborne systems include when soil and site conditions are unsuitable for on-site sewage treatment and disposal systems (OSTDS) or when water under pressure is not available. Composting toilets must meet the standards of the National Sanitation Foundation (NSF), Canadian Standards Association (CSA), Underwriter’s Laboratory, or Warnock Hershey. Other requirements call for continuous ventilation of the components for the storage or treatment of materials. Disposal of the compost must be in accordance with the guidance of EPA Part 503. Disposal of any liquids from the system must be to a sanitary sewer or to an approved OSTDS.

GRAYWATER: Ch. 420-3-1-.03. Defined, graywater is that portion of sewage generated by a water-using fixture or appliance, excluding the toilet and possibly the garbage disposal.³ References to graywater can be found under 402-3-1-.27 Effluent from Clothes Washing Machine and Residential Spa. Water from these systems can circumvent a septic tank and go into a separate effluent disposal field (EDF). In the current regulations, in the absence of water under pressure, graywater shall be disposed of by an effluent distribution line of 50 linear feet per dwelling. Graywater is also covered under the proposed draft of Ch. 420-3-1-.59. No new recommendations besides the EDF system are proposed.

CONSTRUCTED WETLANDS: A constructed wetland is defined in the proposed rules as a human-made, engineered, marsh-like area which is designed, constructed, and operated to treat wastewater by attempting to optimize physical, chemical, and biological processes of natural ecosystems.⁴ However, there are no existing regulations.

Alaska: Alaska Department of Environmental Conservation, Domestic Wastewater Program, 410 West Willoughby Avenue, Suite 105, Juneau, AK 99801; Ph. (907) 465-5324; Fax (907) 465-5362; <http://www.state.ak.us/dec>.

REGULATION(S): 18 AAC 72 Wastewater Disposal (1 April 1999).

COMPOSTING TOILETS: No existing regulations.

GRAYWATER: 18 AAC 72.990. Graywater means wastewater a) from a laundry, kitchen, sink, shower, bath, or other domestic sources; and wastewater b) that does not contain excrement, urine, or combined stormwater. No existing regulations.

CONSTRUCTED WETLANDS: No existing regulations.

Arizona: Arizona Department of Environmental Quality, 3033 North Central Avenue, Phoenix, AZ 85012-2809; Toll-free Ph. (800) 234-5677; Ph. (602) 207-4335; Fax (602) 207-4872; Contact: Nabil Anouti at (602) 207-4723;

http://www.sosaz.com/public_services/Title_18/18-09.htm

REGULATION(S): Arizona Department of Environmental Quality (ADEQ) Bulletin No. 12, Minimum Requirements for the Design and Installation of Septic Tank Systems and Alternative On-site Disposal Systems (June 1989); Arizona Administrative Code Title 18, Ch. 9, Article 7: Regulations for the Reuse of Wastewater (30 September 1998); Arizona Guidance Manual for Constructed Wetlands for Water Quality Improvement (August 1996).

COMPOSTING TOILETS: No regulations. Bulletin 12 suggests the use of composting toilets where conditions are such as to make it impossible or impractical to construct either a septic tank disposal or an earth-pit privy.⁵ Provided they can be maintained and operated without endangering the public health or creating a nuisance, composting toilets may be permitted.⁶

GRAYWATER: Defined under R18-9-701. Graywater means wastewater that originates from clothes washers, dishwashers, bathtubs, showers and sinks, except kitchen sinks and toilets. Under R18-9-703, section C6, graywater from single and multi-family residences may be used for surface irrigation. The design and construction of the system must be approved by the Department. Irrigation sites must be designed to contain a 10-year, 24-hour (i.e., maximum possible) rainfall event and the graywater must fall under the allowable limits of less than 25 colony forming units per 100 milliliters (CFU/ml) fecal coliform and less than 2.0 mg/l chlorine for surface irrigation. Under section 7, formation of a wetlands marsh is allowable reuse of reclaimed wastewater.⁷

CONSTRUCTED WETLANDS: Bulletin 12 describes onsite alternatives to septic tank and drainfield disposal systems. The first general requirement of Bulletin No. 12 is that alternative onsite disposal systems are intended and will be approved for individual lots only where conventional septic tank systems are not suitable and cannot be approved.⁸ Use of a septic tank with a minimum of two compartments for preliminary solids removal is necessary prior to a constructed wetland. Constructed subsurface flow wetlands are viewed as a beneficial augmenting step in the septic tank system, providing additional treatment between the septic tank and the soil absorption system.⁹ The bulletin points out several benefits of segregating blackwater and graywater: 1) conservation of water resources; 2) potential of recycling valuable nutrients to the soil; 3) reuse potential of recycled graywater; and 4) prolonged life of the septic tank soil absorption system.¹⁰ However, until further field data becomes available and is evaluated, graywater treatment and disposal systems shall be designed similarly for typical residential wastewater septic tank soil absorption systems. Under this scenario, it may be possible to reduce the septic tank system capacities, sometimes by one-third.¹¹

Arkansas: Arkansas Department of Health, Sanitary Division, State Health Building, 4815 West Markham, Little Rock, AR 72201; Ph. (501) 661-2171.

REGULATION(S): Alternate Systems Manual published by Environmental Program Services, Division of Environmental Health Protection (April 1993). According to the Alternate Systems Manual, the Arkansas Department of Health encourages studies and submission of plans for alternative methods of treating and disposing of wastes generated by individual residences.¹² However, if site and soil conditions indicate that a standard septic tank and soil absorption system is feasible, no alternative or experimental system will be considered.¹³

COMPOSTING TOILETS: are allowed as long as they are NSF approved. In fact, composting toilets are currently being used in state park systems.¹⁴ A composting toilet is defined as a device specifically designed to retain and process body waste, and, in some cases, household garbage, by biological degradation. The process may be thermophilic or mesophilic, depending on the design of the toilet.¹⁵ Some manufacturers claim the stabilized compost is safe and may be used as a soil additive in gardens. The actual health risks associated with this composted material have not been adequately assessed. The stabilized compost from a composting toilet must be buried onsite or deposited in an approved sanitary landfill. All composting devices must be evaluated by an ANSI approved laboratory under NSF Standard 41.¹⁶ Approved composting toilets for the state of Arkansas include Clivus Multrum models 08, 08-0A, 08-A, 202 and 205; and Sun-Mar Biological Composting Toilet and Sun-Mar-XL. Each application requesting approval of a composting toilet must also provide for the disposal of the home's graywater.¹⁷

GRAYWATER: Essentially, graywater is treated the same as blackwater. The preferred method of handling graywater is through a conventional septic tank and absorption field. A 35% reduction in the absorption field size will be granted. Other methods of treating and/or disposing of graywater will be reviewed on a case by case basis.¹⁸

CONSTRUCTED WETLANDS (ROCK PLANT FILTERS): Rock plant filters (RPFs) provide secondary treatment to septic tank effluent. RPFs act as artificial marshes that rely on microorganisms and the roots of aquatic plants to achieve treatment. RPF systems may be considered on sites where low soil permeability prohibits use of a conventional septic system. Discharge from an RPF must be retained on site, which requires a lot size of at least three acres. This requirement may be waived on repairs to existing, failed septic systems. All off-site discharges must be undergo chlorination prior to discharge.¹⁹

California: California Department of Water Resources, Water Conservation Office, 1020 9th Street, Sacramento, CA 95814; Ph. (916) 327-1655; Contact: Ed Craddock. For Composting Toilets and Constructed Wetlands Regulations, Contact: California Department of Health Services, 724 P Street, Room 1350, Sacramento, CA 95814; Ph. (916) 654 0584; Fax (916) 657-2996.

REGULATION(S): Appendix G. Graywater Systems. Uniform Plumbing Code, Title 24, Part 5, California Administrative Code (18

March 1997).

COMPOSTING TOILETS: No existing regulations, check with your local or county agency. **GRAYWATER:** G-1. General. (b) The type of system shall be determined on the basis of location, soil type, and ground water level and shall be designed to accept all graywater connected to the system from the building. The system shall discharge into subsurface irrigation fields and may include surge tanks and appurtenances, as required by the Administrative Authority. (d) No permit for any graywater system shall be issued until a plot plan with appropriate data satisfactory to the Administrative Authority has been submitted and approved. When there is insufficient lot area or inappropriate soil conditions for adequate absorption of the graywater, as determined by the Administrative Authority, no graywater system shall be permitted. G2. Graywater is untreated wastewater which has not come into contact with toilet waste. Graywater includes used water from bathtubs, showers, bathroom wash basins, clothes washing machines and laundry tubs or an equivalent discharge as approved by the Administrative Authority. It does not include wastewater from kitchen sinks, photo lab sinks, dishwashers, or laundry water from soiled diapers. Surfacing of graywater means the ponding, running off, or other release of graywater from the land surface. G13 Health and Safety. (a) Graywater may contain fecal matter as a result of bathing and/or washing of diapers and undergarments. Water containing fecal matter, if swallowed, can cause illness in a susceptible person. (b) Graywater shall not include laundry water from soiled diapers. (c) Graywater shall not be applied above the land surface or allowed to surface and shall not be discharged directly into or reach any storm sewer system or any water of the United States. (d) Graywater shall not be contacted by humans, except as required to maintain the graywater treatment and distribution system. (e) Graywater shall not be used for vegetable gardens.²⁰

CONSTRUCTED WETLANDS: No existing regulations.

Colorado: Colorado Department of Public Health and Environment, Water Quality Control Division, 4300 Cherry Creek Drive South, Denver, CO 80246-1530; Ph. (303) 692-3500.

REGULATION(S): Guidelines on Individual Sewage Disposal Systems, Chapter 25, Article 10 (1994).

COMPOSTING TOILETS: Composting toilets, according to the Colorado Department of Health, are defined as unit(s) which consist of a toilet seat and cover over a riser which connects to a compartment or a vault that contains or will receive composting materials sufficient to reduce waste by aerobic decomposition.²¹ Composting toilets receive deposits of feces, urine, and readily decomposable household garbage that are not diluted with water or other fluids.²² These deposits are retained in a compartment in which aerobic composting will occur. The compartment may be located within a dwelling or building, provided that the unit complies with the applicable requirements of these guidelines and provided the installation will not result in conditions considered to be a health hazard as determined by the local health department. The effective volume of the receptacle must be sufficient to accommodate the number of persons served. When the receptacle is filled to 75% capacity, residue from the unit shall be disposed of by acceptable solid waste practices. Composting toilets must be NSF approved.²³

GRAYWATER: Graywater systems collect, treat, and dispose of liquid wastes from sinks, lavatories, tubs, showers, and laundry or other approved plumbing fixtures, excluding toilet fixtures.²⁴ Graywater systems shall meet at least all minimum design and construction standards for septic tank systems based on the amount and character of wastes for the fixtures and the number of persons served.²⁵

CONSTRUCTED WETLANDS: are systems which utilize various wetland plants to provide secondary treatment of wastewater through biological, physical, and chemical processes.²⁶ Constructed wetland systems must be designed by a registered professional engineer. Designs have to be site-specific and must include estimates of effluent quality at the inlet and outlet. Periodic sampling is required at the owner's expense.²⁷

Connecticut: Connecticut Department of Public Health, 410 Capitol Avenue, MS #51 SEW, PO Box 340308, Hartford, CT 06134-0308; Ph. (860) 509-7296; <http://www.dep.state.ct.us/dph>.

REGULATION(S): Connecticut Public Health Code: Regulations and Technical Standards for Subsurface Sewage Disposal Systems, Section 19-13-B100 (Conversions, Changes in Use, Additions) (25 October 1976); Section 19-13-B103 (Discharges 5,000 Gallons Per Day or Less) (16 August 1982); and Technical Standards (Pursuant to Section 19-13-B103) (1 January 1997).

COMPOSTING TOILETS: (b)(1) The local director of health may approve the use of a large capacity composting toilet or a heat-assisted composting toilet for replacing an existing privy or a failing subsurface sewage disposal system, or for any single-family residential building where application is made by the owner and occupant, and the lot on which the building will be located is tested by the local director of health and found suitable for a subsurface sewage disposal system meeting all the requirements of Section 19-13-B103d of these regulations. (2) All wastes removed from composting toilets shall be disposed of by burial or other methods approved by the local director of health.²⁸ 19-13-B103f XI. Non-Discharging Sewage Disposal Systems A. Large capacity composting toilets shall have separate receiving, composting, and storage compartments, arranged so that the contents are moved from one compartment to another without spillage or escape of odors within the dwelling. No large capacity composting toilets shall have an interior volume of less than 64 cubic feet. All toilet waste shall be deposited in the receiving chamber, which shall be furnished with a tight self-closing toilet lid. Food waste or other materials necessary to the composting action shall be deposited in the composting compartment through a separate opening with a tight fitting lid. The final composting material shall be removed from the storage compartment through a cleanout opening fitted with a tight door or lid. The cleanout shall not be located in a food storage or preparation area. The receiving and composting compartments shall be connected to the outside atmosphere by a screened vent. The vent shall be a minimum of six inches in diameter and shall extend at least

20 feet above the openings in the receiving and composting compartments, unless mechanical ventilation is provided. Air inlets shall be connected to the storage compartment only, and shall be screened. B. Heat assigned composting toilets shall have a single compartment furnished with a tight, self-closing toilet lid. The compartment shall be connected to the outside atmosphere by a screened vent. There shall be a mechanical ventilation fan arranged to control the humidity in the compartment and provide positive venting of odors to the outside atmosphere at all times. A heating unit shall be provided to maintain temperature in the optimum range for composting.²⁹

GRAYWATER: (n) Graywater means domestic sewage containing no fecal material or toilet wastes. Sec. 19-13-B103d. Minimum Requirements. (f) Gray Water Systems. Disposal systems for sinks, tubs, showers, laundries, and other graywater from residential buildings, where no water flush toilet fixtures are connected, shall be constructed with a septic tank and leaching system at least one-half the capacity specified for the required residential sewage disposal system.³⁰ Sec. 19-13-B103f. Non-discharging Sewage Disposal Systems (a) All non-discharging sewage disposal systems shall be designed, installed, and operated in accordance with the Technical Standards and the requirements of this section, unless an exception is granted by the Commissioner upon a determination that system shall provide for the proper and complete disposal and treatment of toilet wastes or graywater.³¹

CONSTRUCTED WETLANDS: No existing regulations.

Delaware: Department of Natural Resources and Environmental Control, Division of Water Resources, 89 Kings Highway, Dover, DE 19901; Ph. (302) 739-4761.

REGULATION(S): Regulations Governing the Design, Installation and Operation of On-Site Wastewater Treatment and Disposal Systems (4 January 1984).

COMPOSTING TOILETS, GRAYWATER, CONSTRUCTED WETLANDS: No existing regulations. However, a substantial portion of Delaware's population lives where centralized water supply or wastewater treatment services are limited. The Department's mission is to aid and assist the public in the installation of on-site sewage disposal systems, where possible, by utilizing the best information, techniques, and soil evaluations for the most suitable system that site and soil conditions permit. In the past, inadequately renovated wastewater has contaminated Delaware's groundwater and presented a threat to the public health, safety, and welfare. Corrective measures required the replacement of water supply and wastewater systems at a very high cost which was sometimes borne by the general public. In developing these Regulations, the Department operated under the philosophy that where soil and site conditions permit, the least complex, easy to maintain, and most economical system should be used. The Department's policy is to encourage development of systems, processes, and techniques which may benefit significant numbers of people in Delaware.³²

Florida: Florida Department of Health, Bureau of Water and On-Site Sewage Programs, 2020 Capital Circle SE, BIN #A08, Tallahassee, FL 32399-1713; Ph. (850) 488-4070; FAX (850) 922-6969; <http://www.doh.state.fl.us/>;

<http://www.dep.state.fl.us/ogc/documents/rules/rulelistpa.htm#wastewater>; Contact: David Hammonds; Email:

David_Hammonds@doh.state.fl.us

REGULATION(S): 381.0065 Florida Statutes Regulations: Chapter 64E-6, Florida Administrative Code, Standards for Onsite Sewage Treatment and Disposal Systems (3 March 1998).

COMPOSTING TOILETS: Although they are not widely used, they are allowed, especially in floodprone areas. Florida encourages the use of composting toilets.³³ 64E-6.009 Alternative Systems. Upon approval by the DOH county health department, alternative systems may, at the applicant's discretion, be used in circumstances where standard subsurface systems are not suitable or where alternative systems are more feasible. Under this section, composting toilets may be approved for use if found in compliance with NSF Standard 41. Graywater and any other liquid and solid waste must be properly collected and disposed of in accordance with Chapter 64E.³⁴ 64E-6.010 Disposal of Sewage. No receptacle associated with an onsite sewage treatment and disposal system shall be cleaned or have its contents removed until the service person has obtained an annual written permit (form DH4013) from the DOH county health department in the county in which the service company is located.³⁵

GRAYWATER: as defined under Title XXIX, Public Health Chapter 381.0065 Onsite Sewage treatment and disposal systems, means that part of domestic sewage that is not blackwater, including the waste from the bath, lavatory, laundry, and sink, except kitchen sink waste.³⁶ Graywater systems are described in Rule 64E-6.013(4).³⁷ When a separate system is installed to dispose of graywater, the retention tank for such systems shall meet certain design standards as specified in Rule 64E-6.008(3): The minimum effective capacity of the graywater retention tank shall be 250 gallons, with such system receiving not more than 75 gallons of flow per day. Where separate graywater and blackwater systems are used, the size of the blackwater system can be reduced by not more than 25%. 10D-6.046 Location and Installation. (7) Onsite graywater tank and drainfield systems may, at the homeowner's discretion, be utilized in conjunction with an onsite blackwater system where a sewerage system is not available for blackwater disposal.³⁸ 10D-6.048 System Size Determination (4) A separate laundry waste tank and drainfield system may be utilized for residences and may be required by the county public health unit where building codes allow for separation of discharge pipes of the residence to separate stubouts and where lot sizes and setback allow system construction. (a) The minimum laundry waste trench drainfield absorption area for slightly limited soil shall be 75 square feet for a one or two bedroom residence with an additional 25 square feet for each additional bedroom. 10D-6.055 (k) All graywater tanks distributed by the state shall be approved for use by the department prior to being installed. Such approval shall be obtained only after the manufacturer of a specific model has submitted engineering designs of the tank. (4) Graywater retention tanks - when a separate system is

installed to dispose of graywater, the retention tank for such system shall meet the following minimum design standards: a) the minimum effective capacity shall be as specified in Rule 10D-6.048(3). Liquid depth shall be at least 30 inches; and b) retention tanks shall be baffled and vented as specified in the septic tank construction standards found elsewhere in the section provided that an inlet tee, ell, or baffle shall be provided for graywater tanks.³⁹

CONSTRUCTED WETLANDS: No existing regulations.⁴⁰

Georgia: Department of Human Resources, Division of Public Health, Environmental Health Section, 5th Floor-Annex, 2 Peachtree Street NW, Atlanta, GA 30303-3186; Ph. (404) 657-2700 or 6538; FAX (404) 657-6533; <http://www.ganet.org/dnr/environ/rules>;

Contact: Warren Abrahams, Program Consultant.

REGULATION(S): Rules of Department of Human Resources, Public Health, Chapter 290-5-26: Onsite Sewage Disposal Management Systems (20 February 1998).

COMPOSTING TOILETS: Where the availability of land for installation of conventional septic tank systems is limited so as to allow for only a septic tank and a reduced size absorption system, composting toilets may be considered. Laundry, bath, and kitchen wastes must be disposed of in a conventional septic tank system, although the size of the absorption field may be reduced by 35% from that of a conventional system, provided water conservation devices are utilized. Composted wastes from the treatment unit shall be removed as per the manufacturer's recommendations and the residue shall be buried by covering with at least six inches of soil. Wastes should not be used as fertilizer for root or leaf crops which may be eaten raw. Composting toilets must be certified by the NSF as meeting the current standard or certified by the manufacturer as meeting a nationally recognized standard for such purpose.⁴¹

GRAYWATER: Graywater means wastewater generated by water-using fixtures and appliances, excluding water closets, urinals, bidets, kitchen sinks, and garbage disposals. Chapter 290-5-59, Special Onsite Sewage Management Systems, defines sewage as human excreta, all water-carried wastes, and/or liquid household waste including graywater from residences or similar wastes or by-products from commercial and industrial establishments.⁴² Where a separate graywater system is to be used, the minimum effective capacity of the graywater retention tank shall be 500 gallons. The minimum absorption area for graywater or blackwater absorption systems serving residential properties shall be based on the number of bedrooms and the percolation rate. The blackwater portion of the total daily sewage flow shall be 35%; the graywater portion shall be 65%.⁴³

CONSTRUCTED WETLANDS: No existing regulations. Although no regulations are formally in place, an article in the Georgia Environmentalist gives design information and recommendations for both free water surface (FWS) and subsurface flow (SSF) constructed wetlands.⁴⁴

Hawaii: Department Of Health, Wastewater Branch, Environmental Management Division, 919 Ala Moana Boulevard, Suite 309, Honolulu, HI 96814; Ph. (808) 586-4294.

REGULATION(S): Hawaii Administrative Rules, Chapter 11-62 (30 August 1991).

COMPOSTING TOILETS: 11-62-03 Definitions. "Compost toilet" means a non-flush, waterless toilet that employs an aerobic composting process to treat toilet wastes.⁴⁵ Ch. 11-62-35 states that specific design requirements for composting (and other) toilets shall be reviewed and approved by the director on a case-by-case basis.⁴⁶ Products, if sold in Hawaii, are to be approved by the director, based on appropriate testing procedures and standards as set forth by the National Sanitation Foundation (NSF) Testing Laboratory.⁴⁷ The following toilets are approved the NSF Standard 041: Biolet XL; Clivus Multrum Model M-1, M-2, M-12, M-15, M-18, M-22, M-25, M-28, M-32, M-35, M54ADA; Ecotech Carousel; and Sun Mar Excel.

GRAYWATER: means liquid waste from a dwelling or other establishment produced by bathing, washdown, minor laundry, and minor culinary operations, and specifically excluding toilet waste.⁴⁸ Chapter 11-62-31.1 states that individual wastewater systems may be used as a temporary on-site means of wastewater disposal in lieu of wastewater treatment works in residential developments when there is 10,000 square feet or more of land area for each individual wastewater system.⁴⁹ Section G covers graywater systems and their respective design characteristics.⁵⁰ Graywater conveyance systems include: sand filters, absorption trenches and beds, mounds or seepage pits, or when disinfected in accordance with 11-62-26(b) (which governs total coliform levels), used for irrigation.⁵¹ 11-62-31.1 gives the general requirements for proposed individual wastewater systems. (g) A graywater system shall be designed in accordance with the following criteria: (1) design of graywater systems for dwelling units shall be based on a minimum graywater flow of 150 gallons per day per bedroom; and (2) graywater tanks, when required, shall be sized with no less than a 600 gallon capacity and shall conform to the requirements of section 11-62-33-1(a).⁵²

CONSTRUCTED WETLANDS: No existing regulations.

Idaho: Division of Environmental Quality, 1410 North Hilton, Boise, ID 83706-1255; Ph. (208) 373-0502. Contact: Barry Burnell, Watershed Protection Supervisor.

REGULATION(S): IDAPA 16, Title 01, Chapter 03, Rules for Individual/Subsurface Sewage Disposal Systems (7 May 1993) and the Technical Guidance Manual (TGM) for Individual Subsurface Sewage Disposal Systems. The TGM can be viewed at http://www.state.id.us/phd1/tgm/tgm_toc.htm Section 10 of the Idaho code covers Alternative Systems. If a standard system as described in the rules cannot be installed on a parcel of land, an alternative system may be permitted if that system is in accordance with the

recommendations of the Technical Guidance Committee and is approved by the Director.⁵³

COMPOSTING TOILETS: are defined as toilets within the dwelling that store and treat non-water carried human urine and feces and small amounts of household garbage by bacterial decomposition. The resultant product is compost.⁵⁴ Composting toilets are allowed in residences that also have water under pressure, with the understanding that a public sewer or another acceptable method of on-site disposal is available. Permission must be obtained from the Idaho Health Department, as current plumbing code prohibits the use of composting toilets without their permission.⁵⁵

GRAYWATER: The Technical Guidance Manual contains a draft for graywater system guidelines and design requirements, but current Idaho rules permit graywater systems only as experimental systems.⁵⁶ The draft proposal describes graywater as untreated household wastewater that has not come into contact with toilet waste. Graywater includes used water from bathtubs, showers, bathroom wash basins, and water from clothes washing machines and laundry tubs. It shall not include wastewater from kitchen sinks, dishwashers, or laundry water from soiled diapers. A graywater system consists of a separate plumbing system from the blackwater and kitchen plumbing, a surge tank to temporarily hold large drain flows, a filter to remove particles that could clog the irrigation system, a pump to move the graywater from the surge tank to the irrigation field, and an irrigation system to distribute the graywater. Graywater may not be used to irrigate vegetable gardens. Graywater systems may only be permitted for individual dwellings. The capacity of the septic tank and size of the blackwater drainfield and replacement area shall not be reduced by the existence or proposed installation of a graywater system servicing the dwelling. Graywater shall not be applied on the land surface or be allowed to reach the land surface.⁵⁷

CONSTRUCTED WETLANDS: Constructed wetlands are only permitted under experimental systems. All experimental systems require a variance. Experimental systems also are required to be designed by a Idaho licensed professional engineer.⁵⁸

Illinois: Illinois Department of Public Health, Division of Environmental Health, 525-535 West Jefferson Street, Springfield, IL 62761-0001; Ph. (217) 782-5830; Contact: Elaine Beard or Doug Ebelherr.

REGULATION(S): Title 77: Public Health, Chapter I: Department of Public Health, Subchapter r: Water and Sewage, Part 905: Private Sewage Disposal Code, Section 905.30, Approved Private Sewage Disposal Systems (15 March 1996).

COMPOSTING TOILETS: are approved for private sewage disposal of human wastes.⁵⁹ Compost toilets shall be designed in accordance with the manufacturer's recommendation to serve the anticipated number of persons. The owner of a compost toilet shall maintain the toilet and dispose of the contents in accordance with Section 905.170, which lists several methods of disposal: 1) discharge to a municipal sanitary sewer system; 2) discharge to sludge lagoons or sludge drying beds; 3) discharge to an incinerator device; or 4) discharge to a sanitary landfill.⁶⁰ Compost toilets shall comply with the requirement of the NSF Standard 41 and shall bear the NSF Seal.⁶¹

GRAYWATER, CONSTRUCTED WETLANDS: No existing regulations (governed under experimental systems).

Indiana: Indiana Department of Environmental Management, 100 North Senate Avenue, PO Box 6015, Indianapolis, IN 46206-6015; Ph. (317) 233-7179 or (317) 233-7188; Contact: Alan Dunn or Tim Decker; Email: adunn@ISDH.state.in.us.

REGULATION(S): Regulations, if they existed, would most likely be found under 401 Indiana Administrative Code 6-8.1.

COMPOSTING TOILETS, GRAYWATER: No existing regulations.

CONSTRUCTED WETLANDS: Constructed wetlands are approved only for experimental use in residential situations. Indiana outlines some basic design criteria for subsurface constructed wetlands, as follows: 1) The wetland is usually designed for five to seven days retention time; 2) Each wetland has one cell for residential projects, with each cell having a length to width ratio of no greater than 2:1; 3) The depth of gravel in the wetland is no greater than 24 inches; 4) There are three different gravel sizes in the wetland. The inlet and outlet ends of the wetland have coarse gravel in the range of 1 1/2 to 3 inches in size. The area between the ends has gravel in the range of 1/2 to 1 inch in size. The surface layer of gravel over the entire wetland is usually six inches in depth with a range of 3/8 to 1/2 inch size (pea gravel). All gravels are screened and washed to remove fines; 5) The water level in the wetland is set at a depth of two to three inches below the surface of the gravel by the outlet adjustable sump pipe. The outlet sump pipe is orificed with a 1 1/2 inch hole to regulate the flow from the wetland after a six inch rainfall event to spread the rainfall accumulation over a 24-hour period; 6) The wetlands are lined with at least a 20 mil liner for residential projects; 7) The wetland is tested for leaks over a 24-hour period with at least six inch depth of water above the inlet and outlet distribution and collection pipe; 8) The inlet distribution and outlet collection pipes for each cell of the wetland are placed at the bottom of the wetland gravel; 9) Some commonly used wetland plants are cattails (*Typha* sp.) and bulrushes (*Scirpus* sp.) along with other appropriate species. The shallower rooted plants are located near the inlet because of the higher influent temperatures and high nutrient levels, with deeper rooted plants located toward the end of the wetland; and 10) There is required monitoring at the inlet and outlet ends of the wetland for three to five years. Absorption field criteria: 1) Selection and sizing of the absorption field is always based upon the peak daily wastewater load and the on-site soil survey report that is done by an ARCPAC certified soil scientist, in the area of the absorption field; 2) There is an allowable reduction in the size of the absorption field associated with a subsurface constructed wetland based on the soil loading rate. For soil loading rates equal to or greater than 0.5 gallons per day (GPD) per square foot, but less than or equal to 1.2 GPD per square foot, the allowable reduction in field size is 50%. For soil loading rates of less than 0.5 GPD per square foot but greater than or equal to 0.25 GPD per square foot, the allowable reduction in the field is 33%; 3) There must be a 50 to 100% set aside area for the proposed absorption field associated with the subsurface constructed wetland because this combination is still considered experimental when there is an allowable absorption field size reduction; and 4) The septic

tanks are sized for either a 36 or 48 hour detention time.⁶²

Iowa: Iowa Department of Natural Resources, Wallace State Office Building, 502 East 9th Street, Des Moines, IA 50319-0034; Ph. (515) 281-7814; Contact: Brent Parker.

REGULATION(S): Chapter 69: On-Site Wastewater Treatment and Disposal Systems 567-69.11(455B).

COMPOSTING TOILETS, GRAYWATER: No existing regulations. Constructed wetlands: are governed under 69.1(2). "On-site wastewater treatment and disposal system" means all equipment and devices necessary for proper conduction, collection, storage, treatment, and disposal of wastewater from four or fewer dwelling units or other facilities serving the equivalent of 15 persons (1,500 gpd) or less. This includes domestic waste, whether residential or nonresidential, but does not include industrial waste of any flow rate. Included within the scope of this definition are building sewers, septic tanks, subsurface absorption systems, mound systems, sand filters, constructed wetlands and individual mechanical/aerobic wastewater treatment systems. 567---69.11(455B) Constructed wetlands. 69.11(1) Constructed wetlands shall only be used where soil percolation rates at the site exceed 120 minutes per inch. Because of the higher maintenance requirements of constructed wetland systems, preference should be given to sand filters, where conditions allow. b). The effluent from a constructed wetland shall receive additional treatment through the use of intermittent sand filters of a magnitude of half that prescribed in rule 69.9(455B). c) Effluent sampling of constructed wetlands shall be performed twice a year or as directed by the administrative authority. Tests shall be run on all parameters as required in 69.9(1). d). Specifications given in these rules for constructed wetlands are minimal and may not be sufficient for all applications. Technical specifications are changing with experience and research. Other design information beyond the scope of these rules may be necessary to properly design a constructed wetland system. 69.11(2) a). The wetland shall be of a subsurface flow construction with a rock depth of 18 inches and a liquid depth of 12 inches. b). Substrate shall be washed river gravel with a diameter of 3/4 inch to 2½ inches. If crushed quarried stone is used, it must meet the criteria listed in 69.6(4)"a." c). Detention time shall be a minimum of seven days. (1) This may be accomplished with trenches 16 to 18 inches deep (12 inches of liquid), three feet wide with 100 feet of length per bedroom. This may also be done with beds 16 to 18 inches deep, with at least 300 square feet of surface area per bedroom. The bottom of each trench or bed must be level within ±½ inch. (2) Multiple trenches or beds in series should be used. Beds or trenches in series may be stepped down in elevation to fit a hillside application. If the system is on one elevation, it should still be divided into units by earthen berms at about 50 and 75% of the total length. (3) Each subunit shall be connected to the next with an overflow pipe (rigid sewer pipe) that maintains the water level in the first section. Protection from freezing may be necessary. d). Wetlands shall be lined with a synthetic PVC or PE plastic liner 20 to 30 mils thick. e). Effluent shall enter the wetland by a four inch pipe sealed into the liner. With beds, a header pipe shall be installed along the inlet side to distribute the waste. f). Wetland system sites shall be bermed to prevent surface water from entering the trenches or beds. 69.11(3) Vegetation shall be established on the wetlands at time of construction. Twelve inches of rock is placed in each unit, the plants are set, then the final four to six inches of rock is placed. b). Only indigenous plant species shall be used, preferably collected within a 100-mile radius of the site. Multiple species in each system are recommended. Preferred species include, but are not limited to: (1) *Typha latifolia* - Common cattail; (2) *Typha angustifolia* - Narrow leaf cattail; (3) *Scirpus* spp. - Bullrush; (4) *Phragmites communis* - Reed. Transplantation is the recommended method of vegetation establishment. For transplanting, the propagule should be transplanted, at a minimum, on a two-foot grid. The transplants should be fertilized, preferably with a controlled release fertilizer such as Osmocote 18-5-11 for fall and winter planting, 18-6-12 for spring planting, and 19-6-12 for summer planting. Trenches or beds should be filled with fresh water immediately. d). In the late fall, the vegetation shall be mown and the detritus left on the wetland surface as a temperature mulch. In the early spring, the mulch shall be removed and disposed of to allow for adequate bed aeration.⁶³

Kansas: Department of Health and Environment, Bureau of Water, Nonpoint Source Section, Forbes Field, Building 283, Topeka, KS 66620; Ph. (785) 296-4195 or 1683.

REGULATION(S): No existing regulations. If regulations existed, they should fall under the Kansas Administrative Regulations (KAR) Chapter 25, Article 5, Sewage and Excreta Disposal.

COMPOSTING TOILETS, GRAYWATER, CONSTRUCTED WETLANDS: No existing regulations. Bulletin 4-2, Minimum Standards for Design and Construction of Onsite Wastewater Systems (March 1997) mentions alternative systems when conventional absorption fields or ponds are not suitable.⁶⁴ K.A.R. 28-5-9 gives authority to county health departments, in counties that have local codes, to grant variances for alternative onsite wastewater treatment and disposal systems. The variance request is filed with the county administrative agency.⁶⁵

Kentucky: Department for Public Health, Division of Public Health Protection and Safety, Environmental Management Branch, Community Environment Section, 275 East Main Street, Frankfort, KY 40621; Ph. (502) 564-4856; FAX (502) 564-6533; Contact: Craig Sheehan, R.S., Health Inspection Program Evaluator; Email: Craig.sheehan@mail.state.ky.us REGULATION(S): 902 Kentucky Administrative Regulations 10:085 Kentucky Onsite Sewage Disposal Systems (September 1989).

COMPOSTING TOILETS: are mentioned under 1b, 8. System Sizing Standards. When approved permanent non-water carriage water closet type devices (composting toilets, incinerator toilets, oil carriage toilets, etc.) are installed exclusively in any residence and no other blackwater type wastes are created, the daily design flow unit for that specific residence may be reduced.⁶⁶

GRAYWATER: in Section 2(13) means wastewater generated by water-using fixtures and appliances, excluding the toilet and the garbage disposal.⁶⁷ Graywater standards are mentioned under 13a-c, 8. When improved performance (of a septic system) may be attained by separating laundry graywater waste flows from other residential waste flow for new system installations, or as repair for existing systems, such separation shall be accomplished in the following manner: a) Graywater sewer for the washing machine shall be separated from the main house sewer; b) laundry graywater shall discharge into a lateral bed or trench(es) of a minimum of 100 square feet of bottom surface soil absorption area for a two bedroom residence and an additional 50 square feet for each additional bedroom; c) new system installations where laundry wasteflow separation exists are permitted a 15% reduction in the primary system lateral field requirements shall be allowed only for sites with soils in Soil Groups I-III. On sites with soils in Soil Group IV, such separation may be required, but no system size reduction will be granted.⁶⁸

CONSTRUCTED WETLANDS: or plant-rock filters generally consist of a primary treatment unit, usually a septic tank with two compartments or special filters, with a lined rock bed or cell containing approximately 12 inches of rock and a small overflow lateral field. Aquatic plants are planted in the rock media and treat the effluent to a very high degree. Any excess effluent is disposed of in the lateral field. Wetlands are sized based on 1.3 cubic feet of gravel area for each one gallon of total daily waste flow. A typical size for a three bedroom home would be 468 square feet of interior area. Various length to width ratios are acceptable with generally a relatively narrow width to longer length preferable. The system functions primarily by wastewater entering the treatment unit where some treatment occurs. The partially treated wastewater then enters the lined wetlands cell through solid piping where it is distributed across the cell. The plants within the system act to introduce oxygen into the wastewater through their roots. As the wastewater becomes oxygenated, beneficial microorganisms and fungi can thrive, where they in turn digest organic matter. In addition, fairly large amounts of water may be lost through evapotranspiration. Advantages of installing a constructed wetlands system are that they: 1) are space conservative (approximately 1/3 of conventional rock lateral); 2) can be placed on irregular or segmented lots; and 3) may be placed in areas with shallow water tables, high bedrock or restrictive horizons. Disadvantages include that constructed wetlands systems: 1) require a higher level of maintenance than other conventional systems; 2) may be more costly to install; and 3) have an unknown life span.⁶⁹

Louisiana: Department of Health and Hospitals, Office of Public Health, Sanitation Services, 106 Canal Blvd., Thibodaux, LA 70301; Ph. (504) 449 5007; Contact: Teda Boudreaux.

COMPOSTING TOILETS, GRAYWATER SYSTEMS, CONSTRUCTED WETLANDS: No existing regulations.⁷⁰

Maine: Department of Human Services, Bureau of Health, Division of Health Engineering, Wastewater and Plumbing Control Program, State House Station 10, Augusta, ME 04333-0010; Ph. (207) 287-5689.

REGULATION(S): Maine Subsurface Waste Water Disposal Rules 144A CMR 241(20 January 1998).

COMPOSTING TOILETS: are regulated in Ch. 15, Section 1504.0. A composting toilet is designed to receive, store, and compost human wastes. Stabilized (that is, composted) wastes shall be removed for disposal when the toilet's capacity is reached. The minimum interior volume of a composting toilet shall be large enough to allow complete stabilization of all wastes when the toilet is used continuously at its proposed usage level. Toilet wastes shall be deposited into a receiving area with a self-closing, tightly fitting lid. There shall be a separate access, with a tightly fitting lid, through which food wastes, or other materials needed for the composting process, are routed to the composting compartment. Composted material shall be removed from the storage area through a cleanout opening fitted with a tight door or lid. Non cleanout may be located in a food storage or preparation area. Any liquid overflow shall be discharged to a primitive or conventional disposal field. The contents of an alternative toilet shall be removed and disposed of in a legal and sanitary manner whenever they reach recommended capacity of the alternative toilet.⁷¹

GRAYWATER: 1509.0 Separated Laundry Disposal Systems. The plumbing inspector may approve a separate laundry system for single-family dwelling units. A separated laundry field requires an application for subsurface waste water disposal system completed by a licensed site evaluator and a permit to install the system. Only waste water from a washing machine may be discharged to the separate laundry disposal field designed for that purpose. Separate laundry disposal fields may be designed and used for hot tubs or backwash water. A separated laundry disposal field does not require a septic tank.⁷²

CONSTRUCTED WETLANDS: No existing regulations.

Maryland: Maryland Department of the Environment, Water Management Administration, 2500 Broening Highway, Baltimore, MD 21224; Ph. (410) 631-3778.

REGULATION(S): Regulations may be discussed under Chapter 9, Subtitle 14A. Waterless Toilets (1993).

COMPOSTING TOILETS: Waterless toilets are covered in Chapter 9, Subtitle 14A-01. Waterless Toilets The Maryland Department of the Environment does not prohibit the use of any NSF approved composting toilet for use anywhere in the State. The Department's current regulation is to allow a 36% design flow reduction for residences when utilizing an NSF approved composting/waterless toilet.⁷³

GRAYWATER: Innovative graywater designs are currently allowed on a case-by-case basis under the Innovative and Alternative Program.⁷⁴

CONSTRUCTED WETLANDS: No existing regulations.

Massachusetts: Department of Environmental Protection, Division of Water Pollution Control, One Winter Street, 8th Floor, Boston, MA 02108; Ph. (617) 292-5500; <http://www.magnet.state.ma.us/dep/brp/wwm/wwwhome.htm>; Contact: Doug Roth; Email:

douglas.roth@state.ma.us For graywater, contact: Ruth Alfasso, graywater piloting coordinator; Email: Ruth.Alfasso@state.ma.us

REGULATION(S): 310 CMR 15.000, Title 5: Innovative and Alternative Subsurface Sewage Disposal Technologies Approved for Use in Massachusetts (4 March 1998).

COMPOSTING TOILETS: are certified for general use for new construction and for remedial use. Specific regulations concerning composting toilets follow: 1) compost temperature must be maintained above 131 degrees F (55 degrees C); 2) moisture must be maintained between 40-60% for best results; and 3) the system must be designed to store compostable and composted solids for at least two years, either inside the composting chamber or in a separate compost container. Compost must be disposed by one of two methods: 1) by on-site burial, covered with a minimum of six inches of clean compacted earth; or 2) by a licensed septage hauler. If any liquid by-product exists, it should be discharged through a graywater system that includes a septic tank and leaching system or removed by licensed septic hauler.⁷⁵

GRAYWATER: If the facility generates graywater (i.e., wastewater from sinks, showers, washing machines, etc.) a disposal system is still needed for the graywater. Title 5 has different requirements for remedial use and for new construction. Remedial use is for facilities which have a design flow of less than 10,000 gallons per day, are served by an existing system, and where there is no proposed increase in the design flow. An existing cesspool may be used as a leaching pit, provided that the cesspool is pumped and cleaned and is not located in groundwater, and meets the design criteria of 310 CMR 15.253 with respect to effective depth, separation between units, and inspection access. The cesspool may be replaced by a precast concrete leaching pit meeting those requirements, and the effluent loading requirements of Title 5. A septic tank should also be installed. Pertaining to graywater, a filter system specifically approved by the Department can be used instead of a septic tank.⁷⁶ Non-traditional graywater systems, such as those which use constructed wetlands or evapotranspiration beds, are approved on a piloting, site-specific basis.⁷⁷

CONSTRUCTED WETLANDS: No existing regulations, approved on a piloting basis only.⁷⁸

Michigan: Department of Environmental Quality, Environmental Health Section, Drinking Water and Radiological Protection Division, PO Box 30630, Lansing, MI 48909-8130; Toll-free Ph. (800) 662-9278; Ph. (517) 335-8284.

REGULATION(S): Michigan has one of the oldest existing guidelines for composting toilets and graywater systems. However, as there is no statewide sanitary code, the 46 local health departments define the criteria for onsite sewage disposal and "each county runs its own show."⁷⁹ The Michigan Department of Health publishes Guidelines for Acceptable Innovative or Alternative Waste Treatment Systems and Acceptable Alternative Graywater Systems under authority of Act 421, P.A. 1981 (1986). Under Act 421, an owner of a structure using an acceptable an innovative or alternative waste treatment system (heretofore referred to as "alternative systems") in combination with an acceptable alternative graywater system (heretofore referred to as "graywater systems") shall not be required to connect to an available public sanitary sewer system.⁸⁰ Alternative system means a decentralized or individual waste system which has been approved for use by a local health department and which is properly operated and maintained so as to not cause a health hazard or nuisance. An acceptable alternative system may include, but is not limited to, an organic waste treatment system or composting toilet which operates on the principle of decomposition of heterogenous organic materials by aerobic and facultative anaerobic organisms and utilizes an effectively aerobic composting process which produces a stabilized humus. Alternative systems do not include septic tank-drainfield systems or any other systems which are determined by the department to pose a similar threat to the public health, safety and welfare, and the quality of surface and subsurface waters of this state.⁸¹ A person may install and use in a structure an alternative system or an alternative system in combination with a graywater system. The installation and use of an alternative system or an alternative system in combination with a graywater system in a structure shall be subject to regulations by the local health department in accordance with the ordinances and regulations of the local units of government in which the structure lies. A local health department may inspect each alternative system within its jurisdiction at least once each year to determine if it being properly operated and maintained. 1) A local health department may charge the owner of an alternative system a reasonable fee for such an inspection and for the plan review and installation inspection. 2) The department shall maintain a record of approved alternative systems and their maintenance and adoption. The department, after consultation with the state plumbing board, shall adopt guidelines to assist local health departments in determining what are graywater systems and what are alternative systems. The department shall advise local health departments regarding the appropriate installation and use of alternative systems and alternative systems in combination with graywater systems. 3) A person who installs and uses an alternative system or an alternative system in combination with a graywater system shall not be exempt from any special assessments levied by a local unit of government for the purpose of financing the construction of an available public sanitary sewer system. 4) An owner of a structure using an alternative in combination with a graywater system shall not be required to connect to an available public sanitary sewer system.⁸²

GRAYWATER: system means a system for the treatment and disposal of wastewater which does not receive human body wastes or industrial waste which has been approved for use by a local health department and which is properly operated and maintained so as not to cause a health hazard or nuisance.⁸³ Structures which utilize alternative systems and graywater systems which are self-contained systems that do not have an on-site discharge should not be required to connect to an available public sanitary sewer system.⁸⁴ Alternative systems must meet the requirements of Sections 5 (6) and 21 of the Michigan Construction Code, act 230, Public Acts of 1972 as amended.

Structures using alternative systems must also meet the requirements of the Michigan Plumbing Code.⁸⁵ Alternative systems and graywater systems should be tested by the National Sanitation Foundation (NSF) under Standard 41 testing protocol or by an equivalent independent testing agency and procedure. Lacking this testing procedure, the local health department should require performance data prior to approval. When requested, the Michigan Department of Public Health will assist local health departments in evaluating performance data from the NSF and other sources. Each local health department should require appropriate methods for disposal of stored liquid or solid end products from alternative systems.⁸⁶ To the extent that funds are available, the department will provide training and technical field assistance to local health departments regarding the appropriate installation and use of alternative systems and graywater systems.⁸⁷ A person may petition, in writing, the commission to approve the use of a particular material, product, method of manufacture or method or manner of construction or installation. On receipt of the petition, the commission shall cause to be conducted testing and evaluation it deem desirable. After testing and evaluation, and an open public hearing, the commission may reject the petition in whole or in part, may amend the code in such matter as the commission deems appropriate, or may grant a certificate of acceptability.⁸⁸

CONSTRUCTED WETLANDS: The Department of Environmental Quality provides a document entitled Review of Subsurface Flow Constructed Wetlands Literature and Suggested Design and Construction Practices. Constructed wetlands are run through a primary septic tank and then through a subsurface disposal system.⁸⁹ In fact, this guide recommends that at least two septic tanks should be provided with a total volume of at least two times the design daily flow.⁹⁰

Minnesota: Minnesota Pollution Control Agency, Water Quality Division, Nonpoint Source Compliance Section, 520 Lafayette Road, St. Paul, MN 55155-4194; Ph. (612) 296-7574; <http://www.revisor.leg.state.mn.us/arule/7080>

REGULATION(S): Chapter 7080.9010, Alternative and Experimental Systems [**Repealed as of 02/28/00!**]

COMPOSTING TOILETS: No regulations,⁹¹ except in Subpart 3G which mentions that other toilet waste treatment devices may be used where reasonable assurance of performance is provided.⁹²

GRAYWATER: Use of alternative systems is allowed only in areas where a standard system cannot be installed or is not the most suitable treatment. Subpart 3E of Ch. 7080.9010 states that a toilet waste treatment device must be used in conjunction with a graywater system. Accordingly, toilets wastes shall be discharged only to toilet waste treatment devices. Graywater or garbage shall not be discharged to the device, except as specifically recommended by a manufacturer. Septic systems are required for graywater systems. The drainage system in new dwellings or other establishments shall be based on a pipe diameter of two inches to prevent installation of a water flush toilet. There shall be no openings or connections to the drainage system, including floor drains, larger than two inches in diameter. For repair or replacement of an existing system, the existing drainage system may be used. Toilets or urinals of any kind shall not be connected to the drainage system. Toilet waste or garbage shall not be discharged to the drainage system. Garbage grinders shall not be connected to the drainage system. The building sewer shall meet all requirements for part 7080.0120, except that the building sewer for a graywater system shall be no greater than two inches in diameter. Graywater septic tanks shall meet all requirements of 7080.0130, subpart 1, except that the liquid capacity of a graywater septic tank serving a dwelling shall be based on the number of bedrooms existing and anticipated in the dwelling served and shall be at least as large as the following given capacities: 2 bedrooms, 300 gallon capacity; 3 or 4 rooms, 500 gallons; 5 or 6 rooms, 750 gallons; 7, 8 or 9 rooms, 1000 gallons. 4) Sizing for the system can be 60% of the amount calculated for a standard septic system. For ten or more bedrooms or other establishments, the graywater septic tank shall be sized as for any other establishment, except the minimum liquid capacity shall be at least 300 gallons. Graywater aerobic tanks shall meet all requirements of part 7080.0130. 6) Distribution and dosing of graywater shall meet all requirements of parts 7000.0150 and 7080.0160. 7) A standard graywater system shall meet all requirements of part 7080.0170. Experimental systems are discussed in subpart 3a. They may be used in areas where a standard systems cannot be installed or if a system is considered new technology with limited data on reliability.⁹³

CONSTRUCTED WETLANDS: No existing regulations.

Mississippi: Mississippi State Department of Health, PO Box 1700, Jackson, MS 39215-1700; Ph. (601) 576-7689; Contact: Ralph Turnbo.

REGULATION(S): Mississippi Individual On-Site Wastewater Disposal System Law, Chapter 41-67 (1996).

COMPOSTING TOILETS: 2.3 (28) Non-Waterborne Disposal System - any non-water carried system that treats and/or disposes of human excreta.⁹⁴ Non-Waterborne Wastewater Systems are covered under MSDH 300-Section 02A-XIII-01 (revised February 17, 1997). 1. In remote areas of the State or certain transient or temporary locations, the use of non-waterborne systems such as sanitary pit privies, portable toilets, incinerating toilets, composting toilets and related sewage systems may be approved. Due to their limited capacities, these systems are restricted to receive excreta only. Since such systems require regular service and maintenance to prevent their malfunction and overflow, they shall only be used where the local health department approves such use.⁹⁵

GRAYWATER: No existing regulations.

CONSTRUCTED WETLANDS: Constructed wetlands are discussed in Design Standard VII: Plant Rock Filter System, MSDH 300-Section 021-VII. I. A plant rock filter (constructed wetlands) wastewater treatment system may be utilized as an overland/containment system on sites where soil and site conditions prohibit the installation of a conventional or modified subsurface disposal system. In suitable soils, a plant rock filter may utilize underground absorption to dispose of effluent. It may also be utilized to polish effluent from malfunctioning "seeping" absorption field lines on existing systems. II. The plant rock filter may consist of a single cell, two cells in series

or multiple cells in series. The design will depend on the topography. Differences in individual design, construction materials and construction methods allow each of these types of plant/rock filter to vary widely in their application. Careful consideration should be made during the soil/site evaluation to ensure that the “best choice” is recommended for the particular site. Recommendations developed by the Tennessee Valley Authority’s General Design, Construction, and Operation Guidelines Constructed Wetlands Wastewater Treatment Systems for Small Users Including Individual Residences, Second Edition, have been adopted by reference.⁹⁶

Missouri: Missouri Department of Health, Bureau of Community Environmental Health, PO Box 570, Jefferson City, MO 65102-0570; Ph. (573) 751-6095; FAX (573) 526-6946 or 751-0247.

REGULATION(S): Missouri Laws for On-Site Disposal Systems, Chapter 701, Section 701.025 (28 August 1998).

COMPOSTING TOILETS: No existing regulations. May be covered under “Other Systems.” Where unusual conditions exist, special systems of treatment and disposal, other than those specifically mentioned in this rule, may be employed, provided: 1) reasonable assurance of performance of the system is presented to the administrative authority; 2) the engineering design of the system is first approved by the administrative authority; 3) adequate substantiating data indicate that the effluent will not contaminate any drinking water supply, groundwater used for drinking water or any surface water; 4) treatment and disposal of the waste will not deteriorate the public health and general welfare; and 5) discharge of effluent, if any, shall be within setback distances as described in the rules.⁹⁷

GRAYWATER: Under 701.025,12(b), graywater includes bath, lavatory, laundry, and sink waste, excepting human excreta, toilet waste, residential kitchen waste and other similar waste from household or establishment appurtenances.⁹⁸ Title 19, Division 20, Chapter 3, General Sanitation, defines graywater as liquid waste, specifically excluding toilet, hazardous, culinary and oily wastes, from a dwelling or other establishment which is produced by bathing, laundry, or discharges from floor drains.⁹⁹ There are no design recommendations or regulations governing graywater systems.

CONSTRUCTED WETLANDS: provide secondary levels of treatment, which means that some form of pretreatment (septic tank, aeration tank, lagoon, etc.), must be used prior to the wetland, as wetlands cannot withstand large influxes of suspended solids. The pretreatment used must be capable of removing a large portion of these solids. Effluent from wetlands must be contained on the owner’s property with the same set-back distances as required for lagoons. 1. Free water surface wetlands are shallow beds or channels with a depth less than 24 inches and filled with emergent aquatic plants. This type of wetland shall not be allowed. 2. Submerged flow wetlands are similar to free water surface wetlands except that the channels are filled with shallow depths of rock, gravel or sand. The depth of the porous media is usually less than 18 inches. The porous medium supports the root systems of the emergent aquatic vegetation. The water level is to be maintained below the top of the porous medium so that there is no open water surface. The configuration of a wetland for an individual home can be a one cell or two cells in a series, depending on the soil properties of the site.¹⁰⁰

Montana: Montana Department of Environmental Quality, Lee Metcalf Building, 1520 E. Sixth Avenue, PO Box 200901, Helena, MT 59620-0901; Ph. (406) 444-4633; FAX (406) 444-1374; Contact: Mark M. Peterson, P.E., Environmental Engineering Specialist, Permitting and Compliance Division; Email: mkpeter@mt.gov. REGULATION(S): Circular WQB 5. Minimum Design Standards for On-Site Alternative Sewage Treatment and Disposal Systems (1992).

COMPOSTING TOILETS: Under Chapter 70.1, waste segregation systems consist of dry disposal for human waste such as various chemical and incinerator type systems with separate disposal for graywater. However, regardless of the type of dry disposal system used, the graywater must be disposed of by primary (septic tank) and secondary (subsurface drainfield) treatment.¹⁰¹ Waste segregation systems will only be considered for recreational type dwellings which receive seasonal use or commercial buildings.¹⁰²

GRAYWATER: No existing regulations. Graywater must be disposed of through a septic tank and drainfield system.

CONSTRUCTED WETLANDS: No existing regulations.

Nebraska: Nebraska Department of Environmental Quality, Ground Water Section, PO Box 98922, Lincoln, NE 68509-8922; Ph. (402) 471-2580 or (505) 827-7541;

<http://www.deq.state.ne.us/RuleAndR.nsf/390ed3941b29c12f8625682c006210e9/80857228ae0f5c2786256800005153a8?OpenDocument>;

Contact: Brian Sohall.

REGULATION(S): If they existed, regulations would probably be found in Title 124, Rules and Regulations for Design, Operation and Maintenance of Onsite Wastewater Treatment Systems.

COMPOSTING TOILETS, GRAYWATER, CONSTRUCTED WETLANDS: No existing regulations. Graywater is defined, but no systems are necessarily allowed under Title 124.

Nevada: Department of Human Resources, Health Division, Bureau of Health Protection Services, 1179 Fairview Drive, Suite 101, Carson City, NV 89701-5405; Ph. (702) 687-6615 (general number); Ph. (702) 687-4750 (direct line); Contact: Joe Pollack.

REGULATION(S): R129-98. Sewage disposal is regulated under Nevada Administrative Code 444.750 (February 1998).

COMPOSTING TOILETS: Not approved.

GRAYWATER: systems are governed under Regulation R129-98, Section 78. 1. Graywater may be used for underground irrigation if approved by the administrative authority. A homeowner must obtain a permit to construct, alter or install a system that uses graywater for

underground irrigation from the administrative authority before such a system may be constructed, altered or installed. 2. A system that uses graywater for underground irrigation: a) may be used only for a single family dwelling; b) must not be used in soils which have a percolation rate that is greater than 120 minutes per inch; c) must consist of a three-way diversion valve, a holding tank for the graywater and an irrigation system; d) may be equipped with a pump or siphon, or may rely on gravity to cause the water to flow to the irrigation system; e) must not be connected to a system for potable water; and f) must not result in the surfacing of any graywater. 3. A system that uses graywater for underground irrigation, or any part thereof, must not be located on a lot other than the lot which is the site of the single-family dwelling that discharges the graywater to be used in the system. Section 79. 1. An application to construct, alter or install a system that uses graywater for underground irrigation must include: a) detailed plans of the system to be constructed, altered or installed; b) detailed plans of the existing and proposed sewage disposal system; and c) data from percolation tests conducted in accordance with NAC 444.796 and sections 40 to 43, inclusive, of this regulation. 2. A holding tank for graywater must: a) be watertight and constructed of solid, durable materials that are not subject to excessive corrosion or decay; b) have a minimum capacity of 50 gallons; c) have an overflow and an emergency drain. The overflow and emergency drain must not be equipped with a shutoff valve. 3. A three-way diversion valve, emergency drain and overflow must be permanently connected to the building drain or building sewer and must be located upstream from any septic tanks. The required size of an individual sewage disposal system must not be reduced solely because a system that uses graywater for underground irrigation is being used in conjunction with the individual sewage disposal system. 4. The piping for a system that uses graywater for underground irrigation which discharges into the holding tank or is directly connected to the building sewer must be downstream of any vented trap to protect the building from possible sewer gases. 5. The estimated discharge of a system that uses graywater for underground irrigation must be calculated based on the number of bedrooms in the building, as follows: a) for the first bedroom, the estimated discharge of graywater is 80 gallons per day; and b) for each additional bedroom, the estimated discharge of graywater is 40 gallons per day. 6. The absorption area for an irrigation system that includes a system that uses graywater for underground irrigation must be calculated in accordance with the following parameters: percolation rate of 0-20 minutes per inch, 20 square feet (minimum square feet per 100 gallons discharged per day); 21-40 minutes/inch, 40 gallons/day; 41-60 minutes/inch, 60 gallons/day.¹⁰³

CONSTRUCTED WETLANDS: No existing regulations.

New Hampshire: Department of Environmental Services, Bureau of Wastewater Treatment, 6 Hazen Drive, Concord, NH 03301; Ph. (603) 271-3711 or 3503; <http://www.state.nh.us/gencourt/ols/rules/env-ws.htm>

REGULATION(S): Chapter Env-Ws 1000 Subdivision and Individual Sewage Disposal System Design Rules. Env-Ws 1022 deals with Alternate Systems.

COMPOSTING TOILETS, GRAYWATER, CONSTRUCTED WETLANDS: No existing regulations. New Hampshire, does, however, have extensive regulations pertaining to Alternate Systems, as follows. Part Env-Ws 1024 Innovative/Alternative Technology. The purpose of this part is to provide the methodology and review process for the approval of innovative/alternative individual sewage disposal systems, in compliance with RSA 485-A:29, I. b. This part shall apply to any proposed individual sewage disposal system technology not described elsewhere in Env-Ws 1000. a. "Conventional system" means an individual sewage disposal system regulated under Env-Ws 1000 other than Env-Ws 1024. b. "Innovative/Alternative waste treatment" as defined in RSA 485-A:2, XXI, includes individual sewage disposal systems. c. "ITA" means innovative/alternative technology approval. Env-Ws 1024.03 a. If the system will require ongoing professional maintenance, a service contract for such maintenance shall be executed before operational approval is granted. b. In exchange for obtaining the benefit of an operational approval based on innovative/alternative technology, the owner shall covenant to replace the innovative/alternative system with a conventional system should the innovative/alternative system fail to operate lawfully. The covenant shall be recorded by the owner at the registry of deeds where the property is located. Env-Ws 1024.04 ITA Applications. a. Before an innovative/alternative waste treatment system may be used the technology shall be evaluated and approved in an ITA. b. To obtain an ITA, an owner, designer, or other person shall submit a letter of application that includes the following: 1). A written description of the proposed system; 2) All operational reports, patent information, technical reports, and laboratory reports published on the proposed system, even if the information might in whole or in part reflect negatively on the system; 3) A description of any advantages of the proposed system over conventional systems in the prevention of health hazards, surface and groundwater pollution, and any other environmental benefits; 4). A description of the possible risks to public health, surface or groundwaters, or other aspects of the environment of using the proposed system; 5). The names, addresses, and phone numbers of at least three individuals who have experience in the design operation of the same type of system; 6). The proposed system's effect on the area of land required for operation; 7). A list of any rules under Env-Ws 1000 for which waivers will be required; and 8). A list of site locations where the system has been used, whether successfully or not.¹⁰⁴

New Jersey: Department of Environmental Protection, Bureau of Nonpoint Pollution Control, PO Box 029, Trenton, NJ 08625-0029; Ph. (609) 292-0404 or 4543; <http://www.state.nj.us/dep/dwq/rules.htm>

REGULATION(S): New Jersey Administrative Code 7:9A Standards for Individual Subsurface Sewage Disposal Systems.

COMPOSTING TOILETS: No existing regulations. GRAYWATER: 7:9A-2.1 "Graywater" means that portion of the sanitary sewage generated within a residential, commercial or institutional facility which does not include discharges from water closets or urinals.¹⁰⁵ 7:9A-1.8 (c) In cases where the actual volume of sanitary sewage discharged from a facility will be reduced by use of water-saving plumbing

fixtures, recycling of renovated wastewater, incineration or composting of wastes, evaporation of sewage effluent or any other process, the requirement for obtaining a treatment works approval and a NJPDES permit shall be based upon the design volume of sanitary sewage, calculated as prescribed in N.J.A.C. 7:9A-7.4, rather than the actual discharge volume as modified by water conservation or special treatment processes. 7:9A-7.3 (a) The system(s) shall be designed to receive all sanitary sewage from the building served except in the following cases: 1. Separate systems may be designed to receive only graywater, or only blackwater, as allowed in N.J.A.C. 7:9A-7.5. 7:9A-7.5 A graywater system may be approved by the administrative authority provided that all of the requirements of these standards are satisfied and provided that an acceptable means for disposal of the blackwater from the building served is indicated in the system design. When the blackwater from the building served by a graywater system is to be disposed of into a waterless toilet, a variance from the Uniform Construction Code, Plumbing sub-code, N.J.A.C. 5:23-3.5, must be obtained by the applicant prior to approval of the graywater system by the administrative authority and the volume of sanitary sewage to be used in the design of the graywater system shall be determined as prescribed in N.J.A.C. 7:9A-7.4. When the blackwater from the building served by a graywater system is to be disposed of into a separate subsurface sewage disposal system, the blackwater system shall meet all the requirements of this chapter and the volume of sanitary sewage used in the design of both the graywater system and the blackwater system shall be a minimum of 75 % of the volume of sanitary sewage determined as prescribed in N.J.A.C. 7:9A-7.4.¹⁰⁶ 7:9A-7.6 Each system approved by the administrative authority pursuant to this chapter shall consist of a septic tank which discharges effluent through a gravity flow, gravity dosing or pressure dosing network to a disposal field as hereafter described. Seepage pits shall not be approved for new installations except in the case of a graywater system as provided by in N.J.A.C. 7:9A-7.5. Installation of a seepage pit may be approved as an alteration for an existing system subject to the requirements of N.J.A.C. 7:9A-3.3.¹⁰⁷

CONSTRUCTED WETLANDS: No existing regulations.¹⁰⁸ 7:9A-3.11 Experimental systems The Department encourages the development and use of new technologies which may improve the treatment of sanitary sewage prior to discharge or allow environmentally safe disposal of sanitary sewage in areas where standard sewage disposal systems might not function adequately. Where the design, location, construction or installation of the system or any of its components does not conform to this chapter, the administrative authority shall direct the applicant to apply to the Department for a treatment works approval. Depending upon the volume and quality of the wastewater discharged, a NJPDES permit may also be required.¹⁰⁹

New Mexico: State of New Mexico Environment Department, 524 Camino De Los Marquez, Suite 4, Santa Fe, NM 87505; Ph. (505) 827-7545 or 7541 (direct number); FAX (505) 827-7545; Contact: R. Brian Schall, Water Resource Specialist/Community Services.
REGULATION(S): 20 NMAC 7.3, Liquid Waste Disposal Regulations (10 October 1997).

COMPOSTING TOILETS: Composting toilets are allowed, although there is no mention of them in the regulations.¹¹⁰

GRAYWATER: Subpart I, Part 107. AF. "graywater" means water carried waste from kitchen (excluding garbage disposal) and bathroom sinks, wet bar sinks, showers, bathtubs and washing machines. Graywater does not include water carried wastes from kitchen sinks equipped with a garbage disposal, utility sinks, any hazardous materials, or laundry water from the washing of material soiled with human excreta.¹¹¹ Revised regulations will have a separate section allowing graywater systems. However, the system will still have to run through a septic tank. Graywater can then be used for subsurface irrigation.¹¹²

CONSTRUCTED WETLANDS: Constructed wetlands are considered an "alternative system."¹¹³ Subpart II deals with alternative systems. The Department may issue a permit, on an individual basis, for the installation of an alternative on-site liquid waste system, including a system employing new and innovative technology, if the permit applicant demonstrates that the proposed system, by itself or in combination with other on-site liquid waste systems, will neither cause a hazard to public health nor degrade a body of water, and that the proposed system will provide a level of treatment at least as effective as that provided by on-site liquid waste systems, except privies and holding tanks, that meet the requirements of this Part and the New Mexico Design Standards.¹¹⁴

New York: New York State Department of Health, Bureau of Community Sanitation and Food Protection, 2 University Place, Room 404, Albany, NY 12203-3399; Ph. (518) 458-6706; Contact: Ben Pierson.

REGULATION(S): Appendix 75-A, Wastewater Treatment Standards - Individual Household Systems, Statutory Authority: Public Health Law 201(1)(1) (1 December 1990).

COMPOSTING TOILETS: 75-A. 10 Other Systems. (b) Non-Waterborne Systems. (1) In certain areas of the State where running water is not available or is too scarce to economically support flush toilets, or where there is a need or desire to conserve water, the installation of non-waterborne sewage systems may be considered, however, the treatment of wastewater from sinks, showers, and other facilities must be provided when non-flush toilets are installed. The Individual Residential Wastewater Treatment Systems Design Handbook gives more detail regarding composting toilets.¹¹⁵ The State Uniform Fire Prevention and Building Code [9NYCRR Subtitle S Sections 900.1(a) and (b)] requires wet plumbing (i.e., potable water plus sewerage) for all new residences. In accordance with Section 900.2(b), minimal required plumbing fixtures may be omitted for owner occupied single family dwellings if approved by the authority having jurisdiction. Health Department approval for said omission(s) shall be fully protective of public health and be in general harmony with the intent of Section 900.1 (i.e., provide satisfactory sanitary facilities). In some areas of the state where available water becomes insufficient to economically use flush toilets (i.e., even those with only 1.6 gallons per flush) or where a need or desire exists to conserve water, use of non-waterborne systems may be justified.¹¹⁶ **Composters:** These units accept human waste into a chamber where composting of the waste

occurs.¹¹⁷ Composters accept only toilet wastes and kitchen food scraps coupled with supplemental additions of carbon-rich bulking agents such as planar shavings or coarse sawdust. Household cleaning products should not be placed in the unit. Failure to add adequate bulking agents or maintain aerobic moisture can result in the pile becoming hard (and difficult to remove) or anaerobic. The composted humus contains numerous bacteria and may also contain viruses and cysts. Residual wastes (i.e., the composted humus) should be periodically removed by a professional septage hauler. If a homeowner chooses to personally remove the composted humus, it should be disposed of at a sanitary landfill or buried and well mixed into soil distant from food crops, water supply sources and watercourses. The humus comprises an admixture of recent additions and composted older additions and should be disposed of accordingly. Humus disposal sites shall meet Table 2 separation distances for sanitary privy pits.¹¹⁸ These units shall be installed in accordance with the manufacturers instructions. The units shall have a label indicating compliance with the requirements of NSF Standard 41 or equivalent. Only units with a warranty of five years or more shall be installed.¹¹⁹

GRAYWATER: systems shall be designed upon a flow of 75 gpd/bedroom and meet all the criteria previously discussed for treatment of household wastewater.¹²⁰ The treatment of household wastewater is regulated by 75-A.8. Subsurface Treatment. (a) General Information. All effluent from septic tanks or aerobic tanks shall be discharged to a subsurface treatment system. Surface discharge of septic tank or aerobic effluent shall not be approved by the Department of Health or a local health department acting as its agent.¹²¹

CONSTRUCTED WETLANDS: There is no official state policy regarding constructed wetlands. It is doubtful that the state or county health departments would approve them.¹²²

North Carolina: Department of Environmental Health and Natural Resources, Division of Environmental Health, On-Site Wastewater Section, PO Box 27687, Raleigh, NC 27611-7687; Ph. (919) 733-2895 or 7015.

REGULATION(S): Sewage Treatment and Disposal Systems, Section .1900 (April 1993).

COMPOSTING TOILETS: Section.1934. The rules contained in this Section shall govern the treatment and disposal of domestic type sewage from septic tank systems, privies, incinerating toilets, mechanical toilets, composting toilets, recycling toilets, or other such systems serving single or multiple family residences, places of business, or places of public assembly, the effluent from which is designed not to discharge to the land surface or surface waters. Section.1958 (a) Where an approved privy, an approved septic tank system, or a connection to an approved public or community sewage system is impossible or impractical, this Section shall not prohibit the state or local health department from permitting approved non-ground absorption treatment systems utilizing heat or other approved means for reducing the toilet contents to inert or stabilized residue or to an otherwise harmless condition, rendering such contents noninfectious or noncontaminating. Alternative systems shall be designed to comply with the purposes and intent of this Section. (c) Incinerating, composting, vault privies, and mechanical toilets shall be approved by the state agency or local health department only when all of the sewage will receive adequate treatment and disposal.¹²³

GRAYWATER, CONSTRUCTED WETLANDS: No existing regulations.¹²⁴

North Dakota: North Dakota Department of Health, Environmental Health Section, Division of Municipal Facilities, 1200 Missouri Avenue, Bismarck, ND 58504-5264; Ph. (701) 328-5211 or 5150; FAX (701) 328-5200; Contact: Jeff Hauge, P.E, Environmental Engineer.

REGULATION(S): Chapter 62-03-16. Individual Sewage Treatment Systems for Homes and Other Establishments Where Public Sewage Systems are not Available (1996).

COMPOSTING TOILETS: 62-03-16-01. Where water under pressure is not available, all human body wastes shall be disposed of by depositing them in approved privies, chemical toilets or such other installations acceptable to the administrative authority.¹²⁵

GRAYWATER: 62-03-16-01. 6. Water-carried sewage from bathrooms, kitchens, laundry fixtures, and other household plumbing shall pass through a septic or other approved sedimentation tank prior to its discharge into the soil or into an alternative system. Where underground disposal for treatment is not feasible, consideration will be given to special methods of collection and disposal.¹²⁶

CONSTRUCTED WETLANDS: No existing regulations.

Ohio: Bureau of Local Services, Ohio Department of Health, 246 North High Street, Columbus, OH 43266-0588; Ph. (614) 466-5190 or 1390; Contact: Tom Grigsby, Program Specialist; Email: tgrigsby@gw.odh.state.oh.us

REGULATION(S): O.A.C. Chapter 3701-29 Household Sewage Disposal Rules (1977).

COMPOSTING TOILETS, GRAYWATER, CONSTRUCTED WETLANDS: No existing regulations. Chapter 3701-29-20. Variance. (C). Household sewage disposal system components or household sewage disposal systems differing in design or principle of operation from those set forth in rules 3701-29-01 to 3701-29-21, may qualify for approval as a special device or system provided, comprehensive tests and investigations show any such component or system produces results equivalent to those obtained by sewage disposal components or systems complying with such regulations. Such approval shall be obtained in writing from the director of health.¹²⁷

Oklahoma : Department of Environmental Quality, 1000 Northeast 10th Street, Oklahoma City, OK 73177-1212; Ph. (405) 271-7363 or 702-8100 (Division of Water Quality); Contact: Donnie Johnson.

REGULATION(S): Chapter 640. Individual and Small Public Sewage Disposal (1998).

COMPOSTING TOILETS, GRAYWATER, CONSTRUCTED WETLANDS: No existing regulations. Chapter 640-1-12 governs alternative/experimental disposal systems. Where unusual conditions exist, special systems of treatment and disposal, other than individual sewage disposal systems mentioned may be employed, provided that: 1) reasonable assurance is presented to the Department that the system will work properly; 2) the design of the system is approved by the Department prior to installation; 3) there is no discharge to the waters of the state; 4) treatment and disposal of waste are in such a manner as to protect public health and the environment; 5) such systems comply with all local codes and ordinances. (b) Special alternative systems or experimental systems shall be considered on a case-by-case basis, weighing heavily in the approval process. The plans for alternative systems shall be reviewed by the Department and approved or disapproved by the Area or Regional Supervisor. After construction, the installation of the alternative system shall be approved or disapproved by the local DEQ representative. (c) To apply for approval of such systems an applicant shall file two copies of test results based on OAC 252:640-1-9 and two copies of the design plan for the proposed system with the local representative of the Department for the area in which the property is located.¹²⁸

Oregon: Department of Environmental Quality, Water Quality Division, 811 Southwest 6th Avenue, Portland, OR 97204-1390; Ph. (503) 229-6443; <http://www.cbs.state.or.us/> (click on statute/rules and go to oar 918-770 (division 770)); <http://landru.leg.state.or.us/ors/447.htm>; <http://arcweb.sos.state.or.us/banners/rules.htm>; Contact: Sherman Olson, Terry Swisher: Ph (503) 373-7488.

REGULATION(S): Oregon Administrative Rules, Chapter 918, Division 790, Composting Toilet Rules (1998); Oregon Revised Statutes 447.115 (1997); OAR Chapter 340, Division 71 (1997).

COMPOSTING TOILETS: As used in ORS 447.118 and 447.124, "compost toilet" means a permanent, sealed, water-impervious toilet receptacle screened from insects, used to receive and store only human wastes, urine and feces, toilet paper and biodegradable garbage, and ventilated to utilize aerobic composting for waste treatment. 447.118 (1) Nothing in ORS 447.010 to 447.160 shall prohibit the installation of a compost toilet for a dwelling by the occupant of the dwelling if the compost toilet complies with the minimum requirements established under this section. (2) Rules adopted under ORS 447.020 shall provide minimum requirements for the design, construction, installation and maintenance of compost toilets. (3) The Director of the Department of Consumer and Business Services with the approval of the State Plumbing Board may require by rule that, in addition to any other requirements provided by law, any manufacturer or distributor of a compost toilet and any person other than the owner of the dwelling in which the compost toilet is to be installed who proposes to install a compost toilet file with the Department of Consumer and Business Services a satisfactory bond, irrevocable letter of credit issued by an insured institution as defined in ORS 706.008 or other security in an amount to be fixed by the department with approval of the board but not to exceed \$5,000, conditioned that such bond, letter of credit or security shall be forfeited in whole or in part to the department for the purpose of carrying out the provisions of ORS 447.124 by failure of such manufacturer, distributor or person to comply with the rules adopted under this section. 447.124 The Department of Consumer and Business Services, with the assistance of the Health Division: (1) May conduct periodic inspections of any compost toilet; (2) Upon making a finding that a compost toilet is in violation of the rules adopted pursuant to ORS 447.118 (2), may issue an order requiring the owner of the dwelling served by the compost toilet to take action necessary to correct the violation; and (3) Upon making a finding that a compost toilet presents or threatens to present a public health hazard creating an emergency requiring immediate action to protect the public health, safety or welfare, may issue an order requiring the owner of the dwelling served by the compost toilet to take any action necessary to remove such hazard or threat thereof. If such owner fails to take the actions required by such order, the department shall take such action, itself or by contract with outside parties, as necessary to remove the hazard or threat thereof.¹²⁹ More specific information regarding composting toilets is given under Chapter 918-718-0010. Composting toilets: 1) must be ventilated (electrical or mechanical); 2) shall have at least one cubic yard capacity for a one or two bedroom dwelling; 3) shall be limited to installation in areas where a graywater disposal system can be installed and used; 4) shall be installed in an insulated area to keep a biological balance of the materials therein; and 5) humus from composting toilets may be used around ornamental shrubs, flowers, trees, or fruit trees and shall be buried under at least 12 inches of soil cover. Deposit of humus from any compost toilet around any edible vegetation or vegetable shall be prohibited.¹³⁰ Composting toilets must be approved by the NSF Standard 41.¹³¹

GRAYWATER: 447.140 (1) All waste water and sewage from plumbing fixtures shall be discharged into a sewer system or alternate sewage disposal system approved by the Environmental Quality Commission or department of Environmental Quality under ORS chapters 468, 468A and 468B. Graywater is technically defined as sewage and still requires a septic tank and drainfield, although the septic system can be reduced in size.¹³² Chapter 340, Divisions 71 and 73: Under the "split-waste method," blackwater sewage and graywater sewage from the same dwelling or building are disposed of by separate systems.¹³³ 340-71-320. Split Waste Method. In a split waste method, wastes may be disposed of as follows: (1) Black wastes may be disposed of by the use of State Building Codes Division approved non-water carried plumbing units such as recirculating oil flush toilets or compost toilets. (2) Graywater may be disposed of by discharge to: a) an existing on-site system which is not failing; or b) a new on-site system with a soil absorption facility 2/3 normal size. A full size initial disposal area and replacement disposal area of equal size are required; or c) a public sewerage system.¹³⁴

CONSTRUCTED WETLANDS: Performance based permits are issued for constructed wetlands. Several systems have been installed in Oregon, but not for single family homes.¹³⁵

Pennsylvania: Department of Environmental Protection, Bureau of Water Quality Protection, Division of Wastewater Management, Rachel Carson State Office Building, 11th Floor, 400 Market Street, Harrisburg, PA 17101-2301; Ph. (717) 787-8184.

REGULATION(S): Title 25. Environmental Protection, Chapter 73. Standards for Sewage Disposal Facilities, Current through 28 Pa.B. 348 (17 January 1998).

COMPOSTING TOILETS: under Chapter 73.1 are defined as devices for holding and processing human and organic kitchen waste employing the process of biological degradation through the action of microorganisms to produce a stable, humus-like material.¹³⁶ Composting toilets are permitted under Ch. 73.65. Toilets must bear the seal of the NSF indicating testing and approval by that agency under Standard No. 41. (b) The device utilized shall meet the installation specifications of the manufacturer and shall be operated and maintained in a manner that will preclude any potential pollution or health hazards. (c) When the installations of a recycling toilet, incinerating toilet or composting toilets is proposed for a new residence or establishment, an onlot sewage system or other approved method of sewage disposal shall be provided for treatment of washwater or excess liquid from the unit. For existing residences, where no alteration of the on lot system is proposed, a permit is not required to install a composting toilet.¹³⁷

GRAYWATER: 73.11. (c) Liquid wastes, including kitchen and laundry wastes and water softener backwash, shall be discharged to a treatment tank.¹³⁸

CONSTRUCTED WETLANDS: No existing regulations. Ch. 73.71 governs Experimental Sewage Systems, which may be implemented upon submittal of a preliminary design plan. Experimental systems may be considered for individual or community systems in any of the following cases: 1) To solve existing pollution or public health problem; 2) To overcome specific site suitability deficiencies, or as a substitute for systems described in this chapter on suitable lots; 3) To overcome specific engineering problems related to the site or proposed uses; and 4) To evaluate new concepts or technologies applicable to onlot disposal.¹³⁹

Rhode Island: Department of Environmental Management, Division of Groundwater and Individual Sewage Disposal Systems, ISDS Section, 291 Promenade Street, Providence, RI 02908-5767; Ph. (401) 277-4700; <http://www.state.ri.us/dem/regs/water/isds9-98.pdf> or [.doc](#)

REGULATION(S): Chapter 12-120-002, Individual Sewage Disposal Systems (September 1998).

COMPOSTING TOILETS: Regulation 12-120-002, amended September 1998, governs composting toilet guidelines. SD 14.00 discusses the acceptability of composting, or humus, toilets, stating that a humus or incinerator type toilet may be approved for any use where a septic tank and leaching system can be installed. The regulation governs two types of composting toilets: 1) large capacity composting toilets; and 2) heat assisted composting toilets. Large capacity toilets must have an interior volume greater than or equal to 64 cubic feet. All waste removed from large capacity composting toilets shall be disposed of by burial or other means approved by the director. Separate subsurface sewage disposal facilities must be provided for disposal of any liquid wastes from sinks, tubs, showers and laundry facilities (SD 14.05).¹⁴⁰

GRAYWATER: The term, "graywater," shall be held to mean any wastewater discharge from a structure excluding the waste discharges from water closets and waste discharges containing human or animal excrement. The term, "sanitary sewage," shall be held to mean any human or animal excremental liquid or substance, any putrescible animal or vegetable matter and/or any garbage and filth, including, but not limited to, any graywater or blackwater discharged from toilets, laundry tubs, washing machines, sinks, and dishwashers as well as the content of septic tanks, cesspools, or privies.¹⁴¹

CONSTRUCTED WETLANDS: No existing regulations. Section SD14.06 governs Innovative or Alternative Technology Approval Procedures (this is an extensive section on the procedures, that are required to install an alternative system).¹⁴²

South Carolina: Onsite Wastewater Management Branch, Division of Environmental Health, Department of Health and Environmental Control, 2600 Bull Street, Columbia, SC 29201; Ph. (803) 935-7945; FAX (803) 935-7825; Contact: Richard Hatfield; Email: HATFIERL@columb72.dhec.state.sc.us

REGULATION(S): Chapter 61-56, Individual Waste Disposal Systems (27 June 1986).

COMPOSTING TOILETS: Composting toilets may be used in conjunction with an approved septic system, for facilities that are provided with water under pressure. If site and soil conditions are not acceptable for an approved septic system, an alternative toilet may be considered, but only if the facility is not connected to water under pressure.

GRAYWATER: No existing regulations. Graywater is included within the Department's definition of sewage and must be managed appropriately. A permit applicant could elect to install separate systems to handle blackwater and graywater, but the same site and soil requirements apply for both systems.

CONSTRUCTED WETLANDS: Constructed wetlands (rock/plant filter) may be installed by an owner, but only in conjunction with an approved pre-treatment system, such as a septic tank, and an approved disposal system, such as a drain field. A limited number of homeowners have elected to use constructed wetlands systems in an effort to mitigate failing conventional systems.¹⁴³ Regulation 61-56, Individual Waste Disposal Systems, grants authority to the Department of Health and Environmental Control to adopt standards for alternative onsite treatment and disposal systems. However, no technical standards have been developed for graywater systems, constructed wetlands or composting toilets.

South Dakota: Department of Environment and Natural Resources, Air and Surface Water Program, Joe Foss Building, 523 East Capitol, Pierre, SD 57501; Ph. (605) 773-3151; <http://www.state.sd.us/state/legis/lrc/rules/7453.htm>

REGULATION(S): Chapter 74:53:01:10 (1 July 1996).

COMPOSTING TOILETS: Unconventional systems are only to be used when water or electrical systems are unavailable. Vault privies, chemical toilets, incinerator toilets, or composting units shall be used when a water or electrical system is not available. With the exception of vault privies, all unconventional systems are considered experimental systems, and plans and specifications shall be submitted to the secretary for approval as an experimental system prior to installation.¹⁴⁴

GRAYWATER: Under Chapter 74:03: 01:38, graywater systems are wastewater systems designed to recycle or treat wastes from sinks, lavatories, tubs, showers, washers, or other devices which do not discharge garbage or urinary or fecal wastes. In areas where they will not create a public nuisance or enter any water of the state, graywater systems are exempt from the requirement that normally states that wastewater is not allowed to surface on, around, or enter state waters. 74-03:01:75. A graywater system shall be designed in accordance with the following criteria: 1) All graywater treatment and recycle systems shall be located in accordance of the distances specified in 74:03.01:56, Table 1; 2) Design of graywater systems shall be based on a minimum graywater flow of 25 gallons per day per person. Three days retention time shall be provided for each graywater tank; 3) Graywater tanks are septic tanks and shall conform to the requirements for septic tanks; and 4) Effluent from graywater systems may be recycled for toilet use, conveyed to absorption fields, mounds or seepage pits, or used for irrigation of lawns and areas not intended for food production. Percolation tests shall be conducted and the minimum size of absorption area shall be determined in accordance with 74:03:01:66 to 74:03:01:69, inclusive.¹⁴⁵

CONSTRUCTED WETLANDS: No existing regulations.

Tennessee: Tennessee Department of Environment and Conservation, Division of Ground Water Protection, L & C Tower, 10th Floor, 401 Church Street, Nashville, TN 37243-1540; Ph. (615) 532-0774; Contact: Stephen Morse, Environmental Manager. Regulation(s): Rules of Department of Environment and Conservation, Division of Ground Water Protection, Chapter 1200-1-6: Regulations to Govern Subsurface Sewage Disposal Systems (1997).

COMPOSTING TOILETS: (2) Composting toilets must be certified by the NSF to be in compliance with NSF Standard 41, and be published in their Listing of Certified Wastewater Recycle/Reuse and Water Conservation Devices before they may be used for disposal of human excreta by non-water carriage methods. (c) A pit privy or composting toilet shall not be permitted for a facility where the facility has running water available unless there is an acceptable means to dispose of wastewater.¹⁴⁶

GRAYWATER, CONSTRUCTED WETLANDS: No existing regulations. However, the Tennessee Valley Authority does publish a set of guidelines for the design and construction of constructed wetlands: Tennessee Valley Authority's General Design, Construction, and Operation Guidelines — Constructed Wetlands Wastewater Treatment Systems for Small Users Including Individual Residences, Second Edition, by Steiner, et al., 1993.

Texas: Texas Natural Resource Conservation Commission, PO Box 13087, Austin, TX 78711-3087; Ph. (512) 239-4775; <http://www.tnrcc.state.tx.us/>

REGULATION(S): Chapter 285: On-Site Sewage Facilities (1999).

COMPOSTING TOILETS: 285.2 (13) Composting toilet - A self-contained treatment and disposal facility constructed to decompose non-waterborne human wastes through bacterial action facilitated by aeration. 285.34 Other Requirements (e) Composting toilets will be approved by the executive director provided the system has been tested and certified under NSF Standard 41 ¹⁴⁷ 285.2 (27)

GRAYWATER: wastewater from clothes washing machines, showers, bathtubs, handwashing lavatories, and sinks not used for the disposal of hazardous or toxic ingredients or waste from food preparations. Subchapter H: 285.80. Treatment and Disposal of Graywater. New construction or modification to an existing graywater conveyance, treatment, storage or disposal system outside of a structure or building must be carried out in accordance with provisions of this chapter and any established requirements of the permitting authority. Any new construction or modification to an existing graywater reuse or reuse conveyance system associated with a structure or building must be carried out in accordance with the requirements of the State Board of Plumbing Examiners.¹⁴⁸ Graywater must be treated through a septic system first.¹⁴⁹

CONSTRUCTED WETLANDS: Permitted under 285.32C. Non-standard systems include, but are not limited to, all forms of the activated sludge process, rotating biological contactors, recirculating sand filters, and submerged rock biological filters (a fancy name for constructed wetlands). Non standard systems submitted for review will be analyzed on basic engineering principles and the criteria established in Chapter 285. These systems will be reviewed as one of a kind, site-specific installations. Whether blackwater or graywater, all domestic water-carried discharges have to go through a septic tank first before going through a wetland system. After passing through the wetland system, it must still go through a drainfield.¹⁵⁰

Utah: Department of Environmental Quality, Division of Water Quality, 288 North 1460 West, PO Box 144870, Salt Lake City, UT 84114-4870; Ph. (801) 538-6146; <http://www.eq.state.ut.us/eqwq/wqrules.htm>

REGULATION(S): If they existed, they may be covered under R317-502-3, Individual Wastewater Disposal Systems (1993).

COMPOSTING TOILETS, GRAYWATER, CONSTRUCTED WETLANDS: No existing regulations. R317-502-3. does speak to

alternative systems. The drainage system of each dwelling, building or premises covered herein shall receive all wastewater (including but not limited to bathroom, kitchen, and laundry wastes) as required by the Uniform Plumbing Code and shall have a connection to a public sewer except when such sewer is not available or practicable for use, in which case connection shall be made as follows: 3.1 To an individual wastewater disposal system found to be adequate and constructed in accordance with requirements stated herein. 3.2 To any other type of wastewater disposal system acceptable under R317-1, R317-3, R317-5, or R317-560. R317-502-20. Experimental and Alternate Disposal Methods. 20.1 Where unusual conditions exist, experimental methods of wastewater disposal may be employed provided they are acceptable to the Division and to the local health department having jurisdiction. 20.2 When considering proposals for experimental individual wastewater disposal systems, the Division shall not be restricted by this rule provided that: A. The experimental system proposed is attempting to resolve an existing pollution or public health hazard, or when the experimental system proposal is for new construction, it has been predetermined that an acceptable back-up disposal system will be installed in event of failure of the experiment; B. The proposal for an experimental individual wastewater disposal system must be in the name of and bear the signature of the person who will own the system; and C. The person proposing to utilize an experimental system has the responsibility to maintain, correct, or replace the system in event of failure of the experiment. 20.3 When sufficient, successful experience is established with experimental individual wastewater disposal systems, the Division may designate them as approved alternate individual wastewater disposal systems. Following this approval of alternate individual wastewater disposal systems, the Division will adopt rules governing their use.¹⁵¹

Vermont: Agency of Natural Resources, Department of Environmental Conservation, Wastewater Management Division, 103 South Main Street, The Sewing Building, Waterbury, VT 05671-0401; Ph. (802) 241-3834; Contact: Bonnie J. Loomer-Hostelter; Email: bonniel@dec.anr.state.vt.us

REGULATION(S): If they existed, they would most likely be found under Environmental Protection Rules, Chapter 1, Small Scale Wastewater Treatment and Disposal Rules (8 August 1996).

COMPOSTING TOILETS, GRAYWATER, CONSTRUCTED WETLANDS: No existing regulations. Innovative systems are regulated under Chapter 1, Small Scale Wastewater Treatment and Disposal Rules. Innovative Systems are governed under subchapter 2, 1-203. Alternative systems are allowed in Vermont only if a back-up, in ground conventional (septic) system is installed.¹⁵² Constructed wetlands as treatment units could be approved if the design was sufficiently reliable given the extended winter season in Vermont. However, for all practical purposes, the discharge from a constructed wetland unit could not be discharged directly into surface waters under these regulations but would have to be discharged to a subsurface leachfield or possibly a sprayfield system.¹⁵³

Virginia: State of Virginia, Office of Environmental Health Services, Main Street Station, Suite 117, PO Box 2448, Richmond, VA 23218-2448; Ph. (804) 225-4030; <http://www.vdh.state.va.us/onsite/regulations/sew-vac4.htm>; Contact: Donald Alexander; Email: dalexander@vdh.state.va.us

REGULATION(S): 12 VAC 5-610-980.

COMPOSTING TOILETS: Article 6. 12 VAC 5-610-970. 3. Composting toilets are devices which incorporate an incline plane, baffles, or other suitable devices onto which human excreta is deposited for the purpose of allowing aerobic decomposition of the excreta. The decomposing material is allowed to accumulate to form a humus type material. These units serve as both toilet and disposal devices. Composting toilets are located interior to a dwelling. All materials removed from a composting privy shall be buried. Compost material shall not be placed in vegetable gardens or on the ground surface. All composting toilets must be certified by the National Sanitation Foundation as meeting the current Standard 41.

GRAYWATER: No existing regulations.

CONSTRUCTED WETLANDS: 12VAC5-640-370. Constructed wetlands are considered experimental and will be considered on a case by case basis by the department. All constructed wetland systems shall be designed to meet or exceed 10 mg/l BOD5 and 10 mg/l suspended solids. Experimental systems are exactly that: experimental. Only the results of testing will determine if they will become an approved method of treating wastewater. Some systems can solve site and soil problems that a conventional septic system cannot handle; however, no system can overcome all of the problems on some difficult sites. The Division is looking to find safe, sanitary and economical solutions for every site but some problems still lack a viable solution. In short, not every site "percs" and many, if not all, alternative technologies are more expensive than a conventional gravel system. The Department urges prospective buyers to get an approval letter or construction permit before buying property you wish to build on.¹⁵⁴

Washington: Department of Health, Community Environmental Health Programs LD-11, Building 2, Airdustrial Center, PO Box 47826, Olympia, WA 47826; Ph. (360) 236-4501 or 3011 (Environmental Health Programs direct line); <http://access.wa.gov/government/awlaws.asp>; Contact: Jen Haywood.

REGULATION(S): WAC 246-272; Technical Review Committee, Guidelines for Composting Toilets (1994); Recommended Standards and Guidance for Water Conserving On-Site Wastewater Treatment Systems (1999).

COMPOSTING TOILETS: I. The Technical Review Committee for On-Site Sewage Disposal, established under WAC 246-272-040, has reviewed the available literature on composting toilets. The committee has determined that composting toilets could be an approved

method of sewage treatment if use is consistent with the guidelines herein. Composting toilets are not designed to handle the total wastewater volume generated in the home. The units are usually designed to accommodate fecal and urinary wastes together with small amounts of organic kitchen wastes. The remaining wastewater originating from bathing facilities, sinks and washing machines (graywater) must therefore be collected, treated and disposed of in an approved manner. Because there generally will be additional wastewater to dispose of, composting toilets are restricted.

II. Composting toilets are any device designed to store and compost by aerobic bacterial digestion human urine and feces which are non-water carried, together with the necessary venting, piping, electrical and/or mechanical components.¹⁵⁵ Section A. Waterless Toilets/WLTs. Composting - Unit designed to store and compost (by microbial digestion) human urine and feces. These units are commonly designed to accommodate fecal and urinary wastes together with small amounts of organic material to assist their function. No water is used for transport of urine or feces within these units. They may be small enough to sit on the floor of a bathroom or large enough to require space below the floor to house the storage/composting chamber.¹⁵⁶ The units may be used to replace private privies or chemical toilets, including such applications as highway weigh stations, warehouses, port facilities, construction sites, residences, etc., may be used in dwellings where water supply is not available or provided (example: mountain cabins), or may be used in dwellings where an on-site sewage system is or can be provided for disposal of graywater. Where non-discharging blackwater treatment systems are used, a 50% reduction in septic tank volume and a 40% reduction in the daily hydraulic loading to be used in sizing the grey water disposal mechanism (drainfield, mound system, etc.) are recommended from standard design requirements. The units may be used in facilities where a public sewage system is provided for disposal of graywater.¹⁵⁷ The devices shall be capable of accommodating full or part-time usage without accumulating excess liquids when operated at the design rated capacity. Continuous forced ventilations (e.g., electric fan or wind-driven turbovent) of the storage or treatment chamber must be provided to the outside.¹⁵⁸ Components in which biological activity is intended to occur shall be insulated, heated, or otherwise protected from low temperature conditions, in order to maintain the stored wastes at temperatures conducive to aerobic biological decomposition: 20 to 50 degrees C (68 to 130 degrees F). The device shall be capable of maintaining wastes within a moisture range of 40 to 75%. The device shall be designed to prevent the deposition of inadequately treated wastes near parts used for the removal of stabilized end products. The solid end product (i.e., waste humus) shall be stabilized to meet NSF criteria when ready for removal at the clean out port.

1. Performance Standards. 1.2.1.2. Toilets of proprietary design must be tested according to the NSF International Standard No. 41 (May 1983).¹⁵⁹ The maintenance of carbon-to-nitrogen ratios of approximately 20:1 are recommended. Consequently, additions of vegetable matter, wood chips, sawdust, etc., can be helpful. Removal of composted and liquid materials shall be done in a manner approved with the local health departments and as a minimum, shall comply with Guidelines for Sludge Disposal, Washington Department of Health, 1954. Persons finding it necessary to handle this material shall take adequate protective sanitation measures, and should wash their hands carefully with soap and hot water. Compost shall not be used directly on root crops or on low-growing vegetables, fruits or berries which are used for human consumption; however, this general restriction does not apply if stabilized compost is applied 12 months prior to planting. Where it can be shown that sludge will not come in direct contact with the food products, such as in orchards or where stabilized sludges are further treated for sterilization or pathogen reduction, less restrictive periods may be applicable. Performance monitoring shall be performed on composting toilets permitted under this guideline. Permits should include a statement indicating the permitter's right of entry and/or right to inspect. The frequency of monitoring shall be: 1) Two years after installation; 2) Four years after installation; and 3) in response to a complaint or problem. Non-water carried sewage treatment units are presently acknowledged to be a method of sewage disposal under the Uniform Plumbing Code, but variances to use the devices might be required by local administrative authorities. Variances must therefore be obtained from these departments together with approval of the local health department before the installation can be allowed. The Revised Code of Washington (RCW) 70.118 gives local boards of health the authority to waive applicable sections of local building/plumbing codes when they might prohibit the use of an alternative method for correcting a failure.¹⁶⁰

GRAYWATER: Section B. Graywater systems are virtually the same as combined-wastewater on-site sewage systems. Gravity flow graywater systems consist of a septic tank and subsurface drainfield. Pressurized graywater systems consist of a septic tank, a pump chamber or vault, and a subsurface drainfield. Other types of alternative systems, pre-treatment methods and drainfield design and materials options may also be incorporated in graywater systems. The primary distinction between a graywater system and a combined wastewater system is the lower volume of wastewater. As a result, the size of the septic tank and subsurface drainfield is smaller compared to a system that treats and disposes all the household wastewater (combined) through a septic tank and drainfield. In addition to the water conserving nature of waterless toilets/graywater systems, the graywater system drainfield can be designed and located to reuse graywater for subsurface irrigation. Drainfield designs (methods and materials) which place the distributed wastewater in close proximity to the root zone of turf grasses, plants, shrubs, and trees may be used to enhance the reuse potential of graywater as it is treated in the soil, assuring public health protection. When graywater systems are designed, installed, operated and maintained to maximize their potential as a graywater reuse irrigation system, various items should be considered. Among these are plant water and nutrient needs and limits, salt tolerances, depths of root zones, etc. The development of a landscape plan is recommended. Graywater treatment and disposal/reuse systems must provide treatment and disposal at least equal to that provided by on-site system. Graywater on-site systems may be used with new residential construction and existing dwellings. Internal household plumbing may be modified (consistent with local plumbing code) to route any portion of the household graywater to the graywater on-site sewage system. Graywater on-site sewage systems may be located anywhere conventional or alternative on-site sewage systems are allowed. Site conditions, vertical separation, pretreatment requirements, setbacks and other location requirements are the same as described in Chapter 246-272 WAC. 2.4 Graywater on-sites sewage systems must provide permanent, year-round treatment and disposal of graywater unless this is already provided by an approved

on-site system or connection to public sewer. Graywater on-site systems must be installed with an approved waterless toilet or other means of sewage treatment for blackwater approved by the local health officer. Graywater systems are intended to treat and dispose “residential strength” graywater. Graywater exceeding residential strength must receive pre-treatment to at least residential strength levels. Design requirements for graywater on-site sewage systems, unless otherwise noted, are the same as requirements for combined wastewater systems presented in Chapter WAC 246-272. Graywater may be used for subsurface irrigation of trees (including fruit trees) shrubs, flowers, lawns and other ground covers but must not be used for watering of food crops of vegetable gardens, any type of surface or spray irrigation, to flush toilets/urinals or to wash wall, sidewalks or driveways. The disposal component of a graywater treatment system may be designed to enhance the potential for subsurface irrigation. The efficiency of graywater reuse via subsurface irrigation depends upon the proximity of the drainfield to the root-zone of plants, shrubs, trees or turf and the method of distribution. This may be enhanced by: Installing narrower-than-normal trenches shallow in the soil profile (state rules do not have a minimum trench width; minimum trench depth is six inches). Gravel and pipe size may limit how narrow a “conventional” trench may be. It is recommended that at least two inches of gravel be provided between the sides of the distribution pipe and trench sidewalls. Small gravel size (no less than 3/4 inch) is recommended for narrow trenches; using pressure distribution to reduce the height of the trench cross section to enable shallow trench placement and to assure even distribution; and using subsurface drip irrigation (SDS) technology for shallow system placement and equal distribution in close proximity to plant, shrub, turf and trees roots. Some agronomic issues that should be considered with graywater reuse are the water needs and salt tolerances of plants to be irrigated. In many cases, the volume of graywater generated may not meet the needs of the landscape plantings. If potable water is used to augment graywater for irrigation within the same distribution network, a method of backflow prevention approved by the local health officer is required. In some geographical and climatic areas, the frost-protection needs of an SDS or a conventional drainfield trench system may be counter-productive to effective graywater reuse via subsurface irrigation (distribution piping may be too deep for plant root systems). In these areas, local health officers may permit seasonal systems where year-round treatment and disposal is provided by an approved sewage system and seasonal subsurface irrigation with graywater is provided by a separate system with a shallow drainfield or SDS. Where seasonal systems are allowed, various administrative and design issues must be addressed. Both drainfields must meet state and local rule requirements, including soil application rates, to assure treatment and disposal at least equal to that provided by conventional gravity or pressure on-site sewage systems according to Chapter 246-272 WAC. 3.4.2 Municipal sewer systems may provide year-round sewage disposal in conjunction with seasonal graywater treatment and disposal systems designed to enhance graywater reuse via subsurface irrigation. Seasonal graywater treatment and disposal/reuse systems must include a three-way diverter valve to easily divert graywater to the year-round disposal field or sewer when needed (when freezing is a problem). Local health officers may permit “laundry wastewater only” graywater disposal or reuse systems for single family residences for either year-round or seasonal use. Graywater systems limited only to laundry wastewater (including laundry sinks) may differ from other graywater systems according to the following: A single compartment retention/pump tank, with a minimum liquid capacity of 40 gallons may be used in lieu of the tank recommendations. The tank must be warranted by the manufacturer for use with wastewater and meet requirements listed in Appendix G of the 1997 edition of the Uniform Plumbing Code (UPC). Minimum design flow for “laundry wastewater only” systems (for the purpose of drainfield sizing) must be based on the number of bedrooms in the residence and must be no less than 30% of the minimum graywater system design flows. A wastewater filter or screen (with a maximum size opening of 1/16 inch) must be provided in an accessible location conducive to routine maintenance. Homeowners are responsible for proper operation and maintenance of their graywater systems. Specific requirements will vary according to the county where the system is located and the specific type of system. See your local health jurisdiction for local system O & M requirements.¹⁶¹

CONSTRUCTED WETLANDS: No existing regulations.

West Virginia: Secretary of State, Administrative Law Division, State Capitol, 1900 Kanawha Boulevard East, Building 1, Suite 157K, Charleston, WV 25305-0770; Ph. (304) 558-6000; FAX (304) 558-0900; <http://www.state.wv.us/sos>; Email: WVSOS@Secretary.State.WV.US; Contact: Leah Powell.

REGULATION(S): Title 64, Interpretive Rules Board of Health, Series 47, Sewage Treatment and Collection System Design Standards (1983).

COMPOSTING TOILETS: Interpretive Rule 16-1, Series VII, 10.1. Composting toilets may be utilized only in conjunction with an approved graywater treatment and disposal system. 10.2 The design and construction of a composting toilet must meet the requirements of NSF Standard 41.

GRAYWATER: 12.1 Those houses served by a graywater disposal system must have a house sewer of not more than two inches in diameter. 12.2. Houses served by graywater disposal systems shall not have garbage disposal units. 12.3 Manufactured graywater disposal systems must be approved by the director. 12.4. Non-commercial graywater disposal systems shall consist of the following: 12.4.1. A soil absorption field designed on the basis of a 30% reduction in water usage, and constructed in accordance with the design requirements for the standard soil absorption fields. 12.4.2. A septic tank sized according to the following room sizes and minimum capacities: 2 rooms, 500 gallons; 3 to 4 rooms, 750 gallons; 5 or more rooms, add 210 gallons for each additional bedroom.¹⁶²

CONSTRUCTED WETLANDS: No existing regulations.

Wisconsin: Department of Commerce, Bureau of Program Management, 715 Post Road, Stevens Point, WI 54481-6456; Ph. (715) 345-

5334; FAX (715) 345-5269; <http://www.commerce.state.wi.us/sb-comm83revisionsandarticles.htm>;
<http://www.legis.state.wi.us/rsb/code/comm/comm083.pdf>; Contact: Jim Klass, Ph. (608) 266-9292 (Water Regulation).

REGULATION(S): If they existed, they may be found in Wisconsin Comm083.

COMPOSTING TOILETS, GRAYWATER SYSTEMS, CONSTRUCTED WETLANDS: No existing regulations.

Wyoming: Department of Environmental Quality, Water Quality Division, Herschler Building, 122 West 25th Street, Cheyenne, WY 82002; Ph. (307) 777-7075; <http://deq.state.wy.us/wqd/w&wwpage.htm>; Contact: Larry Robinson; <mailto:lharmo@missc.state.wy.us>

REGULATION(S): If they existed, regulations would most likely be found in Chapter XI, Part D, Septic Tank and/or Soil Absorption System, Water Quality Rules and Regulations in the Innovative and Alternative section.

COMPOSTING TOILETS, GRAYWATER SYSTEMS, CONSTRUCTED WETLANDS: No existing regulations.

Canada: Systems would be governed by the provincial Ministries of Health (municipal affairs and health, similar to our county government in the US). Check your local agency.

Other information sources: National Small Flows Clearinghouse: West Virginia University, PO Box 6064, Morgantown, WV 26506-6064; Ph. (304) 294-4191; 1-800-624-8301; National Sanitation Foundation: NSF Standard 41: Nonliquid Saturated Treatment Systems: <http://www.nsf.org/>

ENDNOTES (Appendix 3)

1. Memorandum from James M. Coles, Deputy Director. Division of Community Environmental Protection, State of Alabama Department of Public Health. 7 December 1998.
2. Alabama State Board of Health. 7 December 1998. Rules of State Board of Health Bureau of Environmental Services Division of Community Environmental Protection. Chapter 420-3-1, Onsite Sewage Disposal. Draft. p. 126.
3. Alabama State Board of Health, Bureau of Environmental Services, Division of Community Environmental Protection. 23 December 1998. Rules of State Board of Health Bureau of Environmental Services Division of Community Environmental Protection. Chapter 420-3-1, Onsite Sewage Disposal and Subdivision-Onsite Sewage Systems, Water Supplies and Solid Waste Management. p. 6.
4. Alabama State Board of Health. 7 December 1998. Rules of State Board of Health Bureau of Environmental Services Division of Community Environmental Protection. Chapter 420-3-1, Onsite Sewage Disposal. Draft. p. 126.
5. Arizona Department of Environmental Quality (ADEQ). Bulletin No. 12: Minimum Requirements for the Design and Installation of Septic Tank Systems and Alternative On-site Disposal Systems. June 1989. p. 65.
6. Ibid. p. 65-66.
7. Arizona Administrative Code. Department of Environmental Quality, Water Pollution Control. Article 7. Regulations for the Reuse of Wastewater. p. 14, 15, 17.
8. Knight, R. L, Randall, R. and M. Girts. May 1995. Arizona Guidance Manual for Constructed Wetlands for Water Quality Improvement. Arizona Department of Environmental Quality. p. 8-14.
9. Arizona Department of Environmental Quality. June 1989. Engineering Bulletin No. 12: Minimum Requirements for the Design and Installation of Septic Tank Systems and Alternative On-Site Disposal Systems. p.64.
10. Ibid.
11. Ibid. p. 65.
12. Environmental Program Services, Division of Environmental Health Protection. April 1993. Alternate Systems Manual. Arkansas Department of Health. p. 1.
13. Ibid.
14. Ibid. p. 18.

15. Carl J. Graves, R.S., Sanitarian, Arkansas Department of Health. Personal communication. 25 February 1999. 12. Environmental Program Services, Division of Environmental Health Protection. April 1993. Alternate Systems Manual. Arkansas Department of Health. p. 18.
16. Ibid. p. 18.
17. Ibid.
18. Ibid. p. 13-16
19. Ibid. p. 13-16
20. State of California. Building Standards Commission. 28 September 1997. Appendix G. Graywater Systems. Uniform Plumbing Code (UPC). Title 24, Part 5, California Administrative Code. p. 79-85.
21. Colorado Department of Health. 1994. Guidelines on Individual Sewage Disposal Systems. p. 6.
22. Colorado Department of Health. 1994. Guidelines on Individual Sewage Disposal Systems. p. 46.
23. Ibid. p. 47.
24. Ibid. p. 7.
25. Ibid. p. 44.
26. Ibid. p. 6.
27. Ibid. p. 43.
28. Connecticut Public Health Code. Regulations and Technical Standards for Subsurface Sewage Disposal Systems. Section 19-13-B100, Section 19-13-B103, Technical Standards, Section 19-13-B104. January 1997. p. 12.
29. Ibid. p. 42-43.
30. Ibid. p. 7.
31. Ibid. p. 12.
32. State of Delaware, Department of Natural Resources and Environmental Control. 31 January 1995. Regulations Governing the Design, Installation and Operation of On-Site Wastewater Treatment and Disposal Systems. Forward.
33. David Hammonds, Florida Bureau of Water and Onsite Sewage Programs. Personal conversation. 25 February 1999.
34. State of Florida, Department of Health. 3 March 1998. Chapter 64E-6, Florida Administrative Code, Standards for On-Site Sewage Treatment and Disposal Systems. p. 20.
35. Ibid. p. 22.
36. http://www.leg.state.fl.us/citizen/documents/statutes/1998/ch0381/sec0065_.htm 5 April 1999. p. 1.
37. State of Florida, Department of Health. 3 March 1998. Chapter 64E-6, Florida Administrative Code, Standards for On-Site Sewage Treatment and Disposal Systems. p. 31.
38. Florida Administrative Code. 13 February 1997. Standards for On-Site Sewage Treatment and Disposal Systems, Chapter 10D-6.
39. National Small Flows Clearinghouse. 1997. Graywater Systems from the State Regulations. WWBLRG24. p. 19, 20, 23-24.
40. David Hammonds, Florida Bureau of Water and Onsite Sewage Programs. Personal conversation. 25 February 1999.

41. State of Georgia. 20 February 1998. Chapter 290-5-59. Special Onsite Sewage Management Systems. p. D-18.
42. State of Georgia. 20 February 1998 Chapter 290-5-59. Special Onsite Sewage Management Systems. p. 2.
43. Ibid. p. D-19.
44. Corbitt, Bill. 16 July 1997. Aquatic Sewage Treatment Systems in Georgia, Past and Present. Georgia Environmentalist. Georgia Environmental Health Association. p. 8-14.
45. Hawaii Department of Health. 30 August 1991. Amendment and Compilation of Chapter 11-62. p. 62-4.
46. Ibid. p. 62-5.
47. Ibid. p. 62-24.
48. Ibid. p. 62-26.
49. Ibid. p. 62-23.
50. National Small Flows Clearinghouse. 1997. Graywater Systems from the State Regulations. WWBLRG24. p. 25.
51. Hawaii Department of Health. 30 August 1991. Amendment and Compilation of Chapter 11-62. p. 62-23.
52. Ibid. p. 62-26.
53. State of Idaho. 993. IDAPA 16. Title 01, Chapter 03. Rules for Individual/Subsurface Sewage Disposal Systems. p. 16-8.
54. Idaho Division of Environmental Quality. 8 January 1999. Technical Guidance Manual for Individual Subsurface Sewage Disposal Systems. p. 33.
55. Barry Burnell, Idaho Division of Environmental Quality. Personal communication. 8 January 1999.
56. Ibid.
57. Idaho Division of Environmental Quality. 25 October 1996. Technical Guidance Manual for Individual Subsurface Sewage Disposal Systems. p. 1-4.
58. Barry Burnell, Idaho Division of Environmental Quality. Personal communication. 8 January 1999.
59. Illinois Department of Public Health. 1996. Private Sewage Disposal Licensing Act and Code. p. 54.
60. Ibid. p. 63.
61. Ibid. p. 56.
62. Tim Decker, Indiana State Department of Health. Personal communication. 30 April 1999.
63. Iowa Chapter 69: On-Site Wastewater Treatment and Disposal Systems. 567--69.11(455B) Constructed wetlands section.
64. Kansas Administrative Regulations. 1 January 1973. Chapter 25-5-9. Variance. p. 126.
65. State of Kansas Department of Health and Environment. March 1997. Bulletin 4-2: Minimum Standards for Design and Construction of Onsite Wastewater Systems. p. 1.
66. Kentucky Cabinet for Human Resources. September 1989. On-Site Sewage Disposal Systems Regulations. 902 KAR 10:081 and 902 KAR 10:085. p. 25.
67. Ibid. p. 58-59.
68. Ibid. p. 48.

69. Department for Public Health. August 1997. Kentucky Public Health Homeowner's Manual. Onsite Sewage Disposal Systems. p. 29
70. Teda Boudreaux. Louisiana Department of Health. Personal communication 3 May 1999.
71. Department of Human Services. 20 January 1998. Maine Subsurface Waste Water Disposal Rules. 144A CMR 214. p. 15-1, 15-2.
72. Ibid. p. 15-3.
73. Jay Prager, Acting Chief, Division of Residential Sanitation, Maryland Department of the Environment. 26 October 1990. Innovative/Alternative Section. Memorandum: Guidance on Waterless Toilet Systems. p. 1.
74. Ibid. p. 2.
75. Commonwealth of Massachusetts. Executive Office of Environmental Affairs. Department of Environmental Protection. 4 March 1998. 310 CMR 15.000: Title 5: Innovative and Alternative Subsurface Sewage Disposal Technologies Approved for Use in Massachusetts. p.1,9. Commonwealth of Massachusetts. Executive Office of Environmental Affairs. Department of Environmental Protection. 16 April 1998. The Use of Composting Toilets in Massachusetts. p. 1-4.
76. Ibid. p. 4.
77. Ruth Alfasso, Graywater Piloting Coordinator, Massachusetts DEP. Personal communication. 6 January 1999.
78. Ibid.
79. Rick Fallardeau, Michigan Department of Environmental Quality. Personal communication. April 1999.
80. Michigan Department of Public Health. July 1986. Guidelines for Acceptable Innovative or Alternative Waste Treatment Systems and Acceptable Graywater Systems. p. 1.
81. Ibid. Attachment A. Act No. 421. Public Acts of 1980. Approved by Governor. 13 January 1981. p. 1.
82. Ibid. p. 2.
83. Michigan Department of Public Health. July 1986. Guidelines for Acceptable Innovative or Alternative Waste Treatment Systems and Acceptable Graywater Systems. p. 2.
84. Ibid. p. 2.
85. Ibid. p. 3.
86. Ibid. p. 3.
87. Ibid. p. 3.
88. Ibid Attachment C. Act 230, Public Acts of 1972, as amended Michigan Construction Code. p. 1.
89. Rick Fallardeau, Michigan Department of Environmental Quality. Personal communication. April 1999.
90. McGeachy, Ben. date unknown. A Review of Subsurface Flow Constructed Wetlands Literature and Suggested Design and Construction Practices. Michigan Department of Environmental Quality.
91. Roberta Wirth, Minnesota Department of Natural Resources. Personal communication. 14 January 1999.
92. Minnesota Rules. 3 November 1998.. Chapter 7080.0910. Alternative and Experimental Systems.
93. Ibid. Section E1-E7.
94. Mississippi Individual On-Site Wastewater Disposal System Law. 1996. Chapter 41-67. MSDH 300-Section 02A-03.

95. Ibid. MSDH 300-Section 02A-XIII-01.
96. Ibid. MSDH 300-Section 02A-VII-01.
97. Missouri Department of Health. 1995. Missouri Laws Accompanied by Department of Health Rules Governing On-site Sewage Systems. Missouri Laws for On-Site Disposal Systems. p. 1.
98. Missouri Department of Health. 1995 Missouri Laws Accompanied by Department of Health Rules Governing On-site Sewage Systems. Title 19- Department of Health, Division 20-Environmental Health & Epidemiology, Chapter 3- General Sanitation. p. 37.
99. Ibid. p. 9.
100. Ibid. p. 34.
101. Montana Department of Health and Environmental Sciences. Circular WQB 5. Minimum Design Standards for On-Site Alternative Sewage Treatment and Disposal Systems. p. 4.
102. Ibid. p. 5
103. Nevada Adopted Regulation R 129-98. February 1998. p. 59-61.
104. <http://www.state.nh.us/gencourt/ols/rules/env-ws.htm>
105. <http://www.state.nj.us/dep/dwq/rules.htm> p. 11.
106. Ibid. p. 6-7.
107. Ibid. p. 65, 68-69.
108. Ibid. p. 6.
109. Ibid. p. 25.
110. Brian Schall, New Mexico Environment Department. Personal communication. 1999.
111. Ibid.
112. Ibid.
113. New Mexico Environmental Improvement Board. October 1997. Liquid Waste Disposal Regulations. p. 6.
114. New Mexico Environmental Improvement Board. October 1997. Liquid Waste Disposal Regulations. p 38.
115. New York State Department of Health. 1996. Individual Residential Wastewater Treatment Systems Design Handbook.
116. Ibid. p. 56.
117. Ibid.
118. Ibid. p. 56-57.
119. State of New York. 1 December 1990. Appendix 75-A. Wastewater Treatment Standards - Individual Household Systems. Statutory Authority,; Public Health Law, 201(1)(1), New York. p. 31.
120. Ibid.
121. Ibid. p. 14.

122. Ben Pierson, New York State Department of Health. Personal communication. 6 April 1999.
123. National Small Flows Clearinghouse. September 1997. Alternative Toilets from the State Regulations. WWBKRG23. p. 53-54.
124. Joni Cardin, North Carolina Division of Water Quality. Personal communication. 7 January 1999.
125. State of North Dakota. 1996. Chapter 62-03-16. Individual Sewage Treatment Systems for Homes and Other Establishments Where Public Sewage Systems are not Available. p. 249.
126. Ibid.
127. Ohio Department of Health. 1 July 1977. Chapter 3701-29-01 to 3701-29-21. Household Sewage Disposal Rules. p. 21.
128. Oklahoma Chapter 640, Individual and Small Public Sewage Disposal. 1998. p. 12-13.
129. Oregon Chapter 447.115. 1997. <http://landru.leg.state.or.us/ors/447.htm> 21 January 1999.
130. Oregon Chapter 918-790-0010. 1998. http://arcweb.sos.state.or.us/rules/OARS_900/OAR_918/918_770.htm
131. Oregon Chapter 918-770-0050. 1998. Plumbing Product Approval. http://arcweb.sos.state.or.us/rules/OARS_900/OAR_918/918_770.htm
132. Oregon Chapter 447.115. 1997. <http://landru.leg.state.or.us/ors/447.htm> 21 January 1999.
133. National Small Flows Clearinghouse. September 1997. Greywater Systems from the State Regulations. p. 36.
134. Ibid. p. 37.
135. Terry Swisher, Oregon Chief Plumbing Inspector. Personal communication. 14 January 1999.
136. Commonwealth of Pennsylvania. 17 January 1998. Pennsylvania Code. Title 25. Environmental Protection. p. 73-6.
137. Ibid. p. 73-47 - 73-48.
138. Ibid. p. 73-10.
139. Ibid. p. 73-48 to 73-49.
140. Rhode Island. September 1998. Chapter 12-120-002, Individual Sewage Disposal Systems. p. 40-42.
141. Ibid.
142. Ibid. p. 43-46.
143. Richard Hatfield, South Carolina Onsite Wastewater Management Branch. Personal communication. 7 January 1999.
144. <http://landru.leg.state.or.us/ors/447.htm> 7 January 1999.
145. National Small Flows Clearinghouse. September 1997. Greywater Systems from the State Regulations. p. 39-41.
146. Tennessee Rules of Department of Environment and Conservation, Division of Ground Water Protection. 1997. Chapter 1200-1-6: Regulations to Govern Subsurface Sewage Disposal Systems. p. 59.
147. Texas Natural Resource Conservation Commission. 8 January 1999. Chapter 285, On-Site Sewage Facilities. p. 2, 19.
148. Ibid. p. 1, 3.
149. Ken Graber, Texas Natural Resource Conservation Commission. Personal communication. 4 April 1999.

150. Ibid.
151. <http://www.eq.state.ut.us/eqwq/wqrules.htm> 6 January 1999.
152. Bonnie Loomer-Hostetler, Information Services Chief of the Vermont Wastewater Management Division. Personal communication. 7 January 1999.
153. John Akielaszek, Vermont Department of Environmental Conservation. Personal communication. 12 January 1999.
154. <http://www.vdh.state.va.us/onsite/text/appr-sys.htm>
155. Technical Review Committee. June 1994. Guidelines for Composting Toilets. Washington State Department of Health. p. 2.
156. Water Conserving On-Site Wastewater Treatment Systems. 5 April 1999. Washington State Department of Health. p. 3.
157. Technical Review Committee. June 1994. Guidelines for Composting Toilets. Washington State Department of Health. p. 1.
158. Water Conserving On-Site Wastewater Treatment Systems. 5 April 1999. Washington State Department of Health. p. 2.
159. Ibid. p. 4.
160. Technical Review Committee. June 1994. Guidelines for Composting Toilets. Washington State Department of Health. p. 3, 4, 5.
161. Technical Review Committee. June 1994. Guidelines for Composting Toilets. Washington State Department of Health. p. 19, 20, 22, 23.
162. West Virginia Board of Health. 1983. Interpretive Rule 16-1. Series VII. Part V. Sec. 10.0. p. 135.

*Source: The Humanure Handbook. Jenkins Publishing, PO Box 607, Grove City, PA 16127. To order, phone: 1-800-639-4099.
<http://www.jenkinspublishing.com/>*

MENU: [HOME](#) » [Reconstruction](#) » [Recovery](#) » [Renewal](#) » [Survival](#) » [Humanure Content](#)

Humanure Glossary:

actinomycete

Bacteria resembling fungi because they usually produce a characteristic, branched mycelium.

activated sludge

Sewage sludge that is treated by forcing air through it in order to activate the beneficial microbial populations resident in the sludge.

aerobic

Able to live, grow, or take place only where free oxygen is present, such as aerobic bacteria.

algae

Small aquatic plants.

ambient air temperature

The temperature of the surrounding air, such as the outdoor air temperature in the vicinity of a compost pile.

amendment

See “bulking agent.”

anaerobic

Able to live and grow where there is no oxygen.

Ascaris

A genus of roundworm parasitic to humans.

Aspergillus fumigatus

A spore-forming fungus that can cause allergic reactions in some people.

bacteria

One-celled microscopic organisms. Some are capable of causing disease in humans, others are capable of elevating the temperature of a pile of decomposing refuse sufficiently to destroy human pathogens.

biochemical oxygen demand (BOD)

The amount of oxygen used when organic matter undergoes decomposition by microorganisms. Testing for BOD is done to assess the amount of organic matter in water.

blackwater

Wastewater from a toilet.

bulking agent

An ingredient in compost, such as sawdust or straw, used to improve the structure, porosity, liquid absorption, odor, and carbon content. The terms “bulking agent” and “amendment” are often interchangeable.

carbonaceous

Consisting of or containing carbon.

carbon dioxide (CO₂)

An inorganic gas composed of carbon and oxygen produced during composting.

cellulose

The principal component of cell walls of plants, composed of a long chain of tightly bound sugar molecules.

C/N ratio

The ratio of carbon to nitrogen in an organic material.

combined sewers

Sewers that collect both sewage and rain water runoff.

compost

A mixture of decomposing vegetable refuse, manure, etc., for fertilizing and conditioning soil.

continuous composting

A system of composting in which organic refuse material is continuously or daily added to the compost bin or pit.

cryptosporidia

A pathogenic protozoa which causes diarrhea in humans.

curing

Final stage of composting. Also called aging, or maturing.

effluent

Wastewater flowing from a source.

enteric

Intestinal

evapotranspiration

The transfer of water from the soil into the atmosphere both by evaporation and by transpiration of the plants growing on the soil.

fecal coliforms

Generally harmless bacteria that are commonly found in the intestines of warm-blooded animals, used as an indicator of fecal contamination.

fecophobia

Fear of fecal material, especially in regard to the use of human fecal material for agricultural purposes.

fungi

Simple plants, often microscopic, that lack photosynthetic pigment.

graywater

Household drain water from sinks, tubs, and washing (not from toilets).

green manure

Vegetation grown to be used as fertilizer for the soil, either by direct application of the vegetation to the soil, by composting it before soil application, or by the leguminous fixing of nitrogen in the root nodules of the vegetation.

heavy metal

Metals such as lead, mercury, cadmium, etc., having more than five times the weight of water. When concentrated in the environment, can pose a significant health risk to humans.

helminth

A worm or worm-like animal, especially parasitic worms of the human digestive system, such as the roundworm or hookworm.

human nutrient cycle

The endlessly repeating cyclical movement of nutrients from soil to plants and animals, to humans, and back to soil.

humanure

Human feces and urine used for agriculture purposes.

humus

A dark, loamy, organic material resulting from the decay of plant and animal refuse.

hygiene

Sanitary practices, cleanliness.

indicator pathogen

A pathogen whose occurrence serves as evidence that certain environmental conditions, such as pollution, exist.

K

Chemical symbol for potassium.

latrine

A toilet, often for the use of a large number of people.

leachate

Any liquid draining from a source. Pertaining to compost, it is the liquid that drains from organic material, especially when rain water comes in contact with the compost.

lignin

A substance that forms the woody cell walls of plants and the “cement” between them. Lignin is found together with cellulose and is resistant to biological decomposition.

macroorganism

An organism which, unlike a microorganism, can be seen by the naked eye, such as an earthworm.

mesophile

Microorganisms which thrive at medium temperatures (20-37°C or 68-99°F).

metric tonne

A measure of weight equal to 1,000 kilograms or 2,204.62 pounds.

microhusbandry

The cultivation of microscopic organisms for the purpose of benefiting humanity, such as in the production of fermented foods, or in the decomposition of organic refuse materials.

microorganism

An organism that needs to be magnified in order to be seen by the human eye.

moulder (also molder)

To slowly decay, generally at temperatures below that of the human body.

mulch

Organic material, such as leaves or straw, spread on the ground around plants to hold in moisture, smother weeds, and feed the soil.

municipal solid waste (MSW)

Solid waste originating from homes, industries, businesses, demolition, land clearing, and

construction.

mycelium

Fungus filaments or hyphae.

N

Chemical symbol for nitrogen.

naturalchemy

The transformation of seemingly valueless materials into materials of high value using only natural processes, such as the conversion of humanure into humus by means of microbial activity.

night soil

Human excrement used raw as a soil fertilizer.

nitrates

A salt or ester of nitric acid, such as potassium nitrate or sodium nitrate, both used as fertilizers, and which show up in water supplies as pollution.

organic

Referring to a material from an animal or vegetable source, such as refuse in the form of manure or food scraps; also a form of agriculture which employs fertilizers and soil conditioners that are primarily derived from animal or vegetable sources as opposed to mineral or petrochemical sources.

P

Chemical symbol for phosphorous.

pathogen

A disease-causing microorganism.

PCB

Polychlorinated biphenyl, a persistent and pervasive environmental contaminant.

peat moss

Organic matter that is under-decomposed or slightly decomposed originating under conditions of excessive moisture such as in a bog.

pH

A symbol for the degree of acidity or alkalinity in a solution, ranging in value from 1 to 14. Below 7 is acidic, above 7 is alkaline, 7 is neutral.

phytotoxic

Toxic to plants.

pit latrine

A hole or pit into which human excrement is deposited. Known as an outhouse or privy when sheltered by a small building.

protozoa

Tiny, mostly microscopic animals each consisting of a single cell or a group of more or less identical cells, and living primarily in water. Some are human pathogens.

psychrophile

Microorganism which thrives at low temperatures [as low as -10oC (14oF), but optimally above 20oC (68oF)].

schistosome

Any genus of flukes that live as parasites in the blood vessels of mammals, including humans.

septage

The organic material pumped from septic tanks.

septic

Causing or resulting from putrefaction (foul-smelling decomposition).

shigella

Rod-shaped bacteria, certain species of which cause dysentery.

sludge

The heavy sediment in a sewage or septic tank.

source separation

The separation of discarded material by specific material type at the point of generation.

sustainable

Able to be continued indefinitely without a significant negative impact on the environment or its inhabitants.

thermophilic

Characterized by having an affinity for high temperatures (above 40.50C or 1050F), or for being able to generate high temperatures.

tipping fee

The fee charged to dispose of refuse material.

vector

A route of transmission of pathogens from a source to a victim. Vectors can be insects, birds, dogs, rodents, or vermin.

vermicomposting

The conversion of organic material into worm castings by earthworms.

vermin

Objectionable pests, usually of a small size, such as flies, mice, and rats, etc..

virus

Any group of submicroscopic pathogens which multiply only in connection with living cells.

waste

A substance or material with no inherent value or usefulness, or a substance or material discarded despite its inherent value or usefulness.

wastewater

Water discarded as waste, often polluted with human excrements or other human pollutants, and discharged into any of various wastewater treatment systems, if not directly into the environment.

Western

Of or pertaining to the Western hemisphere (which includes North and South America and Europe) or its human inhabitants.

windrow

A long, low, narrow pile, such as of compost.

worm castings

Earthworm excrement. Worm castings appear dark and granular like soil, and are rich in soil nutrients.

yard material

Leaves, grass clippings, garden materials, hedge clippings, and brush.

Source: *The Humanure Handbook*. Jenkins Publishing, PO Box 607, Grove City, PA 16127. To order, phone: 1-800-639-4099.

<http://www.jenkinspublishing.com/>

MENU: [HOME](#) » [Reconstruction](#) » [Recovery](#) » [Renewal](#) » [Survival](#) » [Humanure Content](#)

Bruce Beach

Greetings, my name is Bruce Beach and I am adding this page so that anyone desiring to do so may get to know me more personally. I am the coordinator, founder and initial vision holder of the [World Language Process](#). I am a former professor of computer science and have been a student of the world language problem for over thirty years.



I now live in a little village of 200 people, called Horning's Mills, that is about 90 miles northwest of Toronto, Ontario, Canada. My wife was born in this village (and her mother also, in the 19th century). We have many relations that live in the village and I have a son and daughter and grandchildren nearby.



I was born in Winfield, Kansas and raised mostly in Wellington, Kansas where a number of my offspring (children, grandchildren, and great grandchild) still live. I moved to Canada in 1970 to teach in the Northern College System (in Sault Ste. Marie, Kirkland Lake and Kapuskasing) after having previously taught in black colleges in the U.S. (Morgan State and Jarvis Christian College in Hawkins Texas).

Years ago I spent a year in the Arctic as a control tower operator, courtesy of the U.S. Air Force. I have made a couple of trips to China and have travelled somewhat extensively in South America and less so to Europe and elsewhere. I have a total of over 20 children, grandchildren, and a great grandchild, several of which live in Taiwan and the rest in the U.S. and Canada. Below is a picture of myself with some of my grandchildren.



At one time I owned a very large research ship called **Canada's Tomorrow** and one third of the company that built the robotic arm that recovered the space shuttle Challenger. One of the company's robotic arms is in the Smithsonian. I have also written a number of books in the computer sciences, the latest being on the programming language 'C'.



My strongest interests, outside of the [World Language Process](#), lie in the areas

of religion, astronomy and the social sciences. I have no musical or sports talents but was once upon a time an exceptional speed reader, reading as many as five books a day. Now I read only about that many a month. I used to play a little [chess](#) and hold patents on a chess teaching machine that was manufactured some years ago and sold in several countries.

I am somewhat notorious as a survivalist having built two dozen [shelters](#) for myself and others, and I have consulted on many dozens more. I maintain a web page on this subject also, and you can click on the link in the unlikely case that this is something that interests you.

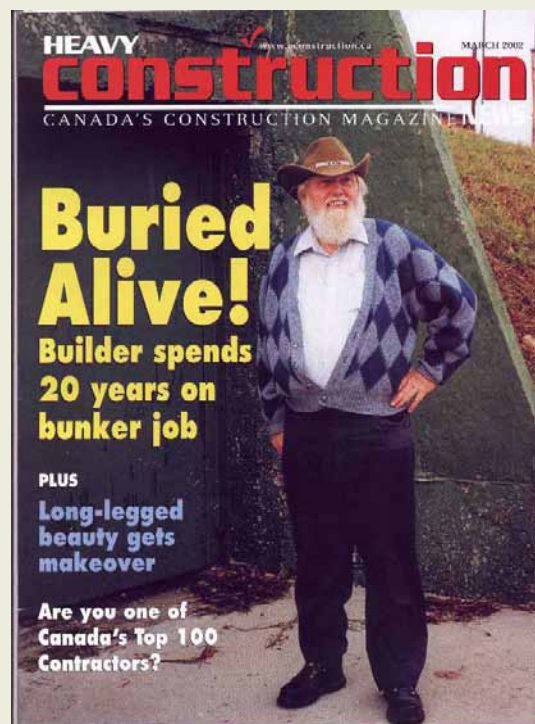

I am an optimist about the long term future of mankind but a pessimist about the immediate future, particularly at this millennialist point. As I have said, I am greatly interested in religion, being a class taught student of Christian Science and a persistent student of the writings of Emannuel Swedenborg for almost forty years. At one time I termed myself a Zen Buddhist and have read many translations of both the Bhagavad Gita and the Koran. I have also thoroughly studied the Mormon religion (I did some practice teaching at BYU) and the Jehovah's Witness religion. I truly appreciate them all and have been a Baha'i for thirty-five years. You can link to my [essays](#) if you are interested to know where

my understanding of the Baha'i Writings has led me. I met my wife at the Baha'i Temple in Wilmette, Illinois which is just outside Chicago. She was guiding at the front door.





My reading interest, in addition to Swedenborg, Computer Magazines, Sky and Telescope and the Bulletin of the Atomic Scientists, is completely eclectic. My favorite books of all time, aside from religious books, have been "Zen and the Art of Motorcycle Maintenance", "The Flatland", "Godel, Escher and Bach", "Varieties of Religious Experience", and many works by J.S. Mills. I have also in the past read gobs in psychology and economics (having a master's degree in the latter). There are times in my life when I have been a science fiction and movie hound but my greatest pleasure now is my children and grandchildren.

This should be about enough to bore you about any one person. I lead a very active life working fourteen to sixteen hours a day. A stroke some years ago blinded me in one eye but I have since reprogrammed myself to type on a Dvorak keyboard. I have loving children who look after me and a wife that everyone,

including myself, says is a saint. I am truly a happy and joyful person, a claim that I wish that more people could make in this technologically illustrious and spiritually dark age.

I can be reached personally at:

language@webpal.org

My hope, of course, is that we can find a mutual interest in furthering the

[World Language Process,](#)

which you can click on and link to if you have come to this page by a different path.

Regards,

Bruce M. Beach



MENU: [HOME](#) » [Reconstruction](#) » [Recovery](#) » [Renewal](#) » [Survival](#)

Fallout and Radiation in Food after a Nuclear War

bruce@webpal.org

[Bruce M. Beach, bio](#)

Click here to return to the
[Social and Economic Recovery
After Nuclear Holocaust](#)

Table of Contents:

[Overview: Layman's overview on Radiation in Food.](#)

A non-technical overview of how radiation gets into food. The effect that it has and what can be done about it.

[Food: Shorter letter on radiation in Food](#)

This was in response to a study that I commissioned. The full report is the next item.

[Radiation in Food: Explanation by a microbiologist](#)

This is the full report by the microbiologist, Aina Shapley. It covers the measurement of radioactivity in food and WATER. [There is also a copy of this available in .pdf](#)
(for which you need a pdf reader)

[Risk: Radiation Risk and Ethics](#)

There was much scare talk about the effects of peace time radiation. This professional paper gives a much different view. It helps to get things into perspective.

[Measurement: Manual of food quality control - radionuclides in food](#)

This .pdf document is the prime authoritative document on the subject. I obtained the information through its author Edmond J. Baratta, International Expert on Radioactivity with the US Food and Drug Administration at the research facility in Winchester, Massachusetts. The document is published both by the FDA and FAO (Food and Agricultural Organization of the UN). 133 pages in length and both very technical and readable in its detailed description of the methodologies and processes involved. However, since it does carry a copyright, and the government charges hundreds of dollars for a copy, this file is presently sealed until after the nuclear war.

[Milk: Removal of Strontium 89 and 90 from milk](#)

How to remove radiation from milk in a processing plant. This is the 61 page masters thesis of David Gene Easterly. I have the author's personal permission to republish it here.

[Potatoes: How to remove radiation from potatoes](#)

(link not yet working)

Now, if I can find this information again.

Click here to return to the
[Social and Economic Recovery
After Nuclear Holocaust](#)

Table of Contents

**Layman's overview on Radiation in Food
(Techniques for Agriculture Recovery -
After Nuclear Holocaust)
by Bruce Beach, Radiological Scientific Officer**

[Prolog: Nature of the problem](#)

Why radiation is a problem and how it gets into food.

[Short Term: The Short Term Problem](#)

The short term problem .

[Survival: The Short Term Solutions](#)

The easy solutions for the short term problem.

Long Term: [The Long Term Problem](#)

Why there is a long term problem, and how serious it may be.

Solutions: [The long term solutions.](#)

Fourteen solutions for the long term problem.

Click here to return to the
[Radiation in Food](#)
[Table of Contents](#)

Prolog: [Nature of the Problem](#)

Radiation does not harm food. Radiation in food is very harmful. One needs to make the distinction. Without entering into the debate, about whether microwave ovens harmed food, destroyed vitamins, etc., the irradiation of food in general, and by most researchers, has not been considered as being harmful. In fact it has been found to be very beneficial, for the same reasons that we cook and preserve any food.

However, radiation *in* food is *very* harmful because it is then absorbed by the consumer. Radioactive particles give off energy. This energy weakens, destroys, or otherwise harms cells. One might picture it as little microwave ovens, inside the body, cooking it from the inside. What is cooked are the cells in the body. Just like with any burn, there may be degrees. Sometimes a cell is destroyed completely and if enough are destroyed then we become sick, weaken, or die. Other times, radiation may only damage or deform the cells. The deformed cells may multiply, causing cancer which is one of the main longterm concerns about radiation.

Radioactive particles are isotopes of minerals that the body naturally seeks and absorbs. We call them isotopes because in the nuclear chain reaction process they have obtained one or more extra electrons. In this state they are unstable and will eventually give off the electron as energy and thus return to their stable state. It is that energy which is harmful.

Radioactive isotopes give off their energy in a random fashion but at a predictable rate. That is like saying that everyone in a population will die within 100 years. This we can predict with high probability and build mortality tables to that effect although we don't know when any one individual will die. The

same is true with isotopic atoms. We know that a population of them will give off all their energy in a predictable time, although we do not know when any one atom will give off its energy.

Just as different species of animals have different average lifetimes, for example shorter for fruit flies and dogs than for people, and longer for some species of parrots and turtles than people, so also do the isotopes of different minerals have different average lifetimes. For some isotopes, indeed most, the average lifetime is very short by human lifetime standards. The isotopes last only milliseconds, or less. Gone in far less than the blink of an eye. Their energy makes up what we call the initial radiation of an atomic blast. Most other radioactive particles decay, that is to say lose their energy in a matter of minutes, hours, or days. They linger around to cause the problems that we see in fallout and are the reason that one needs a fallout shelter for a few weeks after a nuclear war. But even with the latter, most of the radiation is gone in a couple of weeks.

The length of time that it takes a quantity of a radioactive isotope to lose half of its energy is what we call its half life. This can vary from milliseconds to a great many years. As mentioned, for most isotopes it is all over in milliseconds, but the ones that we are most concerned about take decades. Let us suppose that the half life of an isotope was 50 years (there are a couple that approximate that) and that we had a sufficient quantity of it that it was giving off 100 rads. Then in 50 years the radioactive source would be giving off 50 rads. In a hundred years it would be giving off 25 rads. In a hundred and fifty years it would be giving off about 12 rads. In two hundred years it would be giving off 6 rads.

For all practical purposes that source would be depleted, that is to say giving off less than 1 rad in three hundred years. As to when it would reach zero that is sort of the old Greek problem of when the bear would get out of the cave. Starting at the back of the cave it has to go half of the distance first to get out. Then at the half-way point it has to go half of the remaining distance to get out. And then at the quarter-way point, half that distance again. And so on. Logically, (this is the problem with logic and math) we can say the bear will never get out of the cave. It is what we call an asymptotic problem.

So there may always be some residual radiation from a nuclear war. Indeed, some people have speculated that there is already residual radiation on the planet from pre-historic nuclear wars. We also get background radiation from the cosmos. So radiation is always with us. Indeed, some radiation may not be harmful. It may even be necessary. Just as arsenic is considered a deadly poison, nevertheless, without any arsenic in your body - you would equally well die. Enough water and you will drown. Not enough and you will die of dehydration. Balance in all things. Probably regarding radiation also. Experiments have shown that people who live at higher altitudes and who therefore receive more natural radiation from the sun and cosmos, have lower incidence of cancer.

But here, we are talking about too much radiation. And most seriously, radiation that has gotten right into our systems through food. As before, a little bit may not hurt, but we are talking about lots. How it happens is this. The food chains filters in the radiation because it is trying to concentrate the minerals and can't tell the difference between a radioactive isotope of a particular mineral, and its non-radioactive isotope variety.

As an example, let us look at iodine. Too much iodine in the body is poisonous. Too little is also very detrimental. The thyroid absorbs iodine for the body. Because we naturally get iodine from the food we eat and because it is generally added to salt, there is little likelihood that today (although in previous centuries it was a problem) that one gets too little. A nuclear explosion creates isotopes of iodine (I-131 and I-132). These have a half life of about 8 days. This means that it will hang around for about a month after a nuclear explosion. That is the reason that we take Potassium Iodide pills, for a month after a nuclear explosion, so that the thyroid will be loaded with iodine and won't accept anymore iodine during that period.

But here is what happened, during the atomic experiments, when people didn't know about this and didn't take the potassium iodide. The radioactive particles were carried up into atmosphere and settled down on the milk shed of southern Utah. There were so few particles that the radiation meters couldn't measure them. However, they washed down into the soil and the bacteria in the soil, seeking minerals, absorbed them in preference to other inert matter. The lichen in the soil, also seeking minerals, then absorbed the bacteria. These were further absorbed by the legumes and higher grasses. Then a cow came along and ate the grass. Each organism concentrated the minerals because that is what it was really seeking.

Indeed, within the body, certain organs filter out certain minerals also. The bone marrow seeks calcium and such, as do the mammary glands which produce milk. As an aside, concentration of radioactive particles in the bone marrow causes leukemia, actually one of the more prevalent forms of cancer caused by radiation. And leukemia destroys the body's immune system which makes it fatal because of all sorts of causes. However, to continue with our journey of a radioactive particle. This particular one, particularly ended up in the milk. When the milk was drunk by a nursing mother, her system too concentrated the mineral iodine, especially in her milk and she thus passed along the radioactive isotopes to her child with their mother's milk. Finally the child's biological system concentrated the iodine in its thyroid and radioactive isotope had by now become so concentrated that if we held a radiation detector up by the child's neck near the thyroid - it buzzed like a rattlesnake.

The radiation had become very detrimental to the children, and there was a high incidence of mental retardation in the St. George area of southern Utah as a result of the atomic experiments in Nevada. Indeed, scientific studies showed that approximately eleven thousand cases of cancer occurred in the general population of the United States, as the result of nuclear testing. Before we get too excited about that, one must remember that about 20 times that number of cases were caused by desired uses of medical and dental x-ray and other sought after uses of radiation.

Yes, radiation causes cancer. So does water cause drownings. And automobiles cause much greater numbers of fatalities than both put together. Before automobiles horse accidents also caused many human deaths. In all these matters, one has to weigh the relative social benefits before they dispense with radiation, water, automobiles or horses. Every activity, whether manufacturing or mining, whether production or sport, has its attendant risk. Pollution from burning coal has caused much more in the way of cancer than industrial radiation ever has, so let us keep things in perspective.

The issues, in this essay, and in the accompanying scientific papers, are how much radiation we will be dealing with for how long a period of time - along with the techniques of dealing with it.

Click here to return to the
[Layman's Overview](#)
[Table of Contents](#)

Short: **The Short Term Problem**

In the short run after a nuclear war the problem is fallout. Fallout that prevents work outside. Fallout that gets onto food. Fallout that contaminates the soil and prevents the immediate planting of new crops. Fallout that kills the animals. Fallout that contaminates the water and streams. Fallout that blows about in the very air itself.

But fortunately all this is a short term problem of just a few weeks and the radiation in the fallout will decay. Following that, one will then have to deal with the problem of long term residual radiation. However, that is a subject for another section. The problem being discussed here is short term radiation and in the next section the short term solutions for dealing with it.

Click here to return to the
[Layman's Overview](#)
[Table of Contents](#)

Survival: **The Short Term Solutions**

The good news is that food that was grown before the nuclear event, does not become radioactive. As long as the radioactive particles that fall on it are removed then it is perfectly okay. Wash off a banana - then peel and eat it. Wash off an egg - crack it open and it is ready to cook. These principles apply to any fruits and vegetables. Scrub the dirt off the potatoes and they will be perfectly fine. Open any can or closed container and the food will be unaffected. A case of tomatoes could have been sitting outside in the fallout and all one would need is to wash off the can and open it.

Some food may take a little more care. Grain stored in a grainery where dust can have gotten in may need to be washed. Animals may have died or gotten sick from the radiation and needed to be slain, but so long as care is taken in handling the exposed part of the animal the meat will still be okay. We are only talking about immediately after the event. Animals that have had an opportunity to forage in fallout

contaminated areas will assimilate the radiation into their bodies and also into products such as eggs and milk.

So, this is the good news. Immediately after a nuclear war, any food that is still around and that would otherwise be edible, will still be edible. If it has spoiled from lack of refrigeration, or some other cause - then that is another matter. However, in rural areas that have storage facilities there should not be any lack of food of some type. In fact there may well be more food than survivors, but eventually they are going to need a new crop - and that is an entirely different matter, covered in a separate section.

Click here to return to the
[Layman's Overview](#)
[Table of Contents](#)

Long: **The Long Term Problem**

The long term problem of radiation after a nuclear war arises from the fact that some isotopes, as explained in a previous section, have half-lives of decades. Those isotopes which have half-lives of centuries are not really a problem because they give off so little energy during a human lifetime that they are irrelevant.

Neither are the isotopes that we are talking about an external bodily threat because they are usually found in very small quantities. However, because they are concentrated by living organisms, and because in food they become internal to the organism, they can be a serious health concern in food. The two most serious problems, long term, are isotopes of cesium and strontium, both of which in themselves are desirable minerals for many living organisms. The organism is unable to distinguish between a beneficial and a harmful isotope and will therefore equally absorb those which are harmful.

Exactly what quantities are of serious concern and how they may be detected and measured are explained in technical papers in this series. The next section will explain, in generalities, how the problem can be dealt with. At present there is no coterie of professionals trained, equipped or experienced to deal with the technical issues. These technicians will have to be developed from individuals with related technical training - after a nuclear holocaust - and it is for that reason that the necessary technical papers are provided here.

Click here to return to the
[Layman's Overview](#)
[Table of Contents](#)

Solutions: The Long Term Solutions

The long term problem of radiation in food is indeed a horrendous one, but not an insurmountable one. We are used to processing food and to preserving it. This is just an additional step like testing for bacteria or other spoilage. Unfortunately, it is not one that is as easily done at home as other food preparation methods have been in the past. Still one can take care to make sure that radiation does not get into their home produced crops - in the first place.

Some of the necessary procedures may at first seem arduous but that is just a matter of custom. Because of radiation, there may be areas of land which one will wish to avoid in growing crops. But really, that is no different than today where some areas are avoided because they are too rocky and others because they are too swampy.

Some plants prefer other minerals rather than cesium and strontium. Those plants and soil with the alternate minerals, or fertilizer containing them, can be used. These again are matters of expertise that need to be developed in each local soil and plant area, so while information assisting those determinations is presented in the accompanying technical papers it is a matter beyond the generalities of this essay.

I have often stated that there are long term strategies for dealing with radiation in food. Many times I have been asked to list examples in one place and so to satisfy that request - I do so now:

1. Selection of land that is not radioactive.
2. Deep plowing land to turn it over and bring non-radioactive soil up to the surface. (This works well only where there is deep topsoil).
3. Selecting plants to match the soil characteristics, i.e.. that they have no desire for the radioactive minerals that are in the soil.
4. Fertilizing the soil with a mineral that will be taken up in preference to the radioactive mineral. (Oftentimes this is calcium as found in marl).
5. Composting and creating soil that does not have radioactivity in it and then using that soil in a green house, or otherwise protecting it from contamination.
6. Using hydroponics gardening or other similar methods that tightly control the mineral uptake of the plants.
7. Using distilled water on the plants. (Unfortunately this deprives them of the minerals that they

need and minerals then need to be added to the water).

8. Removing the radioactivity from the food. See the article on milk processing for example. There are other techniques for other foods.

9. Storing the food until radioactivity decreases. This works well for the radioactive iodine isotope in powdered milk and cheese.

10. Avoiding foods that have high radioactive content. For example, soy milk might be substituted for dairy or mother's milk for children.

11. Eating lower down on the food chain. As explained in an earlier section, radiation is concentrated by living organisms. Each higher level concentrating it more. It is possible to make flour directly out of bacteria. Using non contaminated oil sources from wells or tarsands would then produce pure uncontaminated flour.

12. Avoiding meats and animal products because they are high up the food chain.

13. Classifying foods by radioactive content and using high content foods for feed for animals that will neither produce product nor be eaten - such as dogs. Coincidentally, because of their relatively short life expectancies, in many cases this will not be detrimental to them.

14. Reserving foods with high radioactive content for individuals with short life expectations. Because at some levels it takes twenty years or longer for the radiation to take effect this will not be detrimental to people who are already elderly. Let them have the meat, fresh milk and eggs.

15. This is by no means an exhaustive list and still other strategies will be developed with experience. Food radioactive content can be indicated in packaging, the content can be certified and varieties of foods can be imported from areas that are radioactive free for that particular food. Eat well and prosper.

Click here to return to the
[Layman's Overview](#)
[Table of Contents](#)

MENU: [HOME](#) » [Reconstruction](#) » [Recovery](#) » [Renewal](#) » [Survival](#)

The *New* Three *R*_s

- every one will have to learn after a Nuclear War -
or other world-wide catastrophe

(but that most people aren't yet ready to even think about)

1. Reconstruction - of society
2. Recovery - of production
3. Renewal - of religion

And a fourth *R* for the present -

4. Resources - for nuclear war survival

by Bruce M. Beach

Radiological Scientific Officer

The Purpose Of These Pages

Our goal is to put essential information for reorganization, recovery and renewal - after a catastrophe such as nuclear war - onto this web site and onto one or two CDs and to make free distribution of these CDs in such a manner that they will be available to survivors of the catastrophe that we feel is now inevitable. While we do not know what form a catastrophe may take, still with the number of nuclear weapons that there are in the world, there is the very great possibility that it may be nuclear. We also realise that in the immensity and intensity of Divine Retribution the very equilibrium of the planet itself may be disturbed.

In the past we have assisted many hundreds of people in obtaining thousands of pieces of radiation detection equipment and we have given away hundreds of pieces to those who could not afford them. We simply no longer have the time to do that but we have stockpiled, tested and labeled hundreds of radiation detection devices (currently worth tens of thousands of dollars) that we will give away to those people that we have to turn away from the door of the shelter.

At that time - the Resources for Survival information on this site will be of considerably less use because we will be past the time to prepare but we have assembled survival guidance material to handout at the

door of the shelter to people for whom we have insufficient room in the shelter to accommodate. In December 2001 we completed a series of 4 twenty-minute videos, on such subjects as building an expedient shelter, which we hope to be able to show to the same group of people.

The plan is to train Radiological Instructors while in the shelter so that they can go out afterwards and train monitoring teams. Equipment has also been stockpiled for these teams.

For over forty years my wife and I have made an intensive effort to alert people to the threat and to urge them to prepare for it. I could never have done alone all that we have done together. For weeks she stood at my side and helped load two printing presses for imprinting of over one-hundred thousand booklets which we gave away absolutely free. Since the advent of the Internet untold thousands more booklets have been downloaded in a printable format for printing and distribution by many other people.

We used many ways of getting the information out to the public. We sent out tens of thousands of pieces of literature through the mails. We set up booths at numerous fairs, I appeared on many dozens of TV and radio programs, many of national and international scope, and there were so many newspaper and magazine articles written about the Ark Two that we long ago lost count. Literally, multiple millions of people heard about our efforts. And we have never charged anyone a penny for any of the information.

Once the Internet became popular, it surpassed all our other efforts of informing people. The interest in our web pages grew to where we get thousands of hits each day. Sometimes, at a period of particular interest it can be tens of thousands. Once, during one three hour period there were over 85,000 hits which completely swamped the system and the server had to pull the plug. Within hours our webmaster had the url rerouted to a new dedicated server directly on the backbone and we were back up. The site was eventually mirrored at over 30 locations. We have no idea how many hits daily there are on all the sites combined.

All this pales, however, compared to our present goal of making recovery information available for the survivors. It is doubtful that the Internet will be working as it is today but if segments of it can be gotten back up then perhaps some of the information can eventually be distributed over more local areas. For this reason we are going to try to get copies of the CDs out to widely distributed ISPs and ask them to retain them for installation on their servers afterwards. Another thought is if people can find a quantity of blank CDs they can take and duplicate the master CDs and distribute them about their geographical area so that those who can get a computer going with local emergency power - will be able to access the information. Any other strategies or suggestions for distribution would be greatly appreciated. We would like for this information to be shared as broadly as possible.

Recovery Information

Some of our key web pages deal with measuring radiation in food and strategies of dealing with radiation in the soil and food chain. There is information available here that I am not aware of being available anywhere else on the web. It spans from the practical "how to" to the highly theoretical necessary for

professionals to set up laboratories. I am a Radiological Scientific Officer and I can assure you that this is the necessary and correct information.

Many of our web pages deal with the technical aspects of small scale farming such as seed saving, fertilizers, crop management and so forth - and many others deal with alternate energy sources and still other subjects necessary to successful small farming, which will have to be a main focus of recovery.

A great many of our resources deal with old Pioneering skills. We cannot just go back to the old ways. We have lost many of the skills. No one had them all then and you would be hard put today to find a wheelwright, a miller, a tanner, a barrel maker. All those trades, like farming, have advanced into modern technology and the present experts seldom have used the old ways. Many of the old implements are no longer around and we certainly don't have the horses. Modern horses are neither bred nor conditioned to pull the plow. Still, in the skills of the past we may find solutions to the problems of the moment.

Beyond recovery there are many web pages, that are a part of this collection, that deal with the subject of the Reconstruction of Society and the Renewal of Religion. These are issues to which men's thought will have to eventually progress but I shall not belabor the point in this overview.

Our Library

Our personal library is very extensive. At one time I counted 13 encyclopedias. These are mostly specialized - like a 14 volume set on gardening and another 16 volume set on do-it-yourself repairs. There are others on health and medicine and a variety of other subjects.

We have also acquired CDs with hundreds of books and one summer put a crew to work microfilming thousands of documents which we have on microfiche. These, plus many many books, are in just our own home but our Ark Two Community librarian is the real gatherer of information - he has many thousands of books, mostly on technology for recovery.

In the future, when people want it, we hope to be able to disseminate all this information widely. There are many blind spots in our library. We have little information on modern technology and almost no information on leading edge technology. Members of our Ark Two community are of far more than average knowledge about nuclear and computers but there are many, many fields such as in modern metallurgy, petroleum refining, hundreds of specialties in chemistry, medicine, and untold numbers of other areas that the expertise to re-establish them will have to survive with the experts - if they are going to be recovered in the immediate decades following.

One major focus of our library has been maps, in order to determine where that expertise may reside. We have thousands of maps. Local road maps. Topographical maps. More and more maps on an expanding scale. We have every map ever published by the National Geographic. We have CDs with map search programs. North American and World Atlases. The list goes on. One map set which we were very desirous of obtaining cost thousands of dollars (far beyond our budget) from the US government. It

comes with a subscription program for real-time updating and the printed book is reprinted annually. A marvelous tool for demographers tracking changing patterns - but one used copy would serve our purposes. Miraculously, on the Internet we found a library discard copy - at a fraction of the cost.

Other associates of ours are providing us with gigabytes of survival information on CDs. Our problem has not been so much one of obtaining information but determining on which to concentrate our limited resources for storing and cataloging. Tons of information is of no use, if you have no way of finding what you want in it. In early years we were given literally tons of new books by libraries and publishers. Expensive new technical volumes that often cost over a hundred dollars each - but we finally had to abandon that effort simply because of lack of storage space and manpower to handle it. Tons had to be destroyed simply because we could not, even with weeks of searching, find a way to transport them to Third World countries who were desirous of having them.

So the problem of the moment has not been getting information but one of determining which information is going to be most useful to survivors. What we offer in these pages, measuring radiation contamination in food, producing food without the modern technology and its skills, finding alternate sources of energy, recovering and repairing remaining machinery, creating the nucleus of an economic system and restoring the basis of functioning society - information on how to do these things - are what we feel will be most needed at the outset. It is our sincerest hope that we will be able to get it to the people who need it and that they will find it useful.

Click here to return to the [Top](#)

[1. Reconstruction of Society after Nuclear War](#)

Since most people think that all-out nuclear war is not survivable, either individually or for society, and since somehow most intellectuals feel that to make positive plans for its aftermath would seem to somehow advocate or condone it - there is absolutely no scholarly discussion on this subject. In these pages I give some direction for the

[Reconstruction of Society](#)

along with critiques of ideas on the

[New World Order](#)

and my personal predominant area of effort - which is the development of the

[World Language Process](#)

The "Reconstruction" Site Map

is immediately below

RECONSTRUCTION SITE MAP

Reconstruction of Society After Nuclear War

Immediate Reconstruction of Local Society

Martial Law: Domestic Support Operations

Martial Law: Reconstruction of Social Order

Martial Law: Internment and Resettlement Operations

Camps: Standards for Building Refugee Camps

Health: Field Hygiene and Sanitation

Toilets: Unsewered Toilets

Rescue: Basic Rescue Skills

Death: Mass body disposal

Dead Animal Disposal

Animal Disposal During an Epidemic

How To Make A Fumigating Mask

How To Make An Emergency Gas Mask.pdf

Danger of Dog Packs

Medical: Emergency Medical Facilities

Medical: When There is No Doctor - Locked

Medical: When There is No Dentist - Locked

[LETS: Reconstruction of the Economic System](#)

[Carnegie: Management of Large Scale Enterprise - Table of Content](#)

[The Gospel of Wealth - A Baha'i Perspective](#)

[Introduction by Harvard Editor](#)

[Chronology of Carnegie's Life](#)

[Carnegie's Introduction](#)

[THE PROBLEM OF THE ADMINISTRATION OF WEALTH](#)

[THE BEST FIELDS FOR PHILANTHROPY](#)

[The Advantages of Poverty](#)

[Popular Illusions about Trusts](#)

[An Employer's View of the Labor Question](#)

[Results of the Labor Struggle](#)

[Distant Possessions: The Parting of the Ways](#)

[Americanism versus Imperialism - Part I](#)

[Americanism versus Imperialism - Part II](#)

[Democracy in England](#)

[Home Rule in America](#)

[Does America Hate England?](#)

[Imperial Federation](#)

[The New World Order - An Introduction](#)

[The New World Order - A Philosopher's View](#)

[Quotes by Presidents & Famous People](#)

[Quotes by Other Famous People](#)

[A Proposed New World Order Constitution](#)

[Opposition to the New World Order Constitution](#)

[History of The New World Order](#)

[Hoax regarding The New World Order](#)

[The World Language Process](#)

[Mission of The World Language Process](#)

[History of The World Language Process](#)

[Projects of The World Language Process](#)

[Regularization of English Syntax](#)

[Angel Tongue Tutorial](#)

[Example of Angel Tongue](#)

[Anjel Arabic Representation](#)

[Inactive Webpal Example](#)

[344 Chess Games](#)

[Chancellors of the World Language Process](#)

[The ACCESS System](#)

[Criticisms of The World Language Process](#)

[Frequently Expressed Comments](#)

[Essays on Language](#)

[Lango](#)

[Lango - Introduction and Directory](#)

[The Origins and Spread of English](#)

[English as an Auxiliary Language](#)

[English as a Primary Language](#)

[English and Other Languages](#)

[The Constructed Languages](#)

[The International Auxiliary Language](#)

[The International Language Committee](#)

[Constructed and Organic Languages](#)

[Language in Education and the Media](#)

[Orthography and Orthoepy](#)

[The Language of Empire](#)

[Pidgins and Creoles](#)

[LANGO Grammar](#)

[LANGO Vocabulary](#)

[LANGO Phonology](#)

[LANGO Orthography](#)

[History of English Spelling Revision](#)

[A Suggestion Towards Orthographic Reform](#)

[International Pronunciation and Accent](#)

[Names and Organisation](#)

[Glossary](#)

[WLP proposal to the UHJ](#)

[Essay on Baha'i UAL Teachings](#)

[Short references in the essay](#)

[Bibliography used in the essay](#)

[Raw quotes used in the essay](#)

[Letter to the UHJ on the subject of gender](#)

[UHJ on the subject of gender](#)

[Essential World English](#)

[Prospects for the World Language Process](#)

[Picture Gallery](#)

[China Goals](#)

[China and Volunteer Teachers](#)

[2. Recovery from Nuclear War](#)

This is the page that I am currently trying hardest to interest people in. It has to do with *individual* recovery after a nuclear war and deals primarily with the subject of *agriculture*. For those who have prepared for nuclear survival this is the next level of thought.

The "Recovery" Site Map
is immediately below

RECOVERY SITE MAP

[Individual Agricultural Recovery After Nuclear Holocaust](#)

[Radiation in Food](#)

[Layman's overview on Radiation in Food](#)

[Shorter letter on radiation in Food.](#)

[Explanation by a microbiologist](#)

[Radiation Risk and Ethics](#)

[Manual of food quality control - radionuclides in food](#)

[Removal of Strontium 89 and 90 from milk](#)

[Farming After A Nuclear War](#)

[Gathering Information for Farming After A Nuclear War](#)

[Protection of Food and Agriculture From Nuclear Attack](#)

[Fallout on the Farm](#)

[The Have More Plan](#)

[Basic Seed Saving](#)

[Humanure Handbook](#)

[Humanure Handbook in .pdf format](#)

[The Organic Way to Mulching](#)

[Fence Planner for the Common Sense Fence](#)

[Pressing Oil from Seeds](#)

[Build Your Ark](#)

[The Farmstead Book](#)

[Grow Friuts & Vegetables The Way They Used To Taste](#)

[Advanced Seed Saving](#)

[Alternate Energy](#)

[Make Your Own Electricity](#)

[Overview of Making Your Own Electricity](#)

[Bicycle Power](#)

[David Butcher Pedal Powered Generator](#)

[A Quick and Dirty Pedal Powered Generator](#)

[How to make low RPM generators!](#)

[Comparison of Alternators and Generators](#)

[Wooden Low RPM Alternators](#)

[Alternator from Scratch](#)

[Making a generator/alternator from a brakedrum](#)

[Brakedrum update](#)

[Forcefield Low RPM Disk Alternator](#)

[Making a Volvo Front Brake Disk into a Generator](#)

[Wood Axe - A very simple wind generator](#)

[Homebrew Windgenerator](#)

[All the plans and information for another wooden one](#)

[A key set of plans to study](#)

[Additional Info on Coils](#)

[Making a Microwave Oven into a Generator](#)

[Testing your theories](#)

[How to make a lawnmower into a generator.](#)

[Windpowered Generators](#)

[Towers](#)

[Tower Design](#)

[Blades or Propellers & our own design sketches](#)

[Technical Information on How to Build Blades](#)

[Still More Information on How To Build Blades](#)

[Some Neat Diagrams on Blade Design](#)

[A Blade in One Hour](#)

[Tails](#)

[Some pictures of a tail mounting](#)

[Overall Design Concepts that includes tails](#)

[More Overall Design Concepts that includes tails](#)

[Testing tails](#)

[Building your own anemometer](#)

[Waterpowered Generators](#)

[The Large Waterfall at Ark Two](#)

[The Smaller Waterfall at our Home & Theory of Systems](#)

[Using Pumps as Turbines](#)

[Making Motors into Electrical Generators](#)

[Diesel and Gasoline Electrical Generators](#)

[Batteries](#)

Bicycle Power

Not Just For Riding

Woodgas

Woodgas pdf file

Biofuel

Make Your Own Biodiesel

Make Your Own Biodiesel - Part 2

Foolproof Way to Make Biodiesel

Using Straight Vegetable Oil

Separating Glycerine/FFAs

From the Fryer to the Fuel Tank

Pressing Oil from Seeds

Stills

How Distillation Works

Building a home still

Running on Alcohol

Making it on the Farm

Still Safety

The Manual For the Home and Farm Production of Alcohol

Solar

[Overall Survey of Solar Cookers](#)

[Survey of Box Solar Cookers](#)

[A very simple solar cooker design](#)

[Make hotwater with the sun even in cold climates](#)

[Build Your Own Solar Water Heater](#)

[Solar Hotwater Heating - A DIY Guide](#)

Simple Technology

[The Basic Principles of Machinery](#)

[Descriptions of Simple Machines](#)

[Patterns for Simple Farm Devices](#)

[The Scythe - A tool of the centuries](#)

[Blacksmithing - An essential technology](#)

[How to build your own alternator regulator](#)

[How to build a float switch](#)

[How to do a gas to propane conversion](#)

[How to convert flashlights to use LEDs](#)

Pioneer Methods

[Making the Best of Basics](#)

[Cloudburst - Handbook of Rural Skills and Technology](#)

[Cloudburst Two](#)

[Foxfire One](#)

[Foxfire Two](#)

[Foxfire Three](#)

[Foxfire Four](#)

[Foxfire Five](#)

[Foxfire Six](#)

[3. Renewal of Religion after Nuclear War](#)

Nothing occurs except by the Decisive or Permissive Will of God. Many will ask - if God is Good why did He permit a nuclear war? From the link in the above title I answer that question and present a number of short religious essays intended to help people fulfill God's Divine Purpose coming out of the nuclear war.

The "Renewal" Site Map
is immediately below

[RENEWAL SITE MAP](#)
[Renewal of Religion](#)

[Why God Would Permit Nuclear War](#)

Essays on Religion - Premises

Problems of Prophecy

Mother Shipton

Ouji

Plants One

Plants One Two

Straight Arrow

The Iching

The Seeker

My Declaration

Four Types of Souls - Content

Four Types of Souls - Introduction

The Soul of Self

The Soul of Love

The Soul of Reason

The Soul of Reason

Four Paths to Truth

Authority

The Senses

[Reason](#)

[Intuition](#)

[The Most Clear Proof - Contents](#)

[The Most Clear Proof - Introduction](#)

[The Most Clear Proof - Numbers](#)

[Jesus](#)

[2300 Days](#)

[1844](#)

[Responses](#)

[Where](#)

[When](#)

[Manifestation](#)

[Revelation](#)

[First Step](#)

[Next Steps](#)

[Final Step](#)

[Final Analysis](#)

[The Seven Churches](#)

[Seaching the OCEAN of God's Word](#)

[Meditation and the Path of Prayer](#)

[Prophecies in the Stars](#)

[4. Resources for Survival of Nuclear War](#)

In recent years this subject has been the main entry page to this site. All the pages of survival material are still here and you can go to them by clicking on the above heading.

The "Resources" Site Map
is immediately below

RESOURCES SITE MAP

[Resources for Survival of Nuclear Holocaust](#)

[State by State - Survival Information](#)

[Nuclear Power Plants](#)

[Links to Target Maps \(+ survival info\) of All 50 States](#)

[Target update information](#)

[The Ark Two Community](#)

[Map of the Interior of the Shelter](#)

[Map to the location of Ark Two](#)

[Pictures of the Inside of the Shelter](#)

[Pictures of the outside of the Shelter](#)

[Pictures of the Shelter Construction](#)

[Life in the Ark Two Community](#)

[Ark Two Programs](#)

[The Ark Two Community TEAM leaders](#)

[Radiation and Detectors](#)

[Official Government Detector Instructions](#)

[My explanation - with pictures](#)

[Understanding Radiation](#)

[How to build a KFM](#)

[Free Books for Downloading](#)

[You Will Survive Doomsday - HTML](#)

[You Will Survive Doomsday - .pdf](#)

[11 Steps To Survival - HTML](#)

[11 Steps To Survival - .pdf](#)

[Your Basement Fallout Shelter - .pdf](#)

[Fallout On The Farm - .pdf](#)

[Nuclear Weapons Defense Manual - .pdf](#)

[Nuclear Weapons Defense Manual - Tables - .pdf](#)

[Nuclear Weapons Effects - Radiological Scientific Officers Handbook - .pdf](#)

[Nuclear War Survival Skills - \(replica\)](#)

[Ark Two Programs](#)

[Overall Purpose of the Programs](#)

[Survival Education](#)

[Agricultural Recovery](#)

[Radiological Monitoring Equipment](#)

[Economic recovery](#)

[KI Potassium Iodide](#)

[State by State Recovery](#)

[Family Registry](#)

[Information Broadcast](#)

[Social Reorganization](#)

[Shelter Building \(+ offsite links\)](#)

[A two bus shelter for 24 people](#)

[Easy Printing Plans for a Basement Shelter](#)

[\(offsite links for bug out kits\)](#)

[\(offsite link for KI - Potassium Iodide\)](#)

[Filtering Air in a shelter](#)

[Kearny Air Pump](#)

[Ventilation](#)

[Free Consultation on Shelter Building](#)

Alternate Energy

Table of Contents:

[Overview: On Alternate Energy.](#)

The problems of producing your own.

[Electricity: Make your own](#)

We have built many of our own generators. Here we tell you how to do it - using wind, water, bicycles and other means.

[Bikes: Not just for riding](#)

Bikes are a very much overlooked energy source. They can be used to operate all sorts of machines and they can be used to generate electricity.

[Smokemobile: Woodgas](#)

Detailed plans for running your tractor, truck, car or bus on wood. This is a tried and proven method used in Europe during the Second World War when there was a gasoline shortage. Much improved design since then. [There is also a copy of the old method available in .pdf](#)
(for which you need a pdf reader)

[Biofuel: Grow it on the farm](#)

Biofuels are used as a substitute for diesel. They can be grown and processed on the farm. They do not require a still.

[Stills: Make your own fuel from potatoes, corn, etc.](#)

These are a bit trickier and at the present generally illegal, or at the very minimum you can get into a lot of legal hassle.

[Solar: Using the sun for energy.](#)

While it is impractical to home build solar cells for generating electricity, solar is great for cooking and

other applications like heating water.

Click here to return to the
[Individual Agricultural Recovery
After Nuclear Holocaust](#)

The Problem of Producing Your Own

There are many problems in developing and installing independent power systems. For one thing the government is not helpful. To say the least. It is not just our project that finds these hurdles but many others have been stopped also. In the second previous century our local water courses were used for power but in the last hundred years everything possible has been done to prevent their use, including dynamiting what was the main local power producing dam. The government centralized production for economies of scale and did not want competition. Then during the depression when costs were such that the farmers could not afford the electricity from the monopoly the farmers again started a generator at the dam and this is when the system was taken back over by the government and the dam dynamited.

With all the surplus rotting potatoes in the area we might also make a still and produce fuel for our diesel generators. But, presently, there is a \$100,000 annual fine for doing so. We will simply have to wait for a more propitious time.

Click here to return to the
[Table of Contents](#)

MENU: [HOME](#) » [Reconstruction](#) » [Recovery](#) » [Renewal](#) » [Energy Types](#)

Simple Technology

Table of Contents:

Some of the information regarding Simplified Technology is presently in locked files because it is copyrighted information. The concept behind putting it on this site in that manner is to gather the information now and to archive it in a form that may possibly be disseminated later. Some of the information here could as well as have gone under farming or pioneering skills. There is so much information about using bicycles, that while they might have gone under simple machines, they have gotten a category of their own. The same applies to windmills and waterwheels. Some of the decisions as where to put information have been arbitrary but there is just too much to put it all under one category, so the reader needs to look under all the categories when studying the subject.

[Basic Machines: The Basic Principles of Machinery](#)

This 168 page .pdf book is open and available for downloading NOW. It covers levers, block and tackle, plane and wedge, and on up through hydraulic devices, and internal combustion engines, and more.

[Simple Machines: Descriptions of Simple Machines](#)

This 81 page .pdf book from MIT explains how to build dozens of primitive machines, drills, lathes, pumps, and all sorts of other useful devices. Currently a locked file because of copyright.

[Farm Devices: Patterns for Simple Farm Devices](#)

This 150 page .pdf book shows how farmers built their own devices in the 1700s and 1800s (and for perhaps centuries earlier). Practical ideas that are still used today.

[Scythes: A tool of the centuries](#)

This 63 page .pdf copyrighted and presently sealed book covers one of the most basic and essential tools of the centuries. Along with ax, hoe, hammer and shovel, it has been essential to the establishment of civilization. Largely displaced by modern harvesting methods it is a technology that may need to be at least temporarily "recovered".

[Blacksmithing: An essential technology](#)

This 132 page .pdf copyrighted and presently sealed book covers an essential technology that may have to be recovered. About a hundred years ago every village would have one or more blacksmiths, but then the

skill largely disappeared except as retained by farriers (horse shoeing is another subject) and some ornamental artists.

[Regulator:](#) [How to build your own alternator regulator](#)

[SEALED:](#) [How to build your own alternator regulator](#)

This is the SEALED mirrored version of this site that won't be opened until after The Great Catastrophe. The above open link is to the original Forcefield Site.

[Float Switch:](#) [How to build a float switch](#)

[SEALED:](#) [How to build a float switch](#)

This is the SEALED mirrored version of this site that won't be opened until after The Great Catastrophe. The above open link is to the original Forcefield Site.

[Propane Conversion:](#) [How to do a gas to propane conversion](#)

[SEALED:](#) [How to do a gas to propane conversion](#)

This is the SEALED mirrored version of this site that won't be opened until after The Great Catastrophe. The above open link is to the original Forcefield Site.

[LED Conversion:](#) [How to convert flashlights to use LEDs](#)

[SEALED:](#) [How to convert flashlights to use LEDs](#)

This is the SEALED mirrored version of this site that won't be opened until after The Great Catastrophe. The above open link is to the original Forcefield Site.

[Click here to return to the Overview Table of Contents](#)

MENU: [HOME](#) » [Reconstruction](#) » [Recovery](#) » [Renewal](#) » [Survival](#)

Pioneer Methods

The "Good Old Days" were those of just recent decades past. In the 1800s and centuries previous the pioneer folk had it unimaginably difficult. People grew soft - and had no idea. City folk could not even begin to do the work of the real farmers who still ran small farms.

A US candidate for president once promised 40 acres and a mule. I always said that the only way I would have possibly made it through the first winter was to eat the mule. The pioneers were survivalists and had survival skills beyond any that we can imagine.

In addition to not having the "toughness", work habits and skills of the early pioneers - we do not have their resources. There are no buffalo herds and there is nowhere near that the deer and antelope play in sufficient number to support most survivors. Those who have taken survival courses that have taught them to go out into the woods and survive will be sorely disappointed. Such animals that have survived the radiation will be in very short supply relative to the survivors that would be in competition for them.

One will not have the horses, wagons or other implements that were necessary to pioneer survival. There will be a far larger population survive than there were pioneers a few centuries ago and there will be far fewer resources of the kind that sustained them. The early settlers of our village were confident in their ability to find in a few minutes enough fish in the stream to make supper. Even in my early days in the village a person could promise the night before that they would go out on the bridge out our back door and get fresh fish for breakfast - and make good their promise. But those days are gone. Fished out and poisoned out by salt on the roads and pesticide run-off from the farmer's fields. At this writing fish no longer come safe even from the farmer's markets without warnings that they are hazardous to expectant mothers.

No, we can't return to the old days - even if we want to. But fortunately we have many, many other advantages. We don't have to cut the forests to gain agricultural ground. We know many things the pioneers did not. Childbirth was a great hazard to pioneer women - simply because people did not know to wash their hands. We have a great advantage in modern knowledge - but we may well need to supplement that, at least for a while, with some of the pioneer knowledge and skills that we have forgotten about. That is the purpose of this page.

This page does not stand by itself, anymore than do any of the others. There may be some duplication on some items that will be found in the pages on simplified machinery and small farming but all that information will probably be just as important to know - if not more so.

The files on this page are all locked until after the nuclear war. Those who have to wisdom to gather the information ahead of time will have to go to other sources but all these pages can be thought of as a

checklist of types of information one may wish to gather together.

Table of Contents:

[SEALED: Making the Best of Basics.](#)

This is a SEALED 188 page .pdf file that won't be opened until after The Great Catastrophe. This 1975 book is by James Talmadge Stevens. It covers sprouting, food drying, game cleaning, recipes for different home products and a variety of similar subjects.

[SEALED: Cloudburst - Handbook of Rural Skills and Technology.](#)

This is a SEALED 126 page .pdf file that won't be opened until after The Great Catastrophe. The book is edited by Vic Marks and is Published in the US by: Cloudburst Press of America, Inc. 2116 Wetern Avenue, Seattle, Washington 98121 and in Canada by: Cloudburst Pres Ltd., Mayne Island British Columbia V0N 2J0 - The book covers a variety of technologies including overshot and undershot waterwheels, juice presses, beehive management, cheese making, a hand operated washing machine, a solar drier, and many other things.

[SEALED: Cloudburst Two.](#)

This is a SEALED 128 page .pdf file that won't be opened until after The Great Catastrophe. This is a second volume of the above book and is also edited by Vic Marks and is Published in the US by: Cloudburst Press of America, Inc. 2116 Wetern Avenue, Seattle, Washington 98121 and in Canada by: Cloudburst Pres Ltd., Mayne Island British Columbia V0N 2J0 - This volume covers a many, many additional technologies including various forms of construction, hand and foot operated machinery, kilns, hydraulic rams, spinning wheels, looms and associated machinery, and many, many other pioneer subjects.

[SEALED: Foxfire One.](#)

This is a SEALED 388 page .pdf file that won't be opened until after The Great Catastrophe. This series of books is edited by Eliot Wigginton and is published by Anchor Press | Doubleday 501 Franklin Avenue - Garden City, NY 11530. Volume One covers many subjects from hog dressing to cabin building.

[SEALED: Foxfire Two.](#)

This is a SEALED 410 page .pdf file that won't be opened until after The Great Catastrophe. This series of books is edited by Eliot Wigginton and is published by Anchor Press | Doubleday 501 Franklin Avenue - Garden City, NY 11530. Volume Two covers many subjects from midwifery to burial.

[SEALED: Foxfire Three.](#)

This is a SEALED 512 page .pdf file that won't be opened until after The Great Catastrophe. This series of books is edited by Eliot Wigginton and is published by Anchor Press | Doubleday 501 Franklin Avenue - Garden City, NY 11530. Volume Three covers many subjects from animal care to hide tanning and making musical instruments.

SEALED: [Foxfire Four.](#)

This is a SEALED 480 page .pdf file that won't be opened until after The Great Catastrophe. This series of books is edited by Eliot Wigginton and is published by Anchor Press | Doubleday 501 Franklin Avenue - Garden City, NY 11530. Volume Four covers many subjects from gardening to traps to knife making and horse trading.

SEALED: [Foxfire Five.](#)

This is a SEALED 515 page .pdf file that won't be opened until after The Great Catastrophe. This series of books is edited by Eliot Wigginton and is published by Anchor Press | Doubleday 501 Franklin Avenue - Garden City, NY 11530. Volume Five covers many subjects from iron making and blacksmithing to gun making and hunting.

SEALED: [Foxfire Six.](#)

This is a SEALED 513 page .pdf file that won't be opened until after The Great Catastrophe. This series of books is edited by Eliot Wigginton and is published by Anchor Press | Doubleday 501 Franklin Avenue - Garden City, NY 11530. Volume Six covers many subjects from shoe making to wooden locks and toy making.

MENU: [HOME](#) » [Reconstruction](#) » [Recovery](#) » [Renewal](#) » [Survival](#)

THE HUMAN NUTRIENT CYCLE

“For the living, three things are inevitable: death, taxes, and shit.”

Dan Sabbath and Mandel Hall in End Product

Figure 2.4

THE HUMAN NUTRIENT CYCLE *INTACT* and *BROKEN*

The Human Nutrient Cycle is an endless natural cycle. In order to keep the cycle intact, food for humans must be grown on soil that is enriched by the continuous addition of organic materials recycled by humans, such as humanure, food scraps, and agricultural residues. By respecting this cycle of nature, humans can maintain the fertility of their agricultural soils indefinitely, instead of depleting them of nutrients, as is common today.

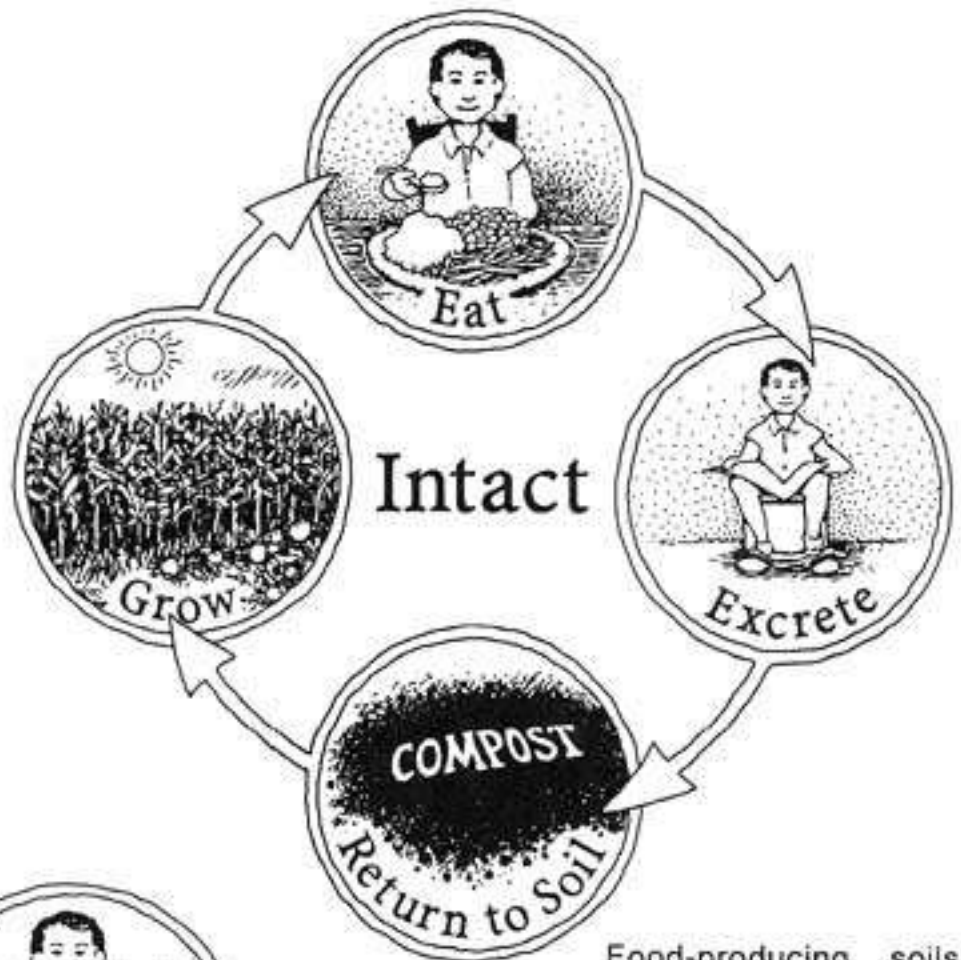

Food-producing soils must be left more fertile after each harvest due to the ever-increasing human population and the need to produce more food with each passing year.

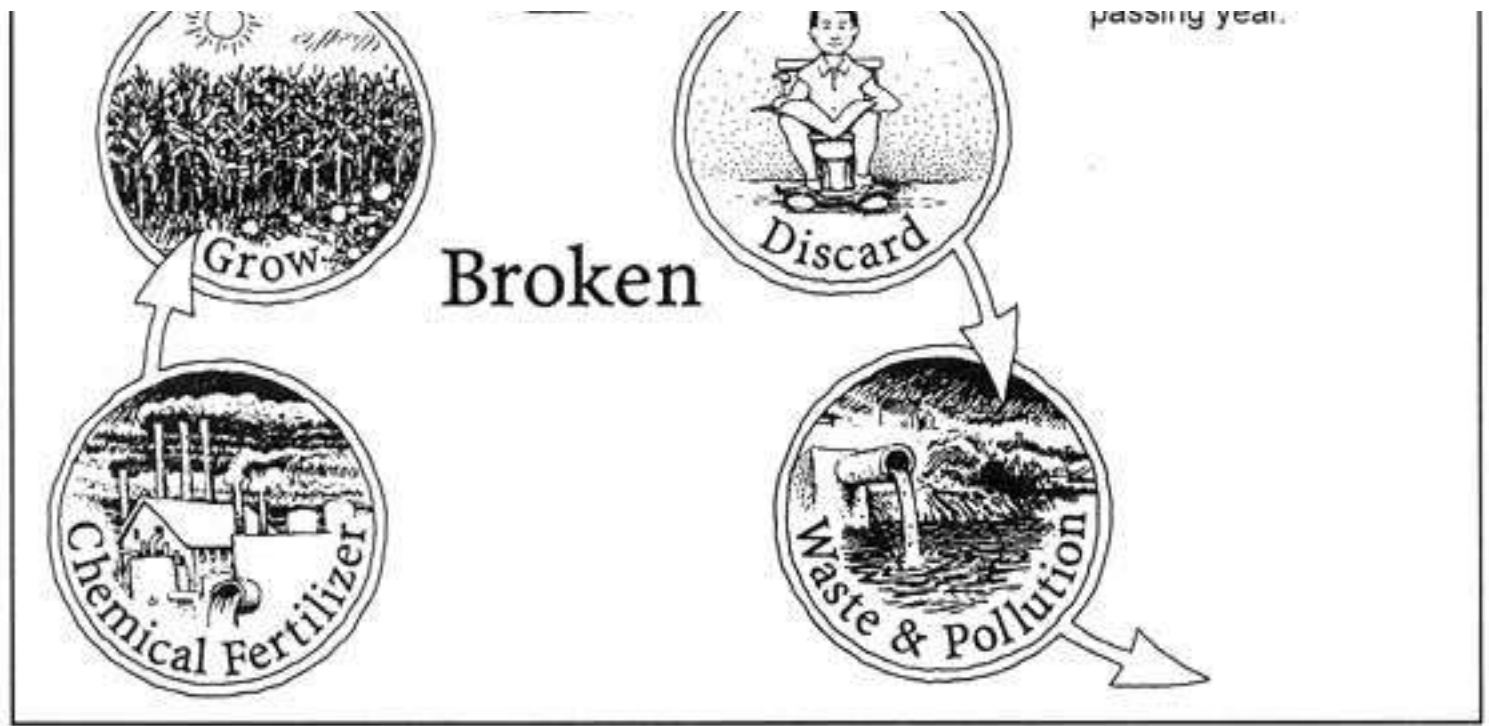

When crops are produced from soil, it is imperative that the organic residues resulting from those crops, including animal excrements, are returned to the soil from which the crops originated. This recycling of all organic residues for agricultural purposes should be axiomatic to sustainable agriculture. Yet, spokespersons for sustainable agriculture movements remain silent about using humanure for agricultural purposes. Why?

Perhaps because there is currently a profound lack of knowledge and understanding about what is referred to as the “human nutrient cycle” and the need to keep the cycle intact. The human nutrient cycle goes like this: a) grow food, b) eat it, c) collect and process the organic residues (feces, urine, food scraps, and agricultural materials), and d) return the processed organic material back to the soil, thereby enriching the soil and enabling more food to be grown. The cycle is repeated, endlessly. This is a sustainable process that mimics the natural cycles of nature and enhances our ability to survive on this planet. When our food refuse is instead discarded as waste, the natural human nutrient cycle is broken, creating problems such as *pollution, loss of soil fertility, and abuse of our water resources.*

We in the United States each waste about a thousand pounds of humanure every year, which is discarded into sewers and septic systems throughout the land. Much of the discarded humanure finds its final resting place in a landfill, along with the other solid waste we Americans discard, which, coincidentally, also amounts to about a thousand pounds per person per year. For a population of 250 million people, that adds up to nearly *250 million tons of solid waste personally discarded by us every year, at least half of which is valuable as an agricultural resource.*

The practice we humans have frequently employed for waste disposal has been quite primitive — we dump our garbage into holes in the ground, then bury it. That’s called a landfill, and for many years they were that simple. Today’s new “sanitary” landfills are lined with waterproof synthetic materials to

prevent the leaching of garbage juice into groundwater supplies. Yet, only about one third of the active dumps in the US have these liners.⁴ Interestingly, the lined landfills bear an uncanny resemblance to gigantic disposable diapers. They are gargantuan plastic lined receptacles where we lay our crap to rest, the layers being carefully folded over and the end products of our wasteful lifestyles buried as if they were in garbage mausoleums intended to preserve our sludge and kitchen trash for posterity. We conveniently flush our toilets and the resultant sewage sludge is transported to these landfills, tucked into these huge disposable diapers, and buried.

This is not to suggest that sewage should instead be used to produce food crops. In my opinion, it should not. Sewage

consists of humanure collected with hazardous materials such as industrial, medical, and chemical wastes, all carried in a common waterborne waste stream. Or in the words of Gary Gardner (State of the World 1998), “*Tens of thousands of toxic substances and chemical compounds used in industrial economies, including PCBs, pesticides, dioxins, heavy metals, asbestos, petroleum products, and industrial solvents, are potentially part of sewage flows.*” Not to mention pathogenic organisms. When raw sewage was used in Berlin in 1949, for example, it was blamed for the spread of worm-related diseases. In the 1980s, it was said to be the cause of typhoid fever in Santiago, and in 1970 and 1991, it was blamed for cholera outbreaks in Jerusalem and South America, respectively.⁵

Humanure, on the other hand, when kept out of the sewers, collected as a resource material, and properly processed (composted), makes a fine agricultural resource suitable for food crops. When we combine our manure with other organic materials such as our food discards, we can achieve a blend that is irresistible to certain very beneficial microorganisms.

The US EPA estimates that nearly 22 million tons of food waste are produced in American cities every year. Throughout the United States, food losses at the retail, consumer, and food services levels are estimated to have been 48 million tons in 1995.⁶ That would make great organic material for composting with humanure. Instead, only 2.4% of our discarded food was being composted in the US in 1994; the remaining 97.6% was apparently incinerated or buried in landfills.⁷

In 1998, industrial countries were only reusing 11% of their organic garbage.⁸ The Organization for Economic Cooperation and Development, a group made up primarily of western industrial countries, estimates that 36% of the waste in their member states is organic food and garden materials. If paper is also considered, the organic share of the waste stream is boosted to nearly an incredible two thirds! In

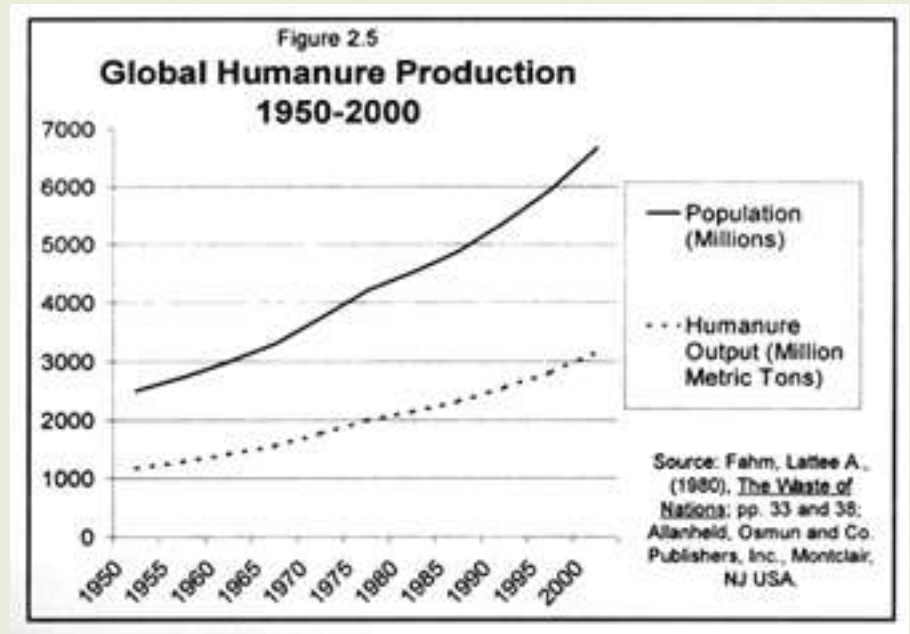

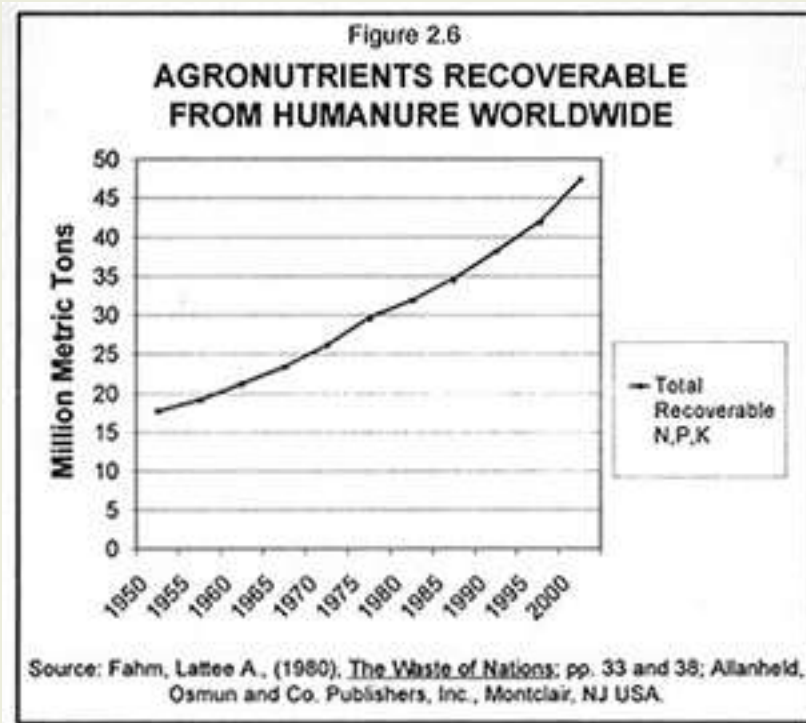

developing countries, organic material typically makes up one-half to two-thirds of the waste stream.⁹ According to the EPA, almost 80% of the net discarded solid waste in the US is composed of organic material (see Figure 2.1).

It is becoming more and more obvious that it is unwise to rely on landfills to dispose of recyclable materials. Landfills fill up, and new ones need to be built to replace them. The estimated cost of building and maintaining an EPA approved landfill is now nearly \$125 million and rising. The 8,000 operating landfills we had in the United States in 1988 had dwindled to 5,812 by the end of 1991. By 1996, only 3,091 remained.¹⁰

In fact, we may be lucky that landfills are closing so rapidly. They are notorious polluters of water, soil, and air. Of the ten thousand landfills that have closed since 1982, 20% are now listed as hazardously contaminated Superfund sites. A 1996 report from the state of Florida revealed that groundwater contamination plumes from older, unlined landfills can be longer than 3.4 miles, and that 523 public water supplies in Florida are located within one mile of these closed landfills, while 2,700 lie within three miles of one.¹¹ No doubt similar situations exist throughout the United States.

Organic material disposed of in landfills also creates large quantities of methane, a major global-warming gas. US landfills are “*among the single greatest contributors of global methane emissions,*” according to the Natural Resources Defense Council. According to the EPA, methane is 20 to 30 times more potent than CO₂ as a greenhouse (global warming) gas on a molecule to molecule basis.¹²

Tipping fees (the fee one pays to dump waste) at landfills in every region of the US have been increasing at more than twice the rate of inflation since 1986. In fact, since then, they have increased 300% and are expected to continue rising at this rate.¹³

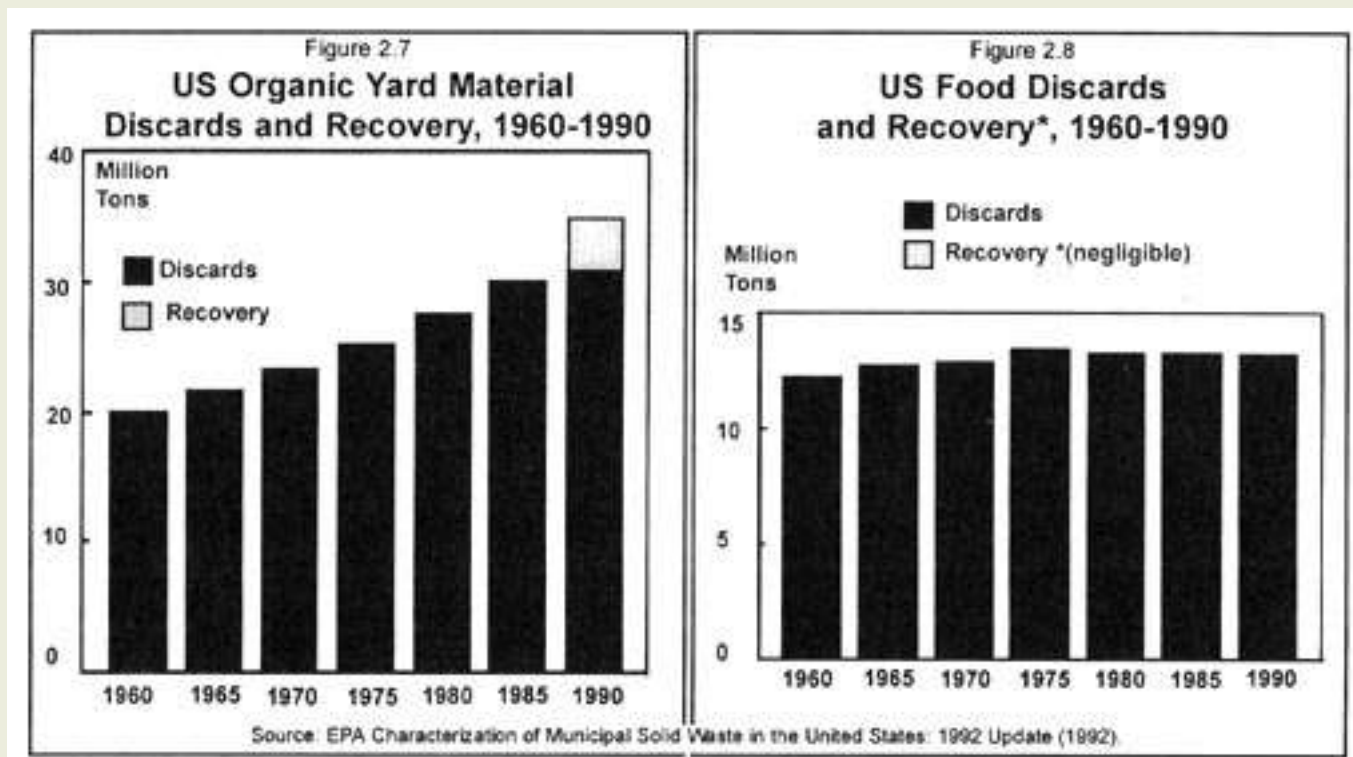

In developing countries, the landfill picture is also bleak. In Brazil, for example, virtually all (99%) of the solid waste is dumped into landfills, and three-fourths of the 90,000 tons per day ends up in open dumps.¹⁴ Slowly we're catching on to the fact that this throw-away trend has to be turned around. We can't continue to throw "away" usable resources in a wasteful fashion by burying them in disappearing, polluting, increasingly expensive, landfills.

As a result, recycling is now becoming more widespread in the US. Between 1989 and 1992, recycling increased from 9 to 14%, and the amount of US municipal solid waste sent to landfills decreased by 8%.¹⁵ The national average for the recycling of all materials in US cities had jumped to 27% by 1998.¹⁶ Composting is also beginning to catch on in a big way in some areas of the world. In the United States, the 700 composting facilities in 1989 grew to more than 3,200 by 1996. Although this is a welcomed trend, it doesn't adequately address a subject still sorely in need of attention: what to do with humanure, which is rarely being recycled anywhere in the western world.

If we had scraped up all the human excrement in the world and piled it on the world's tillable land in 1950, we'd have applied nearly 200 metric tons per square mile at that time (roughly 690 pounds per acre). In the year 2000, we'll be collecting significantly more than *double* that amount because the global population is increasing, but the global land mass isn't. In fact, the global area of agricultural land is steadily *decreasing* as the world loses, for farming and grazing, an area the size of Kansas each year.¹⁷ The world's burgeoning human population is producing a ballooning amount of organic refuse which will eventually have to be dealt with responsibly and constructively. It's not too soon to begin to understand human organic refuse materials as valuable resource materials begging to be recycled.

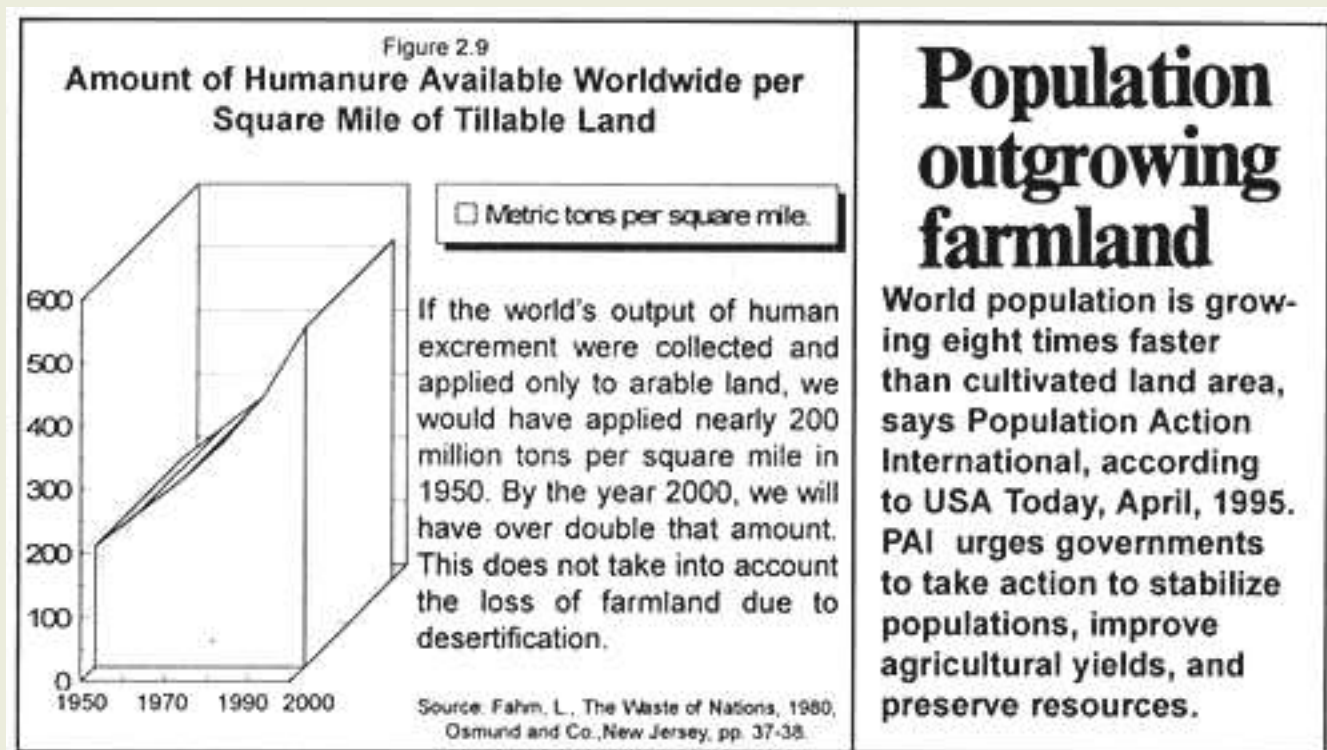

In 1950, the dollar value of the agricultural nutrients in the world's gargantuan pile of humanure was 6.93 billion dollars. In 2000, it will be worth 18.67 billion dollars (calculated in 1975 prices).¹⁸ This is money currently being flushed out somewhere into the environment where it shows up as pollution and landfill material. Every pipeline has an outlet somewhere; everything thrown "away" just moves from one place to another. Humanure and other organic refuse materials are no exception. Not only are we flushing "money" away, we're paying through the nose to do so. The cost is not only economic, it's environmental.

Source: *The Humanure Handbook*. Jenkins Publishing, PO Box 607, Grove City, PA 16127. To order, phone: 1-800-639-4099.

<http://www.jenkinspublishing.com/>

MENU: [HOME](#) » [Reconstruction](#) » [Recovery](#) » [Renewal](#) » [Survival](#) » [Humanure Content](#)

SOILED WATER

“The practice of injecting ‘waste’ products and toxic materials into the arterial waterways of Earth is comparable to the idea of using our own bloodstream as a disposal site for hazardous compounds.”

Keith Helmuth

The world is divided into two categories of people: those who shit in drinking water and those who don’t. We in the western world are in the former class. We defecate in water, usually purified drinking water. After polluting the water with our body’s excrements, we flush the once pure but now polluted water “away,” meaning we probably don’t know where it goes, nor do we care.

Water may cause wars as growth hits cities

The United Nations warned that water shortages created by the world's skyrocketing population and extravagant use could spark wars in the 21st century, according to Reuters News Service in 1996.

This ritual of defecating in water may be useful for maintaining a good standing within western culture. If you don’t deposit your feces into a bowl of drinking water on a regular basis, you may be considered a miscreant of sorts, perhaps uncivilized or dirty or poverty stricken. You may be seen as a non-conformist or a radical.

Yet, the discarding of human organic waste into water supplies obviously affects water quality. By defecating directly into water, we pollute it. Every time we flush a toilet, we launch five or six gallons of polluted water out into the world.¹⁹ That would be like defecating into a five gallon office water jug and then dumping it out before anyone could drink any of it. Then doing the same thing when urinating. Then doing it every day, numerous times. Then multiplying that by about 250 million people in the United States alone.

Even after the contaminated water is treated in wastewater treatment plants, it may still be polluted with excessive levels of nitrates, chlorine, pharmaceutical drugs, industrial chemicals, detergents, and other pollutants. This “treated” water is discharged directly into the environment.

A visit to the local library for a cursory review of sewage pollution incidents in the United States yielded the following:

- In the mid 1980s, the 2,207 publicly owned coastal sewage treatment works were discharging

3.619 *trillion* gallons per year of treated wastewater into the coastal environment.²⁰

- More than 2,000 beaches and bays in twelve states were closed in 1991 because of bacterial levels deemed excessive by health authorities.
- In 1991, the city of Honolulu faced penalties of about \$150 million for some 9,000 alleged sewage discharge violations that were recorded since 1985.²¹
- In 1991, Ohio Environmental Protection Agency fined Cincinnati's Metropolitan Sewer District \$170,000, the largest fine ever levied against an Ohio municipality, for failure to enforce its wastewater treatment program.²²
- In 1991, California was required to spend \$10 million to repair a leaking sewer pipeline that had forced the closure of twenty miles of southern California beaches. The broken pipeline was spilling up to 180 million gallons of sewage per day into the Pacific Ocean less than one mile offshore, resulting in a state of emergency in San Diego County. This situation was compounded by the fact that a recent heavy storm had caused millions of gallons of raw sewage from Mexico to enter the ocean from the Tijuana River.²³
- Environmental advocates sued the city of Portland, Oregon in 1991 for allegedly discharging untreated sewage as often as 3,800 times per year into the Willamette River and the Colombia Slough.²⁴
- In 1992, the US EPA sued the Los Angeles County Sanitation Districts for failing to install secondary sewage treatment at a plant which discharges wastewater into the Pacific Ocean, and for fourteen years of raw sewage spills and other discharges.²⁵
- In April of 1992, national environmental groups announced that billions of gallons of raw waste pour into lakes, rivers, and coastal areas each year from combined sewers. Such sewers carry storm water *and* sewage in the same pipe and tend to overflow during heavy rains, causing many cities to suffer from discharges of completely untreated sewage.²⁶ Combined sewers are found in about 900 US cities.²⁷
- In 1997, pollution caused at least 4,153 beach closings and advisories, 69% of which were caused by elevated bacterial pollution in the water. The elevated bacteria levels were primarily caused by storm-water runoff, raw sewage, and animal wastes entering the oceans. The sources of the pollution included inadequate and overloaded sewage treatment plants, sewage overflows from sanitary sewers and combined sewers, faulty septic systems, boating wastes, and polluted storm water from city streets and agricultural areas.²⁸

It is estimated that by 2010, at least half of the people in the US will live in coastal cities and towns, further exacerbating water pollution problems caused by sewage. The degree of beach pollution becomes a bit more personal when one realizes that current EPA recreational water cleanliness standards still allow 19 illnesses per 1,000 saltwater swimmers, and 8 per 1,000 freshwater swimmers.²⁹ Some of the diseases associated with swimming in wastewater-contaminated recreational waters include typhoid fever, salmonellosis, shigellosis, hepatitis, gastroenteritis, pneumonia, and skin infections.³⁰

If you don't want to get sick from the water you swim in, you can always follow another standard recommendation: don't submerge your head. Otherwise, you may end up like the swimmers in Santa Monica Bay. People who swam in the ocean there within 400 yards (four football fields) of a storm sewer drain had a 66% greater chance of developing a "significant respiratory disease" within the

following 9 to 14 days after swimming.³¹ This should come as no surprise when one takes into consideration the emergence of antibiotic-resistant bacteria. The use of antibiotics is so widespread that many people are now breeding antibiotic resistant bacteria in their intestinal systems. These bacteria are excreted into toilets and make their way to wastewater treatment plants where *the antibiotic resistance can be transferred to other bacteria*. Wastewater plants can then become breeding grounds for resistant bacteria, which are discharged into the environment through effluent drains. Why not just chlorinate the water before discharging it? It usually is chlorinated beforehand, but research has shown that chlorine seems to *increase* bacterial resistance to some antibiotics.³²

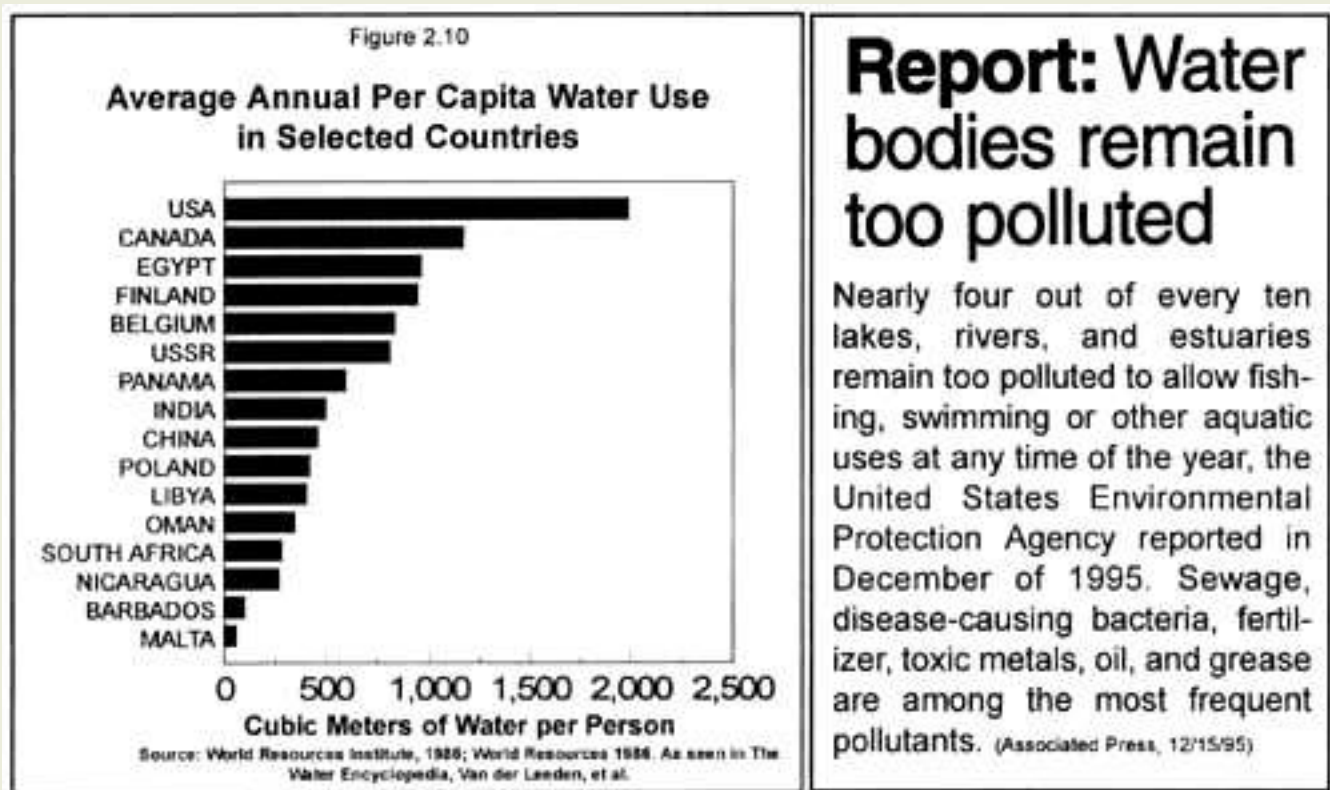

Report: Water bodies remain too polluted

Nearly four out of every ten lakes, rivers, and estuaries remain too polluted to allow fishing, swimming or other aquatic uses at any time of the year, the United States Environmental Protection Agency reported in December of 1995. Sewage, disease-causing bacteria, fertilizer, toxic metals, oil, and grease are among the most frequent pollutants. (Associated Press, 12/15/95)

Not worried about antibiotic resistant bacteria in your swimming area? Here's something else to chew on: 50 to 90% of the pharmaceutical drugs people take can be excreted down the toilet and out into the waterways *in their original or biologically active forms*. Furthermore, drugs that have been partially degraded before excretion can be converted to their original active form by environmental chemical reactions. Pharmaceutical drugs such as chemotherapy drugs, antibiotics, antiseptics, beta-blocker heart drugs, hormones, analgesics, cholesterol-lowering drugs, and drugs for regulating blood lipids have turned up in such places as tap water, groundwater beneath sewage treatment plants, lake water, rivers, and in drinking water aquifers. Think about *that* the next time you fill your glass with water.³³

Long Island Sound receives over a billion gallons of treated sewage every day, the waste of eight million people. So much nitrogen was being discharged into the Sound from the *treated* wastewater that it caused the aquatic oxygen to disappear, rendering the marine environment unsuitable for the fish that normally live there. The twelve treatment plants that were to be completed along the Sound by 1996 were expected to remove 5,000 pounds of nitrogen daily. Nitrogen is normally a soil nutrient and agricultural resource,

but instead, when flushed, it becomes a dangerous pollutant.³⁴

Previous to December 31, 1991, when disposing of US sewage sludge into the ocean was banned, much of the sewage sludge along coastal cities in the United States was simply dumped out at sea. Nevertheless, the city of New York was unable to meet that deadline and was forced to pay \$600 per dry ton to dump its sludge at the Deepwater Municipal Sludge Dump Site, 106 miles off the coast of New Jersey. Illegal dumping of sewage into the sea also continues to be a problem.³⁵ A bigger problem is what to do with sewage sludge now that landfill space is diminishing and sludge can no longer be dumped into the ocean.

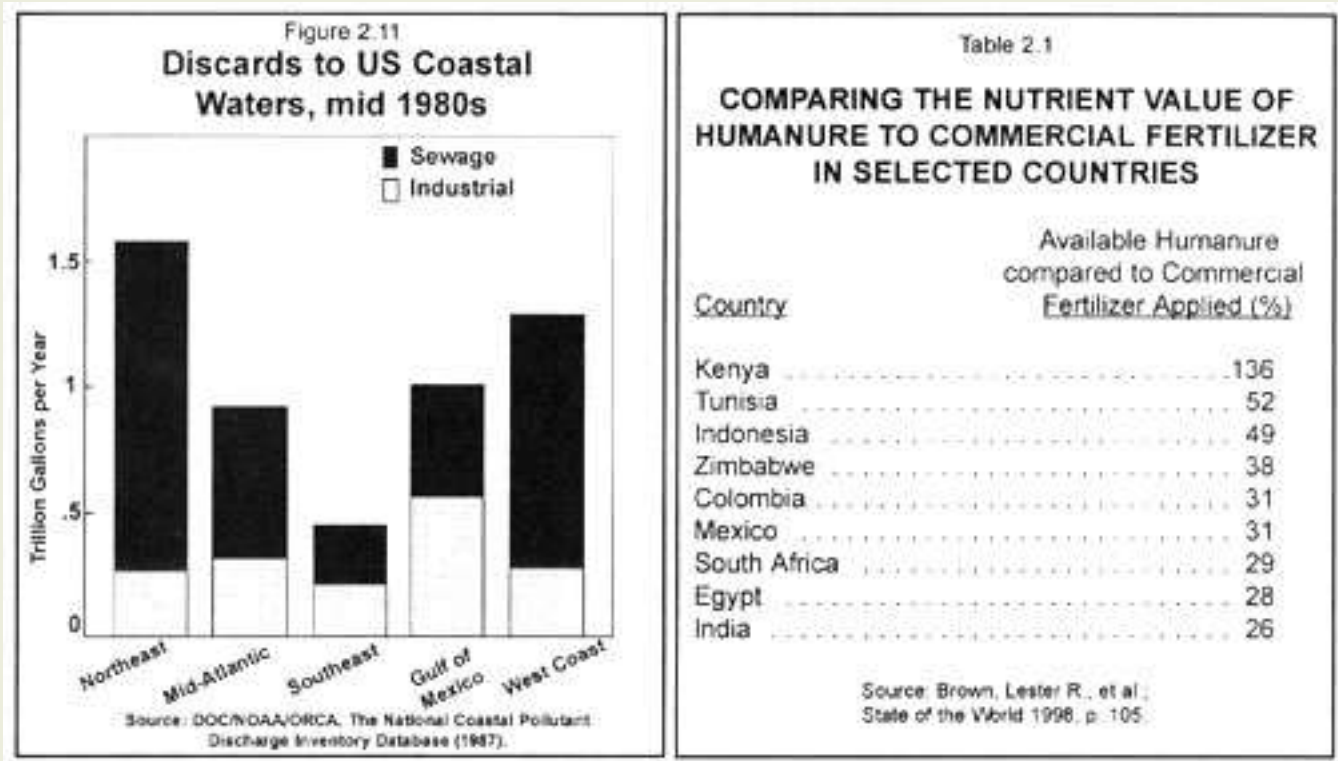

The dumping of sludge, sewage, or wastewater into nature's waterways invariably creates pollution. The impacts of polluted water are far-ranging, causing the deaths of 25 million people each year, three-fifths of them children.³⁶ Half of all people in developing countries suffer from diseases associated with poor water supply and sanitation.³⁷ Diarrhea, a disease associated with polluted water, kills six million children each year in developing countries, and it contributes to the death of up to 18 million people.³⁸ At the beginning of the 21st century, one out of four people in developing countries still lacked clean water, and two out of three lacked adequate sanitation.³⁹

Proper sanitation is defined by the World Health Organization as any excreta disposal facility that interrupts the transmission of fecal contaminants to humans.⁴⁰ This definition should be refined to include excreta *recycling* facilities, as excreta are valuable organic resources which should not be discarded. Compost toilet systems are now becoming internationally recognized as constituting "proper sanitation," and are becoming more and more attractive throughout the world due to their relatively low cost when

compared to waterborne waste systems and centralized sewers. In fact, compost toilet systems yield a dividend — *humus*, which allows such a sanitation system to yield a net profit, rather than being a constant financial drain (no pun intended).

FUN FACTS

about water



- If all the world's drinking water were put in one cubical tank, the tank would measure only 95 miles on each side.
- Number of people currently lacking access to clean drinking water: 1.2 billion.
- Percent of the world's households that must fetch water from outside their homes: 67
- Percent increase in the world's population by the middle of the 21st century: 100
- Percent increase in the world's drinking water supplies by the middle of the 21st century: 0
- Amount of water Americans use every day: 340 billion gallons.
- Number of gallons of water needed to produce a car: 100,000
- Number of cars produced every year: 50 million.
- Amount of water required by a nuclear reactor every year: 1.9 cubic miles.
- Amount of water used by nuclear reactors every year: the equivalent of one and a third Lake Eries.

Sources: Der Spiegel, May 25, 1992; and Annals of Earth, Vol. 8, Number 2, 1990; Ocean Arks International, One Locust Street, Falmouth, MA 02540.

The almost obsessive focus on flush toilets throughout the world is causing the problems of international sanitation to remain unresolved. Many parts of the world cannot afford expensive and water consumptive waste disposal systems. Or, in the words of Gary Gardner (Vital Signs 1998), “*The high costs leave developing countries spending less than a third of what they should in order to provide adequate sanitation, according to WHO. . . Prospects for providing universal access to sanitation are dismal in the near to medium term. . . Despite the attention focused on sanitation, governments have not demonstrated the will to meet this growing challenge.*” [41](#)

Illness related to polluted water afflicted 111,228 Americans from 1971-85. Forty-nine percent of these were caused by untreated or inadequately disinfected groundwater.⁴² Approximately 155 million people in the US obtain their drinking water from surface water sources.⁴³ Several American cities have suffered from

outbreaks of cryptosporidia (protozoa which cause severe diarrhea) since 1984. These protozoa are transmitted when people drink water contaminated by infected human and other animal feces. Outbreaks occurred in Braun Station, Texas, in 1984; in Carrollton, Georgia, in 1987; in Medford and Talent, Oregon, in 1992; and in Milwaukee, Wisconsin, in 1993. The outbreak in Carrollton, Georgia, afflicted 13,000 people, and was caused by contaminated water from a water treatment plant. Hundreds of thousands of people have been afflicted by this bug, for which there is no treatment. The illness runs its course in about fourteen days in healthy people, but can be deadly to people who have weak immune systems.⁴⁴

Modern toilets tax water

291 cities and towns in Japan face water shortages due to the spread of flush toilets, reported the Construction Ministry in April of 1998. Some cities have had to build dams to provide enough water to flush the increasingly popular toilets.

Paris

More than 1 billion people lack access to clean water

The U.N. International Conference on Water and Sustainable Development in 1998 reported that five to ten million people die each year as a result of drinking polluted water, while about 1.2 billion people lack access to clean water. "Fresh water needed for human needs is rapidly getting scarce," they reported.

Figure 2.12

US Water Withdrawals 1940-1995

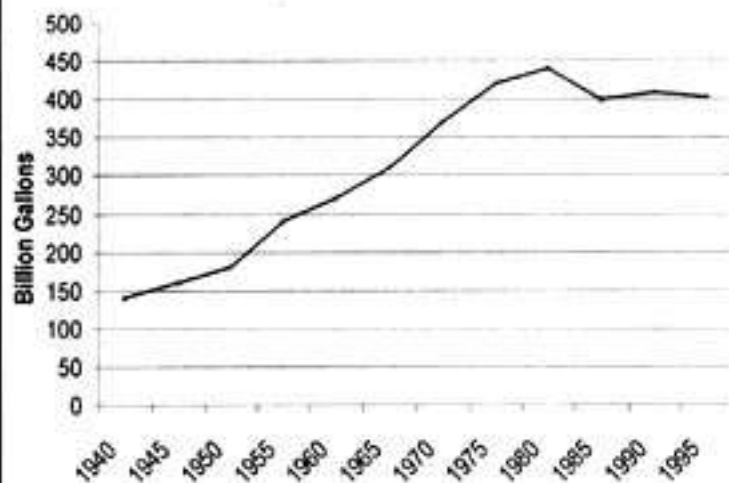

Source: Statistical Abstracts of the United States 1998, p. 240.

In 1995, there were still nearly 10 million people in the US connected to public drinking water supplies from surface sources that were not in compliance with federal standards for the removal of microorganisms. Furthermore, scientists estimate that up to seven million Americans still get sick annually from contaminated drinking water.⁴⁵



Sanitation problems could be avoided by composting, instead of discarding, humanure. Keeping fecal material out of the environment and out of streams, rivers, wells, and underground water sources eliminates the transmission of various diseases. Composting effectively converts fecal material into a hygienically safe humus, yet composting the humanure of municipal populations is not even being considered as an option in most of the western world.

Not only are we polluting our water, we're using it up, and flushing toilets is one way it's being wasted. Of 143 countries ranked for per capita water usage by the World Resources Institute, America came in at #2 using *188 gallons per person per day* (Bahrain was #1).⁴⁶

Water use in the US increased by a factor of 10 between 1900 and 1990, increasing from 40 billion gallons per day to 409 billion gallons per day.⁴⁷ The amount of water we Americans require overall (used in the finished products each of us consumes, plus washing and drinking water) amounts to a staggering 1,565 gallons per person per day, which is three times the rate in Germany or France.⁴⁸ This amount of water is equivalent to flushing our toilets 313 times every day, about once every minute and a half for eight hours straight. By some estimates, it takes one to two thousand tons of water to flush one ton of human waste.⁴⁹ Or, in the words of Carol Stoner, "*For one person, the typical five gallon flush contaminates each year about 13,000 gallons of fresh water to move a mere 165 gallons of body waste.*"⁵⁰ Not surprisingly, the use of groundwater in the United States exceeds replacement rates by 21 billion gallons a day.⁵¹

Source: *The Humanure Handbook*. Jenkins Publishing, PO Box 607, Grove City, PA 16127. To order, phone: 1-800-639-4099.

<http://www.jenkinspublishing.com/>

MENU: [HOME](#) » [Reconstruction](#) » [Recovery](#) » [Renewal](#) » [Survival](#) » [Humanure Content](#)

WASTE VS. MANURE

“Science now knows that the most fertilizing and effective manure is the human manure . . . Do you know what these piles of ordure are . . . All this is a flowering field, it is green grass, it is the mint and thyme and sage . . . it is the gilded wheat, it is the bread on your table, it is the warm blood in your veins.”

Victor Hugo

By dumping soil nutrients down the toilet, we increase our need for synthetic chemical fertilizers. Today, pollution from agriculture, caused from siltation (erosion) and nutrient runoff due to excessive or incorrect use of fertilizers,⁵² is now the “*largest diffuse source of water pollution*” in our rivers, lakes, and streams.⁵³ Chemical fertilizers provide a quick fix of nitrogen, phosphorous, and potassium for impoverished soils. However, it’s estimated that 25-85% of chemical nitrogen applied to soil and 15-20% of the phosphorous and potassium are lost to leaching, much of which can pollute groundwater.⁵⁴ This pollution shows up in small ponds which become choked with algae as a result of the unnatural influx of nutrients. In 1992, for example, the state of Florida was required to build some 35,000 acres of marshlands to filter farm-related runoff that was polluting the Everglades.⁵⁵ From 1950 to 1990, the global consumption of artificial fertilizers rose by 1000%, from 14 million tons to 140 million tons.⁵⁶ In 1997, US farmers used 20 million tons of synthetic fertilizers,⁵⁷ and half of all manufactured fertilizer ever made has been used just since 1982.⁵⁸ All the while, hundreds of millions of tons of compostable organic materials are generated in the US each year, and either buried in landfills, incinerated, or discharged into the environment as waste.

Nitrate pollution from excessive artificial fertilizer use is now one of the most serious water pollution problems in Europe and North America. Such pollution can cause cancer, and even brain damage or death in infants.⁵⁹ Most cases of infant poisoning occur when infant *formula* is made with nitrate polluted water.⁶⁰ A 1984 US EPA survey indicated that out of 124,000 water wells sampled, 24,000 had elevated levels of nitrates and 8,000 were polluted above health limits (10 mg/liter).⁶¹ In fact, a 1990 EPA survey indicated that 4.5 million Americans were potentially exposed to elevated levels of nitrates from drinking water wells alone.⁶²

The squandering of our water resources, and pollution from sewage and synthetic fertilizers results in part from the belief that humanure and food scraps are waste materials rather than recyclable natural resources. There is, however, an alternative. Humanure and food refuse can be composted and thereby rendered hygienically safe for agricultural or garden use. Much of the eastern world recycles humanure. Those parts of the world have known for millennia that humanure is a valuable resource which should be returned to the land, as any animal manure should.

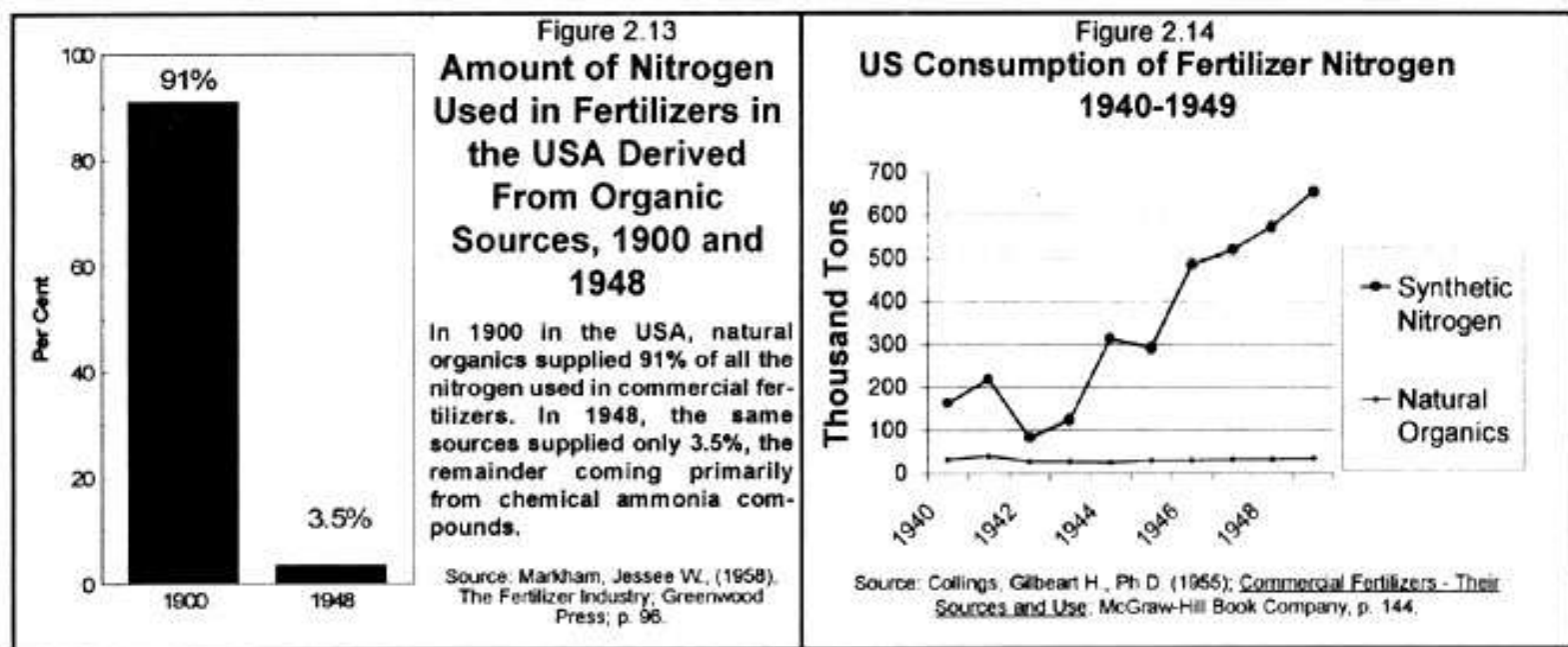

Farmers know that animal manure is valuable. They know that animal manures are digested crops, and that crops are soil, water, air, and sunshine converted into food, and the best way to use that manure is to put it back into the fields from where it originated. So the farmer loads up the manure spreader and flings the manure back onto the fields, thereby cleaning up his barn, saving himself lots of money on fertilizers, and keeping his soil healthy. Sounds reasonable enough. But what about human manure?

Humanure is a little bit different. It shouldn't simply be flung around in a fresh and repulsive state. It should undergo a process of bacterial digestion first, usually known as composting, in order to destroy possible pathogens. This is the missing link in the human nutrient recycling process. The process is similar to any animal's: a human grows food for herself on a field, or in a garden. The food is consumed and passes into the digestive system where the body extracts what it needs, rejects what it doesn't need at the time, or what it can't use, then excretes the rejected material.

At that moment, the digestive system is no longer responsible for the excretion. It's now time for the brain to go to work. The human mind has basically two choices — consider the excretion to be waste and try to get rid of it, or consider the excretion to be a resource which must be recycled. Either way, the body's excretion must be collected. As waste, the material must be dispensed with in a manner that is safe to human health and to the environment; as a resource, the humanure should be naturally recycled.

In some areas of the world, such as Asia, humanure may be applied raw to fields without being composted beforehand. Containers of human excrement are set outside residences in Asia to be picked up during the night and taken to the fields. The content of these containers is called, appropriately enough, "night soil." *That is NOT what this book is about.*

Raw humanure carries with it a significant potential for danger in the form of disease pathogens. These diseases, such as intestinal parasites, hepatitis, cholera, and typhoid are destroyed by composting, either when the retention time is adequate in a low temperature compost pile (usually



Properly composted humanure yields a rich, loamy, pleasant-smelling, hygienically safe soil-building material, here being applied to spring garden beds.

Shanghai, China, a city with an expected population of 14.2 million people in 2000,⁶³ produces an exportable surplus of vegetables in this manner.

considered to be two years) or when the composting process generates internal, biological heat (which can kill pathogens in a matter of minutes). Raw applications of humanure to fields, on the other hand, are not hygienically safe and can assist in the spread of various diseases which may be endemic to areas of Asia. Americans who have traveled to Asia tell of the “horrible stench” of night soil that wafts through the air when it is applied to fields. For these reasons, it is imperative that humanure always be composted before agricultural applications. Proper thermophilic (heat-producing) composting destroys possible pathogens and results in a pleasant-smelling material. Low temperature composting, given adequate time, will yield a compost also suitable for agricultural purposes.

At the very least, raw night soil applications to fields in Asia do return humanure to the land, thereby recovering a valuable resource which is then used to produce food for humans. *Composted* humanure is used in Asia as well. Cities in China, South Korea, and Japan recycle night soil around their perimeters in greenbelts where vegetables are grown.

In some areas of the world, such as Asia, humanure may be applied raw to fields without being composted beforehand. Containers of human excrement are set outside residences in Asia to be picked up during the night and taken to the fields. The content of these containers is called, appropriately enough, “night soil.” *That is NOT what this book is about.*

Humanure can also be used to feed algae which can, in turn, feed fish for aquacultural enterprises. In Calcutta, such an aquaculture system produces 20,000 kilograms of fresh fish daily.⁶⁴ The city of Tainan, Taiwan, is well known for its fish, which are farmed in over 6,000 hectares of fish farms fertilized by humanure. Here, humanure is so valuable that it’s sold on the black market.⁶⁵

*Source: The Humanure Handbook. Jenkins Publishing, PO Box 607, Grove City, PA 16127. To order, phone: 1-800-639-4099.
<http://www.jenkinspublishing.com/>*

MENU: [HOME](#) » [Reconstruction](#) » [Recovery](#) » [Renewal](#) » [Survival](#) » [Humanure Content](#)

RECYCLING HUMANURE

“We stand now where two roads diverge . . .the one ‘less traveled by’ offers our last, our only chance to reach a destination that assures the preservation of our Earth.”

Rachael Carson - *Silent Spring*

Humanure can be naturally recycled by feeding it to the organisms that crave it as food. These voracious creatures have been around for millions, and theoretically *billions* of years, and they’ve patiently waited for us humans to discover them. Mother Nature has seeded our excrements, as well as our garbage, with these “friends in small places,” who will convert our organic discards into a soil-building material right before our eyes. Invisible helpers, these creatures are too small to be seen by the human eye and are therefore called *microorganisms*. The process of feeding organic material to these microorganisms is called *composting*, and proper composting ensures the destruction of potential human pathogens (disease-causing microorganisms) in humanure. Composting also completely converts the humanure into a new, benign, pleasant-smelling, and beneficial substance called *humus*, which is then returned to the soil to enrich it and enhance plant growth.

Incidentally, *all* animal manures benefit from composting, as today’s farmers are now discovering. Compost doesn’t leach like raw manures do. Instead, it helps hold nutrients in soil systems. Composted manures also reduce plant disease and insect damage and allow for better nutrient management on farms. In fact, two tons of compost will yield far more benefits than five tons of manure.⁶⁶

Human manure can be mixed with other organic materials from human activity such as kitchen and food scraps, grass clippings, leaves, garden refuse, paper products, and sawdust. This mix of materials is necessary for proper composting to take place, and it will yield a soil additive suitable for food gardens as well as for agriculture.

One reason we humans have not “fed” our excrement to the appropriate organisms is because we didn’t know they existed. We’ve only learned to see and understand microscopic creatures in our recent past. We also haven’t had such a rapidly growing human population in the past, nor have we been faced with the dire environmental problems that threaten our species today, like buzzards circling an endangered animal.

It all adds up to the fact that the human species must inevitably evolve. Evolution means change, or as Rachel Carson stated almost four decades ago, we must realize that we are now standing at a fork in the

road. Change is often resisted, as old habits die hard, and flush toilets and bulging garbage cans represent well entrenched but non-sustainable habits that must be rethought and reinvented. You will not find profligate, wasteful, and polluting behavior taken for granted on “the road less traveled.”

Consumer cultures of today must evolve toward sustainability. This is a shift that will likely be fought tooth and nail by those powerful, non-sustainable industries that stand to lose profits, and by their paid spokespersons in the newspapers, radio, television, congresses, and senates of the world. Nevertheless, if we humans are half as intelligent as we think we are, we’ll join together cooperatively and eventually get our act together. In the meantime, there are those of you who are doing your share, shifting as you can, incrementally, but surely toward sustainable lifestyle choices. You are also further educating yourselves, as the reading of this book indicates, and perhaps realizing that nature holds many of the keys we need to unlock the door to a sustainable, harmonious existence on this planet. Composting is one of the keys that has been relatively recently discovered by the human race. Its utilization is now beginning to mushroom worldwide.

Source: The Humanure Handbook. Jenkins Publishing, PO Box 607, Grove City, PA 16127. To order, phone: 1-800-639-4099.

<http://www.jenkinspublishing.com/>

MENU: [HOME](#) » [Reconstruction](#) » [Recovery](#) » [Renewal](#) » [Survival](#) » [Humanure Content](#)

VINTAGE COMPOST

“One of the most fascinating aspects of composting is that it still retains elements of art . . . Producing good compost requires the same level of knowledge, engineering, skill, and art required for producing good wine.”

Roger Haug - The Practical Handbook of Compost Engineering

I first moved out to the country and started living off the land at the age of 22. Being fresh out of college, I knew little of practical value. One word that was a mystery to me was “compost”; another was “mulch.” Although I didn’t know what either of these were, I knew they had something to do with organic gardening, and that’s what I wanted to learn about. Of course, it didn’t take me long to understand mulch. Anyone who can throw a layer of straw on the ground can mulch. But compost took a bit longer.

My compost-learning experiences paralleled my winemaking experiences. Back then, having just graduated from the university, I had been conditioned to believe that the best way to learn was by using books. I had little awareness that instinct or intuition were powerful teachers. Furthermore, simple, natural processes had to be complicated with charts, graphs, measurements, devices, and all the wonderful tools of science, otherwise the processes had no validity. It was with this attitude that I set out to learn how to make wine.

The first thing I did was obtain a scientific book replete with charts, graphs, tables, and detailed step-by-step procedures. The book was titled something like “Foolproof Winemaking,” and the trick, or so the author said, was simply to follow his procedures *to the letter*. This was no simple feat. The most difficult part of the process was acquiring the list of chemicals which the author insisted must be used in the winemaking process. After much searching and travel, I managed to get the required materials. Then I followed his instructions *to the letter*. This lengthy process involved boiling sugar, mixing chemicals, and following laborious procedures. To make a long story short, I succeeded in making two kinds of wine. Both tasted like crap; one was bad and the other worse, and both had to be thrown out. I was very discouraged.

Soon thereafter, a friend of mine, Bob, decided he would try *his* hand at winemaking. Bob asked a vineyard worker to bring him five gallons of grape juice in a five gallon glass winemaking carboy. When the grape juice arrived, Bob took one look at the heavy carboy of juice and said, “*Buddy, would you mind carrying that into the basement for me?*” Which the worker obligingly did.

That was it. That utterance of eleven words constituted Bob’s entire effort at winemaking. Two seconds

of flapping jaws was the only work he did toward making that wine. He added no sugar, no yeast, did no racking, and certainly used no chemicals. He didn't do a damn thing to that five gallons of grape juice except abandon it in his basement with an airlock on top of it. Yet, a year later that carboy yielded the best homemade wine I had ever drank. It tasted good and had a heck of a kick to it.

I admit, there was an element of luck there, but I learned an important lesson about winemaking: the basic process is very simple — start with good quality juice and keep the air out of it. That simple, natural process can be easily ruined by too many complicated procedures, and heck, all those charts and graphs took the *fun* out of it. Making compost, I soon learned, was the same sort of phenomenon.

Source: The Humanure Handbook. Jenkins Publishing, PO Box 607, Grove City, PA 16127. To order, phone: 1-800-639-4099.

<http://www.jenkinspublishing.com/>

MENU: [HOME](#) » [Reconstruction](#) » [Recovery](#) » [Renewal](#) » [Survival](#) » [Humanure Content](#)

COMPOST DEFINED

BENEFITS OF COMPOST

ENRICHES SOIL

- Adds organic material
- Improves fertility and productivity
- Suppresses plant diseases
- Discourages insects
- Increases water retention
- Inoculates soil with beneficial microorganisms
- Reduces or eliminates fertilizer needs
- Moderates soil temperature

PREVENTS POLLUTION

- Reduces methane production in landfills
- Reduces or eliminates organic garbage
- Reduces or eliminates sewage

FIGHTS EXISTING POLLUTION

- Degrades toxic chemicals
- Binds heavy metals
- Cleans contaminated air
- Cleans stormwater runoff

RESTORES LAND

- Aids in reforestation
- Helps restore wildlife habitats
- Helps reclaim mined lands
- Helps restore damaged wetlands
- Helps prevent erosion on flood plains

DESTROYS PATHOGENS

- Can destroy human disease organisms
- Can destroy plant pathogens
- Can destroy livestock pathogens

According to the dictionary, compost is “*a mixture of decomposing vegetable refuse, manure, etc. for fertilizing and conditioning the soil.*” The Practical Handbook of Compost Engineering defines composting with a mouthful: “*The biological decomposition and stabilization of organic substrates, under conditions that allow development of thermophilic temperatures as a result of biologically produced heat, to produce a final product that is stable, free of pathogens and plant seeds, and can be beneficially applied to land.*”

The On-Farm Composting Handbook says that compost is “*a group of organic residues or a mixture of organic residues and soil that have been piled, moistened, and allowed to undergo aerobic biological decomposition.*” The Compost Council adds their two cents worth in defining compost: “*Compost is the stabilized and sanitized product of composting; compost is largely decomposed material and is in the process of humification (curing). Compost has little resemblance in physical form to the original material from which it is made.*” That last sentence should be particularly reassuring to the humanure composter.

J. I. Rodale states it a bit more eloquently: “*Compost is more than a fertilizer or a healing agent for the soil’s wounds. It is a symbol of continuing life . . . The compost heap is to the organic gardener what the typewriter is to the writer, what the shovel is to the laborer, and what the truck is to the truckdriver.*” ⁴

- Can destroy livestock pathogens

SAVES MONEY

- Can be used to produce food
- Can eliminate waste disposal costs
- Reduces the need for water, fertilizers, and pesticides
- Can be sold at a profit
- Extends landfill life by diverting materials
- Is a less costly bioremediation technique

Source: US EPA (October 1997). *Compost-New Applications for an Age-Old Technology*. EPA530-F-97-047. And author's experience.

In general, composting is a process managed by humans involving the cultivation of microorganisms that degrade organic matter in the presence of oxygen. When properly managed, the compost becomes so heavily populated with thermophilic microorganisms that it generates quite a bit of heat. Compost microorganisms can be so efficient at converting organic material into humus that the phenomenon is nothing short of miraculous.

Source: *The Humanure Handbook*. Jenkins Publishing, PO Box 607, Grove City, PA 16127. To order, phone: 1-800-639-4099.

<http://www.jenkinspublishing.com/>

MENU: [HOME](#) » [Reconstruction](#) » [Recovery](#) » [Renewal](#) » [Survival](#) » [Humanure Content](#)

NATURALCHEMISTRY

In the Middle Ages, alchemists sought to change base metals, such as lead, into gold. Old German folklore tells of a tale in which a dwarf named Rumpelstiltskin had the power to spin flax straw into precious metal. Somewhere in the psyche of the western mind was a belief that a substance of little or no worth could be transmuted by a miraculous process into something of priceless value. Our ancestors were right, but they were barking up the wrong tree. The miraculous process of *composting* will transmute humanure into humus. In this way, potentially dangerous waste materials become soil additives vital for human life.

Our ancestors didn't understand that the key to this alchemy was right at their fingertips. Had they better known and understood natural processes they could have provided themselves with a wealth of soil fertility and saved themselves the tremendous suffering caused by diseases originating from fecal contamination of the environment. For some reason, they believed that gold embodied value, and in pursuit of glittering riches they neglected the things of real value: health, vitality, self-sufficiency, and sustainability.

Our ancestors had little understanding of a vast, invisible world which surrounded them, a world of countless creatures so small as to be quite beyond the range of human sight. And yet, some of those microscopic creatures were already doing work for humanity in the production of foods such as beer, wine, cheese, or bread. Although *yeasts* have been used by people for centuries, *bacteria* have only become harnessed by western humanity in recent times. Composting is one means by which the power of microorganisms can be utilized in a big way for the betterment of humankind. Unfortunately, our ancestors didn't understand the role of microorganisms in the decomposition of organic matter, nor the efficacy of microscopic life in converting humanure, food scraps, and plant residues into soil. They didn't understand compost.

The composting of organic materials requires armies of bacteria. This microscopic force works so vigorously that it heats the material to temperatures hotter than are normally found in nature. Other micro and macro organisms such as fungi and insects help in the composting process, too. When the compost cools down, earthworms often move in and eat their fill of delicacies, their excreta becoming a further refinement of the compost.

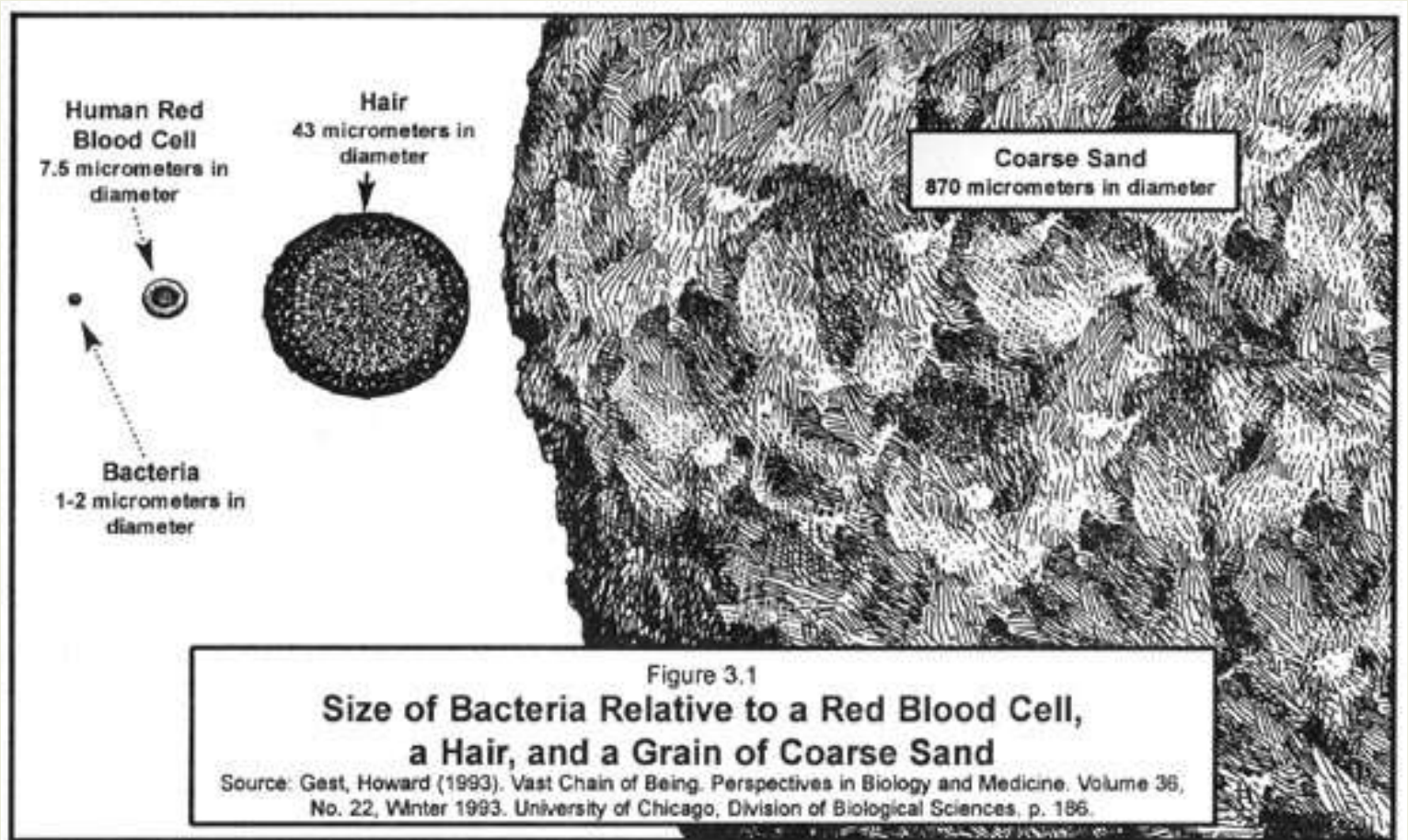

Successful composting requires the maintenance of an environment in which bacteria and fungi can thrive. This is also true for wine, except the microorganisms are yeast, not bacteria. Same for bread (yeast), beer (yeast), yogurt (bacteria), sauerkraut (bacteria), and cheese (bacteria); all of these things require the cultivation of microorganisms which will do the desired work. All of these things involve simple processes which, once you know the basic principles, are easy to carry out successfully. Sometimes bread doesn't rise, sometimes yogurt turns out watery, sometimes compost doesn't seem to turn out right. When this happens, a simple change of procedure will rectify the matter. Once you get the hang of it, you'd think even a chimpanzee could be trained to make compost.

Often, in our household, we have yogurt being made by billions of hard-working bacteria in a few quart mason jars beside the cookstove. At the same time, millions of yeast cells are cheerfully brewing beer in carboys in the back pantry, while millions more yeasts are happily brewing wine beside the beer. Sauerkraut is blithely fermenting in a crock behind the stove; bread is rising on the kitchen counter; and fungi are tirelessly forcing their fruits from oak logs on the sunporch. And then there's the compost pile. At times like these, I feel like a slave driver. But the workers never complain. Those little fellas work day and night, and they do a real nice job.

Source: *The Humanure Handbook*. Jenkins Publishing, PO Box 607, Grove City, PA 16127. To order, phone: 1-800-639-

MENU: [HOME](#) » [Reconstruction](#) » [Recovery](#) » [Renewal](#) » [Survival](#) » [Humanure Content](#)

SOLAR POWER IN A BANANNA PEEL

Organic refuse is stored solar energy. Every apple core or potato peel holds a tiny amount of stored energy, just like a piece of firewood, which is converted into useable plant food by the compost pile. Perhaps S. Sides of the *Mother Earth News* states it more succinctly: “*Plants convert solar energy into food for animals (ourselves included). Then the [refuse] from these animals along with dead plant and animal bodies, ‘lie down in the dung heap,’ are composted, and ‘rise again in the corn.’ This cycle of light is the central reason why composting is such an important link in organic food production. It returns solar energy to the soil. In this context such common compost ingredients as onion skins, hair trimmings, eggshells, vegetable parings, and even burnt toast are no longer seen as garbage, but as sunlight on the move from one form to another.*” ⁵

The organic material used to make compost could be considered anything on the Earth’s surface that had been alive, or from a living thing, such as manure, plants, leaves, sawdust, peat, straw, grass clippings, food scraps, and urine. A rule of thumb is that anything that will rot will compost, including such things as cotton clothing, wool rugs, rags, paper, animal carcasses, junk mail, and cardboard.

To compost means to convert organic material ultimately into soil or, more accurately, *humus*. Humus is a brown or black substance resulting from the decay of organic animal or vegetable refuse. It is a stable material that does not attract insects or nuisance animals. It can be handled and stored if necessary with no problem, and it is beneficial to the growth of plants. Humus holds moisture, and therefore increases the soil’s capacity to absorb and hold water. Compost is said to hold nine times its weight in water (900%), as compared to sand which only holds 2%, and clay 20%.⁶

Compost also adds slow-release nutrients essential for plant growth, creates air spaces in soil, helps balance the soil pH, darkens the soil (thereby helping it absorb heat), and supports microbial populations that add life to the soil. Nutrients such as nitrogen in compost are slowly released throughout the growing season, making them less susceptible to loss by leaching than the more soluble chemical fertilizers.⁷ Organic matter from compost enables the soil to immobilize and degrade pesticides, nitrates, phosphorous, and other things that can become pollutants. Compost binds pollutants in soil systems, reducing their leachability and absorption by plants.⁸

The building of topsoil by Mother Nature is a centuries long process. Adding compost to soil will help to quickly restore fertility that might otherwise take nature hundreds of years to replace. We humans deplete our soils in relatively short periods of time. By composting our organic refuse and returning it to the land, we can restore that fertility also in relatively short periods of time.

Fertile soil yields food that promotes good health. One group of people, the Hunzas of northern India, has been studied to a great extent. One man who studied them extensively, Sir Albert Howard, stated, “*When the health and physique of the various northern Indian races were studied in detail the best were those of the Hunzas, a hardy, agile, and vigorous people, living in one of the high mountain valleys of the Gilgit Agency . . . There is little or no difference between the kinds of food eaten by these hillmen and by the rest of northern India. There is, however, a great difference in the way these foods are grown . . . [T]he very greatest care is taken to return to the soil all human, animal and vegetable [refuse] after being first composted together. Land is limited: upon the way it is looked after, life depends.*” ⁹

Source: *The Humanure Handbook*. Jenkins Publishing, PO Box 607, Grove City, PA 16127. To order, phone: 1-800-639-4099.

<http://www.jenkinspublishing.com/>

MENU: [HOME](#) » [Reconstruction](#) » [Recovery](#) » [Renewal](#) » [Survival](#) » [Humanure Content](#)

MENU: [HOME](#) » [Reconstruction](#) » [Recovery](#) » [Renewal](#) » [Survival](#) » [Humanure Content](#)

GOMER THE PILE

There are several reasons for piling the composting material. A pile keeps the material from drying out or cooling down prematurely. A level of moisture (50-60%) is necessary for the microorganisms to work happily.¹⁰ A vertical stack prevents leaching and waterlogging, and holds heat in the pile. Vertical walls around a pile, especially if they're made of wood, or bales of straw, keep the wind off and will prevent one side of the pile (the windward side) from cooling down prematurely.

A neat, contained pile looks better. It looks like you know what you're doing, instead of looking like a garbage dump. A constructed compost bin also helps to keep out nuisance animals such as dogs.

A pile makes it easier to layer or cover the compost. When a smelly deposit is added to the top, it's a good idea to cover the raw refuse with clean organic material in order to eliminate unpleasant odors and to trap necessary oxygen in the pile. Therefore, if you're going to make compost, don't just fling it out in your yard in a heap. Construct a nice bin and do it right. That bin doesn't have to cost money; it can be made from recycled wood or cement blocks. Wood (not pressure-treated) may be preferable as it will insulate the pile and prevent heat loss and frost penetration. A compost bin doesn't have to be complicated in any way. It doesn't require electricity, technology, gimmicks, or doodads. You don't need shredders, choppers, grinders, or any machines whatsoever.

Compost *pits* are more likely to be used in dry, arid, or cool climates where conservation of moisture and temperature is imperative. The main disadvantage of pits is that they can become waterlogged in the event of an unexpected cloudburst, and excessive water will rob the pile of oxygen, a critical element in the process of decomposition by aerobic microorganisms. Therefore, when pits are used, a roof over them may be an advantage, and air channels may be necessary to allow oxygen to enter the compost.

Source: The Humanure Handbook. Jenkins Publishing, PO Box 607, Grove City, PA 16127. To order, phone: 1-800-639-4099.

<http://www.jenkinspublishing.com/>

MENU: [HOME](#) » [Reconstruction](#) » [Recovery](#) » [Renewal](#) » [Survival](#) » [Humanure Content](#)

FOUR NECESSITIES FOR GOOD COMPOST

MOISTURE

Compost must be kept moist. A dry pile will not work. When people who don't understand compost try to picture a humanure compost pile in someone's backyard, they imagine a giant heap of crap, draining all manner of noxious, smelly liquids out the bottom of the compost bin, and leaching into the groundwater. However, a compost pile is not a pile of garbage or waste. It's a living, breathing mass, a biological sponge which requires quite a bit of moisture. It's not likely to create a leaching problem unless subjected to very heavy rains while uncovered.

Why does compost require moisture? For one thing, composted materials shrink incredibly (40-80%),¹¹ mostly because of water loss. Compost can undergo considerable drying when wet materials are composted.¹² An initial moisture content of 65% can dwindle down to 20 to 30% in only a week, according to some researchers.¹³ It is more likely that one will have to *add* moisture to their compost than have to deal with excess moisture leaching from it.

The amount of moisture a compost pile receives or needs depends on the materials put into the pile and on the location of the pile. In Pennsylvania, there are about 36 inches (about one meter) of rainfall per year, and compost only needs watering during an unusual drought. According to Sir Albert Howard, watering a compost pile in England (where the annual rainfall is 24 inches) is also unnecessary. Nevertheless, the water required for compost-making may be around 200 to 300 gallons for each cubic yard of finished compost.¹⁴ This moisture requirement will be met when human urine is used in humanure compost and the top of the pile is open and receiving adequate rainfall. Additional water comes from moist organic materials such as food scraps. If adequate rainfall is not available and the contents of the pile are not moist, watering will be necessary to produce a moisture content equivalent to a squeezed-out sponge. Graywater from household drains or collected rainwater would suffice for this purpose.

OXYGEN

We want to cultivate *aerobic* bacteria in the compost pile to ensure thermophilic decomposition. This is done by adding bulky materials to the compost pile in order to trap interstitial air spaces. Aerobic bacteria will suffer from a lack of oxygen if drowned in liquid, which is a common problem with commercial and home made composting toilets when improperly managed.

Bacterial decomposition can also take place anaerobically, but this is a slower, cooler process, which can, quite frankly, stink. Anaerobic odors can smell like rotten eggs (caused by hydrogen sulfide), sour milk (caused by butyric acids), vinegar (acetic acids), vomit (valeric acids), and putrefaction (alcohols and phenolic compounds).¹⁵ Obviously, we want to avoid such odors by maintaining an aerobic compost pile.



Figure 3.2: The author probing a humanure compost pile in late winter.

This compost had not yet become thermophilically active.

Of the two thermometers, one has a long probe and the other a short one.

PHOTO BY JEANINE JENKINS

Good, healthy, aerobic compost need not offend one's sense of smell. However, in order for this to be true, a simple rule must be followed: *anything added to the compost that smells bad must be covered with a clean, organic material*. This means you must cover the deposits in your compost toilet and on your compost pile. When you defecate or urinate in your toilet, cover it. Use sawdust, use peat, use clean soil, use leaves, but keep it covered. Then there will be no odor. When you deposit smelly manure on your compost pile, cover it. Use weeds, use straw, use hay, whatever you can get your hands on (especially bulky material which will trap oxygen in the compost), but keep it covered. That's the simple secret to the odor issue.

TEMPERATURE

Dehydration will cause the compost microorganisms to stop working. So will freezing. Compost piles will not work if frozen, which often occurs during the cold winters of the north. However, don't despair, the microorganisms will wait until the temperature rises and then they'll thaw out and, once again, work feverishly. You can continue to add to an outdoor compost pile all winter, even when the pile is frozen solid as a rock. The freezing stage helps to destroy some potential pathogens and, after the thaw, the pile works up a steam as if nothing happened.

BALANCED DIET

A good carbon-nitrogen balance (a good blend of materials) is required for a nice, hot compost pile. Since most of the materials commonly added to a compost pile are very high in carbon, this means that a source of nitrogen must be incorporated into the blend of composting ingredients. This isn't as difficult as it may seem. You can carry bundles of weeds to your compost pile, add hay, straw, leaves, and garbage, but you'll still need one thing: nitrogen. Of course the solution is simple — add manure. Where can you get manure? From an animal. Where can you find an animal? *Look in a mirror.*

Table 3.1
NITROGEN LOSS AND CARBON/NITROGEN RATIO

Initial C/N Ratio	Nitrogen Loss (%)
20.0	38.8
20.5	48.1
22.0	14.8
30.0	0.5
35.0	0.5
76.0	-8.0

Source: Gotaas, *Composting*, 1956, p. 92

Rodale states in *The Complete Book of Composting* that the average gardener may have difficulty in obtaining manure for the compost heap, but with “a little ingenuity and a thorough search,” it can be found. A gardener in the book testifies that when he gets “all steamed up to build myself a good compost pile, there has always been one big question that sits and thumbs its nose at me: *Where am I going to find the manure? I am willing to bet, too, that the lack of manure is one of the reasons why your compost pile is not the thriving humus factory that it might be.*”

Hmmm. WHERE can a large animal like a human being find manure? Gee, that's a tough one. Let's think real hard about that one. Perhaps with a little “ingenuity and a thorough search” we can come up with a source. Where IS that mirror, anyway?

Might be a clue there.

Source: *The Humanure Handbook*. Jenkins Publishing, PO Box 607, Grove City, PA 16127. To order, phone: 1-800-639-4099.

<http://www.jenkinspublishing.com/>

MENU: [HOME](#) » [Reconstruction](#) » [Recovery](#) » [Renewal](#) » [Survival](#) » [Humanure Content](#)

THE CARBON/NITROGEN RATIO

Table 3.2

CARBON / NITROGEN RATIOS

<u>Material</u>	<u>%N</u>	<u>C/N Ratio</u>
Activated Sludge	5-6	6
Amaranth	3.6	11
Apple Pomace	1.1	13
Blood	10-14	3
Bread	2.10	---
Cabbage	3.6	12
Cardboard	0.10	400-563
Coffee Grounds	---	20
Cow Manure	2.4	19
Corn Cobs	0.6	56-123
Corn Stalks	0.6-0.8	60-73
Cottonseed Meal	7.7	7
Cranberry Plant	0.9	61
Farmyard Manure	2.25	14
Fern	1.15	43
Fish Scrap	10.6	3.6
Fruit	1.4	40
Garbage (Raw)	2.15	15-25
Grass Clippings	2.4	12-19
Hardwood Bark	0.241	223
Hardwoods (Avg.)	0.09	560
Hay (General)	2.10	---

One way to understand the blend of ingredients in your compost pile is by using the C/N ratio (carbon/nitrogen ratio). Quite frankly, the chance of the average person measuring and monitoring the carbon and nitrogen quantities of their organic material is almost nil. This is like making wine the “foolproof” way. If composting requires this sort of drudgery, no one would do it.

However, I’ve found that by using all of the organic refuse my family produces, including humanure, urine, food refuse, weeds from our garden, rotting sawdust (which is hauled in), grass clippings, and maybe a little straw or hay now and then, we get the right mix of carbon and nitrogen for successful thermophilic composting. We do not compost newspapers or other burnable materials, we recycle them or burn them in our woodstove.

Nevertheless, no discussion of composting is complete without a review of the subject of the carbon/nitrogen ratio. A good C/N ratio for a compost pile is between 20/1 and 35/1.¹⁶ That’s 20 parts of carbon to one part of nitrogen, up to 35 parts of carbon to one part of nitrogen. Or, for simplicity, you can figure on shooting for an optimum 30/1 ratio.

Hay (legume)	2.5	16
Hen Manure	8	6-15
Horse Manure	1.6	25-30
Humanure	5-7	5-10
Leaves	0.9	54
Lettuce	3.7	---
Meat Scraps	5.1	---
Mussel Residues	3.6	2.2
Mustard	1.5	26
Newsprint	0.06-0.14	398-852
Oat Straw	1.05	48
Olive Husks	1.2-1.5	30-35
Onion	2.65	15
Paper	---	100-800
Pepper	2.6	15
Pig Manure	3.1	14
Potato Tops	1.5	25
Poultry Carcasses	2.4	5
Purslane	4.5	8
Raw Sawdust	0.11	511
Red Clover	1.8	27
Rice Hulls	0.3	121
Rotted Sawdust	0.25	200-500
Seaweed	1.9	19
Sewage Sludge	2-6.9	5-16
Sheep Manure	2.7	16
Shrimp Residues	9.5	3.4
Slaughter Waste	7-10	2-4
Softwood Bark	0.14	496
Softwoods (Average)	0.09	641
Soybean Meal	7.2-7.6	4-6
Straw (General)	0.7	80

For microorganisms, carbon is the basic building block of life and is a source of energy, but nitrogen is also necessary for such things as proteins, genetic material, and cell structure. Microorganisms that digest compost need about 30 parts of carbon for every part of nitrogen they consume. That's a balanced diet for them. If there's too much nitrogen, the microorganisms can't use it all and the excess is lost in the form of smelly ammonia gas. Nitrogen loss due to excess nitrogen in the pile (a low C/N ratio) can be over 60%. At a C/N ratio of 30 or 35 to 1, only one half of one percent of the nitrogen will be lost (see Table 3.1). That's why you don't want too much nitrogen (manure, for example) in your compost: the nitrogen will be lost in the air in the form of ammonia gas, and nitrogen is too valuable for plants to allow it to escape into the atmosphere.¹⁷

That's also why humanure and urine alone *will not* compost. They contain too much nitrogen and not enough carbon, and microorganisms, like humans, gag at the thought of eating it. Since there's nothing worse than several billion gagging microorganisms, a carbon-based material must be added to the humanure in order to make it appealing. Plant cellulose is a carbon-based material, and therefore plant by-products such as hay, straw, weeds, or even paper products if ground to the proper consistency, will provide the needed carbon. Kitchen food scraps are generally C/N balanced, and they can readily be added to humanure compost. Sawdust (preferably *not* kiln-dried) is a good carbon material for balancing the nitrogen of humanure. Sawmill sawdust has a moisture content of 40-65%, which is good for compost.¹⁸ Lumber yard sawdust, on the other hand, is kiln-dried and is biologically inert due to the dehydration. Therefore, it is not as desirable in compost unless rehydrated with water (or urine) before

Straw (Oat)	0.9	60
Straw (Wheat)	0.4	80-127
Telephone Books	0.7	772
Timothy Hay	0.85	58
Tomato	3.3	12
Turkey Litter	2.6	16
Turnip Tops	2.3	19
Urine	15-18	0.8
Vegetable Produce	2.7	19
Water Hyacinth	---	20-30
Wheat Straw	0.3	128-150
Whole Carrot	1.6	27
Whole Turnip	1.0	44



Sources: Gotaas, Harold B. (1956). *Composting - Sanitary Disposal and Reclamation of Organic Wastes* (p.44). World Health Organization, Monograph Series Number 31. Geneva. and Rynk, Robert, ed. (1992). *On-Farm Composting Handbook*. Northeast Regional Agricultural Engineering Service. Ph: (607) 255-7654. pp. 106-113. Some data from Biocycle, *Journal of Composting and Recycling*, July 1998, p.18, 61, 62; and January 1998, p.20.

being added to the compost pile. Also, lumber yard sawdust nowadays can often be contaminated with wood preservatives such as chromated copper arsenate (from “pressure treated lumber”). Both chromium and arsenic are human carcinogens, so it would be wise to avoid such materials.

The C/N ratio of humanure is between five and ten, averaging eight parts of carbon to one part of nitrogen. Therefore, you need to add a fair amount of carbon to humanure to get a 30/1 ratio (see Tables 3.2 and 3.3). I’ve found that the proper balance is obtained by putting all the organic refuse of my household (excluding printed material and burnable paper packaging) in the same compost pile, layered with weeds, straw, hay, leaves, or whatever organic material happens to be within reach. The humanure, when collected in the toilet, is covered with clean, partially rotted, hardwood or softwood sawdust, or another carbon-based material such as peat moss or rice hulls. This carbonaceous “cover material” not only balances the nitrogen, but also prevents odors remarkably well.

It has recently become popular for backyard composters to refer to organic materials as “browns” and “greens.” The browns (such as dried leaves) supply carbon, and the greens (such as fresh grass clippings) supply nitrogen. It’s recommended that two to three volumes of

browns be mixed with one volume of greens in order to produce a mix with the correct C/N ratio for composting.¹⁹ However, since most backyard composters are not humanure composters, many backyard composters have a pile of material sitting in their compost bin showing very little activity. What is usually missing is nitrogen as well as moisture, two critical ingredients to any compost pile. Both of these are provided by humanure when collected with urine and a carbon cover material. The humanure mix can be quite brown, but is also quite high in nitrogen. So the “brown/green” approach doesn’t really work, nor is it necessary, when composting humanure along with other household organic material. Let’s face it, humanure composters are in a class by themselves.

Table 3.3 COMPOSITION OF HUMANURE		Table 3.4 DECOMPOSITION RATES OF SELECTED SAWDUSTS	
Fecal Material: 0.3-0.6 pounds per person per day (135-270 grams), wet weight.		SAWDUST	RELATIVE DECOMPOSITION RATE
Organic Matter (dry weight)	88-97%	Red Cedar	3.9
Moisture Content	66-80%	Douglas Fir	8.4
Nitrogen	5-7%	White Pine	9.5
Phosphorous	3-5.4%	Western White Pine	22.2
Potassium	1-2.5%	Average of all softwoods	12.0
Carbon	40-55%	Chestnut	33.5
Calcium	4-5%	Yellow Poplar	44.3
C/N Ratio	5-10	Black Walnut	44.7
Urine: 1.75-2.25 pints per person per day (1.0-1.3 liters)		White Oak	49.1
Moisture	93-96%	Average of all hardwoods	45.1
Nitrogen	15-19%	Wheat straw	54.6
Phosphorous	2.5-5%	The lower the number, the slower the decomposition rate. According to this data, hardwood sawdust decomposes faster than softwood sawdust.	
Potassium	3-4.5%	Source: Haug, Roger T. (1993). <i>The Practical Handbook of Compost Engineering</i> . CRC Press, Inc., 2000 Corporate Blvd. N.W., Boca Raton, FL 33431 USA, as reported in <i>Biocycle - Journal of Composting and Recycling</i> , December, 1998, p. 19.	
Carbon	11-17%		
Calcium	4.5-6%		
Source: Gotaas, Composting, (1956), p. 35			

Source: *The Humanure Handbook*. Jenkins Publishing, PO Box 607, Grove City, PA 16127. To order, phone: 1-800-639-4099.

<http://www.jenkinspublishing.com/>

MENU: [HOME](#) » [Reconstruction](#) » [Recovery](#) » [Renewal](#) » [Survival](#) » [Humanure Content](#)

THERMOPHILIC MICROORGANISMS

A wide array of microorganisms live in a compost pile. Bacteria are especially abundant and are usually divided into several classes based upon the temperatures at which they grow best. The low temperature bacteria are the *psychrophiles*, which can grow at temperatures down to -10°C , but whose optimum temperature is 15°C (59°F) or lower. The *mesophiles* live at medium temperatures, $20\text{-}45^{\circ}\text{C}$ ($68\text{-}113^{\circ}\text{F}$), and include human pathogens. *Thermophiles* thrive above 45°C (113°F), and some live at or even above the boiling point of water.

Strains of thermophilic bacteria have been identified with optimum temperatures ranging from 55°C to an incredible 105°C (above the boiling point of water), and many temperatures in between.²⁰ The strains that survive at extremely high temperatures are called, appropriately enough, extreme thermophiles, or hyperthermophiles, and have a temperature optimum of 80°C (176°F) or higher. Thermophilic bacteria occur naturally in hot springs, tropical soils, compost heaps, in your excrement, in hot water heaters (both domestic and industrial), and in your garbage, to name a few places.²¹

Thermophilic bacteria were first isolated in 1879 by Miquel, who found bacteria capable of developing at 72°C (162°F). He found these bacteria in soil, dust, *excrement*, sewage, and river mud. It wasn't long afterward that a variety of thermophilic bacteria were discovered in soil — bacteria that readily thrived at high temperatures, but not at room temperature. These bacteria are said to be found in the sands of the Sahara Desert, but not in the soil of cool forests. Composted or manured garden soils may contain 1-10 percent thermophilic types of bacteria, while field soils may have only 0.25% or less. Uncultivated soils may be entirely free of thermophilic bacteria.²²

Table 3.5
COMPARISONS OF DIFFERENT TYPES OF MANURES

<u>Manure</u>	<u>% Moisture</u>	<u>% Nitrogen</u>	<u>% Phosphorous</u>	<u>% Potassium</u>
Human	66-80	5-7	3-5.4	1.0-2.5
Cattle	80	1.67	1.11	0.56
Horse	75	2.29	1.25	1.38
Sheep	68	3.75	1.87	1.25
Pig	82	3.75	1.87	1.25
Hen	56	6.27	5.92	3.27
Pigeon	52	5.68	5.74	3.23
Sewage	---	5-10	2.5-4.5	3.0-4.5

Source: Gotaas, Harold B. (1956). *Composting - Sanitary Disposal and Reclamation of Organic Wastes*. pp. 35, 37, 40.
World Health Organization, Monograph Series Number 31, Geneva.

Thermophiles are responsible for the spontaneous heating of hay stacks which can cause them to burst into flame. Compost itself can sometimes spontaneously combust. This occurs in larger piles (usually over 12 feet high) that become too dry (between 25% and 45% moisture) and overheat.²³ Spontaneous fires have started at two American composting plants (Schenectady and Cape May) due to excessively dry compost. According to the EPA, fires can start at surprisingly low temperatures (194°F) in too-dry compost, although this is not a problem for the back yard composter. When growing on bread, thermophiles can raise the temperature of the bread to 74°C (165°F). Heat from bacteria also warms germinating seeds, as seeds in a sterile environment are found to remain cool while germinating.²⁴

Both mesophilic and thermophilic microorganisms are found widely distributed in nature, and are commonly resident on food material, garbage, and manures. This is not so surprising when considering mesophiles, because the temperatures they find to be optimum for their reproduction are commonly found in nature. These temperatures include those of warm-blooded animals, which excrete mesophiles in their stools in huge numbers.

A mystery presents itself, on the other hand, when we consider *thermophilic* microorganisms, since they prefer living at temperatures not commonly found in nature, but in hot springs, water heaters, and compost piles. Their preferences for hot temperatures has given rise to some speculation about their evolution. One theory suggests that the thermophiles were among the first living things on this planet, developing and evolving during the primordial birthing days of Earth, when surface temperatures were quite hot. They have thus been called the “Universal Ancestor.” Estimated at 3.6 billion years old, they are said to be so abundant as to “*comprise as much as half of all living things on the planet.*”²⁵ This is a rather startling concept, as it would mean that thermophilic organisms are perhaps more ancient than anything else alive. Their age would make dinosaurs look like new born babes, still wet behind the ears (however extinct). Of course, we humans, in comparison, have just shown up on the Earth. Thermophiles could, therefore, be the common ancestral organism of all life forms on our planet.

Just as startling is the concept that thermophiles, despite their need for a hot environment, are found everywhere. They’re lingering in your garbage, and in your stool, and have been since we humans first began to crawl on this planet. They have quietly waited since the beginning of time, and we haven’t been aware of them until recently. Researchers insist that thermophiles do not grow at ambient or room temperatures.²⁶ Yet, like a miracle, when we collect our organic refuse in a tidy pile, the thermophiles seem to be sparked out of their dormant slumber to work furiously toward creating the primordial heat they so long for. And they succeed — if we help them by creating compost piles. They reward us for our help by converting our garbage and other organic discards into life-sustaining earth.

The knowledge of living creatures incomprehensibly ancient, so small as to be entirely invisible, thriving at temperatures hotter than those normally found in nature, and yet found alive everywhere, is remarkable enough. The fact that they are so willing to work for our benefit, however, is rather humbling.

By some estimates, humanure contains up to 1,000,000,000,000 (a trillion) bacteria per gram.²⁷ These

are, of course, mixed species, and not by any means all thermophiles. A trillion bacteria is equivalent to the entire human population of the Earth multiplied by 166, and all squeezed into a gram of organic material. These microbiological concepts of size and number are difficult for us humans to grasp. Ten people crammed into an elevator we can understand. A trillion living organisms in a teaspoonful of crap is a bit mind-boggling.

Has anyone identified the species of microorganism that heats up compost? Actually, a large variety of species, a *biodiversity*, is critical to the success of compost. However, the thermophilic stage of the process is dominated by thermophilic bacteria. One examination of compost microorganisms at two compost plants showed that most of the bacteria (87%) were of the genus *Bacillus*, which are bacteria that form spores,²⁸ while another researcher found that above 65°C, the organisms in the compost were almost purely *Bacillus stearothermophilus*.²⁹

Source: *The Humanure Handbook*. Jenkins Publishing, PO Box 607, Grove City, PA 16127. To order, phone: 1-800-639-4099.

<http://www.jenkinspublishing.com/>

MENU: [HOME](#) » [Reconstruction](#) » [Recovery](#) » [Renewal](#) » [Survival](#) » [Humanure Content](#)

FOUR STAGES OF COMPOST

There is a huge difference between a backyard humanure composter and a municipal composter. Municipal composters handle large batches of organic materials all at once, while backyard composters continuously produce a small amount of organic material every day. Municipal composters, therefore, are “batch” composters, while backyard composters tend to be “continuous” composters. When organic material is composted in a batch, four stages of the composting process are apparent. Although the same phases occur during continuous composting, they are not as apparent as they are in a batch, and, in fact, they may be occurring concurrently rather than sequentially.

The four phases include: 1) the mesophilic phase; 2) the thermophilic phase; 3) the cooling phase; and 4) the curing phase.

Compost bacteria combine carbon with oxygen to produce carbon dioxide and energy. Some of the energy is used by the microorganisms for reproduction and growth, the rest is given off as heat. When a pile of organic refuse begins to undergo the composting process, mesophilic bacteria proliferate, raising the temperature of the composting mass up to 44°C (111°F). This is the first stage of the composting process. These mesophilic bacteria can include *E. coli* and other bacteria from the human intestinal tract, but these soon become increasingly inhibited by the temperature, as the thermophilic bacteria take over in the transition range of 44°C-52°C (111°F-125.6°F).

This begins the second stage of the process, when thermophilic microorganisms are very active and produce a lot of heat. This stage can then continue up to about 70°C (158°F),³⁰ although such high temperatures are neither common nor desirable in backyard compost. This heating stage takes place rather quickly and may last only a few days, weeks, or months. It tends to remain localized in the upper portion of a backyard compost bin where the fresh material is being added, whereas in batch compost, the entire composting mass may be thermophilic all at once.

After the thermophilic heating period, the humanure will appear to have been digested, but the coarser organic material will not. This is when the third stage of composting, the cooling phase, takes place. During this phase, the microorganisms that were chased away by the thermophiles migrate back into the compost and get back to work digesting the more resistant organic materials. Fungi and macroorganisms such as earthworms and sowbugs that break the coarser elements down into humus also move back in.

After the thermophilic stage has been completed, only the readily available nutrients in the organic material have been digested. There’s still a lot of food in the pile, and a lot of work to be done by the

creatures in the compost. It takes many months to break down some of the more resistant organic material in compost such as “lignin” which comes from wood materials. Like humans, trees have evolved with a skin that is resistant to bacterial attack, and in a compost pile those lignins resist breakdown by thermophiles. However, other organisms, such as fungi, can break down lignin, given enough time; since they don’t like the heat of thermophilic compost, they simply wait for things to cool down before beginning their job.

The final stage of the composting process is called the curing, aging, or maturing stage, and it is a long and important one. Commercial composting professionals often want to make their compost as quickly as possible, usually sacrificing the compost’s curing time. One municipal compost operator remarked that if he could shorten his compost time to four months, he could make three batches of compost a year instead of only the two he was then making, thereby increasing his output by 50%. Municipal composters see truckloads of compost coming in to their facilities daily, and they want to make sure they don’t get inundated with organic material waiting to be composted. Therefore, they feel a need to move their material through the composting process as quickly as possible to make room for the new stuff coming in. Household composters don’t have that problem, although there seem to be plenty of backyard composters who are obsessed with making compost as quickly as possible. However, the curing, aging, or maturing of the compost is a critically important stage of the compost-making process. And, as in wine-making, an important element to figure into the equation is *patience*.

A long curing period (e.g., a year after the thermophilic stage) adds a safety net for pathogen destruction. Many human pathogens only have a limited period of viability in the soil, and the longer they are subjected to the microbiological competition of the compost pile, the more likely they will die a swift death.

Immature compost can be harmful to plants. Uncured compost can produce phytotoxins (substances toxic to plants), can rob the soil of oxygen and nitrogen, and can contain high levels of organic acids. So relax, sit back, put your feet up, and let your compost reach full maturity *before* you even think about using it.

Source: The Humanure Handbook. Jenkins Publishing, PO Box 607, Grove City, PA 16127. To order, phone: 1-800-639-4099.

<http://www.jenkinspublishing.com/>

MENU: [HOME](#) » [Reconstruction](#) » [Recovery](#) » [Renewal](#) » [Survival](#) » [Humanure Content](#)

COMPOST BIODIVERSITY

Compost is normally populated by three general categories of microorganisms: bacteria, actinomycetes, and fungi (see Figure 3.3 and Table 3.6). It is the bacteria, and specifically the thermophilic bacteria, that create the heat of the compost pile.

Although considered bacteria, actinomycetes are effectively intermediate between bacteria and fungi because they look similar to fungi and have similar nutritional preferences and growth habits. They tend to be more commonly found in the later stages of the compost, and are generally thought to follow the thermophilic bacteria in succession. They, in turn, are followed predominantly by fungi during the last stages of the composting process.

There are at least 100,000 species of fungi known, the overwhelming majority of them being microscopic.³¹ Most fungi cannot grow at 50°C (it's too hot) although some are heat tolerant (thermophilic fungi). Fungi tend to be absent in compost above 60°C, and actinomycetes tend to be absent above 70°C. Above 82°C biological activity effectively stops (extreme thermophiles are not found in compost).³²

To get an idea of the microbial diversity normally found in nature, consider this: a teaspoon of native grassland soil contains 600-800 million bacteria comprising 10,000 species, plus perhaps 5,000 species of fungi, the mycelia of which could be stretched out for several miles. In the same teaspoon, there may be 10,000 individual protozoa of perhaps 1,000 species, plus 20-30 different nematodes from as many as 100 species. Sounds crowded to me. Obviously, good compost will reinoculate depleted, sanitized, chemicalized soils with a wide variety of beneficial microorganisms (see Figures 3.4 and 3.5).³³

COMPOST MICROORGANISMS "SANITIZE" COMPOST

One of the most frequent questions asked of me is, "How do you know that ALL parts of your compost have been subjected to high enough temperatures to kill ALL potential pathogens?" The answer should be obvious: you don't. You never will. Unless, of course, you examine every cubic centimeter of your compost for pathogens in a laboratory. This would probably cost many thousands of dollars, which would make your compost the most expensive in history.

It's not *only* the heat of the compost that causes the destruction of human, animal, and plant pathogens, it's a combination of factors including:

- competition for food from compost microorganisms;
-
- inhibition and antagonism by compost microorganisms;
-
- consumption by compost organisms;
-
- biological heat generated by compost microorganisms; and
-
- antibiotics produced by compost microorganisms.

For example, when bacteria were grown both in an incubator and separately in compost at 50°C, they died in the compost after only seven days, but lived in the incubator for seventeen days. This indicated that it is more than just temperature that determines the fate of pathogenic bacteria. The other factors listed above undoubtedly affect the viability of non-indigenous microorganisms (such as human pathogens) in a compost pile. Those factors require as large and diverse a microbial population as possible, which is best achieved by temperatures below 60°C (140°F). One researcher states that, “*Significant reductions in pathogen numbers have been observed in compost piles which have not exceeded 40°C [104°F].*” ³⁴

There is no doubt that the heat produced by thermophilic bacteria kills pathogenic microorganisms, viruses, bacteria, protozoa, worms and eggs that may inhabit humanure. A temperature of 50°C (122° F), if maintained for twenty-four hours, is sufficient to kill all of the pathogens, according to some sources (see Chapter Seven). A lower temperature will take longer to kill pathogens. A temperature of 46°C (115°F) may take nearly a week to kill pathogens completely, a higher temperature may only take minutes. What we have yet to determine is how low those temperatures can be and still achieve satisfactory pathogen elimination. Some researchers insist that all pathogens will die at ambient temperatures (normal air temperature) given enough time.

When Westerberg and Wiley composted sewage sludge which had been inoculated with polio virus, *Salmonella*, roundworm eggs, and *Candida albicans*, they found that a compost temperature of 47-55°C (116-130°F) maintained for three days killed all of these pathogens.³⁵ This phenomenon has been confirmed by many other researchers, including Gotaas, who indicates that pathogenic organisms are unable to survive compost temperatures of 55-60°C (131-140°F) for more than thirty minutes to one hour.³⁶ The first goal in composting humanure, therefore, should be to create a compost pile that will heat sufficiently to kill all potential human pathogens that may be found in the manure.

Nevertheless, the heat of the compost pile is a highly lauded characteristic of compost that is a bit overblown at times. People think that it’s only the heat of the compost that destroys pathogens, so they want their compost to become as hot as possible. This is a mistake. In fact, compost can become too hot, and when it does, it destroys the biodiversity of the microbial community. As one scientist states, “*Research has indicated that temperature is not the only mechanism involved in pathogen suppression, and that the employment of higher than necessary temperatures may actually constitute a barrier to effective sanitization under certain circumstances.*” ³⁷ Perhaps only one species (e.g., *Bacillus*

stearotherophilus) may dominate the compost pile during periods of excessive heat, thereby driving out or just outright killing the other inhabitants of the compost, which include fungi and actinomycetes, as well as the bigger organisms that you can actually see.

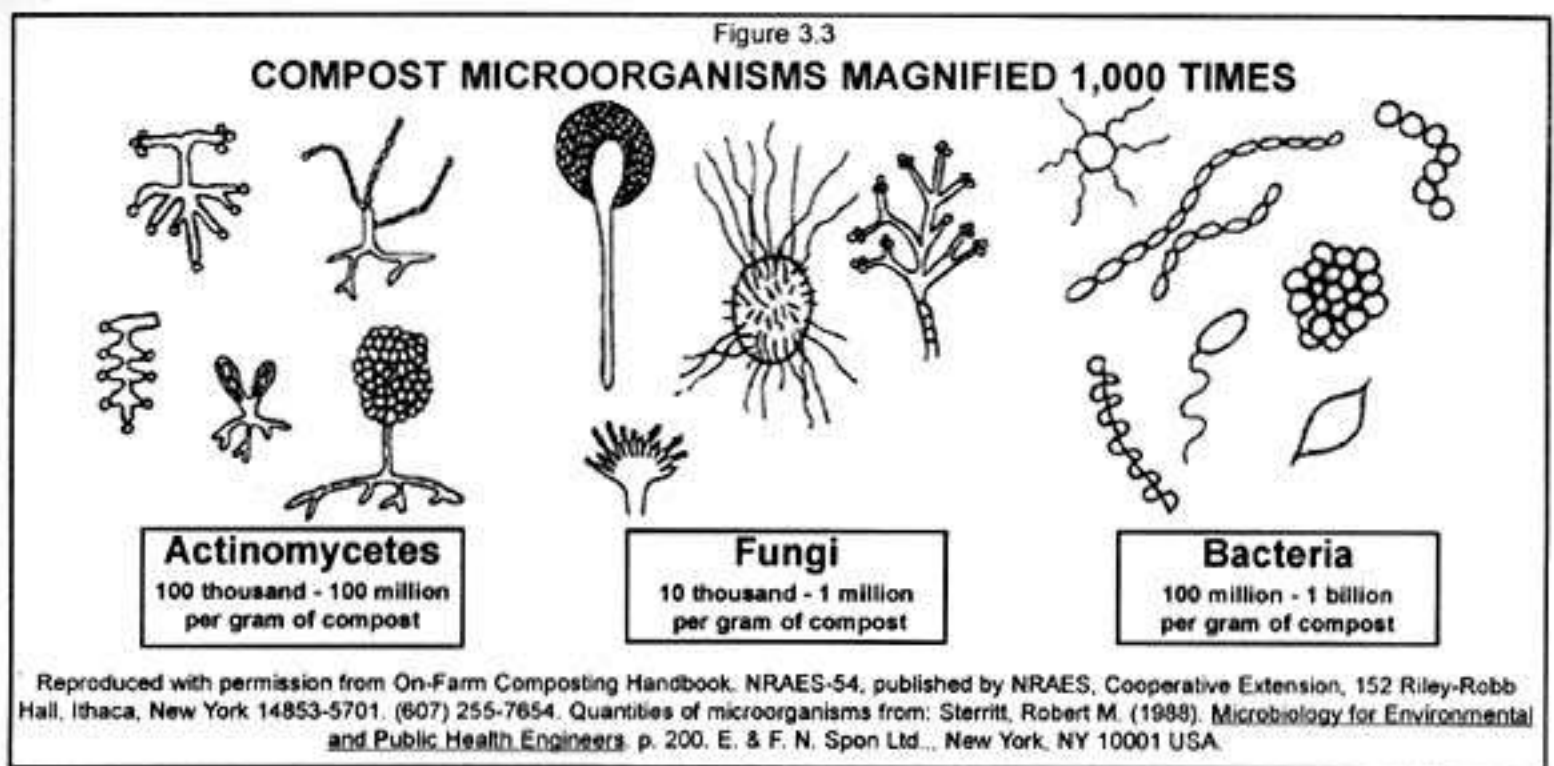

Table 3.6
MICROORGANISMS IN COMPOST

<u>Actinomycetes</u>	<u>Fungi</u>	<u>Bacteria</u>
<i>Actinobifida chromogena</i>	<i>Aspergillus fumigatus</i>	<i>Alcaligenes faecalis</i>
<i>Microbispora bispora</i>	<i>Humicola grisea</i>	<i>Bacillus brevis</i>
<i>Micropolyspora faeni</i>	<i>H. insolens</i>	<i>B. circulans</i> complex
<i>Nocardia</i> sp.	<i>H. lanuginosa</i>	<i>B. coagulans</i> type A
<i>Pseudocardia thermophila</i>	<i>Malbranchea pulchella</i>	<i>B. coagulans</i> type B
<i>Streptomyces rectus</i>	<i>Myriococcum thermophilum</i>	<i>B. licheniformis</i>
<i>S. thermofuscus</i>	<i>Paecilomyces variotti</i>	<i>B. megaterium</i>
<i>S. thermoviolaceus</i>	<i>Papulaspora thermophila</i>	<i>B. pumilus</i>
<i>S. thermovulgaris</i>	<i>Scytalidium thermophilum</i>	<i>B. sphaericus</i>
<i>S. violaceus-ruber</i>	<i>Sporotrichum thermophile</i>	<i>B. stearotherophilus</i>
<i>Thermoactinomyces sacchari</i>		<i>B. subtilis</i>
<i>T. vulgaris</i>		<i>Clostridium thermocellum</i>
<i>Thermomonospora curvata</i>		<i>Escherichia coli</i>
<i>T. viridis</i>		<i>Flavobacterium</i> sp.
		<i>Pseudomonas</i> sp.
		<i>Serratia</i> sp.
		<i>Thermus</i> sp.

Source: Palmisano, Anna C. and Barlaz, Morton A. (Eds.) (1996). *Microbiology of Solid Waste*. Pp. 125-127. CRC Press, Inc., 2000 Corporate Blvd., N.W. Boca Raton, FL 33431 USA.

A compost pile that is too hot can destroy its own biological community and leave a mass of organic material that must be re-populated in order to continue the necessary conversion of organic matter to humus. Such sterilized compost is more likely to be colonized by unwanted microorganisms, such as *Salmonella*. Researchers have shown that the biodiversity of compost acts as a barrier to colonization by such unwanted microorganisms as *Salmonella*. In the absence of a biodiverse “indigenous flora,” such as happens through sterilization, *Salmonella* were able to regrow.³⁸

The microbial biodiversity of compost is also important because it aids in the breakdown of the organic material. For example, in high-temperature compost (80°C), only about 10% of sewage sludge solids could be decomposed in three weeks, whereas at 50-60°C, 40% of the sludge solids were decomposed in only seven days. The lower temperatures apparently allowed for a richer diversity of living things which in turn had a greater effect on the degradation of the organic matter. One researcher indicates that optimal decomposition rates occur in the 55-59°C (131-139°F) temperature range, and optimal thermophilic activity occurs at 55°C (131°F), which are both adequate temperatures for pathogen destruction.³⁹ A study conducted in 1955 at Michigan State University, however, indicated that optimal decomposition occurs at an even lower temperature of 45°C (113°F).⁴⁰ Another researcher asserts that maximum biodegradation occurs at 45-55°C (113-131°F), while maximum microbial diversity requires a temperature range of 35-45°C (95-113°F).⁴¹ Apparently, there is still some degree of flexibility in these estimates, as the science of “compost microhusbandry” is not an utterly precise one at this time. Control of excessive heat is rarely a concern for the backyard composter.

Some thermophilic actinomycetes, as well as mesophilic bacteria, produce antibiotics that display considerable potency toward other bacteria, and yet exhibit low toxicity when tested on mice. Up to one half of thermophilic strains can produce antimicrobial compounds, some of which have been shown to be effective against *E. coli* and *Salmonella*. One thermophilic strain with an optimum growth temperature of 50°C produces a substance that “*significantly aided the healing of infected surface wounds in clinical tests on human subjects. The product(s) also stimulated growth of a variety of cell types, including various animal and plant tissue cultures and unicellular algae.*”⁴² The production of antibiotics by compost microorganisms theoretically assists in the destruction of human pathogens that may have existed in the organic material before composting.

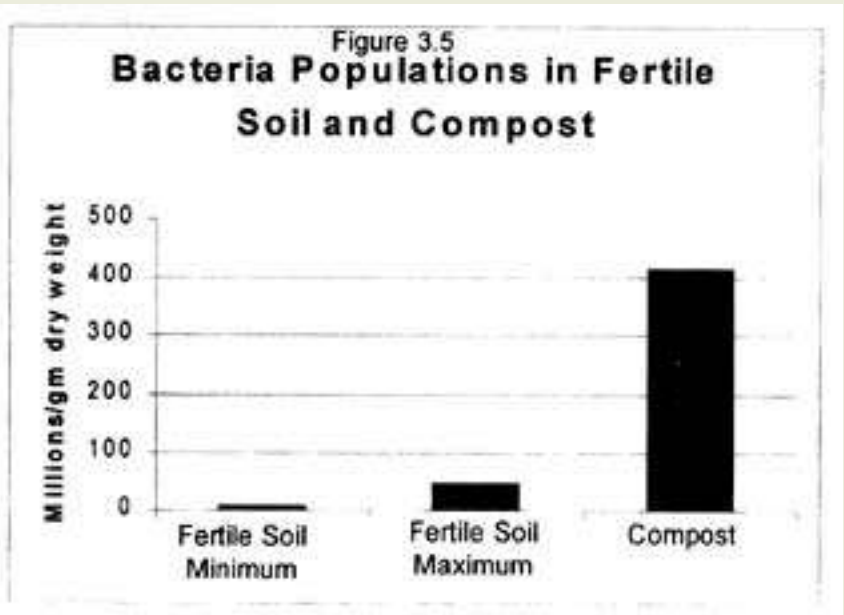
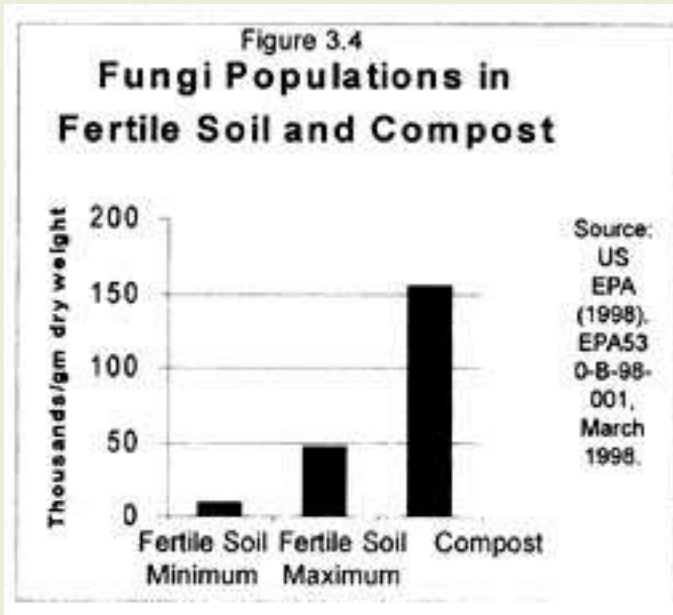

Even if every speck of the composting material is not subjected to the high internal temperatures of the compost pile, the process of thermophilic composting nevertheless contributes immensely toward the creation of a sanitary organic material. Or, in the words of one group of composting professionals, “*The high temperatures achieved during composting, assisted by the competition and antagonism among the microorganisms [i.e., biodiversity], considerably reduce the number of plant and animal pathogens. While some resistant pathogenic organisms may survive and others may persist in cooler sections of the pile, the disease risk is, nevertheless, greatly reduced.*” ⁴³

If a backyard composter has any doubt or concern about the existence of pathogenic organisms in his or her humanure compost, s/he can use the compost for horticultural purposes rather than for food purposes. Humanure compost can grow an amazing batch of berries, flowers, bushes, or trees. Furthermore, lingering pathogens continue to die after the compost has been applied to the soil, which is not surprising as human pathogens prefer the warm and moist environment of the human body. As the World Bank researchers put it, “*even pathogens remaining in compost seem to disappear rapidly in the soil.*” [Night Soil Composting, 1981] Finally, compost can be tested for pathogens by compost testing labs.

Some say that a few pathogens in soil or compost are ok. “*Another point most folks don’t realize is that no compost and no soil are completely pathogen free. You really don’t want it to be completely pathogen free, because you always want the defense mechanism to have something to practice on. So a small number of disease-causing organisms is desirable. But that’s it.*” ⁴⁴ Pathogens are said to have “minimum infective doses,” which vary widely from one type of pathogen to another, meaning that a number of pathogens are necessary in order to initiate an infection. The idea, therefore, that compost must be sterile is incorrect. It must be sanitary, which means it must have a greatly weakened, reduced, or destroyed pathogen population.

In reality, the average backyard composter knows whether his or her family is healthy or not. Healthy families have little to be concerned about, and can feel pretty confident that their thermophilic compost will be safe for their garden, provided the simple instructions in this book are followed regarding

compost temperatures and retention times, as discussed in Chapter Seven. On the other hand, there will always be those people who are fecophobic, and who will never be convinced that humanure compost is safe. These people are not likely to compost their humanure anyway, so who cares?

Source: The Humanure Handbook. Jenkins Publishing, PO Box 607, Grove City, PA 16127. To order, phone: 1-800-639-4099.

<http://www.jenkinspublishing.com/>

MENU: [HOME](#) » [Reconstruction](#) » [Recovery](#) » [Renewal](#) » [Survival](#) » [Humanure Content](#)

COMPOST MYTHS

TO TURN OR NOT TO TURN: THAT IS THE QUESTION

What is one of the first things to come to mind when one thinks of compost? Turning the pile. *Turn, turn, turn*, has become the mantra of composters worldwide. Early researchers who wrote seminal works in the composting field, such as Gotaas, Rodale, and many others, emphasize turning compost piles, almost obsessively so.

Much of compost's current popularity in the West can be attributed to the work of Sir Albert Howard, who wrote *An Agricultural Testament* (1943) and several other works on aspects of what has now become known as *organic* agriculture. Sir Howard's discussions of composting techniques focus on the Indore process of composting, a process developed in Indore, India, between the years of 1924 and 1931. The Indore process was first described in detail in Sir Howard's work (co-authored with Y. D. Wad), *The Waste Products of Agriculture*, in 1931. The two main principles underlying the Indore composting process include: 1) mixing animal and vegetable refuse with a neutralizing base, such as agricultural lime; and 2) managing the compost pile by physically turning it. The Indore process subsequently became adopted and espoused by composting enthusiasts in the West, and today one still commonly sees people turning and liming compost piles. For example, Robert Rodale wrote in the February, 1972 issue of *Organic Gardening* concerning composting humanure, "*We recommend turning the pile at least three times in the first few months, and then once every three months thereafter for a year.*"

A large industry has emerged from this philosophy, one which manufactures expensive compost turning equipment, and a lot of money, energy, and expense goes into making sure compost is turned regularly. To some compost professionals, the suggestion that compost doesn't need to be turned at all is utter blasphemy. Of course you have to turn it — it's a compost pile, for heaven's sake.

Or do you? Well, in fact, NO, you don't, especially if you're a backyard composter, and not even if you're a large scale composter. The perceived need to turn compost is one of the myths of composting.

Turning compost potentially serves four basic purposes. First, turning is supposed to add oxygen to the compost pile, which is supposed to be good for the aerobic microorganisms. We are warned that if we do not turn our compost, it will become anaerobic and smell bad, attract rats and flies, and make us into social pariahs in our neighborhoods. Second, turning the compost ensures that all parts of the pile are subjected to the high internal heat, thereby ensuring total pathogen death, and yielding a hygienically safe, finished compost. Third, the more we turn the compost, the more it becomes chopped and mixed,

and the better it looks when finished, rendering it more marketable. Fourth, frequent turning can speed up the composting process. Since backyard composters don't actually market their compost, usually don't care if it's finely granulated or somewhat coarse, and usually have no good reason to be in a hurry, we can eliminate the last two reasons for turning compost right off the bat. Let's look at the first two.

Aeration is necessary for aerobic compost, which is what we want. There are numerous ways to aerate a compost pile. One is to force air into or through the pile using fans, which is common at large-scale composting operations, where air is sucked from under the compost piles and out through a biofilter. The suction causes air to seep into the organic mass through the top, thereby keeping it aerated. However, this air flow is more often than not a method for trying to reduce the temperature of the compost, because the exhaust air draws quite a bit of heat away from the compost pile. Mechanical aeration is never a need of the backyard composter, and is limited to large scale composting operations where the piles are so big they can smother themselves if not subjected to forced aeration.

Aeration can also be achieved by poking holes in the compost, driving pipes into it, and generally impaling it. This seems to be popular among some backyard composters. A third way is to physically turn the pile. A fourth, largely ignored way, however, is to build the pile so that tiny interstitial air spaces are trapped in the compost. This is done by using coarse materials in the compost, such as hay, straw, weeds, and the like. When a compost pile is properly constructed, no additional aeration will be needed. Even the organic gardening pros admit that, *“good compost can be made without turning by hand if the materials are carefully layered in the heap which is well-ventilated and has the right moisture content.”*

[45](#)

This is especially true for “continuous compost,” which is different from “batch compost.” Batch compost is made from a batch of material that is composted all at once. This is what commercial composters do — they get a dumptruck load of garbage or sewage sludge from the municipality and compost it in one big pile. Backyard composters, especially humanure composters, produce organic residues daily, a little at a time, and rarely, if ever, in big batches. Therefore, continuous composters add material continuously to a compost pile, usually by putting the fresh material on the top. This causes the thermophilic activity to be in the upper part of the pile, while the thermophilically “spent” part of the compost sinks lower and lower to be worked on by fungi, actinomycetes, earthworms, and lots of other things. Turning continuous compost dilutes the thermophilic layer with the spent layers and can quite abruptly stop all thermophilic activity.

Researchers have measured oxygen levels in large-scale windrow composting operations (a windrow is a long, narrow pile of compost). One reported, *“Oxygen concentration measurements taken within the windrows during the most active stage of the composting process, showed that within fifteen minutes after turning the windrow — supposedly aerating it — the oxygen content was already depleted.”* [46](#) Other researchers compared the oxygen levels of large, turned and unturned batch compost piles, and have come to the conclusion that compost piles are largely self-aerated. *“The effect of pile turning was to refresh oxygen content, on average for [only] 1.5 hours (above the 10% level), after which it dropped to less than 5% and in most cases to 2% during the active phase of composting . . . Even with no turning, all piles eventually resolve their oxygen tension as maturity approaches, indicating that self-aeration alone*

can adequately furnish the composting process . . . In other words, turning the piles has a temporal but little sustained influence on oxygen levels.” These trials compared compost that was not turned, bucket turned, turned once every two weeks, and turned twice a week.⁴⁷

Interestingly enough, the same trials indicated that bacterial pathogens were destroyed whether the piles were turned or unturned, stating that there was no evidence that bacterial populations were influenced by turning schemes. There were no surviving *E. coli* or *Salmonella* strains, indicating that there were “no statistically significant effects attributable to turning.” Unturned piles can benefit by the addition of extra coarse materials such as hay or straw, which trap extra air in the organic material and make additional aeration unnecessary. Furthermore, unturned compost piles can be covered with a thick insulating layer of organic material, such as hay, straw, or even finished compost, which will allow the temperatures on the outer edges of the pile to warm enough for pathogen destruction.

Not only can turning compost piles be an unnecessary expenditure of energy, but the above trials also showed that when batch compost piles are turned frequently, some other disadvantageous effects can result (see Figure 3.6). The more frequently compost piles are turned, the more they lose agricultural nutrients. When the finished compost was analyzed for organic matter and nitrogen loss, the unturned compost showed the least loss. The more frequently the compost was turned, the greater was the loss of both nitrogen and organic matter. Also, the more the compost was turned, the more it cost. The unturned compost cost \$3.05 per wet ton, while the compost turned twice a week cost \$41.23 per wet ton, a 1,351% increase. The researchers concluded that

Figure 3.6

Compost Turning Costs

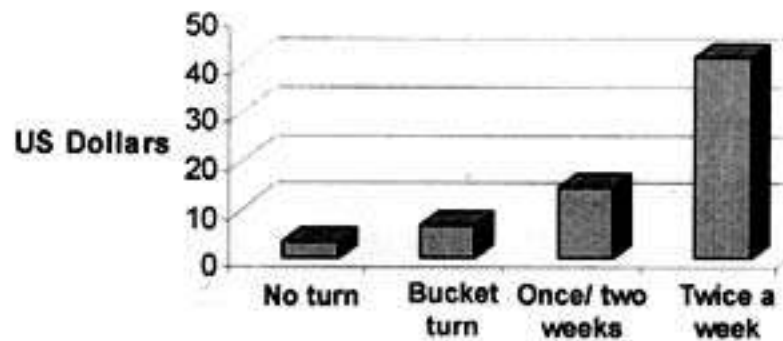

Organic Matter Loss Due to Turning (%)

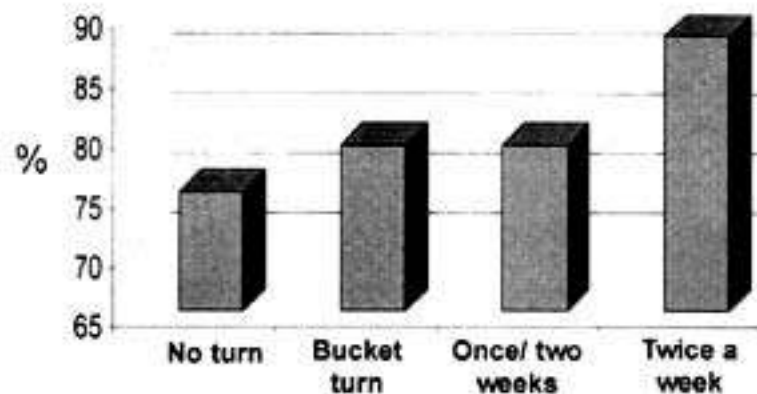

Nitrogen Loss Due To Turning (%)

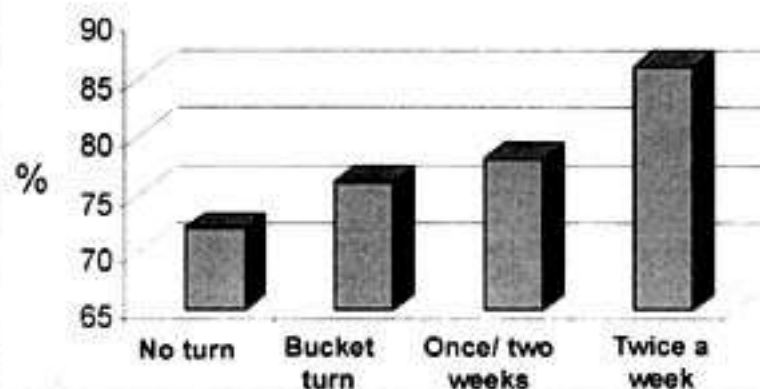

“Composting methods that require intensification [frequent turning] are a curious result of modern popularity and technological development of composting as particularly evidenced in popular trade journals. They do not appear to be scientifically supportable based on these studies . . . By carefully managing composting to achieve proper mixes and limited turning, the ideal of a quality product at low economic burden can be achieved.” ⁴⁸ Backyard composters like the “low economic burden” part of that statement.

no turn	once a turn	once two weeks	twice a week
Source: Brinton, William F. Jr. (date unknown). Sustainability of Modern Composting - Intensification Versus Cost and Quality. Woods End Institute, PO Box 297, Mt. Vernon, Maine 04352 USA.			

When large piles of compost are turned, they give off emissions of such things as *Aspergillus fumigatus* fungi, which can cause health problems in people. Aerosol concentrations from static (unturned) piles are relatively small when compared to mechanically turned compost. Measurements thirty meters downwind from static piles showed that aerosol concentrations of *A. fumigatus* were not significantly above background levels, and were “33 to 1800 times less” than those from piles that were being moved.⁴⁹

Finally, turning compost piles in cold climates can cause them to lose too much heat. It is recommended that cold climate composters turn less frequently, if at all.⁵⁰

DO YOU NEED TO INOCULATE YOUR COMPOST PILE?

No. This is perhaps one of the most astonishing aspects of composting. In October of 1998, I took a trip to Nova Scotia, Canada, to observe the municipal composting operations there. The Province had legislated that as of November 30, 1998, no organic materials could be disposed of in landfills. By the end of October, with the “ban date” approaching, virtually all municipal organic garbage was being collected and transported instead to composting facilities, where it was effectively being recycled and converted into humus. The municipal garbage trucks would simply back into the compost facility building (the composting was done indoors), and then dump the garbage on the floor. The material consisted of the normal household and restaurant food materials such as banana peels, coffee grounds, bones, meat, spoiled milk, and paper products such as cereal boxes. The occasional clueless person would contribute a toaster oven, but these were sorted out. The organic material was then checked for other contaminants such as bottles and cans, run through a grinder, and finally shoved into a concrete compost bin. Within 24-48 hours, the temperature of the material would climb to 70°C (158°F). No inoculants were required. Incredibly, the thermophilic bacteria were already there, waiting in the garbage for this moment to arrive.

Researchers have composted materials with and without inocula and found that, “*although rich in bacteria, none of the inocula accelerated the composting process or improved the final product . . . The failure of the inocula to alter the composting cycle is due to the adequacy of the indigenous microbial population already present and to the nature of the process itself . . . The success of composting operations without the use of special inocula in the Netherlands, New Zealand, South Africa, India, China, the USA, and a great many other places, is convincing evidence that inocula and other additives*

are not essential in the composting of [organic] materials.”⁵¹ Others state, “No data in the literature indicate that the addition of inoculants, microbes, or enzymes accelerate the compost process.”⁵²

LIME

It is not necessary to put lime (ground agricultural limestone) on your compost pile. The belief that compost piles should be limed is a common misconception. Nor are other mineral additives needed on your compost. If your soil needs lime, put the lime on your soil, not your compost. Bacteria don't digest limestone; in fact lime is used to kill microorganisms in sewage sludge (lime-stabilized sludge).

Aged compost is not acidic, even with the use of sawdust. The pH of finished compost should slightly exceed 7 (neutral). What is pH? It's a measure of acidity and alkalinity which ranges from 1-14. Neutral is 7. Below seven is acidic, above seven is basic or alkaline (see Figure 3.7). If the pH is too acidic or too alkaline, bacterial activity will be hindered or stopped completely. Lime and wood ashes raise the pH, but wood ashes should also go straight on the soil. The compost pile doesn't need them. It may seem logical that one should put into one's compost pile whatever one also wants to put into one's garden soil, as the compost will end up in the garden eventually, but that's not the reality of the situation. *What one should put into one's compost is what the microorganisms in the compost want or need, not what the garden soil wants or needs.*

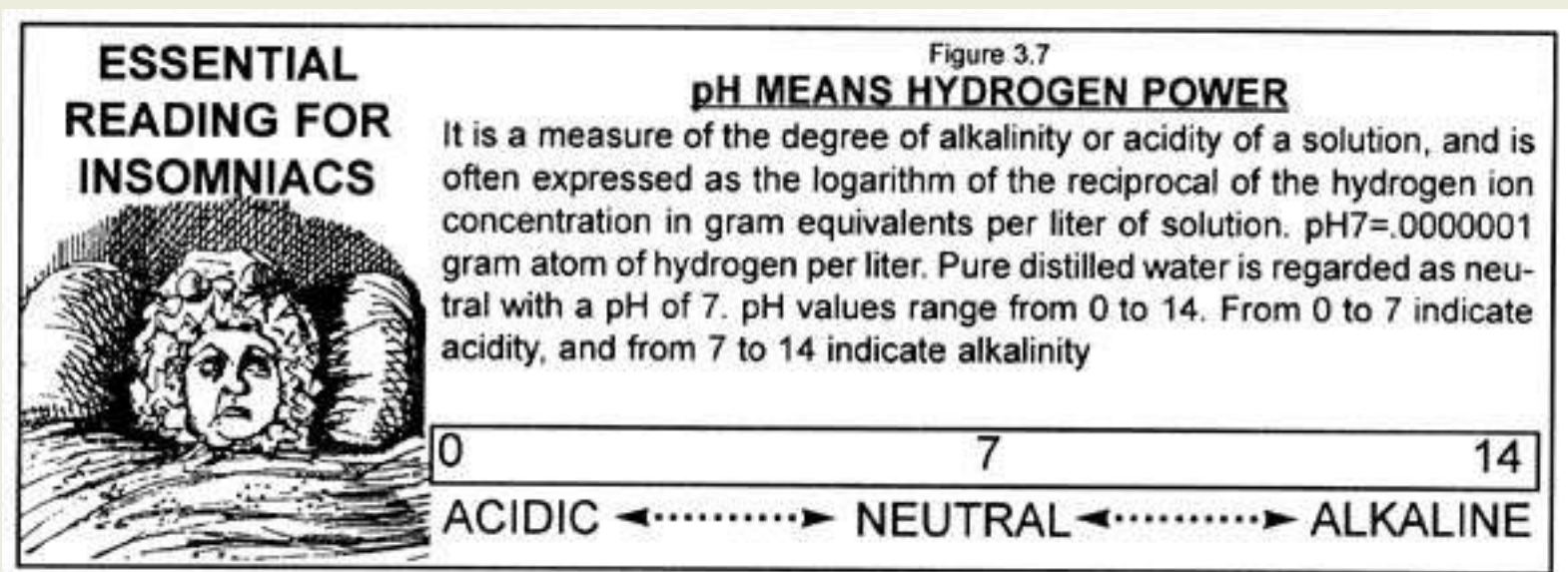

Sir Albert Howard, one of the most well-known proponents of composting, as well as J. I. Rodale, another prominent organic agriculturist, have recommended adding lime to compost piles.⁵³ They seemed to base their reasoning on the belief that the compost will become acidic during the composting process, and therefore the acidity must be neutralized by adding lime to the pile while it's composting. It may well be the case that some compost becomes acidic during the process of decomposition, however, it seems to neutralize itself if left alone, yielding a neutral, or slightly alkaline end product. Therefore, it is recommended that you test your *finished* compost for pH before deciding that you need to neutralize any acids.

I find it perplexing that the author who recommended liming compost piles in one book, states in another, “*The control of pH in composting is seldom a problem requiring attention if the material is kept aerobic. . . the addition of alkaline material is rarely necessary in aerobic decomposition and, in fact, may do more harm than good because the loss of nitrogen by the evolution of ammonia as a gas will be greater at the higher pH.*”⁵⁴ In other words, don’t assume that you should lime your compost. Only do so if your finished compost is consistently acidic, which would be highly unlikely. Get a soil pH test kit and check it out. Researchers have indicated that maximum thermophilic composting occurs at a pH range between 7.5 to 8.5, which is slightly alkaline.⁵⁵ But don’t be surprised if your compost is slightly acidic at the start of the process. It should turn neutral or slightly alkaline and remain so when completely cured.

According to a 1991 report, scientists who were studying various commercial fertilizers found that agricultural plots to which composted sewage sludge had been added made better use of lime than plots without composted sludge. The lime in the composted plots changed the pH deeper in the soil, indicating that organic matter assists calcium movement through the soil “*better than anything else,*” according to Cecil Tester, Ph.D., research chemist at USDA’s Microbial Systems Lab in Beltsville, MD.⁵⁶ The implications are that compost should be added to the soil when lime is added to the soil.

Perhaps Gotaas sums it up best, “*Some compost operators have suggested the addition of lime to improve composting. This should be done only under rare circumstances such as when the raw material to be composted has a high acidity due to acid industrial wastes or contains materials that give rise to highly acid conditions during composting.*”⁵⁷

WHAT NOT TO COMPOST? YOU CAN COMPOST ALMOST ANYTHING

I get a bit perturbed when I see compost educators telling their students that there is a long list of things “NOT to be composted!” This prohibition is always presented in such an authoritative and serious manner that novice composters begin trembling in their boots at the thought of composting any of the banned materials. I can imagine naive composters armed with this misinformation carefully segregating their food scraps so that, god forbid, the wrong materials don’t end up in the compost pile. Those banned materials include meat, fish, dairy products, butter, bones, cheese, lard, mayonnaise, milk, oils, peanut butter, salad dressing, sour cream, weeds with seeds, diseased plants, citrus peels, rhubarb leaves, crab grass, pet manures, and, perhaps worst of all: human manure. Presumably, one must segregate half-eaten peanut butter sandwiches from the compost bucket, or any sandwich with mayonnaise or cheese, or any left-over salad with salad dressing, or spoiled milk, or orange peels, all of which must go to a landfill and be buried under tons of dirt instead of being composted. Luckily, I was never exposed to such instructions, and my family has composted EVERY bit of food scrap it has produced, including meat, bones, butter, oils, fat, lard, citrus peels, mayonnaise, and everything else on the list; we’ve done this in our backyard for almost 25 years with never a problem. Why would it work for me and not for anyone else? The answer, in a word, if I may hazard a guess, is *humanure*, another forbidden compost material.

When compost heats up, much of the organic material is quickly degraded. This holds true for oils and fats, or in the words of scientists, “*Based on evidence on the composting of grease trap wastes, lipids*

[fats] can be utilized rapidly by bacteria, including actinomycetes, under thermophilic conditions.” [58](#)

The problem with the materials on the “banned” list, is that they do require thermophilic composting conditions for best results. Otherwise, they can just sit in the compost pile and only very slowly decompose. In the meantime, they can look very attractive to the wandering dog, cat, raccoon, or rat. Ironically, when the forbidden materials, including humanure, are combined with other compost ingredients, thermophilic conditions will prevail. When humanure and the other controversial organic materials are segregated from compost, thermophilic conditions may not occur at all. This is a situation that is probably quite common in most backyard compost piles. The solution is not to segregate materials from the pile, but to add nitrogen and moisture, as is commonly found in manure.

As such, compost educators would provide a better service to their students if they told them the truth: almost any organic material will compost, rather than give them the false impression that some common food materials will not. Granted, some things do not compost very well. Bones are one of them, but they do no harm in a compost pile.

Nevertheless, toxic chemicals *should* be kept out of the backyard compost pile. Such chemicals are found, for example, in “pressure treated” (i.e. poison-soaked) lumber, which is saturated with cancer-causing chemicals (chromated copper arsenate). What not to compost: sawdust from pressure treated lumber, which is, unfortunately, a toxic material that is more and more available to the average gardener.

Source: The Humanure Handbook. Jenkins Publishing, PO Box 607, Grove City, PA 16127. To order, phone: 1-800-639-4099.

<http://www.jenkinspublishing.com/>

MENU: [HOME](#) » [Reconstruction](#) » [Recovery](#) » [Renewal](#) » [Survival](#) » [Humanure Content](#)

COMPOST MIRACLES

COMPOST CAN DEGRADE TOXIC CHEMICALS

Compost microorganisms not only convert organic material into humus, but they also degrade toxic chemicals into simpler, benign, organic molecules. These chemicals include gasoline, diesel fuel, jet fuel, oil, grease, wood preservatives, PCBs, coal gasification wastes, refinery wastes, insecticides, herbicides, TNT, and other explosives.⁵⁹

In one experiment in which compost piles were laced with insecticides and herbicides, the insecticide (carbofuran) was completely degraded, and the herbicide (triazine) was 98.6% degraded after 50 days of composting. Soil contaminated with diesel fuel and gasoline was composted, and after 70 days in the compost pile, the total petroleum hydrocarbons were reduced approximately 93%.⁶⁰ Soil contaminated with Dicamba herbicide at a level of 3,000 parts per million showed no detectable levels of the toxic contaminant after only 50 days of composting. In the absence of composting, this biodegradation process normally takes years.

Compost also seems to bind lead in soils, making it less likely to be absorbed by living things. One researcher fed lead-contaminated soil to rats, either with compost added, or without. The soil to which compost had been added showed no toxic effects, whereas the soil without compost did exhibit some toxic effects.⁶¹ Compost seems to strongly bind metals and prevent their uptake by both plants and animals, thereby preventing transfer of metals from contaminated soil into the food chain.⁶² Plants grown in lead contaminated soil with ten percent compost showed a reduction in lead uptake of 82.6%, compared to plants grown in soil with no compost.⁶³

Fungi in compost produce a substance that breaks down petroleum, thereby making it available as food for bacteria.⁶⁴ One man who composted a batch of sawdust contaminated with diesel oil said, "*We did tests on the compost, and we couldn't even find the oil!*" The compost had apparently "eaten" it all.⁶⁵ Fungi also produce enzymes that can be used to replace chlorine in the paper-making process. Researchers in Ireland have discovered that fungi gathered from compost heaps can provide a cheap and organic alternative to toxic chemicals.⁶⁶

Compost has been used in recent years to degrade other toxic chemicals as well. For example, chlorophenol contaminated soil was composted with peat, sawdust, and other organic matter, and after 25 months, the chlorophenol was reduced in concentration by 98.73%. Freon contamination was reduced by 94%, PCPs by up to

98%, and TCE by 89-99% in other compost trials.⁶⁷ Some of this degradation is due to the efforts of fungi at lower (mesophilic) temperatures.⁶⁸

Table 3.7
MICROORGANISMS THAT HELP REMOVE METALS FROM WASTEWATER

MICROORGANISM	METAL
<i>Zooglea ramigera</i>	Copper
<i>Saccharomyces cerevisiae</i>	Uranium
<i>Trichoderma viride</i>	Copper
<i>Penicillium spinulosum</i>	Copper, Cadmium, Zinc
<i>Aspergillus Niger</i>	Copper, Cadmium, Zinc
<i>Chlorella vulgaris</i>	Gold, Zn, Cu, Mercury
<i>Rhizopus arrhizus</i>	Uranium

Source: Bitton, Gabriel (1994). *Wastewater Microbiology*, p. 302. Wiley-Liss, Inc. 605 Third Avenue, New York, NY 10518-0012.

Some bacteria even have an appetite for uranium. Derek Lovley, a microbiologist, has been working with a strain of bacteria that normally lives 650 feet under the Earth's surface. These microorganisms will eat, then excrete, uranium. The chemically altered uranium excreta becomes water insoluble as a result of the microbial digestion process, and can consequently be removed from the water it was contaminating (see Table 3.7).⁶⁹

An Austrian farmer claims that the microorganisms he introduces into his fields have prevented his crops from being contaminated by the radiation from Chernobyl, the ill-fated Russian nuclear power plant, which contaminated his neighbor's fields. Sigfried Lubke sprays his green manure crops with compost-type microorganisms just before plowing them under. This practice has produced a soil rich in humus and teeming with microscopic life. After the Chernobyl disaster, crops from fields in Lubke's farming area were banned from sale due to high amounts of radioactive cesium contamination. However, when officials tested Lubke's crops, no trace of cesium could be found. The officials made repeated tests because they couldn't believe that one farm showed no radioactive contamination while the surrounding farms did. Lubke surmises that the humus just "ate up" the cesium.⁷⁰

Compost is also able to decontaminate soil polluted with TNT from munitions plants. The microorganisms in the compost digest the hydrocarbons in TNT and convert them into carbon dioxide, water, and simple organic molecules. The method of choice for eliminating contaminated soil has thus far been incineration. However, composting costs far less, and yields a material that is valuable (compost), as opposed to incineration, which yields an ash that must itself be disposed of as toxic waste. When the Umatilla Army Depot in Hermiston, Oregon, a Superfund site, composted 15,000 tons of contaminated soil instead of incinerating it, it saved approximately \$2.6 million. Although the Umatilla soil was heavily contaminated with TNT and RDX (Royal Demolition Explosives), no explosives could be detected after composting, and the soil was restored to "*a better condition than before it was contaminated.*"⁷¹ Similar results have been obtained at Seymour Johnson Air Force Base in North Carolina, the Louisiana Army Ammunition Plant, the US Naval Submarine Base in Bangor, Washington, Fort Riley in Kansas, and the Hawthorne Army Depot in Nevada.⁷²

The US Army Corps of Engineers estimates that we would save \$200 million if composting, instead of incineration, were used to clean up the remaining US munitions sites. The ability of compost to bioremediate toxic chemicals is particularly meaningful when one considers that in the US there are currently 1.5 million underground storage tanks leaking a wide variety of materials into soil, as well as 25,000 Department of Defense sites in need of remediation. In fact, it is estimated that the remediation costs for America's most polluted sites using standard technology may reach \$750 billion, while in Europe the costs could reach \$300 to \$400 billion.

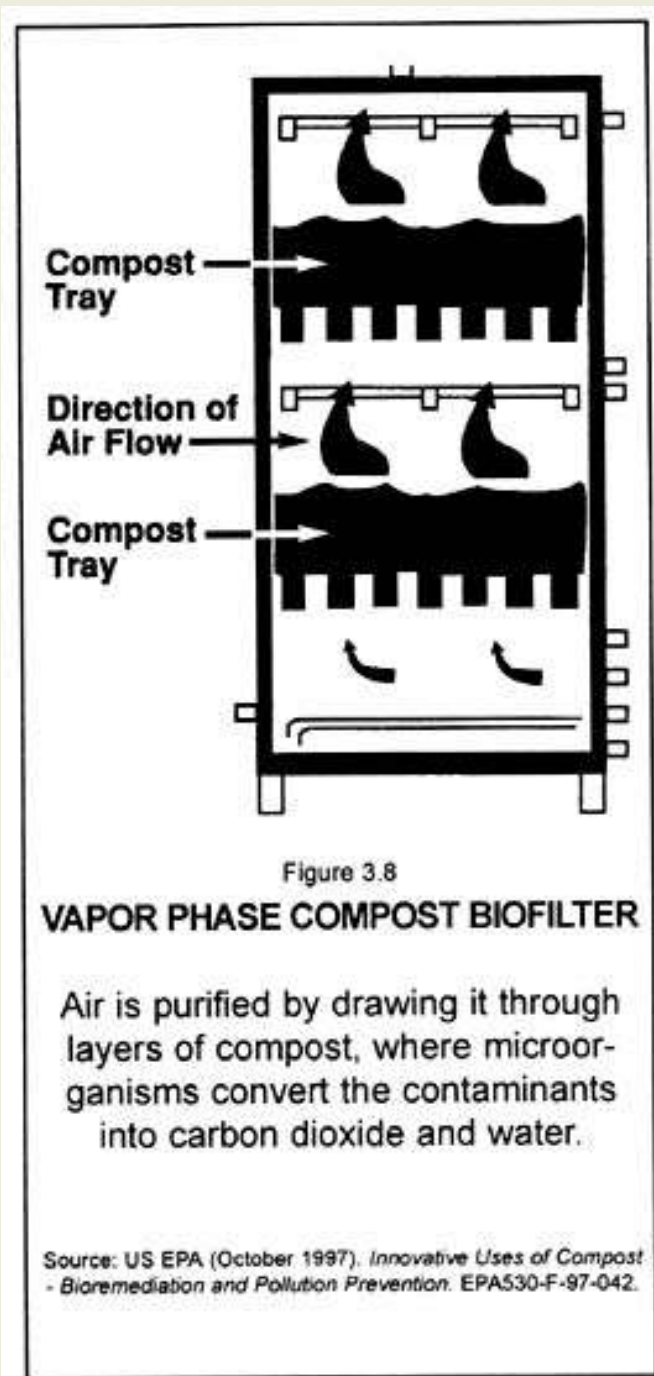

As promising as compost bioremediation appears, however, it cannot heal all wounds. Heavily chlorinated chemicals show considerable resistance to microbiological biodegradability. Apparently, there are even some things a fungus will spit out.⁷³ On the other hand, some success has been shown in the bioremediation of PCBs (polychlorinated biphenyls) in composting trials conducted by Michigan State University researchers in 1996. In the best case, PCB loss was in the 40% range. Despite the chlorinated nature of the PCBs, researchers still managed to get quite a few microorganisms to choke the stuff down.⁷⁴

COMPOST CAN FILTER POLLUTED AIR AND WATER

Compost can control odors. Biological filtration systems, called “biofilters,” are used at large-scale composting facilities where exhaust gases are filtered for odor control. The biofilters are composed of layers of organic material such as wood chips, peat, soil, and compost through which the air is drawn in order to remove any contaminants. The microorganisms in the organic material eat the contaminants and convert them into carbon dioxide and water (see Figures 3.8 and 3.9).

In Rockland County, New York, one such biofiltration system can process 82,000 cubic feet of air a minute, and guarantee no detectable odor at or beyond the site property line. Another facility in Portland, Oregon, uses biofilters to remediate aerosol cans prior to disposal. After such remediation, the cans are no longer considered hazardous, and can be disposed of more readily. In this case, a \$47,000 savings in hazardous waste disposal costs was realized over a period of 18 months. Vapor Phase Biofilters can maintain a consistent Volatile Organic Compound removal efficiency of 99.6%, which isn’t

bad for a bunch of microorganisms.⁷⁵ After a year or two, the biofilter is recharged with new organic material, and the old stuff is simply composted or applied to the land.

Compost is also now used to filter stormwater runoff (see Figure 3.10). Compost Stormwater Filters use compost to filter out heavy metals, oil, grease, pesticides, sediment, and fertilizers from stormwater runoff. Such filters can remove over 90% of all solids, 82% to 98% of heavy metals, and 85% of oil and grease, while filtering up to eight cubic feet per second. These Compost Stormwater Filters prevent stormwater contamination from polluting our natural waterways.⁷⁶

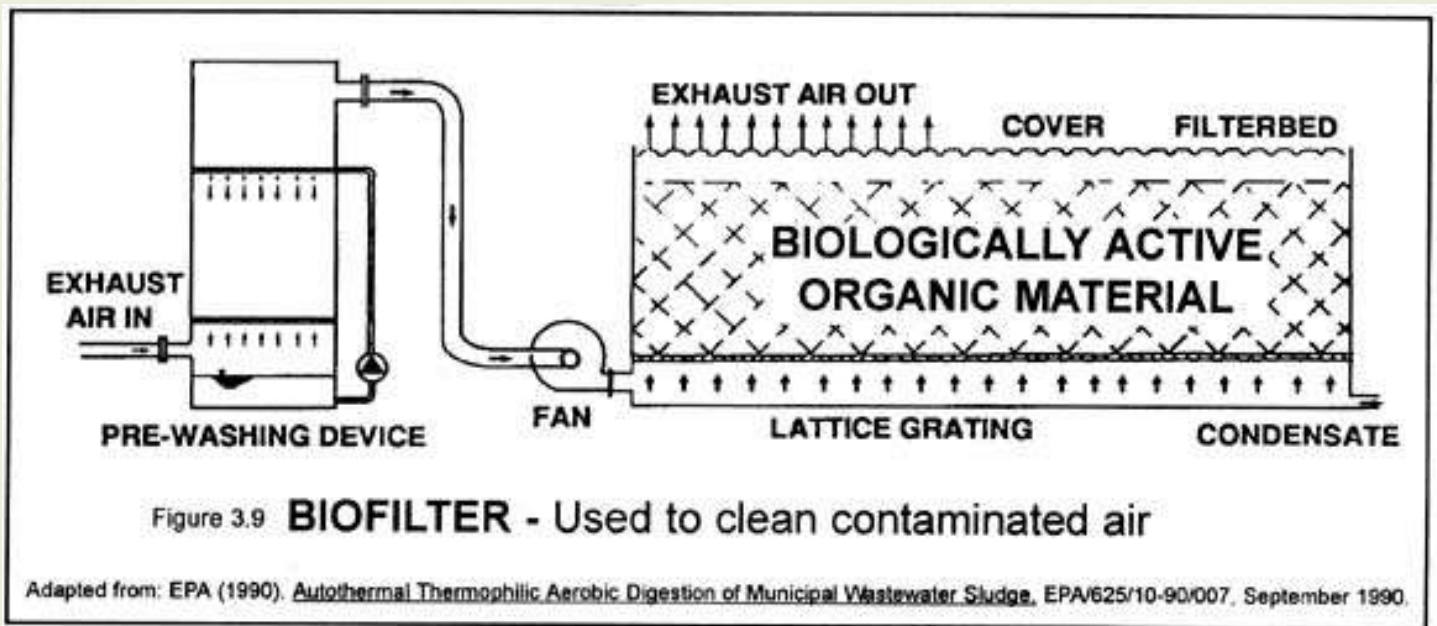

COMPOST DEFENDS PLANTS FROM DISEASES

The composting process can destroy many plant pathogens. Because of this, diseased plant material should be thermophilically composted rather than returned to the land where reinoculation of the disease could occur. The beneficial microorganisms in thermophilic compost directly compete with, inhibit, or kill organisms that cause diseases in plants. Plant pathogens are also eaten by micro-arthropods, such as mites and springtails, which are found in compost.⁷⁷

Compost microorganisms can produce antibiotics which suppress plant diseases. Compost added to soil can also activate disease resistance genes in plants, preparing them for a better defense against plant pathogens. Systemic Acquired Resistance caused by compost in soils allows plants to resist the effects of diseases such as *Anthraxnose* and *Pythium* root rot in cucumbers. Experiments have shown that when only some of the roots of a plant are in compost amended soil, while the other roots are in diseased soil, the entire plant can still acquire resistance to the disease.⁷⁸ Researchers have shown that compost combats chili wilt (*Phytophthora*) in test plots of chili peppers, and suppresses ashy stem blight in beans, *Rhizoctonia* root rot in black-eyed peas,⁷⁹ *Fusarium oxysporum* in potted plants, and gummy stem blight and damping off diseases in squash.⁸⁰ It is now recognized that the control of root rots with composts can be as effective as synthetic fungicides such as methyl bromide. Only a small percentage of compost microorganisms can, however, induce disease resistance in plants, which again emphasizes the importance of biodiversity in compost.

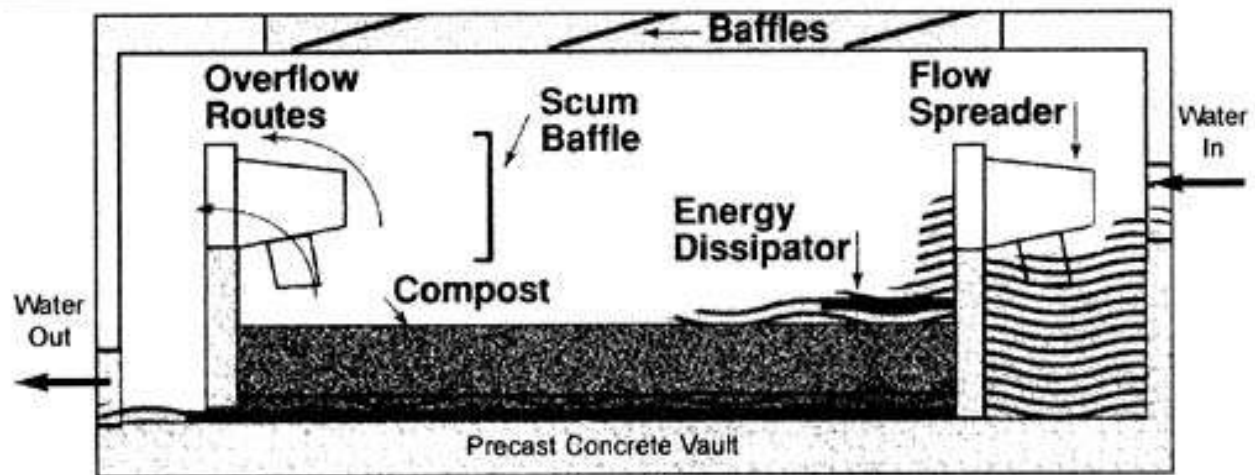

Figure 3.10

COMPOST STORMWATER FILTER

Contaminants are removed from stormwater when filtered through layers of compost.

Source: US EPA (October 1997). *Innovative Uses of Compost - Bioremediation and Pollution Prevention*. EPA530-F-97-042.

Studies in 1968 by researcher Harry Hoitink indicated that compost inhibited the growth of disease-causing microorganisms in greenhouses by adding beneficial microorganisms to the soil. In 1987, he and a team of scientists took out a patent for compost that could reduce or suppress plant diseases caused by three deadly microorganisms: *Phytophthora*, *Pythium*, and *Fusarium*. Growers who used this compost in their planting soil reduced their crop losses from 25-75% to 1% without applying fungicides. The studies suggested that sterile soils could provide optimum breeding conditions for plant disease microorganisms, while a rich diversity of microorganisms in soil, such as that found in compost, would render the soil unfit for the proliferation of disease organisms.⁸¹

In fact, compost tea has also been demonstrated to have disease-reducing properties in plants. Compost tea is made by soaking mature (but not overly-mature) compost in water for three to twelve days. The tea is then filtered and sprayed on plants undiluted, thereby coating the leaves with live bacteria colonies. When sprayed on red pine seedlings, for example, blight was significantly reduced in severity.⁸² Powdery mildew (*Uncinula necator*) on grapes was very successfully suppressed by compost tea made from cattle manure compost.⁸³ “Compost teas can be sprayed on crops to coat leaf surfaces and actually occupy the infection sites that could be colonized by disease pathogens,” states one researcher, who adds, “There are a limited number of places on a plant that a disease pathogen can infect, and if those spaces are occupied by beneficial bacteria and fungi, the crop will be resistant to infection.”⁸⁴

Besides helping to control soil diseases, compost attracts earthworms, aids plants in producing growth stimulators, and helps control parasitic nematodes.⁸⁵ Compost “biopesticides” are now becoming increasingly effective alternatives to chemical bug killers. These “designer composts” are made by adding certain pest-fighting microorganisms to compost, yielding a compost with a specific pest-killing capacity. Biopesticides must be registered with the US EPA and undergo the same testing as chemical pesticides to determine their effectiveness and degree of public safety.⁸⁶

Finally, composting destroys weed seeds. Researchers observed that after three days in compost at 55°C (131°F),

all of the seeds of the eight weed species studied were dead.⁸⁷

COMPOST CAN RECYCLE THE DEAD

Dead animals of all species and sizes can be recycled by composting. Of the 7.3 billion chickens, ducks, and turkeys raised in the US each year, about 37 million die from disease and other natural causes before they're marketed.⁸⁸ The dead birds can simply be composted. The composting process not only converts the carcasses to humus which can be returned directly to the farmer's fields, but it also destroys the pathogens and parasites that may have killed the birds in the first place. It is preferable to compost diseased animals on the farm where they originated rather than transport them elsewhere and risk spreading the disease. A temperature of 55°C maintained for at least three consecutive days maximizes pathogen control.

Composting is considered a simple, economic, environmentally sound, and effective method of managing animal mortalities. Carcasses are buried in, well, a compost pile. The composting process ranges from several days for small birds to six or more months for mature cattle. Generally, the total time required ranges from two to twelve months depending on the size of the animal and other factors such as ambient air temperature (time of year). The rotting carcasses are never buried in the ground where they may pollute groundwater, as is typical when composting is not used. Animal mortality recycling can be accomplished without odors, flies, or scavenging birds or animals.

Originally developed to recycle dead chickens, the animal carcasses that are now composted include full-grown pigs, cattle, and horses, as well as fish, sheep, calves, and other animals. The biological process of composting dead animals is identical to the process of composting any organic material. The carcasses provide nitrogen and moisture, while materials such as sawdust, straw, corn stalks, and paper provide carbon and bulk for air impregnation. The composting can be done in temporary three-sided bins made of straw or hay bales. A layer of absorbent organic material is used to cover the bottom of the bin, acting as a sponge for excess liquids. Large animals are placed back down in the compost, with their abdominal and thoracic cavities opened, and covered with organic material (sawmill sawdust has been shown to be one of the most effective organic materials with which to compost dead animals). After filling the bin with properly prepared animal mortalities, the top is covered with clean organic material that acts as a biofilter for odor control. Although large bones may remain after the composting process, they are easily broken when applied to the soil.⁸⁹

Backyard composters can also make use of this technique. When a small animal has died and the carcass needs to be recycled, simply dig a hole in the top center of the compost pile, deposit the carcass, bury it over with the compost, and cover it all with a clean layer of organic material such as straw, weeds, or hay. You will never see the carcass again. This is also a good way to deal with fish, meat scraps, milk products, and other organic materials that may otherwise be attractive to nuisance animals. However, one should have thermophilic compost in order to do this, and one can greatly increase the likelihood of his or her backyard compost being thermophilic by adding the nitrogen and moisture that humanure provides.

I keep some ducks and chickens on my homestead, and occasionally one of them dies. A little poking around in the compost pile to create a depression in the top, and a plop of the carcass into the hole, and another creature is on the road to reincarnation. We've also used this technique regularly for recycling other smaller animal carcasses such as mice, baby chicks, and baby rabbits. After I collect earthworms from my compost pile to go fishing at the local pond, I filet the catch and put it in the freezer for winter consumption. The fish remains go straight into the compost, buried in the same manner as any other animal mortality. We have five outdoor cats, and they wouldn't

be caught dead digging around in thermophilic humanure compost looking for a bite to eat. Nor would our dog — and dogs will eat anything, but not when buried in thermophilic compost.

COMPOST RECYCLES PET MANURES

Can you use dog manure in your compost? I can honestly say that I've never tried it, as I do not have a source of dog manure for experimentation (my dog is a free-roaming outdoor dog, and he leaves his scat somewhere out of sight). Numerous people have written to ask me whether pet manures can go into their household compost pile, and I have responded that I don't know from experience. So I've recommended that pet manures be collected in their own separate little compost bins with cover materials such as hay, grass clippings, leaves, weeds, or straw, and perhaps occasionally watered a bit to provide moisture. A double bin system will allow the manures to be collected for quite some time in one bin, then aged for quite some time while the second bin is being filled. What size bin? About the size of a large garbage can, although a larger mass may be necessary in order to spark a thermophilic reaction.

On the other hand, this may be entirely too much bother for most pet owners who are also composters, and you may just want to put pet and human manures into one compost bin. This would certainly be the simpler method. The idea of composting dog manure has been endorsed by J. I. Rodale in the *Encyclopedia of Organic Gardening*. He states, "*Dog manure can be used in the compost heap; in fact it is the richest in phosphorous if the dogs are fed with proper care and given their share of bones.*" He advises the use of cover materials similar to the ones I mentioned above, and recommends that the compost bin be made dog-proof, which can be done with straw bales, chicken wire, boards, or fencing.

ONE WAY TO RECYCLE JUNK MAIL

Composting is a solution for junk mail, too. A pilot composting project was started in 1997 in Dallas-Ft. Worth, Texas, where 800 tons of undeliverable bulk mail are generated annually. The mail was ground in a tub grinder, covered with wood chips so it wouldn't blow away, then mixed with zoo manure, sheep entrails, and discarded fruits and vegetables. The entire works was kept moist and thoroughly mixed. The result — a finished compost "*as good as any other compost commercially available.*" It grew a nice bunch of tomatoes, too.⁹⁰

What about newspapers in backyard compost? Yes, newspaper will compost, but there are some concerns about newsprint. For one, the glossy pages are covered with a clay that retards composting. For another, the inks can be petroleum-based solvents or oils with pigments containing toxic substances such as chromium, lead and cadmium in both black and colored inks. Pigment for newspaper ink still comes from benzene, toluene, naphthalene, and other benzene ring hydrocarbons which may be quite harmful to human health if accumulated in the food chain. Fortunately, quite a few newspapers today are using soy-based inks instead of petroleum-based inks. If you really want to know about the type of ink in your newspaper, call your newspaper office and ask them. Otherwise, keep the glossy paper or colored pages in your compost to a minimum. Remember, ideally, compost is being made to use for producing human food. One should try to keep the contaminants out of it, if possible.⁹¹

Wood's End Laboratory in Maine did some research on composting ground up telephone books and newsprint, which had been used as bedding for dairy cattle. The ink in the paper contained common cancer-causing chemicals, but after composting it with dairy cow manure, the dangerous chemicals were reduced by 98%.⁹² So it appears that if you're using shredded newspaper for bedding under livestock, you *should* compost it, if for no other reason than to eliminate some of the toxic elements from the newsprint. It'll probably make acceptable

compost too, especially if layered with garbage, manure, and other organic materials.

What about things like sanitary napkins and disposable diapers? Sure, they'll compost, but they'll leave strips of plastic throughout your finished compost which are quite unsightly. Of course, that's OK if you don't mind picking the strips of plastic out of your compost. Otherwise, use cloth diapers and washable cloth menstrual pads instead.

Toilet paper composts, too. So do the cardboard tubes in the center of the rolls. Unbleached, recycled toilet paper is ideal. Or you can use the old fashioned toilet paper, otherwise known as corncobs. Popcorn cobs work best, they're softer. Corncobs don't compost very readily though, so you have a good excuse not to use them. There are other things that don't compost well: eggshells, bones, hair, and woody stems, to name a few. We throw our eggshells back to our chickens, or into the woodstove. Bones go into the woodstove, or to the cats or dog. Hair goes out to the birds for nests, if not into the compost pile.

Compost professionals have almost fanatically seized upon the idea that wood chips are good for making compost. Nowadays, when novice composters want to begin making compost, the first thing they want to know is where they can get wood chips. In fact, wood chips do NOT compost very well at all, unless ground into fine particles, as in sawdust. Even compost professionals admit that they have to screen out their wood chips *after* the compost is finished because they didn't decompose. They insist on using them anyway, because they break up the compost consistency and maintain air spaces in their large masses of organic material. However, a home composter should avoid wood chips and use other bulking materials that degrade more quickly, such as hay, straw, sawdust, and weeds.

Finally, never put woody stemmed plants, such as tree saplings, on your compost pile. I hired a young lad to clear some brush for me one summer and he innocently put the small saplings on my compost pile without me knowing it. Later, I found them networked through the pile like iron reinforcing rods. I'll bet the lad's ears were itching that day — I sure had some nasty things to say about him. Fortunately, only Gomer, the compost pile, heard me.

*Source: The Humanure Handbook. Jenkins Publishing, PO Box 607, Grove City, PA 16127. To order, phone: 1-800-639-4099.
<http://www.jenkinspublishing.com/>*

MENU: [HOME](#) » [Reconstruction](#) » [Recovery](#) » [Renewal](#) » [Survival](#) » [Humanure Content](#)

MENU: [HOME](#) » [Reconstruction](#) » [Recovery](#) » [Renewal](#) » [Survival](#) » [Humanure Content](#)

VERMICOMPOSTING

Vermicomposting, or worm composting, involves the use of redworms (*Eisenis fetida* or *Lumbricus rubellus*) to consume organic material either in specially designed worm boxes, or in large-scale, outdoor compost piles. Redworms prefer a dark, cool, well-aerated space, and thrive on moist bedding such as shredded newspaper. Kitchen food scraps are placed in worm boxes and are consumed by the worms. Worm castings are left in their place, which can be used like finished compost to grow plants. Vermicomposting is popular among children who like to watch the worms, and among adults who prefer the convenience of being able to make compost under their kitchen counter or in a household closet.

Although vermicomposting involves microorganisms as well as earthworms, it is not the same as thermophilic composting. The hot stage of thermophilic composting will drive away all earthworms from the hot area of the compost pile. However, they will migrate back in after the compost cools down. Earthworms are reported to actually eat root-feeding nematodes, pathogenic bacteria, and fungi, as well as small weed seeds.⁹³

When thermophilic compost is piled on the bare earth, a large surface area is available for natural earthworms to migrate in and out of the compost pile. Properly prepared thermophilic compost situated on bare earth should require no addition of earthworms, as they will naturally migrate into the compost when it best suits them. My compost is so full of natural earthworms at certain stages in its development that, when dug into, it looks like spaghetti. These worms are occasionally harvested and transformed into fish. This is a process which converts compost directly into protein, but which requires a fishing rod, a hook, and lots of patience.

Source: The Humanure Handbook. Jenkins Publishing, PO Box 607, Grove City, PA 16127. To order, phone: 1-800-639-4099.

<http://www.jenkinspublishing.com/>

MENU: [HOME](#) » [Reconstruction](#) » [Recovery](#) » [Renewal](#) » [Survival](#) » [Humanure Content](#)

PRACTICE MAKES COMPOST

“Composting is easier to do than to describe, and, like lovemaking, magic when you do it well.”

Sim Van der Ryn

After reading this chapter one may become overwhelmed with all that is involved in composting: bacteria, actinomycetes, fungi, thermophiles, mesophiles, C/N ratios, oxygen, moisture, temperatures, bins, pathogens, curing, and biodiversity. How do you translate this into your own personal situation and locate it all in your own backyard? How does one become an accomplished composter, a master composter? That’s easy — just do it. Then keep doing it. Throw the books away (not this one, of course) and get some good, old-fashioned experience. There’s no better way to learn. Book learning will only get you so far, but not far enough. A book such as this one is for inspiring you, for sparking your interest, and for reference. But you have to get out there and *do it* if you really want to learn.

Work with the compost, get the feel of the process, look at your compost, smell the finished product, buy or borrow a compost thermometer and get an idea of how well your compost is heating up, then use your compost for food production. Rely on your compost. Make it a part of your life. Need it and value it. In no time, without the need for charts or graphs, Ph.D.s, or worry, your compost will be as good as the best of them. Perhaps someday we’ll be like the Chinese who give prizes for the best compost in a county, then have intercounty competitions. Now *that’s* getting your shit together.

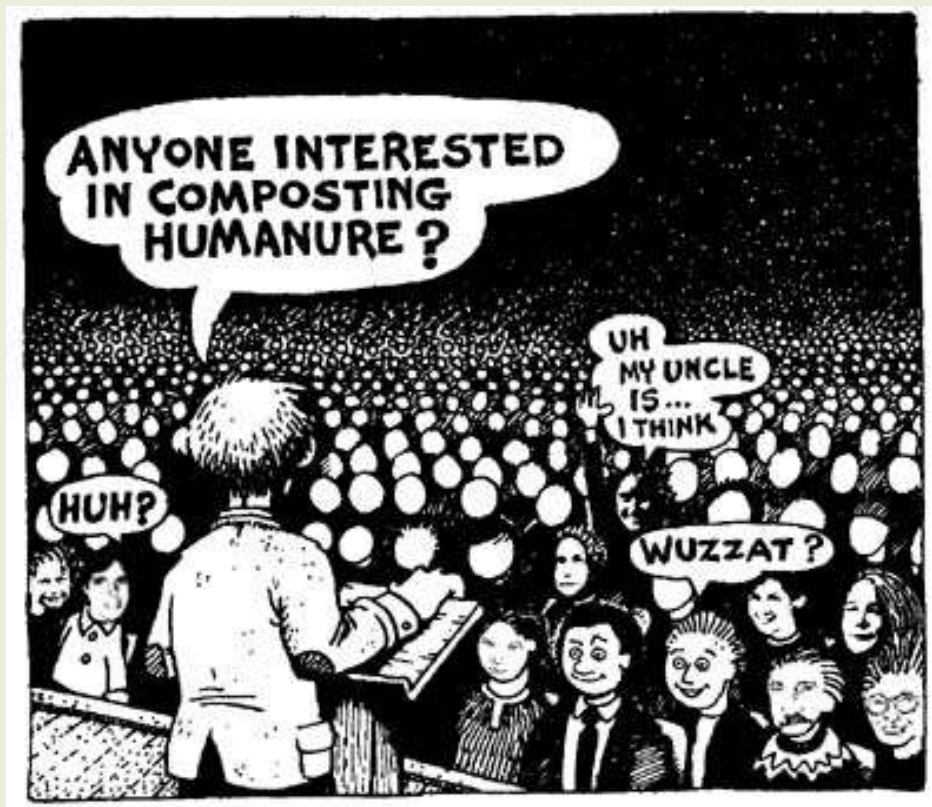



*Source: The Humanure Handbook. Jenkins Publishing, PO Box 607, Grove City, PA 16127. To order, phone: 1-800-639-4099.
<http://www.jenkinspublishing.com/>*

MENU: [HOME](#) » [Reconstruction](#) » [Recovery](#) » [Renewal](#) » [Survival](#) » [Humanure Content](#)

THE EGO VS. THE ECO

There are numerous theoretical reasons why we humans have strayed so far from a benign symbiotic relationship with the planet, and have instead taken on the visage, if not the behavior, of planetary pathogens. One of my favorites is “The Ego vs. The Eco” theory, also sometimes called the “Microcosm vs. the Macrocosm,” or, more simply, “Humans vs. Nature,” which I will attempt to explain in brief.

Human beings, like all living things on this planet, are inextricably intertwined with all of the elements of nature. We are threads in the tapestry of life. We constantly breathe the atmosphere that envelopes the planet; we drink the fluids that flow over the planet’s surface; we eat the organisms that grow from the planet’s skin. From the moment an egg and a sperm unite to spark our existence, each of us grows and develops from the elements provided by the Earth and sun. In essence, the soil, air, sun, and water combine within our mother’s womb to mold another living creature. Nine months later, another human being is born. That person is a separate entity, with an awareness of an individual self, an Ego. That person is also totally a part of, and completely dependent upon, the surrounding natural world, the Eco.

When the ego and the eco are balanced, the creature lives in harmony with the planet. In this theory, such a balance is considered to be the true meaning of *spirituality*, because the individual is a conscious part of, attuned to, and in harmony with a greater level of actual Being. When too much emphasis is placed on the self, the ego, an imbalance occurs and problems result, especially when that imbalance is collectively demonstrated by entire cultures. To suggest that these problems are only environmental, and therefore not of great concern, is incorrect. Environmental problems (damage to the eco) ultimately affect all living things, as all living things derive their existence, livelihood, and well-being from the planet. We cannot damage a thread in the web of life without the risk of fraying the entire tapestry.

When the ego gets blown out of proportion, we get thrown off balance in a variety of ways. Our educational institutions teach us to idolize the intellect, often at the expense of our moral, ethical, and spiritual development. Our economic institutions urge us to be consumers, and those who have gained the most material wealth are glorified. Our religious institutions often amount to little more than systems of human-worship, where divinity is only personified in human form, and only human creations (e.g., books and buildings) are considered sacred.

By emphasizing the intellect at the expense of intuition, creativity, and conscience, our educational systems yield spiritually imbalanced individuals. No discussion of a subject should be considered complete without an examination of its moral, philosophical, and ethical considerations, *as well* as a review of the intellectual and scientific data. When we ignore the ethics behind a particular issue, and

instead focus on intellectual achievements, it's great for our egos. We can pat ourselves on the back and tell ourselves how smart we are. It deflates our egos, on the other hand, to realize that we are actually insignificant creatures on a speck of dust in a corner of the universe, and that we are only one of the millions of life forms on this speck, all of whom must live together.

In recent decades, an entire generation of western scientists, a formidable force of intelligence, focused all its efforts on developing new ways to kill huge numbers of human beings all at once. This was the nuclear arms race of the 1950s through the present — a race that left us with environmental disasters yet to be cleaned up, a huge amount of natural materials gone to total waste (5.5 *trillion* dollars worth),¹ a military death toll consisting of hundreds of thousands of innocent non-combatants, and the threat of nuclear annihilation hanging over all of the peace-loving peoples of the world, even today. Surely this is an example of the collective ego being out of balance with the eco.

Religious movements that worship humans are ego-centered. It is ironic that a tiny, insignificant lifeform on a speck of dust at the edge of a galaxy lost somewhere in a corner of the universe would declare that the universe was created by one of their own kind. This would be a laughing matter if it were not taken so seriously by so many members of the human species, who insist on believing that the source of all life is another human, colloquially referred to as “God.”

We humans have evolved enough to know that the idea of a human-like creator-deity is simply myth. We can't begin to comprehend the full nature of our existence, so we *make up* a story that works until we figure out something better. Unfortunately, human-worship breeds an imbalanced collective ego. When we actually *believe* the myth, that humans are the pinnacle of life and the entire universe was created by one of our own kind, we go off the deep end. We stray too far from truth and wander, lost, with no point of reference to take us back to a balanced spiritual perspective we need for our own long-term survival on this planet. We become like a person knee deep in his own excrement, not knowing how to free himself from his unfortunate position, staring blankly at a road map with a look of utter incomprehension.

Today, new perspectives are emerging regarding the nature of human existence. The Earth itself is becoming recognized as a living entity, a level of Being immensely greater than the human level. The galaxy and universe are seen as even higher levels of Being, with multiverses (multiple universes) theorized as existing at a higher level yet. All of these levels of Being are thought to be imbued with the energy of life, as well as with a form of consciousness which we cannot even begin to comprehend. As we humans expand our knowledge of ourselves and recognize our true place in the vast scheme of things, our egos must defer to reality. We must admit our absolute dependence upon the ecosystem we call Earth, and try to balance our egotistical feelings of self-importance with our need to live in harmony with the greater world around us.

Getting back to compost, organic material, and soil nutrients, I must propose some additional philosophical speculation. Theoretically, the Asians evolved over the millennia with spiritual perspectives that maintained, to some extent, a view of the Earth, and of nature, as sacred. These

perspectives did not single out the human race as the pinnacle of creation, but instead recognized the totality of interconnected existence as divine, and advocated human harmony with that totality.

Contrast this to our western religious heritage which taught us that divinity lies only in human form, and that peoples who revere nature are “pagans,” “heathens,” “witches,” and worse. Admittedly, this is a broad and contentious topic, too broad for the scope of this book. Perhaps a few quotes here, however, will help to illustrate the point.

Hinduism, more common to India, but reaching into the Far East, seems to be sensitive to the sanctity of the natural world:

*“When Svetaketu, at his father’s bidding, had brought a ripe fruit from the banyan tree, his father said to him, Split the fruit in two, dear son.
Here you are. I have split it in two.
What do you find there?
Innumerable tiny seeds.
Then take one of the seeds and split it.
I have split the seed.
And what do you find there?
Why, nothing, nothing at all.
Ah, dear son, but this great tree cannot possibly come from nothing. Even if you cannot see with your eyes that subtle something in the seed which produces this mighty form, it is present nonetheless. That is the power, that is the spirit unseen, which pervades everywhere and is all things. Have faith! That is the spirit which lies at the root of all existence, and that also art thou, O Svetaketu.”*

(Chandogya Upanishad)²

Buddhism is a dominant influence in vast sections of Asia:

“May all living things be happy and at their ease! May they be joyous and live in safety! All beings, whether weak or strong — omitting none — in high, middle, or low realms of existence, small or great, visible or invisible, near or far away, born or to be born — may all beings be happy and at their ease! Let none deceive another, or despise any being in any state; let none by anger or ill will wish harm to another! Even as a mother watches over and protects her only child, so with a boundless mind should one cherish all living beings, radiating friendliness over the entire world, above, below and all around without limit; so let him cultivate a boundless good will toward the entire world, uncramped, free from ill will or enmity.”

The Metta Sutra³

Zen is a transliteration of the Sanskrit word “dyhana” meaning meditation, or more fully, “contemplation leading to a higher state of consciousness,” or “union with Reality.” It can be described as a blend of Indian mysticism and Chinese naturalism with a Japanese influence:

“When the mind rests serene in the oneness of things . . . dualism vanishes by itself.”

From the Hsis-hsis-ming by Seng-ts’an⁴

“Zen does not go along with the Judaic-Christian belief in a personal savior or a God — outside the Universe — who has created the cosmos and the human race. To the Zen view, the Universe is one indissoluble substance, one total whole, of which humanity is a part.”

Nancy Wilson Ross⁵

Confucius, like Buddha, was born in the sixth century B.C. and preached a philosophy of common Chinese virtue:

“The path of duty lies in what is near and people seek for it in what is remote. The work of duty lies in what is easy and people seek for it in what is difficult.”

Confucius⁶

The Tao (the way), written by Lao Tsu, a contemporary of Confucius, has provided one of the major underlying influences in Chinese thought and culture for 2,500 years:

“Those who know do not talk. Those who talk do not know. Keep your mouth closed. Guard your senses. Temper your sharpness. Simplify your problems. Mask your brightness. Be at one with the dust of the earth. This is primal union. He who has achieved this state is unconcerned with friends and enemies, with good and harm, with honor and disgrace. This therefore is the highest state of humanity.”

Lao Tsu⁷

Christianity, the primary religious influence of the western world, strongly supports the idea that humans are separate from and dominant over the natural world:

“And God said, Let us make man in our image, after our likeness, and let them have dominion over the fish of the sea, and over the fowl of the air, and over the cattle, and over all the earth, and over every creeping thing that creepeth on the earth. And God blessed them, and God said unto them, Be fruitful and multiply, and replenish the earth, and subdue it: and have dominion over the fish of the sea, and over the fowl of the air, and over every living thing that moveth upon the earth.”

Far Eastern religion has traditionally been imbued with the concepts of oneness, with the belief that the highest state of human evolution is one of harmony and peace with one's inner self and with the natural world. This would certainly seem to contribute to the development of sustainable agricultural methods. When one accepts the sacredness of life, one can easily understand why one should create compost and soil rather than waste and pollution.

For those of you readers who are devout Christians, this analysis of religious history is not intended to be "Christian-bashing," nor is it intended to offend anyone. Christianity must be singled out to some extent because the writer is writing from, and for, a culture that developed from an overwhelmingly Christian heritage. It is interesting to note that direct translations of Christian teachings from the Aramaic language (which Jesus spoke) as preserved in the Dead Sea Scrolls, indicate that Nature was, at that time, considered sacred by practicing Christians (refer to the translations of Edmund Bordeaux Szekeley). Those early teachings became buried under Biblical translations tailored to suit the European cultures of the late Middle Ages, which were hierarchic and male-dominated. Today, Christians can be among the most vocal defenders of the environment.

Historically, Christianity had periods that modern Christians would like to forget about, periods when the human egos involved grew to outrageous and terribly threatening proportions. During these times, male religious leaders claimed divinity and disbelievers were simply terrorized or destroyed. Those dark ages of Christianity adversely affected our understanding of the origins and nature of disease.

Unfortunately, *most* major religions today have drawn their focus toward human-worship, whether it be the Hindu worship of Krishna, the Buddhist worship of Buddha, the Islamic worship of Mohammed, the Christian worship of Jesus, or the bowing to the various human gurus and religious leaders which takes place all over the world. Patriarchal, hierarchic religious institutions still foster bloated egos the farther up the hierarchy one looks. Eventually, the human race will cast aside limiting, static, religious perspectives like a butterfly casts aside a cocoon. In the meantime, a metamorphosis must, and will, take place. That is what we should be focusing on, regardless of the religious institution to which we may currently belong.

Source: The Humanure Handbook. Jenkins Publishing, PO Box 607, Grove City, PA 16127. To order, phone: 1-800-639-4099.

<http://www.jenkinspublishing.com/>

MENU: [HOME](#) » [Reconstruction](#) » [Recovery](#) » [Renewal](#) » [Survival](#) » [Humanure Content](#)

ASIAN RECYCLING

The Asian people have recycled humanure for thousands of years. The Chinese have used humanure agriculturally since the Shang Dynasty 3-4000 years ago. Why haven't we westerners? The Asian cultures, namely Chinese, Korean, Japanese and others, evolved to understand human excrement to be a natural resource rather than a waste material. Where we have human waste, they have night soil. We produce waste and pollution; they historically have produced soil nutrients and food. It's clear to me that Asians have been more advanced than the western world in this regard. And they should be, since they've been working on developing sustainable agriculture for four thousand years on the same land. For *four thousand years* those people have worked the same land with little or no chemical fertilizers and, in many cases, have produced greater crop yields than western farmers, who are quickly destroying the soils of their own countries through depletion and erosion.

A fact largely ignored by people in western agriculture is that *agricultural land must produce a greater output over time. The human population is constantly increasing; available agricultural land is not. Therefore, our farming practices should leave us with land more fertile with each passing year.* However, we are doing just the opposite.

Back in 1938, the US Department of Agriculture came to the alarming conclusion that *a full 61% of the total area under crops in the US at that time had already been completely or partly destroyed, or had lost most of its fertility.*⁹ Nothing to worry about? We have artificial fertilizers, tractors, and oil to keep it all going. True, US agriculture is now heavily dependent upon fossil fuel resources. However, in 1993, we were importing about half our oil from foreign sources, and it's estimated that the US will be out of domestic oil reserves by 2020.¹⁰ A heavy dependence on foreign oil for our food production seems unwise *at best*, and probably just plain foolish, especially when we're producing soil nutrients every day in the form of organic refuse and throwing those nutrients "away" by burying them in landfills or incinerating them.

Why aren't we following the Asian example of agronutrient recycling? It's certainly not for a lack of information. Dr. F. H. King wrote an interesting book, published in 1910 titled Farmers of Forty Centuries.¹¹ Dr. King (D.Sc.) was a former chief of the Division of Soil Management of the US Department of Agriculture who traveled through Japan, Korea, and China in the early 1900s as an agricultural visitor. He was interested in finding out how people could farm the same fields for millennia without destroying their fertility. He states:

"One of the most remarkable agricultural practices adopted by any civilized people is the centuries long

and well nigh universal conservation and utilization of all human waste [sic] in China, Korea and Japan, turning it to marvelous account in the maintenance of soil fertility and in the production of food. To understand this evolution it must be recognized that mineral fertilizers so extensively employed in modern Western agriculture have been a physical impossibility to all people alike until within very recent years. With this fact must be associated the very long unbroken life of these nations and the vast numbers their farmers have been compelled to feed.

When we reflect upon the depleted fertility of our own older farm lands, comparatively few of which have seen a century's service, and upon the enormous quantity of mineral fertilizers which are being applied annually to them in order to secure paying yields, it becomes evident that the time is here when profound consideration should be given to the practices the Mongolian race has maintained through many centuries, which permit it to be said of China that one-sixth of an acre of good land is ample for the maintenance of one person, and which are feeding an average of three people per acre of farm land in the three southernmost islands of Japan.

[Western humanity] is the most extravagant accelerator of waste the world has ever endured. His withering blight has fallen upon every living thing within his reach, himself not excepted; and his besom of destruction in the uncontrolled hands of a generation has swept into the sea soil fertility which only centuries of life could accumulate, and yet this fertility is the substratum of all that is living.” [12](#)

According to King's research, the average daily excreta of the adult human weighs in at 40 ounces. Multiplied by 250 million, a rough estimate of the current US population, Americans each year produce 1,448,575,000 pounds of nitrogen, 456,250,000 pounds of potassium, and 193,900,000 pounds of phosphorous. Almost all is discarded into the environment as a waste material or a pollutant, or as Dr. King puts it, “poured into the seas, lakes or rivers and into the underground waters.”

According to King, “*The International Concession of the city of Shanghai, in 1908, sold to a Chinese contractor the privilege of entering residences and public places early in the morning of each day and removing the night soil, receiving therefor more than \$31,000 gold, for 78,000 tons of waste [sic]. All of this we not only throw away but expend much larger sums in doing so.*”

In case you didn't catch that, the contractor paid \$31,000 gold for the humanure, referred to as “night soil” and incorrectly as “waste” by Dr. King. People don't pay to buy waste, they pay money for things of value.

Furthermore, using Dr. King's figures, the US population today produces approximately 228,125,000,000 pounds of fecal material annually. That's 228 billion pounds. You could call that the *really* Gross National Product.

Admittedly, the spreading of raw human excrement on fields, as is done in Asia, will never become culturally acceptable in the United States, and rightly so. The agricultural use of raw night soil produces an assault to the sense of smell, and provides a route of transmission for various human disease

organisms. Americans who have traveled abroad and witnessed the use of raw human excrement in agricultural applications have largely been repulsed by the experience. That repulsion has instilled in many Americans an intransigent bias against, and even a fear of the use of humanure for soil enrichment. However, few Americans have witnessed the *composting* of humanure as a preliminary step in its recycling. Proper thermophilic composting converts humanure into a pleasant smelling material devoid of human pathogens.

Although the agricultural use of raw human excrement will never become a common practice in the US, the use of composted human refuse, including humanure, food refuse, and other organic municipal refuse such as leaves, can and should become a widespread and culturally encouraged practice in the United States. The act of composting humanure instead of using it raw will set Americans apart from Asians in regard to the recycling of human excrements, *for we too will have to constructively deal with all of our organic by-products eventually*. We can put it off, but not forever. As it stands now, at least many of the Asians are recycling much of their organic discards. We're not.

Source: The Humanure Handbook. Jenkins Publishing, PO Box 607, Grove City, PA 16127. To order, phone: 1-800-639-4099.

<http://www.jenkinspublishing.com/>

MENU: [HOME](#) » [Reconstruction](#) » [Recovery](#) » [Renewal](#) » [Survival](#) » [Humanure Content](#)

THE ADVANCES OF SCIENCE

How is it that Asian peoples developed an understanding of human nutrient recycling and we didn't? After all, we're the advanced, developed, scientific nation, aren't we? Dr. King makes an interesting observation concerning western scientists. He states: *"It was not until 1888, and then after a prolonged war of more than thirty years, generated by the best scientists of all Europe, that it was finally conceded as demonstrated that leguminous plants acting as hosts for lower organisms living on their roots are largely responsible for the maintenance of soil nitrogen, drawing it directly from the air to which it is returned through the processes of decay. But centuries of practice had taught the Far East farmers that the culture and use of these crops are essential to enduring fertility, and so in each of the three countries the growing of legumes in rotation with other crops very extensively, for the express purpose of fertilizing the soil, is one of their old fixed practices."* ¹³

In western culture, we wait for the experts to figure things out before we claim any real knowledge. This appears to have put us several centuries behind the Asians. It certainly seems odd that people who gain their knowledge in real life through practice and experience are largely ignored or trivialized by the academic world and associated government agencies. Such agencies only credit learning that has taken place within an institutional framework. As such, it's no wonder that Western humanity's crawl toward a sustainable existence on the planet Earth is so pitifully slow.

"Strange as it may seem," says King, *"there are not today and apparently never have been, even in the largest and oldest cities of Japan, China or Korea, anything corresponding to the hydraulic systems of sewage disposal used now by Western nations. When I asked my interpreter if it was not the custom of the city during the winter months to discharge its night soil into the sea, as a quicker and cheaper mode of disposal [than recycling], his reply came quick and sharp, 'No, that would be waste. We throw nothing away. It is worth too much money.'*" ¹⁴ *"The Chinaman,"* says King, *"wastes nothing while the sacred duty of agriculture is uppermost in his mind."* ¹⁵

Perhaps, a few centuries from now, we also will understand.

Source: *The Humanure Handbook*. Jenkins Publishing, PO Box 607, Grove City, PA 16127. To order, phone: 1-800-639-4099.

<http://www.jenkinspublishing.com/>

MENU: [HOME](#) » [Reconstruction](#) » [Recovery](#) » [Renewal](#) » [Survival](#) » [Humanure Content](#)

MENU: [HOME](#) » [Reconstruction](#) » [Recovery](#) » [Renewal](#) » [Survival](#) » [Humanure Content](#)

WHEN THE CRAP HIT THE FAN

While the Asians were practicing sustainable agriculture and recycling their organic resources and doing so over millennia, what were the people of the west doing? What were the Europeans and those of European descent doing? Why weren't our ancestors returning their manures to the soil, too? After all, it does make sense. The Asians who recycled their manures not only recovered a resource and reduced pollution, but by returning their excrement to the soil, they succeeded in reducing threats to their health. There was no putrid sewage collecting and breeding disease germs. Instead, the humanure was, for the most part, undergoing a natural, non-chemical purification process in the soil which required no technology.

Granted, a lot of "night soil" in the Far East today is not composted and is the source of health problems. However, even the returning of humanure raw to the land succeeds in destroying many human pathogens in the manure, and it also returns nutrients to the soil. Let's take a look at what was happening in Europe regarding public hygiene from the 1300s on. Great pestilences swept Europe throughout recorded history. The Black Death killed more than half the population of England in the fourteenth century. In 1552, 67,000 patients died of the Plague in Paris alone. Fleas from infected rats were the carriers of this disease. Did the rats dine on human waste? Other pestilences included the sweating sickness (attributed to uncleanness), cholera (spread by food and water contaminated by the excrement of infected persons), "jail fever" (caused by a lack of sanitation in prisons), typhoid fever (spread by water contaminated with infected feces), and numerous others.

Andrew D. White, cofounder of Cornell University, writes, "*Nearly twenty centuries since the rise of Christianity, and down to a period within living memory, at the appearance of any pestilence the Church authorities, instead of devising sanitary measures, have very generally preached the necessity of immediate atonement for offenses against the Almighty. In the principal towns of Europe, as well as in the country at large, down to a recent period, the most ordinary sanitary precautions were neglected, and pestilences continued to be attributed to the wrath of God or the malice of Satan.*" ¹⁶

It's now known that the main cause of such immense sacrifice of life was a lack of proper hygienic practices. It's argued that certain theological reasoning at that time resisted the evolution of proper hygiene. According to White, "*For century after century the idea prevailed that filthiness was akin to holiness.*" Living in filth was regarded by holy men as evidence of sanctity, according to White, who lists numerous saints who never bathed parts or all of their bodies, such as St. Abraham, who washed neither his hands nor his feet for fifty years, or St. Sylvia, who never washed any part of her body except her fingers.¹⁷

Interestingly, after the Black Death left its grim wake across Europe, “*an immensely increased proportion of the landed and personal property of every European country was in the hands of the church.*” ¹⁸ Apparently, the church was reaping some benefit from the deaths of huge numbers of people. Perhaps the church had a vested interest in maintaining public ignorance about the sources of disease. This insinuation is almost too diabolical for serious consideration. Or is it?

Somehow, the idea developed around the 1400s that Jews and witches were causing the pestilences. Jews were suspected because they didn’t succumb to the pestilences as readily as the Christian population did, presumably because they employed a unique sanitation system more conducive to cleanliness, including the eating of kosher foods. Not understanding this, the Christian population arrived at the conclusion that the Jews’ immunity resulted from protection by Satan. As a result, attempts were made in all parts of Europe to stop the plagues by torturing and murdering the Jews. Twelve thousand Jews were reportedly burned to death in Bavaria alone during the time of the plague, and additionally thousands more were likewise killed throughout Europe.¹⁹

In 1484, the “infallible” Pope Innocent VIII issued a proclamation supporting the church’s opinion that witches were causes of disease, storms, and a variety of ills affecting humanity. The feeling of the church was summed up in one sentence: “*Thou shalt not suffer a witch to live.*” From the middle of the sixteenth to the middle of the seventeenth centuries, women and men were sent to torture and death by the thousands, by both Protestant and Catholic authorities. It’s estimated that the number of victims sacrificed during that century in Germany alone was over a hundred thousand.

The following case in Milan, Italy, summarizes the ideas of sanitation in Europe during the seventeenth century:

The city was under the control of Spain, and it had received notice from the Spanish government that witches were suspected to be en route to Milan to “anoint the walls” (smear the walls with disease-causing ointments). The church rang the alarm from the pulpit, putting the population on the alert. One morning, in 1630, an old woman looking out of her window saw a man who was walking along the street wipe his fingers on a wall. He was promptly reported to the authorities. He claimed he was simply wiping ink from his fingers which had rubbed off the ink-horn he carried with him. Not satisfied with this explanation, the authorities threw the man into prison and tortured him until he “confessed.” The torture continued until the man gave the names of his “accomplices,” who were subsequently rounded up and tortured. They in turn named *their* “accomplices” and the process continued until members of the foremost families were included in the charges. Finally, a large number of innocent people were sentenced to their deaths, all reportedly a matter of record.²⁰

One loathsome disease of the 1500s through the 1700s was the “jail fever.” The prisons of that period were filthy. People were confined in dungeons connected to sewers with little ventilation or drainage. Prisoners incubated the disease and spread it to the public, especially to the police, lawyers and judges. In 1750, for example, the disease killed two judges, the lord mayor, various aldermen, and many others in London, not to mention prisoners.²¹

The pestilences at that time in the Protestant colonies in America were also attributed to divine wrath or satanic malice, but when the pestilences afflicted the Native Americans, they were considered acts of divine mercy. *“The pestilence among the Indians, before the arrival of the Plymouth Colony, was attributed in a notable work of that period to the Divine purpose of clearing New England for the heralds of the gospel.”* [22](#)

Perhaps the reason the Asian countries have such large populations in comparison to Western countries is because they escaped some of the pestilences common to Europe, especially pestilences spread by the failure to responsibly recycle human excrement. They presumably plowed their manure back into the land because their spiritual perspectives supported such behavior. Westerners were too busy burning witches and Jews with the church’s wholehearted assistance to bother thinking about recycling humanure.

Our ancestors did, eventually, come to understand that poor hygiene was a causal factor in epidemic diseases. Nevertheless, it was not until the late 1800s in England that improper sanitation and sewage were suspected as causes of epidemics. At that time, large numbers of people were still dying from pestilences, especially cholera, which killed at least 130,000 people in England in 1848-9 alone. In 1849, an English medical practitioner published the theory that cholera was spread by water contaminated with sewage. Ironically, even where sewage was being piped away from the population, the sewers were still leaking into drinking water supplies.

The English government couldn’t be bothered with the fact that hundreds of thousands of mostly poor citizens were perishing like flies year after year. So it rejected a Public Health Bill in 1847. A Public Health Bill finally became an Act in 1848 in the face of the latest outbreak, but wasn’t terribly effective. However, it did bring poor sanitation to the attention of the public, as the following statement from the General Board of Health (1849) implies: *“Householders of all classes should be warned that their first means of safety lies in the removal of dung heaps and solid and liquid filth of every description from beneath or about their houses and premises.”* This may make one wonder if a compost pile would have been considered a “dung heap” in those days, and therefore banned.

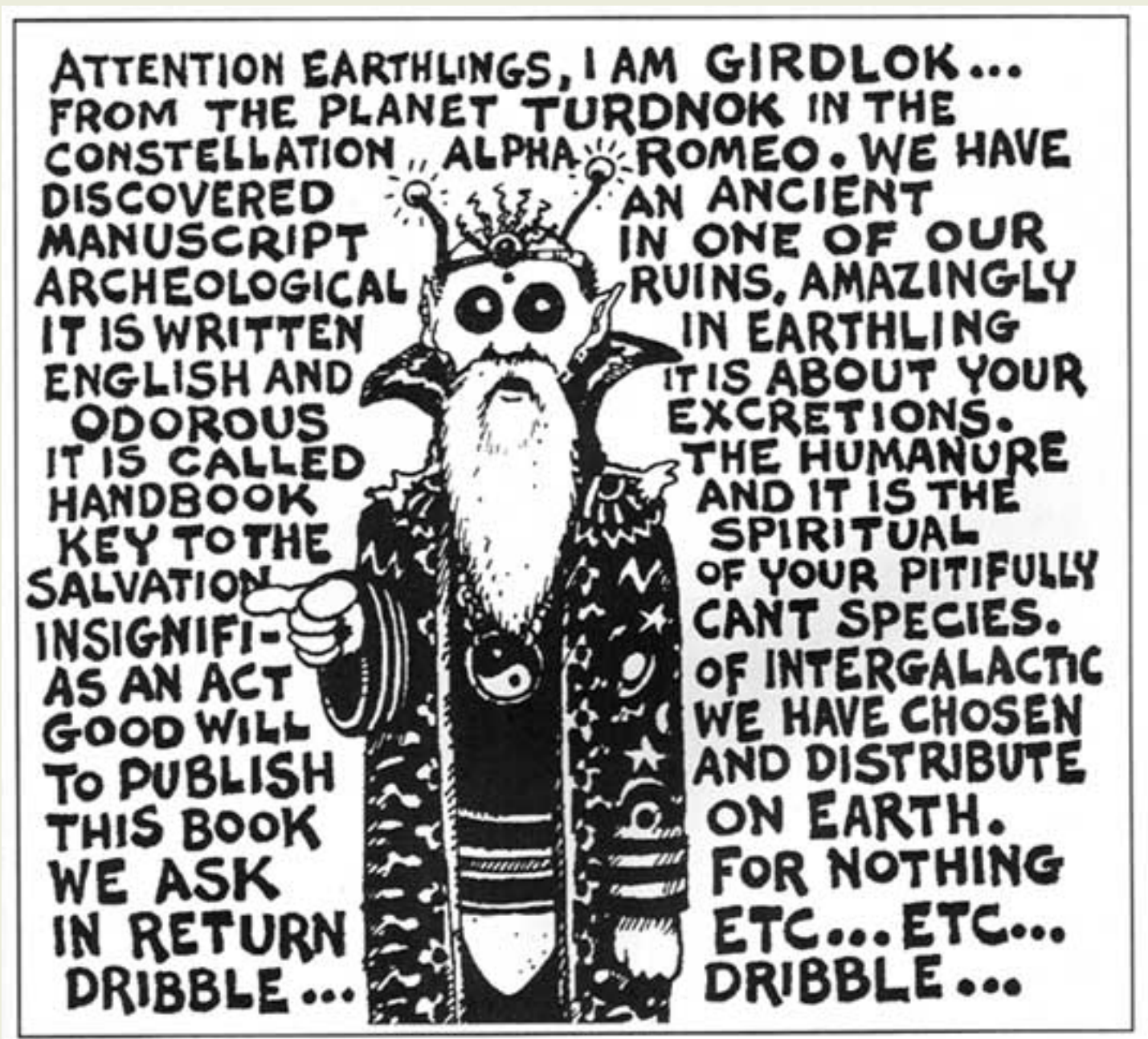

Sanitation in England was so bad in the mid to late eighteenth centuries that, “In 1858, when the Queen and Prince Albert had attempted a short pleasure cruise on the Thames, its malodorous waters drove them back to land within a few minutes. That summer a prolonged wave of heat and drought exposed its banks, rotten with the sewage of an overgrown, undrained city. Because of the stench, Parliament had to rise early.” Another story describes Queen Victoria gazing out over the river and asking aloud what the pieces of paper were that so abundantly floated by. Her companion, not wanting to admit that the Queen was looking at pieces of used toilet paper, replied, “Those, Ma’am, are notices that bathing is forbidden.” ²³

The wealthy folks, including the Tories or “conservatives” of the English government still thought that spending on social services was a waste of money and an unacceptable infringement by the government on the private sector (sound familiar?). A leading newspaper, “The Times,” maintained that the risk of

cholera was preferable to being bullied by the government into providing sewage services. However, a major Act was finally passed in 1866, the Public Health Act, with only grudging support from the Tories. Once again, cholera was raging through the population, and it's probably for that reason that any act was passed at all. Finally, by the end of the 1860s, a framework of public health policy was established in England. Thankfully, the cholera epidemic of 1866 was the last and the least disastrous.²⁴

The powers of the church eventually diminished enough for physicians to have their much delayed say about the origins of disease. Today, the church is no longer an obstacle to the progress of society, and in many cases acts as a force for peace, justice, and environmental awareness in the western world.

Our modern sanitation systems have finally yielded a life safe for most of us, although not without shortcomings. The eventual solution developed by the west was to collect humanure in water and discard it, perhaps chemically treated, incinerated, or dehydrated — into the seas, into the atmosphere, onto the surface of the land, and into landfills.

Source: The Humanure Handbook. Jenkins Publishing, PO Box 607, Grove City, PA 16127. To order, phone: 1-800-639-4099.

<http://www.jenkinspublishing.com/>

MENU: [HOME](#) » [Reconstruction](#) » [Recovery](#) » [Renewal](#) » [Survival](#) » [Humanure Content](#)

ASIAN UPDATE

It would be naive to suggest that the Asian societies are perfect by any stretch of the imagination. Asian history is rife with the problems that have plagued humanity since the first person crawled on this planet. Those problems include such things as oppressive rule by the rich, war, famine, natural catastrophes, oppressive rule by heathens, more war, and now overpopulation.

Today, Asians are abandoning the harmonious agricultural techniques that Dr. King observed nearly a century ago. In Kyoto, Japan, for example, *“night soil is collected hygienically to the satisfaction of users of the system, only to be diluted at a central collection point for discharge to the sewer system and treatment at a conventional sewage treatment plant.”* [25](#)

A Humanure Handbook reader wrote an interesting account of Japanese toilets in a letter to the author, which is paraphrased here:

“I just got through reading your Humanure Handbook. This is the book of the year! Your book really opened my eyes about humanure. I never even thought about using sawdust/leaves/hay as a solution to odors and about thermophilic composting. How brilliant! My only real experience, outside of continuously composting yard refuse/kitchen scraps either in an open pile or directly burying them and then using them on my vegetable garden for over twenty years, comes from living in Japan from 1973-1983. I’ll take this opportunity to tell you all I directly experienced about their humanure recycling. As my experience is dated, things may have changed (probably for the worse as toilets and life were becoming ‘westernized’ even toward the end of my stay in Japan).”

My experience comes from living in small, rural towns as well as in metropolitan areas (provincial capitals) from 1973-1983. Homes/businesses had an ‘indoor outhouse.’ The Vault: Nothing but urine/feces were deposited into the large metal vault under the toilet (squat style, slightly recessed in the floor and made of porcelain). No cover material or carbonaceous stuff was used. It stunk !! Not just the bathroom, but the whole house! There were many flies, even though the windows were screened. Maggots were the main problem. They crawled up the sides of the vault onto the toilet and floor and sometimes even made it outside the bathroom into the hall. People constantly poured some kind of toxic chemical into the vaults to control the smell and maggots. (It didn’t help — in fact, the maggots really poured out of the vault to escape the chemicals.) Occasionally a slipper

(one put on special ‘bathroom slippers’ as opposed to ‘house slippers’ when entering the bathroom) fell into the disgusting liquid/maggot filled vault. You couldn’t even begin to think about getting it out! You couldn’t let little children use the toilet without an adult suspending them over it. They might fall in! Disposal: When the vault was full (about every three months), you called a private vacuum truck which used a large hose placed in an outside opening to suck out the liquid mass. You paid them for their services. I’m not sure exactly what happened to the humanure next but, in the agricultural areas near the fields were large (10 feet in diameter) round, concrete, raised containers, similar in looks to an above ground swimming pool. In the containers, I was told, was the humanure from the ‘vacuum trucks.’ It was a greenish-brown liquid with algae growing on the surface. I was told this was spread onto agricultural fields.” E.A. in IL

In 1952, about 70% of Chinese humanure was recycled. This had increased to 90% by 1956, and constituted a third of all fertilizer used in the country.²⁶ Lately, however, humanure recycling in China seems to be going downhill. The use of synthetic fertilizers has risen over 600% between the mid 1960s to the mid 1980s, and now China’s average annual fertilizer usage per hectare is estimated to be double that of the world’s average. Between 1949 and 1983, agricultural nitrogen and phosphorous inputs increased by a factor of ten, while agricultural yields only tripled.²⁷

Water pollution in China began to increase in the 1950s due to the discarding of sewage into water. Now, about 70% of China’s wastewater is said to be dumped into China’s main rivers. By 1992, 45 billion tonnes of wastewater were flowing into China’s rivers and lakes annually, 70% untreated. In urban areas, 80% of the surface water is polluted with nitrogen and ammonia, and most lakes around cities have become dumping grounds for large quantities of sewage. It is estimated that 450,000 tonnes of humanure are dumped into the Huangpu River alone in a year. Half a million cases of hepatitis A, spread by polluted water, occurred in Shanghai in 1988. Soilborne diseases, practically non-existent in China twenty years ago, are now also causing problems. *“Increasingly, Chinese urban authorities are turning to incineration or landfill as the ways of disposing of their solid wastes rather than recycling and composting, which means that China, like the west, is putting the problem onto the shoulders of future generations.”* ²⁸

For a sense of historical perspective, I’ll leave you with a quote from Dr. Arthur Stanley, health officer of the city of Shanghai, China, in his annual report for 1899, when the population of China amounted to about 500 million people, roughly double that of the US today. At that time, no artificial fertilizers were employed for agricultural purposes — only organic, natural materials such as agricultural residues and humanure were being used:

“Regarding the bearing on the sanitation of Shanghai of the relationship between Eastern and Western hygiene, it may be said, that if prolonged national life is indicative of sound sanitation, the Chinese are a race worthy of study by all who concern themselves with public health. It is evident that in China the birth rate must very considerably exceed the death rate, and have done so in an average way during the three or four thousand years that the Chinese nation has existed. Chinese hygiene, when compared to medieval English, appears to advantage.” ²⁹

Sounds like an understatement to me.

Source: The Humanure Handbook. Jenkins Publishing, PO Box 607, Grove City, PA 16127. To order, phone: 1-800-639-4099.

<http://www.jenkinspublishing.com/>

MENU: [HOME](#) » [Reconstruction](#) » [Recovery](#) » [Renewal](#) » [Survival](#) » [Humanure Content](#)

MENU: [HOME](#) » [Reconstruction](#) » [Recovery](#) » [Renewal](#) » [Survival](#) » [Humanure Content](#)

COMPOSTING TOILETS MUST BE MANAGED

We have used flush toilets for so long that after we defecate we expect to simply pull a handle and walk away. Some think that composting toilets should behave in the same manner. However, flush toilets are *disposal* devices that create pollution and waste soil nutrients. Composting toilets are recycling devices that should create no pollution and should recover the soil nutrients in human manure and urine. When you push a handle on a flush toilet, you're paying someone to dispose of your waste for you. Not only are you paying for the water, for the electricity, and for the wastewater treatment costs, but you are also contributing to the environmental problems inherent in waste disposal. When you use a composting toilet, you are getting paid for the small amount of effort you expend in recycling your organic material. Your payment is in the form of compost. Composting toilets, therefore, require some management. You have to *do* something besides just pushing a handle and walking away.

The degree of your involvement will depend on the type of toilet you are using. In most cases, this involves simply adding some clean organic cover material such as peat moss, sawdust, rice hulls, or leaf mould to the toilet after each use. Instead of flushing, you cover. Nevertheless, someone must take responsibility for the overall management of the toilet. This is usually the homeowner, or someone else who has volunteered for the task. Their job is simply to make sure sufficient cover materials are available and being used in the toilet. They must also add bulking materials to the toilet contents when needed, and make sure the toilet is not being used beyond its capacity, not becoming waterlogged, and not breeding flies. Remember that a composting toilet houses an organic mass with a high level of microscopic biodiversity. The contents are alive, and must be watched over and managed to ensure greatest success.

Source: The Humanure Handbook. Jenkins Publishing, PO Box 607, Grove City, PA 16127. To order, phone: 1-800-639-4099.

<http://www.jenkinspublishing.com/>

MENU: [HOME](#) » [Reconstruction](#) » [Recovery](#) » [Renewal](#) » [Survival](#) » [Humanure Content](#)

MENU: [HOME](#) » [Reconstruction](#) » [Recovery](#) » [Renewal](#) » [Survival](#) » [Humanure Content](#)

FECOPHOBIA AND THE PATHOGEN ISSUE

The belief that humanure is unsafe for agricultural use is called *fecophobia*, a term, I admit, I made up. People who are fecophobic can suffer from severe fecophobia or a relatively mild fecophobia, the mildest form being little more than a healthy concern about personal hygiene. Severe fecophobics do not want to use humanure for food growing, composted or not. They believe that it's dangerous and unwise to use such a material in their garden. Milder fecophobics may, however, compost humanure and use the finished compost in horticultural applications. People who are not fecophobic may compost humanure and utilize it in their food garden. Some may even use it raw, a practice *not* recommended by the author.

It is well known that humanure contains the *potential* to harbor disease-causing microorganisms (pathogens). This potential is directly related to the state of health in the population which is producing the excrement. If a family is composting its own humanure, for example, and it is a healthy family, the danger in the production and use of the compost will be very low. If one is composting the humanure from orphanages in Haiti where intestinal parasites are endemic, then extra precautions must be taken to ensure maximum pathogen death. Compost temperatures must rise significantly above the temperature of the human body (37°C or 98.6°F) in order to begin eliminating disease-causing organisms, as human pathogens thrive at temperatures similar to that of their hosts. On the other hand, most pathogens only have a limited viability outside the human body, and given enough time, will die even in low-temperature compost.

Humanure is best rendered hygienically safe by thermophilic composting. To achieve this, humanure can simply be collected and deposited on an outdoor compost pile like any other compost material. Open-air, outdoor compost piles with good access are easily managed and offer a no-cost, odorless method to achieve the thermophilic composting of humanure. However, such a system does require the regular collection and cartage of the organic material to the compost pile, making it relatively labor intensive when compared to low-temperature, stationary, homemade and commercial composting toilets.

Many people will use a composting toilet only if they do not have to do anything in any way related to the toilet contents. Therefore, most homemade and commercial composting toilets are comprised of large composting chambers under the toilet seat. The organic material is deposited directly into a composting chamber, and the contents are emptied only very occasionally.

Thermophilic conditions do not seem to be common in these toilets, for several reasons. For one, many commercial composting toilets are designed to *dehydrate* the organic material deposited in them. This

dehydration is achieved by electrical fans, which rob the organic mass of moisture and heat. Commercial toilets also often strive to reduce the *quantity* of material collecting in the composting chamber (mostly by dehydration), in order to limit the frequency of emptying for the sake of the convenience of the user. Bulky air-entrapping additions to the compost are not encouraged, although these additions will encourage thermophilic composting. Yet, even passive, low-temperature composting will eventually yield a relatively pathogen-free compost after a period of time.

Low-temperature composting toilets include most commercial and many homemade units. According to current scientific evidence, a few months retention time in just about any composting toilet will result in the deaths of nearly all human pathogens ([see Chapter 7](#)). The most persistent pathogen seems to be the roundworm (*Ascaris lumbricoides*) and particularly the egg of the roundworm, which is protected by an outer covering which resists chemicals and adverse environmental conditions. Estimates of the survival time of *Ascaris* eggs in certain soil types under certain conditions are as high as ten years. Although the *Ascaris* eggs are readily destroyed by thermophilic composting, they may survive in conditions generated by a low-temperature toilet. This is why the compost resulting from such toilets is generally not recommended for garden use if it comes in contact with food crops.

People can become rather obsessive about this issue. One man who published a book on this topic wrote to me to say that a two year retention time in a low-temperature composting toilet is generally considered adequate for the destruction of *Ascaris* ova (eggs). He indicated that he would never consider using his own low-temperature compost until it had aged at least two years. I asked him if he was infected with roundworms. He said no. I asked him if anyone else was using his toilet. No. I asked him what he was worried about then. Why would he think there could be roundworm eggs in his compost when he knew he didn't have roundworms in the first place? Sometimes common sense is not so common. The *potential* dangers of humanure can be blown way out of proportion. This is similar to the phobic person who would never go to a movie theater because there may be someone in the theater who has tuberculosis and who may sneeze. Although this is a risk we all take, it's not likely to be a problem.

Source: The Humanure Handbook. Jenkins Publishing, PO Box 607, Grove City, PA 16127. To order, phone: 1-800-639-4099.

<http://www.jenkinspublishing.com/>

MENU: [HOME](#) » [Reconstruction](#) » [Recovery](#) » [Renewal](#) » [Survival](#) » [Humanure Content](#)

OWNER-BUILT COMPOSTING TOILETS

Owner-built composting toilets are in widespread use throughout the world since many people do not have the financial resources required to purchase commercially produced toilets. They tend to be low-temperature composting toilets, although they can conceivably be thermophilic toilet systems if properly managed.

The objectives of any composting toilet should be to achieve safe and sanitary treatment of fecal material, to conserve water, to function with a minimum of maintenance and energy consumption, to operate without unpleasant odors, and to recycle humanure for agricultural use.

The primary advantage of low-temperature toilets is the passive involvement of the user. The toilet collection area need not be entered into very often unless, perhaps, to rake the pile flat. The pile that collects in the chamber must be raked somewhat every few months (which can be done through a floor access door), and the chamber is emptied only after nothing has been deposited in it for at least a year or two, although this time period may vary depending on the individual system used.

In order for this system to work well, each toilet must have two chambers. Fecal material and urine are deposited into the first chamber until it's full, then the second chamber is used while the first ages. By the time the second side is full, the first should be ready to empty. It may take several years to fill a side, depending on its capacity and the number of users. In addition to feces, carbonaceous organic matter such as sawdust, as well as bulky vegetable matter such as straw and weeds, are regularly added to the chamber in use. A clean cover of such material is maintained over the compost at all times for odor prevention (see Figure 6.1).

Some of these composting toilets involve the separation of urine from feces. This is done by urinating into a separate container or into a diversion device which causes the urine to collect separately from the feces. The reason for separating urine from feces is that the urine/feces blend contains too much nitrogen to allow for effective composting and the collected material can get too wet and odorous. Therefore, the urine is collected separately, reducing the nitrogen, the liquid content, and the odor of the collected material (see Figure 6.2).

An alternative method of achieving the same result which does not require the separation of urine from feces does exist. Organic material with too much nitrogen for effective composting (such as a urine/feces mixture) can be balanced by adding more carbon material such as sawdust, rather than by removing the

urine. The added carbon material absorbs the excess liquid and will cover the refuse sufficiently to eliminate odor completely. This also sets the stage for thermophilic composting because of the carbon/nitrogen balancing.

One may also “precharge” the toilet with a “biological sponge,” a thick layer of absorbent cellulose material filling the bottom of the compost chamber to a depth of up to 50% of its capacity. Some suggest that the toilet can be filled to 100% of its capacity before beginning to be used, because if the material is loose (such as loose hay), it will compress under the weight of the added humanure. A bottom sponge may consist of bales of hay or straw buried in sawdust. These materials absorb the excess urine as it is added to the toilet. Fecal material is covered after each use with materials such as sawdust, peat, leaf mould, or rice hulls. A drain into a five gallon bucket (perhaps pre-filled with sawdust) will collect any leachate, which can simply be deposited back on the compost pile. Extra bulking materials such as straw, weeds, hay, and food scraps are regularly added to the compost chamber to help oxygenate and feed the growing organic mass in order to promote thermophilic decomposition. Ventilation can be enhanced by utilizing a vertical pipe installed like a chimney, which will allow air to passively circulate into and out of the compost chamber.

Such systems will need to be custom-managed according to the circumstances of the individuals using them. Someone needs to keep an eye on the toilet chambers to make sure they’re receiving enough bulking material. The deposits need to be flattened regularly so that they remain covered and odorless. Chutes that channel humanure from the toilet seat to the compost chamber must be cleaned regularly in order to prevent odors. When one compost chamber is filled, it must be rested while the other is filled. A close eye on the toilet contents will prevent waterlogging. Any leachate system must be monitored. In short, any composting toilet will require some management. Remember that you are actively recycling organic material, and that means you are *doing* something constructive. When you consider the value of the finished compost, you can also consider this: every time you deposit into a composting toilet, it’s as if you’re putting money in the bank.

Homemade low temperature composting toilets offer a method of composting humanure that is attractive to persons wanting a low-maintenance, low-cost, fairly passive approach to excrement recycling. Any effort which constructively returns organic refuse to the soil without polluting water or the environment certainly demands a high level of commendation.

Source: The Humanure Handbook. Jenkins Publishing, PO Box 607, Grove City, PA 16127. To order, phone: 1-800-639-4099.

<http://www.jenkinspublishing.com/>

MENU: [HOME](#) » [Reconstruction](#) » [Recovery](#) » [Renewal](#) » [Survival](#) » [Humanure Content](#)

ASIAN COMPOSTING

It is well known that Asians have recycled humanure for centuries, possibly millennia. How did *they* do it? Historical information concerning the *composting* of humanure in Asia seems difficult to find. Rybczynski et al. state that composting was only introduced to China in a systematic way in the 1930s and that it wasn't until 1956 that composting toilets were used on a wide scale in Vietnam.¹ On the other hand, Franceys et al. tell us that composting "*has been practiced by farmers and gardeners throughout the world for many centuries.*" They add that, "*In China, the practice of composting [humanure] with crop residues has enabled the soil to support high population densities without loss of fertility for more than 4000 years.*"²

However, a book published in 1978 and translated directly from the original Chinese indicates that composting has not been a cultural practice in China until only recently. An agricultural report from the Province of Hopei, for example, states that the standardized management and hygienic disposal (i.e., composting) of excreta and urine was only initiated there in 1964. The composting techniques being developed at that time included the segregation of feces and urine, which were later "*poured into a mixing tank and mixed well to form a dense fecal liquid*" before piling on a compost heap. The compost was made of 25% human feces and urine, 25% livestock manure, 25% miscellaneous organic refuse, and 25% soil.³

Two *aerobic* methods of composting were reported to be in widespread use in China, according to the 1978 report. The two methods are described as: 1) surface aerobic continuous composting; and 2) pit aerobic continuous composting. The surface method involves constructing a compost pile around an internal framework of bamboo, approximately nine feet by nine feet by three feet high (3m x 3m x 1m). Compost ingredients include fecal material (both human and non-human), organic refuse, and soil. The bamboo is removed from the constructed pile and the resultant holes allow for the penetration of air into this rather large pile of refuse. The pile is then covered with earth or an earth/horse manure mix, and left to decompose for 20 to 30 days, after which the composted material is used in agriculture.

The pit method involves constructing compost pits five feet wide and four feet deep by various lengths, and digging channels in the floor of the pits. The channels (one lengthwise and two widthwise) are covered with coarse organic material such as millet stalks, and a bamboo pole is placed vertically along the walls of the pit at the end of each channel. The pit is then filled with organic refuse and covered with earth, and the bamboo poles are removed to allow for air circulation.⁴

A report from a hygienic committee of the Province of Shantung provides us with additional information on Chinese composting.⁵ The report lists three traditional methods used in that province for the recycling of humanure:

- 1) Drying it — “*Drying has been the most common method of treating human excrement and urine for years.*” It is a method that causes a significant loss of nitrogen;
- 2) Using it raw, a method that is well known for pathogen transmission; and
- 3) “*Connecting the household pit privy to the pigpen . . . a method that has been used for centuries.*” An unsanitary method in which the excrement was simply eaten by a pig.

No mention is made whatsoever of *composting* being a traditional method used by the Chinese for recycling humanure. On the contrary, all indications were that the Chinese government in the 1960s was, *at that time*, attempting to establish composting as preferable to the three traditional recycling methods listed above, mainly because the three methods were hygienically unsafe, while composting, when properly managed, would destroy pathogens in humanure while preserving agriculturally valuable nutrients. This report also indicated that soil was being used as an ingredient in the compost, or, to quote directly, “*Generally, it is adequate to combine 40-50% of excreta and urine with 50-60% of polluted soil and weeds.*”

For further information on Asian composting, I must defer to Rybczynski et al., whose World Bank research on low-cost options for sanitation considered over 20,000 references and reviewed approximately 1200 documents. Their review of Asian composting is brief, but includes the following information, which I have condensed:

There are no reports of composting privys (toilets) being used on a wide scale until the 1950s, when the Democratic Republic of Vietnam initiated a five-year plan of rural hygiene and a large number of *anaerobic* composting toilets were built. These toilets, known as the Vietnamese Double Vault, consisted of two above ground water-tight tanks, or *vaults*, for the collection of humanure (see Figure 6.3). For a family of five to ten people, each vault was required to be 1.2 m wide, 0.7 m high, and 1.7 m long (approximately 4 feet wide by 28 inches high and 5 feet 7 inches long). One tank is used until full and left to decompose while the other tank is used. The use of this sort of composting toilet requires the segregation of urine, which is diverted to a separate receptacle through a groove on the floor of the toilet. Fecal material is collected in the tank and covered with soil, where it anaerobically decomposes. Kitchen ashes are added to the fecal material for the purpose of reducing odor.

Eighty-five percent of intestinal worm eggs, one of the most persistently viable forms of human pathogens, were found to be destroyed after a two month composting period in this system. However, according to Vietnamese health authorities, forty-five days in a sealed vault is adequate for the complete destruction of all bacteria and intestinal parasites (presumably they mean pathogenic bacteria). Compost from such latrines is reported to increase crop yields by 10-25% in comparison to the use of raw

humanure. The success of the Vietnamese Double Vault required “*long and persistent health education programs.*” ⁶

When the Vietnamese Double Vault composting toilet system was exported to Mexico and Central America, the result was “*overwhelming positive,*” according to one source, who adds, “*Properly managed there is no smell and no fly breeding in these toilets. They seem to work particularly well in the dry climate of the Mexican highlands. Where the system has failed (wetness in the processing chamber, odours, fly breeding) it was usually due to non-existent, weak, or bungled information, training and follow-up.*” ⁷ A lack of training and a poor understanding of the composting processes can cause any humanure composting system to become problematic. Conversely, complete information and an educated interest will ensure the success of humanure composting systems.

Another anaerobic double-vault composting toilet used in Vietnam includes using both fecal material *and* urine. In this system, the bottom of the vaults are perforated to allow drainage, and urine is filtered through limestone to neutralize acidity. Other organic refuse is also added to the vaults, and ventilation is provided via a pipe.

In India, the *composting* of organic refuse and humanure is advocated by the government. A study of such compost prepared in pits in the 1950s showed that intestinal worm parasites and pathogenic bacteria were completely eliminated in three months. The destruction of pathogens in the compost was attributed to the maintenance of a temperature of about 40°C (104°F) for a period of 10-15 days. However, it was also concluded that the compost pits had to be properly constructed and managed, and the compost not removed until fully “ripe,” in order to achieve the total destruction of human pathogens. If done properly, it is reported that “*there is very little hygienic risk involved in the use and handling of [humanure] compost for agricultural purposes.*” ⁸

In short, it doesn’t look like the Asians have a lot to offer us with regard to composting toilet designs. Perhaps we should instead look to the Scandinavians, who have developed many commercial composting toilets.

Source: The Humanure Handbook. Jenkins Publishing, PO Box 607, Grove City, PA 16127. To order, phone: 1-800-639-4099.

<http://www.jenkinspublishing.com/>

MENU: [HOME](#) » [Reconstruction](#) » [Recovery](#) » [Renewal](#) » [Survival](#) » [Humanure Content](#)

COMMERCIAL COMPOSTING TOILETS

Commercial composting toilets have been popular in Scandinavia for some time; at least twenty-one different composting toilets were on the market in Norway alone in 1975.⁹ One of the most popular types of commercially available composting toilets in the United States today is the multrum toilet, invented by a Swedish engineer and first put into production in 1964 (see Figure 6.4). Fecal material and urine are deposited together into a single chamber with a double bottom. The decomposition takes place over a period of years, and the finished compost gradually falls down to the very bottom of the toilet chamber where it can be removed. Again, the decomposition temperatures remain cool, not usually climbing above 32°C (90°F). Therefore, it is recommended that the finished compost be buried under one foot of soil or used in an ornamental garden.¹⁰

Because no water is used or required during the operation of this toilet, human excrement is kept out of water supplies, conserving water. According to one report, a single person using a Clivus (pronounced Clee-vus) Multrum (see Figure 6.5) will produce 40 kg (88 lbs) of compost per year while refraining from polluting 25,000 liters (6,604 gallons) of water annually.¹¹ The finished compost can be used as a soil additive where the compost will not come in contact with food crops.

A 1977 report issued by Clivus Multrum USA analyzed the nutrient content in finished compost from seven Clivus Multrum toilets which had been in use for 4 to 14 years. The compost averaged 58% organic matter, with 2.4% nitrogen, 3.6% phosphorous, and 3.9% potassium, reportedly higher than composted sewage sludge, municipal compost, or ordinary garden compost. Suitable concentrations of trace nutrients were also found. Toxic metals were found to exist in concentrations far below recommended safe levels.¹²

If a multrum toilet is managed properly, it should easily be odor and worry-free. As always, a good understanding of the basic concepts of composting helps anyone who wishes to use a composting toilet. Nevertheless, the multrum toilets, when used properly, should provide a suitable alternative to flush toilets for people who want to stop defecating in their drinking water. You can probably grow a heck of a rose garden with the compost, too.

Inexpensive versions of multrum toilets were introduced into the Philippines, Argentina, Botswana, and Tanzania, but were not successful. According to one source, “*Compost units I inspected in Africa were the most unpleasant and foul-smelling household latrines I have experienced. The trouble was that the mixture of excreta and vegetable matter was too wet, and insufficient vegetable matter was added, especially during the dry season.*”¹³ Poor management and a lack of understanding of how composting

works will create problems with any compost toilet. Too much liquid will create anaerobic conditions with consequent odors. The aerobic nature of the organic mass can be improved by the *regular* addition of carbonaceous bulking materials. Compost toilets are not pit latrines. You cannot just defecate in a hole and walk away. If you do, your nose will let you know that you're doing something wrong.

Besides the Scandinavian multrum toilets, a variety of other composting toilets are available on the market today. One manufacturer claims that over 200,000 of their composting toilets have been sold worldwide. The same manufacturer produces a fiberglass and stainless steel toilet which consists of a drum under the toilet seat or under the bathroom floor into which the feces and urine are deposited. The drum is rotated by hand in order to blend the ingredients, which should include food scraps and a carbon material such as peat moss. The toilet can come equipped with an electric heating system and an electrical fan ventilation system. The compost, produced in small quantities which are removed by pulling out a drawer beneath the drum, is said to be suitable for garden purposes. Some of the models require water as well as electricity (although some require no electricity or water).¹⁴

Other composting toilets cost upwards of \$10,000 or more, and can be equipped with insulated tanks, conveyers, motor-driven agitators, pumps, sprayers, and exhaust fans.¹⁵ According to a composting toilet manufacturer, waterless composting toilets can reduce household water consumption by 40,000 gallons (151,423 liters) per year.¹⁶ This is significant when one considers that only 3% of the Earth's water is not salt water, and two-thirds of that freshwater is locked up in ice. That means that less than one percent of the Earth's water is available as drinking water. Why shit in it?

Source: The Humanure Handbook. Jenkins Publishing, PO Box 607, Grove City, PA 16127. To order, phone: 1-800-639-4099.

<http://www.jenkinspublishing.com/>

MENU: [HOME](#) » [Reconstruction](#) » [Recovery](#) » [Renewal](#) » [Survival](#) » [Humanure Content](#)

PRIMAL COMPOST

Try to imagine yourself in an extremely primitive setting, perhaps sometime around 10,000 B.C. Imagine that you're slightly more enlightened than your brutish companions and it dawns on you one day that your feces should be disposed of in a different manner. Everyone else is defecating in the back of the cave, creating a smelly, fly-infested mess, and you don't like it.

Your first revelation is that smelly refuse should be deposited in one place, not spread around for everyone to step in or smell, and it should be deposited away from one's living area. You watch the wild cats and see that they each go to a special spot to defecate. But the cats are still one step ahead of the humans, as you soon find out, because they cover their excrement.

When you've shat outside the cave on the ground in the same place several times, you see that you've still created a foul-smelling, fly-infested mess. Your second revelation is that the refuse you're depositing on the ground should be covered after each deposit. So you scrape up some leaves every time you defecate and throw them over the feces. Or you pull some tall grass out of the ground and use it for cover.

Soon your companions are also defecating in the same spot and covering their fecal material as well. They were encouraged to follow your example when they noticed that you had conveniently located the defecation spot between two large rocks, and positioned logs across the rocks to provide a convenient perch, allowing for care-free defecation above the material collecting underneath.

A pile of dead leaves is now being kept beside the toilet area in order to make the job of covering it more convenient. As a result, the offensive odors of human feces and urine no longer foul the air. Instead, it's food scraps that are generating odors and attracting flies. This is when you have your third revelation: food scraps should be deposited on the same spot and covered as well. Every stinky bit of refuse you create is now going to the same spot and is being covered with a natural material to eliminate odor. This hasn't been hard to figure out, it makes good sense, and it's easy to do.

You've succeeded in solving three problems at once: no more human waste scattered around your living area, no more garbage, and no more offensive odors assaulting your keen sense of smell and generally ruining your day. You also begin to realize that the illnesses that were prone to spread through the group have subsided, a fact that you don't understand, but you suspect may be due to the group's new found hygienic practices.

Quite by accident, you've succeeded in doing one very revolutionary thing: *you've created a compost pile*. You begin to wonder what's going on when the pile gets so hot it's letting off steam. What you don't know is that you've done exactly what nature intended you to do by piling all your organic refuse together, layered with natural, biodegradable cover materials. In fact, nature has "seeded" your excrement with microscopic animals that proliferate in and digest the pile you've created. In the process, they heat the compost to such an extent that disease-causing pathogens resident in the humanure are destroyed. The microscopic animals would not multiply rapidly in the discarded refuse unless you created the pile, and thereby the conditions, which favor their proliferation.

Finally, you have one more revelation, a big one. You see that the pile, after it gets old, sprouts all kind of vibrant plant growth. You put two and two together and realize that the stinking refuse you carefully disposed of has been transformed into rich earth, and ultimately into food. Thanks to you, humankind has just climbed another step up the ladder of evolution.

There is one basic problem with this scenario: it didn't take place 12,000 years ago. It's taking place now. Compost microorganisms are apparently very patient. Not much has changed since 10,000 B.C. in their eyes. The invisible animals that convert humanure into humus don't care what composting techniques are used today anymore than they cared what techniques may have been used eons ago, so long as their needs are met. And those needs haven't changed in human memory, nor are they likely to change as long as humans roam the earth. Those needs include: 1) *temperature* (compost microorganisms won't work if frozen); 2) *moisture* (they won't work if too dry or too wet); 3) *oxygen* (they won't work without it); and 4) *a balanced diet* (otherwise known as balanced carbon/nitrogen). In this sense, compost microorganisms are a lot like people. With a little imagination, we can see them as a working army of microscopic people who need the right food, water, air and warmth.

The art of composting, then, remains the simple and yet profound art of providing for the needs of invisible workers so that they work as vigorously as possible, season after season. And although those needs may be the same worldwide, the techniques used to arrive at them may differ from eon to eon and from place to place.

Composting differs from place to place because it is a bioregional phenomenon. There are thousands of geographic areas on the Earth each with its own unique human population, climatic conditions, and available organic materials, and there will also be potentially thousands of individual composting methods, techniques, and styles. What works in one place on the planet for one group of people may not work for another group in another geographic location (for example, we have lots of hardwood sawdust in Pennsylvania, but no rice hulls). Compost should be made in order to eliminate local waste and pollution as well as to recover resources, and a compost maker will strive to utilize in a wise and efficient manner whatever local organic resources are available.

Source: The Humanure Handbook. Jenkins Publishing, PO Box 607, Grove City, PA 16127. To order, phone: 1-800-639-4099.

<http://www.jenkinspublishing.com/>

MENU: [HOME](#) » [Reconstruction](#) » [Recovery](#) » [Renewal](#) » [Survival](#) » [Humanure Content](#)

THE SAWDUST TOILET

Simple methods of collecting humanure and composting it are sometimes called cartage systems or bucket systems, as the manure is carried to the compost bin, often in buckets or other waterproof vessels. People who utilize such simple techniques for composting humanure simply take it for granted that humanure recycling is one of the regular and necessary responsibilities for sustainable human life on this planet.

How it works is a model of simplicity. One begins by depositing one's organic refuse (feces and urine) into a plastic bucket, clay urn, or other non-corrodible waterproof receptacle with about a five gallon (20 liter) capacity. Food scraps may be collected in a separate receptacle, but can also be deposited into the toilet receptacle. A five gallon capacity is recommended because a larger size would be too heavy to carry when full. If five gallons is still too heavy for someone to carry, it can be emptied when half-full.

The contents of the toilet are kept covered with a clean, organic *cover material* such as rotted sawdust, peat moss, leaf mould, rice hulls, or grass clippings, in order to prevent odors, absorb urine, and eliminate any fly nuisance. Urine is deposited into the same receptacle, and as the liquid surface rises, more cover material is added so that a clean layer of organic material covers the toilet contents *at all times*.

A lid is kept on the toilet receptacle when not in use. The lid need not be air-tight, and a standard, hinged toilet seat is quite suitable. The lid does not necessarily prevent odor from escaping, and it does not necessarily prevent flies from gaining access to the toilet contents. Instead, the *cover material* does. The cover material acts as an organic lid or a "biofilter"; the physical lid (toilet seat) is used primarily for convenience and aesthetics. Therefore, the choice of organic cover material is very important, and a material that has some moisture content, such as rotted sawdust, works beautifully. This is not kiln-dried sawdust from a carpenter shop. It is sawdust from a sawmill where trees are cut into boards. Such sawdust is both moist and biologically active and makes a very effective biofilter. Kiln-dried sawdust is too light and airy to be a 100% effective biofilter. Furthermore, sawdust from wood-working shops may contain hazardous chemical poisons if "pressure-treated" lumber is being used there. It seems that present-day carpenters are more than willing to expose themselves to the chemical hazards of poison-soaked lumber, which contains cancer-causing chemicals. There is no need for composters and gardeners to duplicate such unwise exposure.

I use rotted sawdust as a toilet cover material because it is a readily available, very inexpensive, local resource which works well. I used to haul a free load home from a local sawmill every so often in the back of my pick-up truck, but now I just have a fellow with a small dump truck deliver me a load every year or two. I have the sawdust dumped in a pile in a corner of my backyard adjacent to my compost bins where it can remain exposed to the elements and thereby slowly decompose on its own, as rotting sawdust makes compost more readily than fresh sawdust. The sawdust itself doesn't cost me anything, but I usually have to pay about five dollars to have it loaded onto the dump truck and another twenty-five to have it hauled. This is an expense I'm

happy to pay every year or two in order to ensure for myself a functional compost toilet system. I would speculate that many other cellulose-based materials or combination of materials would work as a toilet cover material, including perhaps ground newsprint.

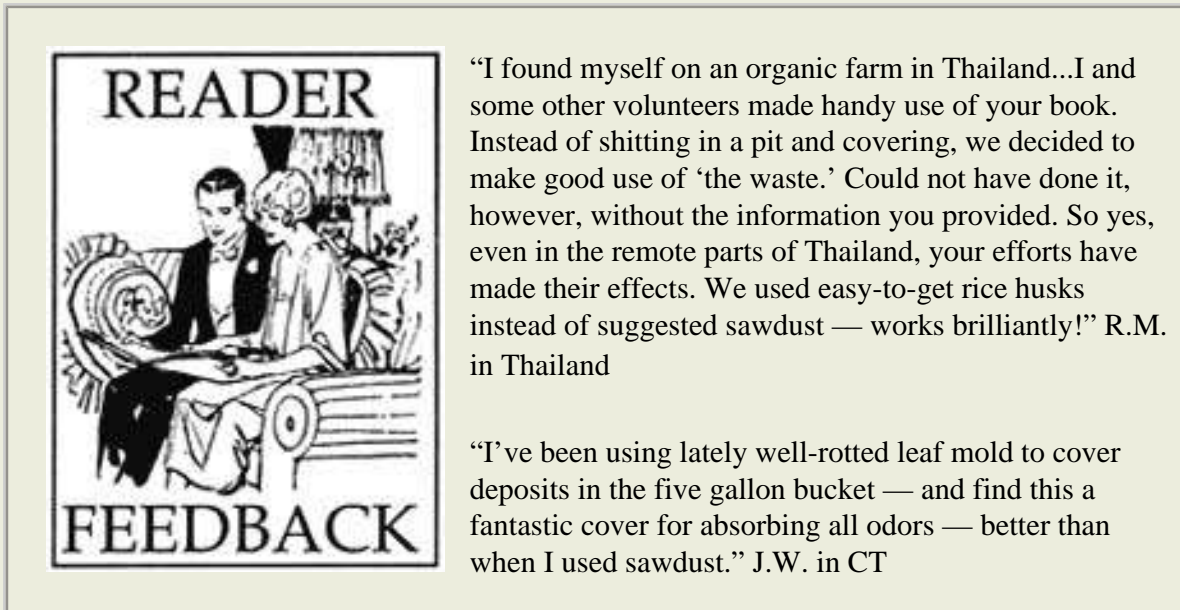

“I found myself on an organic farm in Thailand...I and some other volunteers made handy use of your book. Instead of shitting in a pit and covering, we decided to make good use of ‘the waste.’ Could not have done it, however, without the information you provided. So yes, even in the remote parts of Thailand, your efforts have made their effects. We used easy-to-get rice husks instead of suggested sawdust — works brilliantly!” R.M. in Thailand

“I’ve been using lately well-rotted leaf mold to cover deposits in the five gallon bucket — and find this a fantastic cover for absorbing all odors — better than when I used sawdust.” J.W. in CT

In the winter, an outdoor pile of sawdust will freeze solid. I have to layer some hay over mine and cover it with a tarp in order to be able to access it all winter. Otherwise, feedsacks filled with sawdust stored in a basement will work as an alternative, as will peat moss and other cover materials stored indoors.

The system of using an organic cover material in a small receptacle works well enough in preventing odors to allow the toilet to be indoors, year round. In fact, a full bucket with adequate and appropriate cover material, and no lid, can be set on the kitchen table without emitting unpleasant odors (take my word for it). An indoor sawdust toilet should be designed to be as warm, cozy, pleasant, and comfortable as possible. A well-lit, private room with a window, a standard toilet seat, a container of cover material, and some reading material will suffice.

AMERICAN YARDS AND ENGLISH GARDENS

In the United States, a “yard” is a grassy area surrounding a house; the term is equivalent to the English term “garden.” That grassy area may contain trees, shrubs, or flowers. If it is located in front of the house, it is called the “front yard.” Behind the house, it is the “back yard.” Beside the house, it is the “side yard.” An American “garden” is a plot of vegetables, often located within the yard. An American garden can also be a flower garden or fruit

When the bucket is full, it is carried to the composting area and deposited on the pile. Since the material must be moved from the toilet room to an outdoor compost pile, the toilet room should be handy to an outside door. If you are redesigning a sawdust toilet in a new home, situate the toilet room near a door that allows direct access to the outside.

It is best to dig a slight depression in the top center of the compost pile and deposit the fresh material there, in order to

garden; some American gardens contain flowers, fruits, and vegetables. In the UK, the green area around a house is called the “garden,” whether it contains vegetables, flowers, or nothing but mowed grass. English homes do not have “yards.” So the term “back yard composting,” translated to UK English, would be “back garden composting.”

SAWDUST TOILET VITAL STATISTICS

One hundred pounds of human body weight will fill approximately three gallons (.4 cubic feet, 693 cubic inches, or approximately 11 liters) in a sawdust toilet per week - this volume includes the sawdust cover material. One hundred pounds of human body weight will also require approximately 3 gallons of semi-dry, deciduous, rotting sawdust per week for use as a cover material in a toilet. This amounts to a requirement of approximately 20 cubic feet of sawdust cover material per one hundred pounds of body weight per year for the proper functioning of a sawdust toilet. Human excrement tends to add weight rather than volume to a sawdust toilet as it is primarily liquid and fills the air spaces in the sawdust. Therefore, for every gallon of sawdust-covered excrement collected in a sawdust toilet, nearly a gallon of cover material will need to be used.

keep the incoming humanure in the hotter center of the compost pile. This is easily achieved by raking aside the cover material on top of the pile, depositing the toilet contents in the resulting depression, and then raking the cover material back over the fresh deposit. The area is then immediately covered with additional clean, bulky, organic material such as straw, leaves, or weeds, in order to eliminate odors and to entrap air as the pile is built. The bucket is then thoroughly scrubbed with a small quantity of water, which can be rain water or graywater, and biodegradable soap, if available or desired. A long-handled toilet brush works well for this purpose. Often, a simple but thorough rinsing will be adequate. Rain water or wastewater is ideal for this purpose as its collection requires no electricity or technology. The soiled water is then poured on the compost pile.

It is imperative that the rinse water not be allowed to pollute the environment. The best way to avoid this is to put the rinse water on the compost pile, as stated. However, the rinse water can be poured down a drain into a sewer or septic system, or drained into an artificial wetland. It can also be poured at the base of a tree or shrub that is designated for this purpose. Such a tree or shrub should have a thick layer of organic material (biological sponge) at its base and be staked or fenced to prevent access to children or pets. Under no circumstances should the rinse water be flung aside nonchalantly. This is the weak link in this simple humanure recycling chain, and it provides the

most likely opportunity for environmental contamination. Such contamination is easy to avoid through considerate, responsible management of the system. Finally, never use chlorine to rinse a compost receptacle. Chlorine is a chemical poison that is detrimental to the environment and is totally unnecessary for use in any humanure recycling system. Simple soap and water is adequate.

After rinsing or washing, the bucket is then replaced in the toilet area. The inside of the bucket should then be dusted with sawdust, the bottom of the empty receptacle should be primed with an inch or two of sawdust, and it's once again ready for use. After about ten years, the plastic bucket may begin to develop an odor, even after a thorough washing. Replace odorous buckets with new ones in order to maintain an odor-free system. The old buckets will lose their odor if left to soak in clean, soapy water for a lengthy period (perhaps weeks), rinsed, sun-dried, and perhaps soaked again, after which they can be used for utility purposes (or, if you really have a shortage of buckets, they can be used in the toilet again).

Here's a helpful hint: when first establishing such a toilet system, it's a good idea to acquire at least *four* five gallon buckets, with lids, that are *exactly the same*, and more if you intend to compost for a large number of people. Use one under the toilet seat and two, with lids, set aside in the toilet room, empty and waiting (save

the fourth as a back-up). When the first becomes full, take it out of the toilet, put a lid on it, set it aside, and replace it with one of the empty ones. When the second one fills, take it out, put the other lid on it, set it aside, and replace it with the other empty one. Now you have two full compost buckets, which can be emptied at your leisure, while the third is in place and ready to be used. This way, the time you spend emptying compost is almost cut in half, because it's just as easy to carry two buckets to the compost pile as one. Furthermore, you potentially have a 15 gallon toilet capacity at any one time (20 with the extra bucket), instead of just five gallons. You may find that extra capacity to come in very handy when inundated with visitors.

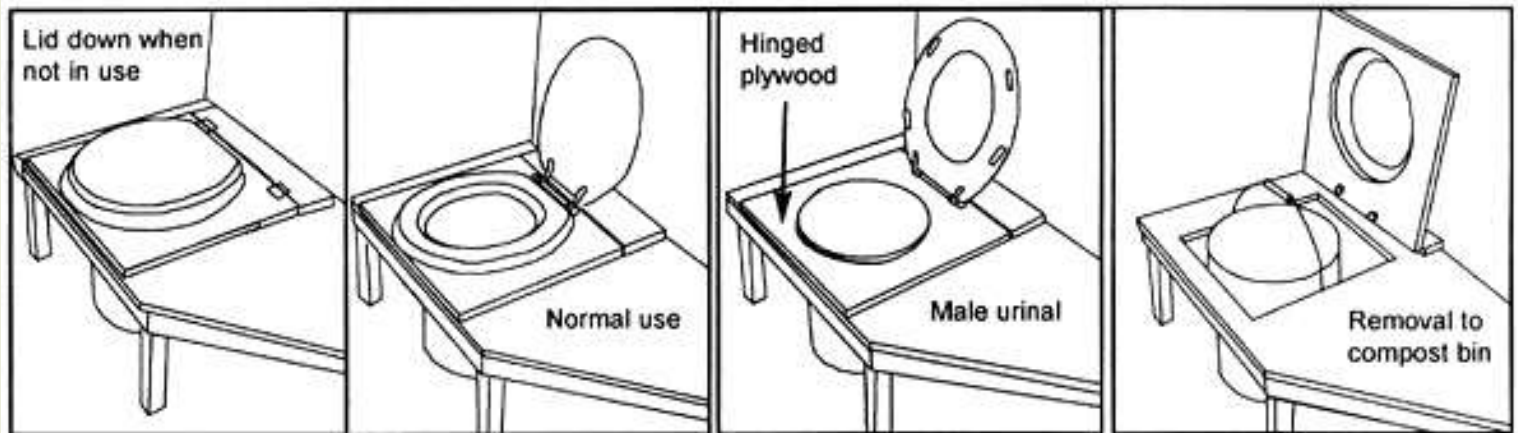

Figure 8.1

SAWDUST TOILET WITH HINGED SEAT

The above diagram shows a simple sawdust toilet permanently built into a toilet room. The compost receptacle (bucket) sits directly on the floor. A standard toilet seat is attached to an 18" square piece of plywood, which lifts up on hinges to allow easy access when removing the compost material. Bucket setback from the front edge of the plywood is 1&1/2". Height of top surface of plywood is 1/2" lower than height of bucket. Bucket protrudes through cabinet to contact bottom of toilet seat ring. Plastic bumpers on bottom of toilet seat ring are swiveled sideways so as to fit around bucket. Actual toilet shown below.



DIRECTIONS FOR SAWDUST TOILET:

1. MAKE YOUR DEPOSIT
2. COVER WITH SAWDUST
3. HAVE A GREAT DAY ~ ENJOY!

Figure 8.2

SAWDUST TOILET WITH LIFT-OFF TOP

Toilet at left came with directions mounted on the wall.

Why should all of the buckets be exactly the same? If you build a permanent toilet cabinet (seat), the top of the bucket should protrude through the cabinet to contact the bottom of a standard toilet seat. This ensures that all organic material goes into the container, not over its edge. Although this is not usually a problem, it can be with young children who may urinate over the top of a bucket receptacle when sitting on a toilet. A good design will enable the bucket to fit tightly through the toilet cabinet as shown in Figures 8.1, 8.2, and 8.4. Since all plastic buckets are slightly different in height and diameter, you will have to build your toilet cabinet to fit one size bucket. You should have extra identical ones when backup capacity is needed to accommodate large numbers of people.

It is much better to set a full toilet receptacle aside, with a lid, and replace it immediately with an empty one, than to have to empty and replace a full one while someone is waiting to use the toilet. There are some things in life we would all like to avoid: you have no money in the bank, your gas tank is empty, you're out of firewood, your pantry is bare, the sun's not shining, the dog has died, and "nature calls," but the shit bucket's full. Put some harmonica music to that last sentence and you'd have *"The Shit Bucket Blues."* One can avoid singing that tune by properly planning and managing a sawdust toilet system.

Theoretically, with enough containers, a sawdust toilet system can be used for any number of people. For example, if you are using a sawdust toilet in your home, and you are suddenly visited by thirty people all at once, you will be very happy to have empty containers ready to replace the ones that fill up. You will also be very happy that you will not have to empty any compost containers until after your company leaves, because you can simply set them out of the way in the toilet room as they fill up, and then empty them the next day.

Experience has shown that 150 people will require four five gallon containers during a serious party. Therefore, always be prepared for the unexpected, and maintain a reserve toilet capacity at all times by having extra toilet receptacles available, as well as extra cover material. Incidentally, for every full container of compost material carried out of a toilet room, a full, same-sized container of cover material will need to be carried in.

Expecting five hundred people for a major gathering out in the woods? Sawdust toilets will work fine, as long as you keep enough buckets handy, as well as adequate cover materials, and some volunteers to manage it all. You will collect a lot of valuable soil nutrients. Which brings to mind a verse created by a friend and sung to the tune of "Old Joe Clark" at one of my own gatherings, here paraphrased:

*"He feeds us lots of party food,
and calls it appetizers.
But we know what he's going to do,
He'll make it fertilizer!"*

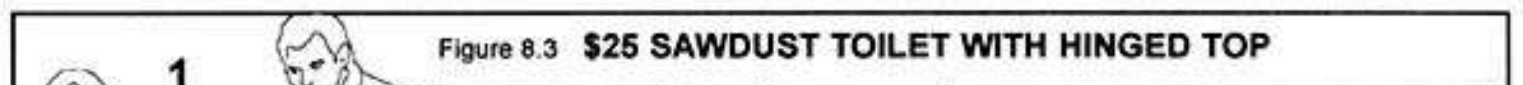
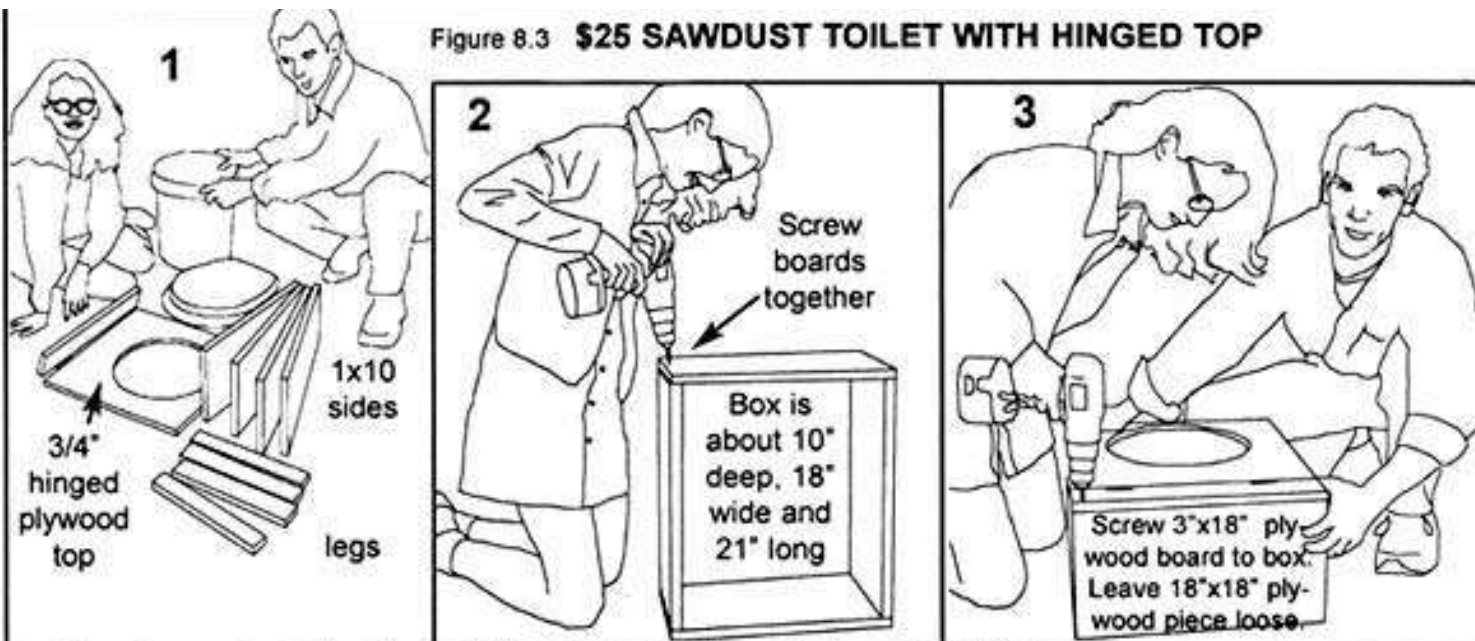
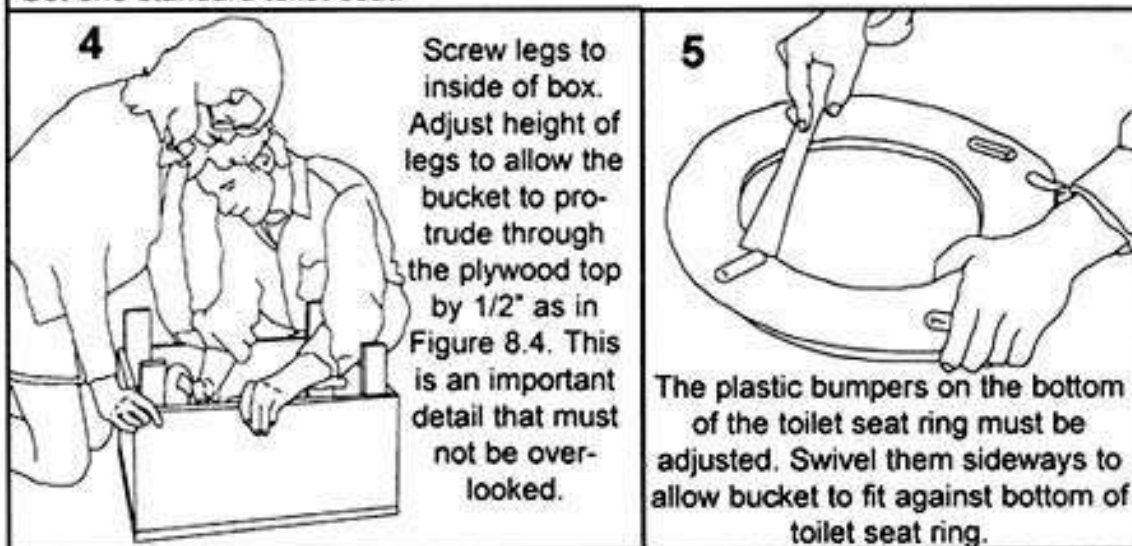

Figure 8.3 \$25 SAWDUST TOILET WITH HINGED TOP



A hinged sawdust toilet box will be 18" wide by 21" long. Get (2) boards 3/4"x10"x18", (2) 3/4"x10"x20.5", (2) hinges, (1) piece of 3/4" plywood 18"x18" and another 18"x3" and hinge them together. Cut a hole in the larger plywood to fit the top of a five-gallon bucket, set back one and one half inches from the front (as in Figure 8.4). Get four five-gallon buckets that are identical. Get (4) 3/4"x3"x12" legs. Get one standard toilet seat.



Attach toilet seat to box. Your \$25 composting toilet is now ready to be stained, varnished, or painted. The hinged seat will allow for convenient removal of the compost material. Remember that the toilet is only one of three components to a sawdust toilet system.



The advantages of a sawdust toilet system include low financial start-up cost in the creation of the facilities, and low, or no energy consumption in its operation. Also, such a simple system, when the refuse is thermophilically composted, has a low environmental cost, as little or no technology is required for the system's operation, and the finished compost is as nice and benign a material as humanure can ever hope to be. No composting facilities are necessary in or near one's living space, although the toilet can and should be inside one's home and can be quite comfortably designed and totally odor-free. No electricity is needed, and no water is required except a small amount for cleaning purposes. The compost, if properly managed, will heat up sufficiently for sanitation to occur, thereby making it useful for gardening purposes. The composting process is fast, i.e., the humanure is converted quickly (within a few days if not frozen) into an inoffensive substance that will neither attract rodents nor flies. In cold winter months, the compost simply freezes until spring thaw, and then heats up. If the compost is unmanaged and does not become thermophilic, the compost can simply be left to age for a couple of years before horticultural use. In either case, a complete natural cycle is maintained, unbroken.

*Source: The Humanure Handbook. Jenkins Publishing, PO Box 607, Grove City, PA 16127. To order, phone: 1-800-639-4099.
<http://www.jenkinspublishing.com/>*

MENU: [HOME](#) » [Reconstruction](#) » [Recovery](#) » [Renewal](#) » [Survival](#) » [Humanure Content](#)

THE COMPOST BINS

A sawdust toilet requires three components: 1) the toilet receptacle; 2) cover materials; and 3) a compost bin system. The system will NOT work without all three of these components. The toilet is only the collection stage of the process. The composting takes place away from the toilet, and the compost bin system is important.

1) *Use at least a double-chambered, above-ground compost bin.* A three-chambered bin is recommended. Deposit in one chamber for a period of time (e.g., a year), then switch to another for an equal period of time.

2) *Deposit a good mix of organic material into the compost pile, including kitchen scraps.* It is a good idea to put all of your organic material into the same compost bin. Pay no attention to those people who insist that humanure compost should be segregated from other compost. They are people who do not compost humanure and don't know what they're talking about.

3) *Always cover humanure deposits in the toilet with an organic cover material* such as sawdust, leaf mould, peat moss, or rice hulls. *Always cover fresh deposits on the compost pile with coarser cover materials* such as hay, weeds, straw, or leaves. Make sure that enough cover is applied so that there is neither excess liquid build-up in the toilet nor offensive odors escaping either the toilet or the compost pile. The trick to using cover material is quite simple: if it smells bad or looks bad, cover it until it does neither.

4) *Keep good access to the pile* in order to rake the top flat, to apply bulky cover material when needed, to allow air to access the pile, and to monitor the temperature of the pile. The advantage of aerobic composting, as is typical of an above-ground pile, over relatively anaerobic composting typical of enclosed composting toilets, is that the aerobic compost will generate higher temperatures, thereby ensuring a more rapid and complete destruction of potential human pathogens.

The disadvantages of a collection system requiring the regular transporting of humanure to a compost pile are obvious. They include the inconvenience of: 1) carrying the organic refuse to the compost pile; 2) keeping a supply of organic cover material available and handy to the toilet; 3) maintaining and managing the compost pile itself.

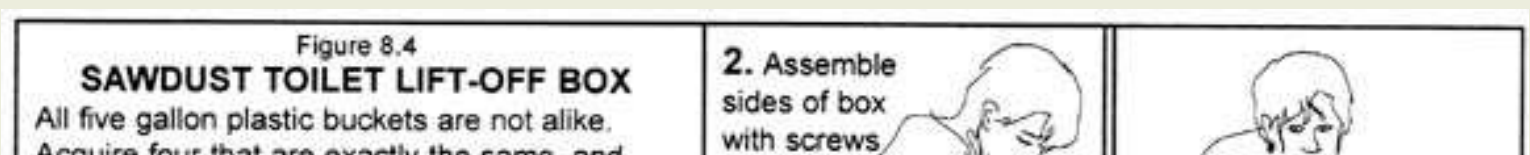

All five gallon plastic buckets are not alike. Acquire four that are exactly the same, and build the box to fit the bucket height and diameter. The bucket should protrude through the top of the box by 1/2" in order to contact the bottom of the toilet seat (as shown in #7).

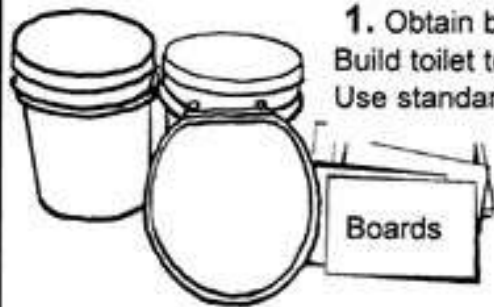

1. Obtain buckets first. Build toilet to fit buckets. Use standard toilet seat.

sides of box with screws and glue (or nails)



3. Attach top boards

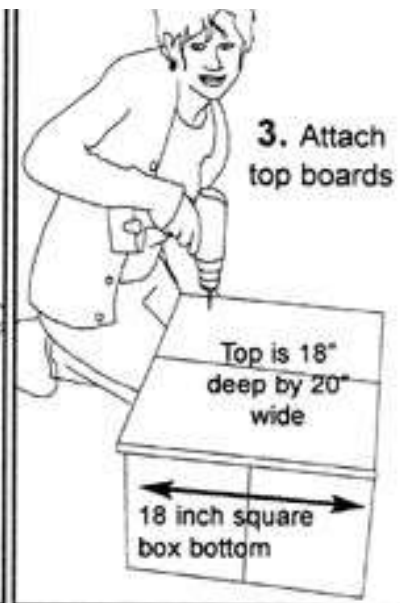

4. Set bucket 1 1/2" from the front of the box, and center it. Mark for cut.

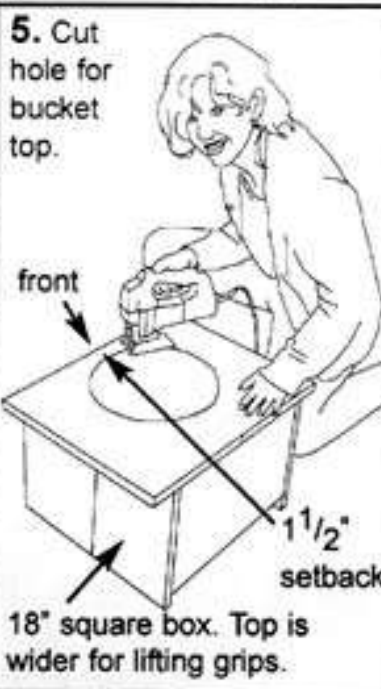

5. Cut hole for bucket top.

front
1 1/2" setback

18" square box. Top is wider for lifting grips.

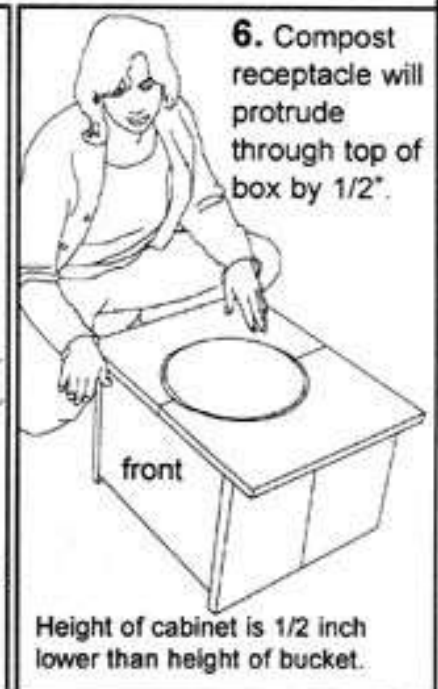

6. Compost receptacle will protrude through top of box by 1/2".

Height of cabinet is 1/2 inch lower than height of bucket.

7. The overall height of the toilet box is equal to the height of the bucket minus 1/2", allowing the bucket to protrude through the box and contact the bottom of the toilet seat ring.

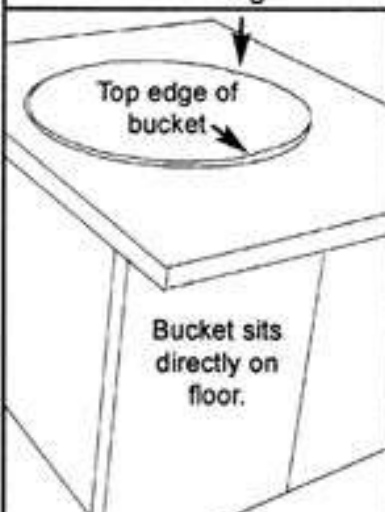

8. The plastic bumpers on the underside of the toilet seat ring must be turned sideways so as to allow the toilet seat ring to contact the top of the bucket. This ensures that all organic material meant to go into the bucket will get there and not go over the top, as may otherwise happen when little children are seated on the toilet.

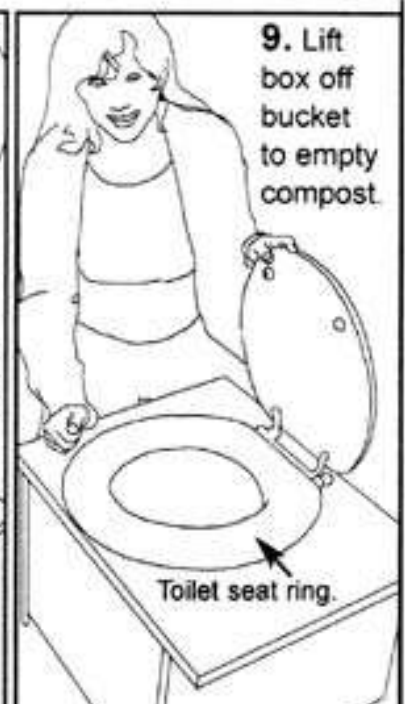

9. Lift box off bucket to empty compost.



Source: *The Humanure Handbook*. Jenkins Publishing, PO Box 607, Grove City, PA 16127. To order, phone: 1-800-639-4099.

<http://www.jenkinspublishing.com/>

MENU: [HOME](#) » [Reconstruction](#) » [Recovery](#) » [Renewal](#) » [Survival](#) » [Humanure Content](#)

MENU: [HOME](#) » [Reconstruction](#) » [Recovery](#) » [Renewal](#) » [Survival](#) » [Humanure Content](#)

NORMAL COMPOSTING BIN SEQUENCE

It's very important to understand that *two* factors are involved in destroying potential pathogens in humanure. Along with heat, the *time* factor is important. Once the organic material in a compost pile has been heated by thermophilic microorganisms, it should be left to age or "season." This part of the process allows for the final decomposition to take place, decomposition that may be dominated by fungi and macroorganisms such as earthworms. Therefore, a good compost system will utilize at least two composting bins, one to fill and leave to age, and another to fill while the first is aging. A three-binned composting system is recommended, as the third bin provides a place to store cover materials, and separates the active bins so there is no possible accidental transfer of fresh material to an aging bin.

When composting humanure, fill one bin first. Start the compost pile by establishing a thick layer of coarse and absorbent organic material on the bottom of the bin. This is called a "biological sponge"; its purpose is to act as a leachate barrier. The sponge may be an 18 inch layer of hay or straw, grass clippings, leaves, and/or weeds. Place the first container of the humanure/sawdust mix from the toilet directly on the top center of the sponge. Cover immediately with more straw, hay, weeds, or leaves — the cover acts as a natural "biofilter" for odor prevention, and it causes air to become trapped in the developing compost pile, making physical turning of the pile for aeration unnecessary.

Continue in this manner until the bin is full, being sure to add to this bin *all* of the other organic material you produce. There is no need to have any other compost piles — one is enough for everything produced by the humans in your household. If you have small animals such as chickens or rabbits, their manure can go into the same compost pile. Presumably, pet manures can also go into the same compost pile as well (see Chapter 3), although pet manures, like human manures, can contain human pathogens, so thermophilic composting and/or adequate aging of the compost are essential. Small dead animals can also be added to the compost pile.

You need to do nothing special to prepare material for adding to the compost pile. You do not need to chop up vegetables, for example. Just chuck it all in there. Most of the things compost educators tell you cannot be composted *can*, in fact, be composted in your humanure compost pile (such as meat, fats, oils, etc.). Add it all to the same compost pile. Anything smelly that may attract flies should be dug into the top center of the pile. Keep a shovel or pitchfork handy for this purpose and use the tool *only* for the compost. Keep a clean cover material over the compost at all times, and don't let your compost pile become shaped like the Matterhorn — keep it somewhat flattened so nothing rolls off.



SAWDUST TOILET IN NEW RURAL HOME



LIFT-OFF SAWDUST TOILET IN RURAL HOME



PEAT TOILET (PEAT STORED UNDER LID WITH HANDLE)



EMERGENCY SAWDUST TOILET IN BASEMENT OF NEW HOME WITH SEPTIC SYSTEM



HINGED TOP SAWDUST TOILET IN URBAN HOME



SAWDUST TOILET IN "OUTHOUSE"

When you have a sudden large quantity of cover material available, such as an influx of grass clippings when the lawn is mowed, weeds from the garden, or leaves in the fall, place them in the center bin for storage and use them to cover humanure deposits as you need them. It is assumed that you do not use any poisonous chemicals on your lawn. If you do, bag the lawn clippings, take them to a toxic waste dump, and on the way, reflect upon the folly of such toxic behavior. Do not put poisoned grass clippings on your compost pile.

Filling the first bin should take a year — that's how long it takes us, a family, usually of four, with a lot of visitors. We start to fill a compost bin every summer solstice or at some point near that time. Cover the finished compost pile with a thick layer of straw, leaves, grass clippings, or other clean material (without weed seeds) to insulate it and to act as a biofilter, then leave the pile alone. Start filling the second chamber, following the same procedure as the first (start with a biological sponge). When the second chamber is nearly full (a year later), the first one can begin to be emptied onto the garden, berries, orchard, or flower beds. The finished compost does not need to be dug deeply into the soil or buried in a trench on another planet, as the fecophobes insist. It can either be used as mulch, or it can be dug or tilled into the top layer of your garden soil. You can even roll naked in it if you want to (no, I haven't tried this — yet).



The author's triple chambered compost bins, in use for twenty years. The far bin is the active one, the near bin is the aging one, here being broken into for spring planting.

Source: *The Humanure Handbook*. Jenkins Publishing, PO Box 607, Grove City, PA 16127. To order, phone: 1-800-639-4099.

<http://www.jenkinspublishing.com/>

MENU: [HOME](#) » [Reconstruction](#) » [Recovery](#) » [Renewal](#) » [Survival](#) » [Humanure Content](#)

MENU: [HOME](#) » [Reconstruction](#) » [Recovery](#) » [Renewal](#) » [Survival](#) » [Humanure Content](#)

NORMAL COMPOSTING BIN SEQUENCE (CONTINUED)

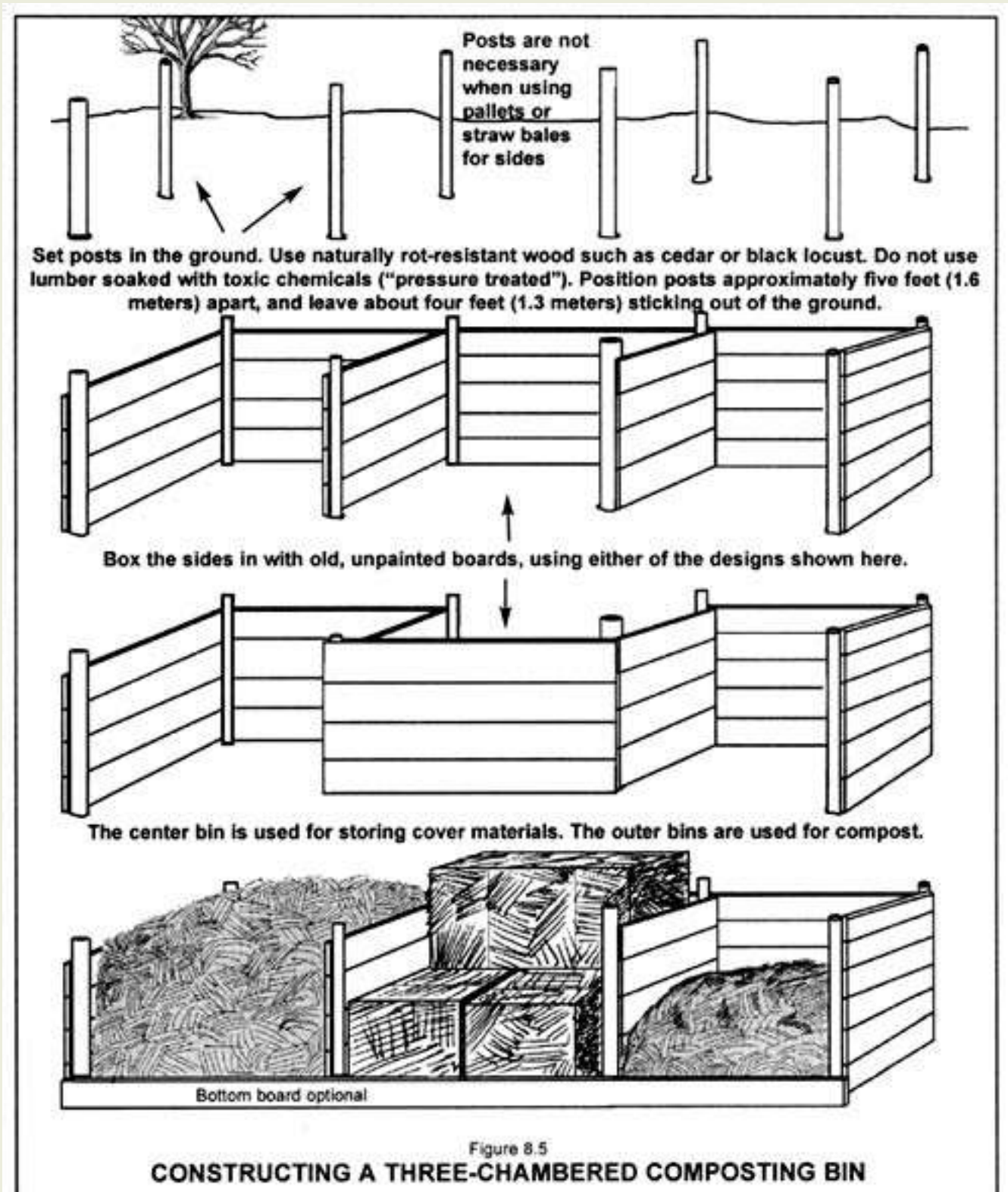

CONSTRUCTING A THREE-CHAMBERED COMPOSTING BIN

The three-chambered bin is ideally suited for humanure composting. The bin can be built of pallets wired, nailed, or screwed together instead of boards. Straw or hay bales (or pallets) can be used to close the open side when filling with compost. Later, the old straw can be used as a cover material. The center bin is used for storing excess cover materials such as garden weeds, lawn grass and leaves, or bales of hay or straw.

A compost pile can accept a huge amount of refuse, and even though the pile may seem to be full, as soon as you turn your back it will shrink down and leave room for more material. So when I say fill the first bin before filling the second, I mean *fill* it. A year is a good period of time for doing so in any area where there is an annual growing season. In the tropics, a shorter period may be necessary; I don't know. You readers who live in the tropics will have to figure that out. In the cold winters of the north, it is quite likely that the compost will freeze solid. You can, however, keep adding to the pile all winter. In the spring when it thaws out, the compost should work up a head of steam as if nothing happened.

Follow a natural timing cycle when making compost, one that is in tune to your agricultural cycle. A yearly cycle works best for me in Pennsylvania, where we have an annual growing cycle (one growing season per year). By late spring, the compost bin has been completely filled and it's time to let it sit until the next spring, when the finished compost will be ready to be removed and added to the garden.

The system outlined above will not yield any compost until two years after the process has started (one year to build the first pile and an additional year for it to age). However, after the initial two year start-up period, an ample amount of compost will be available on an annual basis.



A few people wrote to me wondering what happens to the leachate from the compost pile. Apparently they imagined that noxious fluids were draining into the soil under the pile, and they were concerned that this would constitute a violation of environmental regulations. Ironically, in most rural and many suburban areas, the alternative would be to use a septic system for waste disposal. Septic systems are *designed* to leach waste into the soil. That makes me wonder why people are concerned about possible leaching into the soil from compost while they show no concern for the leaching from septic systems. The answer to the leaching question is two-fold. First, compost *requires* a lot of moisture; evaporated moisture is one of the main reasons why compost shrinks so much. Compost piles are not inclined to *drain* moisture unless during a very heavy rain. Most rainwater is absorbed by the compost, but in heavy rainfall areas a roof or cover can be placed over the compost pile at appropriate times in order to prevent leaching. Second, a thick biological sponge is layered under the compost before the pile is built. This acts as a leachate barrier. If these two factors aren't effective enough, it is a simple matter to place a layer of plastic underneath the compost pile, under the biological sponge, before the pile is built. Fold the plastic so that it collects any leachate and drains into a sunken five gallon bucket. If leachate collects in the bucket, pour it back over the compost pile. The plastic, however, will act as a biological barrier between the soil and the compost, and its use is therefore not recommended by the author. The interface between the compost pile and the soil acts as a corridor for soil organisms to enter the compost pile, and plastic will prevent that natural migration. However, the plastic can provide simple and effective leachate prevention, if needed.

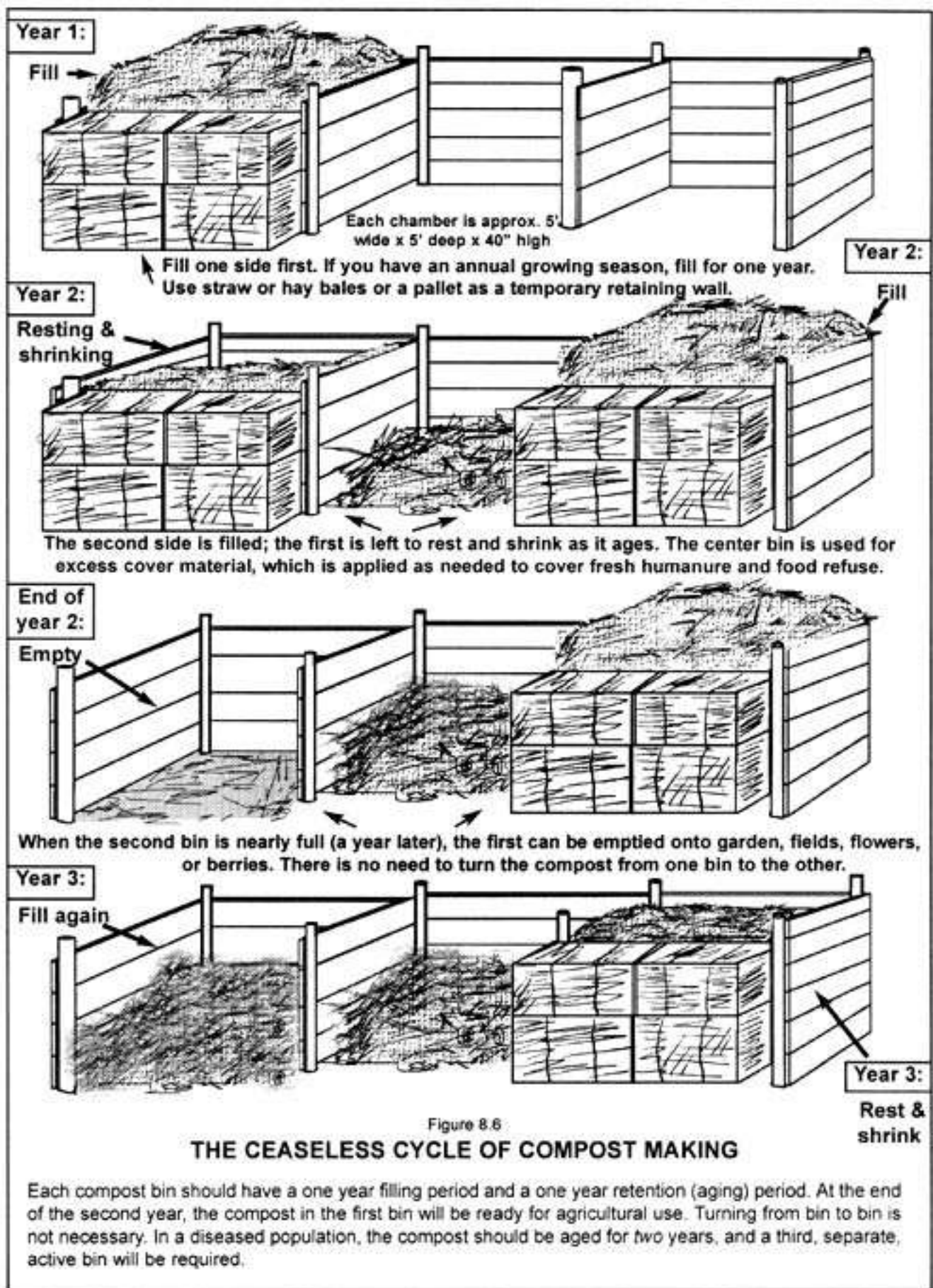

Source: *The Humanure Handbook*. Jenkins Publishing, PO Box 607, Grove City, PA 16127. To order, phone: 1-800-639-

4099.

<http://www.jenkinspublishing.com/>

MENU: [HOME](#) » [Reconstruction](#) » [Recovery](#) » [Renewal](#) » [Survival](#) » [Humanure Content](#)

PATHOGENIC POPULATIONS AND A TWO YEAR RETENTION TIME

DO'S AND DON'TS OF A THERMOPHILIC TOILET COMPOSTING SYSTEM

DO — Collect urine, feces, and toilet paper in the same toilet receptacle. Urine provides essential moisture and nitrogen.

DO — Keep a supply of clean, organic cover material handy to the toilet at all times. Rotting sawdust, peat moss, leaf mould, and other such cover materials prevent odor, absorb excess moisture, and balance the C/N ratio.



DON'T — Segregate urine or toilet paper from feces.

DON'T — Turn the compost pile if it is being continuously added to and a batch is not available. Allow the active thermophilic layer in the upper part of the pile to remain undisturbed.

DON'T — Use lime or wood ashes on the compost pile. Put these things directly on the soil.

DO — Keep another supply of cover material handy to the compost bins for covering the compost pile itself.

Coarser materials such as hay, straw, weeds, leaves, and grass clippings, prevent odor, trap air in the pile, and balance the C/N ratio.

DO — Deposit humanure into a depression in the top center of the compost pile, not around edges.

DO — Add a mix of organic materials to the humanure compost pile, including all food scraps.

DO — Keep the top of the compost pile somewhat flat. This allows the compost to absorb rainwater, and makes it easy to cover fresh material added to the pile.

DO — Use a compost thermometer to check for thermophilic activity. If your compost does not seem to be adequately heating, use the finished compost for berries, fruit trees, flowers, or ornamentals, rather than food crops. Or allow the constructed pile to age for two full years before garden use.

DON'T — Expect thermophilic activity until a sufficient mass has accumulated.

DON'T — Deposit anything smelly into a toilet or onto a compost pile without covering it with a clean cover material.

DON'T — Allow dogs or other animals to disturb your compost pile. If you have problems with animals, install wire mesh or other suitable barriers around your compost, and underneath, if necessary.

DON'T — Segregate food items from your humanure compost pile. Add all organic materials to the same compost bin.

DON'T — Use the compost before it has fully aged. This means one year after the pile has been constructed, or two years if the humanure originated from a diseased population.

DON'T — Worry about your compost. If it does not heat to your satisfaction, let it age for a prolonged period, then use it for horticultural purposes.

Fecophobes, as we have seen throughout this book, believe that all human excrement is extremely dangerous, and will cause the end of the world as we know it if not immediately flushed down a toilet. Some insist that humanure compost piles must be turned frequently — to ensure that all parts of the pile are subjected to the internal high temperatures.

The only problem with that idea is that most people produce organic refuse a little at a time. For example, most people defecate once a day. A large amount of organic material suitable for thermophilic composting is therefore usually not available to the average person. As such, we who make compost a daily and normal part of our lives tend to be “continuous composters.” We add organic material

continuously to a compost pile, and almost never have a large “batch” that can be flipped and turned all at once. In fact, a continuous compost pile will have a thermophilic layer, which will be located usually in the top two feet or so of the pile. If you turn the compost pile under these conditions, that layer will become smothered by the thermophilically “spent” bottom of the pile, and all thermophilic activity will grind to a halt.

In healthy human populations, therefore, turning a continuous compost pile is not recommended. Instead, all humanure deposits should be deposited in the top center of the compost pile in order to feed it to the hot area of the compost, and a thick layer of insulating material (e.g., hay) should be maintained over the composting mass. Persons who have doubts about the hygienic safety of their finished humanure compost are urged to either use the compost for non-food crops or orchards, or have it tested at a lab before using on food crops.

On the other hand, one may have the need to compost humanure from a population with known disease problems. If the organic material is available in *batches*, then it can be turned frequently during the thermophilic stage in order to enhance pathogen death. After the thermophilic stage, the compost can be left to age for at least a year.

If the organic material is available only on a continuous basis, and turning the pile, therefore, is counterproductive, an *additional* year-long curing period is recommended. This will require one more composting bin in addition to the two already in use. After the first is filled (presumably for a year), it is left to rest *for two years*. The second is filled during the second year, then it is left to rest for two years. The third is filled during the third year. By the time the third is filled, the first has aged for two years and should be pathogen-free and ready for agricultural use. This system will create an initial lag-time of three years before compost is available for agricultural purposes (one year to build the first pile, and two more years retention time), but the extra year’s retention time will provide added insurance against lingering pathogens. After the third year, finished compost will be available on a yearly basis. Again, if in doubt, either test the compost for pathogens in a laboratory, or use it agriculturally where it will not come in contact with food crops.

A TIP FROM MR. TURDLEY

Sawdust works best in compost when it comes from logs, not kiln-dried lumber. Although kiln-dried sawdust (from a wood-working shop) will compost, it is a dehydrated material and will not decompose as quickly as sawdust from fresh logs, which are found at sawmills. Kiln-dried sawdust may originate from “pressure-treated” lumber, which usually is contaminated with chromated copper arsenate, a known cancer-causing agent, and a dangerous addition to any backyard compost pile. Sawdust from logs can be an



inexpensive and plentiful local resource in forested areas. It should be stored outside where it will remain damp and continue to decompose. Although some think sawdust will make soil acidic, a comprehensive study between 1949 and 1954 by the Connecticut Experiment Station showed no instance of sawdust doing so.

Source: Rodale, The Complete Book of Composting, 1960, p. 192.

Source: *The Humanure Handbook*. Jenkins Publishing, PO Box 607, Grove City, PA 16127. To order, phone: 1-800-639-4099.

<http://www.jenkinspublishing.com/>

MENU: [HOME](#) » [Reconstruction](#) » [Recovery](#) » [Renewal](#) » [Survival](#) » [Humanure Content](#)

ANALYSES

After nearly 14 years of composting all of my family's and visitors' humanure on the same spot about 50 feet from my garden, and using all of the finished compost to grow the food in our single garden, I analyzed my garden soil, my yard soil (for comparison), and my compost, each for fertility and pH, using LaMotte test kits from the local university.¹ I also sent samples of my feces to a local hospital lab to be analyzed for indicator parasitic ova or worms.

The humanure compost proved to be adequate in nitrogen (N), and rich in phosphorus (P), and potassium (K), and higher than either the garden or the yard soil in these constituents as well as in various beneficial minerals. The pH of the compost was 7.4 (slightly alkaline), and no lime or wood ashes had been added during the composting process. This is one reason why I don't recommend adding lime (which raises the pH) to a compost pile. A finished compost would ideally have a pH around, or slightly above, 7 (neutral).

The garden soil was slightly lower in nutrients (N, P, K) than the compost, and the pH was also slightly lower at 7.2. I had added lime and wood ashes to my garden soil over the years, which may explain why it was slightly alkaline. The garden soil, however, was still significantly higher in nutrients and pH than the yard soil (pH of 6.2), which remained generally poor.

My stool sample was free of pathogenic ova or parasites. I used my own stool for analysis purposes because I had been exposed to the compost system and the garden soil longer than anyone else in my family by a number of years. I had freely handled the compost, with bare hands, year after year, with no reservations (my garden is mostly hand-worked). I repeated the stool analysis a year later (after 15 years of exposure) again with negative results (no ova or parasites observed). Hundreds of people had used my compost toilet over the years, prior to these tests.

These results indicate that humanure compost is a good soil builder, and that no intestinal parasites were transmitted from the compost to the compost handler. This wasn't a laboratory experiment; it was a real life situation conducted over a period of 15 years. The whole process, for me, has been quite successful.



Adequately aged, thermophilically composted humanure is a pleasant-smelling, hygienic material. It can be freely handled and used as mulch in a food garden. The author's asparagus bed is shown here getting its 17th annual spring mulching.

Another five years have passed since I did those analyses, and over the entire 20 year period, all of the humanure compost my family has produced has been used in our food garden (see color photos following this chapter). We have raised a lot of food with that compost, and a crop of lovely and healthy children with that food.

One person commented that the Ova & Parasite lab analyses I had done at the local hospital were pointless. They didn't prove anything, or so the contention went, because there may not have been any contamination by intestinal parasites in the compost to begin with. If, after fifteen years and literally hundreds of users, no contaminants made their way into my compost, then why do people worry about them so much? Perhaps this proves that the fears are grossly overblown. The point is that my compost has not created any health problems for me or my family, and that's a very important point, one that the fecophobes should take note of.

Source: The Humanure Handbook. Jenkins Publishing, PO Box 607, Grove City, PA 16127. To order, phone: 1-800-639-4099.

<http://www.jenkinspublishing.com/>

MENU: [HOME](#) » [Reconstruction](#) » [Recovery](#) » [Renewal](#) » [Survival](#) » [Humanure Content](#)

MENU: [HOME](#) » [Reconstruction](#) » [Recovery](#) » [Renewal](#) » [Survival](#) » [Humanure Content](#)

MONITORING COMPOST TEMPERATURE

ANOTHER TIP FROM MR. TURDLEY



THE SECRET OF COMPOSTING HUMANURE IS TO KEEP IT COVERED

Always thoroughly cover toilet deposits with a clean, organic cover material such as rotting sawdust, peat moss, leaf mould, rice hulls, or other suitable material to prevent odor, absorb urine, and balance the nitrogen. Always cover toilet deposits again, after adding them to the compost pile, with a clean cover material such as hay, straw, weeds, grass clippings, leaves, or other suitable material in order to prevent odors and flies, to create air spaces in the compost pile, and to balance the nitrogen. Such cover materials also add a blend of organic materials to the compost, and the variety supports a healthier microbial population.

Figure 8.7 shows the rise in temperature of humanure compost piles (feces, urine, and food scraps) which had been frozen all winter. The compost consisted primarily of deposits from the sawdust toilet, which contained raw hardwood sawdust (just enough to cover the material in the toilet), humanure including urine, and toilet paper. In addition to this material, kitchen food scraps were added to the pile intermittently throughout the winter, and hay was used to cover the toilet deposits on the pile. Some weeds and leaves were added now and then.

The material was continuously collected over a period of about four months from a family of four, and added to an existing compost pile. Nothing special was done to the pile at any time. No unusual ingredients were added, no compost starters, no water, no animal manures other than human (although a little chicken manure was added to the pile charted on the right, which may explain the higher composting temperatures). No turning was done whatsoever. The compost piles were situated in a three-sided, open-topped wooden bin on bare soil, outdoors. The only imported materials (not from the home) were sawdust, a locally abundant resource, and hay from a neighboring farm (less than two bales were used during the entire winter).

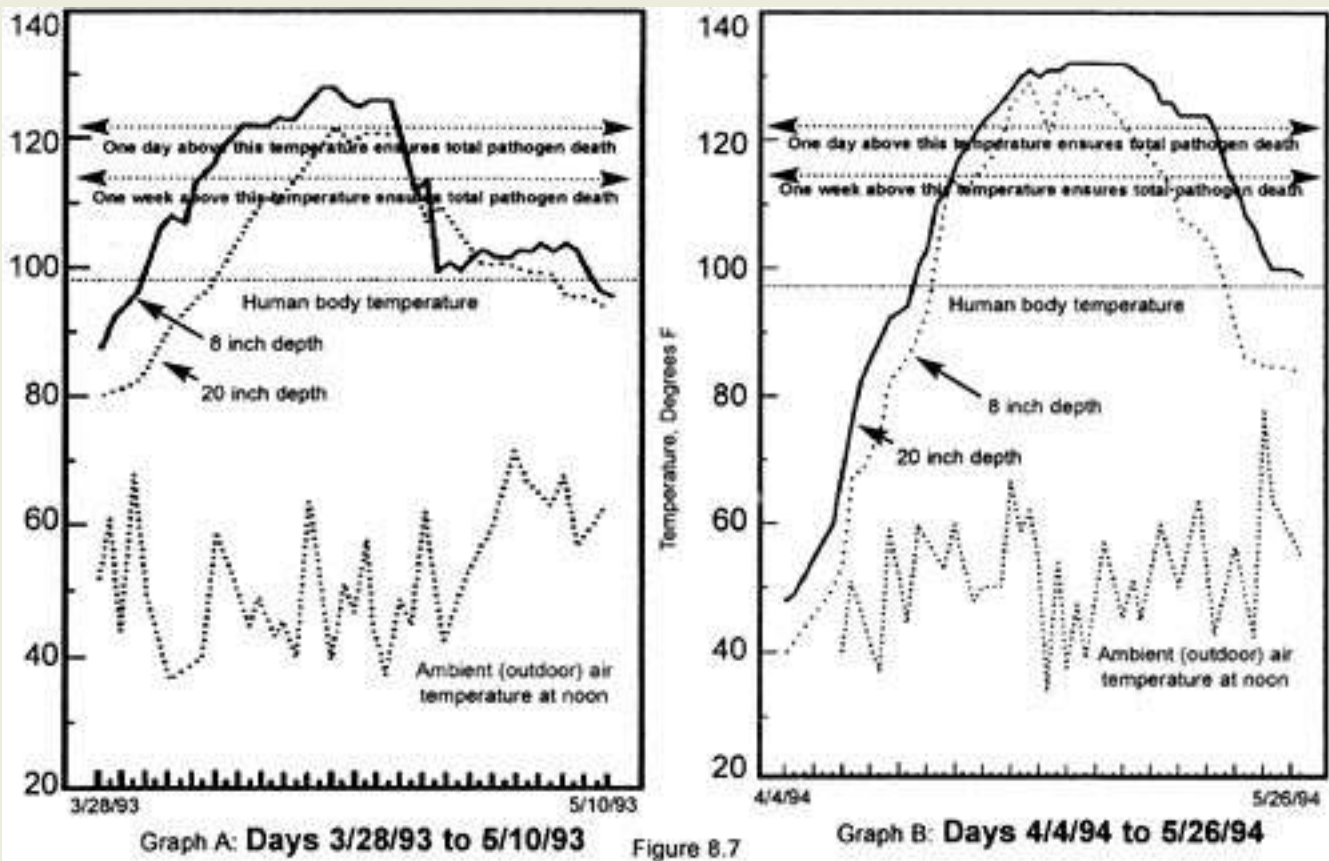

Graph A: Days 3/28/93 to 5/10/93

Figure 8.7

Graph B: Days 4/4/94 to 5/26/94

TEMPERATURE CURVE OF HUMANURE COMPOST PILES AFTER SPRING THAW

The above compost piles were situated outdoors, in wooden bins, on bare soil. The compost was unturned and no compost starters were used. Ingredients included humanure, urine, food scraps, hay, weeds, leaves, and some chicken manure (on right). The compost was frozen solid, but exhibited the above temperature climb after thawing. Fresh material was added to the compost pile regularly while these temperatures were being recorded on unmoved thermometers. The hot area of the compost pile remained in the upper section of the compost as the pile continued to be built during the following summer. In the fall, the compost cooled down, finally freezing and becoming dormant until the following spring. It is imperative that humanure compost rise above the temperature of the human body for an extended period of time. This is the "fever effect," which is necessary to destroy pathogens. A temperature exceeding 120°F for at least one day is preferred, although lower temperatures for longer periods can be effective (see Chapter 7). The heating of the compost should be followed by a lengthy curing period (at least a year).



“Thank you for a wonderful book on a subject where little information is available. We started using our ‘system’ the day after receiving your book. It took about two hours to put together. I wish that more problems that at first seemed complicated and expensive could be solved as simply as this one has with your help.” J.F. in NY

From a Christmas letter to friends and relatives:

“I am sorry to say that the solar toilet...never got off the ground. The plans from the book were sketchy and we weren’t able to get it to work. It’s sitting in the back of the property covered and waiting to be converted into a solar oven. But luckily we read another book [Humanure Handbook] which had an even better method suited for our household. With minimal fuss and expense we set up the system, and it’s working great.” J.S. in CA

Two thermometers were used to monitor the temperature of this compost, one having an 8” probe, the other having a 20” probe. The outside of the pile (8” depth) shown on Graph A was heated by thermophilic activity before the inside (20” depth). The outside thawed first, so it started to heat first. Soon thereafter, the inside thawed and also heated. By April 8th, the outer part of the pile had reached 50°C (122°F) and the temperature remained at that level or above until April 22nd (a two-week period). The inside of the pile reached 122°F on April 16th, over a week later than the outside, and remained there or above until April 23rd. The data suggest that the entire pile was at or above 122°F for a period of eight days before starting to cool. The pile shown in Graph B was above 122°C for 25 days.

According to Dr. T. Gibson, Head of the Department of Agricultural Biology at the Edinburgh and East of Scotland College of Agriculture, “All the evidence shows that a few hours at 120 degrees Fahrenheit would eliminate [pathogenic microorganisms] completely. There should be a wide margin of safety if that temperature were maintained for 24 hours.” [2](#)

The significance of the previous graphs is that they show that the humanure compost required no coaxing to heat up sufficiently to be rendered hygienically safe. It just did it on its own, having been provided the simple requirements a compost pile needs.



“The one alteration I’m going to make to the potty pictured in your book is a hinged door on the front and an attachable wagon handle, and, of course, large wheels on a shallow box the bucket rests in. That’s only because I’m older (55), small and have arthritis. I can’t pick up five gallons of anything wet and heavy. I could empty the bucket on a daily basis, but I don’t know if that’s a good idea or if it would screw up the working of the compost pile [author’s note: it wouldn’t]. Thank you for taking on the work and expense of sharing your experience with those of us who want to leave small or no footprints on our Mother Earth. (P.S. My children will be horrified! No doubt they will choose to stay at a motel and eat at restaurants.)” C.M. in AZ

THE SAWDUST TOILET ON CAMPING TRIPS

Humanure composters have tricks up their sleeves. Ever go on a week-long camping trip or to a camping music festival and hate using those awful portable chemical toilets that stink? If you have a humanure compost bin at home, simply take two five gallon buckets with you on the trip. Fill one with a cover material, such as rotted sawdust, and put a lid on it. Set it inside the empty bucket and pack it along with your other camping gear. Voila! One portable composting toilet! When you set up your camp, string up a tarp for privacy and set the two containers in the private space. Use the empty container as a toilet, and use the cover material to keep it covered. Place a lid on it when not in use. No standing in line, no odors, no chemicals, no pollution. This toilet will last several days for two people. When you leave the camp, take the “soil nutrients” home with you and add them to your compost pile. You will probably be the only campers there who didn’t leave anything behind, a little detail that you can be proud of. And the organic material you collected will add another tomato plant or blueberry bush to your garden. You can improve on this system by taking a toilet seat that clamps on a five gallon bucket, or even taking along a home-made toilet box with seat (as shown in Figures 8.3 and 8.4).

A SIMPLE URINAL

Want to collect urine only? Maybe you want a urinal in a private office, bedroom, or shop. Simply fill a five gallon bucket with rotted sawdust or other suitable material, and put a tight lid on it. A bucket full of sawdust will still have enough air space in it to hold about a week’s worth of urine from one adult. Urinate into the bucket, and replace the lid when not in use. For a fancy urinal, place the sawdust bucket in a toilet cabinet such as illustrated in Figures 8.1, 8.2, 8.3, and 8.4. When the bucket is full, deposit it on your compost pile. The sawdust inhibits odors, and balances the nitrogen in the urine. It sure beats the frequent trips to a central toilet that coffee drinkers are inclined to

make, and no “soil nutrients” are going to waste down a drain.



WHY NOT PLACE THE COMPOST BINS DIRECTLY UNDERNEATH THE TOILET?

The thought of carrying buckets of humanure to a compost bin can deter even the most dedicated recycler. What if you could situate your toilet directly over your compost bins? Here's some reader feedback:

"I finally write back to you after 2 1/2 years of excitingly successful and inspiring use of humanure methods applied to a 'direct shitter' compost. We indeed built a beautiful humanure receptacle 10 feet long, 4 feet high and 5 feet wide, divided into two chambers. One chamber was used (sawdust after every shit, frequent green grass and regular dry hay applications) from May 1996 until June 1997, then

nailed shut. We moved to the second chamber until June 1998 — when with excitement mounting, we unscrewed the boards at the back of the “Temple of Turds” (our local appellation) and sniffed the aroma...of the most gorgeous, chocolate brownie, crumbly compost ever SEEN. Yes, I thrust my hands fully into the heavenly honey pot of sweet soil, which soon thereafter graced the foundations of our new raspberry bed. Needless to say, the resulting berries knew no equal. Humanure and the potential for large-scale . . . even a city size composting collection (apartment building toilets into a central collection dumpster), along with the crimes of the so-called “septic system,” has become one of my most favored topics of conversation and promotion. Often through direct exposition at our farm. Many thanks for your noble work of art and contribution to this stinky species of ape.” R.T. in CT



MORE ON INSTALLING THE COMPOST BINS UNDER YOUR HOUSE

The **Straw Bale House** in Ship Harbor, Nova Scotia, Canada, built in 1993, employed an outhouse until 1998 when a composting toilet was built. The toilet allowed for the direct depositing of humanure into compost chambers underneath the house. Designer/builder Kim Thompson provides feedback:

“Having heard and experienced mixed success with commercial composting toilets, it was exciting to read the Humanure Handbook and

have systems detailed which reinforced ideas that had only existed with me intuitively before. I did a lot of research on the subject, but as far as I could make out, the indoor system I wanted to try hadn't been done before. After several phone conversations with Joe Jenkins, his encouragement, and a sharing of plans, I went ahead with the project. Two concrete chambers, three feet high by five feet square, with four inch thick walls, were built on a six inch gravel base with a French drain, underneath the house. In the bathroom above, a wooden box was fitted with a standard toilet seat as

well as a compartment for sawdust storage. All kitchen scraps, straw, and some garden compost were added regularly to the compost chambers, as well as the sawdust cover material. Red wiggler worms were added as well. Two and a half residents used the toilet, and the first chamber filled in six months.

Because there wasn't a good starter base of organic material, and because there was no drain (one was added later), the compost was, for many months, a sloppy, ineffectual mess. I now recommend layering the following materials in a composting chamber before it is used: one foot of straw, six inches of sawdust, a couple buckets of compost as a starter, one foot of leaf compost, and three inches of sawdust (or something like that depending on availability of local resources). Be sure to include a drainage system from the chambers to prevent a build-up of urine.

Make sure there are screens over the access doors to the chambers which can be easily removed, as easy access to the chambers makes it more likely that they will be maintained and monitored regularly. In a northern climate the chambers need to be constructed in such a way as to insure that they won't heave with the frost. It is important to insulate the chambers during the winter months to optimize conditions for thermophilic activity.

The learning curve on how to maintain and use the system efficiently has been steep. It is like learning how to make bread, easy when you know how. Smell has been the biggest problem so far. We have tried three different ways of venting and find that it still smells on occasion. Venting is currently done through a stove-pipe flue. I intend to install a small photovoltaic fan that will either draw air into the stove-pipe or directly outside through a vent. I injured myself over the winter and found that maintenance of the composting toilet system for a single person with a disability was difficult, especially hauling the bags of frozen sawdust cover material into the storage area. I had thought that establishing thermophilic activity in the second chamber over the winter months would be difficult, but a couple buckets of compost from the first chamber activated the new chamber almost immediately. The draft created by the toilet seat hole while in use, especially in the winter, has been variously described. A simple way of sealing the seat when not in use needs to be developed. We have been using a piece of polystyrene foam with a handle which sits in the box under the seat. It works, but isn't elegant.

I love the fact that I don't have to deal with a septic system and that the compost produced will help feed my family. The composting toilet complements well my work with low impact, natural building systems. Many people who contact Straw Bale Projects about construction are also interested in the compost toilet alternative."

For more information contact Kim Thompson, Straw Bale Projects, 13183 Hwy #7, Ship Harbor, NS Canada B0J 1Y0; EMail: <mailto:shipharbor@ns.sympatico.ca>

<http://www.jenkinspublishing.com/>

MENU: [HOME](#) » [Reconstruction](#) » [Recovery](#) » [Renewal](#) » [Survival](#) » [Humanure Content](#)

MENU: [HOME](#) » [Reconstruction](#) » [Recovery](#) » [Renewal](#) » [Survival](#) » [Humanure Content](#)

FECOFRIGGINFOBIA

There seems to be an irrational fear among fecophobes that if you don't die instantly from humanure compost, you'll die a slow, miserable, and wretched death, or you'll surely cause an epidemic of something like the plague and everyone within 200 miles of you will die, or you'll become so infested with parasitic worms that you'll no longer be recognized as human (your head will look like spaghetti).

These fears exist perhaps because much of the information in print concerning the recycling of humanure is confusing, erroneous, or incomplete. For example, when researching the literature during the preparation of this book, I found it surprising that almost no mention is ever made of the thermophilic composting of humanure as a viable alternative to other forms of on-site sanitation. When "bucket" systems are mentioned, they are also called "cartage" systems, and are universally decried as being the least desirable sanitation alternative. For example, in *A Guide to the Development of On-Site Sanitation* by Franceys et al., published by the World Health Organization in 1992, "bucket latrines" are described as "*malodorous, creating a fly nuisance, a danger to the health of those who collect or use the nightsoil, and the collection is environmentally and physically undesirable.*" This sentiment is echoed in Rybczynski's (et al.) World Bank funded work on low-cost sanitation options, where it is stated that "*the limitations of the bucket latrine include the frequent collection visits required to empty the small container of [humanure], as well as the difficulty of restricting the passage of flies and odors from the bucket.*"

YET ANOTHER TIP FROM THE INFAMOUS MR. TURDLEY

PRESSURE TREATED LUMBER SHOULD NEVER BE USED TO MAKE COMPOST BINS

Or for anything else, either, when the lumber is soaked with chromated copper arsenate. CCA saturated lumber would be more appropriately called "cancer-soaked" lumber rather than euphemistically referred to as "pressure treated."

Both arsenic and chromium have been classified as human



carcinogens (causing cancer) and are suspected mutagens (causing mutations). The poisons in cancer-soaked lumber are widely documented to leach into the soil and rub off onto skin and clothing.

Such material has no place in organic gardens or compost bins. You can't even safely burn cancer-soaked lumber to get rid of it — it produces highly toxic fumes and ash. Be very careful when getting sawdust from a lumber yard. It may contain highly toxic cancer-soaked sawdust!

I've personally used a sawdust toilet for 20 years and it has never caused odor problems, fly problems, health problems, or environmental problems. Quite the contrary, it has actually *enhanced* my health, the health of my family, and the health of my environment by producing healthy, organic food in my garden, and by keeping human waste out of the water table. Nevertheless, Franceys et al. go on to say that “[humanure] collection should never be considered as an option for sanitation improvement programmes, and all existing bucket latrines should be replaced as soon as possible.” Say what?

Obviously Franceys et al. are referring to the practice of collecting humanure in buckets without a cover material (which would surely stink to high heaven and attract flies) and without any intention of composting the humanure. Such buckets of feces and urine are presumably dumped raw into the environment. Naturally, such a practice should be decried and strongly discouraged, if not outlawed. However, rather than forcing people who use such crude waste disposal methods to switch to other more prohibitively costly waste disposal methods, perhaps it would be better to educate those people about *resource recovery*, about the *human nutrient cycle*, and about *thermophilic composting*. It would be more constructive to help them acquire adequate and appropriate *cover materials* for their toilets, assist them in constructing compost bins, and thereby eliminate waste, pollution, odor, flies, and health hazards altogether. I find it inconceivable that intelligent, educated scientists who observe bucket latrines and the odors and flies associated with them do not see that the simple addition of a clean organic cover material to the system would solve the aforementioned problems, and balance the nitrogen of the humanure with carbon.

Franceys et al. state, however, in their aforementioned book, that “*apart from storage in double pit latrines, the most appropriate treatment for on-site sanitation is composting.*” I would agree that composting, when done properly, is the most appropriate method of on-site sanitation available to humans. I would not agree that double pit storage is more appropriate than thermophilic composting unless it could be proven that all human pathogens could be destroyed using such a double pit system,

and that such a system would produce no unpleasant odor, and would not require the segregation of urine from feces. According to Rybczynski, the double pit latrine shows a reduction of *Ascaris* ova of 85% after two months, a statistic which does not impress me. When my compost is finished, I don't want *any* pathogens in it.

Ironically, the work of Franceys et al. further illustrates a “decision tree for selection of sanitation” that indicates the use of a “compost latrine” as being one of the least desirable sanitation methods, and one which can only be used if the user is willing to collect urine separately. Unfortunately, contemporary professional literature is rife with this sort of inconsistent and incomplete information which would surely lead a reader to believe that composting humanure just isn't worth the trouble.

On the other hand, Hugh Flatt, who, I would guess, is a practitioner and not a scientist, in *Practical Self-Sufficiency* tells of a sawdust toilet system he had used for decades. He lived on a farm for more than 30 years which made use of “bucket lavatories.” The lavatories serviced a number of visitors during the year and often two families in the farmhouse, but they used no chemicals. They used sawdust, which Mr. Flatt described as “absorbent and sweet-smelling.” The deciduous sawdust was added after each use of the toilet, and the toilet was emptied on the compost pile daily. The compost heap was located on a soil base, the deposits were covered each time they were added to the heap, and kitchen refuse was added to the pile (as was straw). The result was “*a fresh-smelling, friable, biologically active compost ready to be spread on the garden.*” [3](#)



From a Public Radio Commentary

“People are saying that the Year 2000 computer problem could foul up a lot of stuff we usually depend on, all at once. I thought I'd give this Y2K Practice Day a try. Turn off the heat, lights, water and phones. Just for 24 hours. The day before Practice Day, I complained to Larry, telling him that I was bitterly disappointed not to try out an emergency toilet. This complaining really paid off. Larry, who's also a writer researching Year 2000 emergency preparedness, phoned a man named Joe Jenkins, author of a book called the Humanure Handbook. Joe reassured my husband of the safe, sanitary, and uncomplicated

method for composting human waste. His solution is based on 20 years of scholarly study. It turns out that the thermophilic bacteria in human waste, when mixed with organic material like peat moss or sawdust, creates temperatures over 120 degrees Fahrenheit, rapidly killing pathogens just as Mother Nature intended.

We grew bold and daring and decided to use our emergency five gallon bucket with the toilet seat, layering everything with peat moss. Larry spent maybe a half hour building a special compost bin. This was right up his alley, since he already composts all the kitchen scraps, yard, and dog wastes.

Surprisingly, I found myself liking that little toilet. It was comfortable, clean, with no odor, just a slightly earthy smell of peat moss. The soul-searching came when I contemplated going back to the flush toilet.

By coincidence, I recently heard a presentation by the director of the local waste treatment facility. He was asked to address the issue of Year 2000 disruptions and explain what preparations were being made. In a matter-of-fact voice, he described what a visitor from another planet would undoubtedly consider a barbaric custom. First, we defecate and urinate in our own clean drinking water. In our town, we have 800 miles of sewers that pipe this effluent to a treatment facility where they remove what are euphemistically called solids. Then they do a bunch more stuff to the water, I forget exactly what. But I do remember that at one point, they dose it with a potent poison — chlorine, of course — and then they do their best to remove the chlorine. When all this is done, the liquid gushes into the Spokane River.

At this meeting was a man named Keith who lives on the shores of Long Lake, down river from us. Keith was quite interested to know what might occur if our sewage treatment process was interrupted. The waste treatment official assured him that all would be well, but I couldn't help reflecting that Keith might end up drinking water that we had been flushing. I like Keith. So I decided to keep on using my camp toilet.

My husband is a passionate organic gardener, at his happiest with a shovel in his hand, and he's already coveting the new compost. He's even wondering if the neighbors might consider making a contribution. I'm just grateful the kids are grown and moved out, because they'd have a thing or two to say."

Judy Laddon in WA (excerpted with permission)

Perhaps the "experts" will one day understand, accept, and advocate simple humanure composting techniques such as the sawdust toilet. However, we may have to wait until Composting 101 is taught at the university, which may occur shortly after hell freezes over.

In the meantime, those of us who use simple humanure composting methods must view the comments of today's so-called experts with a mixture of amusement and chagrin. Consider, for example, the following comments posted on the World Wide Web by an "expert." A reader posted a query on a compost toilet forum website wondering if anyone had any scientific criticism about the above mentioned sawdust toilet system. The expert replied that he was about to publish a new book on composting toilets, and he offered the following excerpt:

"Warning: Though powerfully appealing in its logic and simplicity, I'd expect this system to have an especially large spread between its theoretical and its practical effectiveness. If you don't have a consistent track record of maintaining high temperatures in quick compost piles, I'd counsel against using this system. Even among gardeners, only a small minority assemble compost piles which consistently attain the necessary high temperatures . . . Health issues I'd be concerned about are 1) bugs and small critters fleeing the high-temperature areas of the pile and carrying a coat of pathogen laden feces out of the pile with them; 2) large critters (dog, raccoons, rats . . .) raiding the pile for food and tracking raw waste away; and 3) the inevitable direct exposure from carrying, emptying, and washing buckets.

Some clever and open-minded folk have hit on the inspiration of composting feces . . . by adding them to their compost piles! What a revolutionary concept! . . . Sound too good to

be true? Well, in theory it is true, though in practice I believe that few folks would pass all the little hurdles along the way to realizing these benefits. Not because any part of it is so difficult, just that, well, if you never ate sugar and brushed and flossed after every meal, you won't get cavities either.”⁴

Sound a bit cynical? The above comments are entirely lacking in scientific merit, and expose an “expert” who has no experience whatsoever about the subject on which he is commenting. It is disheartening that such opinions would actually be published, but not surprising. The writer hits upon certain knee-jerk fears of fecophobes. His comment on bugs and critters fleeing the compost pile coated with pathogen-laden feces is a perfect example. It would presumably be a bad idea to inform this fellow that fecal material is a product of his body, and that if it is laden with pathogens, he’s in very bad shape. Furthermore, there is some fecal material probably inside him at any given moment. Imagine that — pathogen-infested fecal material brimming with disease-causing organisms actually sitting in the man’s bowels. How can he survive?

When one lives with a humanure composting system for an extended period of time, one understands that fecal material comes from one’s body, and exists inside oneself at all times. With such an understanding, it would be hard to be fearful of one’s own humanure, and impossible to see it as a substance brimming with disease organisms, unless, of course, one is diseased.

The writer hits upon another irrational fear — large animals, including rats, invading a compost pile and spreading disease all over creation. Compost bins are easily built to be animal-proof. If animals are a problem, the problem can be remedied by lining a compost bin with chicken wire, or surrounding the compost with pallets, straw bales, or similar barriers. In 20 years of humanure composting, we have never had a problem with animals, have never seen a rat in our compost, and our compost bins are not wire-lined. We have had dozens of skunks, possums, and raccoons in our chicken house, but never in our compost pile 50 feet away. It seems that the thermophilic composting process itself makes the organic material undesirable for larger animals, including dogs.

The writer warns that most gardeners do not have thermophilic compost. Most gardeners also leave critical ingredients out of their compost, thanks to the fear-mongering of the ill-informed. Those ingredients are humanure and urine, which are quite likely to make one’s compost thermophilic. Commercial composting toilets almost never become thermophilic. Does the author also condemn those? As we have seen, it is not only the temperature of the compost that destroys pathogens, it is retention time. The sawdust toilet compost pile requires a year’s construction time, and another year’s undisturbed retention time. When a thermophilic phase is added to this process, I would challenge anyone to come up with a more effective, earth-friendly, simpler, low-cost system for pathogen destruction.

Finally, the writer warns of “the inevitable direct exposure from carrying, emptying and washing buckets.” I’m not sure what he’s getting at here, as I have carried, emptied, and washed buckets for 20 years and never had a problem.



“We’ve been joyfully composting for some time already, and adding our humanure since this spring. Your book was immensely informative, helping to dispel some of those culturally imposed myths of fecophobia! Please know that the book is being eagerly passed about and many of our friends have also begun composting humanure, too! Again, thank you for all the years and time you and your family have spent experimenting and actively composting! Your work has been a great asset to our path of a simpler, sustainable and self-reliant lifestyle. We believe we are the keys to changing the dominant paradigm and healing the Earth. Thank you, thank you for the book!” B.C. and J.S. in AK

Other recent experts have thrown in their two cents worth on the sawdust toilet. A book on composting toilets (also about to be published as I write this), mentions the sawdust toilet system.⁵ Although the comments are not at all cynical and are meant to be informative, a bit of misinformation manages to come through. For example, the suggestion to use “rubber gloves and perhaps a transparent face mask so you do not get anything splashed on you” when emptying a compost bucket onto a compost pile, caused groans, a lot of eyes to roll, and a few giggles when read aloud to seasoned humanure composters. Why not just wear an EPA approved moon suit and carry the compost bucket at the end of a ten-foot pole? How is it that what has just emerged from one’s body can be considered so utterly toxic? More exaggeration and misinformation existed in the book regarding temperature levels and compost bin techniques. One warning to “bury finished compost in a shallow hole or trench around the roots of non-edible plants,” was classic fecophobia. Apparently, humanure compost is to be banned from human food production, never mind the human nutrient cycle. The authors recommended that humanure compost be composted again in a non-humanure compost pile, or micro-waved for pasteurization, both bizarre suggestions. They add, “Your health agent and your neighbors may not care for this [sawdust toilet composting] method.”

I have to scratch my head and wonder why the “experts” would say this sort of thing. Apparently, the act of *composting* one’s own humanure is so radical and even revolutionary to the people who have spent their lives trying to *dispose* of the substance, that they can’t quite come to grips with the idea. Ironically, a very simple sawdust toilet used by a physician and his family in Oregon is featured and illustrated in the above book. The physician states, “*There is no offensive odor. We’ve never had a complaint from the neighbors.*” Their sawdust toilet system is also illustrated and posted on the internet, where a brief description sums it up: “*This simple composting toilet system is inexpensive both in construction and to operate and, when properly maintained, aesthetic and hygienic. It is a perfect complement to organic gardening. In many ways, it out-performs complicated systems costing hundreds of times as much.*” Often, knowledge derived from real-life experiences can be diametrically opposed to the speculations of “experts.” Sawdust toilet users find, through *experience*, that such a simple system can work remarkably well.



“My wife and I have just finished reading your handbook and found it an inspiration in our pursuit of alternative living styles. Our system is up and functioning very well for us and already building our future garden bedding. We have discovered a certain level of ‘alienation’ when ‘friends’ have discovered our system. Although not particularly concerned about this ‘friendship purification process,’ we would like to network with other like-minded people to share ideas and experiences. If you have the fortune of knowing anyone using your technique in Eastern Washington-Northern Idaho area, would you please extend to them our invitation of friendship? Thank you for your book and your leadership into the rather solitary world of fecal familiarity.” K.K. and A.K. in WA

“I line the solids bucket with newspapers so that I don’t need to rinse it out.”
A.E. in Australia

What about “health agents”? Health authorities can be misled by misinformation, such as that stated by the above authors. Health authorities, according to my experience, generally know very little, if anything, about thermophilic composting. Many have never even heard of it. The health authorities who have contacted me are very interested in getting more information, and seem very open to the idea of a natural, low-cost, effective, humanure recycling system. They know that human sewage is a dangerous pollutant and a serious environmental problem, and they seem to be surprised and impressed to find out that such sewage can be avoided altogether. Most intelligent people are willing and able to expand their awareness and change their attitudes based upon new information. Therefore, if you are using a sawdust toilet and are having a problem with any authority, please give the authority a copy of this book. I have a standing offer to donate, free of charge, a copy of the *Humanure Handbook* to any permitting agent or health authority, no questions asked, upon anyone’s request — just send a name and address to the publisher at the front of this book.

Well-informed health professionals and environmental authorities are aware that “human waste” presents an environmental dilemma that is not going away.

The problem, on the contrary, is getting worse. Too much water is being polluted by sewage and septic discharges, and there has to be a constructive alternative. Perhaps that is why, when health authorities learn about the thermophilic composting of humanure, they realize that there may very likely be no better solution to the human waste problem. That may be also why I received a letter from the US Department of Health and Human Services praising my book and wanting to know more about humanure composting, or why the US Environmental Protection Agency wrote to me to praise the *Humanure Handbook* and order ten copies (and re-order more later), or why the PA Department of Environmental Protection nominated *Humanure* for a public-awareness environmental award in 1998. Fecophobes think composting humanure is dangerous. I will patiently wait until they come up with a better solution to the problem of “human waste.” I expect there will be a few cold days in hell before that happens.

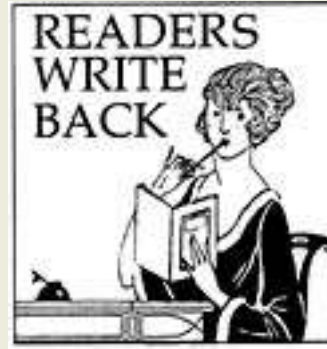

“Just a note to thank you for sending the gratis copies of Humanure to our local supervisors and health director. A small but significant step forward is shown by the

article on the reverse side and no doubt your book played a part [a newspaper article titled “Law Would Back Waterless Toilets” was copied on the back of the letter]. This victory may not seem like much but, believe me, getting these troglodytes to change their minds on anything is nothing less than a miracle! R.W. in CA

Source: *The Humanure Handbook*. Jenkins Publishing, PO Box 607, Grove City, PA 16127. To order, phone: 1-800-639-4099.

<http://www.jenkinspublishing.com/>

MENU: [HOME](#) » [Reconstruction](#) » [Recovery](#) » [Renewal](#) » [Survival](#) » [Humanure Content](#)

LEGALITIES

This is an interesting topic. It seems that some people believe that if you do anything differently from the mainstream, it must be illegal. Certainly composting humanure must be illegal. After all, humanure is a dangerous pollutant and must be immediately disposed of in a professional and approved manner. Recycling it is foolish and hazardous to your health and to the health of your community and your environment. At least that's what the fecophobes think. Therefore, recycling humanure can not be an activity that is within the law, can it? Well, yes actually, the backyard composting of humanure is probably quite within the letter of the laws to which you are subjected.

Waste disposal is regulated, and it should be. Waste disposal is potentially very dangerous to the environment. Sewage disposal and recycling are also regulated, and they should be, too. Sewage includes a host of hazardous substances deposited into a waterborne waste stream. People who compost their humanure are neither disposing of waste, nor producing sewage — they are recycling. Furthermore, regarding the regulating of composting itself, both backyard composting and farm composting are exempt from regulations unless the compost is being sold, or unless the farm compost operation is unusually large.

To quote one source, *“The US Department of Environmental Protection (DEP) has established detailed regulations for the production and use of compost created from [organic material]. These regulations exclude compost obtained from backyard composting and normal farming operations. Compost from these activities is exempt from regulation only if it is used on the property where it was composted, as part of the farming operation. Any compost which is sold must meet the requirements of the regulations.”*

[6](#)

Composting toilets are also regulated in some states. However, composting toilets are usually defined as toilets inside which composting takes place. A sawdust toilet, by definition, is *not* a composting toilet because no composting occurs in the toilet itself. The composting occurs in the “backyard” and therefore is not regulated by composting *toilet* laws. Portable toilet laws may apply instead, although the backyard compost exemption will probably allow sawdust toilet users to continue their recycling undisturbed.

A review of composting toilet laws is both interesting and disconcerting. For example, in Maine, it is apparently illegal to put kitchen food scraps down the toilet chute in a commercial composting toilet, even though the food scraps and toilet materials must go to the exact same place in the composting chamber. Such a regulation makes no sense whatsoever. In Massachusetts, finished compost from

composting toilets must be buried under six inches of soil, or hauled away and disposed of by a septage hauler. These laws are apparently written by people who are either lacking in knowledge and understanding, or are fecophobic, or, most likely, all of the above. Such laws can discourage the necessary and important recycling of humanure.

Ideally, laws are made to protect society. Laws requiring septic, waste, and sewage disposal systems are supposedly designed to protect the environment, the health of the citizens, and the water table. This is all to be commended, and conscientiously carried out by those who produce *sewage*, a waste material. If you don't produce sewage, you have no need for a sewage disposal system; laws pertaining to sewage disposal are not your concern. The number of people who produce backyard compost instead of sewage is so minimal, that few, if any, laws have been enacted to regulate the practice. The thermophilic composting of humanure is not a threat to society, it produces no pollution, does not threaten the health of humans, nor contaminate the groundwater or environment. Unfortunately, because this fact is not understood by many people, ignorance remains a problem.

It would be hard to intelligently argue that a person who produces no sewage must have a costly sewage treatment system. What would they do with it? That would be like requiring someone who doesn't own a car to have a garage. And it would be very difficult to prove that composting humanure is threatening to society, especially given the facts as presented in this book. It is much easier to prove that composting humanure is a *benefit* to society. On the other hand, Galileo, the astronomer, was arrested as a heretic and forced to renounce his theory that the Earth revolves around the sun. Yes, that was three hundred years ago, but sometimes it seems like the consciousness of our society as it relates to human manure is still back in the dark ages.

If you're concerned about your local laws, go to the library and see what you can find about regulations concerning backyard compost. Or inquire at your county seat or state agency as statutes, ordinances, and regulations vary from locality to locality. Where I live, septic system permits aren't required for new home construction, but the next county is two properties over and people there are required to have septic system permits before they can build a new dwelling. This is largely due to the fact that the water table tends to be high in my area, and septic systems don't always work, so sand mounds are required by law for sewage disposal. If you don't want to dispose of your manure but want to compost it instead (which will certainly keep it out of the water table, not to mention raise a few eyebrows at the local municipal office), you may have to stand up for your rights.

A reader called from a small state in New England to tell me his story. It seems the man had a sawdust toilet in his house, but the local municipal authorities decided he could only use an "approved" waterless toilet, meaning, in this case, an incinerating toilet. The man did not want an incinerating toilet because the sawdust toilet was working well for him and he liked making and using the compost. So he complained to the authorities, attended township meetings, and put up a fuss. To no avail. After months of "fighting city hall," he gave up and bought a very expensive and "approved" incinerating toilet. When it was delivered to his house, he had the delivery people set it in a back storage room. And that's where it remained, still in the packing box, never opened. The man continued to use his sawdust toilet for years after that. The authorities knew that he had bought the "approved" toilet, and thereafter left him alone.

He never did use it, but the authorities didn't care. He bought the damn thing and had it in his house, and that's what they wanted. Those local authorities obviously weren't rocket scientists.

Another interesting story comes from a fellow in Tennessee. It seems that he bought a house which had a rather crude sewage system — the toilet flushed directly into a creek behind the house. The fellow was smart enough to know this was not good, so he installed a sawdust toilet. However, an unfriendly neighbor assumed he was still using the direct waste dump system, and the neighbor reported him to the authorities. But let him tell it in his own words:

“Greetings from rural Tennessee.

I'm a big fan of your book & our primitive outhouse employs a rotating 5-gallon bucket sawdust shitter that sits inside a 'throne.' Our system is simple & based largely on your book. We transport the poop to a compost pile where we mix the mess with straw & other organic materials. The resident in our cabin before we bought the farm used a flush toilet that sent all sewage directly to a creekbed. An un-informed neighbor complained to the state in 1998, assuming that we used the same system. The state people have visited us several times. We were forced to file a \$100 application for a septic system but the experts agree that our hilly, rocky house site is not suitable for a traditional septic system even if we wanted one. They were concerned about our grey water as well as our composting outhouse. My rudimentary understanding of the law is that the state approves several alternative systems that are very complicated and at least as expensive as a traditional septic. The simple sawdust toilet is not included & the state does not seem to want any civilian to actually transport his own shit from the elimination site to a different decomposition site. The bureaucrats tentatively approved an experimental system where our sewage could feed a person-made aquatic wetlands type thingie & they agreed to help us design & implement that system. Currently, we cannot afford to do that on our own & continue to use our sawdust bucket latrine. The officials seem to want to leave us alone as long as our neighbors don't complain anymore. So, that's a summary of our situation here in Tennessee. I've read most of the state laws on the topic; like most legal texts, they are virtually unreadable. As far as I can tell, our system is not explicitly banned but it is not included in the list of "approved" alternative systems that run the gamut from high-tech, low volume, factory-produced composting gizmos to the old fashioned pit latrine. For a while now, I've wanted to write an article on our experience and your book. Unfortunately, grad school in English has seriously slowed down my freelance writing.”

Cheers, A.S. in Tennessee

Other than the above two situations, I have heard no details from other readers who may have had problems with authorities in relation to their sawdust toilets. Nevertheless, as part of the research for this second edition, I have undertaken a review of US state regulations pertaining to composting toilets, and that information is included in [Appendix 3](#).

In Pennsylvania, the state legislature has enacted legislation “*encouraging the development of resources recovery as a means of managing solid waste, conserving resources, and supplying energy.*” Under such legislation the term “disposal” is defined as “*the incineration, dumping, spilling, leaking, or placing of solid waste into or on the land or water in a manner that the solid waste or a constituent of the solid waste enters the environment, is emitted into the air or is discharged to the waters of the Commonwealth.*” ⁷ Further legislation has been enacted in Pennsylvania stating that “*waste reduction and recycling are preferable to the processing or disposal of municipal waste,*” and further stating “*pollution is the contamination of any air, water, land or other natural resources of this Commonwealth that will create or is likely to create a public nuisance or to render the air, water, land, or other natural resources harmful, detrimental or injurious to public health, safety or welfare. . .*” ⁸ In view of the fact that the thermophilic composting of humanure involves recovering a resource, requires no disposal of waste, and creates no environmental pollution, it is unlikely that anyone who conscientiously engages in such an activity would be unduly bothered by anyone. Don’t be surprised if most people find such an activity commendable, because, in fact, it is.

If there aren’t any regulations concerning backyard compost in your area, then be sure that when you’re making your compost, you’re doing a good job of it. It’s not hard to do it right. The most likely problem you could have is an odor problem, and that would simply be due to not keeping your deposits adequately covered with clean, not-too-airy, organic “biofilter” material. If you keep it covered, it does not give off offensive odors. It’s that simple. Perhaps shit stinks so people will be naturally compelled to cover it with something. That makes sense when you think that thermophilic bacteria are already in the feces waiting for the manure to be layered into a compost pile so they can get to work. Sometimes the simple ways of nature are really profound.

Few people understand that the composting of humanure is a benign method of recycling what would otherwise be a toxic waste material. For that reason, this book is recommended reading for people involved in municipal, county, or township waste treatment or permitting, or resource recovery. So when you’re feeling especially benevolent, buy an extra copy of *Humanure* and give it to your local authority. Anonymously, if necessary.

What about flies — could they create a public nuisance or health hazard? I have never had problems with flies on my compost. Perhaps the compost heats up so fast that flies don’t have a chance to enjoy it. Of course, a clean cover material is kept over the compost pile at all times. Concerning flies, F. H. King, who traveled through China, Korea, and Japan in the early 1900s when organic material, especially humanure, was the only source of soil fertilizer, stated, “*One fact which we do not fully understand is that, wherever we went, house flies were very few. We never spent a summer with so little annoyance from them as this one in China, Korea and Japan. If the scrupulous husbanding of [organic] refuse so universally practiced in these countries reduces the fly nuisance and this menace to health to the extent which our experience suggests, here is one great gain.*” He added, “*We have adverted to the very small number of flies observed anywhere in the course of our travel, but its significance we did not realize until near the end of our stay. Indeed, for some reason, flies were more in evidence during the first two days on the steamship out from Yokohama on our return trip to America, than at any time before on our*

journey.” ⁹

If an entire country the size of the United States, but with twice the population (at that time), could recycle all of its organic refuse without the benefit of electricity or automobiles and not have a fly problem, surely we in the United States can recycle a greater portion of our own organic refuse with similar success today.

Source: The Humanure Handbook. Jenkins Publishing, PO Box 607, Grove City, PA 16127. To order, phone: 1-800-639-4099.

<http://www.jenkinspublishing.com/>

MENU: [HOME](#) » [Reconstruction](#) » [Recovery](#) » [Renewal](#) » [Survival](#) » [Humanure Content](#)

MENU: [HOME](#) » [Reconstruction](#) » [Recovery](#) » [Renewal](#) » [Survival](#) » [Humanure Content](#)

ENVIRONMENTAL POTTY TRAINING 101

Simple, low-tech composting systems not only have a positive impact on the Earth's ecosystems, but are proven to be sustainable. Westerners may think that any system not requiring technology is too primitive to be worthy of respect. However, when western culture is nothing more than a distant and fading memory in the collective mind of humanity thousands (hundreds?) of years from now, the humans who will have learned how to survive on this planet in the long term will be those who have learned how to live in harmony with it. That will require much more than intelligence or technology — it will require a sensitive understanding of our place as humans in the web of life. That self-realization may be beyond the grasp of our egocentric intellects. Perhaps what is required of us in order to gain such an awareness is a sense of humility, and a renewed respect for that which is simple.

Some would argue that a simple system of humanure composting can also be the most advanced system known to humanity. It may be considered the most advanced because it works well while consuming little, if any, non-renewable resources, producing no pollution, and actually creating a resource vital to life.

Others may argue that in order for a system to be considered “advanced,” it must display all the gadgets, doodads and technology normally associated with advancement. The argument is that something is advanced if it's been created by the scientific community, by humans, not by nature. That's like saying the most advanced method of drying one's hair is using a nuclear reaction in a nuclear power plant to produce heat in order to convert water to steam. The steam is then used to turn an electric generator in order to produce electricity. The electricity is used to power a plastic hair-drying gun to blow hot air on one's head. That's *technological* advancement. It reflects humanity's *intellectual* progress . . . (which is debatable).

True advancement, others would argue, instead requires the balanced *development* of humanity's intellect with physical and spiritual development. We must link what we know intellectually with the physical effects of our resultant behavior, and with the understanding of ourselves as small, interdependent, interrelated life forms relative to a greater sphere of existence. Otherwise, we create technology that excessively consumes non-renewable resources and creates toxic waste and pollution in order to do a simple task such as hair drying, which is easily done by hand with a towel. If that's advancement, we're in trouble.

Perhaps we're really advancing ourselves when we can function healthfully, peacefully, and sustainably

without squandering resources and without creating pollution. That's not a matter of mastering the intellect or of mastering the environment with technology, it's a matter of mastering one's self, a much more difficult undertaking, but certainly a worthy goal.

Finally, I don't understand humans. We line up and make a lot of noise about big environmental problems like incinerators, waste dumps, acid rain, global warming, and pollution. But we don't understand that when we add up all the tiny environmental problems each of us creates, we end up with those big environmental dilemmas. Humans are content to blame someone else, like government or corporations, for the messes we create, and yet we each continue doing the same things, day in and day out, that have created the problems. Sure, corporations create pollution. If they do, don't buy their products. If you have to buy their products (gasoline for example), keep it to a minimum. Sure, municipal waste incinerators pollute the air. Stop throwing trash away. Minimize your production of waste. Recycle. Buy food in bulk and avoid packaging waste. Simplify. Turn off your TV. Grow your own food. Make compost. Plant a garden. Be part of the solution, not part of the problem. If you don't, who will?

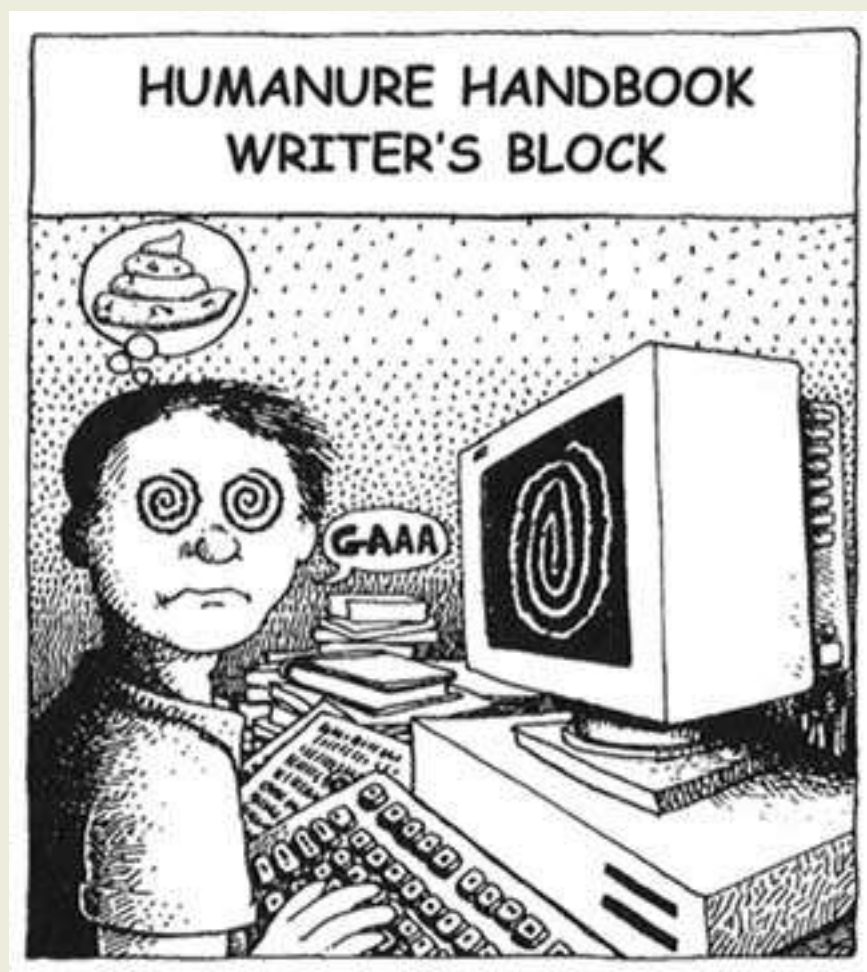

Source: *The Humanure Handbook*. Jenkins Publishing, PO Box 607, Grove City, PA 16127. To order, phone: 1-800-639-4099.

<http://www.jenkinspublishing.com/>

MENU: [HOME](#) » [Reconstruction](#) » [Recovery](#) » [Renewal](#) » [Survival](#) » [Humanure Content](#)

The Ten Outstanding Books of the Year (Awarded in 2002 for books published in 2001)

For 20 years our mission at Independent Publisher has been to recognize and encourage the work of independent publishers. We applaud those out there on the front lines, exhibiting the courage and creativity it takes to get noticed and to impress readers in a world of superstores and publishing conglomerates.

The Ten Outstanding Books of the Year were chosen for exemplifying that kind of independent spirit. Each will receive a \$500 cash award.

Most Inspirational to Youth

Where Does God Live?
by August Gold & Matthew J. Perlman
(Skylight Paths Publishing)

Business Breakthrough of the Year

The Answer to How is Yes: Acting on What Matters
by Peter Block
(Berrett-Koehler Publishers)

Most Likely To Save the Planet

Visionaries: People and Ideas to Change Your Life
by Jay Walljasper, Jon Spayde and the editors of Utne Reader
(New Society Publishers)

Best Health Book

The McCall Body Balance Method:
Simple Concepts for Ageless Movement
by Lisa Ann McCall
(Brown Books)

Best Book Arts/Craftsmanship

Sophocles' Antigone
retold by Gita Wolf & Sirish Rao
illus. Indrapramit Roy
Designed by Rathna Ramanathan
(Getty Publications)

Best Corporate Branding Book

Single Malt Whisky: An Italian Passion
by Umberto Angeloni (Brioni Books)

Most Life-Changing

Continuation: Honoring and Celebrating the Human Condition

by R. Scott Brooks
(Continuation Publishing Group)

Most Original Concept

Flowers, the Angels' Alphabet: The Language and Poetry of
Flowers

by Susan Loy
(CSL Press)

Story Teller of the Year

Jack Fritscher

Author of What They Did to the Kid: Confessions of an Altar Boy
(Palm Drive Publishing)

Most Unique Design

Martha Madigan - Vernal Equinox: Recent Photograms
(Michael Rosenfeld Gallery)

Independent Publisher

leading the world of bookselling in new directions



Independent Publisher

Book Awards

Highlighted Titles

Industry Update

Get Published

Sell More Books

Resources

Subscribe

[Table of Contents](#)

[Contact the Editor](#)

Search the Archives.
Enter key word(s) and
click "Go".

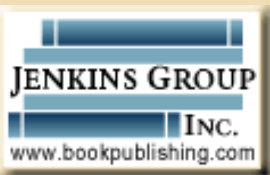

Independent Publisher
Online
400 W. Front St.
Traverse City, MI
49684
Ph: 231.933.0445
fax: 231.933.0448

“Like Riding a Roller Coaster:” How an IPPY Award-Winning Author Found Her Literary Path *by Joan Schweighardt & Jacqueline Church Simonds*

An IPPY Award Winner Profile [Read this feature](#)

Improve Your Writing Business NOW! *Two New Books Offer Suggestions*

A Back-to-School Special Report [Read this feature](#)

Building the Buzz: New Book Helps Savvy Authors through the Perfect (Publicity) Storm *A "Back-to-School" Special Report*

Includes the Ten Things You Can Do if your Book's Not Getting Media Attention [Read this feature](#)

Way Cool: Gerard Jones Finally Gets Published! *By Nina L. Diamond*

The long-suffering creator of the popular Everyone Who's Anyone In Publishing website gets his book published. So why is he still so cranky? [Read this feature](#)

The Book Coach Says: A Monthly Column of Book Marketing Advice *by Judy Cullins*

IP Department

This month: Top Ten Tips To Get Started Writing Your Book [Read this department](#)

**Vol. 22 #9
September 2004
Back To School!**

**Independent Publisher
Book Awards**

["Recognizing Excellence in Independent Publishing" 2004 Awards Results Announcement - 2005 Awards Entry](#)

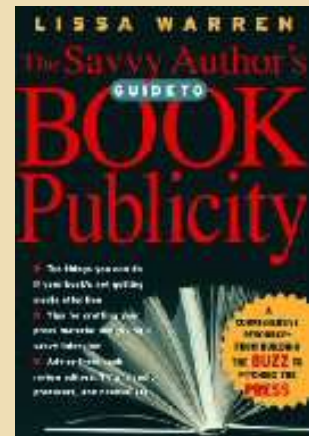

Build a Bigger Buzz for your Book!



Ginny Good is REALLY REALLY GOOD!

Recharge Your Life! with Dr. Sue

by Suzanne Zoglio, Ph.D.

IP Department

This Month: Keep a List of Firm Intentions [Read this department](#)

Much Ado About Publishing

By Nina L. Diamond

IP Department

Invasion of the Valley Girl Editors [Read this department](#)

INKLINGS: Writing Well & Profitably for Books, Film, and Stage

By Christina Hamlett

IP Department

This month: HOW TO ENDEAR YOURSELF TO THE EDITING DEPARTMENT [Read this department](#)



CELEBRATING THE IPPY AWARDS!

Results and photos from our "Night of Independent Stars" party and Independent Publisher Book Awards presentation

[Click here to see what you missed! \(Or see yourself on the dance floor...\)](#)

Independent Publisher Online is published by Jenkins Group, Inc.
copyright 2002, all rights reserved
web design by [Bright Bridge Communications, Inc](#)

Please visit these other Jenkins Group Publishing Service Companies:

[BookPublishing.com](#) [Jenkins Group, Inc.](#) [Books are Marketing Tools](#)

Special Market Book Sales **Printellectual**

THE HUMANURE HANDBOOK -- REFERENCE CITATIONS

[CHAPTER ONE](#) | [TWO](#) | [THREE](#) | [FOUR](#) | [FIVE](#) | [SIX](#) | [SEVEN](#) | [EIGHT](#) | [NINE](#) | [TEN](#)

REFERENCES - CHAPTER ONE - CRAP HAPPENS

- 1 - Brown, Lester R., et al. (1998). State of the World 1998. New York: W. W. Norton and Co., p. 115.
- 2 - Brown, Lester R., et al. (1999). State of the World 1999. New York: W. W. Norton and Co., p. 15.
- 3 - Associated Press. (1999 January 12).
- 4 - State of the World 1999, p. 14.
- 5 - State of the World 1999, p. 88.
- 6 - State of the World 1998, p. 3, 10.
- 7 - State of the World 1999, p. 10; State of the World 1998, p. 3.
- 8 - Brown, Lester R., et al. (1998). Vital Signs 1998. New York: W. W. Norton and Co., p. 20.
- 9 - State of the World 1998, p. 4, 5.
- 10 - State of the World 1998, p. 14.
- 11 - State of the World 1999, p. 79, 83.
- 12 - State of the World 1999, p. 87.
- 13 - State of the World 1998, p. 11, 41; State of the World 1999, p. 97.
- 14 - State of the World 1999, p. 13, 97.
- 15 - State of the World 1999, p. 20, 21, 41, 46.

16 - Steingraber, Sandra. (1997). Living Downstream. Reading, MA: Perseus Books, p. 70.

17 - Living Downstream, p. 90.

18 - Colborn, Theo, Dumanoksi, Diane and Myers, John Peterson. (1996). Our Stolen Future. New York: Penguin Books, p.137.

19 - Living Downstream, p. 103.

20 - State of the World 1999, p. 49; Living Downstream, p. 70.

21 - Living Downstream, p. 38, 40, 49, 59, 60.

22 - Our Stolen Future, p. 137.

23 - Ryan, Frank, M.D. (1997). Virus X. New York: Little, Brown and Co., p. 383-390.

24 - State of the World 1999, p. xix.

25 - Gelbspan, Ross. (1997). The Heat is On. Reading, MA: Addison-Wesley Publishing Co., Inc., p. 148, 157.

26 - Barker, Rodney. (1998). And the Waters Turned to Blood. New York: Touchstone.

REFERENCES - CHAPTER TWO - WASTE NOT WANT NOT

1 - Hershkowitz, Allen. (1997). Too Good to Throw Away: Recycling's Proven Record. Washington, D.C.: Natural Resources Defense Council, Chapter 2.

2 - Steingraber, Sandra. (1997). Living Downstream. Reading, MA: Perseus Books, p. 95.

3 - Living Downstream, p. 238.

4 - Too Good to Throw Away, Chapter Two.

5 - Brown, Lester R., et al. (1998). State of the World 1998. New York: W. W. Norton and Co., p. 106.

6 - Kantor, Linda S., et al. (1997, January - April). "Estimating and Addressing America's Food Losses." Food Review. Washington, D.C.: US Department of Agriculture, Commodity Economics Division, Economic Research Service.

7 - US Environmental Protection Agency. (May 1998) Characterization of Municipal Solid Waste in the United States: 1997 Update. Report # EPA530-R-98-007. Washington, D.C.: US Environmental Protection Agency, p. 29, 45.

8 - State of the World 1998, p. 102.

- 9 - State of the World 1998, p. 101, 166.
- 10 - State of the World 1998, p. 101.
- 11 - Environment Reporter. (1996 September 27)
- 12 - Too Good to Throw Away, Chapter Two.
- 13 - Too Good to Throw Away, Chapter Two.
- 14 - World Resource Foundation. (1998, April). Warmer Bulletin Information Sheet - Landfill.
- 15 - Hammond, A., et al. (Eds.) (1993). 1993 Information Please Environmental Almanac. New York. Houghton Mifflin Co., p. 60-64.
- 16 - Brown, Lester R., et al. (1999). State of the World 1999. New York: W. W. Norton and Co., p. 141.
- 17 - Daniel, J.E., et al., (Eds.). 1992 Earth Journal. Boulder, CO: Buzzworm Books, p. 94.
- 18 - Fahm, Lattee A. (1980). The Waste of Nations: The Economic Utilization of Human Waste in Agriculture. Montclair, NJ: Allenheld, Osmun & Co., p. 45.
- 19 - Golden, Jack, et al. (1979). The Environmental Impact Data Book. Ann Arbor, MI: Ann Arbor Science Publishers, Inc., p. 495.
- 20 - US Department of Commerce, National Oceanic and Atmospheric Administration, Office of Ocean Resources, Conservation and Assessment. (1987). The National Coastal Pollutant Discharge Inventory Database. Silver Spring, MD: DOC/NOAA/ORCA.
- 21 - Environment Reporter. (1991 November 22) p. 1799.
- 22 - Environment Reporter. (1992 January 3) p. 2103.
- 23 - Environment Reporter. (1992 February 14) p. 2373.
- 24 - Environment Reporter. (1991 December 27) p. 2072.
- 25 - Environment Reporter. (1992 January 17) p. 2144.
- 26 - Environment Reporter. (1992 May 1) p. 13.
- 27 - US Environmental Protection Agency. (September 1997). Beach Program, EPA#820-F-97-002. Washington, D.C.: US Environmental Protection Agency, p. 5.

- 28 - Environment Reporter. (1992 July 31). Washington D.C.: Bureau of National Affairs, Inc., p. 1110.
- 29 - Paul, Elizabeth. (1998). Testing the Waters VIII: Has Your Vacation Beach Cleaned Up Its Act?. Washington, D.C.: Natural Resources Defense Council, Inc.; NRDC Worldview News. (1998). Pollution Persists at US Beaches. Washington, D.C.: Natural Resources Defense Council, Inc.
- 30 - Bitton, Gabriel. (1994). Wastewater Microbiology. New York: Wiley-Liss, Inc., p. 368-369.
- 31 - National Resources Defense Council. (1997). Bulletin: Stop Polluted Runoff - 11 Actions to Clean up Our Waters. <http://www.nrdc.org/nrdcpn/fppubl.html>
- 32 - Wastewater Microbiology, p. 86.
- 33 - Ralof, Janet. (1998 March 21). "Drugged Waters--Does it Matter that Pharmaceuticals are Turning Up in Water Supplies?" Science News, Vol. 153 (No. 12), p. 187-189.
- 34 - State of the New England Environment. (1996). Preserving New England Natural Resources. <http://www.epa.gov/region01/soe/coastal.html>
- 35 - Environment Reporter. (1991 November 8) p. 1745-46; (1992 January 31) p. 2299.
- 36 - Toward Organic Security: Environmental Restoration or the Arms Race?. Peace and Environment Platform Project, c/o World Citizens Assembly, Suite 506, 312 Sutter St., San Francisco, CA 94018.
- 37 - Vital Signs 1998, p. 156.
- 38 - Courier. (1985, January). UNESCO. 7 Place de Fentenoy, 75700 Paris, France.
- 39 - State of the World 1999, p. 137.
- 40 - Vital Signs 1998, p. 156.
- 41 - Vital Signs 1998, p. 156, 157.
- 42 - Wastewater Microbiology, p. 79-80.
- 43 - Wastewater Microbiology, p. 261.
- 44 - Associated Press. (1993 April 10). Observer-Reporter. Washington and Green Counties, PA, p. A2; Carrolton, GA statistics from Wastewater Microbiology, p. 97.
- 45 - Goldstein, Debra. (1997). "Your drinking water: H₂O+what else?." e-Amicus. Washington, D.C.: National Resources Defense Council, <http://www.nrdc.org/eamicus/index.html>; US Environmental Protection Agency. Indicator 2: Population Served by Unfiltered Surface Water Systems at Risk from Microbiological Contamination. Washington, D.C.:

US Environmental Protection Agency.

46 - Gever, John, et al. (1986). Beyond Oil: The Threat to Food and Fuel in the Coming Decades, A Summary Report. Cambridge, MA: Ballinger Publishing Co.

47 - Solley, Wayne B., et al. (1990). "Estimated Water Use in the United States in 1990." US Geological Survey Circular 1081, Table 31. Denver, CO. United State Geological Service, p. 65.

48 - National Resources Defense Council. (1996 December 24). Population and Consumption at NRDC: US Population Scorecard. Washington, D.C.: National Resources Defense Council.

49 - The Waste of Nations, p. xxiv.

50 - Stoner, Carol (Ed.). (1977). Goodbye to the Flush Toilet. Emmaus, PA: Rodale Press, Inc., p. vii.

51 - 1993 Information Please Environmental Almanac, p. 340-341.

52 - Environment Reporter. (1992 April 24) p. 2877-78.

53 - State of the World 1998, p. 100.

54 - Sides, S. (1991, August/September). "Compost." Mother Earth News, Issue 127, p. 50.

55 - Environment Reporter. (1992 February 28) p. 2439.

56 - Brown, Lester R., et al. (1998). Vital Signs 1998. New York: W. W. Norton and Co., p. 44-45.

57 - Vital Signs, p. 44.

58 - Vital Signs, p. 132.

59 - Vital Signs 1998, p. 132.

60 - US Environmental Protection Agency. PA IRIS Substance File: Nitrate, CASRN 14797-55-8. Washington, D.C.: US Environmental Protection Agency.

61 - 1992 Earth Journal, p. 159.

62 - US Environmental Protection Agency. (1990). National Survey of Pesticides in Drinking Water Wells. Washington, D.C.: US Environmental Protection Agency.

63 - State of the World 1999, p. 135.

64 - State of the World 1990, p. 184.

65 - Rybczynski, Witold, et al. (1982). Low Cost Technology Options for Sanitation - A State of the Art Review and Annotated Bibliography. Washington, D.C.: World Bank, p. 23.

66 - Cannon, Charles A. (1997 September 3-5). "Life Cycle Analysis and Sustainability Moving Beyond the Three R's -- Reduce, Reuse, and Recycle -- to P2R2 -- Preserve, Purify, Restore and Remediate." In E.I. Stentiford (Ed.), Proceedings of the 1997 Organic Recovery and Biological Treatment International Conference. Harrogate, UK, p. 252-253. Available from Stuart Brown, National Compost Development Association, PO Box 4, Grassington, North Yorkshire, BD23 5UR UK (stuartbrown@compuserve.com)

REFERENCES - CHAPTER THREE - MICROHUSBANDRY

1 - Shuval, Hillel I., et al. (1981). Appropriate Technology for Water Supply and Sanitation - Night Soil Composting. p.2. International Bank for Reconstruction and Development (World Bank), Washington DC, 20433, USA.

2 - Shuval, Hillel I. et al. (1981). Appropriate Technology for Water Supply and Sanitation - Night Soil Composting. p.2. International Bank for Reconstruction and Development (World Bank), Washington DC, 20433, USA.

3 - Shuval, Hillel I. et al. (1981). Appropriate Technology for Water Supply and Sanitation - Night Soil Composting. p.ii. International Bank for Reconstruction and Development (World Bank), Washington DC, 20433, USA.

4 - Rodale, J. I. (1960). The Complete Book of Composting. p. 9. Rodale Books, Inc., Emmaus, PA.

5 - Sides, S. (1991). Compost. *Mother Earth News*. Issue 127, Aug/Sept 1991 (pp.49-53).

6 - Bem, R., (1978). Everyone's Guide to Home Composting. Van Nostrand Reinhold Co., NY (p.4).

7 - Haug, Roger T. (1993). The Practical Handbook of Compost Engineering. p. 2. CRC Press, Inc., 2000 Corporate Blvd. N.W., Boca Raton, FL 33431 USA.

8 - Cannon, Charles A., (1997). *Life Cycle Analysis and Sustainability Moving Beyond the Three R's - Reduce, Reuse, and Recycle - to P2R2 - Preserve, Purify, Restore and Remediate*. As seen in the 1997 Organic Recovery and Biological Treatment Proceedings, Stentiford, E.I. (ed.). International Conference, Harrogate, United Kingdom. 3-5 September, 1997. P. 253. Available from Stuart Brown, National Compost Development Association, PO Box 4, Grassington, North Yorkshire, BD23 5UR UK (stuartbrown@compuserve.com).

9 - Howard, Sir Albert, (1943). An Agricultural Testament. Oxford University Press: New York.

10 - Bhamidimarri, R. (1988). Alternative Waste Treatment Systems. Elsevier Applied Science Publishers LTD., Crown House, Linton Road, Barking, Essex, IG11 8JU, England. (p.129).

11 - Rynk, Robert, ed. (1992). On-Farm Composting Handbook. Northeast Regional Agricultural Engineering Service. Ph: (607) 255-7654. p. 12.

- 12 - Haug, Roger T. (1993). The Practical Handbook of Compost Engineering. p. 2. CRC Press, Inc., 2000 Corporate Blvd. N.W., Boca Raton, FL 33431 USA.
- 13 - Palmisano, Anna C. and Barlaz, Morton A. (Eds.) (1996). Microbiology of Solid Waste. P. 129. CRC Press, Inc., 2000 Corporate Blvd., N.W., Boca Raton, FL 33431 USA.
- 14 - Howard, Sir Albert, (1943). An Agricultural Testament. (p.48).
- 15 - Ingham, Elaine (1998). *Anaerobic Bacteria and Compost Tea*. *Biocycle*, June 1998, p 86. The JG Press, Inc., 419 State Avenue, Emmaus, PA 18049.
- 16 - Stoner, C.H. (Ed.). (1977). Goodbye to the Flush Toilet. Rodale Press: Emmaus, PA, 1977. (p.46).
- 17 - Rodale, J.I. et al. (Eds.). (1960). The Complete Book of Composting. Rodale Books Inc.: Emmaus, Pa (pp.646-647).
- 18 - Gotaas, Harold B., (1956). Composting - Sanitary Disposal and Reclamation of Organic Wastes. p.39. World Health Organization, Monograph Series Number 31. Geneva.
- 19 - *Mixing Browns and Greens For Backyard Success*. *Biocycle*, Journal of Composting and Recycling, January 1998. p. 20 (Regional Roundup). JG Press, Inc., 419 State Ave., Emmaus, PA 18049 USA.
- 20 - Brock, Thomas D. (1986). Thermophiles - General, Molecular, and Applied Biology. p.4. John Wiley and Sons, Inc.
- 21 - Madigan, Michael T. et al. (1997). Brock Biology of Microorganisms, Eighth edition. Pp. 150, 167. Information about water heaters, as well as temperature ranges of bacteria.
- 22 - Waksman, S.A. (1952). Soil Microbiology. John Wiley and Sons, Inc., New York. (p.70).
- 23 - Rynk, Robert, ed. (1992). On-Farm Composting Handbook. Northeast Regional Agricultural Engineering Service. Ph: (607) 255-7654. p. 55.
- 24 - Thimann, K.V. (1955). The Life of Bacteria: Their Growth, Metabolism, and Relationships. The Macmillan Co., New York. (p.177).
- 25 - Wade, Nicholas (1996). *Universal Ancestor*. The New York Times, as seen in the Pittsburgh Post-Gazette, Monday, August 26, 1996, p. A-8.
- 26 - Brock, Thomas D. (1986). Thermophiles - General, Molecular, and Applied Biology. p.23. John Wiley and Sons, Inc.
- 27 - Bitton, Gabriel (1994). Wastewater Microbiology. p. 81. Wiley-Liss, Inc. 605 Third Avenue, New York, NY 10518-0012.
- 28 - Bitton, Gabriel (1994). Wastewater Microbiology. p. 212. Wiley-Liss, Inc. 605 Third Avenue, New York, NY 10518-0012.

- 29 - Palmisano, Anna C. and Barlaz, Morton A. (Eds.) (1996). Microbiology of Solid Waste. P. 123. CRC Press, Inc., 2000 Corporate Blvd., N.W., Boca Raton, FL 33431 USA.
- 30 - Lynch, J.M. and Poole, N.L. (Eds.). (1979). Microbial Ecology: A Conceptual Approach. Blackwell Scientific Publications, London. (p.238).
- 31 - Sterritt, Robert M. (1988). Microbiology for Environmental and Public Health Engineers. P. 53. E. & F. N. Spon Ltd., New York, NY 10001 USA.
- 32 - Palmisano, Anna C. and Barlaz, Morton A. (Eds.) (1996). Microbiology of Solid Waste. Pp. 124, 125, 129, 133. CRC Press, Inc., 2000 Corporate Blvd., N.W., Boca Raton, FL 33431 USA.
- 33 - Ingham, Elaine (1998). Replacing Methyl Bromide with Compost. *Biocycle*, Journal of Composting and Recycling, December 1998. p. 80. JG Press, Inc., 419 State Ave., Emmaus, PA 18049 USA.
- 34 - Curry, Dr. Robin (1977). Composting of Source Separated Domestic Organic Waste by Mechanically Turned Open Air Windrowing. As seen in the 1997 Organic Recovery and Biological Treatment Proceedings, Stentiford, E.I. (ed.). International Conference, Harrogate, United Kingdom. 3-5 September, 1997. P. 184.
- 35 - *Applied Microbiology*, December 1969.
- 36 - Gotaas, Harold B., (1956). Composting - Sanitary Disposal and Reclamation of Organic Wastes (p.20). World Health Organization, Monograph Series Number 31. Geneva.
- 37 - Curry, Dr. Robin (1977). Composting of Source Separated Domestic Organic Waste by Mechanically Turned Open Air Windrowing. As seen in the 1997 Organic Recovery and Biological Treatment Proceedings, Stentiford, E.I. (ed.). International Conference, Harrogate, United Kingdom. 3-5 September, 1997. P. 183.
- 38 - Palmisano, Anna C. and Barlaz, Morton A. (Eds.) (1996). Microbiology of Solid Waste. P. 169. CRC Press, Inc., 2000 Corporate Blvd., N.W., Boca Raton, FL 33431 USA.
- 39 - Palmisano, Anna C. and Barlaz, Morton A. (Eds.) (1996). Microbiology of Solid Waste. Pp. 121, 124, 134. CRC Press, Inc., 2000 Corporate Blvd., N.W., Boca Raton, FL 33431 USA.
- 40 - Rodale, J. I. (1960). The Complete Book of Composting. p. 702. Rodale Books, Inc., Emmaus, PA.
- 41 - Curry, Dr. Robin (1977). Composting of Source Separated Domestic Organic Waste by Mechanically Turned Open Air Windrowing. As seen in the 1997 Organic Recovery and Biological Treatment Proceedings, Stentiford, E.I. (ed.). International Conference, Harrogate, United Kingdom. 3-5 September, 1997. P. 183.
- 42 - Brock, Thomas D. (1986). Thermophiles - General, Molecular, and Applied Biology. p.244. John Wiley and Sons, Inc.
- 43 - Rynk, Robert, ed. (1992). On-Farm Composting Handbook. Northeast Regional Agricultural Engineering Service. Ph: (607) 255-7654. p. 13.

- 44 - *Biocycle*, November 1998, p.18.
- 45 - Rodale, J. I. (1960). The Complete Book of Composting. p. 932. Rodale Books, Inc., Emmaus, PA.
- 46 - Smalley, Curtis (1998). *Hard Earned Lessons on Odor Management*. *Biocycle, Journal of Composting and Recycling*, January 1998. p. 59. JG Press, Inc., 419 State Ave., Emmaus, PA 18049 USA.
- 47 - Brinton, William F. Jr. (date unknown). *Sustainability of Modern Composting - Intensification Versus Cost and Quality*. Woods End Institute, PO Box 297, Mt. Vernon, Maine 04352 USA.
- 48 - Brinton, William F. Jr. (date unknown). *Sustainability of Modern Composting - Intensification Versus Cost and Quality*. Woods End Institute, PO Box 297, Mt. Vernon, Maine 04352 USA.
- 49 - Palmisano, Anna C. and Barlaz, Morton A. (Eds.) (1996). Microbiology of Solid Waste. P. 170. CRC Press, Inc., 2000 Corporate Blvd., N.W., Boca Raton, FL 33431 USA.
- 50 - *Researchers Study Composting in the Cold*. *Biocycle, Journal of Composting and Recycling*, January 1998. p. 24 (Regional Roundup). JG Press, Inc., 419 State Ave., Emmaus, PA 18049 USA.
- 51 - Gotaas, Harold B., (1956). Composting - Sanitary Disposal and Reclamation of Organic Wastes. p.77. World Health Organization, Monograph Series Number 31. Geneva.
- 52 - Regan, Raymond W. (1998). *Approaching 50 years of Compost Research*. *Biocycle, Journal of Composting and Recycling*, October 1998. p. 82. JG Press, Inc., 419 State Ave., Emmaus, PA 18049 USA.
- 53 - Howard, Sir Albert (1943). An Agricultural Testament. Oxford University Press: New York. (p.44). Also see: Rodale, J.I. (1946). *Pay Dirt*. The Devon-Adair Co.: New York.
- 54 - Rodale, J.I. et al. (Eds.) (1960). The Complete Book of Composting. Rodale Books Inc.: Emmaus, PA (p.658).
- 55 - Regan, Raymond W. (1998). *Approaching 50 years of Compost Research*. *Biocycle, Journal of Composting and Recycling*, October 1998. p. 82. JG Press, Inc., 419 State Ave., Emmaus, PA 18049 USA.
- 56 - Poncavage, J. and Jesiolowski, J. (1991). *Mix Up a Compost and a Lime*. *Organic Gardening*. March 1991, Vol. 38, Issue 3. (p.18).
- 57 - Gotaas, Harold B., (1956). Composting - Sanitary Disposal and Reclamation of Organic Wastes. p.93. World Health Organization, Monograph Series Number 31. Geneva.
- 58 - Palmisano, Anna C. and Barlaz, Morton A. (Eds.) (1996). Microbiology of Solid Waste. P. 132. CRC Press, Inc., 2000 Corporate Blvd., N.W., Boca Raton, FL 33431 USA.
- 59 - US EPA (1998). An Analysis of Composting as an Environmental Remediation Technology. EPA530-B-98-001, March 1998.

- 60 - Haug, Roger T. (1993). The Practical Handbook of Compost Engineering. p. 9. CRC Press, Inc., 2000 Corporate Blvd. N.W., Boca Raton, FL 33431 USA.
- 61 - US EPA (October 1997). *Innovative Uses of Compost - Bioremediation and Pollution Prevention*. EPA530-F-97-042.
- 62 - US EPA (1998). An Analysis of Composting as an Environmental Remediation Technology. EPA530-B-98-001, March 1998.
- 63 - Cannon, Charles A., (1997). *Life Cycle Analysis and Sustainability Moving Beyond the Three R's - Reduce, Reuse, and Recycle - to P2R2 - Preserve, Purify, Restore and Remediate*. As seen in the 1997 Organic Recovery and Biological Treatment Proceedings, Stentiford, E.I. (ed.). International Conference, Harrogate, United Kingdom. 3-5 September, 1997. P. 253. Available from Stuart Brown, National Compost Development Association, PO Box 4, Grassington, North Yorkshire, BD23 5UR UK (stuartbrown@compuserve.com).
- 64 - US EPA (October 1997). *Innovative Uses of Compost - Bioremediation and Pollution Prevention*. EPA530-F-97-042.
- 65 - Logan, W.B. (1991). "Rot is Hot." *New York Times Magazine*. 9/8/91, Vol. 140, Issue 4871. (p.46).
- 66 - *Compost Fungi Used to Recover Wastepaper*. Biocycle, Journal of Composting and Recycling, May 1998. p. 6 (Biocycle World). JG Press, Inc., 419 State Ave., Emmaus, PA 18049 USA.
- 67 - Young, Lily Y., and Cerniglia, Carl E. (Eds.) (1995). Microbial Transformation and Degradation of Toxic Organic Chemicals. Pp. 408, 461, and Table 12.5. Wiley-Liss, Inc. 605 Third Avenue, New York, NY 10518-0012.
- 68 - Palmisano, Anna C. and Barlaz, Morton A. (Eds.) (1996). Microbiology of Solid Waste. P. 127. CRC Press, Inc., 2000 Corporate Blvd., N.W., Boca Raton, FL 33431 USA.
- 69 - Logan, W.B. (1991). "Rot is Hot." *New York Times Magazine*. 9/8/91, Vol. 140, Issue 4871. (p.46).
- 70 - Lubke, Sigfried. (1989). Interview: All Things Considered in the Wake of the Chernobyl Nuclear Accident. *Aeres U.S.A.* December 1989. (p. 20) [also contact Uta and Sigfried Lubke, A4722 Peuerbach, Untererleinsbach 1, Austria]
- 71 - US EPA (1998). An Analysis of Composting as an Environmental Remediation Technology. EPA530-B-98-001, March 1998.
- 72 - Cannon, Charles A., (1997). *Life Cycle Analysis and Sustainability Moving Beyond the Three R's - Reduce, Reuse, and Recycle - to P2R2 - Preserve, Purify, Restore and Remediate*. As seen in the 1997 Organic Recovery and Biological Treatment Proceedings, Stentiford, E.I. (ed.). International Conference, Harrogate, United Kingdom. 3-5 September, 1997. P. 254. Available from Stuart Brown, National Compost Development Association, PO Box 4, Grassington, North Yorkshire, BD23 5UR UK (stuartbrown@compuserve.com).and Schonberner, Doug (1998). *Reclaiming Contaminated Soils*, as well as Block, Dave (1998). *Composting Breaks Down Explosives*. Biocycle, Journal of Composting and Recycling, September 1998, 36-40.
- 73 - US EPA (1998). An Analysis of Composting as an Environmental Remediation Technology. EPA530-B-98-001, March 1998.

- 74 - Block, Dave (1998). *Degrading PCB's Through Composting*. Biocycle, Journal of Composting and Recycling, December 1998. p. 45-48. JG Press, Inc., 419 State Ave., Emmaus, PA 18049 USA.
- 75 - US EPA (October 1997). *Innovative Uses of Compost - Bioremediation and Pollution Prevention*. EPA530-F-97-042.
- 76 - US EPA (October 1997). *Innovative Uses of Compost - Bioremediation and Pollution Prevention*. EPA530-F-97-042.
- 77 - Rynk, Robert, ed. (1992). On-Farm Composting Handbook. Northeast Regional Agricultural Engineering Service. Ph: (607) 255-7654. p. 83.
- 78 - Hoitink, Harry A. J. et al., (1997). Suppression of Root and Foliar Diseases Induced by Composts. As seen in the 1997 Organic Recovery and Biological Treatment Proceedings, Stentiford, E.I. (ed.). International Conference, Harrogate, United Kingdom. 3-5 September, 1997. p. 95.
- 79 - US EPA (October 1997). *Innovative Uses of Compost - Disease Control for Plants and Animals*. EPA530-F-97-044.
- 80 - US EPA (1998). An Analysis of Composting as an Environmental Remediation Technology. EPA530-B-98-001, March 1998.
- 81 - Logan, W.B. (1991). "Rot is Hot". *New York Times Magazine*. 9/8/91, Vol. 140, Issue 4871. (p.46).
- 82 - US EPA (1998). An Analysis of Composting as an Environmental Remediation Technology. EPA530-B-98-001, March 1998.
- 83 - Trankner, Andreas, and Brinton, William (date unknown). *Compost Practices for Control of Grape Powdery Mildew (Uncinula necator)*. Woods End Institute, PO Box 297, Mt. Vernon, Maine 04352 USA.
- 84 - Quote from Elaine Ingham as reported in: Grobe, Karin (1998). *Fine-Tuning the Soil Web*. Biocycle, Journal of Composting and Recycling, January 1998. p. 46. JG Press, Inc., 419 State Ave., Emmaus, PA 18049 USA.
- 85 - Sides, S. (1991). Compost. *Mother Earth News*. Issue 127, Aug/Sept 1991 (p.50).
- 86 - US EPA (October 1997). *Innovative Uses of Compost - Disease Control for Plants and Animals*. EPA530-F-97-044.
- 87 - Biocycle, Journal of Composting and Recycling, October 1998. p. 26. JG Press, Inc., 419 State Ave., Emmaus, PA 18049 USA.
- 88 - US EPA (October 1997). *Innovative Uses of Compost - Disease Control for Plants and Animals*. EPA530-F-97-044.
- 89 - Brodie, Herbert L., and Carr, Lewis E. (1997). Composting Animal Mortality. As seen in the 1997 Organic Recovery and Biological Treatment Proceedings, Stentiford, E.I. (ed.). International Conference, Harrogate, United Kingdom. 3-5 September, 1997. Pp. 155-159.
- 90 - McKay, Bart (1998). *Com-Postal-Ing in Texas*. Biocycle, Journal of Composting and Recycling, May 1998. p. 44-46. JG Press, Inc., 419 State Ave., Emmaus, PA 18049 USA.

- 91 - *Garbage: the Practical Journal for the Environment*. May/June 1992, p.66, Old House Journal Corp., 2 Main St., Gloucester, MA 01930.
- 92 - Logan, W.B. (1991). "Rot is Hot." *New York Times Magazine*. 9/8/91, Vol. 140, Issue 4871.
- 93 - Biocycle, Journal of Composting and Recycling, November 1998. p. 18. JG Press, Inc., 419 State Ave., Emmaus, PA 18049 USA.

REFERENCES - CHAPTER FOUR - DEEP SH*T

- 1 - Bulletin of the Atomic Scientists. September/October 1998.
- 2 - Wilson, N.W., (1966). Three Ways of Asian Wisdom. Simon and Shuster: New York. (p.11-12).
- 3 - Ibid. (p.77-78).
- 4 - Ibid. (p.137).
- 5 - Ibid. (p.145).
- 6 - Ibid. (p.140).
- 7 - Lao Tsu. Tao Te Ching. Vintage Books Edition, 1972. Vintage Books (Random House): New York. (#57).
- 8 - Holy Bible. King James Version. The World Publishing Co.: New York. (p.9).
- 9 - Rodale, J. I., (1946). Paydirt, Devon-Adair Co.: NY, (p.vi).
- 10 - *Beyond Oil: The Threat to Food and Fuel in the Coming Decades, A summary Report*. November 1986. Carrying Capacity Inc., 1325 G. Street, NW, Suite 1003, Wash. D.C. 10005.
- 11 - King, F.H., (1911). Farmers of Forty Centuries. Rodale Press: Emmaus, PA 18049.
- 12 - Ibid. (p.193, 196-7).
- 13 - Ibid. (p.10).
- 14 - Ibid. (p.19).
- 15 - Ibid. (p.199).
- 16 - White, A.D. (1955). The Warfare of Science with Theology. George Braziller: New York. (pp.68,70).

17 - Ibid. (p.69).

18 - Ibid. (p.71).

19 - Ibid. (p.73).

20 - Ibid. (pp.76-77).

21 - Ibid. (p.84).

22 - Ibid. (p.85).

23 - Reyburn, Wallace (1989). Flushed with Pride - The Story of Thomas Crapper. Pavilion Books Limited, 196 Shaftesbury Avenue, London WC2H 8JL. pp. 24-25.

24 - Seaman, L.C.B. (1973). Victorian England. Methuan & Co.: London. (pp. 48-56).

25 - Shuval, Hillel I. et al. (1981). Appropriate Technology for Water Supply and Sanitation - Night Soil Composting. Abstract. World Bank, Washington DC 20433, USA.

26 - Winblad, Uno, and Kilama, Wen (1985). Sanitation Without Water. Macmillan Education Ltd., London and Basingstoke. p. 12.

27 - Edmonds, Richard Louis (1994). Patterns of China's Lost Harmony - A Survey of the Country's Environmental Degradation and Protection. p. 9, 132, 137, 142, 146, 156. Routledge, 11 New Fetter Lane, London EC4P 4EE and 29 West 35th Street, New York, NY 10001.

28 - Hoitink, Harry A. J. et al., (1997). *Suppression of Root and Foliar Diseases Induced by Composts*. As seen in the 1997 Organic Recovery and Biological Treatment Proceedings, Stentiford, E.I. (ed.). International Conference, Harrogate, United Kingdom. 3-5 September, 1997. p. 97.

29 - Farmers of Forty Centuries. (p.198).

REFERENCES - CHAPTER FIVE - A DAY IN THE LIFE OF A TURD

1 - Mancini, K. *Septic Tank - Soil Absorption Systems*. Agricultural Engineering Fact Sheet SW-44. Penn State College of Agriculture Cooperative Extension, University Park, PA 16802.

2 - Mancini, K. *Mound Systems for Wastewater Treatment*. SW-43. Same as above.

3 - Stewart, John G. (1990). Drinking Water Hazards: How to Know if There Are Toxic Chemicals in Your Water and What to Do If There Are. Envirographics: Hiram, Ohio. (pp.177-178).

- 4 - van der Leeden, F. et al. (1990). The Water Encyclopedia. Lewis Publishers Inc.: Chelsea, Michigan, 48118. (p.526).
- 5 - Ibid. (p.525).
- 6 - Stewart, John G. (as in #3 above, same pages).
- 7 - Ibid.
- 8 - Environment Reporter. 2/28/92. The Bureau of National Affairs, Inc., Washington D.C., (pp. 2441-2).
- 9 - Gray, N.F. (1990). Activated Sludge Theory and Practice. Oxford University Press: New York. (p.125).
- 10 - *Journal of Environmental Health*. July/August 1989. "EPA Proposes New Rules for Sewage Sludge Disposal". (P.321).
- 11 - Logan, W.B. (1991). "Rot is Hot." *New York Times Magazine*. 9/8/91 Vol. 140, Issue 4871, p.46.
- 12 - van der Leeden, F. et al. (1990). The Water Encyclopedia Second Edition. Lewis Publishers, 121 South Main Street, Chelsea, Michigan 48118 (p. 541).
- 13 - *Garbage*. February/March 1993. Old House Journal Corp., 2 Main St., Gloucester, MA 01930. (p.18).
- 14 - Pickford, John (1995). Low-Cost Sanitation - A Survey of Practical Experience. p. 96. IT Publications, 103-105 Southampton Row, London WC1B 4HH, UK.
- 15 - US EPA (1996). Wastewater Treatment: Alternatives to Septic Systems (Guidance Document). EPA/909-K-96-001. US Environmental Protection Agency, Region 9, Drinking Water Program (W-6-3). p. 16-19. and:US EPA (1987). It's Your Choice - A Guidebook for Local Officials on Small Community Wastewater Management Options. EPA 430/9-87-006. United States Environmental Protection Agency, Office of Municipal Pollution Control (WH-595), Municipal Facilities Division, Washington DC 20460. p.55.
- 16 - Manahan, S.E. (1990). Hazardous Waste Chemistry, Toxicology and Treatment. Lewis Publishers, Inc.: Chelsea, Michigan. (p.131).
- 17 - Bitton, Gabriel (1994). Wastewater Microbiology. p. 120. Wiley-Liss, Inc. 605 Third Avenue, New York, NY 10518-0012.
- 18 - Ibid. (pp. 148-49).
- 19 - Baumann, Marty. *USA Today*. Feb 2, 1994, p. 1A, 4A. USA Today (Gannet Co. Inc.) 1000 Wilson Blvd., Arlington, VA 22229.
- 20 - "The Perils of Chlorine." *Audubon Magazine*, 93:30-2. Nov/Dec 1991.

- 21 - Liptak, B.G. (1991). Municipal Waste Disposal in the 1990's. Chilton Book Co.: Radnor, PA. (pp.196-8).
- 22 - Bitton, Gabriel (1994). Wastewater Microbiology. p. 312. Wiley-Liss, Inc. 605 Third Avenue, New York, NY 10518-0012.
- 23 - Stiak, J. "The Trouble With Chlorine." *Buzzworm*. Nov/Dec 1992. (p.22).
- 24 - Bitton, Gabriel (1994). Wastewater Microbiology. p. 121. Wiley-Liss, Inc. 605 Third Avenue, New York, NY 10518-0012.
- 25 - Environment Reporter. 7/10/92. (p.767).
- 26 - Bitton, Gabriel (1994). Wastewater Microbiology. p. 121. Wiley-Liss, Inc. 605 Third Avenue, New York, NY 10518-0012.
- 27 - *Buzzworm*. March/April 1993. (p.17).
- 28 - *Environment Reporter*. 7/10/92. (p.767).
- 29 - Ibid. 4/24/92. (p.2879).
- 30 - Ibid. 8/7/92. (p.1155).
- 31 - Burke, W.K. "A Prophet of Eden." *Buzzworm*. Vol. IV, Number 2, March/April 1992. (pp.18-19).
- 32 - Environment Reporter. 8/7/92. (P.1152).
- 33 - Ibid. 5/15/92. (p.319).
- 34 - Bitton, Gabriel (1994). Wastewater Microbiology. p. 352. Wiley-Liss, Inc. 605 Third Avenue, New York, NY 10518-0012.
- 35 - Ibid. 3/6/92 (p. 2474) and 1/17/92 (p.2145).
- 36 - Ibid. 1/3/92 (p.2109).
- 37 - Ibid. 11/1/91 (p.1657) and 9/27/96 (p. 1212).
- 38 - Hammond, A. et al. (Eds.) (1993). The 1993 Information Please Environmental Almanac. Compiled by the World Resources Institute. Houghton Mifflin Co.: New York. (p.41).
- 39 - Purves, D. (1990). "Toxic Sludge." *Nature*. Vol. 346, 8/16/1990 (pp. 617-18).
- 40 - Bitton, Gabriel (1994). Wastewater Microbiology. p. 352. Wiley-Liss, Inc. 605 Third Avenue, New York, NY 10518-

0012.

41 - Rybczynski, W. et al. (1982). Appropriate Technology for Water Supply and Sanitation - Low Cost Technology Options for Sanitation, A State of the Art Review and Annotated Bibliography. World Bank. (p. 124).

42 - Ibid. (p. 125).

43 - Sterritt, Robert M. (1988). Microbiology for Environmental and Public Health Engineers. P. 160. E. & F. N. Spon Ltd., New York, NY 10001 USA.

44 - Fahm, L.A. (1980). The Waste of Nations. Allanheld, Osmun & Co.: Montclair, NJ (p.61).

45 - Shuval, Hillel I. et al. (1981). Appropriate Technology for Water Supply and Sanitation - Night Soil Composting. p.5. International Bank for Reconstruction and Development (World Bank), Washington DC, 20433, USA

46 - Bitton, Gabriel (1994). Wastewater Microbiology. p. 166, 352. Wiley-Liss, Inc. 605 Third Avenue, New York, NY 10518-0012.

47 - Sterritt, Robert M. (1988). Microbiology for Environmental and Public Health Engineers. P. 242, 251-2. E. & F. N. Spon Ltd., New York, NY 10001 USA.

48 - Radtke, T.M., and Gist, G.L. (1989). "Wastewater Sludge Disposal: Antibiotic Resistant Bacteria May Pose Health Hazard." *Journal of Environmental Health*. Vol 52, No.2, Sept/Oct 1989. (pp.102-5).

49 - *Environment Reporter*. 7/10/92. (p.770).

50 - *Environment Reporter*. 11/1/91. (p.1653).

51 - Ibid. 1/17/92. (p.2154).

52 - Damsker, M. (1992). "Sludge Beats Lead." *Organic Gardening*. Feb, 1992, Vol. 39, Issue 2, p.19.

53 - Contact JCH Environmental Engineering, Inc., 2730 Remington Court, Missoula, MT 59801-7121. Phone (406) 721-1164.

54 - Miller, T. L. et al., (1992). *Selected Metal and Pesticide Content of Raw and Mature Compost Samples from Eleven Illinois Facilities*. Illinois Department of Energy and Natural Resources. and: Manios, T. and Stentiford, E.I. (1998). Heavy Metals Fractionation Before, During, and After Composting of Urban Organic Residues. As seen in the 1997 Organic Recovery and Biological Treatment Proceedings, Stentiford, E.I. (ed.). International Conference, Harrogate, United Kingdom. 3-5 September, 1997. p. 227-232.

55 - US EPA, (1989) - Summary Report: In-Vessel Composting of Municipal Wastewater Sludge. pp. 20, 161. EPA/625/8-89/016. Center for Environmental Research Information, Cincinnati, OH.

56 - Fahm. (1980). The Waste of Nations. (p.xxiv).

57 - Ibid. (p.40).

58 - Shuval, Hillel I. et al. (1981). Appropriate Technology for Water Supply and Sanitation - Night Soil Composting. (summary). International Bank for Reconstruction and Development (World Bank), Washington DC, 20433, USA.

59 - Rivard, C.J. et al. (1989). "Waste to Energy." *Journal of Environmental Health*. Vol 52, No.2, Sept/Oct 1989. (p.100).

60 - See *Garbage*, Oct/Nov 1992, (p.14).

REFERENCES - CHAPTER SIX - COMPOSTING TOILETS & SYSTEMS

1 - Rybczynski, W. et al. (1982). Appropriate Technology for Water Supply and Sanitation - Low Cost Technology Options for Sanitation, A State of the Art Review and Annotated Bibliography. World Bank. Transportation and Water Department, 1818 H Street N.W., Washington D.C. 20433 USA.

2 - Franceys et al. (1992). A Guide to the Development of On-Site Sanitation. World Health Organization, Geneva. (p. 213).

3 - McGarry, Michael G., and Stainforth, Jill (eds.) (1978). Compost, Fertilizer, and Biogas Production from Human and Farm Wastes in the People's Republic of China. International Development Research Center, Box 8500, Ottawa, Canada, K1G 3H9 (pages 9, 10, 29, 32).

4 - Rybczynski, W. et al. (1982). Appropriate Technology for Water Supply and Sanitation - Low Cost Technology Options for Sanitation, A State of the Art Review and Annotated Bibliography. World Bank. Transportation and Water Department, 1818 H Street N.W., Washington D.C. 20433 USA. (p. 114).

5 - McGarry, Michael G., and Stainforth, Jill (eds.) (1978). Compost, Fertilizer, and Biogas Production from Human and Farm Wastes in the People's Republic of China. International Development Research Center, Box 8500, Ottawa, Canada, K1G 3H9.

6 - Winblad, Uno, and Kilama, Wen (1985). Sanitation Without Water. Macmillan Education Ltd., London and Basingstoke. pp. 20-21.

7 - Winblad, Uno (Ed.) (1998). Ecological Sanitation. Swedish International Development Cooperation Agency, Stockholm, Sweden. p. 25.

8 - Rybczynski, W. et al. (1982). Appropriate Technology for Water Supply and Sanitation - Low Cost Technology Options for Sanitation, A State of the Art Review and Annotated Bibliography. World Bank. Transportation and Water Department, 1818 H Street N.W., Washington D.C. 20433 USA.

9 - Ibid.

10 - Clivus Multrum Maintenance Manual, Clivus Multrum, Inc., 21 Canal St., Lawrence, Mass. 01840. (Also contact

Hanson Assoc., Lewis Mill, Jefferson, MD 21755).

11 - Ibid.

12 - Ibid.

13 - Source: Pickford, John (1995). Low-Cost Sanitation, Intermediate Technology Publications, 103-105 Southampton Row, London WC1B 4HH, UK. p. 68.

14 - Sun Mar Corp., 900 Hertel Ave., Buffalo, NY 14216 USA; or 5035 North Service Road, Burlington, Ontario, Canada L7L 5V2.

15 - AlasCan, Inc., 3400 International Way, Fairbanks, Alaska 99701, phone/fax (907) 452-5257 [as seen in *Garbage*, Feb/Mar 1993, p.35].

16 - Composting Toilet Systems, PO Box 1928 (or 1211 Bergen Rd.), Newport, WA 99156, phone: (509) 447-3708; Fax: (509) 447-3753.

REFERENCES - CHAPTER SEVEN - WORMS AND DISEASE

1 - Kristof, Nicholas D. (1995). *Japanese is Too Polite for Words*. Pittsburgh Post Gazette, Sunday, September 24, 1995. P. B-8.

2 - Beeby, John (1995). The Tao of Pooh (now titled Future Fertility). Disclaimer, and pp. 64-65. Ecology Action of the Midpeninsula, 5798 Ridgewood Road, Willits, CA 95490-9730.

3 - Beeby, John (1995). The Tao of Pooh (now titled Future Fertility). Pp. 11-12. Ecology Action of the Midpeninsula, 5798 Ridgewood Road, Willits, CA 95490-9730.

4 - Barlow, Ronald S. (1992). The Vanishing American Outhouse. P. 2. Windmill Publishing Co., 2147 Windmill View Road, El Cajon, California 92020 USA.

5 - Warren, George M. (1922 - revised 1928). Sewage and Sewerage of Farm Homes. US Department of Agriculture, Farmer's Bulletin No. 1227. As seen in: Barlow, Ronald S. (1992). The Vanishing American Outhouse. Pp. 107-110. Windmill Publishing Co., 2147 Windmill View Road, El Cajon, California 92020 USA.

6 - Shuval, Hillel I. et al. (1981). Appropriate Technology for Water Supply and Sanitation - Night Soil Composting. p.8. International Bank for Reconstruction and Development (World Bank), Washington DC, 20433, USA.

7 - Tompkins, P., and Boyd, C. (1989). Secrets of the Soil. Harper and Row: New York. (pp.94-5).

8 - Howard, Sir Albert. The Soil and Health: A Study of Organic Agriculture. Schocken: New York. 1947. (pp. 37-38).

9 - Ibid. (p.177).

- 10 - Feachem, et al. (1980). Appropriate Technology for Water Supply and Sanitation. The World Bank, Director of Information and Public Affairs, Washington D.C. 20433.
- 11 - Sterritt, Robert M. (1988). Microbiology for Environmental and Public Health Engineers. P. 238. E. & F. N. Spon Ltd., New York, NY 10001 USA.
- 12 - Jervis, N. "Waste Not, Want Not". *Natural History*. May, 1990 (p.73).
- 13 - Winblad, Uno (Ed.) (1998). Ecological Sanitation. Swedish International Development Cooperation Agency, Stockholm, Sweden. p. 75.
- 14 - Sterritt, Robert M. (1988). Microbiology for Environmental and Public Health Engineers. Pp. 59-60. E. & F. N. Spon Ltd., New York, NY 10001 USA.
- 15 - Palmisano, Anna C. and Barlaz, Morton A. (Eds.) (1996). Microbiology of Solid Waste. Pp. 159. CRC Press, Inc., 2000 Corporate Blvd., N.W., Boca Raton, FL 33431 USA.
- 16 - Gotaas, Harold B., (1956). Composting - Sanitary Disposal and Reclamation of Organic Wastes. p.20. World Health Organization, Monograph Series Number 31. Geneva.
- 17 - Sopper, W.E. and Kardos, L.T. (Eds.). (1973). Recycling Treated Municipal Wastewater and Sludge Through Forest and Cropland. The Pennsylvania State University, University Park, PA (pp. 248-51).
- 18 - Ibid. (pp. 251-252).
- 19 - Shuval, Hillel I. et al. (1981). Appropriate Technology for Water Supply and Sanitation - Night Soil Composting. p.4. International Bank for Reconstruction and Development (World Bank), Washington DC, 20433, USA.
- 20 - Sterritt, Robert M. (1988). Microbiology for Environmental and Public Health Engineers. P. 252. E. & F. N. Spon Ltd., New York, NY 10001 USA.
- 21 - Cheng, Thomas C. (1973). General Parasitology. Academic Press, Inc., 111 Fifth Avenue, New York, NY 10003 (p. 645).
- 22 - Shuval, Hillel I. et al. (1981). Appropriate Technology for Water Supply and Sanitation - Night Soil Composting. p.6. International Bank for Reconstruction and Development (World Bank), Washington DC, 20433, USA.
- 23 - Feachem et al. (1980). Appropriate Technology for Water Supply and Sanitation: Health Aspects of Excreta and Sullage Management. Energy, Water and Telecommunications Department of the World Bank, 1818 H Street N.W., Washington D.C. 20433. This comprehensive work cites 394 references from throughout the world, and was carried out as part of the World Bank's research project on appropriate technology for water supply and sanitation.
- 24 - Ibid.

- 25 - Olson, O. W. (1974). Animal Parasites - Their Life Cycles and Ecology. University Park Press, Baltimore, MD (p. 451-452).
- 26 - Crook, James (1985). "Water Reuse in California." *Journal of the American Waterworks Association*. v77, no. 7. as seen in The Water Encyclopedia by van der Leeden et al. (1990), Lewis Publishers, Chelsea, Mich. 48118.
- 27 - Boyd, R. F. and Hoerl, B. G. (1977). Basic Medical Microbiology. Little, Brown and Co., Boston Mass. (p. 494).
- 28 - Cheng, Thomas C. (1973) General Parasitology. Academic Press Inc., 111 Fifth Ave., New York, NY 10003. (p. 645).
- 29 - Sterritt, Robert M. (1988). Microbiology for Environmental and Public Health Engineers. Pp. 244-245. E. & F. N. Spon Ltd., New York, NY 10001 USA.
- 30 - Epstein, Elliot (1998). "Pathogenic Health Aspects of Land Application." *Biocycle*, September 1998, p.64. The JG Press, Inc., 419 State Avenue, Emmaus, PA 18049.
- 31 - Shuval, Hillel I. et al. (1981). Appropriate Technology for Water Supply and Sanitation - Night Soil Composting. p.5. International Bank for Reconstruction and Development (World Bank), Washington DC, 20433, USA.
- 32 - Franceys, R. et al. (1992). A Guide to the Development of On-Site Sanitation. World Health Organization, Geneva. p. 212.
- 33 - Schoenfeld, M., and Bennett, M. (1992). Water Quality Analysis of Wolf Creek. (Unpublished manuscript). Slippery Rock University, Applied Ecology Course, PREE, Fall Semester. (Prof. P. Johnson), Slippery Rock, PA 16057
- 34 - Pomeranz, V.E. and Schultz, D., (1972). The Mother's and Father's Medical Encyclopedia. The New American Library, Inc., 1633 Broadway, New York, NY 10019. (p.627).
- 35- Chandler, A.C. and Read, C.P. (1961). Introduction to Parasitology. John Wiley and Sons, Inc.: New York.
- 36 - Brown, H.W. and Neva, F.A. (1983). Basic Clinical Parasitology. Appleton-Century-Crofts/Norwalk, Connecticut 06855. (pp.128-31). Pinworm destruction by composting mentioned in: Gotaas, Harold B., (1956). Composting - Sanitary Disposal and Reclamation of Organic Wastes . p.20. World Health Organization, Monograph Series Number 31. Geneva.
- 37 - Brown, H.W. and Neva, F.A. (1983). Basic Clinical Parasitology. Appleton-Century-Crofts/Norwalk, Connecticut 06855. (pp.119-126).
- 38 - Ibid.
- 39 - Ibid.
- 40 - Haug, Roger T. (1993). The Practical Handbook of Compost Engineering. p. 141. CRC Press, Inc., 2000 Corporate Blvd. N.W., Boca Raton, FL 33431 USA.
- 41 - Shuval, Hillel I. et al. (1981). Appropriate Technology for Water Supply and Sanitation - Night Soil Composting. p.4.

International Bank for Reconstruction and Development (World Bank), Washington DC, 20433, USA.

42 - Franceys, R. et al. (1992). A Guide to the Development of On-Site Sanitation. World Health Organization, Geneva. p. 214.

43 - Shuval, Hillel I. et al. (1981). Appropriate Technology for Water Supply and Sanitation - Night Soil Composting. p.7. International Bank for Reconstruction and Development (World Bank), Washington DC, 20433, USA.

REFERENCES - CHAPTER EIGHT - THE TAO OF COMPOST

1 - LaMotte Chemical Products Co., Chestertown, MD 21620

2 - Rodale, J. I., (1960). The Complete Book of Composting. P. 650, Rodale Books, Emmaus, PA.

3 - Kitto, Dick. (1988). Composting: The Organic Natural Way. Thorsons Publishers Ltd.: Wellingborough, England. (p. 103).

4 - World of Composting Toilets Forum Update No. 3, Monday, November 2, 1998. Reply to: earthwise@earthwise.nwnet.co.uk.

5 - Del Porto, David, and Steinfeld, Carol (1999). The Composting Toilet System Book - editor's draft. Center for Ecological Pollution Prevention, PO Box 1330, Concord, MA 01742-1330.

6 - Olexa, M. T. and Trudeau, Rebecca L., (1994). *How is the Use of Compost Regulated?* University of Florida, Florida Cooperative Extension Service, Document No. SS-FRE-19, September 1994.

7 - Pennsylvania Solid Waste Management Act, Title 35, Chapter 29A.

8 - Pennsylvania Municipal Waste Planning, Recycling and Waste Reduction Act (1988), Title 53, Chapter 17A.

9 - King, F.H. (1911). Farmers of Forty Centuries. Rodale Press, Inc., Emmaus, PA 18049. (pp.78, 202).

REFERENCES - CHAPTER NINE - ALTERNATIVE GREY WATER SYSTEMS

1 - Waterless Toilets as Repair for Failed Septic Tank Systems. Bio-Sun Systems, Inc., RR #2, Box 134A, Millerton, PA 16936. Ph: 717-537-2200. Email: Bio-sun@ix.netcom.com

2 - US EPA (1992). Wastewater Treatment/Disposal for Small Communities. P. 42. EPA/625/R-92/005. US EPA Office of Research and Development, Office of Water, Washington DC 20460 USA.

3 - Bennett, Dick (1995). *Graywater, An Option for Household Water Reuse*. Home Energy Magazine, July/August, 1995.

- 4 - Gerba, Charles P. et al. (1995). *Water Quality Study of Graywater Treatment Systems*. Water Resources Bulletin, February, 1995, Vol. 31, No. 1, p. 109. American Water Resources Association.
- 5 - Rose, Joan B. et al. (1991). *Microbial Quality and Persistence of Enteric Pathogens in Graywater from Various Household Sources*. Water Resources, Vol. 25, No. 1, pp. 37-42, 1991.
- 6 - Karpiscak, Martin M. et al. (1990). *Residential Water Conservation: Casa del Agua*. Water Resources Bulletin, December 1990, p. 945-946. American Water Resources Association.
- 7 - Gerba, Charles P. et al. (1995). *Water Quality Study of Graywater Treatment Systems*. Water Resources Bulletin, February, 1995, Vol. 31, No. 1, p. 109. American Water Resources Association.
- 8 - Karpiscak, Martin M. et al. (1990). *Residential Water Conservation: Casa del Agua*. Water Resources Bulletin, December 1990, p. 940. American Water Resources Association.
- 9 - Rose, Joan B. et al. (1991). *Microbial Quality and Persistence of Enteric Pathogens in Graywater from Various Household Sources*. Water Resources, Vol. 25, No. 1, p. 40, 1991.
- 10 - Karpiscak, Martin M. et al. (1990). *Residential Water Conservation: Casa del Agua*. Water Resources Bulletin, December 1990, p. 940. American Water Resources Association.
- 11 - Ludwig, Art (1994). Create an Oasis with Greywater. Oasis Design, 5 San Marcos Trout Club, Santa Barbara, CA 93105-9726. Phone: 805-967-9956.
- 12 - Bennett, Dick (1995). *Graywater, An Option for Household Water Reuse*. *Home Energy Magazine*, July/August, 1995.
- 13 - Rose, Joan B. et al. (1991). *Microbial Quality and Persistence of Enteric Pathogens in Graywater from Various Household Sources*. Water Resources, Vol. 25, No. 1, p. 40, 1991.
- 14 - Rose, Joan B. et al. (1991). *Microbial Quality and Persistence of Enteric Pathogens in Graywater from Various Household Sources*. Water Resources, Vol. 25, No. 1, pp. 37-38, 1991.
- 15 - Rose, Joan B. et al. (1991). *Microbial Quality and Persistence of Enteric Pathogens in Graywater from Various Household Sources*. Water Resources, Vol. 25, No. 1, pp. 39, 41, 1991.
- 16 - Bastian, Robert K. (date unknown). Needs and Problems in Sewage Treatment and Effluent Disposal Facing Small Communities; The Role of Wetland Treatment Alternatives. US EPA, Office of Municipal Pollution Control, Washington DC 20460.
- 17 - Hoang, Tawni et al. (1998). Greenhouse Wastewater Treatment with Constructed Wetlands. *Greenhouse Product News*, August 1998, p.33.
- 18 - Golueke, Clarence G. (1977). *Using Plants for Wastewater Treatment*. *Compost Science*, September/October 1977, p. 18.

- 19 - Berghage, R.D. et al. (date unknown). *"Green" Water Treatment for the Green Industries: Opportunities for Biofiltration of Greenhouse and Nursery Irrigation Water and Runoff with Constructed Wetlands.* and: Gupta, G.C. (1980). *Use of Water Hyacinths in Wastewater Treatment.* Journal of Environmental Health. 43(2):80-82. and: Joseph, J. (1978). *Hyacinths for Wastewater Treatment.* Reeves Journal. 56(2):34-36.
- 20 - Hillman, W.S. and Culley, D.D. Jr. (1978). *The Uses of Duckweed.* American Scientist, 66:442-451
- 21 - Pries, John (date unknown, but 1996 or later). *Constructed Treatment Wetland Systems in Canada.* Gore and Storrie Ltd., Suite 600, 180 King St. S., Waterloo, Ontario, N2J 1P8. Ph: 519-579-3500.
- 22 - Golueke, Clarence G. (1977). *Using Plants for Wastewater Treatment.* Compost Science, September/October 1977, p. 18.
- 23 - Golueke, Clarence G. (1977). *Using Plants for Wastewater Treatment.* Compost Science, September/October 1977, p. 17.
- 24 - For more information, contact Carl Lindstrom at: www.greywater.com

REFERENCES - CHAPTER TEN - THE END IS NEAR

- 1 - Rybczynski, W. et. al. (1982). Appropriate Technology for Water Supply and Sanitation - Low Cost Technology Options for Sanitation, A State of the Art Review and Annotated Bibliography. World Bank, Geneva. (p. 20).
- 2 - Kugler, R. et al. (1998). *Technological Quality Guarantees for H.Q. Compost from Bio-Waste.* As seen in the 1997 Organic Recovery and Biological Treatment Proceedings, Stentiford, E.I. (ed.). International Conference, Harrogate, United Kingdom. 3-5 September, 1997. P. 31. Available from Stuart Brown, National Compost Development Association, PO Box 4, Grassington, North Yorkshire, BD23 5UR UK (stuartbrown@compuserve.com).
- 3 - Vorkamp, Katrin et al. (1998). *Multiresidue Analysis of Pesticides and their Metabolites in Biological Waste.* As seen in the 1997 Organic Recovery and Biological Treatment Proceedings, Stentiford, E.I. (ed.). International Conference, Harrogate, United Kingdom. 3-5 September, 1997. p. 221. Available from Stuart Brown, National Compost Development Association, PO Box 4, Grassington, North Yorkshire, BD23 5UR UK (stuartbrown@compuserve.com).
- 4 - Wheeler, Pat (1998). *Results of the Environment Agency Research Programme into Composting of Green and Household Wastes.* As seen in the 1997 Organic Recovery and Biological Treatment Proceedings, Stentiford, E.I. (ed.). International Conference, Harrogate, United Kingdom. 3-5 September, 1997. p. 77. Available from Stuart Brown, National Compost Development Association, PO Box 4, Grassington, North Yorkshire, BD23 5UR UK (stuartbrown@compuserve.com).
- 5 - Johnson, Julie. (1990). "Waste That No One Wants." *New Scientist.* 9/8/90, Vol. 127, Issue 1733. (p.50).
- 6 - Benedict, Arthur H. et. al. (1988). "Composting Municipal Sludge: A Technology Evaluation." Appendix A. Noyes Data Corporation.

7 - Biocycle, January 1998, p. 71.

8 - Johnson, Julie. (1990). *Waste That No One Wants*. (p. 53) see above.

9 - Simon, Ruth. (1990). *The Whole Earth Compost Pile?* Forbes. 5/28/90, Vol. 145, Issue 11. p. 136.

10 - Gotaas, Harold B., (1956). Composting - Sanitary Disposal and Reclamation of Organic Wastes. p.101. World Health Organization, Monograph Series Number 31. Geneva.

Source: The Humanure Handbook. Jenkins Publishing, PO Box 607, Grove City, PA 16127. To order, phone: 1-800-639-4099.

www.jenkinspublishing.com

[Previous Page](#) | [Top](#) | [Next Page](#)

weblife.org | [library](#) | [Humanure Handbook](#) | *References*

ALTERNATIVE GREY WATER SYSTEMS

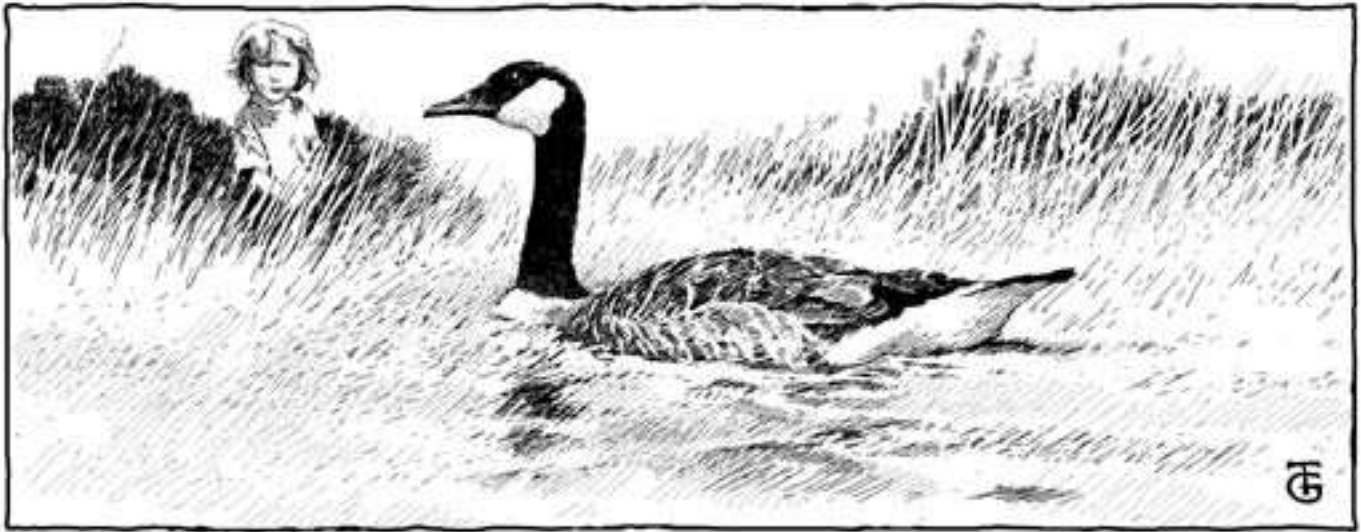

"When dealt with appropriately, graywater is a valuable resource which horticultural and agricultural growers, as well as home gardeners, will increasingly come to appreciate."

Carl Lindstrom

There are two concepts that sum up this book: 1) one organism's excretions are another organism's food, and 2) there is no waste in nature. We humans need to understand what organisms will consume our excretions if we are to live in greater harmony with the natural world. Our excretions include humanure, urine, and *other* organic materials that we discharge into the environment, such as "graywater," which is the water resulting from washing or bathing. Graywater should be distinguished from "blackwater," the water that comes from toilets. Graywater contains recyclable organic materials such as nitrogen, phosphorous, and potassium. These materials are pollutants when discarded into the environment. When responsibly recycled, however, they can be beneficial nutrients.

My first exposure to an "alternative" wastewater system occurred on the Yucatan Peninsula of Mexico in 1977. At that time, I was staying in a tent on a primitive, isolated, beach-front property lined with coconut palms and overlooking the turquoise waters and white sands of the Caribbean. My host operated a small restaurant with a rudimentary bathroom containing a toilet, sink, and shower, primarily reserved for tourists who paid to use the room. The wastewater from this room drained from a pipe, through the wall, and directly into the sandy soil outside, where it ran down an inclined slope out of sight behind the thatched pole building. I first noticed the drain not because of the odor (there wasn't any that I can remember), but because of the thick growth of tomato plants that cascaded down the slope where the

drain was located. I asked the owner why he would plant a garden in such an unlikely location, and he replied that he didn't plant it at all - the tomatoes were volunteers; the seeds sprouted from human excretions. He admitted that whenever he needed a tomato, he didn't have to go far to get one. This is not an example of sanitary wastewater recycling, but it is an example of how wastewater can be put to constructive use, even by accident.

From there, I traveled to Guatemala, where I noticed a similar wastewater system, again at a crude restaurant at an isolated location in the Peten jungle. The restaurant's wastewater drain irrigated a small section of the property separate from the camp sites and other human activities, but plainly visible. That section had the most luxurious growth of banana plants I had ever seen. Again, the water proved to be a resource useful in food production, and in this case, the luxurious growth added an aesthetic quality to the property, appearing as a lush tropical garden. The restaurant owner liked to show off his "garden," admitting that it was largely self-planted and self-perpetuating. "That's the value of drain water," he was quick to point out, and its value was immediately apparent to anyone who looked.

All wastewater contains organic materials, such as food remnants and soap. Microorganisms, as well as plants and macroorganisms, consume these organic materials and convert them into beneficial nutrients. In a sustainable system, wastewater is made available to natural organisms for their benefit. Recycling organic materials through living organisms naturally purifies water.

In the US, the situation is quite different. Household wastewater typically contains all the water from toilet flushings (blackwater) as well as water from sink, bathtub, and washing machine drains (graywater). To complicate this, many households have in-sink garbage disposals. These contraptions grind up all of the organic food material that could otherwise be composted, then eject it out into the drain system. Government regulators assume the worst case scenario for household wastewater (lots of toilet flushings, lots of baby diapers in the wash, and lots of garbage in the disposal unit), then they draft regulations to accommodate this scenario. Wastewater is considered a public health hazard which must be quarantined from human contact. Typically, the wastewater is required to go directly into a sewage system, or, in suburban and rural locations, into a septic system.

A septic system generally consists of a concrete box buried underground into which household wastewater is discharged. When the box fills and overflows, the effluent drains into perforated pipes that allow the water to percolate into the soil. The drain field is usually located deep enough in the soil that surface plants cannot access the water supply.

In short, conventional drainage systems isolate wastewater from natural systems, making the organic material in the water unavailable for recycling. At wastewater treatment plants (sewage plants), the organic material in the wastewater is removed using complicated, expensive procedures. Despite the high cost of such separation processes, the organic material removed from the wastewater is often buried in a landfill.

The alternatives should be obvious. Albert Einstein once remarked that the human race will require an

entirely new manner of thinking if it is to survive. I am inclined to agree. Our "waste disposal" systems must be rethought. As an alternative to our current throw-away mentality, we can understand that organic material is a resource, rather than a waste, that can be beneficially recycled using natural processes.

In pursuing this alternative, the first step is to *recycle* as much organic material as possible, keeping it away from waste disposal systems altogether. We can eliminate all blackwater from our drains by composting all human manure and urine. We can also eliminate almost all other organic material from our drains by composting food scraps. As such, one should never use an in-sink garbage disposal. As an indication of how much organic material typically goes down a household drain, consider the words of one composting toilet manufacturer, "*New regulations will soon demand that septic tanks receiving flush toilet and garbage disposal wastes be pumped out and documented by a state certified septage hauler every three years. When toilet and garbage solids and their associated flush water is removed from the septic system, and the septic tank is receiving only graywater, the septic tank needs pumping only every twenty years.*" ¹ According to the US EPA, household garbage disposals contribute 850% more organic matter and 777% more suspended solids to wastewater than do toilets.²

The second step is to understand that a drain is not a waste disposal site; it should *never* be used to dump something to "get rid of it." This has unfortunately become a bad habit for many Americans. As an example, a friend was helping me process some of my home-made wine. The process created five gallons of spent wine as a by-product. When I had my back turned, the fellow dumped the liquid down the sink drain. I found the empty bucket and asked what happened to the liquid that had been in it. "I dumped it down the sink," he said. I was speechless. Why would anyone dump five gallons of food-derived liquid down a sink drain? But I could see why. My friend considered a drain to be a waste disposal site, as do most Americans. This was compounded by the fact that he had *no idea* what to do with the liquid otherwise. My household effluent drains directly into a constructed wetland which consists of a graywater pond. Because anything that goes down that drain feeds a natural aquatic system, I am quite particular about what enters the system. I keep all organic material out of the system, except for the small amount that inevitably comes from dishwashing and bathing. All food scraps are composted, as are grease, fats, oils, and every other bit of organic food material our household produces (every food item compost educators tell you "not to compost" ends up down a drain or in a landfill otherwise, which is foolish; in our household, it all goes into the compost). This recycling of organic material allows for a relatively clean graywater that can be easily remediated by a constructed wetland, soilbed, or irrigation trench. The thought of dumping something down my drain simply to dispose of it just doesn't fit into my way of thinking. So I instructed my friend to pour any remaining organic liquids onto the compost pile. Which he did. I might add that this was in the middle of January when things were quite frozen, but the compost pile still absorbed the spent wine. In fact, that winter was the first one in which the active compost pile did not freeze. Apparently, the 30 gallons of liquid we doused it with kept it active enough to generate heat all winter long.

Step three is to eliminate the use of all toxic chemicals and non-biodegradable soaps in one's household. Chemicals could find their way down the drains and out into the environment as pollutants. The quantity and variety of toxic chemicals routinely dumped down drains in the US is both incredible and disturbing. We can eliminate a lot of our wastewater problems by simply being careful what we add to our water.

Many Americans do not realize that most of the chemicals they use in their daily lives and believe to be necessary are not necessary at all. They can simply be eliminated. This is a fact that will not be promoted on TV or by the government (including schools), because the chemical industry might object. I am quite sure that you, the reader, don't care whether the chemical industry objects or not. Therefore, you willingly make the small effort necessary to find environmentally benign cleaning agents for home use.

Cleaning products that contain boron should not be used with graywater recycling systems because boron is reportedly toxic to most plants. Liquid detergents are better than powdered detergents because they contribute less salts to the system.³ Water softeners may not be good for graywater recycling systems because softened water reportedly contains more sodium than unsoftened water, and the sodium may build up in the soil, to its detriment. Chlorine bleach or detergents containing chlorine should not be used, as chlorine is a potent poison. Drain cleaners, and products that clean porcelain without scrubbing should not be drained into a graywater recycling system.

Step four is to reduce our water consumption altogether, thereby reducing the amount of water issuing from our drains. This can be aided by collecting and using rainwater, and by recycling graywater through beneficial, natural systems.

The "old school" of wastewater treatment, still embraced by most government regulators and many academics, considers water to be a vehicle for the routine transfer of waste from one place to another. It also considers the accompanying organic material to be of little or no value. The "new school," on the other hand, sees water as a dwindling, precious resource that should not be polluted with waste; organic materials are seen as resources that should be constructively recycled. My research for this chapter included reviewing hundreds of research papers on alternative wastewater systems. I was amazed at the incredible amount of time and money that has gone into studying how to clean the water we have polluted with human excrement. In all of the research papers, without exception, the idea that we should simply stop defecating in water is never suggested.

The change from a water polluting, waste-disposal way of life to an environmentally benign, resource-recovery way of life will not occur from the "top down." Many government authorities and scientists take our wasteful, polluting way of life for granted, and even defend it. Those of us who are courageous enough to be different and who insist upon environmentally friendly lifestyles represent the first wave in the emerging lifestyle changes which we must all inevitably embrace. As our numbers increase, our cumulative impact will become more and more significant.

GRAYWATER

"The question of residential water conservation is not one of whether it will occur, but rather a question of how rapidly it will occur."

Martin M. Karpiscak et al.

It is estimated that 42 to 79% of household graywater comes from the bathtub and shower, 5 to 23% from

laundry facilities, 10 to 17% from the kitchen sink or dishwasher, and 5 to 6% from the bathroom sink. [By comparison, the flushing of toilets (creating blackwater) constitutes 38 to 45% of all interior water use in the US, and is the single largest use of water indoors. On average, a person flushes a toilet six times a day.^{6]}

Various studies have indicated that the amount of graywater generated per person per day varies from 25 to 45 gallons (96 to 172 liters), or 719 to 1,272 gallons (2,688 to 4,816 liters) per week for a typical family of four.⁴ In California, a family of four may produce 1300 gallons of graywater in a week.⁵ This amounts to nearly a 55 gallon drum filled with sink and bath water by every person every day, which is then drained into a septic or sewage system. This estimate does not include toilet water. Ironically, the graywater we dispose of can still be useful for such purposes as yard, garden, and greenhouse irrigation. Instead, we dump the graywater into the sewers and use drinking water to irrigate our lawns.

Reuse of graywater for landscape irrigation can greatly reduce the amount of drinkable water used during the summer months when landscape water may constitute 50-80% of the water used at a typical home. Even in an arid region, a three person household can generate enough graywater to meet all of their irrigation needs.⁷ In Tucson, Arizona, for example, a typical family of three uses 123,400 gallons of municipal water per year.⁸ It is estimated that 31 gallons of graywater can be collected per person, per day, amounting to almost 34,000 gallons of graywater per year for the same family.⁹ An experimental home in Tucson, known as Casa del Aqua, reduced its municipal water use by 66% by recycling graywater and collecting rainwater. Graywater recycling amounted to 28,200 gallons per year, and rainwater collection amounted to 7,400 gallons per year.¹⁰ In effect, recycled graywater constitutes a "new" water supply by allowing water that was previously wasted to be used beneficially. Water reuse also reduces energy and fossil fuel consumption by requiring less water to be purified and pumped, thereby helping to reduce the production of global warming gases such as carbon dioxide.

Because graywater can be contaminated with fecal bacteria and chemicals, its reuse is prohibited or severely restricted in many states. Since government regulatory agencies do not have complete information about graywater recycling, they assume the worst-case scenario and simply ban its reuse. This is grossly unfair to those who are conscientious about what they put down their drains and who are determined to conserve and recycle water. Graywater experts contend that the health threat from graywater is insignificant. One states, "*I know of no documented instance in which a person in the US became ill from graywater.*" ¹¹ Another adds, "*Note that although graywater has been used in California for about 20 years without permits, there has not been one documented case of disease transmission.*" ¹² The health risks from graywater reuse can be reduced first by keeping as much organic material and toxic chemicals out of your drains as possible, and second, by filtering the graywater into a constructed wetland, soilbed, or below the surface of the ground so that the graywater does not come into direct human contact, or in contact with the edible portions of fruits and vegetables.

In November of 1994, legislation was passed in California that allowed the use of graywater in single family homes for subsurface landscape irrigation. Many other states do not currently have any legislation regulating graywater ([see Appendix 3](#)). However, many states are now realizing the value of alternative

graywater systems and are pursuing research and development of such systems. The US EPA, for example, considers the use of wetlands to be an emerging alternative to conventional treatment processes.

PATHOGENS

Graywater can contain disease organisms which originate from fecal material or urine entering bath, wash, or laundry water. Potential pathogens in fecal material and urine, as well as infective doses, are listed in [Chapter 7](#).

Indicator bacteria such as *E. coli* reveal fecal contamination of the water, as well as the possible presence of other intestinal disease-causing organisms. Fecal coliforms are a pollution indicator. A high count is undesirable and indicates a greater chance of human illness resulting from contact with the graywater. Plant material, soil, and food scraps can contribute to the *total* coliform population, but fecal coliforms indicate that fecal material is also entering the water system. This can come from baby diapers, or just from bathing or showering.

More microorganisms may come from shower and bath graywater than from other graywater sources. Studies have shown that total coliforms and fecal coliforms were approximately ten times greater in bathing water than in laundry water (see Figure 9.1).¹³

One study showed an average of 215 total coliforms per 100 ml and 107 fecal coliforms per 100 ml in laundry water; 1810 total coliforms and 1210 fecal coliforms per 100 ml in bath water; and 18,800,000 colony forming units of total coliforms per 100 ml in graywater containing household garbage (such as when a garbage disposal is used).¹⁴ Obviously, grinding and dumping food waste down a drain greatly increases the bacterial population of the graywater.

Due to the undigested nature of the organic material in graywater, microorganisms can grow and reproduce in the water during storage. The numbers of bacteria can actually increase in graywater within the first 48 hours of storage, then remain stable for about 12 days, after which they slowly decline (see Figure 9.2).¹⁵

For maximum hygienic safety, follow these simple rules when using a graywater recycling system: don't drink graywater; don't come in physical contact with graywater (and wash promptly if you accidentally do come in contact with it); don't allow graywater to come in contact with edible portions of food crops; don't allow graywater to pool on the surface of the ground; and don't allow graywater to run off your property.

PRACTICAL GRAYWATER SYSTEMS

The object of recycling graywater is to make the organic nutrients in the water available to plants and microorganisms, preferably on a continuous basis. The organisms will consume the organic material,

thereby recycling it through the natural system.

It is estimated that 30 gallons of graywater per person per day will be produced from a water-conservative home. This graywater can be recycled either indoors or outdoors. Inside buildings, graywater can be filtered through deep soil beds, or shallow gravel beds, in a space where plants can be grown, such as in a greenhouse.

Outdoors, in colder climates, graywater can be drained into leaching trenches that are deep enough to resist freezing, but shallow enough to keep the nutrients within the root zones of surface plants. Freezing can be prevented by applying a mulch over the subsurface leaching trenches. Graywater can also be circulated through evapotranspiration trenches (Figure 9.3), constructed wetlands (Figures 9.4, 9.5, 9.6, and 9.7), mulch basins (Figure 9.10), and soilbeds (Figures 9.11, 9.12, 9.13, and 9.14).

EVAPOTRANSPIRATION

Plants can absorb graywater through their roots and then transpire the moisture into the air. A graywater system that relies on such transpiration is called an Evapotranspiration System. Such a system may consist of a tank to settle out the solids, with the effluent draining or being pumped into a shallow sand or gravel bed covered with vegetation. Canna lilies, iris, elephant ears, cattails, ginger lily, and umbrella tree, among others, have been used with these systems. An average two bedroom house may require an evapotranspiration trench that is three feet wide and 70 feet long. One style of evapotranspiration system consists of a shallow trench lined with clay or other waterproof lining (such as plastic), filled with an inch or two of standard gravel, and six inches of pea gravel. Plants are planted in the gravel, and no soil is used.

Other systems, such as the Watson Wick (Figure 9.3), may be deeper and may utilize topsoil.

CONSTRUCTED WETLANDS

The system of planting aquatic plants such as reeds or bulrushes in a wet (often gravel) substrate medium for graywater recycling is called a "constructed wetland" or "artificial wetland." The first artificial wetlands were built in the 1970s. By the early 1990s, there were more than 150 constructed wetlands treating municipal and industrial wastewater in the US.

According to the US Environmental Protection Agency, "Constructed wetlands treatment systems can be established almost anywhere, including on lands with limited alternative uses. This can be done relatively simply where wastewater treatment is the only function sought. They can be built in natural settings, or they may entail extensive earthmoving, construction of impermeable barriers, or building of containment such as tanks or trenches. Wetland vegetation has been established and maintained on substrates ranging from gravel or mine spoils to clay or peat . . . Some systems are set up to recharge at least a portion of the treated wastewater to underlying ground water. Others act as flow-through systems, discharging the final effluent to surface waters. Constructed wetlands have diverse applications

and are found across the country and around the world. They can often be an environmentally acceptable, cost-effective treatment option, particularly for small communities." ¹⁶

A wetland, by definition, must maintain a level of water near the surface of the ground for a long enough time each year to support the growth of aquatic vegetation. Marshes, bogs, and swamps are examples of naturally occurring wetlands. Constructed wetlands are designed especially for pollution control, and exist in locations where natural wetlands do not.

Two types of constructed wetlands are in common use today. One type exposes the water's surface (Surface Flow Wetland, Figure 9.6), and the other maintains the water surface below the level of the gravel (Subsurface Flow Wetland, Figures 9.4, 9.5, and 9.7). Some designs combine elements of both. Subsurface flow wetlands are also referred to as Vegetated Submerged Bed, Root Zone Method, Rock Reed Filter, Microbial Rock Filter, Hydrobotanical Method, Soil Filter Trench, Biological-Macrophytic Marsh Bed, and Reed Bed Treatment.¹⁷

Subsurface flow wetlands are considered to be advantageous compared to open surface wetlands, and are more commonly used for individual households. By keeping the water below the surface of the gravel medium, there is less chance of odors escaping, less human contact, less chance of mosquito breeding, and faster "treatment" of the water (due to more of the water being exposed to the microbially populated gravel surfaces and plant roots). The subsurface water is also less inclined to freeze during cold weather.

Constructed wetlands generally consist of one or more lined beds, or cells. The gravel media in the cells should be as uniform in size as possible and should consist of small to medium size gravel or stone, from one foot to three feet in depth. A layer of sand may be used either at the top or the bottom of a gravel medium, or a layer of mulch and topsoil may be applied over the top of the gravel. In some cases, gravel alone will be used with no sand, mulch, or topsoil. The sides of the wetlands are bermed to prevent rainwater from flowing into them, and the bottom may be slightly sloped to aid in the flow of graywater through the system. A constructed wetland for a household, once established, requires some maintenance, mainly the annual harvesting of the plants (which can be composted).

In any case, the roots of aquatic plants will spread through the gravel as the plants grow. The most common species of plants used in the wetlands are the cattails, bulrushes, sedges, and reeds. Graywater is filtered through the gravel, thereby keeping the growing environment wet, and bits of organic material from the graywater become trapped in the filtering medium. Typical retention times for graywater in a subsurface flow wetland system range from two to six days. During this time, the organic material is broken down and utilized by microorganisms living in the medium and on the roots of the plants. A wide range of organic materials can also be taken up directly by the plants themselves.

Bacteria, both aerobic and anaerobic, are among the most plentiful microorganisms in wetlands and are thought to provide the majority of the wastewater treatment. Microorganisms and plants seem to work together symbiotically in constructed wetlands, as the population of microorganisms is much higher in the root areas of the plants than in the gravel alone. Dissolved organic materials are taken up by the roots

of the plants, while oxygen and food are supplied to the underwater microorganisms through the same root system.¹⁸

Aquatic microorganisms have been reported to metabolize a wide range of organic contaminants in wastewater, including benzene, naphthalene, toluene, chlorinated aromatics, petroleum hydrocarbons, and pesticides. Aquatic plants can take up, and sometimes metabolize, water contaminants such as insecticides and benzene. The water hyacinth, for example, can remove phenols, algae, fecal coliforms, suspended particles, and heavy metals including lead, mercury, silver, nickel, cobalt, and cadmium from contaminated water. In the absence of heavy metals or toxins, water hyacinths can be harvested as a high-protein livestock feed. It can also be harvested as a feedstock for methane production. Reed-based wetlands can remove a wide range of toxic organic pollutants.¹⁹ Duckweeds also remove organic and inorganic contaminants from water, especially nitrogen and phosphorous.²⁰

When the outdoor air temperature drops below a certain point (during the winter months in cold climates), wetland plants will die and microbial activity will drop off. Therefore, constructed wetlands will not provide the same level of water treatment year round. Artificial wetlands systems constitute a relatively new approach to water purification, and the effects of variables such as temperature fluctuations are not completely understood. Nevertheless, wetlands are reported to perform many treatment functions efficiently in winter. One source reports that the removal rates of many contaminants are unaffected by water temperature, adding, "*The first two years of operation of a system in Norway showed a winter performance almost at the same level as the summer performance.*" Some techniques have been developed to insulate wetland systems during the colder months. For example, in Canada, water levels in wetlands were raised during freezing periods, then lowered after a layer of ice had formed. The cattails held the ice in place, creating an air space over the water. Snow collected on top of the ice, further insulating the water underneath.²¹

It is estimated that one cubic foot of artificial wetland is required for every gallon per day of graywater produced. For an average single bedroom house, this amounts to about a 120 square foot system, one foot deep. However, it is better to overbuild a system than to underbuild. Some constructed wetland situations may not have enough drainage water from a residence to keep the system wet enough. In this case, extra water may be added from rain water collection or other sources.

WETLAND PLANTS

Aquatic plants used in constructed wetland systems can be divided into two general groups: microscopic and macroscopic. Most of the microscopic plants are algae, which can be either single cell (such as *Chlorella* or *Euglena*) or filamentous (such as *Spirulina* or *Spyrogyra*).

Macroscopic (larger) plants can grow under water (submergent) or above water (emergent). Some grow partially submerged and some partially emerged. Some examples of macroscopic aquatic plants are reeds, bulrushes, water hyacinths, and duckweeds (see Figure 9.8 and Table 9.1). Submerged plants can remove nutrients from wastewaters, but are best suited in water where there is plenty of oxygen (water

with a high level of organic material tends to be low in oxygen due to extensive microbial activity).

Examples of floating plants are duckweeds and water hyacinths. Duckweeds can absorb large quantities of nutrients. Small ponds that are overloaded with nutrients such as farm fertilizer run-off can often be seen choked with duckweed, appearing as a green carpet on the pond's surface. In a two and a half acre pond, duckweed can absorb the nitrogen, phosphorous, and potassium from the excretions of 207 dairy cows. The duckweed can eventually be harvested, dried, and fed back to the livestock as a protein-rich feed. Livestock can even eat the plants directly from a water trough.²²

Algae work in partnership with bacteria in aquatic systems. Bacteria break down complex nitrogen compounds and thereby make the nitrogen available to algae. Bacteria also produce carbon dioxide which is utilized by the algae.²³

SOILBOXES OR SOILBEDS

A soilbox is a box designed to allow graywater to filter through it while plants grow on top of it (Figure 9.14). Such boxes have been in use since the 1970s. Since the box must be well-drained, it is first layered with rocks, pea gravel, or other drainage material. This is covered with screening, then a layer of coarse sand is added, followed by finer sand; two feet of top soil is added to finish it off. Soilboxes can be located indoors or outdoors, either in a greenhouse, or as part of a raised-bed garden system.²⁴

Soilboxes (soilbeds) located in indoor greenhouses are illustrated in Figures 9.11 and 9.13. An outdoor soilbed is illustrated in Figure 9.12.

PEEPERS

At one point in the development of my homestead, I had to decide what to do with my graywater. My household produced no blackwater or sewage, and we composted all of our organic material. We only had a hand pump at the kitchen sink, and we carried our drinking water from a spring out behind the house. Nevertheless, we still had a sink and bathtub with drains, and the water had to go somewhere.

The choices I had were pretty limited: install an underground septic tank and drain the graywater into it; run the graywater through some sort of biofilter (such as sawdust) and then compost the sawdust on occasion; or try some sort of constructed wetland. I decided to experiment with the last option, mainly because I had an acid-mine-drainage spring running past my house, and I thought the graywater, which tends to be alkaline because of soap, would help neutralize the acid water. I also thought a pond would provide insurance against a drought, when rain water collection for watering a garden isn't reliable.

The acid spring flowed past my house from an abandoned surface coal mine, and when I first started living beside it, it was choked with long, slimy, green algae. I introduced ducks to the algae-choked water, and quite by accident, I found that the algae disappeared as long as I kept ducks on the water. Whether the ducks were eating the algae or just breaking it up with their feet, I don't know. In any case,

the water changed from ugly to beautiful, almost overnight, by the simple addition of another lifeform to the biological system. This indicated to me that profound changes could occur in ecological systems with proper (even accidental) management. Unfortunately, constructed wetland systems are still new and there is not much concrete information about them that is applicable to single family dwellings. Therefore, I was forced, as usual, to engage in experimentation.

I built a naturally clay-lined pond near my house about the size of a large swimming pool, then diverted some of the acid mine water to fill the pond. I directed my graywater into this "modified lagoon" wastewater system via a six inch diameter drain pipe with an outlet discharging the graywater below the surface of the pond water. I installed a large drainpipe to act as a pre-digestion chamber where organic material could collect and be broken down by anaerobic bacteria en route to the lagoon, like a mini septic tank. I add septic tank bacteria to the system annually by dumping it down the household drains. I assumed that the small amount of organic matter that entered the pond from the graywater drain would be consumed by the organisms in the water, thereby helping to biologically remediate an extensively damaged source of water. The organic material settles into the bottom of the pond, which is about five feet at the deepest point, thereby being retained in the constructed system indefinitely. I also lined the bottom of the pond with limestone to help neutralize the incoming acid mine water.

The ducks, of course, loved the new pond. They still spend countless hours poking their heads under the water, searching the pond bottom for things to eat. Our house is located between our garden and the pond, and the water is clearly visible from the kitchen sink, as well as from the dining room on the east side of the house, while the nearby garden is visible from the west windows. Shortly after we built the pond, my family was working in our garden. Soon we heard the loud honking of Canada geese in the sky overhead, and watched as a mating pair swooped down through the trees and landed on our new, tiny pond. This was quite exciting, as we realized that we now had a place for wild waterfowl, a bonus we hadn't really anticipated. We continued working in the garden, and were quite surprised to see the geese leave the pond and walk past our house toward the garden where we were busy digging. We continued to work, and they continued to walk toward us, eventually walking right past us through the yard, and on to the far end of the garden. When they reached the orchard, they turned around and marched right past us again, making their way back to the pond. To us, this was equivalent to an initiation for our new pond, a way that nature was telling us we had contributed something positive to the environment.

Of course, it didn't end with the two Canada Geese. Soon, a Great Blue Heron landed in the pond, wading around its shallow edges on stilt-like legs. It was spotted by one of the children during breakfast, a mere fifty feet from the dining room window. Then, a pair of colorful wood ducks spent an afternoon playing in the water. This was when I noticed that wood ducks can perch on a tree branch like a songbird. Recently, I counted 40 Canada geese on the little pond. They covered its surface like a feathery carpet, only to suddenly fly off in a great rush of wings.

We raise our own domesticated ducks for algae control, for eggs, and occasionally for meat. At one point we raised some Mallard ducks, only to find that this wild strain will fly away when they reach maturity. One of the female Mallards became injured somehow, and developed a limp. She was certainly a "lame duck," but the children liked her and took care of her. Then one day she completely disappeared. We

thought a predator had killed the defenseless bird, and we never expected to see her again. To the children's delight, the following spring a pair of wild Mallard ducks landed on our little pond. We watched them swim around for quite some time, until the female came out of the water and walked toward us. Or, I should say, "limped" toward us. Our lame Mallard duck had flown away for the winter only to come back in the spring with a handsome boyfriend! Our new graywater pond was the point of reference for her migration.

My youngest daughter, Phoebe, was given a Canada goose to raise by one of the neighbors. The tiny gosling couldn't have been more than a day or two old when it was discovered wandering lost along the road. I'm not sure why Phoebe was asked to take care of the goose, other than she loves animals and she had a pond in her backyard, but she enthusiastically accepted the responsibility. She named the goose "Peepers," and everywhere Phoebe went, Peepers followed. The two of them spent many a day at the graywater pond, Peepers splashing around in the water while Phoebe sat on the shore watching. Soon Peepers was a full grown goose, and everywhere Peepers went, large piles of goose droppings followed. The goose doo situation finally became so intolerable (to Dad, who renamed the goose "Poopers") that Peepers was furtively exported to the wild. Phoebe was heartbroken.

This spring, as I write this, ten years after our graywater pond was constructed, a pair of honking Canada geese once again flew overhead. Except this time, only the female landed in our little pond. Phoebe went running to the pond when she heard that familiar honking, yelling "Peepers! Peepers!" Peepers had come back to say hello to Phoebe. How did I know it was Peepers? I didn't. But somehow, Phoebe did. She stood on the pond bank for quite some time talking to the majestic goose, and the goose, also standing on the bank, talked back. They carried on a conversation that is rarely witnessed. Finally, Peepers flew off, and this time, Phoebe was happy.

I have more stories to tell about our graywater pond, and no doubt will have many more in the future. A buried, quarantined, septic tank for graywater, on the other hand, is pretty boring. I believe I made the right decision in deciding to construct a pond for our graywater. The benefits of such a system can go far beyond what one may imagine.

Source: The Humanure Handbook. Jenkins Publishing, PO Box 607, Grove City, PA 16127. To order, phone: 1-800-639-4099.

www.jenkinspublishing.com

[Previous Page](#) | [Top](#) | [Next Page](#)

weblife.org | [library](#) | [Humanure Handbook](#) | *Chapter 9: Alternative Grey Water Systems*

Site Sponsor



The world of Composting Toilets

Welcome to the World of Composting Toilets Web site.

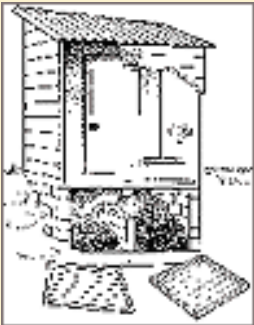
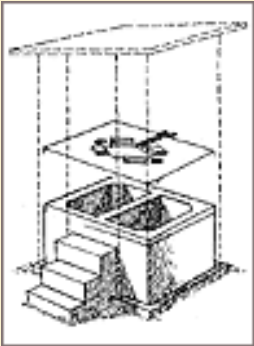
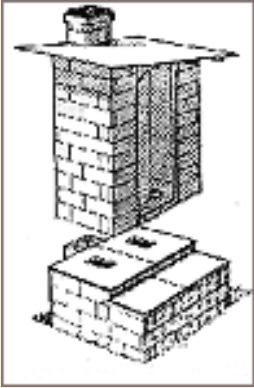

Latest

June 1 - 2004 - Update

We have decided to make the site into a non-profit site so that it can advance quicker and serve you out there better. We will be discussing this in private forums and hope to have the site up and running in a better, more independent format with more interaction and being maintained by a group of enthusiasts. This will make the site more relevant to you, and more able to promote composting toilets and greywater systems around the world.

If you are interested in helping out in the venture, send your email address and a few details to admin@compostingtoilet.org and we will include you in the online discussions.

Jan 14 - 2004 - Updates

Updated the website address for Brian Woodward - consultant. www.compostingtoilet.org/consultants.cfm#consults_earthways.

We have also added the web address for the consultants "Elemental Solutions" in the UK. Very experienced consultants in toilet solutions.

www.compostingtoilet.org/consultants.cfm#consults_elemental.

We have added the website for the consultant "Natural Solutions". www.compostingtoilet.org/consultants.cfm#consults_natsolutions.

There is a new forum started by the people at the Dutch group "De 12 Ambachten" in Holland. We have added it to the list on the forum page, or you can go there at the following link - you will need to join the Yahoo groups to be on list. It is mainly in Dutch language, but open to all.

<http://groups.yahoo.com/group/compost-toilet/>.

Fixed a problem with the "articles" section and it now should be working again.

Cheers,

Key

[Home](#)
[Explain CT's](#)
[FAQ's](#)
[Systems](#)
[Suppliers](#)
[Consultants](#)
[Products](#)
[Owner-Build](#)
[Public Facilities](#)
[Greywater](#)
[Associations](#)
[Publications](#)
[Articles](#)
[Training](#)
[International](#)
[Links](#)
[LARGER TEXT?](#)
[Link to us](#)
[About WOCT](#)
[Contact us](#)

Published by::

eekos

High Walk House
Kirkby Malzeard
Ripon
North Yorkshire
HG4 3QL
ENGLAND

Phone::

UK 01765 650385

November 2002 - WOCT has a new look and a sponsor!

We thank Scott Smith and Sancor Industries Ltd. makers of the Envirolet® range for having the confidence to sponsor us.

If you want to have a look at the range of Envirolet® systems on offer, just click on their logo at the top left.

The aim of the site is to present information on composting toilets so that persons in all countries have the opportunity to help improve their living conditions and their surrounding natural environment.

Need to contact all manufacturers and consultants for installation / project?

If you are considering installing a composting toilet system for your house, or thinking of it for a larger commercial use (e.g. eco-tourism etc.) or perhaps a composting toilet sanitation project in a low income part of the world, then we have a mailing list that goes to all the manufacturers and consultants in the world which you can use to send a message.

We have sent over 250 enquiries in the last year on to the manufacturers and have had all good reports on the replies and attention received.

Click [HERE](#) to go to the form to send.

Oh yes, before you dive in, could you have a look at our [disclaimer](#) thanks. There is just too many variables for us to be responsible for the systems we provide information on.

Quick Find

Want to have a quick summary of all the commercial systems in the world?

Go to the [Systems](#) page for a list with basic information on all systems.

Need to find out who is supplying systems in your country?

Go to the [Suppliers](#) page and there is a list of all countries that have agents or manufacturers. Don't forget that wherever you are in the world, most manufacturers will endeavor to supply you a system if there is not a local agent.

Want to build a composting toilet?

Go to our [Owner-build](#) page and you will find various plans and information.

Need help with designing or choosing a system?

Try a consultant to assist you in selecting or designing a system for your location. This is particularly good for looking at options for larger scale systems. Look to the [Consultants](#) page for a country listing.

Contents

[Explain CT's](#) :: [FAQ's](#) :: [Systems](#) :: [CT suppliers](#) :: [Consultants](#) ::
[Products](#) :: [Owner-build](#) :: [Public Facilities](#) :: [Greywater](#) ::
[Associations](#) :: [Publications](#) :: [Articles](#) :: [Training](#) :: [International](#) ::
[Links](#) :: [Email us](#)

This page - <http://www.compostingtoilet.org/index.cfm> [^ top](#)

COMPOSTING TOILETS AND RELATED PRODUCTS: MANUFACTURERS AND SUPPLIERS

(Special Thanks to the World of Composting Toilets Website at:

<http://www.compostingtoilet.org>)

This list is provided for informational purposes only. Inclusion on this list does not constitute an endorsement by the author.

[AUSTRALIA](#) | [BELGIUM](#) | [CANADA](#) | [CHILE](#) | [DENMARK](#) | [FINLAND](#) | [GERMANY](#) | [IRELAND](#) | [ISRAEL](#) | [KOREA](#) | [LATVIA](#) | [NETHERLANDS](#) | [NEW ZEALAND](#) | [NORWAY](#) | [SOUTH AFRICA](#) | [SPAIN](#) | [SWEDEN](#) | [SWITZERLAND](#) | [UK](#) | [USA](#) | [OWNER BUILT](#) | [COMPOST THERMOMETERS](#) | [BACKYARD COMPOST BINS](#) | [COMPOST TESTING LABS](#) | [AUDIO TAPES](#) | [INTERNET LINKS](#)

AUSTRALIA

CLIVUS MULTRUM AUSTRALIA

115 Railway Avenue, Strathpine, Qld 4500, Australia

Phone: 61 7 3889 6144

Fax: 61 7 3889 6149

Mobile phone: 0419 657851

Website: <http://www.earthlink.com.au/clivus>

Email: www.ats.com.au

Contact: Tony Rapson

Sells the Clivus Multrum range of toilets and graywater systems as well as toilet buildings for use in National Parks and Public areas. Also acts as agent for Separett and EnviroLet composting toilets.

CLIVUS MULTRUM TOILET SYSTEMS (Agent)

9 Holland Street, Fremantle 6160, Western Australia, Australia

Phone: (08) 9430 7777

Fax: 61 8 9430 4305

Email: gaiagnet@cygnus.uwa.edu.au

Agent for Clivus Multrum composting toilets in western Australia.

CLOSET DEPOSIT

3 Redash Place, Cabarita Beach, NSW 2488 Australia;

Contact: Graham Clements;

Supplies own design, inclined base, fibreglass composting chamber. Improved ventilation system for reduced tank size. Also supplies artificial wetlands graywater system in ferro-cement or HDPE plastic with flowform water conditioners.

DOWMUS

Pty Ltd PO Box 400, Mapleton Qld, 4552, Australia

Phone: 61 7 5499 9828

Fax: 61 7 5499 9688

Email: dowmus@ozemail.com.au

Website: <http://www.dowmus.com>

Supply and install single batch tank system with compost extortion auger. Emphasis on worm and compost fauna treatment. Also incorporating graywater treatment.

GARRY SCOTT COMPOST TOILET SYSTEMS

Mullumbimby NSW, 2482, Australia

Phone: 61 2 6684 3468

FAX: 61 2 6684 4567

Email: enquires@composttoilets.com.au

Website: <http://www.composttoilets.com.au>

Design, manufacture, supply and service of a wide range of waterless compost toilets. Independent agent for systems manufactured by Clivus Multrum, Natureloo, Envirolet, Separett and selected others. Manufacture of lowcost PBD and Wheelie Batch systems. Ownerbuilder assistance with consultation, components, plans and books. Agent for the Hybrid toilet system, a septic system, with no flush, secondary treatment and excellent performance.

NATURE-LOO

Savannah Environmental Pty Ltd, 74 Brisbane Street, Bulimba, QLD 4171, Australia

Postal Address: P.O. Box 150, Bulimba, Queensland, Australia 4171

Phone: 61 7 3395 6800

Fax: 61 7 3395 5322

Email: info@nature-loo.com.au

Website: <http://www.nature-loo.com.au>

Contact: Carla Gregg

Patented market-leader in domestic composting toilets: inexpensive, aerated tank, odour-free, batch system. Classic model easily owner-installed in space under floor. Self-contained Compact model can be installed on slab floor, and is suitable for temporary accommodation, holiday cabins, building sites, camp grounds, etc. Also markets toilet buildings suitable for golf courses, building sites, etc.

ROTA-LOO COMPOSTING TOILET

41A Jarrah Drive or PO Box 988, Braeside, Victoria 3195 Australia

Phone: 61 3 9587 2447

Fax: 61 3 9587 5622

Website: <http://www.rotaloo.com>

E mail: buzzburrows@rotaloo.com

General info: enquiry@rotaloo.com

Contact: Buzz Burrows (General Manager)

Domestic models, Mini 650, Standard 950 all with removable compost bins. Commercial models, Maxi 1200 (Fiberglass) Maxi 2000, all with removable compost bins. Soltran buildings, remote location Public Toilet Facilities, supplied in kit form in any configuration with combinations of two cubicles either standard or disabled. Graywater systems, plans available for passive systems or electropurification system will clean graywater to potable standard. Other products: Bacterial agents to speed up the decomposition rate. Bacterial agents that terminate odour problems in bad installations. Full range of accessories, fiberglass and ceramic pedestals. Urinals that don't need water for cleaning.

BELGIUM

ECOSAVE SEPRETT (Agent)

Flierenbos 67, 2370 Arendonk, Belgium Ph/Fax: 32 14 67 20 04; Agent for Septum and Separett urine separating composting toilets.

CANADA

CLIVUS MULTRUM CANADA LIAISON OFFICE

1911 Lorraine Place, Ann Arbor, MI 48104-3607

Contact: Laurence Scott

Phone: 734-995-4767

Fax: 734-994-1292

Email: naylorscott@compuserve.com

CLIVUS MULTRUM CANADA LTD.

1558 Queen Street, East Toronto, Ontario, M4L 1E8 or P.O.Box 783 - Station A, Windsor, Ontario, N9A 6N8

Phone: 800-645-4767

Fax: 416-466-0635 Attn: L H Scott

Email: naylorscott@compuserve.com

CANADA-USA LIAISON

Phone : 734-995-4767

Fax: 734-994-1292

COMPOSTING TOILETS WESTERN (Agent)

1278 Inglewood Avenue, West Vancouver, B.C. B7T 1Y6, Canada

Phone: 1-604-926-3748

Fax: 1-604-926-4854

Contact: Bob Tapp

COMPOSTING TOILETS WESTERN

23646 16th Avenue, Langley B.C.V2Z 1K9, Canada

Phone/Fax: 1-604-533-5207

Contact: J. Rockandel

Supply and install Clivus Multrum composting toilets and Sum-mar composting toilets.

SANCOR

140-30 Milner Ave., Toronto, Ontario M1S 3R3 Canada

USA Toll-Free: 1-800-387-5126

CDA Toll-Free: 1-800-387-5245

International: 1-416-299-4818

Fax: 1-416-299-3124

Email: info@envirolet.com

Website: <http://www.envirolet.com>

Online Store: <http://www.sancor.net>

Manufacturer of Envirolet Composting Toilet Systems. The systems include Waterless Self-Contained, Waterless Remote and Low Water Remote models. Available in Non-Electric, 12v Battery, Solar and 110v Electric. Available for purchase online.

SUNERGY SYSTEMS LTD.

Box 70, Cremona, AB T0M 0R0, Canada

Phone: 403-637-3973

Email: sunergy@telusplanet.net

Website: <http://www.compostingtoilet.com>

Contact: Michael Kerfoot

Also at: SUNERGY'S B.C. OFFICE

2945 Haliday Crescent, Nanaimo, B.C. V9T 1B2 Canada

Phone: 250-751-0053

Fax: 250-751-0063

Sunergy distributes Phoenix composting toilet systems in Canada for residential and public facility applications. Installations from coast to coast include National Parks, Provincial Parks, roadside rest areas, golf courses, responsible housing, etc. Design integrates solar/energy/resource efficiency with a natural whimsy.

SUN-MAR CORPORATION

5035 N Service Rd C9, Burlington Ontario L7L 5V2 Canada

Phone: 1-905-332-1314

Fax: 1-905-332-1315

For a Free Catalogue Call: 1-800-461-2461

Email: compost@sun-mar.com

Website: <http://www.sun-mar.com>

Long time successful suppliers of bathroom installed composting toilets. Large range of models available for differing situations; both residential and cottage use toilets available.

CHILE

MINIMET

S.A. Av. 11 de Septiembre 1860, Of. 106, Santiago, Chile

Contact: Jaime Arancibia

Phone: 56-2-233-53 69 Fax: 56-2-232-11 95

Email: ggminimet@entelchile.net

Manufactures and sells Clivus Multrum products under license from Clivus Multrum, USA.

DENMARK

A & B BACKLUND APS (Agent)

Ordrupvej 101, DK-2920 Charlottenlund, Denmark

Phone: 45 39 63 33 64

Fax: 45 39 63 64 55

Email: backlund@backlund.dk

We work with ecological environmental engineering and waste to energy subjects. We sell no-mixing composting toilets in plastic, pine wood, metal or china. Our big composting units are made of stainless steel or glassfiber with geotextile sacks. The toilets are either without flushing, with single flushing for urine, double flushing for both urine and feces (but separate), or with vacuum for feces and gravitation for urine. Agent for Separett, Septum, Mullis, WM-Ekologen.

B & O BYGGEINDUSTRI A/S

Pakhus 12, Sdr. Frihavn, Dampfaergevej 8, 2100 Kobenhaun 0, Denmark

Contact: Dany Vandy

Phone : 45 35 43 01 01

Fax: 45 35 43 25 22

Website: <http://www.bobyg.dk>

Email: info@bobyg.dk

Sells and markets Clivus Multrum products as agent for Clivus AB, Sweden.

FINLAND

EKOLET (Biolett)

Estetie 3, FIN-00430 Helsinki, Finland

Phone: +358 40 546 4775, Fax: +358 9 563 5056

Email: ekolet@ekolet.com

Website: <http://www.ekolet.com>

The Ekolet composting toilet is the manufacturer's own design for domestic and cottage use. Good experience and test results for over 10 years. Requires no water, no additives, low or no el. requirements, cleans the liquid biologically so it can be piped along with graywater. Consists of a toilet seat and a 4 chamber rotating composting tank (polyethene, stainless steel) under the floor. The end-product is ready-to-use odorless fertilizer.

LUONTO-LAITE OY

Kasiniemenraitti 229, Fin-17740 Kasiniemi, Finland

Phone: +358 (0)3 556 8132

Fax +358 (0)3 556 8133

Email: luontola@sci.fi

Marketing: NEXET OY

Ravurinkatu 11 FIN-20380 Turku, Finland

Phone: +358 (0)2 276 0250

Fax: +358 (0)2 276 0251

Email: nexet@nexet.fi

Website: <http://www.saunalahti.fi/luontola>

The Composting Naturum Toilet. Bathroom installed, urine separating, rotary drum, composting toilet. Stylish design toilet in non-PVC plastic.

GERMANY

BIOTECHNIK (Agent)

Sigrid Habel, Lessingstr.6, D-04109 Leipzig Germany

Phone: 49 342 234 8657

Fax: 49 341 980 3391

Agent for Biolett (Ekolet) composting toilets.

PEUSER GMBH (Agent)

Siloweg 1, D-56479 Neunkirchen/Ww Germany

Phone: 49 6436 35 45

Fax: 49 6436 64 99

Agent for Septum toilets and products.

PEUSER GMBH (Agent)

Stollberger Strasse 31 D-09221 Neunkirchen/bei Chemnitz, Germany

Phone: 49 371 281 21 ?0

Fax: 49 371 281 21 50

Agent for Septum and Separett composting toilets and products.

SANITÄR U. HEIZUNG (Agent)

Uwe Reimer, Hallesche Strasse 9, D-04509 Delitzsch, Germany

Phone: 49 342 025 9281

Fax: 49 177 275 0928

Agent for Biolett (Ekolet) composting toilets.

C. & M. SCHÖNBERGER GBR (Agent)

Blumenstrasse 11; D-61239 Langenhain

Phone: 49 6002-92990

Fax: 49 6002-92980

Agent for Separett Toilets

SOLTEC GMBH (Agent)

Wichmannstrasse 4, Bldg. 10, D-22607 Hamburg, Germany

Phone: +49 40 89 50-25

Fax: +49 40 89 50-28

Email: soltec@enbil.de

Agent for Biolett (Ekolet) composting toilets.

IRELAND

THE OLD RECTORY ROBERT FORRESTER, EASKEY, CO.

Sligo Republic of Ireland

Phone/Fax: 353 96 49 181

Email: adlib@tinet.ie

Agent for Septum and Separett servicing both UK and Ireland.

ISRAEL

ECONET ENVIRONMENTAL TECHNOLOGIES & PROJECTS LTD

Dr. Amram Pruginin, 11 Bialik St, Jerusalem, Israel

Phone/Fax: (972) 2-653 61 71

Email: msamram@pluto.mscc.huji.ac.il

Agent for Clivus Multrum in Israel.

KOREA

CLIVUS KOREA INC.

701 Marco Polo Building, 720-20 Yeoksam-Dong, Kangnam-Ku, Seoul, 135-080 Korea

Phone: 82-2-501-4794/5

Fax: 82-2-568-4631

Contact: J.H. Um

Manufacture and market Clivus Multrum under license from Clivus Multrum USA.

LATVIA

SIA APRITE (Agent)

Gaujas iela 56, Cesis LV-4101, Latvia

Phone/Fax: 371 41 25 033

Agent for Septum toilets and products.

NETHERLANDS (HOLLAND)

CLIVUS MULTRUM ECOSAVE - Mr. Danny Vandy

Noorderbaan 25, 8256 PP Biddinghuizen, Holland

Phone: (31)-321-332-038

Fax: (31)-321-330-975

Agent for Clivus Multrum composting toilets, Septum and Separett.

TECHNISCH BUREAU HAMAR

Heykampsweg 6, 7642 LP Wierden, Netherlands

Phone: 31 546 575697

Email: tbhamar@xs4all.nl

Website: <http://www.xs4all.nl/~tbhamar>

Contact: Hans Baarslag; Makes and sells composting toilets for camping, temporary dwellings and replacement in normal houses. The designs are simple and utilize common materials in their manufacture. They are designed for economic treatment of toilet deposits and some household organic material.

NEW ZEALAND

ECOTECH (Agent)

RD 1 Masters Access Rd., Kaitaia, 0500 New Zealand

Phone/Fax: 64 9 409 4993

Website: <http://www.ecotech.co.nz>

Email: ecotech/nzed@xtra.co.nz

Contact: J. Douglas Donnell.

Distributors of Sun-Mar composting toilets.

NORWAY

IMPERIAL ENGOS AS

Langgaten 71 A, Postboks 98 N 4301 Sandnes, Norway

Phone: 47 51 66 44 92

Fax: 47 51 62 36 07

Agent for Separett.

VERA VERA MILJO A/S

Postboks 2036, N-3239 Sandefjord Norway

SOUTH AFRICA

DRYLOO

PO Box 75619, Gardenview 2047, South Africa

Phone/Fax: 2711 615 5328

Mobile: 2782 463 0674

Email: theboys@netactive.co.za

Dryloo waterless collapsible low cost composting toilets. Six catchment bags on rotatable piping carousel. No mechanical parts. Suitable for hot conditions. Prov. Pat. 99/1278. Also solar toilet extraction fans. Available from Michael Mayers and Associates. The specialist in African non-flush toilets.

ENVIROLOO ENVIRO OPTIONS (PTY) LTD

P.O. Box 27356, Benrose, 2011, South Africa

Phone: 27 11 6181350

Fax: 27 11 6181838

Established composting toilet maker/installer.

SPAIN

CLIVUS MULTRUM WILLI KNACKSTEDT

Phone /Fax: (34)-95-266 60 25

Mobile: 989 82 22 30

Email: carl@websida.com

SWEDEN

AQUATRON INTERNATIONAL AB

Box 2086, SE-194 02 Upplands Vasby, Sweden

Phone: +468-590 304 50

Fax: +468-590 304 94

Email: info@aquatron.se

Website: <http://www.aquatron.se>

Contact: Rolf Kornemark or Torgny Sundin.

Systems that use standard flush toilets connected to composting chambers via a centrifugal separator. The composting chamber is either inclined base, single batch or 4 chamber carousel. Graywater is treated with UV prior to drainage to a Graywater infiltration bed..

CLIVUS MULTRUM AB

Ålberga Boställe, 61050 Jönåker, Sweden

Phone: (46)-155-72310

Fax: (46)-155-72390

Email: torb@clivus-multrum.se

Main office in Europe for Clivus Multrum Composting Toilets

EKOLOGEN AB

Box 11162 - 10061, Stockholm, Sweden

Phone: 46 8 641 4250

Fax: 46 8 798 5650

Urine separating composting toilet systems.

MULLIS - THE BIOLOGICAL TOILET

Luxgatan 1, 119 69 Stockholm, Sweden

Phone: 46 8 656 54 56

Fax (?): +46 8 184 71 8

Email: mullis@hem3.passagen.se

Website: <http://hem3.passagen.se/mullis>

Contact: Uno Finnstrom

Supplies an inclined base composting toilet with 4 air tracks, built in rustfree sheet metal. Can be ordered made in desired length for capacity required.

SERVATOR SEPRETT AB

Skinnebo, S-330 10 Bredaryd, Sweden

Phone: 46 371 712 20

Fax: 46 371 712 60

Email: servator@mbox200.swipnet.se

Website: <http://www.seprett.com>

Suppliers of Lectrolav and Separett toilets, and now Septum composting toilets.

SVEN LINDEN AB

Ludvigsborg, 24394 Hoor, Sweden

Phone: 46-415-51335

Fax: 46-415-51115

Mobile: 070 584 76 52

Contact: Sven Linden

Produce a number of capacity tanks based on the single batch system with or without inclined base. Also a wheeled bin system is available.

SWEDISH ECOLOGY AB

Klippan 1A, S-414 51 Goteborg, Sweden

Phone: 46 31 42 29 30

Fax: 46 31 42 49 08

Contact: Harry Lejgren

Agent for the MullToa and Separera systems. These are the equivalent Scandinavian names for the Biolet and UFA toilets supplied by Biolet International.

SWITZERLAND

BIOLET INTERNATIONAL

Weidstrasse 18a, 6300 Zug, Switzerland

Phone : 41 41 710 4728

Fax: 41 41 710 4683

Website: <http://www.biolet.com>

E-mail: info@biolet.com

Established, world-wide suppliers of 9 models of unit compost toilets for bathroom and under-house installation.

UK

BARTON ACCESSORIES

Morleigh Road, Harbertonford, Totnes, Devon TQ9 7TS, England

Phone/Fax: 44 1803 732878

Supplies the WEB toilet, a waterless electronic/biological toilet unit that fits in bathroom. In-built heat treatment in composting cycle. Is able to supply world-wide. New model: 12/24v DC, small enough for recreational vehicles, boats, motor coaches, domestic; can be run from solar cells, batteries, or wind generator.

EASTWOOD SERVICES

Kitty Mill, Wash Lane, Wenhasston, Halesworth, Suffolk, IP19 9DX, England

Phone/Fax: 44 1502 478165

Contact: Adam East.

UK agent for Sun-Mar composting toilets and low flush systems. Supplier of gray and rain water recycling systems.

EKOLOGEN/NATRUM/SEPTUM EASTWOOD SERVICES

c/o Kitty Mill, Wash Lane Wenhasston Halesworth, Suffolk IP19 9DX England

Phone: 44 1502 478249

Fax: 44 1502 478165

ELEMENTAL SOLUTIONS

Oaklands Park, Newnham-on-Severn Gloucestershire, GL14 1EF, UK

Phone: 01594 516063

Fax: 01594 516821

Email mark.es@aecb.net

Contact: Mark Moodie

Incorporates 'Camphill Water' and 'Nick Grant Ecological Engineering'; responsible for over 100 reed bed sites and compost toilet installations. Ceramic composting toilet pedestals. Own design and site specific composting toilet kits. UK and Ireland agents for 'Aquatron' toilet systems. Co writers of "Sewage Solutions; Answering the Call of Nature" and "Septic Tanks." Low water use fittings. Sewage courses, and rainwater harvesting. Genuine enquiries only please.

KINGSLEY CLIVUS ENVIRONMENTAL PRODUCTS LTD.

Kingsley House, Woodside Road, Boyatt Wood Trading Estate, Eastleigh, Hampshire S050 4ET Great Britain

Phone: 44 01703 615680

Fax: 44 01703 642613

Contact: Viv Murley

Sells and markets Clivus Multrum products as agent for Clivus Multrum USA.

MAURICE MOORE

26 St Mary's Rd, Long Ditton, Surrey KT6, England

Phone: 44 181 398 7951

Agent for Soltrna/ Rota-loo in United Kingdom.

WENDAGE POLLUTION CONTROL LTD (Agent)

Rangeways Farm, Conford, Liphook, Hants UK GU30 7QP

Phone: 44 1428 751296

Fax: 44 1428 751541

Contact: Nigel Mansfield.

Agent for Biolet self-contained electrical compost toilets, in several varieties for home, caravans and portacabins. Also consultants in water, sewage and pollution control.

USA

ADVANCED COMPOSTING SYSTEMS

195 Meadows Road, Whitefish, MT, 59937, USA

Phone: 1 406 862 3855

Fax: 1 406 862 3855

Email: phoenix@compostingtoilet.com

Website: <http://www.compostingtoilet.com>

Contacts: Glenn Nelson, James Conner

Manufactures the Phoenix Composting Toilet, a continuous throughput system featuring odorless, waterless operation, and built-in liquid respray of the composting pile. Very low energy requirements (five watts). Options include microflush toilets, auxillary evaporators, and photovoltaic systems for off-grid installations. Residential and public facility models available.

ALASCAN CLEARWATER SYSTEM

3498 St. Albans Road, Cleveland Heights, OH 44121 USA

Phone: 1 216 382 4151

Contact: David Kern

Email: Drewid@star21.com

Originally developed, tested and supplied in Alaska. The system uses either one cup per flush, or foam flush toilets, and a basement system comprised of one composting tank, one graywater treatment tank, & optional recycling system. System effluents are topsoil & potable water. They have a 15 minute video about the system, available for \$15 US including S&H.

ALASCAN OF MINNESOTA, INC.

8271 - 90th Lane, Clear Lake, MN 55319 USA

Marketing Manager: Jerry L. Carter

Phone: (320) 743-2909

Fax: (320) 743-3509

Email: mail@alascanofmn.com

Website: <http://www.alascanofmn.com>

ARCHITERRA ENTERPRISES, INC.

0186 SCR 1400, BRR, Silverthorne, CO 80498 USA

Phone/Fax: 970-262-6727

Email: natural@colorado.net

Website: <http://thenaturalhome.com>

Catalog: The Natural Home Building Source (24 pages)

We sell and install graywater system packages, and Clivus Multrum and Sun-Mar composting toilet systems.

BIOLET U.S.A.

45 Newbury Street, Boston, MA 02116 USA

Phone: (617) 578-0435

Fax: (617) 578-0465

E-mail: info@biolet.com

Website: <http://www.biolet.com>

Established manufacturer (since 1972) and worldwide supplier of BioLet composting toilets. Self contained, remote and non electric units are available.

BIO-RECYCLER CORP.

5308 Emerald Drive, Sykesville, MD 21784 USA

Phone: 1 410 795-2607

Fax: 1 410 549 1445

Contact: Jeremy Criss

Vermiculture based remote processing unit to which toilet deposits are delivered, using minimal water, by vacuum assisted toilet units. The resultant product is high nutrient worm castings used for soil amendment.

BIO-SUN SYSTEMS INC.

RR#2 Box 134A, Route 549, Jobs Corners, Millerton, PA 16936, USA

Toll free: (800) 847-8840

Phone: 1-717 537 2200

Fax: 1 717 537 6200

Email: bio-sun@ix.netcom.com

Contact: Becky Heffner, Al White

Composting toilet system based on the use of in-situ built tank and intermittent compressed air blown through composting pile.

CENTRE FOR ECOLOGICAL POLLUTION PREVENTION

P.O. Box 1330, Concord, MA 01742-1330 USA

Phone 978-369-9440

Email: cepp@hotmail.com

The CEPP develops, promotes and demonstrates innovative lower-impact technologies and systems, with an emphasis on utilization and zero-discharge approaches. Their most important successes have been the development of low cost net composting systems that are suitable for developing countries and the development of planted treatment systems for graywater utilization.

CLIVUS MULTRUM US

15 Union Street, Lawrence MA, 01840, USA

Phone: 1 978 725 5591;

Toll Free: 1 800 4 CLIVUS

Fax: 1 978 557 9658

Email: forinfo@clivusmultrum.com

Webpage: <http://clivusmultrum.com>

Contact: Don Mills

Sole manufacturer of the Clivus Multrum, original design of inclined base composting toilet. Residential models as well as commercial systems. Also sell toilet buildings and graywater treatment systems.

CLIVUS NEW ENGLAND

P.O. BOX 127, North Andover, MA 01845 USA

Phone: 978-794-9400

Fax: 978-794-9444

CLIVUS MULTRUM GREAT LAKES, INC.

P.O. Box 1025, Ann Arbor, MI 48106 USA

Phone: 734-995-4767

Fax: 734-994-1292

COTUIT DRY TOILET

Conrad Geysler, PO Box 89, Cotuit, Massachusetts 02635 USA

Phone: 508-428-8442

Email: conradg@cape.com

Website: <http://www.cape.com/cdt>

"CTS" TOILET

Composting Toilet Systems, PO Box 1928, Newport, Washington 99156-1928, USA

Phone: 1 509 447 3708;

Toll Free: 888 786 4538

Fax: 1 509 447 3708

Email: cts@povn.com

Contact: Joel Jacobsen

Inclined base composting toilet system built from fibreglass. 5 models offered with NSF International certification. Also offer pre-engineered toilet buildings and agent for Sun-Mar composting toilets.

ECOLOGY SERVICES

PO Box 76, Delafield, WI 53018 USA

Phone/Fax: 262-646-4664

Contact: Mike Mangan

Sell and install composting toilets, graywater systems, and rainwater collection systems. Sunmar and Phoenix toilets.

ECO-TECH/VERA ECOS, INC.

P.O. Box 1313, Concord, MA 01742-1313 USA

Phone: 978-369-3951

Fax: 978-369-2484

Email: watercon@igc.org

Website: <http://www.ecologicalengineering.com>

"Tools for low-water living since 1972." Sell a range of products: EcoTech Carousel compost ECO-TECH/VERA (cont.) ing toilet system, as well as composting toilet models from Vera Toga, BioLet, CTS and Sun-Mar; plans for site-built composting toilets; the Septic Protector, vacuum and micro-flush toilets; Washwater Garden graywater system; and related low-water products. Catalog \$2.

JADE MOUNTAIN INC (Agent)

P.O. Box 4616, 717 Poplar, Boulder, CO 80306, USA

Phone: 1 800 442 1972 or 303 449 6601

Fax: 1 303 449 8266

Email: info@jademountain.com

Website: <http://www.jademountain.com>

You can now download the complete catalog and order online. Supplies a wide range of appropriate technology products (over 6000) and information which includes composting toilets and graywater treatment systems.

LEHMANS HARDWARE AND APPLIANCES (Agent)

One Lehman Circle, P.O. Box 41, Kidron, Ohio 44636, USA

Phone: 330 857 5757

Fax: 330 857 5785

Email: info@lehmans.com

Website: <http://www.lehmans.com>

Agent for Sunmar, Biolet and Alaskan systems. Store and catalogue mail order sales of products for self-sufficiency. "Serving the Amish and others without electricity with products for simple, self sufficient living since 1955."

MOUNTAIN LION TRADING CO. (Agent)

Sales office: 2404 North Columbus Street Spokane, WA 99207-2126, USA

Phone: 1 509-487-0765 (Voice or Fax)

Email: cj@mtlion.com

Website: <http://www.mtlion.com/sunmar>

Sell a range of products including Sunmar composting toilets.

REAL GOODS TRADING CO. (Agent)

555 Leslie St, Ukiah, CA. 95482, USA

Phone: 1 707 468 9292

Fax: 1 707 468 9394

Email: realgoods@realgoods.com

Website: <http://www.realgoods.com>

Sun-mar and Biolet composting toilet agents. Stores in Hopland, CA, Eugene, OR and Amherst, WI.

SMARTER WATER COMPANY

Atlanta, GA USA

Email: email@smarterwater.com

Website: <http://www.smarterwater.com>

Southeastern U.S. distributor of composting toilet systems. Agents for Sunmar composting toilet systems.

SOILTECH (Agent)

607 East Canal St, Newcomerstown, Ohio, 43832-1207, USA

Phone: 1 614 498 5929

Email: soiltech@tusco.net

Website: <http://web.tusco.net/soiltech>

Contact: Kevin Mills; Distributors of Biolet composting toilets. Also have related products including a mulch starter.

SOLAR COMPOSTING ADVANCED TOILETS (S.C.A.T.)

Larry Warnberg, PO Box 43, Nahcotta, WA 98637, USA

Phone: 360-665-2926

Email: warnberg@pacifier.com

The Solar Composting Advanced Toilet - S.C.A.T. - is a freestanding complete toilet facility designed to recycle human excrement and urine into a relatively dry and deodorized compost which can be safely and easily applied to the immediately surrounding landscape. The S.C.A.T. is suitable for recreational campsites, vacation cabins, construction sites, agricultural and nursery settings.

SUN-MAR CORPORATION

600 Main St., Tonawanda, NY 14150-0888 USA

For a Free Catalogue Call: 1 800 461 2461

Email: compost@sun-mar.com

Website: <http://www.sun-mar.com>

SUPER TOILETS USA

John Flaherty, 10 Seaside Place, Norwalk, CT 06855 USA

Phone/Fax: 203-831-9810

OWNER BUILT

APPALACHIA SCIENCE IN THE PUBLIC INTEREST

50 Lair St., Mt. Vernon, KY 40456 USA

Phone: 606 256 0077 (main office)

Fax: 606 256 2779

Email: aspi@kih.net

Website: <http://www.kih.net/aspi>

Contact: Jack Kiefer

ASPI has technical bulletins on composting toilets and constructed wetlands including schematics for a compost toilet which ASPI designed, and for a constructed wetland.

BIG BATCH COMPOSTING TOILET EKAT (East Kentucky Appropriate Technologies)

Executive Director, 150 Gravel Lick Branch Road Dreyfus, KY 40385, USA

Phone: 606 986-6146

Contact: Robert J. Fairchild

Another owner-build system that utilizes readily available materials. It is designed around a large rolling polyethylene dump cart with air pipes of PVC placed into it. Two are used, one 'resting' while the other is filled. EKAT is a non-profit organization which provides engineering assistance with appropriate technology projects to families and groups in central Appalachia. The 'Big batch composting toilet' plans are \$7.

ECO-TECH/VERA ECOS, INC.

P.O. Box 1313, Concord, MA 01742-1313 USA

Phone: 978-369-3951

Fax: 978-369-2484

Email: watercon@igc.org

Website: <http://www.ecologicalengineering.com>

Plans for site-built composting toilets (see previous US listing).

ELEMENTAL SOLUTIONS

Oaklands Park, Newnham-on-Severn Gloucestershire, GL14 1EF, UK

Phone: 01594 516063

Fax: 01594 516821

Email: mark.es@aecb.net

Contact: Mark Moodie

Kits include plans of the chamber recommended for a domestic situation in the UK climate. Includes ceramic pedestal, internal fittings of the tank, water proof 12V or 230V fan (uses ~3W) and power supply where necessary, construction and maintenance manual.

GARRY SCOTT COMPOST TOILET SYSTEMS

Mullumbimby NSW, 2482, Australia

Phone/Fax: 61 2 6684 3468

Email: compost@mullum.com.au

Ownerbuilder assistance with consultation, components, plans and books.

LONG BRANCH ENVIRONMENTAL EDUCATION CENTER

Big Sandy Mush Creek; POB 369; Leicester, NC 28748 USA

Contact: Paul Gallimore, Director

Phone: 828-683-3662

Fax: 828-683-9211

Email: paulg@buncombe.main.nc.us

Website: <http://main.nc.us/LBEEC>

SOLAR COMPOSTING ADVANCED TOILET (S.C.A.T.)

Larry Warnberg, PO Box 43, Nahcotta, WA 98637, USA

Phone: 360 665 2926

Email: warnberg@pacifier.com

Solar composting toilet plans ([see previous US listing](#))

STAN SLAUGHTER 55 GALLON DRUM COMPOST TOILET - GUIDEBOOK AND PLANS

Stan Slaughter, Tall Oak Productions, Pilar Route, Box 11B, Embudo, NM 87531, USA

Phone: 888 484 4477

Fax: 505 758 0201

Website: <http://www.stanslaughter.com>

Also has a great audio tape: Rot N' Roll. Offers music/educational programs and a new card game, "Compost Gin."

"SUNNY JOHN" SOLAR MOLDERING TOILET CONSTRUCTION PLANS - \$20/POSTPAID

John Cruickshank, 5569 North County Road 29, Loveland CO 80538

Email: hobbithouse@compuserve.com

Website: <http://ourworld.compuserve.com/homepages/hobbithouse>

COMPOST THERMOMETERS

REOTEMP

11568 Sorrento Valley Road, Suite 10 San Diego, CA 92121 USA

Phone: 619 481 7737

Toll free: 1-800-648-7737

Fax: 619 481 7415

Email: reotemp@reotemp.com

Website: <http://www.reotemp.com>

BACKYARD COMPOST BINS

COVERED BRIDGE ORGANIC

PO Box 91, Jefferson, OH 44047 USA

Phone: 440 576 5515

GARDNER EQUIPMENT

PO Box 106, Juneau, WI 53039 USA

Toll Free: 800 393 0333

GEDYE COMPOST BINS

555 S. Sunrise Way, Ste. 200, Palm Springs, CA 92262 USA

Phone: 760 325 1035

Fax: 760 778 5383

HARMONIOUS TECHNOLOGIES

PO Box 1716, Sebastopol, CA 95437 USA

Phone: 707 823 1999

Fax: 707 823 2424

Website: <http://www.homecompost.com>

Bins made from 100% recycled plastic.

PALMOR PRODUCTS

PO Box 38, Thorntown, IN 46071 USA

Phone: 800 872 2822

Fax: 765 436 2490

Website: <http://www.trac-vac.com>

PLASTOPAN NORTH AMERICA, INC.

812 E 59th St., Los Angeles, CA 90001 USA

Phone: 323 231 2225

Fax: 323 231 2068

Website: <http://www.plastopan.com>

PRECISION-HUSKY

Equipment Division POD 507, Leeds, AL 35094 USA

Phone: 205 640 5181

Fax: 205 640 1147

Website: <http://www.precisionhusky.com>

PRESTO PRODUCTS CO.

PO Box 2399, Appleton, WI 54913 USA

Phone: 920 738 0986

Fax: 920 738 1458

RECYCLED PLASTICS MARKETING, INC.

2829 152nd Ave. NE, Redmond, WA 98052 USA

Phone: 800 867 3201

Fax: 425 867 3282

Website: <http://www.rrpm.com>

C.E. SHEPHERD CO., INC.

PO Box 9445, Houston, TX 77261 USA

Phone: 713 928 3763

Fax: 713 928 2324

Website: <http://www.ceshepherd.com>

SMITH AND HAWKEN

117 East Strawberry Dr., Mill Valley, CA 94941 USA

Phone: 415 383 4415

Fax: 415 383 8010

Website: <http://www.smithandhawken.com>

SWING AND SLIDE CORPORATION (SHAPE PRODUCTS)

1212 Barberry Dr., Janesville, WI 53545 USA

Phone: 800 888 1232

Fax: 608 755 4763

THE WILMARC CO.

225 W Grant St., Thorntown, IN 46071 USA

Ph: 765 436 7089

Fax: 765 436 2634

COMPOST TESTING LABS

WOODS END AGRICULTURAL INSTITUTE, INC.

PO Box 297, Mt. Vernon, ME 04352 USA

Phone: 207-293-2457

Toll Free: 800-451-0337

Fax: 207-293-2488

Email: info@woodsend.org

Website: <http://www.woodsend.org>

Ascaris and coliform testing as well as full nutrient tests. Sells the Solvita(R) Maturity Test Kit which is now approved in CA, CT, IL, MA, ME, NJ, NM, OH, TX, and WA. Has developed a soil-respiration test kit that is approved by the USDA for soil quality investigations.

WOODS END EUROPE AUC

Agrar und Umwelt-Consult GmbH: Augustastrasse 9 D-53173 Bonn, Germany

Phone: 049 0228 343246

Fax: 049 0228 343237

Officially certified for pathogen survival testing. Sells the Solvita(R) Maturity Test Kit which is now approved in CA, CT, IL, MA, ME, NJ, NM, OH, TX, and WA.

CONTROL LAB. INC.

42 Hangar Way, Watsonville, CA 95076 USA

Phone: 831 724 5422

Fax: 831 724 3188

AUDIO TAPES

ROT 'N ROLL

Stan Slaughter, Tall Oak Productions, Pilar Route, Box 11B, Embudo, NM 87531 USA

Phone: 888 484 4477

Fax: 505 758 0201

Website: <http://www.stanslaughter.com>

SONGS FOR THE COMPOST PILE

Dreams and Bones Performance Company, Jake Weinstein, Rainbow Recycling, 810 State St., New Haven, CT 06511 USA

Phone: 203 865 6507

INTERNET LINKS

EARTHWISE PUBLICATIONS

High Walk House, Kirkby Malzeard, Ripon HG4 3RY England

Phone + 44 01765 658786

Fax on request.

Email: earthwise@earthwise.nwnet.co.uk

World of Composting Toilets: <http://www.compostingtoilet.org>

International Composting Toilet News: <http://www.nwnet.co.uk/earthwise/journal>

Rot Web: http://net.indra.com/~topsoil/Compost_Menu.html

Compost Resource Page: <http://www.oldgrowth.org/compost/humanure.html>

Humanure Forum: http://www.oldgrowth.org/compost/forum_humanure1

Canadian Composting Toilet Website: <http://www.cityfarmer.org/comptoilet64.html#toilet>

Composting council: <http://www.compostingcouncil.org>

Others of interest:

http://www.cfe.cornell.edu/compost/Composting_homepage.html

<http://www.composter.com>

<http://www.history.rochester.edu/class/compost/compost.html>

Vermicomposting:

<http://www.humic.com>

<http://www.worndigest.org>

<http://www.wormwoman.com>

<http://www.vermint.com.au>

<http://www.wormpage.com>

<http://www.allthingsorganic.com>

<http://www.worm-publications.com>

<http://www.vermitechnology.com>

Source: The Humanure Handbook. Jenkins Publishing, PO Box 607, Grove City, PA 16127. To order, phone: 1-800-639-4099.

www.jenkinspublishing.com

[Previous Page](#) | [Top](#) | [Next Page](#)

weblife.org | [library](#) | [Humanure Handbook](#) | [Chapter 6: Composting Toilets and Related Products](#)

Search:

Popular Links

Related Links

Top Sites

Nature Loo

THE AFFORDABLE YET ELEGANT SOLUTION

Our goal is to provide the lowest priced, most environmentally friendly wastewater management system with quality assured performance.

Nature Loo is a family-owned, Australian company that has provided domestic waste solutions since 1994. Our reputation was established with our composting waterless toilets, however we now also offer grey water systems.

Nature Loo toilets are available as a split level system for homes with a minimum of 750mm clearance under the bathroom floor or stand alone single unit toilets for dwellings without underfloor clearance.

We keep designs uncomplicated so that prices and ongoing maintenance costs stay low. Our certification to New Zealand and Australian Standards for Waterless Toilets 1546.2. ensures our products are manufactured to a consistently high standard, as well as being environmentally safe.

Our pedestal designs are elegant as well as functional. We have designs suitable for both modern and traditional bathrooms.

Our grey water systems clean and filter waste water simply and cheaply with the minimum of maintenance. Many councils will permit the reuse of the treated water in sub surface garden irrigation.

The Nature Loo solution is free of odours, chemicals, pollution, pumps and high maintenance costs. It also saves the typical family some 35,000 litres of water per year.

NATURE LOO - IT'S ONLY NATURAL



Split Level system with ceramic pedestal.



Stand alone single unit for low set homes

ROTA-LOO

Thinking beyond the obvious

DID YOU KNOW THAT 20% of all Australian household water used is FLUSHED down the toilet. ROTA-LOO composting toilets DO NOT use any water



Rota-Loo Toilets

Waterless urinals

Mobile Rota-Loo

Rota-Loo 101

The Biolet

Rota-Loo Soltran

Brochures

Buildings

Grey Water Systems

Rota-Loo Dealers

About Us

What others say

Technical Papers

Useful Links

NEWS

- The OnZite worm farm is the natural waste water treatment system and is now available for installation...

[Read all about it](#)

- **Victorian** residents can now get a \$500.00 rebate on the installation of [approved](#) Grey Water systems

- Rota-Loo has always excelled and yet again we have been finalist in the [Savewater Awards](#)



- Royal Geelong Yacht Club helps stem water pollution with the help Environment Equipment [Read More](#)

- See **Rota-Loo installations** and how they work - [Quicktime movies](#)

An Australian Solution to a Global Problem

The Rota-Loo Composting Toilet

Man's inability to control his own waste...

The water which we use today is the same water that was used thousands of years ago by the first inhabitants of the earth, the same water that was created millions of years ago, when our planet came alive. Water, the planet's life blood is recycled again and again for all time. Since the 1800's mankind has slowly transformed our water into a diseased liquid waste. One of the major causes of pollution to our water supply is sewage. It leaches into the ground water, waterways and ultimately our oceans, polluting our environment, killing the life forms and contaminating the food chain.

Research has shown that 50% of all septic tanks don't work properly making the flush toilet possibly the most ecologically destructive invention in the last 200 years.

The average family flushes around 40,000 litres of precious drinking water around the 'S' bend every year. When this water is combined with human waste it is transformed into about eight tonnes of pollution for every man, woman and child each year.

Consider then, the ROTA-LOO composting toilet, it uses no water,

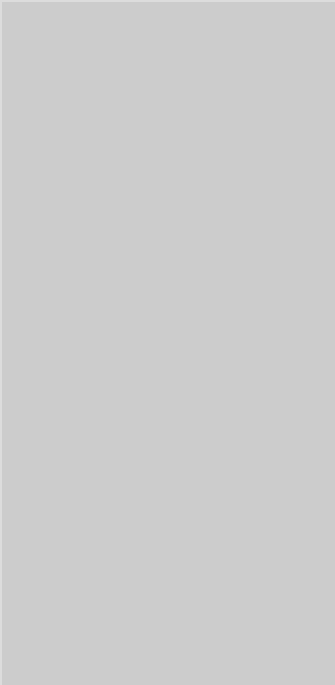

has no odours and only produces about 20 kilograms per year of environmentally safe compost that can be returned to-the earth as fertilizer and soil building humus.

This website is designed and maintained by wherinoz.com.au please report any problems to info@wherinoz.com.au

The ROTA-LOO is a registered name owned by [Environment Equipment Pty Ltd](#) [Victoria Australia](#)



ENVIROLET® SALE!

Save \$250 now on all Envirolet® Composting Toilet Systems! [Click here!](#)



Envirolet® Composting Toilet Systems are the #1 environment-friendly toilet solution.

Envirolet® does not burn, use chemicals or require a septic tank. Ideal for your cottage, cabin, home, business and more.

First time visitor? Get the Envirolet® [catalog](#) sent to you!

Get the [Envirolet® catalog with price list](#) sent to you in the mail free. Usually ships next business day.

Envirolet® Waterless & Low Water [composting toilets](#), manufactured by [Sancor](#) in North America, are available **factory direct** in a choice of non-electric, 12v and 120v. Envirolet® is CSA® [certified](#) to ANSI/NSF® Std-41 and CSA® Electrical, CSA® Plumbing.



Envirolet® MS10

Save \$250!

Use Coupon Code S250

Save until Sept. 27

Save on all complete **envirolet** compost toilet systems*

[Click here!](#)



Envirolet® MS10 (120VAC Electric)

Most efficient self-contained compost toilet system available.

\$1,450.00



[Request Envirolet® Catalog](#)

Get the Envirolet® Composting Toilets [catalog](#) sent to you in the mail. **Free.** Ships next business day.



Envirocycle Composter

Great backyard composter. Now available at a special introductory price!

regular: \$155.00

[envirolet.com:](#)

\$123.00, 2/\$237.00

Save \$250!

Sale!

Save \$250 Now! Use Coupon Code S250. [Click here](#) for details.

Envirolet® & Company News...

- **Envirolet® was chosen to be the toilet by the University of Colorado in the [2005 Solar Decathlon](#) at the Washington Mall. Teams from across North America are competing. U of C is the defending champions!**
- Check out the re-designed [Sancor](#) company web site, located at www.sancorweb.com.
- Envirolet® has been selected for the [Cubes of Good Ideas](#) exhibit during Forum Barcelona 2004 in Spain!
- Envirolet® Waterless Self-Contained Systems are increasingly becoming a popular choice as a [pool cabana toilet](#) solution. Add one to your cabana and keep your house dry!
- Read some recent [Envirolet® customer comments here](#). Send your comments to info@envirolet.com.
- Check out the [Compost Mixer](#), just added to our site!
- We're adding more environment-friendly products all the time. Check out the [Sancor Lawn Store](#).
- Learn about Envirolet® toilets in [Danish](#), [French](#), [German](#), [Norwegian](#), [Polish](#), [Spanish](#) and [Swedish](#)!
- Read more [Sancor company news](#).

- Sale!
- Get Catalog
- Get Video
- The Systems
- How it Works
- Prices
- Parts
- FAQ
- Factory Direct

- Lawn Mowers
- Composters
- Garden
- Low Flush

- Shop Cart
- Privacy Policy
- Search
- About Us

envirolet
Customer Service
USA 1.800.387.5126
CDA 1.800.387.5245

Manufactured by
sancor

[Catalog](#) | [Envirolet® Toilets](#) | [Parts](#) | [Composters](#) | [Lawn Mowers](#)

info@envirolet.com | USA 1.800.387.5126 | Canada 1.800.387.5245 | envirolet.com

©2004, [Sancor](#) Industries Ltd. Envirolet® is a registered [trademark](#).

ENVIROLET® SALE!

Save \$250 now on all Envirolet® Composting Toilet Systems! [Click here!](#)



Envirolet® Composting Toilet Systems are the #1 environment-friendly toilet solution.

Envirolet® does not burn, use chemicals or require a septic tank. Ideal for your cottage, cabin, home, business and more.

First time visitor? Get the Envirolet® [catalog](#) sent to you!

Get the [Envirolet® catalog with price list](#) sent to you in the mail free. Usually ships next business day.

Envirolet® Waterless & Low Water [composting toilets](#), manufactured by [Sancor](#) in North America, are available **factory direct** in a choice of non-electric, 12v and 120v. Envirolet® is CSA® [certified](#) to ANSI/NSF® Std-41 and CSA® Electrical, CSA® Plumbing.



Envirolet® MS10

Save \$250!

Use Coupon Code S250

Save until Sept. 27

Save on all complete **envirolet** compost toilet systems*

[Click here!](#)



Envirolet® MS10 (120VAC Electric)

Most efficient self-contained compost toilet system available.

\$1,450.00



[Request Envirolet® Catalog](#)

Get the Envirolet® Composting Toilets [catalog](#) sent to you in the mail. **Free.** Ships next business day.



[Envirocycle Composter](#)

Great backyard composter. Now available at a special introductory price!

regular: \$155.00

[envirolet.com:](#)

\$123.00, 2/\$237.00

Save \$250!

[Sale!](#)

Save \$250 Now! Use Coupon Code S250. [Click here](#) for details.

Envirolet® & Company News...

- **Envirolet® was chosen to be the toilet by the University of Colorado in the [2005 Solar Decathlon](#) at the Washington Mall. Teams from across North America are competing. U of C is the defending champions!**
- Check out the re-designed [Sancor](#) company web site, located at www.sancorweb.com.
- Envirolet® has been selected for the [Cubes of Good Ideas](#) exhibit during Forum Barcelona 2004 in Spain!
- Envirolet® Waterless Self-Contained Systems are increasingly becoming a popular choice as a [pool cabana toilet](#) solution. Add one to your cabana and keep your house dry!
- Read some recent [Envirolet® customer comments here](#). Send your comments to info@envirolet.com.
- Check out the [Compost Mixer](#), just added to our site!
- We're adding more environment-friendly products all the time. Check out the [Sancor Lawn Store](#).
- Learn about Envirolet® toilets in [Danish](#), [French](#), [German](#), [Norwegian](#), [Polish](#), [Spanish](#) and [Swedish](#)!
- Read more [Sancor company news](#).

- Sale!
- Get Catalog
- Get Video
- The Systems
- How it Works
- Prices
- Parts
- FAQ
- Factory Direct

- Lawn Mowers
- Composters
- Garden
- Low Flush

- Shop Cart
- Privacy Policy
- Search
- About Us

envirolet
Customer Service
USA 1.800.387.5126
CDA 1.800.387.5245

Manufactured by
sancor

[Catalog](#) | [Envirolet® Toilets](#) | [Parts](#) | [Composters](#) | [Lawn Mowers](#)

info@envirolet.com | USA 1.800.387.5126 | Canada 1.800.387.5245 | envirolet.com

©2004, [Sancor](#) Industries Ltd. Envirolet® is a registered [trademark](#).

Advanced Composting Systems

[Home](#)
[About ACS](#)
[Design Features](#)
[Public Facilities](#)
[Applications Planning Guide](#)
[ACS Prefabricated Buildings](#)
[Where Phoenixes Are Found](#)
[Residential](#)
[Request Information](#)
[Download Documents](#)

195 Meadows RD
Whitefish, MT 59937
406-862-3854
Email



Phoenix Composting Toilet System

The odorless and waterless Phoenix composting toilet conserves energy and water, and is friendly to the environment.



[Seven key questions](#) to ask before choosing a composting toilet.

[Phoenix Composting Toilet Sets New Standard.](#) Extensive review from Environmental Building News.

[Phoenix installation at Wild Horse Island.](#) A state of the art facility for Montana's unique water-girt park on Flathead Lake.

[More examples of how and where Phoenixes are employed.](#) The Phoenix is suitable for a wide variety of situations.

- **Odorless.** Positive ventilation system guarantees no bad smells.
- **Waterless.** Ideal where central sewers or septic tanks are uneconomical or environmentally unsound.
- **Treats wastes biologically.** Operates like a garden compost pile, transforming wastes into a stable end product.
- **Easy to install and operate.** Designed for the convenience of the builder and owner.
- **Tough . [High strength, long lasting materials](#)** resist corrosion and defeat vandals and extreme conditions. Lasts a lifetime.
- **Low power requirements.** Draws only 5 watts. Ideal for off-grid installations.
- **Proven in the field.** Respected manufacturer has 28 years of experience building & installing composting toilets.
- **Excellent technical support.** We stand by both our products *and* our customers.

Copyright 2003, [Advanced Composting Systems](#), all rights reserved.



"It may be THE invention of the 20th Century."
- Tom Hanley, Excel



[\[Boat Owners Click Here\]](#)



[\[Cottage Owners Click Here\]](#)



[\[Pool Owners Click Here\]](#)



[\[Home Owners Click Here\]](#)



[\[Resort Owners Click Here\]](#)

World Leader In Home Composting Technology

- ::
- Velkommen**
- :: **Om**
- BOBYG ApS**
- :: **Vinduer &**
- Døre**
- :: **Nybyg &**
- Ombyg**
- ::
- Svampeskader**
- ::
- Billedgalleri:**
- :: **Kontakt**
- os**

Velkommen til vores hjemmeside !

BOBYG ApS ønsker at fremstå som et seriøst og kvalitetsbevidst snedker- og tømrerfirma.

Vi udfører alle tænkelige opgaver indenfor dette omfangsrige håndværksfag. Det kan De læse mere om på denne hjemmeside samt se billeder fra nogle af vore mange projekter.

Vi leverer kvalitetsarbejde til konkurrencedygtige priser, og sørger altid for at overholde alle aftalte betingelser samt leveringstider.

Ring til os for et ganske uforpligtende tilbud !





**Ekolet -
kompostikäymälä
suomeksi**



**Ekolet - the
composting
toilet in
English**



**Biolett
Kompostierendes
WC auf Deutsch**



**ЭКОЛЕТ
-Компостный туалет**



**エコレット
コンポストトイレ
日本語のページ**

WORMS AND DISEASE

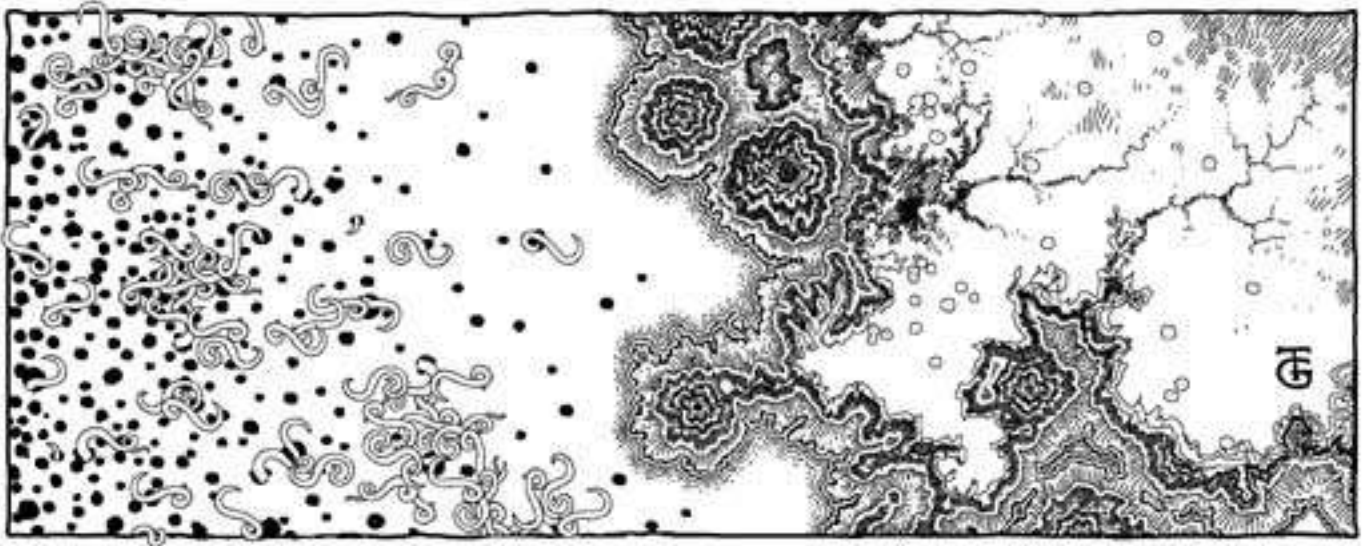

"A well-made compost heap steams like a tea kettle and gets hot enough to destroy all pathogens that may be present when one uses human sewage. An extraordinary device when one thinks about it. Thermophilic bacteria. Bacteria that can live and flourish in temperatures hot enough to cook an egg. How can they survive in such heat? Truly the tricks of nature are extraordinary!"

Robert S. deRopp

I well remember in early 1979 when I first informed a friend that I intended to compost my own manure and grow my own food with it. *"Oh my God, you can't do that!"* she cried.

"Why not?"

"Worms and disease!"

Of course. What else would a fecophobe think of when one mentions using humanure as a fertilizer?

A young English couple was visiting me one summer after I had been composting humanure for about six years. One evening, as dinner was being prepared, the couple suddenly understood the horrible reality of their situation: the food they were about to eat was *recycled shit*. When this "fact" dawned upon them, it seemed to set off some kind of instinctive alarm in their minds, possibly inherited directly from Queen Victoria. *"We don't want to eat shit!"* they informed me (that's an exact quote), as if in preparing dinner I was simply defecating on plates and setting them on the table. Never mind that the food was delicious. It

was the *thought* of it that mattered.

Fecophobia is alive and well and currently afflicting about a billion westerners. One common misconception is that fecal material, when composted, remains fecal material. *It does not.* Humanure comes from the earth, and through the miraculous process of composting, is converted back into earth. When the composting process is finished, the end product is humus, not crap, and it is useful in growing food. My friends didn't understand this; despite my attempts to clarify the matter for their benefit, they chose to cling to their misconceptions. Apparently, some fecophobes will always remain fecophobes.

Allow me to make a radical suggestion: humanure is not dangerous. More specifically, it is not any more dangerous than the body from which it is excreted. The danger lies in what we *do* with humanure, not in the material itself. To use an analogy, a glass jar is not dangerous either. However, if we smash it on the kitchen floor and walk on it with bare feet, we will be harmed. If we use a glass jar improperly and dangerously, we will suffer for it, but that's no reason to condemn glass jars. When we discard humanure as a waste material and pollute our soil and water supplies with it, we are using it improperly, and that is where the danger lies. When we constructively recycle humanure by composting, it enriches our soil, and, like a glass jar, actually makes life easier for us.

Not all cultures think of human excrement in a negative way. For example, swear-words meaning excrement do not seem to exist in the Chinese language. The Tokyo bureau chief for the New York Times explains why: "*I realized why people [in China] did not use words for excrement in a negative way. Traditionally, there was nothing more valuable to a peasant than human waste.*" ¹ Calling someone a "humanure head" just doesn't sound like an insult. "Humanure for brains" doesn't work either. If you told someone they were "full of humanure," they'd probably agree with you. "Shit," on the other hand, is a substance that is widely denounced and has a long history of excoriation in the western world. Our ancestor's historical failure to responsibly recycle the substance caused monumental public health headaches. Consequently, the attitude that humanure *itself* is terribly dangerous has been embraced and promulgated up to the present day.

For example, a recently published book on the topic of recycling "human waste" begins with the following disclaimer: "*Recycling human waste can be extremely dangerous to your health, the health of your community and the health of the soil. Because of the current limits to general public knowledge, [we] strongly discourage the recycling of human waste on an individual or community basis at this time and cannot assume responsibility for the results that occur from practicing any of the methods described in this publication.*" The author adds, "*Before experimenting, obtain permission from your local health authority since the health risks are great.*" The author then elaborates upon a human "waste" composting methodology which includes segregating urine from feces, collecting the manure in 30 gallon plastic containers, and using straw rather than sawdust as a cover material in the toilet.² All three of these procedures are ones I would discourage based on my 20 years of humanure composting experience (no need to go to the bother of segregating urine; a 30 gallon container is way too big and heavy to be able to easily handle; and *sawmill* sawdust does, in fact, work beautifully in a composting toilet. These issues will be thoroughly discussed in the next chapter).

I had to ask myself why an author writing a book on recycling humanure would "*strongly discourage the recycling of human waste,*" which seems counterproductive, to say the least. If I didn't already know that recycling humanure was easy and simple, I might be totally petrified at the thought of attempting such an "*extremely dangerous*" undertaking after reading that book. And the last thing anyone wants to do is get the local health authorities involved. If there is anyone who knows nothing about composting humanure, it's probably the local health authority, who receives no such training. I had to read between the lines of the book to find an explanation.

It seems that the author was somehow associated with the "Bio-Dynamic" agricultural movement, founded by Dr. Rudolf Steiner. Dr. Steiner has quite some following around the world, and many of his teachings are followed almost religiously by his disciples. The Austrian scientist and spiritual leader had his own opinions about the recycling of humanure, based as it were on intuition rather than on experience or science. He insisted that humanure must only be used to fertilize soil used to grow plants to feed animals *other* than humans. The manure from those animals can then be used to fertilize soil to grow plants for human consumption. According to Steiner, humans must *never* get any closer to a direct human nutrient cycle than that. Otherwise, they will suffer "brain damage and nervous disorders." Steiner further warned against using "lavatory fluid," including human urine, which "should never be used as a fertilizer, no matter how well-processed or aged it is." ³ Steiner, quite frankly, was ill-informed, incorrect, and severely fecophobic, and that fecophobia has, unfortunately, rubbed off on some of his followers. It is unfortunate that sensational, fear-motivated warnings regarding humanure recycling continue to be published.

But, it's nothing new, and it has historically been based upon ignorance, which is a widespread problem. At one time, for example, doctors insisted that human excrement should be an important and necessary part of one's personal environment. They argued that, "*Fatal illness may result from not allowing a certain amount of filth to remain in [street] gutters to attract those putrescent particles of disease which are ever present in the air.*" At that time, toilet contents were simply dumped in the street. Doctors believed that the germs in the air would be drawn to the filth in the street and therefore away from people. This line of reasoning so influenced the population that many homeowners built their outhouses attached to their kitchens in order to keep their food germ-free and wholesome.⁴ The results were just the opposite - flies made frequent trips between the toilet contents and the food table.

By the early 1900s, the US government was condemning the use of humanure for agricultural purposes, warning of dire consequences, including death, to those who would dare to do otherwise. A 1928 US Department of Agriculture bulletin made the risks crystal clear: "*Any spittoon, slop pail, sink drain, urinal, privy, cesspool, sewage tank, or sewage distribution field is a potential danger. A bit of spit, urine, or feces the size of a pin head may contain many hundred germs, all invisible to the naked eye and each one capable of producing disease. These discharges should be kept away from the food and drink of [humans] and animals. From specific germs that may be carried in sewage at any time, there may result typhoid fever, tuberculosis, cholera, dysentery, diarrhea, and other dangerous ailments, and it is probable that other maladies may be traced to human waste. From certain animal parasites or their eggs that may be carried in sewage there may result intestinal worms, of which the more common are the hookworm, roundworm, whipworm, eelworm, tapeworm, and seat worm.*"

Disease germs are carried by many agencies and unsuspectingly received by devious routes into the human body. Infection may come from the swirling dust of the railway roadbed, from contact with transitory or chronic carriers of disease, from green truck [vegetables] grown in gardens fertilized with night soil or sewage, from food prepared or touched by unclean hands or visited by flies or vermin, from milk handled by sick or careless dairymen, from milk cans or utensils washed with contaminated water, or from cisterns, wells, springs, reservoirs, irrigation ditches, brooks, or lakes receiving the surface wash or the underground drainage from sewage-polluted soil."

The bulletin continues, *"In September and October, 1899, 63 cases of typhoid fever, resulting in five deaths, occurred at the Northampton (Mass.) insane hospital. This epidemic was conclusively traced to celery, which was eaten freely in August and was grown and banked in a plot that had been fertilized in the late winter or early spring with the solid residue and scrapings from a sewage filter bed situated on the hospital grounds."*

And to drive home the point that human waste is highly dangerous, the bulletin adds, *"Probably no epidemic in American history better illustrates the dire results that may follow one thoughtless act than the outbreak of typhoid fever at Plymouth, Pa., in 1885. In January and February of that year the night discharges of one typhoid fever patient were thrown out upon the snow near his home. These, carried by spring thaws into the public water supply, caused an epidemic running from April to September. In a total population of about 8,000, 1,104 persons were attacked by the disease and 114 died."*

The government bulletin insisted that the use of human excrement as fertilizer was both "dangerous" and "disgusting." It warned that, *"under no circumstances should such wastes be used on land devoted to celery, lettuce, radishes, cucumbers, cabbages, tomatoes, melons, or other vegetables, berries, or low-growing fruits that are eaten raw. Disease germs or particles of soil containing such germs may adhere to the skins of vegetables or fruits and infect the eater."* The bulletin summed it up by stating, *"Never use [human] waste to fertilize or irrigate vegetable gardens."* The fear of human excrement was so severe it was advised that the contents of bucket toilets be burned, boiled, or chemically disinfected, then buried in a trench.⁵

This degree of fecophobia, fostered and spread by authoritative government publications and by spiritual leaders who knew of no constructive alternatives to waste disposal, still maintains a firm grip on the western psyche. It may take a long time to eliminate. A more constructive attitude is displayed by scientists with a broader knowledge of the subject of recycling humanure for agricultural purposes. They realize that the benefits of proper humanure recycling "far outweigh any disadvantages from the health point of view."⁶

Source: The Humanure Handbook. Jenkins Publishing, PO Box 607, Grove City, PA 16127. To order, phone: 1-800-639-4099.

www.jenkinspublishing.com

APPENDIX 3

State Regulations (US), Compiled in 1999: Composting Toilets, Graywater Systems, and Constructed Wetlands

[AL](#) | [AK](#) | [AZ](#) | [AR](#) | [CA](#) | [CO](#) | [CT](#) | [DE](#) | [FL](#) | [GA](#) | [HI](#) | [ID](#) | [IL](#) | [IN](#) | [IA](#) | [KS](#) | [KY](#) | [LA](#) | [ME](#) | [MA](#) | [MD](#) | [MI](#) | [MN](#) | [MS](#) | [MO](#) | [MT](#) | [NC](#) | [NE](#) | [NV](#) | [NH](#) | [NJ](#) | [NM](#) | [NY](#) | [ND](#) | [OH](#) | [OK](#) | [OR](#) | [PA](#) | [RI](#) | [SC](#) | [SD](#) | [TN](#) | [TX](#) | [UT](#) | [VT](#) | [VA](#) | [WA](#) | [WV](#) | [WI](#) | [WY](#) | [CANADA](#) | [OTHER INFO](#)

Notes: 1. Although many states do not have formal design standards or regulations concerning composting toilets, graywater systems, and/or constructed wetlands as they pertain to on-site sewage management for residences, many of the rules and regulations do contain a section allowing “experimental” and/or “alternative” systems which may be permitted by individual application to the regulating agency. Individuals interested in these systems should check with their state agency for more information.

2. When the phrase “no existing regulations,” is used it is not meant to imply that those systems may be used without prior approval from the local or state permitting agency. In all cases, check with your local or state permitting agency to see what their permitting requirements are.

Alabama: Alabama Department of Public Health, Division of Community Environmental Protection, RSA Tower, Suite 1250, PO Box 303017, Montgomery, AL 36130-3017; Ph. (334) 206-5373; Contact: John Paul O’Driscoll.

REGULATION(S): Chapter 420-3-1: Onsite Sewage Disposal and Subdivision-Onsite Sewage Systems, Water Supplies and Solid Waste Management (23 December 1998). Composting Toilets: As of December 23, 1998, no regulations exist for composting toilets.

Composting toilets are not expressly forbidden, but the homeowner does have to show adequate sewage disposal for graywater. Alabama is working on a set of new regulations, as the current rules have been overcome by time, and are not adequate for many of the situations that the regulated community faces today. The main shortcoming of the current regulations is that they do not adequately address the large systems and alternative technologies that are present today.¹ In the proposed regulations, composting toilets are discussed in Chapter 420-3-1-.59 under Non-Waterborne Systems: Pit Privies, Portable, Composting, and Incinerating Toilets. A composting toilet is defined as a dry closet which combines toilet and urinal waste with optional food waste in an aerobic vented environment. Decomposition of the waste is accomplished by the dehydration and digestion of organic matter, yielding a composted residue which is removed for sanitary disposal.² Conditions which justify the use of non-waterborne systems include when soil and site conditions are unsuitable for on-site sewage treatment and disposal systems (OSTDS) or when water under pressure is not available. Composting toilets must meet the standards of the National Sanitation Foundation (NSF), Canadian Standards Association (CSA), Underwriter’s Laboratory, or Warnock Hershey. Other requirements call for continuous ventilation of the components for the storage or treatment of materials. Disposal of the compost must be in accordance with the guidance of EPA Part 503. Disposal of any liquids from the system must be to a sanitary sewer or to an approved OSTDS.

GRAYWATER: Ch. 420-3-1-.03. Defined, graywater is that portion of sewage generated by a water-using fixture or appliance, excluding the toilet and possibly the garbage disposal.³ References to graywater can be found under 402-3-1-.27 Effluent from Clothes Washing Machine and Residential Spa. Water from these systems can circumvent a septic tank and go into a separate effluent disposal field (EDF). In the current regulations, in the absence of water under pressure, graywater shall be disposed of by an effluent distribution line of 50 linear feet per dwelling. Graywater is also covered under the proposed draft of Ch. 420-3-1-.59. No new recommendations besides the EDF system are proposed.

CONSTRUCTED WETLANDS: A constructed wetland is defined in the proposed rules as a human-made, engineered, marsh-like area which is designed, constructed, and operated to treat wastewater by attempting to optimize physical, chemical, and biological processes of natural ecosystems.⁴ However, there are no existing regulations.

Alaska: Alaska Department of Environmental Conservation, Domestic Wastewater Program, 410 West Willoughby Avenue, Suite 105, Juneau, AK 99801; Ph. (907) 465-5324; Fax (907) 465-5362; <http://www.state.ak.us/dec>.

REGULATION(S): 18 AAC 72 Wastewater Disposal (1 April 1999).

COMPOSTING TOILETS: No existing regulations.

GRAYWATER: 18 AAC 72.990. Graywater means wastewater a) from a laundry, kitchen, sink, shower, bath, or other domestic sources; and wastewater b) that does not contain excrement, urine, or combined stormwater. No existing regulations.

CONSTRUCTED WETLANDS: No existing regulations.

Arizona: Arizona Department of Environmental Quality, 3033 North Central Avenue, Phoenix, AZ 85012-2809; Toll-free Ph. (800) 234-5677; Ph. (602) 207-4335; Fax (602) 207-4872; Contact: Nabil Anouti at (602) 207-4723;

http://www.sosaz.com/public_services/Title_18/18-09.htm

REGULATION(S): Arizona Department of Environmental Quality (ADEQ) Bulletin No. 12, Minimum Requirements for the Design and Installation of Septic Tank Systems and Alternative On-site Disposal Systems (June 1989); Arizona Administrative Code Title 18, Ch. 9, Article 7: Regulations for the Reuse of Wastewater (30 September 1998); Arizona Guidance Manual for Constructed Wetlands for Water Quality Improvement (August 1996).

COMPOSTING TOILETS: No regulations. Bulletin 12 suggests the use of composting toilets where conditions are such as to make it impossible or impractical to construct either a septic tank disposal or an earth-pit privy.⁵ Provided they can be maintained and operated without endangering the public health or creating a nuisance, composting toilets may be permitted.⁶

GRAYWATER: Defined under R18-9-701. Graywater means wastewater that originates from clothes washers, dishwashers, bathtubs, showers and sinks, except kitchen sinks and toilets. Under R18-9-703, section C6, graywater from single and multi-family residences may be used for surface irrigation. The design and construction of the system must be approved by the Department. Irrigation sites must be designed to contain a 10-year, 24-hour (i.e., maximum possible) rainfall event and the graywater must fall under the allowable limits of less than 25 colony forming units per 100 milliliters (CFU/ml) fecal coliform and less than 2.0 mg/l chlorine for surface irrigation. Under section 7, formation of a wetlands marsh is allowable reuse of reclaimed wastewater.⁷

CONSTRUCTED WETLANDS: Bulletin 12 describes onsite alternatives to septic tank and drainfield disposal systems. The first general requirement of Bulletin No. 12 is that alternative onsite disposal systems are intended and will be approved for individual lots only where conventional septic tank systems are not suitable and cannot be approved.⁸ Use of a septic tank with a minimum of two compartments for preliminary solids removal is necessary prior to a constructed wetland. Constructed subsurface flow wetlands are viewed as a beneficial augmenting step in the septic tank system, providing additional treatment between the septic tank and the soil absorption system.⁹ The bulletin points out several benefits of segregating blackwater and graywater: 1) conservation of water resources; 2) potential of recycling valuable nutrients to the soil; 3) reuse potential of recycled graywater; and 4) prolonged life of the septic tank soil absorption system.¹⁰ However, until further field data becomes available and is evaluated, graywater treatment and disposal systems shall be designed similarly for typical residential wastewater septic tank soil absorption systems. Under this scenario, it may be possible to reduce the septic tank system capacities, sometimes by one-third.¹¹

Arkansas: Arkansas Department of Health, Sanitary Division, State Health Building, 4815 West Markham, Little Rock, AR 72201; Ph. (501) 661-2171.

REGULATION(S): Alternate Systems Manual published by Environmental Program Services, Division of Environmental Health Protection (April 1993). According to the Alternate Systems Manual, the Arkansas Department of Health encourages studies and submission of plans for alternative methods of treating and disposing of wastes generated by individual residences.¹² However, if site and soil conditions indicate that a standard septic tank and soil absorption system is feasible, no alternative or experimental system will be considered.¹³

COMPOSTING TOILETS: are allowed as long as they are NSF approved. In fact, composting toilets are currently being used in state park systems.¹⁴ A composting toilet is defined as a device specifically designed to retain and process body waste, and, in some cases, household garbage, by biological degradation. The process may be thermophilic or mesophilic, depending on the design of the toilet.¹⁵ Some manufacturers claim the stabilized compost is safe and may be used as a soil additive in gardens. The actual health risks associated with this composted material have not been adequately assessed. The stabilized compost from a composting toilet must be buried onsite or deposited in an approved sanitary landfill. All composting devices must be evaluated by an ANSI approved laboratory under NSF Standard 41.¹⁶ Approved composting toilets for the state of Arkansas include Clivus Multrum models 08, 08-0A, 08-A, 202 and 205; and Sun-Mar Biological Composting Toilet and Sun-Mar-XL. Each application requesting approval of a composting toilet must also provide for the disposal of the home's graywater.¹⁷

GRAYWATER: Essentially, graywater is treated the same as blackwater. The preferred method of handling graywater is through a conventional septic tank and absorption field. A 35% reduction in the absorption field size will be granted. Other methods of treating and/or disposing of graywater will be reviewed on a case by case basis.¹⁸

CONSTRUCTED WETLANDS (ROCK PLANT FILTERS): Rock plant filters (RPFs) provide secondary treatment to septic tank effluent. RPFs act as artificial marshes that rely on microorganisms and the roots of aquatic plants to achieve treatment. RPF systems may be considered on sites where low soil permeability prohibits use of a conventional septic system. Discharge from an RPF must be retained on site, which requires a lot size of at least three acres. This requirement may be waived on repairs to existing, failed septic systems. All off-site discharges must be undergo chlorination prior to discharge.¹⁹

California: California Department of Water Resources, Water Conservation Office, 1020 9th Street, Sacramento, CA 95814; Ph. (916) 327-1655; Contact: Ed Craddock. For Composting Toilets and Constructed Wetlands Regulations, Contact: California Department of Health Services, 724 P Street, Room 1350, Sacramento, CA 95814; Ph. (916) 654 0584; Fax (916) 657-2996.

REGULATION(S): Appendix G. Graywater Systems. Uniform Plumbing Code, Title 24, Part 5, California Administrative Code (18

March 1997).

COMPOSTING TOILETS: No existing regulations, check with your local or county agency. **GRAYWATER:** G-1. General. (b) The type of system shall be determined on the basis of location, soil type, and ground water level and shall be designed to accept all graywater connected to the system from the building. The system shall discharge into subsurface irrigation fields and may include surge tanks and appurtenances, as required by the Administrative Authority. (d) No permit for any graywater system shall be issued until a plot plan with appropriate data satisfactory to the Administrative Authority has been submitted and approved. When there is insufficient lot area or inappropriate soil conditions for adequate absorption of the graywater, as determined by the Administrative Authority, no graywater system shall be permitted. G2. Graywater is untreated wastewater which has not come into contact with toilet waste. Graywater includes used water from bathtubs, showers, bathroom wash basins, clothes washing machines and laundry tubs or an equivalent discharge as approved by the Administrative Authority. It does not include wastewater from kitchen sinks, photo lab sinks, dishwashers, or laundry water from soiled diapers. Surfacing of graywater means the ponding, running off, or other release of graywater from the land surface. G13 Health and Safety. (a) Graywater may contain fecal matter as a result of bathing and/or washing of diapers and undergarments. Water containing fecal matter, if swallowed, can cause illness in a susceptible person. (b) Graywater shall not include laundry water from soiled diapers. (c) Graywater shall not be applied above the land surface or allowed to surface and shall not be discharged directly into or reach any storm sewer system or any water of the United States. (d) Graywater shall not be contacted by humans, except as required to maintain the graywater treatment and distribution system. (e) Graywater shall not be used for vegetable gardens.²⁰

CONSTRUCTED WETLANDS: No existing regulations.

Colorado: Colorado Department of Public Health and Environment, Water Quality Control Division, 4300 Cherry Creek Drive South, Denver, CO 80246-1530; Ph. (303) 692-3500.

REGULATION(S): Guidelines on Individual Sewage Disposal Systems, Chapter 25, Article 10 (1994).

COMPOSTING TOILETS: Composting toilets, according to the Colorado Department of Health, are defined as unit(s) which consist of a toilet seat and cover over a riser which connects to a compartment or a vault that contains or will receive composting materials sufficient to reduce waste by aerobic decomposition.²¹ Composting toilets receive deposits of feces, urine, and readily decomposable household garbage that are not diluted with water or other fluids.²² These deposits are retained in a compartment in which aerobic composting will occur. The compartment may be located within a dwelling or building, provided that the unit complies with the applicable requirements of these guidelines and provided the installation will not result in conditions considered to be a health hazard as determined by the local health department. The effective volume of the receptacle must be sufficient to accommodate the number of persons served. When the receptacle is filled to 75% capacity, residue from the unit shall be disposed of by acceptable solid waste practices. Composting toilets must be NSF approved.²³

GRAYWATER: Graywater systems collect, treat, and dispose of liquid wastes from sinks, lavatories, tubs, showers, and laundry or other approved plumbing fixtures, excluding toilet fixtures.²⁴ Graywater systems shall meet at least all minimum design and construction standards for septic tank systems based on the amount and character of wastes for the fixtures and the number of persons served.²⁵

CONSTRUCTED WETLANDS: are systems which utilize various wetland plants to provide secondary treatment of wastewater through biological, physical, and chemical processes.²⁶ Constructed wetland systems must be designed by a registered professional engineer. Designs have to be site-specific and must include estimates of effluent quality at the inlet and outlet. Periodic sampling is required at the owner's expense.²⁷

Connecticut: Connecticut Department of Public Health, 410 Capitol Avenue, MS #51 SEW, PO Box 340308, Hartford, CT 06134-0308; Ph. (860) 509-7296; <http://www.dep.state.ct.us/dph>.

REGULATION(S): Connecticut Public Health Code: Regulations and Technical Standards for Subsurface Sewage Disposal Systems, Section 19-13-B100 (Conversions, Changes in Use, Additions) (25 October 1976); Section 19-13-B103 (Discharges 5,000 Gallons Per Day or Less) (16 August 1982); and Technical Standards (Pursuant to Section 19-13-B103) (1 January 1997).

COMPOSTING TOILETS: (b)(1) The local director of health may approve the use of a large capacity composting toilet or a heat-assisted composting toilet for replacing an existing privy or a failing subsurface sewage disposal system, or for any single-family residential building where application is made by the owner and occupant, and the lot on which the building will be located is tested by the local director of health and found suitable for a subsurface sewage disposal system meeting all the requirements of Section 19-13-B103d of these regulations. (2) All wastes removed from composting toilets shall be disposed of by burial or other methods approved by the local director of health.²⁸ 19-13-B103f XI. Non-Discharging Sewage Disposal Systems A. Large capacity composting toilets shall have separate receiving, composting, and storage compartments, arranged so that the contents are moved from one compartment to another without spillage or escape of odors within the dwelling. No large capacity composting toilets shall have an interior volume of less than 64 cubic feet. All toilet waste shall be deposited in the receiving chamber, which shall be furnished with a tight self-closing toilet lid. Food waste or other materials necessary to the composting action shall be deposited in the composting compartment through a separate opening with a tight fitting lid. The final composting material shall be removed from the storage compartment through a cleanout opening fitted with a tight door or lid. The cleanout shall not be located in a food storage or preparation area. The receiving and composting compartments shall be connected to the outside atmosphere by a screened vent. The vent shall be a minimum of six inches in diameter and shall extend at least

20 feet above the openings in the receiving and composting compartments, unless mechanical ventilation is provided. Air inlets shall be connected to the storage compartment only, and shall be screened. B. Heat assigned composting toilets shall have a single compartment furnished with a tight, self-closing toilet lid. The compartment shall be connected to the outside atmosphere by a screened vent. There shall be a mechanical ventilation fan arranged to control the humidity in the compartment and provide positive venting of odors to the outside atmosphere at all times. A heating unit shall be provided to maintain temperature in the optimum range for composting.²⁹

GRAYWATER: (n) Graywater means domestic sewage containing no fecal material or toilet wastes. Sec. 19-13-B103d. Minimum Requirements. (f) Gray Water Systems. Disposal systems for sinks, tubs, showers, laundries, and other graywater from residential buildings, where no water flush toilet fixtures are connected, shall be constructed with a septic tank and leaching system at least one-half the capacity specified for the required residential sewage disposal system.³⁰ Sec. 19-13-B103f. Non-discharging Sewage Disposal Systems (a) All non-discharging sewage disposal systems shall be designed, installed, and operated in accordance with the Technical Standards and the requirements of this section, unless an exception is granted by the Commissioner upon a determination that system shall provide for the proper and complete disposal and treatment of toilet wastes or graywater.³¹

CONSTRUCTED WETLANDS: No existing regulations.

Delaware: Department of Natural Resources and Environmental Control, Division of Water Resources, 89 Kings Highway, Dover, DE 19901; Ph. (302) 739-4761.

REGULATION(S): Regulations Governing the Design, Installation and Operation of On-Site Wastewater Treatment and Disposal Systems (4 January 1984).

COMPOSTING TOILETS, GRAYWATER, CONSTRUCTED WETLANDS: No existing regulations. However, a substantial portion of Delaware's population lives where centralized water supply or wastewater treatment services are limited. The Department's mission is to aid and assist the public in the installation of on-site sewage disposal systems, where possible, by utilizing the best information, techniques, and soil evaluations for the most suitable system that site and soil conditions permit. In the past, inadequately renovated wastewater has contaminated Delaware's groundwater and presented a threat to the public health, safety, and welfare. Corrective measures required the replacement of water supply and wastewater systems at a very high cost which was sometimes borne by the general public. In developing these Regulations, the Department operated under the philosophy that where soil and site conditions permit, the least complex, easy to maintain, and most economical system should be used. The Department's policy is to encourage development of systems, processes, and techniques which may benefit significant numbers of people in Delaware.³²

Florida: Florida Department of Health, Bureau of Water and On-Site Sewage Programs, 2020 Capital Circle SE, BIN #A08, Tallahassee, FL 32399-1713; Ph. (850) 488-4070; FAX (850) 922-6969; <http://www.doh.state.fl.us>;

<http://www.dep.state.fl.us/ogc/documents/rules/rulelistpa.htm#wastewater>; Contact: David Hammonds; Email:

David_Hammonds@doh.state.fl.us

REGULATION(S): 381.0065 Florida Statutes Regulations: Chapter 64E-6, Florida Administrative Code, Standards for Onsite Sewage Treatment and Disposal Systems (3 March 1998).

COMPOSTING TOILETS: Although they are not widely used, they are allowed, especially in floodprone areas. Florida encourages the use of composting toilets.³³ 64E-6.009 Alternative Systems. Upon approval by the DOH county health department, alternative systems may, at the applicant's discretion, be used in circumstances where standard subsurface systems are not suitable or where alternative systems are more feasible. Under this section, composting toilets may be approved for use if found in compliance with NSF Standard 41. Graywater and any other liquid and solid waste must be properly collected and disposed of in accordance with Chapter 64E.³⁴ 64E-6.010 Disposal of Sewage. No receptacle associated with an onsite sewage treatment and disposal system shall be cleaned or have its contents removed until the service person has obtained an annual written permit (form DH4013) from the DOH county health department in the county in which the service company is located.³⁵

GRAYWATER: as defined under Title XXIX, Public Health Chapter 381.0065 Onsite Sewage treatment and disposal systems, means that part of domestic sewage that is not blackwater, including the waste from the bath, lavatory, laundry, and sink, except kitchen sink waste.³⁶ Graywater systems are described in Rule 64E-6.013(4).³⁷ When a separate system is installed to dispose of graywater, the retention tank for such systems shall meet certain design standards as specified in Rule 64E-6.008(3): The minimum effective capacity of the graywater retention tank shall be 250 gallons, with such system receiving not more than 75 gallons of flow per day. Where separate graywater and blackwater systems are used, the size of the blackwater system can be reduced by not more than 25%. 10D-6.046 Location and Installation. (7) Onsite graywater tank and drainfield systems may, at the homeowner's discretion, be utilized in conjunction with an onsite blackwater system where a sewerage system is not available for blackwater disposal.³⁸ 10D-6.048 System Size Determination (4) A separate laundry waste tank and drainfield system may be utilized for residences and may be required by the county public health unit where building codes allow for separation of discharge pipes of the residence to separate stubouts and where lot sizes and setback allow system construction. (a) The minimum laundry waste trench drainfield absorption area for slightly limited soil shall be 75 square feet for a one or two bedroom residence with an additional 25 square feet for each additional bedroom. 10D-6.055 (k) All graywater tanks distributed by the state shall be approved for use by the department prior to being installed. Such approval shall be obtained only after the manufacturer of a specific model has submitted engineering designs of the tank. (4) Graywater retention tanks - when a separate system is

installed to dispose of graywater, the retention tank for such system shall meet the following minimum design standards: a) the minimum effective capacity shall be as specified in Rule 10D-6.048(3). Liquid depth shall be at least 30 inches; and b) retention tanks shall be baffled and vented as specified in the septic tank construction standards found elsewhere in the section provided that an inlet tee, ell, or baffle shall be provided for graywater tanks.³⁹

CONSTRUCTED WETLANDS: No existing regulations.⁴⁰

Georgia: Department of Human Resources, Division of Public Health, Environmental Health Section, 5th Floor-Annex, 2 Peachtree Street NW, Atlanta, GA 30303-3186; Ph. (404) 657-2700 or 6538; FAX (404) 657-6533; <http://www.ganet.org/dnr/environ/rules>;

Contact: Warren Abrahams, Program Consultant.

REGULATION(S): Rules of Department of Human Resources, Public Health, Chapter 290-5-26: Onsite Sewage Disposal Management Systems (20 February 1998).

COMPOSTING TOILETS: Where the availability of land for installation of conventional septic tank systems is limited so as to allow for only a septic tank and a reduced size absorption system, composting toilets may be considered. Laundry, bath, and kitchen wastes must be disposed of in a conventional septic tank system, although the size of the absorption field may be reduced by 35% from that of a conventional system, provided water conservation devices are utilized. Composted wastes from the treatment unit shall be removed as per the manufacturer's recommendations and the residue shall be buried by covering with at least six inches of soil. Wastes should not be used as fertilizer for root or leaf crops which may be eaten raw. Composting toilets must be certified by the NSF as meeting the current standard or certified by the manufacturer as meeting a nationally recognized standard for such purpose.⁴¹

GRAYWATER: Graywater means wastewater generated by water-using fixtures and appliances, excluding water closets, urinals, bidets, kitchen sinks, and garbage disposals. Chapter 290-5-59, Special Onsite Sewage Management Systems, defines sewage as human excreta, all water-carried wastes, and/or liquid household waste including graywater from residences or similar wastes or by-products from commercial and industrial establishments.⁴² Where a separate graywater system is to be used, the minimum effective capacity of the graywater retention tank shall be 500 gallons. The minimum absorption area for graywater or blackwater absorption systems serving residential properties shall be based on the number of bedrooms and the percolation rate. The blackwater portion of the total daily sewage flow shall be 35%; the graywater portion shall be 65%.⁴³

CONSTRUCTED WETLANDS: No existing regulations. Although no regulations are formally in place, an article in the Georgia Environmentalist gives design information and recommendations for both free water surface (FWS) and subsurface flow (SSF) constructed wetlands.⁴⁴

Hawaii: Department Of Health, Wastewater Branch, Environmental Management Division, 919 Ala Moana Boulevard, Suite 309, Honolulu, HI 96814; Ph. (808) 586-4294.

REGULATION(S): Hawaii Administrative Rules, Chapter 11-62 (30 August 1991).

COMPOSTING TOILETS: 11-62-03 Definitions. "Compost toilet" means a non-flush, waterless toilet that employs an aerobic composting process to treat toilet wastes.⁴⁵ Ch. 11-62-35 states that specific design requirements for composting (and other) toilets shall be reviewed and approved by the director on a case-by-case basis.⁴⁶ Products, if sold in Hawaii, are to be approved by the director, based on appropriate testing procedures and standards as set forth by the National Sanitation Foundation (NSF) Testing Laboratory.⁴⁷ The following toilets are approved the NSF Standard 041: Biolet XL; Clivus Multrum Model M-1, M-2, M-12, M-15, M-18, M-22, M-25, M-28, M-32, M-35, M54ADA; Ecotech Carousel; and Sun Mar Excel.

GRAYWATER: means liquid waste from a dwelling or other establishment produced by bathing, washdown, minor laundry, and minor culinary operations, and specifically excluding toilet waste.⁴⁸ Chapter 11-62-31.1 states that individual wastewater systems may be used as a temporary on-site means of wastewater disposal in lieu of wastewater treatment works in residential developments when there is 10,000 square feet or more of land area for each individual wastewater system.⁴⁹ Section G covers graywater systems and their respective design characteristics.⁵⁰ Graywater conveyance systems include: sand filters, absorption trenches and beds, mounds or seepage pits, or when disinfected in accordance with 11-62-26(b) (which governs total coliform levels), used for irrigation.⁵¹ 11-62-31.1 gives the general requirements for proposed individual wastewater systems. (g) A graywater system shall be designed in accordance with the following criteria: (1) design of graywater systems for dwelling units shall be based on a minimum graywater flow of 150 gallons per day per bedroom; and (2) graywater tanks, when required, shall be sized with no less than a 600 gallon capacity and shall conform to the requirements of section 11-62-33-1(a).⁵²

CONSTRUCTED WETLANDS: No existing regulations.

Idaho: Division of Environmental Quality, 1410 North Hilton, Boise, ID 83706-1255; Ph. (208) 373-0502. Contact: Barry Burnell, Watershed Protection Supervisor.

REGULATION(S): IDAPA 16, Title 01, Chapter 03, Rules for Individual/Subsurface Sewage Disposal Systems (7 May 1993) and the Technical Guidance Manual (TGM) for Individual Subsurface Sewage Disposal Systems. The TGM can be viewed at http://www.state.id.us/phd1/tgm/tgm_toc.html Section 10 of the Idaho code covers Alternative Systems. If a standard system as described in the rules cannot be installed on a parcel of land, an alternative system may be permitted if that system is in accordance with the

recommendations of the Technical Guidance Committee and is approved by the Director.⁵³

COMPOSTING TOILETS: are defined as toilets within the dwelling that store and treat non-water carried human urine and feces and small amounts of household garbage by bacterial decomposition. The resultant product is compost.⁵⁴ Composting toilets are allowed in residences that also have water under pressure, with the understanding that a public sewer or another acceptable method of on-site disposal is available. Permission must be obtained from the Idaho Health Department, as current plumbing code prohibits the use of composting toilets without their permission.⁵⁵

GRAYWATER: The Technical Guidance Manual contains a draft for graywater system guidelines and design requirements, but current Idaho rules permit graywater systems only as experimental systems.⁵⁶ The draft proposal describes graywater as untreated household wastewater that has not come into contact with toilet waste. Graywater includes used water from bathtubs, showers, bathroom wash basins, and water from clothes washing machines and laundry tubs. It shall not include wastewater from kitchen sinks, dishwashers, or laundry water from soiled diapers. A graywater system consists of a separate plumbing system from the blackwater and kitchen plumbing, a surge tank to temporarily hold large drain flows, a filter to remove particles that could clog the irrigation system, a pump to move the graywater from the surge tank to the irrigation field, and an irrigation system to distribute the graywater. Graywater may not be used to irrigate vegetable gardens. Graywater systems may only be permitted for individual dwellings. The capacity of the septic tank and size of the blackwater drainfield and replacement area shall not be reduced by the existence or proposed installation of a graywater system servicing the dwelling. Graywater shall not be applied on the land surface or be allowed to reach the land surface.⁵⁷

CONSTRUCTED WETLANDS: Constructed wetlands are only permitted under experimental systems. All experimental systems require a variance. Experimental systems also are required to be designed by a Idaho licensed professional engineer.⁵⁸

Illinois: Illinois Department of Public Health, Division of Environmental Health, 525-535 West Jefferson Street, Springfield, IL 62761-0001; Ph. (217) 782-5830; Contact: Elaine Beard or Doug Ebelherr.

REGULATION(S): Title 77: Public Health, Chapter I: Department of Public Health, Subchapter r: Water and Sewage, Part 905: Private Sewage Disposal Code, Section 905.30, Approved Private Sewage Disposal Systems (15 March 1996).

COMPOSTING TOILETS: are approved for private sewage disposal of human wastes.⁵⁹ Compost toilets shall be designed in accordance with the manufacturer's recommendation to serve the anticipated number of persons. The owner of a compost toilet shall maintain the toilet and dispose of the contents in accordance with Section 905.170, which lists several methods of disposal: 1) discharge to a municipal sanitary sewer system; 2) discharge to sludge lagoons or sludge drying beds; 3) discharge to an incinerator device; or 4) discharge to a sanitary landfill.⁶⁰ Compost toilets shall comply with the requirement of the NSF Standard 41 and shall bear the NSF Seal.⁶¹

GRAYWATER, CONSTRUCTED WETLANDS: No existing regulations (governed under experimental systems).

Indiana: Indiana Department of Environmental Management, 100 North Senate Avenue, PO Box 6015, Indianapolis, IN 46206-6015; Ph. (317) 233-7179 or (317) 233-7188; Contact: Alan Dunn or Tim Decker; Email: adunn@ISDH.state.in.us.

REGULATION(S): Regulations, if they existed, would most likely be found under 401 Indiana Administrative Code 6-8.1.

COMPOSTING TOILETS, GRAYWATER: No existing regulations.

CONSTRUCTED WETLANDS: Constructed wetlands are approved only for experimental use in residential situations. Indiana outlines some basic design criteria for subsurface constructed wetlands, as follows: 1) The wetland is usually designed for five to seven days retention time; 2) Each wetland has one cell for residential projects, with each cell having a length to width ratio of no greater than 2:1; 3) The depth of gravel in the wetland is no greater than 24 inches; 4) There are three different gravel sizes in the wetland. The inlet and outlet ends of the wetland have coarse gravel in the range of 1 1/2 to 3 inches in size. The area between the ends has gravel in the range of 1/2 to 1 inch in size. The surface layer of gravel over the entire wetland is usually six inches in depth with a range of 3/8 to 1/2 inch size (pea gravel). All gravels are screened and washed to remove fines; 5) The water level in the wetland is set at a depth of two to three inches below the surface of the gravel by the outlet adjustable sump pipe. The outlet sump pipe is orificed with a 1 1/2 inch hole to regulate the flow from the wetland after a six inch rainfall event to spread the rainfall accumulation over a 24-hour period; 6) The wetlands are lined with at least a 20 mil liner for residential projects; 7) The wetland is tested for leaks over a 24-hour period with at least six inch depth of water above the inlet and outlet distribution and collection pipe; 8) The inlet distribution and outlet collection pipes for each cell of the wetland are placed at the bottom of the wetland gravel; 9) Some commonly used wetland plants are cattails (*Typha* sp.) and bulrushes (*Scirpus* sp.) along with other appropriate species. The shallower rooted plants are located near the inlet because of the higher influent temperatures and high nutrient levels, with deeper rooted plants located toward the end of the wetland; and 10) There is required monitoring at the inlet and outlet ends of the wetland for three to five years. Absorption field criteria: 1) Selection and sizing of the absorption field is always based upon the peak daily wastewater load and the on-site soil survey report that is done by an ARCPAC certified soil scientist, in the area of the absorption field; 2) There is an allowable reduction in the size of the absorption field associated with a subsurface constructed wetland based on the soil loading rate. For soil loading rates equal to or greater than 0.5 gallons per day (GPD) per square foot, but less than or equal to 1.2 GPD per square foot, the allowable reduction in field size is 50%. For soil loading rates of less than 0.5 GPD per square foot but greater than or equal to 0.25 GPD per square foot, the allowable reduction in the field is 33%; 3) There must be a 50 to 100% set aside area for the proposed absorption field associated with the subsurface constructed wetland because this combination is still considered experimental when there is an allowable absorption field size reduction; and 4) The septic

tanks are sized for either a 36 or 48 hour detention time.⁶²

Iowa: Iowa Department of Natural Resources, Wallace State Office Building, 502 East 9th Street, Des Moines, IA 50319-0034; Ph. (515) 281-7814; Contact: Brent Parker.

REGULATION(S): Chapter 69: On-Site Wastewater Treatment and Disposal Systems 567-69.11(455B).

COMPOSTING TOILETS, GRAYWATER: No existing regulations. Constructed wetlands: are governed under 69.1(2). "On-site wastewater treatment and disposal system" means all equipment and devices necessary for proper conduction, collection, storage, treatment, and disposal of wastewater from four or fewer dwelling units or other facilities serving the equivalent of 15 persons (1,500 gpd) or less. This includes domestic waste, whether residential or nonresidential, but does not include industrial waste of any flow rate. Included within the scope of this definition are building sewers, septic tanks, subsurface absorption systems, mound systems, sand filters, constructed wetlands and individual mechanical/aerobic wastewater treatment systems. 567---69.11(455B) Constructed wetlands. 69.11(1) Constructed wetlands shall only be used where soil percolation rates at the site exceed 120 minutes per inch. Because of the higher maintenance requirements of constructed wetland systems, preference should be given to sand filters, where conditions allow. b). The effluent from a constructed wetland shall receive additional treatment through the use of intermittent sand filters of a magnitude of half that prescribed in rule 69.9(455B). c) Effluent sampling of constructed wetlands shall be performed twice a year or as directed by the administrative authority. Tests shall be run on all parameters as required in 69.9(1). d). Specifications given in these rules for constructed wetlands are minimal and may not be sufficient for all applications. Technical specifications are changing with experience and research. Other design information beyond the scope of these rules may be necessary to properly design a constructed wetland system. 69.11(2) a). The wetland shall be of a subsurface flow construction with a rock depth of 18 inches and a liquid depth of 12 inches. b). Substrate shall be washed river gravel with a diameter of 3/4 inch to 2½ inches. If crushed quarried stone is used, it must meet the criteria listed in 69.6(4)"a." c). Detention time shall be a minimum of seven days. (1) This may be accomplished with trenches 16 to 18 inches deep (12 inches of liquid), three feet wide with 100 feet of length per bedroom. This may also be done with beds 16 to 18 inches deep, with at least 300 square feet of surface area per bedroom. The bottom of each trench or bed must be level within ±½ inch. (2) Multiple trenches or beds in series should be used. Beds or trenches in series may be stepped down in elevation to fit a hillside application. If the system is on one elevation, it should still be divided into units by earthen berms at about 50 and 75% of the total length. (3) Each subunit shall be connected to the next with an overflow pipe (rigid sewer pipe) that maintains the water level in the first section. Protection from freezing may be necessary. d). Wetlands shall be lined with a synthetic PVC or PE plastic liner 20 to 30 mils thick. e). Effluent shall enter the wetland by a four inch pipe sealed into the liner. With beds, a header pipe shall be installed along the inlet side to distribute the waste. f). Wetland system sites shall be bermed to prevent surface water from entering the trenches or beds. 69.11(3) Vegetation shall be established on the wetlands at time of construction. Twelve inches of rock is placed in each unit, the plants are set, then the final four to six inches of rock is placed. b). Only indigenous plant species shall be used, preferably collected within a 100-mile radius of the site. Multiple species in each system are recommended. Preferred species include, but are not limited to: (1) *Typha latifolia* - Common cattail; (2) *Typha angustifolia* - Narrow leaf cattail; (3) *Scirpus* spp. - Bullrush; (4) *Phragmites communis* - Reed. Transplantation is the recommended method of vegetation establishment. For transplanting, the propagule should be transplanted, at a minimum, on a two-foot grid. The transplants should be fertilized, preferably with a controlled release fertilizer such as Osmocote 18-5-11 for fall and winter planting, 18-6-12 for spring planting, and 19-6-12 for summer planting. Trenches or beds should be filled with fresh water immediately. d). In the late fall, the vegetation shall be mown and the detritus left on the wetland surface as a temperature mulch. In the early spring, the mulch shall be removed and disposed of to allow for adequate bed aeration.⁶³

Kansas: Department of Health and Environment, Bureau of Water, Nonpoint Source Section, Forbes Field, Building 283, Topeka, KS 66620; Ph. (785) 296-4195 or 1683.

REGULATION(S): No existing regulations. If regulations existed, they should fall under the Kansas Administrative Regulations (KAR) Chapter 25, Article 5, Sewage and Excreta Disposal.

COMPOSTING TOILETS, GRAYWATER, CONSTRUCTED WETLANDS: No existing regulations. Bulletin 4-2, Minimum Standards for Design and Construction of Onsite Wastewater Systems (March 1997) mentions alternative systems when conventional absorption fields or ponds are not suitable.⁶⁴ K.A.R. 28-5-9 gives authority to county health departments, in counties that have local codes, to grant variances for alternative onsite wastewater treatment and disposal systems. The variance request is filed with the county administrative agency.⁶⁵

Kentucky: Department for Public Health, Division of Public Health Protection and Safety, Environmental Management Branch, Community Environment Section, 275 East Main Street, Frankfort, KY 40621; Ph. (502) 564-4856; FAX (502) 564-6533; Contact: Craig Sheehan, R.S., Health Inspection Program Evaluator; Email: Craig.sheehan@mail.state.ky.us REGULATION(S): 902 Kentucky Administrative Regulations 10:085 Kentucky Onsite Sewage Disposal Systems (September 1989).

COMPOSTING TOILETS: are mentioned under 1b, 8. System Sizing Standards. When approved permanent non-water carriage water closet type devices (composting toilets, incinerator toilets, oil carriage toilets, etc.) are installed exclusively in any residence and no other blackwater type wastes are created, the daily design flow unit for that specific residence may be reduced.⁶⁶

GRAYWATER: in Section 2(13) means wastewater generated by water-using fixtures and appliances, excluding the toilet and the garbage disposal.⁶⁷ Graywater standards are mentioned under 13a-c, 8. When improved performance (of a septic system) may be attained by separating laundry graywater waste flows from other residential waste flow for new system installations, or as repair for existing systems, such separation shall be accomplished in the following manner: a) Graywater sewer for the washing machine shall be separated from the main house sewer; b) laundry graywater shall discharge into a lateral bed or trench(es) of a minimum of 100 square feet of bottom surface soil absorption area for a two bedroom residence and an additional 50 square feet for each additional bedroom; c) new system installations where laundry wasteflow separation exists are permitted a 15% reduction in the primary system lateral field requirements shall be allowed only for sites with soils in Soil Groups I-III. On sites with soils in Soil Group IV, such separation may be required, but no system size reduction will be granted.⁶⁸

CONSTRUCTED WETLANDS: or plant-rock filters generally consist of a primary treatment unit, usually a septic tank with two compartments or special filters, with a lined rock bed or cell containing approximately 12 inches of rock and a small overflow lateral field. Aquatic plants are planted in the rock media and treat the effluent to a very high degree. Any excess effluent is disposed of in the lateral field. Wetlands are sized based on 1.3 cubic feet of gravel area for each one gallon of total daily waste flow. A typical size for a three bedroom home would be 468 square feet of interior area. Various length to width ratios are acceptable with generally a relatively narrow width to longer length preferable. The system functions primarily by wastewater entering the treatment unit where some treatment occurs. The partially treated wastewater then enters the lined wetlands cell through solid piping where it is distributed across the cell. The plants within the system act to introduce oxygen into the wastewater through their roots. As the wastewater becomes oxygenated, beneficial microorganisms and fungi can thrive, where they in turn digest organic matter. In addition, fairly large amounts of water may be lost through evapotranspiration. Advantages of installing a constructed wetlands system are that they: 1) are space conservative (approximately 1/3 of conventional rock lateral); 2) can be placed on irregular or segmented lots; and 3) may be placed in areas with shallow water tables, high bedrock or restrictive horizons. Disadvantages include that constructed wetlands systems: 1) require a higher level of maintenance than other conventional systems; 2) may be more costly to install; and 3) have an unknown life span.⁶⁹

Louisiana: Department of Health and Hospitals, Office of Public Health, Sanitation Services, 106 Canal Blvd., Thibodaux, LA 70301; Ph. (504) 449 5007; Contact: Teda Boudreaux.

COMPOSTING TOILETS, GRAYWATER SYSTEMS, CONSTRUCTED WETLANDS: No existing regulations.⁷⁰

Maine: Department of Human Services, Bureau of Health, Division of Health Engineering, Wastewater and Plumbing Control Program, State House Station 10, Augusta, ME 04333-0010; Ph. (207) 287-5689.

REGULATION(S): Maine Subsurface Waste Water Disposal Rules 144A CMR 241(20 January 1998).

COMPOSTING TOILETS: are regulated in Ch. 15, Section 1504.0. A composting toilet is designed to receive, store, and compost human wastes. Stabilized (that is, composted) wastes shall be removed for disposal when the toilet's capacity is reached. The minimum interior volume of a composting toilet shall be large enough to allow complete stabilization of all wastes when the toilet is used continuously at its proposed usage level. Toilet wastes shall be deposited into a receiving area with a self-closing, tightly fitting lid. There shall be a separate access, with a tightly fitting lid, through which food wastes, or other materials needed for the composting process, are routed to the composting compartment. Composted material shall be removed from the storage area through a cleanout opening fitted with a tight door or lid. Non cleanout may be located in a food storage or preparation area. Any liquid overflow shall be discharged to a primitive or conventional disposal field. The contents of an alternative toilet shall be removed and disposed of in a legal and sanitary manner whenever they reach recommended capacity of the alternative toilet.⁷¹

GRAYWATER: 1509.0 Separated Laundry Disposal Systems. The plumbing inspector may approve a separate laundry system for single-family dwelling units. A separated laundry field requires an application for subsurface waste water disposal system completed by a licensed site evaluator and a permit to install the system. Only waste water from a washing machine may be discharged to the separate laundry disposal field designed for that purpose. Separate laundry disposal fields may be designed and used for hot tubs or backwash water. A separated laundry disposal field does not require a septic tank.⁷²

CONSTRUCTED WETLANDS: No existing regulations.

Maryland: Maryland Department of the Environment, Water Management Administration, 2500 Broening Highway, Baltimore, MD 21224; Ph. (410) 631-3778.

REGULATION(S): Regulations may be discussed under Chapter 9, Subtitle 14A. Waterless Toilets (1993).

COMPOSTING TOILETS: Waterless toilets are covered in Chapter 9, Subtitle 14A-01. Waterless Toilets The Maryland Department of the Environment does not prohibit the use of any NSF approved composting toilet for use anywhere in the State. The Department's current regulation is to allow a 36% design flow reduction for residences when utilizing an NSF approved composting/waterless toilet.⁷³

GRAYWATER: Innovative graywater designs are currently allowed on a case-by-case basis under the Innovative and Alternative Program.⁷⁴

CONSTRUCTED WETLANDS: No existing regulations.

Massachusetts: Department of Environmental Protection, Division of Water Pollution Control, One Winter Street, 8th Floor, Boston, MA 02108; Ph. (617) 292-5500; <http://www.magnet.state.ma.us/dep/brp/wwm/wwwhome.htm>; Contact: Doug Roth; Email:

douglas.roth@state.ma.us For graywater, contact: Ruth Alfasso, graywater piloting coordinator; Email: Ruth.Alfasso@state.ma.us

REGULATION(S): 310 CMR 15.000, Title 5: Innovative and Alternative Subsurface Sewage Disposal Technologies Approved for Use in Massachusetts (4 March 1998).

COMPOSTING TOILETS: are certified for general use for new construction and for remedial use. Specific regulations concerning composting toilets follow: 1) compost temperature must be maintained above 131 degrees F (55 degrees C); 2) moisture must be maintained between 40-60% for best results; and 3) the system must be designed to store compostable and composted solids for at least two years, either inside the composting chamber or in a separate compost container. Compost must be disposed by one of two methods: 1) by on-site burial, covered with a minimum of six inches of clean compacted earth; or 2) by a licensed septage hauler. If any liquid by-product exists, it should be discharged through a graywater system that includes a septic tank and leaching system or removed by licensed septic hauler.⁷⁵

GRAYWATER: If the facility generates graywater (i.e., wastewater from sinks, showers, washing machines, etc.) a disposal system is still needed for the graywater. Title 5 has different requirements for remedial use and for new construction. Remedial use is for facilities which have a design flow of less than 10,000 gallons per day, are served by an existing system, and where there is no proposed increase in the design flow. An existing cesspool may be used as a leaching pit, provided that the cesspool is pumped and cleaned and is not located in groundwater, and meets the design criteria of 310 CMR 15.253 with respect to effective depth, separation between units, and inspection access. The cesspool may be replaced by a precast concrete leaching pit meeting those requirements, and the effluent loading requirements of Title 5. A septic tank should also be installed. Pertaining to graywater, a filter system specifically approved by the Department can be used instead of a septic tank.⁷⁶ Non-traditional graywater systems, such as those which use constructed wetlands or evapotranspiration beds, are approved on a piloting, site-specific basis.⁷⁷

CONSTRUCTED WETLANDS: No existing regulations, approved on a piloting basis only.⁷⁸

Michigan: Department of Environmental Quality, Environmental Health Section, Drinking Water and Radiological Protection Division, PO Box 30630, Lansing, MI 48909-8130; Toll-free Ph. (800) 662-9278; Ph. (517) 335-8284.

REGULATION(S): Michigan has one of the oldest existing guidelines for composting toilets and graywater systems. However, as there is no statewide sanitary code, the 46 local health departments define the criteria for onsite sewage disposal and "each county runs its own show."⁷⁹ The Michigan Department of Health publishes Guidelines for Acceptable Innovative or Alternative Waste Treatment Systems and Acceptable Alternative Graywater Systems under authority of Act 421, P.A. 1981 (1986). Under Act 421, an owner of a structure using an acceptable an innovative or alternative waste treatment system (heretofore referred to as "alternative systems") in combination with an acceptable alternative graywater system (heretofore referred to as "graywater systems") shall not be required to connect to an available public sanitary sewer system.⁸⁰ Alternative system means a decentralized or individual waste system which has been approved for use by a local health department and which is properly operated and maintained so as to not cause a health hazard or nuisance. An acceptable alternative system may include, but is not limited to, an organic waste treatment system or composting toilet which operates on the principle of decomposition of heterogenous organic materials by aerobic and facultative anaerobic organisms and utilizes an effectively aerobic composting process which produces a stabilized humus. Alternative systems do not include septic tank-drainfield systems or any other systems which are determined by the department to pose a similar threat to the public health, safety and welfare, and the quality of surface and subsurface waters of this state.⁸¹ A person may install and use in a structure an alternative system or an alternative system in combination with a graywater system. The installation and use of an alternative system or an alternative system in combination with a graywater system in a structure shall be subject to regulations by the local health department in accordance with the ordinances and regulations of the local units of government in which the structure lies. A local health department may inspect each alternative system within its jurisdiction at least once each year to determine if it being properly operated and maintained. 1) A local health department may charge the owner of an alternative system a reasonable fee for such an inspection and for the plan review and installation inspection. 2) The department shall maintain a record of approved alternative systems and their maintenance and adoption. The department, after consultation with the state plumbing board, shall adopt guidelines to assist local health departments in determining what are graywater systems and what are alternative systems. The department shall advise local health departments regarding the appropriate installation and use of alternative systems and alternative systems in combination with graywater systems. 3) A person who installs and uses an alternative system or an alternative system in combination with a graywater system shall not be exempt from any special assessments levied by a local unit of government for the purpose of financing the construction of an available public sanitary sewer system. 4) An owner of a structure using an alternative in combination with a graywater system shall not be required to connect to an available public sanitary sewer system.⁸²

GRAYWATER: system means a system for the treatment and disposal of wastewater which does not receive human body wastes or industrial waste which has been approved for use by a local health department and which is properly operated and maintained so as not to cause a health hazard or nuisance.⁸³ Structures which utilize alternative systems and graywater systems which are self-contained systems that do not have an on-site discharge should not be required to connect to an available public sanitary sewer system.⁸⁴ Alternative systems must meet the requirements of Sections 5 (6) and 21 of the Michigan Construction Code, act 230, Public Acts of 1972 as amended.

Structures using alternative systems must also meet the requirements of the Michigan Plumbing Code.⁸⁵ Alternative systems and graywater systems should be tested by the National Sanitation Foundation (NSF) under Standard 41 testing protocol or by an equivalent independent testing agency and procedure. Lacking this testing procedure, the local health department should require performance data prior to approval. When requested, the Michigan Department of Public Health will assist local health departments in evaluating performance data from the NSF and other sources. Each local health department should require appropriate methods for disposal of stored liquid or solid end products from alternative systems.⁸⁶ To the extent that funds are available, the department will provide training and technical field assistance to local health departments regarding the appropriate installation and use of alternative systems and graywater systems.⁸⁷ A person may petition, in writing, the commission to approve the use of a particular material, product, method of manufacture or method or manner of construction or installation. On receipt of the petition, the commission shall cause to be conducted testing and evaluation it deem desirable. After testing and evaluation, and an open public hearing, the commission may reject the petition in whole or in part, may amend the code in such matter as the commission deems appropriate, or may grant a certificate of acceptability.⁸⁸

CONSTRUCTED WETLANDS: The Department of Environmental Quality provides a document entitled Review of Subsurface Flow Constructed Wetlands Literature and Suggested Design and Construction Practices. Constructed wetlands are run through a primary septic tank and then through a subsurface disposal system.⁸⁹ In fact, this guide recommends that at least two septic tanks should be provided with a total volume of at least two times the design daily flow.⁹⁰

Minnesota: Minnesota Pollution Control Agency, Water Quality Division, Nonpoint Source Compliance Section, 520 Lafayette Road, St. Paul, MN 55155-4194; Ph. (612) 296-7574; <http://www.revisor.leg.state.mn.us/arule/7080>

REGULATION(S): Chapter 7080.9010, Alternative and Experimental Systems **[Repealed as of 02/28/00!]**

COMPOSTING TOILETS: No regulations,⁹¹ except in Subpart 3G which mentions that other toilet waste treatment devices may be used where reasonable assurance of performance is provided.⁹²

GRAYWATER: Use of alternative systems is allowed only in areas where a standard system cannot be installed or is not the most suitable treatment. Subpart 3E of Ch. 7080.9010 states that a toilet waste treatment device must be used in conjunction with a graywater system. Accordingly, toilets wastes shall be discharged only to toilet waste treatment devices. Graywater or garbage shall not be discharged to the device, except as specifically recommended by a manufacturer. Septic systems are required for graywater systems. The drainage system in new dwellings or other establishments shall be based on a pipe diameter of two inches to prevent installation of a water flush toilet. There shall be no openings or connections to the drainage system, including floor drains, larger than two inches in diameter. For repair or replacement of an existing system, the existing drainage system may be used. Toilets or urinals of any kind shall not be connected to the drainage system. Toilet waste or garbage shall not be discharged to the drainage system. Garbage grinders shall not be connected to the drainage system. The building sewer shall meet all requirements for part 7080.0120, except that the building sewer for a graywater system shall be no greater than two inches in diameter. Graywater septic tanks shall meet all requirements of 7080.0130, subpart 1, except that the liquid capacity of a graywater septic tank serving a dwelling shall be based on the number of bedrooms existing and anticipated in the dwelling served and shall be at least as large as the following given capacities: 2 bedrooms, 300 gallon capacity; 3 or 4 rooms, 500 gallons; 5 or 6 rooms, 750 gallons; 7, 8 or 9 rooms, 1000 gallons. 4) Sizing for the system can be 60% of the amount calculated for a standard septic system. For ten or more bedrooms or other establishments, the graywater septic tank shall be sized as for any other establishment, except the minimum liquid capacity shall be at least 300 gallons. Graywater aerobic tanks shall meet all requirements of part 7080.0130. 6) Distribution and dosing of graywater shall meet all requirements of parts 7000.0150 and 7080.0160. 7) A standard graywater system shall meet all requirements of part 7080.0170. Experimental systems are discussed in subpart 3a. They may be used in areas where a standard systems cannot be installed or if a system is considered new technology with limited data on reliability.⁹³

CONSTRUCTED WETLANDS: No existing regulations.

Mississippi: Mississippi State Department of Health, PO Box 1700, Jackson, MS 39215-1700; Ph. (601) 576-7689; Contact: Ralph Turnbo.

REGULATION(S): Mississippi Individual On-Site Wastewater Disposal System Law, Chapter 41-67 (1996).

COMPOSTING TOILETS: 2.3 (28) Non-Waterborne Disposal System - any non-water carried system that treats and/or disposes of human excreta.⁹⁴ Non-Waterborne Wastewater Systems are covered under MSDH 300-Section 02A-XIII-01 (revised February 17, 1997). 1. In remote areas of the State or certain transient or temporary locations, the use of non-waterborne systems such as sanitary pit privies, portable toilets, incinerating toilets, composting toilets and related sewage systems may be approved. Due to their limited capacities, these systems are restricted to receive excreta only. Since such systems require regular service and maintenance to prevent their malfunction and overflow, they shall only be used where the local health department approves such use.⁹⁵

GRAYWATER: No existing regulations.

CONSTRUCTED WETLANDS: Constructed wetlands are discussed in Design Standard VII: Plant Rock Filter System, MSDH 300-Section 021-VII. I. A plant rock filter (constructed wetlands) wastewater treatment system may be utilized as an overland/containment system on sites where soil and site conditions prohibit the installation of a conventional or modified subsurface disposal system. In suitable soils, a plant rock filter may utilize underground absorption to dispose of effluent. It may also be utilized to polish effluent from malfunctioning "seeping" absorption field lines on existing systems. II. The plant rock filter may consist of a single cell, two cells in series

or multiple cells in series. The design will depend on the topography. Differences in individual design, construction materials and construction methods allow each of these types of plant/rock filter to vary widely in their application. Careful consideration should be made during the soil/site evaluation to ensure that the "best choice" is recommended for the particular site. Recommendations developed by the Tennessee Valley Authority's General Design, Construction, and Operation Guidelines Constructed Wetlands Wastewater Treatment Systems for Small Users Including Individual Residences, Second Edition, have been adopted by reference.⁹⁶

Missouri: Missouri Department of Health, Bureau of Community Environmental Health, PO Box 570, Jefferson City, MO 65102-0570; Ph. (573) 751-6095; FAX (573) 526-6946 or 751-0247.

REGULATION(S): Missouri Laws for On-Site Disposal Systems, Chapter 701, Section 701.025 (28 August 1998).

COMPOSTING TOILETS: No existing regulations. May be covered under "Other Systems." Where unusual conditions exist, special systems of treatment and disposal, other than those specifically mentioned in this rule, may be employed, provided: 1) reasonable assurance of performance of the system is presented to the administrative authority; 2) the engineering design of the system is first approved by the administrative authority; 3) adequate substantiating data indicate that the effluent will not contaminate any drinking water supply, groundwater used for drinking water or any surface water; 4) treatment and disposal of the waste will not deteriorate the public health and general welfare; and 5) discharge of effluent, if any, shall be within setback distances as described in the rules.⁹⁷

GRAYWATER: Under 701.025,12(b), graywater includes bath, lavatory, laundry, and sink waste, excepting human excreta, toilet waste, residential kitchen waste and other similar waste from household or establishment appurtenances.⁹⁸ Title 19, Division 20, Chapter 3, General Sanitation, defines graywater as liquid waste, specifically excluding toilet, hazardous, culinary and oily wastes, from a dwelling or other establishment which is produced by bathing, laundry, or discharges from floor drains.⁹⁹ There are no design recommendations or regulations governing graywater systems.

CONSTRUCTED WETLANDS: provide secondary levels of treatment, which means that some form of pretreatment (septic tank, aeration tank, lagoon, etc.), must be used prior to the wetland, as wetlands cannot withstand large influxes of suspended solids. The pretreatment used must be capable of removing a large portion of these solids. Effluent from wetlands must be contained on the owner's property with the same set-back distances as required for lagoons. 1. Free water surface wetlands are shallow beds or channels with a depth less than 24 inches and filled with emergent aquatic plants. This type of wetland shall not be allowed. 2. Submerged flow wetlands are similar to free water surface wetlands except that the channels are filled with shallow depths of rock, gravel or sand. The depth of the porous media is usually less than 18 inches. The porous medium supports the root systems of the emergent aquatic vegetation. The water level is to be maintained below the top of the porous medium so that there is no open water surface. The configuration of a wetland for an individual home can be a one cell or two cells in a series, depending on the soil properties of the site.¹⁰⁰

Montana: Montana Department of Environmental Quality, Lee Metcalf Building, 1520 E. Sixth Avenue, PO Box 200901, Helena, MT 59620-0901; Ph. (406) 444-4633; FAX (406) 444-1374; Contact: Mark M. Peterson, P.E., Environmental Engineering Specialist, Permitting and Compliance Division; Email: mkpeterson@mt.gov. **REGULATION(S):** Circular WQB 5. Minimum Design Standards for On-Site Alternative Sewage Treatment and Disposal Systems (1992).

COMPOSTING TOILETS: Under Chapter 70.1, waste segregation systems consist of dry disposal for human waste such as various chemical and incinerator type systems with separate disposal for graywater. However, regardless of the type of dry disposal system used, the graywater must be disposed of by primary (septic tank) and secondary (subsurface drainfield) treatment.¹⁰¹ Waste segregation systems will only be considered for recreational type dwellings which receive seasonal use or commercial buildings.¹⁰²

GRAYWATER: No existing regulations. Graywater must be disposed of through a septic tank and drainfield system.

CONSTRUCTED WETLANDS: No existing regulations.

Nebraska: Nebraska Department of Environmental Quality, Ground Water Section, PO Box 98922, Lincoln, NE 68509-8922; Ph. (402) 471-2580 or (505) 827-7541;

<http://www.deq.state.ne.us/RuleAndR.nsf/390ed3941b29c12f8625682c006210e9/80857228ae0f5c2786256800005153a8?OpenDocument>;

Contact: Brian Sohall.

REGULATION(S): If they existed, regulations would probably be found in Title 124, Rules and Regulations for Design, Operation and Maintenance of Onsite Wastewater Treatment Systems.

COMPOSTING TOILETS, GRAYWATER, CONSTRUCTED WETLANDS: No existing regulations. Graywater is defined, but no systems are necessarily allowed under Title 124.

Nevada: Department of Human Resources, Health Division, Bureau of Health Protection Services, 1179 Fairview Drive, Suite 101, Carson City, NV 89701-5405; Ph. (702) 687-6615 (general number); Ph. (702) 687-4750 (direct line); Contact: Joe Pollack.

REGULATION(S): R129-98. Sewage disposal is regulated under Nevada Administrative Code 444.750 (February 1998).

COMPOSTING TOILETS: Not approved.

GRAYWATER: systems are governed under Regulation R129-98, Section 78. 1. Graywater may be used for underground irrigation if approved by the administrative authority. A homeowner must obtain a permit to construct, alter or install a system that uses graywater for

underground irrigation from the administrative authority before such a system may be constructed, altered or installed. 2. A system that uses graywater for underground irrigation: a) may be used only for a single family dwelling; b) must not be used in soils which have a percolation rate that is greater than 120 minutes per inch; c) must consist of a three-way diversion valve, a holding tank for the graywater and an irrigation system; d) may be equipped with a pump or siphon, or may rely on gravity to cause the water to flow to the irrigation system; e) must not be connected to a system for potable water; and f) must not result in the surfacing of any graywater. 3. A system that uses graywater for underground irrigation, or any part thereof, must not be located on a lot other than the lot which is the site of the single-family dwelling that discharges the graywater to be used in the system. Section 79. 1. An application to construct, alter or install a system that uses graywater for underground irrigation must include: a) detailed plans of the system to be constructed, altered or installed; b) detailed plans of the existing and proposed sewage disposal system; and c) data from percolation tests conducted in accordance with NAC 444.796 and sections 40 to 43, inclusive, of this regulation. 2. A holding tank for graywater must: a) be watertight and constructed of solid, durable materials that are not subject to excessive corrosion or decay; b) have a minimum capacity of 50 gallons; c) have an overflow and an emergency drain. The overflow and emergency drain must not be equipped with a shutoff valve. 3. A three-way diversion valve, emergency drain and overflow must be permanently connected to the building drain or building sewer and must be located upstream from any septic tanks. The required size of an individual sewage disposal system must not be reduced solely because a system that uses graywater for underground irrigation is being used in conjunction with the individual sewage disposal system. 4. The piping for a system that uses graywater for underground irrigation which discharges into the holding tank or is directly connected to the building sewer must be downstream of any vented trap to protect the building from possible sewer gases. 5. The estimated discharge of a system that uses graywater for underground irrigation must be calculated based on the number of bedrooms in the building, as follows: a) for the first bedroom, the estimated discharge of graywater is 80 gallons per day; and b) for each additional bedroom, the estimated discharge of graywater is 40 gallons per day. 6. The absorption area for an irrigation system that includes a system that uses graywater for underground irrigation must be calculated in accordance with the following parameters: percolation rate of 0-20 minutes per inch, 20 square feet (minimum square feet per 100 gallons discharged per day); 21-40 minutes/inch, 40 gallons/day; 41-60 minutes/inch, 60 gallons/day.¹⁰³

CONSTRUCTED WETLANDS: No existing regulations.

New Hampshire: Department of Environmental Services, Bureau of Wastewater Treatment, 6 Hazen Drive, Concord, NH 03301; Ph. (603) 271-3711 or 3503; <http://www.state.nh.us/gencourt/ols/rules/env-ws.html>

REGULATION(S): Chapter Env-Ws 1000 Subdivision and Individual Sewage Disposal System Design Rules. Env-Ws 1022 deals with Alternate Systems.

COMPOSTING TOILETS, GRAYWATER, CONSTRUCTED WETLANDS: No existing regulations. New Hampshire, does, however, have extensive regulations pertaining to Alternate Systems, as follows. Part Env-Ws 1024 Innovative/Alternative Technology. The purpose of this part is to provide the methodology and review process for the approval of innovative/alternative individual sewage disposal systems, in compliance with RSA 485-A:29, I. b. This part shall apply to any proposed individual sewage disposal system technology not described elsewhere in Env-Ws 1000. a. "Conventional system" means an individual sewage disposal system regulated under Env-Ws 1000 other than Env-Ws 1024. b. "Innovative/Alternative waste treatment" as defined in RSA 485-A:2, XXI, includes individual sewage disposal systems. c. "ITA" means innovative/alternative technology approval. Env-Ws 1024.03 a. If the system will require ongoing professional maintenance, a service contract for such maintenance shall be executed before operational approval is granted. b. In exchange for obtaining the benefit of an operational approval based on innovative/alternative technology, the owner shall covenant to replace the innovative/alternative system with a conventional system should the innovative/alternative system fail to operate lawfully. The covenant shall be recorded by the owner at the registry of deeds where the property is located. Env-Ws 1024.04 ITA Applications. a. Before an innovative/alternative waste treatment system may be used the technology shall be evaluated and approved in an ITA. b. To obtain an ITA, an owner, designer, or other person shall submit a letter of application that includes the following: 1). A written description of the proposed system; 2) All operational reports, patent information, technical reports, and laboratory reports published on the proposed system, even if the information might in whole or in part reflect negatively on the system; 3) A description of any advantages of the proposed system over conventional systems in the prevention of health hazards, surface and groundwater pollution, and any other environmental benefits; 4). A description of the possible risks to public health, surface or groundwaters, or other aspects of the environment of using the proposed system; 5). The names, addresses, and phone numbers of at least three individuals who have experience in the design operation of the same type of system; 6). The proposed system's effect on the area of land required for operation; 7). A list of any rules under Env-Ws 1000 for which waivers will be required; and 8). A list of site locations where the system has been used, whether successfully or not.¹⁰⁴

New Jersey: Department of Environmental Protection, Bureau of Nonpoint Pollution Control, PO Box 029, Trenton, NJ 08625-0029; Ph. (609) 292-0404 or 4543; <http://www.state.nj.us/dep/dwq/rules.htm>

REGULATION(S): New Jersey Administrative Code 7:9A Standards for Individual Subsurface Sewage Disposal Systems.

COMPOSTING TOILETS: No existing regulations. **GRAYWATER:** 7:9A-2.1 "Graywater" means that portion of the sanitary sewage generated within a residential, commercial or institutional facility which does not include discharges from water closets or urinals.¹⁰⁵ 7:9A-1.8 (c) In cases where the actual volume of sanitary sewage discharged from a facility will be reduced by use of water-saving plumbing

fixtures, recycling of renovated wastewater, incineration or composting of wastes, evaporation of sewage effluent or any other process, the requirement for obtaining a treatment works approval and a NJPDES permit shall be based upon the design volume of sanitary sewage, calculated as prescribed in N.J.A.C. 7:9A-7.4, rather than the actual discharge volume as modified by water conservation or special treatment processes. 7:9A-7.3 (a) The system(s) shall be designed to receive all sanitary sewage from the building served except in the following cases: 1. Separate systems may be designed to receive only graywater, or only blackwater, as allowed in N.J.A.C. 7:9A-7.5. 7:9A-7.5 A graywater system may be approved by the administrative authority provided that all of the requirements of these standards are satisfied and provided that an acceptable means for disposal of the blackwater from the building served is indicated in the system design. When the blackwater from the building served by a graywater system is to be disposed of into a waterless toilet, a variance from the Uniform Construction Code, Plumbing sub-code, N.J.A.C. 5:23-3.5, must be obtained by the applicant prior to approval of the graywater system by the administrative authority and the volume of sanitary sewage to be used in the design of the graywater system shall be determined as prescribed in N.J.A.C. 7:9A-7.4. When the blackwater from the building served by a graywater system is to be disposed of into a separate subsurface sewage disposal system, the blackwater system shall meet all the requirements of this chapter and the volume of sanitary sewage used in the design of both the graywater system and the blackwater system shall be a minimum of 75 % of the volume of sanitary sewage determined as prescribed in N.J.A.C. 7:9A-7.4.¹⁰⁶ 7:9A-7.6 Each system approved by the administrative authority pursuant to this chapter shall consist of a septic tank which discharges effluent through a gravity flow, gravity dosing or pressure dosing network to a disposal field as hereafter described. Seepage pits shall not be approved for new installations except in the case of a graywater system as provided by in N.J.A.C. 7:9A-7.5. Installation of a seepage pit may be approved as an alteration for an existing system subject to the requirements of N.J.A.C. 7:9A-3.3.¹⁰⁷

CONSTRUCTED WETLANDS: No existing regulations.¹⁰⁸ 7:9A-3.11 Experimental systems The Department encourages the development and use of new technologies which may improve the treatment of sanitary sewage prior to discharge or allow environmentally safe disposal of sanitary sewage in areas where standard sewage disposal systems might not function adequately. Where the design, location, construction or installation of the system or any of its components does not conform to this chapter, the administrative authority shall direct the applicant to apply to the Department for a treatment works approval. Depending upon the volume and quality of the wastewater discharged, a NJPDES permit may also be required.¹⁰⁹

New Mexico: State of New Mexico Environment Department, 524 Camino De Los Marquez, Suite 4, Santa Fe, NM 87505; Ph. (505) 827-7545 or 7541 (direct number); FAX (505) 827-7545; Contact: R. Brian Schall, Water Resource Specialist/Community Services.
REGULATION(S): 20 NMAC 7.3, Liquid Waste Disposal Regulations (10 October 1997).

COMPOSTING TOILETS: Composting toilets are allowed, although there is no mention of them in the regulations.¹¹⁰

GRAYWATER: Subpart I, Part 107. AF. "graywater" means water carried waste from kitchen (excluding garbage disposal) and bathroom sinks, wet bar sinks, showers, bathtubs and washing machines. Graywater does not include water carried wastes from kitchen sinks equipped with a garbage disposal, utility sinks, any hazardous materials, or laundry water from the washing of material soiled with human excreta.¹¹¹ Revised regulations will have a separate section allowing graywater systems. However, the system will still have to run through a septic tank. Graywater can then be used for subsurface irrigation.¹¹²

CONSTRUCTED WETLANDS: Constructed wetlands are considered an "alternative system."¹¹³ Subpart II deals with alternative systems. The Department may issue a permit, on an individual basis, for the installation of an alternative on-site liquid waste system, including a system employing new and innovative technology, if the permit applicant demonstrates that the proposed system, by itself or in combination with other on-site liquid waste systems, will neither cause a hazard to public health nor degrade a body of water, and that the proposed system will provide a level of treatment at least as effective as that provided by on-site liquid waste systems, except privies and holding tanks, that meet the requirements of this Part and the New Mexico Design Standards.¹¹⁴

New York: New York State Department of Health, Bureau of Community Sanitation and Food Protection, 2 University Place, Room 404, Albany, NY 12203-3399; Ph. (518) 458-6706; Contact: Ben Pierson.

REGULATION(S): Appendix 75-A, Wastewater Treatment Standards - Individual Household Systems, Statutory Authority: Public Health Law 201(1)(1) (1 December 1990).

COMPOSTING TOILETS: 75-A. 10 Other Systems. (b) Non-Waterborne Systems. (1) In certain areas of the State where running water is not available or is too scarce to economically support flush toilets, or where there is a need or desire to conserve water, the installation of non-waterborne sewage systems may be considered, however, the treatment of wastewater from sinks, showers, and other facilities must be provided when non-flush toilets are installed. The Individual Residential Wastewater Treatment Systems Design Handbook gives more detail regarding composting toilets.¹¹⁵ The State Uniform Fire Prevention and Building Code [9NYCRR Subtitle S Sections 900.1(a) and (b)] requires wet plumbing (i.e., potable water plus sewerage) for all new residences. In accordance with Section 900.2(b), minimal required plumbing fixtures may be omitted for owner occupied single family dwellings if approved by the authority having jurisdiction. Health Department approval for said omission(s) shall be fully protective of public health and be in general harmony with the intent of Section 900.1 (i.e., provide satisfactory sanitary facilities). In some areas of the state where available water becomes insufficient to economically use flush toilets (i.e., even those with only 1.6 gallons per flush) or where a need or desire exists to conserve water, use of non-waterborne systems may be justified.¹¹⁶ **Composters:** These units accept human waste into a chamber where composting of the waste

occurs.¹¹⁷ Composters accept only toilet wastes and kitchen food scraps coupled with supplemental additions of carbon-rich bulking agents such as planar shavings or coarse sawdust. Household cleaning products should not be placed in the unit. Failure to add adequate bulking agents or maintain aerobic moisture can result in the pile becoming hard (and difficult to remove) or anaerobic. The composted humus contains numerous bacteria and may also contain viruses and cysts. Residual wastes (i.e., the composted humus) should be periodically removed by a professional septage hauler. If a homeowner chooses to personally remove the composted humus, it should be disposed of at a sanitary landfill or buried and well mixed into soil distant from food crops, water supply sources and watercourses. The humus comprises an admixture of recent additions and composted older additions and should be disposed of accordingly. Humus disposal sites shall meet Table 2 separation distances for sanitary privy pits.¹¹⁸ These units shall be installed in accordance with the manufacturers instructions. The units shall have a label indicating compliance with the requirements of NSF Standard 41 or equivalent. Only units with a warranty of five years or more shall be installed.¹¹⁹

GRAYWATER: systems shall be designed upon a flow of 75 gpd/bedroom and meet all the criteria previously discussed for treatment of household wastewater.¹²⁰ The treatment of household wastewater is regulated by 75-A.8. Subsurface Treatment. (a) General Information. All effluent from septic tanks or aerobic tanks shall be discharged to a subsurface treatment system. Surface discharge of septic tank or aerobic effluent shall not be approved by the Department of Health or a local health department acting as its agent.¹²¹

CONSTRUCTED WETLANDS: There is no official state policy regarding constructed wetlands. It is doubtful that the state or county health departments would approve them.¹²²

North Carolina: Department of Environmental Health and Natural Resources, Division of Environmental Health, On-Site Wastewater Section, PO Box 27687, Raleigh, NC 27611-7687; Ph. (919) 733-2895 or 7015.

REGULATION(S): Sewage Treatment and Disposal Systems, Section .1900 (April 1993).

COMPOSTING TOILETS: Section.1934. The rules contained in this Section shall govern the treatment and disposal of domestic type sewage from septic tank systems, privies, incinerating toilets, mechanical toilets, composting toilets, recycling toilets, or other such systems serving single or multiple family residences, places of business, or places of public assembly, the effluent from which is designed not to discharge to the land surface or surface waters. Section.1958 (a) Where an approved privy, an approved septic tank system, or a connection to an approved public or community sewage system is impossible or impractical, this Section shall not prohibit the state or local health department from permitting approved non-ground absorption treatment systems utilizing heat or other approved means for reducing the toilet contents to inert or stabilized residue or to an otherwise harmless condition, rendering such contents noninfectious or noncontaminating. Alternative systems shall be designed to comply with the purposes and intent of this Section. (c) Incinerating, composting, vault privies, and mechanical toilets shall be approved by the state agency or local health department only when all of the sewage will receive adequate treatment and disposal.¹²³

GRAYWATER, CONSTRUCTED WETLANDS: No existing regulations.¹²⁴

North Dakota: North Dakota Department of Health, Environmental Health Section, Division of Municipal Facilities, 1200 Missouri Avenue, Bismarck, ND 58504-5264; Ph. (701) 328-5211 or 5150; FAX (701) 328-5200; Contact: Jeff Hauge, P.E, Environmental Engineer.

REGULATION(S): Chapter 62-03-16. Individual Sewage Treatment Systems for Homes and Other Establishments Where Public Sewage Systems are not Available (1996).

COMPOSTING TOILETS: 62-03-16-01. Where water under pressure is not available, all human body wastes shall be disposed of by depositing them in approved privies, chemical toilets or such other installations acceptable to the administrative authority.¹²⁵

GRAYWATER: 62-03-16-01. 6. Water-carried sewage from bathrooms, kitchens, laundry fixtures, and other household plumbing shall pass through a septic or other approved sedimentation tank prior to its discharge into the soil or into an alternative system. Where underground disposal for treatment is not feasible, consideration will be given to special methods of collection and disposal.¹²⁶

CONSTRUCTED WETLANDS: No existing regulations.

Ohio: Bureau of Local Services, Ohio Department of Health, 246 North High Street, Columbus, OH 43266-0588; Ph. (614) 466-5190 or 1390; Contact: Tom Grigsby, Program Specialist; Email: tgrigsby@gw.odh.state.oh.us

REGULATION(S): O.A.C. Chapter 3701-29 Household Sewage Disposal Rules (1977).

COMPOSTING TOILETS, GRAYWATER, CONSTRUCTED WETLANDS: No existing regulations. Chapter 3701-29-20. Variance. (C). Household sewage disposal system components or household sewage disposal systems differing in design or principle of operation from those set forth in rules 3701-29-01 to 3701-29-21, may qualify for approval as a special device or system provided, comprehensive tests and investigations show any such component or system produces results equivalent to those obtained by sewage disposal components or systems complying with such regulations. Such approval shall be obtained in writing from the director of health.¹²⁷

Oklahoma : Department of Environmental Quality, 1000 Northeast 10th Street, Oklahoma City, OK 73177-1212; Ph. (405) 271-7363 or 702-8100 (Division of Water Quality); Contact: Donnie Johnson.

REGULATION(S): Chapter 640. Individual and Small Public Sewage Disposal (1998).

COMPOSTING TOILETS, GRAYWATER, CONSTRUCTED WETLANDS: No existing regulations. Chapter 640-1-12 governs alternative/experimental disposal systems. Where unusual conditions exist, special systems of treatment and disposal, other than individual sewage disposal systems mentioned may be employed, provided that: 1) reasonable assurance is presented to the Department that the system will work properly; 2) the design of the system is approved by the Department prior to installation; 3) there is no discharge to the waters of the state; 4) treatment and disposal of waste are in such a manner as to protect public health and the environment; 5) such systems comply with all local codes and ordinances. (b) Special alternative systems or experimental systems shall be considered on a case-by-case basis, weighing heavily in the approval process. The plans for alternative systems shall be reviewed by the Department and approved or disapproved by the Area or Regional Supervisor. After construction, the installation of the alternative system shall be approved or disapproved by the local DEQ representative. (c) To apply for approval of such systems an applicant shall file two copies of test results based on OAC 252:640-1-9 and two copies of the design plan for the proposed system with the local representative of the Department for the area in which the property is located.¹²⁸

Oregon: Department of Environmental Quality, Water Quality Division, 811 Southwest 6th Avenue, Portland, OR 97204-1390; Ph. (503) 229-6443; <http://www.cbs.state.or.us> (click on statute/rules and go to oar 918-770 (division 770);

<http://landru.leg.state.or.us/ors/447.html>; <http://arcweb.sos.state.or.us/banners/rules.htm>; Contact: Sherman Olson, Terry Swisher: Ph (503) 373-7488.

REGULATION(S): Oregon Administrative Rules, Chapter 918, Division 790, Composting Toilet Rules (1998); Oregon Revised Statutes 447.115 (1997); OAR Chapter 340, Division 71 (1997).

COMPOSTING TOILETS: As used in ORS 447.118 and 447.124, "compost toilet" means a permanent, sealed, water-impervious toilet receptacle screened from insects, used to receive and store only human wastes, urine and feces, toilet paper and biodegradable garbage, and ventilated to utilize aerobic composting for waste treatment. 447.118 (1) Nothing in ORS 447.010 to 447.160 shall prohibit the installation of a compost toilet for a dwelling by the occupant of the dwelling if the compost toilet complies with the minimum requirements established under this section. (2) Rules adopted under ORS 447.020 shall provide minimum requirements for the design, construction, installation and maintenance of compost toilets. (3) The Director of the Department of Consumer and Business Services with the approval of the State Plumbing Board may require by rule that, in addition to any other requirements provided by law, any manufacturer or distributor of a compost toilet and any person other than the owner of the dwelling in which the compost toilet is to be installed who proposes to install a compost toilet file with the Department of Consumer and Business Services a satisfactory bond, irrevocable letter of credit issued by an insured institution as defined in ORS 706.008 or other security in an amount to be fixed by the department with approval of the board but not to exceed \$5,000, conditioned that such bond, letter of credit or security shall be forfeited in whole or in part to the department for the purpose of carrying out the provisions of ORS 447.124 by failure of such manufacturer, distributor or person to comply with the rules adopted under this section. 447.124 The Department of Consumer and Business Services, with the assistance of the Health Division: (1) May conduct periodic inspections of any compost toilet; (2) Upon making a finding that a compost toilet is in violation of the rules adopted pursuant to ORS 447.118 (2), may issue an order requiring the owner of the dwelling served by the compost toilet to take action necessary to correct the violation; and (3) Upon making a finding that a compost toilet presents or threatens to present a public health hazard creating an emergency requiring immediate action to protect the public health, safety or welfare, may issue an order requiring the owner of the dwelling served by the compost toilet to take any action necessary to remove such hazard or threat thereof. If such owner fails to take the actions required by such order, the department shall take such action, itself or by contract with outside parties, as necessary to remove the hazard or threat thereof.¹²⁹ More specific information regarding composting toilets is given under Chapter 918-718-0010. Composting toilets: 1) must be ventilated (electrical or mechanical); 2) shall have at least one cubic yard capacity for a one or two bedroom dwelling; 3) shall be limited to installation in areas where a graywater disposal system can be installed and used; 4) shall be installed in an insulated area to keep a biological balance of the materials therein; and 5) humus from composting toilets may be used around ornamental shrubs, flowers, trees, or fruit trees and shall be buried under at least 12 inches of soil cover. Deposit of humus from any compost toilet around any edible vegetation or vegetable shall be prohibited.¹³⁰ Composting toilets must be approved by the NSF Standard 41.¹³¹

GRAYWATER: 447.140 (1) All waste water and sewage from plumbing fixtures shall be discharged into a sewer system or alternate sewage disposal system approved by the Environmental Quality Commission or department of Environmental Quality under ORS chapters 468, 468A and 468B. Graywater is technically defined as sewage and still requires a septic tank and drainfield, although the septic system can be reduced in size.¹³² Chapter 340, Divisions 71 and 73: Under the "split-waste method," blackwater sewage and graywater sewage from the same dwelling or building are disposed of by separate systems.¹³³ 340-71-320. Split Waste Method. In a split waste method, wastes may be disposed of as follows: (1) Black wastes may be disposed of by the use of State Building Codes Division approved non-water carried plumbing units such as recirculating oil flush toilets or compost toilets. (2) Graywater may be disposed of by discharge to: a) an existing on-site system which is not failing; or b) a new on-site system with a soil absorption facility 2/3 normal size. A full size initial disposal area and replacement disposal area of equal size are required; or c) a public sewerage system.¹³⁴

CONSTRUCTED WETLANDS: Performance based permits are issued for constructed wetlands. Several systems have been installed in Oregon, but not for single family homes.¹³⁵

Pennsylvania: Department of Environmental Protection, Bureau of Water Quality Protection, Division of Wastewater Management, Rachel Carson State Office Building, 11th Floor, 400 Market Street, Harrisburg, PA 17101-2301; Ph. (717) 787-8184.

REGULATION(S): Title 25. Environmental Protection, Chapter 73. Standards for Sewage Disposal Facilities, Current through 28 Pa.B. 348 (17 January 1998).

COMPOSTING TOILETS: under Chapter 73.1 are defined as devices for holding and processing human and organic kitchen waste employing the process of biological degradation through the action of microorganisms to produce a stable, humus-like material.¹³⁶ Composting toilets are permitted under Ch. 73.65. Toilets must bear the seal of the NSF indicating testing and approval by that agency under Standard No. 41. (b) The device utilized shall meet the installation specifications of the manufacturer and shall be operated and maintained in a manner that will preclude any potential pollution or health hazards. (c) When the installations of a recycling toilet, incinerating toilet or composting toilets is proposed for a new residence or establishment, an onlot sewage system or other approved method of sewage disposal shall be provided for treatment of washwater or excess liquid from the unit. For existing residences, where no alteration of the on lot system is proposed, a permit is not required to install a composting toilet.¹³⁷

GRAYWATER: 73.11. (c) Liquid wastes, including kitchen and laundry wastes and water softener backwash, shall be discharged to a treatment tank.¹³⁸

CONSTRUCTED WETLANDS: No existing regulations. Ch. 73.71 governs Experimental Sewage Systems, which may be implemented upon submittal of a preliminary design plan. Experimental systems may be considered for individual or community systems in any of the following cases: 1) To solve existing pollution or public health problem; 2) To overcome specific site suitability deficiencies, or as a substitute for systems described in this chapter on suitable lots; 3) To overcome specific engineering problems related to the site or proposed uses; and 4) To evaluate new concepts or technologies applicable to onlot disposal.¹³⁹

Rhode Island: Department of Environmental Management, Division of Groundwater and Individual Sewage Disposal Systems, ISDS Section, 291 Promenade Street, Providence, RI 02908-5767; Ph. (401) 277-4700; <http://www.state.ri.us/dem/reggs/water/isds9-98.pdf> or [.doc](#)

REGULATION(S): Chapter 12-120-002, Individual Sewage Disposal Systems (September 1998).

COMPOSTING TOILETS: Regulation 12-120-002, amended September 1998, governs composting toilet guidelines. SD 14.00 discusses the acceptability of composting, or humus, toilets, stating that a humus or incinerator type toilet may be approved for any use where a septic tank and leaching system can be installed. The regulation governs two types of composting toilets: 1) large capacity composting toilets; and 2) heat assisted composting toilets. Large capacity toilets must have an interior volume greater than or equal to 64 cubic feet. All waste removed from large capacity composting toilets shall be disposed of by burial or other means approved by the director. Separate subsurface sewage disposal facilities must be provided for disposal of any liquid wastes from sinks, tubs, showers and laundry facilities (SD 14.05).¹⁴⁰

GRAYWATER: The term, "graywater," shall be held to mean any wastewater discharge from a structure excluding the waste discharges from water closets and waste discharges containing human or animal excrement. The term, "sanitary sewage," shall be held to mean any human or animal excremental liquid or substance, any putrescible animal or vegetable matter and/or any garbage and filth, including, but not limited to, any graywater or blackwater discharged from toilets, laundry tubs, washing machines, sinks, and dishwashers as well as the content of septic tanks, cesspools, or privies.¹⁴¹

CONSTRUCTED WETLANDS: No existing regulations. Section SD14.06 governs Innovative or Alternative Technology Approval Procedures (this is an extensive section on the procedures, that are required to install an alternative system).¹⁴²

South Carolina: Onsite Wastewater Management Branch, Division of Environmental Health, Department of Health and Environmental Control, 2600 Bull Street, Columbia, SC 29201; Ph. (803) 935-7945; FAX (803) 935-7825; Contact: Richard Hatfield; Email:

HATFIERL@columb72.dhec.state.sc.us

REGULATION(S): Chapter 61-56, Individual Waste Disposal Systems (27 June 1986).

COMPOSTING TOILETS: Composting toilets may be used in conjunction with an approved septic system, for facilities that are provided with water under pressure. If site and soil conditions are not acceptable for an approved septic system, an alternative toilet may be considered, but only if the facility is not connected to water under pressure.

GRAYWATER: No existing regulations. Graywater is included within the Department's definition of sewage and must be managed appropriately. A permit applicant could elect to install separate systems to handle blackwater and graywater, but the same site and soil requirements apply for both systems.

CONSTRUCTED WETLANDS: Constructed wetlands (rock/plant filter) may be installed by an owner, but only in conjunction with an approved pre-treatment system, such as a septic tank, and an approved disposal system, such as a drain field. A limited number of homeowners have elected to use constructed wetlands systems in an effort to mitigate failing conventional systems.¹⁴³ Regulation 61-56, Individual Waste Disposal Systems, grants authority to the Department of Health and Environmental Control to adopt standards for alternative onsite treatment and disposal systems. However, no technical standards have been developed for graywater systems, constructed wetlands or composting toilets.

South Dakota: Department of Environment and Natural Resources, Air and Surface Water Program, Joe Foss Building, 523 East Capitol, Pierre, SD 57501; Ph. (605) 773-3151; <http://www.state.sd.us/state/legis/lrc/rules/7453.htm>

REGULATION(S): Chapter 74:53:01:10 (1 July 1996).

COMPOSTING TOILETS: Unconventional systems are only to be used when water or electrical systems are unavailable. Vault privies, chemical toilets, incinerator toilets, or composting units shall be used when a water or electrical system is not available. With the exception of vault privies, all unconventional systems are considered experimental systems, and plans and specifications shall be submitted to the secretary for approval as an experimental system prior to installation.¹⁴⁴

GRAYWATER: Under Chapter 74:03: 01:38, graywater systems are wastewater systems designed to recycle or treat wastes from sinks, lavatories, tubs, showers, washers, or other devices which do not discharge garbage or urinary or fecal wastes. In areas where they will not create a public nuisance or enter any water of the state, graywater systems are exempt from the requirement that normally states that wastewater is not allowed to surface on, around, or enter state waters. 74-03:01:75. A graywater system shall be designed in accordance with the following criteria: 1) All graywater treatment and recycle systems shall be located in accordance of the distances specified in 74:03.01:56, Table 1; 2) Design of graywater systems shall be based on a minimum graywater flow of 25 gallons per day per person. Three days retention time shall be provided for each graywater tank; 3) Graywater tanks are septic tanks and shall conform to the requirements for septic tanks; and 4) Effluent from graywater systems may be recycled for toilet use, conveyed to absorption fields, mounds or seepage pits, or used for irrigation of lawns and areas not intended for food production. Percolation tests shall be conducted and the minimum size of absorption area shall be determined in accordance with 74:03:01:66 to 74:03:01:69, inclusive.¹⁴⁵

CONSTRUCTED WETLANDS: No existing regulations.

Tennessee: Tennessee Department of Environment and Conservation, Division of Ground Water Protection, L & C Tower, 10th Floor, 401 Church Street, Nashville, TN 37243-1540; Ph. (615) 532-0774; Contact: Stephen Morse, Environmental Manager. Regulation(s): Rules of Department of Environment and Conservation, Division of Ground Water Protection, Chapter 1200-1-6: Regulations to Govern Subsurface Sewage Disposal Systems (1997).

COMPOSTING TOILETS: (2) Composting toilets must be certified by the NSF to be in compliance with NSF Standard 41, and be published in their Listing of Certified Wastewater Recycle/Reuse and Water Conservation Devices before they may be used for disposal of human excreta by non-water carriage methods. (c) A pit privy or composting toilet shall not be permitted for a facility where the facility has running water available unless there is an acceptable means to dispose of wastewater.¹⁴⁶

GRAYWATER, CONSTRUCTED WETLANDS: No existing regulations. However, the Tennessee Valley Authority does publish a set of guidelines for the design and construction of constructed wetlands: Tennessee Valley Authority's General Design, Construction, and Operation Guidelines - Constructed Wetlands Wastewater Treatment Systems for Small Users Including Individual Residences, Second Edition, by Steiner, et al., 1993.

Texas: Texas Natural Resource Conservation Commission, PO Box 13087, Austin, TX 78711-3087; Ph. (512) 239-4775; <http://www.tnrcc.state.tx.us>

REGULATION(S): Chapter 285: On-Site Sewage Facilities (1999).

COMPOSTING TOILETS: 285.2 (13) Composting toilet - A self-contained treatment and disposal facility constructed to decompose non-waterborne human wastes through bacterial action facilitated by aeration. 285.34 Other Requirements (e) Composting toilets will be approved by the executive director provided the system has been tested and certified under NSF Standard 41 ¹⁴⁷ 285.2 (27)

GRAYWATER: wastewater from clothes washing machines, showers, bathtubs, handwashing lavatories, and sinks not used for the disposal of hazardous or toxic ingredients or waste from food preparations. Subchapter H: 285.80. Treatment and Disposal of Graywater. New construction or modification to an existing graywater conveyance, treatment, storage or disposal system outside of a structure or building must be carried out in accordance with provisions of this chapter and any established requirements of the permitting authority. Any new construction or modification to an existing graywater reuse or reuse conveyance system associated with a structure or building must be carried out in accordance with the requirements of the State Board of Plumbing Examiners.¹⁴⁸ Graywater must be treated through a septic system first.¹⁴⁹

CONSTRUCTED WETLANDS: Permitted under 285.32C. Non-standard systems include, but are not limited to, all forms of the activated sludge process, rotating biological contactors, recirculating sand filters, and submerged rock biological filters (a fancy name for constructed wetlands). Non standard systems submitted for review will be analyzed on basic engineering principles and the criteria established in Chapter 285. These systems will be reviewed as one of a kind, site-specific installations. Whether blackwater or graywater, all domestic water-carried discharges have to go through a septic tank first before going through a wetland system. After passing through the wetland system, it must still go through a drainfield.¹⁵⁰

Utah: Department of Environmental Quality, Division of Water Quality, 288 North 1460 West, PO Box 144870, Salt Lake City, UT 84114-4870; Ph. (801) 538-6146; <http://www.eq.state.ut.us/eqwq/wqrules.htm>

REGULATION(S): If they existed, they may be covered under R317-502-3, Individual Wastewater Disposal Systems (1993).

COMPOSTING TOILETS, GRAYWATER, CONSTRUCTED WETLANDS: No existing regulations. R317-502-3. does speak to

alternative systems. The drainage system of each dwelling, building or premises covered herein shall receive all wastewater (including but not limited to bathroom, kitchen, and laundry wastes) as required by the Uniform Plumbing Code and shall have a connection to a public sewer except when such sewer is not available or practicable for use, in which case connection shall be made as follows: 3.1 To an individual wastewater disposal system found to be adequate and constructed in accordance with requirements stated herein. 3.2 To any other type of wastewater disposal system acceptable under R317-1, R317-3, R317-5, or R317-560. R317-502-20. Experimental and Alternate Disposal Methods. 20.1 Where unusual conditions exist, experimental methods of wastewater disposal may be employed provided they are acceptable to the Division and to the local health department having jurisdiction. 20.2 When considering proposals for experimental individual wastewater disposal systems, the Division shall not be restricted by this rule provided that: A. The experimental system proposed is attempting to resolve an existing pollution or public health hazard, or when the experimental system proposal is for new construction, it has been predetermined that an acceptable back-up disposal system will be installed in event of failure of the experiment; B. The proposal for an experimental individual wastewater disposal system must be in the name of and bear the signature of the person who will own the system; and C. The person proposing to utilize an experimental system has the responsibility to maintain, correct, or replace the system in event of failure of the experiment. 20.3 When sufficient, successful experience is established with experimental individual wastewater disposal systems, the Division may designate them as approved alternate individual wastewater disposal systems. Following this approval of alternate individual wastewater disposal systems, the Division will adopt rules governing their use.¹⁵¹

Vermont: Agency of Natural Resources, Department of Environmental Conservation, Wastewater Management Division, 103 South Main Street, The Sewing Building, Waterbury, VT 05671-0401; Ph. (802) 241-3834; Contact: Bonnie J. Loomer-Hostelter; Email: bonniel@dec.anr.state.vt.us

REGULATION(S): If they existed, they would most likely be found under Environmental Protection Rules, Chapter 1, Small Scale Wastewater Treatment and Disposal Rules (8 August 1996).

COMPOSTING TOILETS, GRAYWATER, CONSTRUCTED WETLANDS: No existing regulations. Innovative systems are regulated under Chapter 1, Small Scale Wastewater Treatment and Disposal Rules. Innovative Systems are governed under subchapter 2, 1-203. Alternative systems are allowed in Vermont only if a back-up, in ground conventional (septic) system is installed.¹⁵² Constructed wetlands as treatment units could be approved if the design was sufficiently reliable given the extended winter season in Vermont. However, for all practical purposes, the discharge from a constructed wetland unit could not be discharged directly into surface waters under these regulations but would have to be discharged to a subsurface leachfield or possibly a sprayfield system.¹⁵³

Virginia: State of Virginia, Office of Environmental Health Services, Main Street Station, Suite 117, PO Box 2448, Richmond, VA 23218-2448; Ph. (804) 225-4030; <http://www.vdh.state.va.us/onsite/regulations/sew-vac4.htm>; Contact: Donald Alexander; Email: dalexander@vdh.state.va.us

REGULATION(S): 12 VAC 5-610-980.

COMPOSTING TOILETS: Article 6. 12 VAC 5-610-970. 3. Composting toilets are devices which incorporate an incline plane, baffles, or other suitable devices onto which human excreta is deposited for the purpose of allowing aerobic decomposition of the excreta. The decomposing material is allowed to accumulate to form a humus type material. These units serve as both toilet and disposal devices. Composting toilets are located interior to a dwelling. All materials removed from a composting privy shall be buried. Compost material shall not be placed in vegetable gardens or on the ground surface. All composting toilets must be certified by the National Sanitation Foundation as meeting the current Standard 41.

GRAYWATER: No existing regulations.

CONSTRUCTED WETLANDS: 12VAC5-640-370. Constructed wetlands are considered experimental and will be considered on a case by case basis by the department. All constructed wetland systems shall be designed to meet or exceed 10 mg/l BOD5 and 10 mg/l suspended solids. Experimental systems are exactly that: experimental. Only the results of testing will determine if they will become an approved method of treating wastewater. Some systems can solve site and soil problems that a conventional septic system cannot handle; however, no system can overcome all of the problems on some difficult sites. The Division is looking to find safe, sanitary and economical solutions for every site but some problems still lack a viable solution. In short, not every site "percs" and many, if not all, alternative technologies are more expensive than a conventional gravel system. The Department urges prospective buyers to get an approval letter or construction permit before buying property you wish to build on.¹⁵⁴

Washington: Department of Health, Community Environmental Health Programs LD-11, Building 2, Airdustrial Center, PO Box 47826, Olympia, WA 47826; Ph. (360) 236-4501 or 3011 (Environmental Health Programs direct line); <http://access.wa.gov/government/awlaws.asp>; Contact: Jen Haywood.

REGULATION(S): WAC 246-272; Technical Review Committee, Guidelines for Composting Toilets (1994); Recommended Standards and Guidance for Water Conserving On-Site Wastewater Treatment Systems (1999).

COMPOSTING TOILETS: I. The Technical Review Committee for On-Site Sewage Disposal, established under WAC 246-272-040, has reviewed the available literature on composting toilets. The committee has determined that composting toilets could be an approved

method of sewage treatment if use is consistent with the guidelines herein. Composting toilets are not designed to handle the total wastewater volume generated in the home. The units are usually designed to accommodate fecal and urinary wastes together with small amounts of organic kitchen wastes. The remaining wastewater originating from bathing facilities, sinks and washing machines (graywater) must therefore be collected, treated and disposed of in an approved manner. Because there generally will be additional wastewater to dispose of, composting toilets are restricted.

II. Composting toilets are any device designed to store and compost by aerobic bacterial digestion human urine and feces which are non-water carried, together with the necessary venting, piping, electrical and/or mechanical components.¹⁵⁵ Section A. Waterless Toilets/WLTs. Composting - Unit designed to store and compost (by microbial digestion) human urine and feces. These units are commonly designed to accommodate fecal and urinary wastes together with small amounts of organic material to assist their function. No water is used for transport of urine or feces within these units. They may be small enough to sit on the floor of a bathroom or large enough to require space below the floor to house the storage/composting chamber.¹⁵⁶ The units may be used to replace private privies or chemical toilets, including such applications as highway weigh stations, warehouses, port facilities, construction sites, residences, etc., may be used in dwellings where water supply is not available or provided (example: mountain cabins), or may be used in dwellings where an on-site sewage system is or can be provided for disposal of graywater. Where non-discharging blackwater treatment systems are used, a 50% reduction in septic tank volume and a 40% reduction in the daily hydraulic loading to be used in sizing the grey water disposal mechanism (drainfield, mound system, etc.) are recommended from standard design requirements. The units may be used in facilities where a public sewage system is provided for disposal of graywater.¹⁵⁷ The devices shall be capable of accommodating full or part-time usage without accumulating excess liquids when operated at the design rated capacity. Continuous forced ventilations (e.g., electric fan or wind-driven turbovent) of the storage or treatment chamber must be provided to the outside.¹⁵⁸ Components in which biological activity is intended to occur shall be insulated, heated, or otherwise protected from low temperature conditions, in order to maintain the stored wastes at temperatures conducive to aerobic biological decomposition: 20 to 50 degrees C (68 to 130 degrees F). The device shall be capable of maintaining wastes within a moisture range of 40 to 75%. The device shall be designed to prevent the deposition of inadequately treated wastes near parts used for the removal of stabilized end products. The solid end product (i.e., waste humus) shall be stabilized to meet NSF criteria when ready for removal at the clean out port.

1. Performance Standards. 1.2.1.2. Toilets of proprietary design must be tested according to the NSF International Standard No. 41 (May 1983).¹⁵⁹ The maintenance of carbon-to-nitrogen ratios of approximately 20:1 are recommended. Consequently, additions of vegetable matter, wood chips, sawdust, etc., can be helpful. Removal of composted and liquid materials shall be done in a manner approved with the local health departments and as a minimum, shall comply with Guidelines for Sludge Disposal, Washington Department of Health, 1954. Persons finding it necessary to handle this material shall take adequate protective sanitation measures, and should wash their hands carefully with soap and hot water. Compost shall not be used directly on root crops or on low-growing vegetables, fruits or berries which are used for human consumption; however, this general restriction does not apply if stabilized compost is applied 12 months prior to planting. Where it can be shown that sludge will not come in direct contact with the food products, such as in orchards or where stabilized sludges are further treated for sterilization or pathogen reduction, less restrictive periods may be applicable. Performance monitoring shall be performed on composting toilets permitted under this guideline. Permits should include a statement indicating the permitter's right of entry and/or right to inspect. The frequency of monitoring shall be: 1) Two years after installation; 2) Four years after installation; and 3) in response to a complaint or problem. Non-water carried sewage treatment units are presently acknowledged to be a method of sewage disposal under the Uniform Plumbing Code, but variances to use the devices might be required by local administrative authorities. Variances must therefore be obtained from these departments together with approval of the local health department before the installation can be allowed. The Revised Code of Washington (RCW) 70.118 gives local boards of health the authority to waive applicable sections of local building/plumbing codes when they might prohibit the use of an alternative method for correcting a failure.¹⁶⁰

GRAYWATER: Section B. Graywater systems are virtually the same as combined-wastewater on-site sewage systems. Gravity flow graywater systems consist of a septic tank and subsurface drainfield. Pressurized graywater systems consist of a septic tank, a pump chamber or vault, and a subsurface drainfield. Other types of alternative systems, pre-treatment methods and drainfield design and materials options may also be incorporated in graywater systems. The primary distinction between a graywater system and a combined wastewater system is the lower volume of wastewater. As a result, the size of the septic tank and subsurface drainfield is smaller compared to a system that treats and disposes all the household wastewater (combined) through a septic tank and drainfield. In addition to the water conserving nature of waterless toilets/graywater systems, the graywater system drainfield can be designed and located to reuse graywater for subsurface irrigation. Drainfield designs (methods and materials) which place the distributed wastewater in close proximity to the root zone of turf grasses, plants, shrubs, and trees may be used to enhance the reuse potential of graywater as it is treated in the soil, assuring public health protection. When graywater systems are designed, installed, operated and maintained to maximize their potential as a graywater reuse irrigation system, various items should be considered. Among these are plant water and nutrient needs and limits, salt tolerances, depths of root zones, etc. The development of a landscape plan is recommended. Graywater treatment and disposal/reuse systems must provide treatment and disposal at least equal to that provided by on-site system. Graywater on-site systems may be used with new residential construction and existing dwellings. Internal household plumbing may be modified (consistent with local plumbing code) to route any portion of the household graywater to the graywater on-site sewage system. Graywater on-site sewage systems may be located anywhere conventional or alternative on-site sewage systems are allowed. Site conditions, vertical separation, pretreatment requirements, setbacks and other location requirements are the same as described in Chapter 246-272 WAC. 2.4 Graywater on-sites sewage systems must provide permanent, year-round treatment and disposal of graywater unless this is already provided by an approved

on-site system or connection to public sewer. Graywater on-site systems must be installed with an approved waterless toilet or other means of sewage treatment for blackwater approved by the local health officer. Graywater systems are intended to treat and dispose "residential strength" graywater. Graywater exceeding residential strength must receive pre-treatment to at least residential strength levels. Design requirements for graywater on-site sewage systems, unless otherwise noted, are the same as requirements for combined wastewater systems presented in Chapter WAC 246-272. Graywater may be used for subsurface irrigation of trees (including fruit trees) shrubs, flowers, lawns and other ground covers but must not be used for watering of food crops of vegetable gardens, any type of surface or spray irrigation, to flush toilets/urinals or to wash wall, sidewalks or driveways. The disposal component of a graywater treatment system may be designed to enhance the potential for subsurface irrigation. The efficiency of graywater reuse via subsurface irrigation depends upon the proximity of the drainfield to the root-zone of plants, shrubs, trees or turf and the method of distribution. This may be enhanced by: Installing narrower-than-normal trenches shallow in the soil profile (state rules do not have a minimum trench width; minimum trench depth is six inches). Gravel and pipe size may limit how narrow a "conventional" trench may be. It is recommended that at least two inches of gravel be provided between the sides of the distribution pipe and trench sidewalls. Small gravel size (no less than 3/4 inch) is recommended for narrow trenches; using pressure distribution to reduce the height of the trench cross section to enable shallow trench placement and to assure even distribution; and using subsurface drip irrigation (SDS) technology for shallow system placement and equal distribution in close proximity to plant, shrub, turf and trees roots. Some agronomic issues that should be considered with graywater reuse are the water needs and salt tolerances of plants to be irrigated. In many cases, the volume of graywater generated may not meet the needs of the landscape plantings. If potable water is used to augment graywater for irrigation within the same distribution network, a method of backflow prevention approved by the local health officer is required. In some geographical and climatic areas, the frost-protection needs of an SDS or a conventional drainfield trench system may be counter-productive to effective graywater reuse via subsurface irrigation (distribution piping may be too deep for plant root systems). In these areas, local health officers may permit seasonal systems where year-round treatment and disposal is provided by an approved sewage system and seasonal subsurface irrigation with graywater is provided by a separate system with a shallow drainfield or SDS. Where seasonal systems are allowed, various administrative and design issues must be addressed. Both drainfields must meet state and local rule requirements, including soil application rates, to assure treatment and disposal at least equal to that provided by conventional gravity or pressure on-site sewage systems according to Chapter 246-272 WAC. 3.4.2 Municipal sewer systems may provide year-round sewage disposal in conjunction with seasonal graywater treatment and disposal systems designed to enhance graywater reuse via subsurface irrigation. Seasonal graywater treatment and disposal/reuse systems must include a three-way diverter valve to easily divert graywater to the year-round disposal field or sewer when needed (when freezing is a problem). Local health officers may permit "laundry wastewater only" graywater disposal or reuse systems for single family residences for either year-round or seasonal use. Graywater systems limited only to laundry wastewater (including laundry sinks) may differ from other graywater systems according to the following: A single compartment retention/pump tank, with a minimum liquid capacity of 40 gallons may be used in lieu of the tank recommendations. The tank must be warranted by the manufacturer for use with wastewater and meet requirements listed in Appendix G of the 1997 edition of the Uniform Plumbing Code (UPC). Minimum design flow for "laundry wastewater only" systems (for the purpose of drainfield sizing) must be based on the number of bedrooms in the residence and must be no less than 30% of the minimum graywater system design flows. A wastewater filter or screen (with a maximum size opening of 1/16 inch) must be provided in an accessible location conducive to routine maintenance. Homeowners are responsible for proper operation and maintenance of their graywater systems. Specific requirements will vary according to the county where the system is located and the specific type of system. See your local health jurisdiction for local system O & M requirements.¹⁶¹

CONSTRUCTED WETLANDS: No existing regulations.

West Virginia: Secretary of State, Administrative Law Division, State Capitol, 1900 Kanawha Boulevard East, Building 1, Suite 157K, Charleston, WV 25305-0770; Ph. (304) 558-6000; FAX (304) 558-0900; <http://www.state.wv.us/sos>; Email: WVSOS@Secretary.State.WV.US; Contact: Leah Powell.

REGULATION(S): Title 64, Interpretive Rules Board of Health, Series 47, Sewage Treatment and Collection System Design Standards (1983).

COMPOSTING TOILETS: Interpretive Rule 16-1, Series VII, 10.1. Composting toilets may be utilized only in conjunction with an approved graywater treatment and disposal system. 10.2 The design and construction of a composting toilet must meet the requirements of NSF Standard 41.

GRAYWATER: 12.1 Those houses served by a graywater disposal system must have a house sewer of not more than two inches in diameter. 12.2. Houses served by graywater disposal systems shall not have garbage disposal units. 12.3 Manufactured graywater disposal systems must be approved by the director. 12.4. Non-commercial graywater disposal systems shall consist of the following: 12.4.1. A soil absorption field designed on the basis of a 30% reduction in water usage, and constructed in accordance with the design requirements for the standard soil absorption fields. 12.4.2. A septic tank sized according to the following room sizes and minimum capacities: 2 rooms, 500 gallons; 3 to 4 rooms, 750 gallons; 5 or more rooms, add 210 gallons for each additional bedroom.¹⁶²

CONSTRUCTED WETLANDS: No existing regulations.

Wisconsin: Department of Commerce, Bureau of Program Management, 715 Post Road, Stevens Point, WI 54481-6456; Ph. (715) 345-

5334; FAX (715) 345-5269; <http://www.commerce.state.wi.us/sb-comm83revisionsandarticles.html>;
<http://www.legis.state.wi.us/rsb/code/comm/comm083.pdf>; Contact: Jim Klass, Ph. (608) 266-9292 (Water Regulation).

REGULATION(S): If they existed, they may be found in Wisconsin Comm083.

COMPOSTING TOILETS, GRAYWATER SYSTEMS, CONSTRUCTED WETLANDS: No existing regulations.

Wyoming: Department of Environmental Quality, Water Quality Division, Herschler Building, 122 West 25th Street, Cheyenne, WY 82002; Ph. (307) 777-7075; <http://deq.state.wy.us/wqd/w&wwpage.htm>; Contact: Larry Robinson; lharmo@missc.state.wy.us

REGULATION(S): If they existed, regulations would most likely be found in Chapter XI, Part D, Septic Tank and/or Soil Absorption System, Water Quality Rules and Regulations in the Innovative and Alternative section.

COMPOSTING TOILETS, GRAYWATER SYSTEMS, CONSTRUCTED WETLANDS: No existing regulations.

Canada: Systems would be governed by the provincial Ministries of Health (municipal affairs and health, similar to our county government in the US). Check your local agency.

Other information sources: National Small Flows Clearinghouse: West Virginia University, PO Box 6064, Morgantown, WV 26506-6064; Ph. (304) 294-4191; 1-800-624-8301; National Sanitation Foundation: NSF Standard 41: Nonliquid Saturated Treatment Systems: <http://www.nsf.org>

ENDNOTES (Appendix 3)

1. Memorandum from James M. Coles, Deputy Director. Division of Community Environmental Protection, State of Alabama Department of Public Health. 7 December 1998.
2. Alabama State Board of Health. 7 December 1998. Rules of State Board of Health Bureau of Environmental Services Division of Community Environmental Protection. Chapter 420-3-1, Onsite Sewage Disposal. Draft. p. 126.
3. Alabama State Board of Health, Bureau of Environmental Services, Division of Community Environmental Protection. 23 December 1998. Rules of State Board of Health Bureau of Environmental Services Division of Community Environmental Protection. Chapter 420-3-1, Onsite Sewage Disposal and Subdivision-Onsite Sewage Systems, Water Supplies and Solid Waste Management. p. 6.
4. Alabama State Board of Health. 7 December 1998. Rules of State Board of Health Bureau of Environmental Services Division of Community Environmental Protection. Chapter 420-3-1, Onsite Sewage Disposal. Draft. p. 126.
5. Arizona Department of Environmental Quality (ADEQ). Bulletin No. 12: Minimum Requirements for the Design and Installation of Septic Tank Systems and Alternative On-site Disposal Systems. June 1989. p. 65.
6. Ibid. p. 65-66.
7. Arizona Administrative Code. Department of Environmental Quality, Water Pollution Control. Article 7. Regulations for the Reuse of Wastewater. p. 14, 15, 17.
8. Knight, R. L, Randall, R. and M. Girts. May 1995. Arizona Guidance Manual for Constructed Wetlands for Water Quality Improvement. Arizona Department of Environmental Quality. p. 8-14.
9. Arizona Department of Environmental Quality. June 1989. Engineering Bulletin No. 12: Minimum Requirements for the Design and Installation of Septic Tank Systems and Alternative On-Site Disposal Systems. p.64.
10. Ibid.
11. Ibid. p. 65.
12. Environmental Program Services, Division of Environmental Health Protection. April 1993. Alternate Systems Manual. Arkansas Department of Health. p. 1.
13. Ibid.
14. Ibid. p. 18.

15. Carl J. Graves, R.S., Sanitarian, Arkansas Department of Health. Personal communication. 25 February 1999. 12. Environmental Program Services, Division of Environmental Health Protection. April 1993. Alternate Systems Manual. Arkansas Department of Health. p. 18.
16. Ibid. p. 18.
17. Ibid.
18. Ibid. p. 13-16
19. Ibid. p. 13-16
20. State of California. Building Standards Commission. 28 September 1997. Appendix G. Graywater Systems. Uniform Plumbing Code (UPC). Title 24, Part 5, California Administrative Code. p. 79-85.
21. Colorado Department of Health. 1994. Guidelines on Individual Sewage Disposal Systems. p. 6.
22. Colorado Department of Health. 1994. Guidelines on Individual Sewage Disposal Systems. p. 46.
23. Ibid. p. 47.
24. Ibid. p. 7.
25. Ibid. p. 44.
26. Ibid. p. 6.
27. Ibid. p. 43.
28. Connecticut Public Health Code. Regulations and Technical Standards for Subsurface Sewage Disposal Systems. Section 19-13-B100, Section 19-13-B103, Technical Standards, Section 19-13-B104. January 1997. p. 12.
29. Ibid. p. 42-43.
30. Ibid. p. 7.
31. Ibid. p. 12.
32. State of Delaware, Department of Natural Resources and Environmental Control. 31 January 1995. Regulations Governing the Design, Installation and Operation of On-Site Wastewater Treatment and Disposal Systems. Forward.
33. David Hammonds, Florida Bureau of Water and Onsite Sewage Programs. Personal conversation. 25 February 1999.
34. State of Florida, Department of Health. 3 March 1998. Chapter 64E-6, Florida Administrative Code, Standards for On-Site Sewage Treatment and Disposal Systems. p. 20.
35. Ibid. p. 22.
36. <http://www.leg.state.fl.us/citizen/documents/statutes/1998/ch0381/sec0065%5F.htm> 5 April 1999. p. 1.
37. State of Florida, Department of Health. 3 March 1998. Chapter 64E-6, Florida Administrative Code, Standards for On-Site Sewage Treatment and Disposal Systems. p. 31.
38. Florida Administrative Code. 13 February 1997. Standards for On-Site Sewage Treatment and Disposal Systems, Chapter 10D-6.
39. National Small Flows Clearinghouse. 1997. Graywater Systems from the State Regulations. WWBLRG24. p. 19, 20, 23-24.
40. David Hammonds, Florida Bureau of Water and Onsite Sewage Programs. Personal conversation. 25 February 1999.

41. State of Georgia. 20 February 1998. Chapter 290-5-59. Special Onsite Sewage Management Systems. p. D-18.
42. State of Georgia. 20 February 1998 Chapter 290-5-59. Special Onsite Sewage Management Systems. p. 2.
43. Ibid. p. D-19.
44. Corbitt, Bill. 16 July 1997. Aquatic Sewage Treatment Systems in Georgia, Past and Present. Georgia Environmentalist. Georgia Environmental Health Association. p. 8-14.
45. Hawaii Department of Health. 30 August 1991. Amendment and Compilation of Chapter 11-62. p. 62-4.
46. Ibid. p. 62-5.
47. Ibid. p. 62-24.
48. Ibid. p. 62-26.
49. Ibid. p. 62-23.
50. National Small Flows Clearinghouse. 1997. Graywater Systems from the State Regulations. WWBLRG24. p. 25.
51. Hawaii Department of Health. 30 August 1991. Amendment and Compilation of Chapter 11-62. p. 62-23.
52. Ibid. p. 62-26.
53. State of Idaho. 993. IDAPA 16. Title 01, Chapter 03. Rules for Individual/Subsurface Sewage Disposal Systems. p. 16-8.
54. Idaho Division of Environmental Quality. 8 January 1999. Technical Guidance Manual for Individual Subsurface Sewage Disposal Systems. p. 33.
55. Barry Burnell, Idaho Division of Environmental Quality. Personal communication. 8 January 1999.
56. Ibid.
57. Idaho Division of Environmental Quality. 25 October 1996. Technical Guidance Manual for Individual Subsurface Sewage Disposal Systems. p. 1-4.
58. Barry Burnell, Idaho Division of Environmental Quality. Personal communication. 8 January 1999.
59. Illinois Department of Public Health. 1996. Private Sewage Disposal Licensing Act and Code. p. 54.
60. Ibid. p. 63.
61. Ibid. p. 56.
62. Tim Decker, Indiana State Department of Health. Personal communication. 30 April 1999.
63. Iowa Chapter 69: On-Site Wastewater Treatment and Disposal Systems. 567--69.11(455B) Constructed wetlands section.
64. Kansas Administrative Regulations. 1 January 1973. Chapter 25-5-9. Variance. p. 126.
65. State of Kansas Department of Health and Environment. March 1997. Bulletin 4-2: Minimum Standards for Design and Construction of Onsite Wastewater Systems. p. 1.
66. Kentucky Cabinet for Human Resources. September 1989. On-Site Sewage Disposal Systems Regulations. 902 KAR 10:081 and 902 KAR 10:085. p. 25.
67. Ibid. p. 58-59.
68. Ibid. p. 48.

69. Department for Public Health. August 1997. Kentucky Public Health Homeowner's Manual. Onsite Sewage Disposal Systems. p. 29
70. Teda Boudreaux. Louisiana Department of Health. Personal communication 3 May 1999.
71. Department of Human Services. 20 January 1998. Maine Subsurface Waste Water Disposal Rules. 144A CMR 214. p. 15-1, 15-2.
72. Ibid. p. 15-3.
73. Jay Prager, Acting Chief, Division of Residential Sanitation, Maryland Department of the Environment. 26 October 1990. Innovative/Alternative Section. Memorandum: Guidance on Waterless Toilet Systems. p. 1.
74. Ibid. p. 2.
75. Commonwealth of Massachusetts. Executive Office of Environmental Affairs. Department of Environmental Protection. 4 March 1998. 310 CMR 15.000: Title 5: Innovative and Alternative Subsurface Sewage Disposal Technologies Approved for Use in Massachusetts. p.1,9. Commonwealth of Massachusetts. Executive Office of Environmental Affairs. Department of Environmental Protection. 16 April 1998. The Use of Composting Toilets in Massachusetts. p. 1-4.
76. Ibid. p. 4.
77. Ruth Alfasso, Graywater Piloting Coordinator, Massachusetts DEP. Personal communication. 6 January 1999.
78. Ibid.
79. Rick Fallardeau, Michigan Department of Environmental Quality. Personal communication. April 1999.
80. Michigan Department of Public Health. July 1986. Guidelines for Acceptable Innovative or Alternative Waste Treatment Systems and Acceptable Graywater Systems. p. 1.
81. Ibid. Attachment A. Act No. 421. Public Acts of 1980. Approved by Governor. 13 January 1981. p. 1.
82. Ibid. p. 2.
83. Michigan Department of Public Health. July 1986. Guidelines for Acceptable Innovative or Alternative Waste Treatment Systems and Acceptable Graywater Systems. p. 2.
84. Ibid. p. 2.
85. Ibid. p. 3.
86. Ibid. p. 3.
87. Ibid. p. 3.
88. Ibid Attachment C. Act 230, Public Acts of 1972, as amended Michigan Construction Code. p. 1.
89. Rick Fallardeau, Michigan Department of Environmental Quality. Personal communication. April 1999.
90. McGeachy, Ben. date unknown. A Review of Subsurface Flow Constructed Wetlands Literature and Suggested Design and Construction Practices. Michigan Department of Environmental Quality.
91. Roberta Wirth, Minnesota Department of Natural Resources. Personal communication. 14 January 1999.
92. Minnesota Rules. 3 November 1998.. Chapter 7080.0910. Alternative and Experimental Systems.
93. Ibid. Section E1-E7.
94. Mississippi Individual On-Site Wastewater Disposal System Law. 1996. Chapter 41-67. MSDH 300-Section 02A-03.

95. Ibid. MSDH 300-Section 02A-XIII-01.

96. Ibid. MSDH 300-Section 02A-VII-01.

97. Missouri Department of Health. 1995. Missouri Laws Accompanied by Department of Health Rules Governing On-site Sewage Systems. Missouri Laws for On-Site Disposal Systems. p. 1.

98. Missouri Department of Health. 1995 Missouri Laws Accompanied by Department of Health Rules Governing On-site Sewage Systems. Title 19- Department of Health, Division 20-Environmental Health & Epidemiology, Chapter 3- General Sanitation. p. 37.

99. Ibid. p. 9.

100. Ibid. p. 34.

101. Montana Department of Health and Environmental Sciences. Circular WQB 5. Minimum Design Standards for On-Site Alternative Sewage Treatment and Disposal Systems. p. 4.

102. Ibid. p. 5

103. Nevada Adopted Regulation R 129-98. February 1998. p. 59-61.

104. <http://www.state.nh.us/gencourt/ols/rules/env-ws.html>

105. <http://www.state.nj.us/dep/dwq/rules.htm> p. 11.

106. Ibid. p. 6-7.

107. Ibid. p. 65, 68-69.

108. Ibid. p. 6.

109. Ibid. p. 25.

110. Brian Schall, New Mexico Environment Department. Personal communication. 1999.

111. Ibid.

112. Ibid.

113. New Mexico Environmental Improvement Board. October 1997. Liquid Waste Disposal Regulations. p. 6.

114. New Mexico Environmental Improvement Board. October 1997. Liquid Waste Disposal Regulations. p 38.

115. New York State Department of Health. 1996. Individual Residential Wastewater Treatment Systems Design Handbook.

116. Ibid. p. 56.

117. Ibid.

118. Ibid. p. 56-57.

119. State of New York. 1 December 1990. Appendix 75-A. Wastewater Treatment Standards - Individual Household Systems. Statutory Authority,; Public Health Law, 201(1)(1), New York. p. 31.

120. Ibid.

121. Ibid. p. 14.

122. Ben Pierson, New York State Department of Health. Personal communication. 6 April 1999.
123. National Small Flows Clearinghouse. September 1997. Alternative Toilets from the State Regulations. WWBKRG23. p. 53-54.
124. Joni Cardin, North Carolina Division of Water Quality. Personal communication. 7 January 1999.
125. State of North Dakota. 1996. Chapter 62-03-16. Individual Sewage Treatment Systems for Homes and Other Establishments Where Public Sewage Systems are not Available. p. 249.
126. Ibid.
127. Ohio Department of Health. 1 July 1977. Chapter 3701-29-01 to 3701-29-21. Household Sewage Disposal Rules. p. 21.
128. Oklahoma Chapter 640, Individual and Small Public Sewage Disposal. 1998. p. 12-13.
129. Oregon Chapter 447.115. 1997. <http://landru.leg.state.or.us/ors/447.html> 21 January 1999.
130. Oregon Chapter 918-790-0010. 1998. http://arcweb.sos.state.or.us/rules/OARS_900/OAR_918/918_770.html
131. Oregon Chapter 918-770-0050. 1998. Plumbing Product Approval. http://arcweb.sos.state.or.us/rules/OARS_900/OAR_918/918_770.html
132. Oregon Chapter 447.115. 1997. <http://landru.leg.state.or.us/ors/447.html> 21 January 1999.
133. National Small Flows Clearinghouse. September 1997. Greywater Systems from the State Regulations. p. 36.
134. Ibid. p. 37.
135. Terry Swisher, Oregon Chief Plumbing Inspector. Personal communication. 14 January 1999.
136. Commonwealth of Pennsylvania. 17 January 1998. Pennsylvania Code. Title 25. Environmental Protection. p. 73-6.
137. Ibid. p. 73-47 - 73-48.
138. Ibid. p. 73-10.
139. Ibid. p. 73-48 to 73-49.
140. Rhode Island. September 1998. Chapter 12-120-002, Individual Sewage Disposal Systems. p. 40-42.
141. Ibid.
142. Ibid. p. 43-46.
143. Richard Hatfield, South Carolina Onsite Wastewater Management Branch. Personal communication. 7 January 1999.
144. <http://www.state.sd.us/state/legis/lrc/rules/7453.htm> 7 January 1999.
145. National Small Flows Clearinghouse. September 1997. Greywater Systems from the State Regulations. p. 39-41.
146. Tennessee Rules of Department of Environment and Conservation, Division of Ground Water Protection. 1997. Chapter 1200-1-6: Regulations to Govern Subsurface Sewage Disposal Systems. p. 59.
147. Texas Natural Resource Conservation Commission. 8 January 1999. Chapter 285, On-Site Sewage Facilities. p. 2, 19.
148. Ibid. p. 1, 3.
149. Ken Graber, Texas Natural Resource Conservation Commission. Personal communication. 4 April 1999.

150. Ibid.
151. <http://www.eq.state.ut.us/eqwq/wqrules.htm> 6 January 1999.
152. Bonnie Loomer-Hostetler, Information Services Chief of the Vermont Wastewater Management Division. Personal communication. 7 January 1999.
153. John Akielaszek, Vermont Department of Environmental Conservation. Personal communication. 12 January 1999.
154. <http://www.vdh.state.va.us/onsite/text/appr-sys.htm>
155. Technical Review Committee. June 1994. Guidelines for Composting Toilets. Washington State Department of Health. p. 2.
156. Water Conserving On-Site Wastewater Treatment Systems. 5 April 1999. Washington State Department of Health. p. 3.
157. Technical Review Committee. June 1994. Guidelines for Composting Toilets. Washington State Department of Health. p. 1.
158. Water Conserving On-Site Wastewater Treatment Systems. 5 April 1999. Washington State Department of Health. p. 2.
159. Ibid. p. 4.
160. Technical Review Committee. June 1994. Guidelines for Composting Toilets. Washington State Department of Health. p. 3, 4, 5.
161. Technical Review Committee. June 1994. Guidelines for Composting Toilets. Washington State Department of Health. p. 19, 20, 22, 23.
162. West Virginia Board of Health. 1983. Interpretive Rule 16-1. Series VII. Part V. Sec. 10.0. p. 135.

*Source: The Humanure Handbook. Jenkins Publishing, PO Box 607, Grove City, PA 16127. To order, phone: 1-800-639-4099.
www.jenkinspublishing.com*

[Previous Page](#) | [Top](#) | [Next Page](#)

weblife.org | [library](#) | [Humanure Handbook](#) | *Appendix 3: State Regulations of Composting Toilets, Greywater Systems, and Constructed Wetlands*